



 *Summerset*<sup>®</sup>  
PROFESSIONAL GRILLS



# ABOUT SUMMERSSET

Summerset™ Professional Grills offers a complete line of stainless steel grills, grill carts, BBQ islands, fire pits, doors, drawers, components and more. Our commitment to quality is reflected in the craftsmanship of our product and is backed by the full support of the Summerset™ warranty.



## OVER 18 YEARS OF LEADERSHIP

Summerset™ Professional Grills is a company born of experience. With 18 years of leadership in branding and manufacturing, our core focus is clear - to provide consumers with outstanding quality, exceptional service at great value



## RELIABLE PRODUCTS FOR EVERY BUDGET

Summerset strives to meet every outdoor living aspiration. We offer a wide range of affordable products from our Sizzler Series all the way up to our Alturi Series, without sacrificing an ounce of quality. No matter the budget, Summerset™ will deliver an outdoor experience that will create fond memories for years to come.



## SUPERIOR QUALITY

Here at Summerset we pride ourselves on using only the best materials. All of our products are made with the highest-grade stainless steel available, designed to withstand the high temperatures and greasy environments of outdoor cooking. We strive to maintain excellence in all we do and the result is a product you can count on.

# SIZZLER SERIES

Quality you can afford. The latest addition to the Summerset line, the Sizzler Series is a premium product at an unbeatable price. Constructed in all #443 stainless steel\* and designed with careful precision to ensure optimal airflow and even heating, this grill gives its higher-priced competitors a run for their money in both durability and grilling performance. The Sizzler will impress the most discriminating of grillers.

\*For more on #443 stainless steel visit us at [www.summersetgrills.com/the-difference](http://www.summersetgrills.com/the-difference)



**CAPTURED  
BRIQUETTE  
TRAYS**

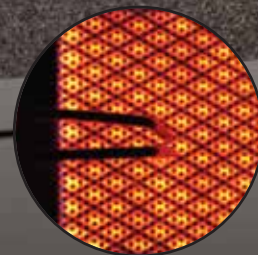

**INFRARED  
BACK BURNER  
(32" Model)**

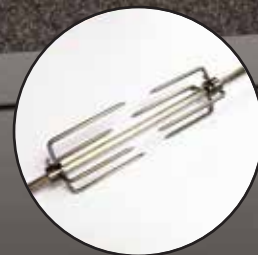

**OPTIONAL  
ROTISSERIE KIT**

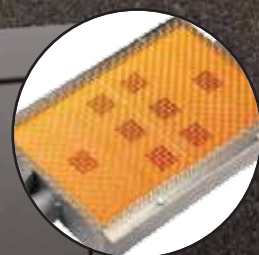

**OPTIONAL DROP-IN  
SEAR BURNER**



**SIZ32  
SIZZLER 32" GRILL**

4 Main Burners  
12,000 BTU Stainless Steel Tube Burners  
15,000 BTU IR Back Burner  
63,000 Total BTUs  
Cooking Surface 740 sq. in.  
Cut Out Dimensions:  
(W) 30<sup>1</sup>/<sub>2</sub>" x (H) 8<sup>1</sup>/<sub>2</sub>" x (D) 20<sup>3</sup>/<sub>4</sub>"



**CART-SIZ32  
SIZZLER 32" CART**

#443 Stainless Steel Construction  
Double Door Storage  
Fixed Shelves  
Locking Casters



**SIZ26  
SIZZLER 26" GRILL**

3 Main Burners  
12,000 BTU Stainless Steel Tube Burners  
36,000 Total BTUs  
Cooking Surface 560 sq. in.  
Cut Out Dimensions:  
(W) 23<sup>3</sup>/<sub>4</sub>" x (H) 8<sup>1</sup>/<sub>2</sub>" x (D) 20<sup>3</sup>/<sub>4</sub>"



**CART-SIZ26  
SIZZLER 26" CART**

#443 Stainless Steel Construction  
Double Door Storage  
Fixed Shelves  
Locking Casters

# FEATURES

- #443 Stainless Steel Construction
- Double-Lined Hood
- 8mm Cooking Grates
- 12,000 BTU #304 Stainless Burners
- 15,000 BTU IR Back Burner (32" Model)
- Flame Thrower Ignition
- Manual Flash Tube Ignition
- Easy-Clean Briquette System
- 32" Rotisserie Kit Available
- 15,000 BTU Drop-In Sear Burner Available
- Stainless Steel Carts Available
- Built-In and Cart Models Available
- Matching Side Burner Available

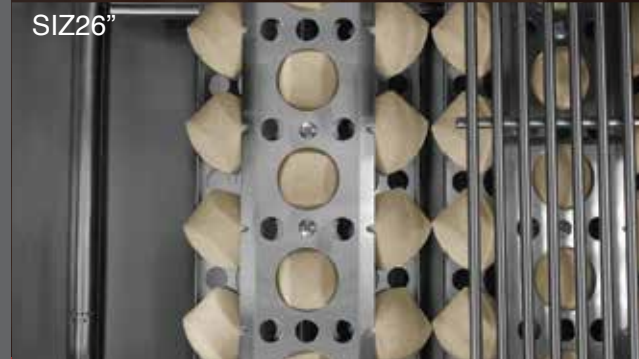

# TRL SERIES

The TRL is a fully loaded workhorse, a grilling classic packed with luxury features. Complete with interior lights, exterior LEDs, a rear infrared burner, full rotisserie set, flame thrower valves, easy-clean briquette burner covers and plug-and-play infrared sear zone options, the TRL makes professional grilling easy. With a commercial-grade stainless steel construction and 16-gauge stainless steel burners backed by lifetime warranty, this grill is built to last.



**LED FRONT PANEL LIGHTING**



**INTERIOR LIGHTING**

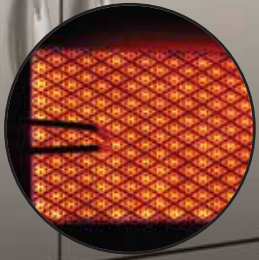

**INFRARED BACK BURNER**

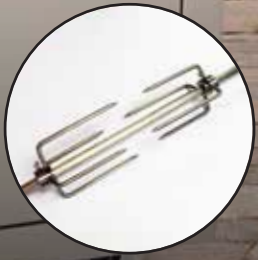

**ROTISSERIE KIT INCLUDED**



**TRL38**  
TRL 38" GRILL

4 Main Burner  
18,000 BTU U-Tube Burners  
20,000 BTU Cast Burner Available  
15,000 BTU IR Back Burner  
87,000 - 95,000 Total BTUs  
Total Cooking Surface: 1076 sq. in.  
Cut Out Dimensions:  
(W) 38<sup>1</sup>/<sub>2</sub>" x (H) 10" x (D) 20<sup>3</sup>/<sub>4</sub>"



**CART-TRL38**  
TRL 38" CART

#304 Stainless Steel Construction  
Double Door Storage  
Fixed Shelves  
Locking Casters



**TRL32**  
TRL 32" GRILL

3 Main Burner  
18,000 BTU U-Tube Burners  
20,000 BTU Cast Burner Available  
15,000 BTU IR Back Burner  
69,000 - 75,000 Total BTUs  
Total Cooking Surface: 855 sq. in.  
Cut Out Dimensions:  
(W) 30<sup>1</sup>/<sub>2</sub>" x (H) 10" x (D) 20<sup>3</sup>/<sub>4</sub>"



**CART-TRL32**  
TRL 32" CART

#304 Stainless Steel Construction  
Double Door Storage  
Fixed Shelves  
Locking Casters

# FEATURES

- #304 Stainless Steel Construction
- Double-Lined Hood
- LED Front Panel Lighting
- Interior Halogen Lighting
- 8mm Cooking Grates
- 18,000 BTU Stainless U-Tube Burners
- 15,000 BTU IR Back Burner
- Flame Thrower Ignition
- Manual Flash Tube Ignition
- Easy-Clean Briquette System
- Rotisserie Kit Included
- 20,000 BTU Cast Burners Available
- Drop-In Sear Burner Available
- Built-In or Cart Model Available
- Stainless Steel Carts Available



TRL 32"

# TRLD SERIES

The TRLD redefines value with premium craftsmanship, horsepower and a price tag that puts it in a class of its own. With all of the special features of the TRL, the Deluxe Series turns up the heat with standard 20,000 BTU cast stainless steel burners, ultra heavy-duty construction and a generous warranty to back it up. Beauty, durability and muscle come together to create this truly superior performance grill.



LED FRONT PANEL LIGHTING



INTERIOR LIGHTING



HEAVY DUTY KNOBS

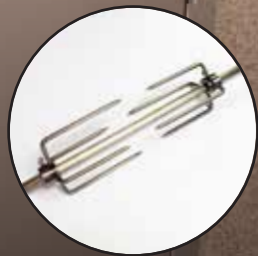

ROTISSERIE KIT INCLUDED



**TRLD44**  
TRL DELUXE 44" GRILL

4 Main Burner  
20,000 BTU Cast Burners  
15,000 IR Back Burner  
95,000 Total BTUs  
Total Cooking Surface: 1200 sq. in.  
Cut Out Dimensions:  
(W) 45<sup>1</sup>/<sub>4</sub>" x (H) 11" x (D) 20"



**CART-TRLD44**  
TRL DELUXE 44" CART

#304 Stainless Steel Construction  
Double Door Storage  
LP Pull-Out Drawer  
Folding Shelves  
Locking Casters



**TRLD32**  
TRL DELUXE 32" GRILL

3 Main Burners  
20,000 BTU Cast Burners  
12,500 IR Back Burner  
72,500 Total BTUs  
Total Cooking Surface: 855 sq. in.  
Cut Out Dimensions:  
(W) 33<sup>1</sup>/<sub>4</sub>" x (H) 11" x (D) 20"



**CART-TRLD32**  
TRL DELUXE 32" CART

#304 Stainless Steel Construction  
Double Door Storage  
LP Pull-Out Drawer  
Folding Shelves  
Locking Casters

# FEATURES

- #304 Stainless Steel Construction
- Heavy-Duty Double-Lined Hood
- LED Front Panel Lighting
- Interior Halogen Lighting
- Heavy-Duty 9mm Cooking Grates
- 20,000 BTU Cast Stainless Burners
- 12,500 & 15,000 BTU IR Back Burner
- Heat-Zone Separator
- Flame Thrower Ignition
- Easy-Clean Briquette System
- Rotisserie Kit Included
- Drop-In Sear Burner Available
- Built-In or Cart Model Available
- Stainless Steel Carts Available
- Matching Side Burner Available



TRLD 44"

# ALTURI SERIES

The Alturi Series can be summed up in one word – luxury. Designed with elegance, fueled with raw power and loaded with every feature, this grill sets the bar for luxury outdoor cooking. Details like the angle-mounted interior lights, rotisserie storage and spring-assisted hood provide ultimate convenience, while its solid #304 stainless steel construction and high BTU Red Brass burners - the most durable in the market - guarantee lasting performance. When it comes to performance, quality and style, Alturi truly stands alone.



**RED BRASS CAST BURNERS**



**LED FRONT PANEL LIGHTING**



**INTERIOR LIGHTING**



**SMOKER TRAY**



**ALT42**  
ALTURI 42" GRILL

3 Main Burners  
26,000 BTU Cast Red Brass Burners  
18,000 BTU Back Burner  
7,000 BTU Smoker Burner  
103,000 Total BTUs  
Drop-In Sear Burner Available  
Total Cooking Surface: 1100 sq. in.  
Cut Out Dimensions  
(W) 40<sup>1</sup>/<sub>2</sub>" x (H) 10<sup>3</sup>/<sub>16</sub>" x (D) 23<sup>1</sup>/<sub>16</sub>"



**ALT36**  
ALTURI 36" GRILL

3 Main Burners  
26,000 BTU Cast Red Brass Burners  
18,000 BTU Back Burner  
96,000 Total BTUs  
Drop-In Sear Burner Available  
Total Cooking Surface: 945 sq. in.  
Cut Out Dimensions  
(W) 34<sup>1</sup>/<sub>4</sub>" x (H) 10<sup>3</sup>/<sub>16</sub>" x (D) 23<sup>1</sup>/<sub>16</sub>"



**ALT30**  
ALTURI 30" GRILL

2 Main Burners  
26,000 BTU Cast Red Brass Burners  
18,000 BTU Back Burner  
7,000 BTU Smoker Burner  
79,000 Total BTUs  
Drop-In Sear Burner Available  
Total Cooking Surface: 780 sq. in.  
Cut Out Dimensions  
(W) 28<sup>1</sup>/<sub>2</sub>" x (H) 10<sup>3</sup>/<sub>16</sub>" x (D) 23<sup>1</sup>/<sub>16</sub>"



**CART-ALT42**  
ALTURI 42" CART

#304 Stainless Steel Construction  
2 Drawer, Vertical Door Combo Cart  
Inner-Door Condiment Tray  
Adjustable Shelves  
Locking Casters



**CARTALT36**  
ALTURI 36" CART

#304 Stainless Steel Construction  
Double Door Storage  
Inner-Door Condiment Tray  
Adjustable Shelves  
Locking Casters



**CARTALT30**  
ALTURI 30" CART

#304 Stainless Steel Construction  
Double Door Storage  
Inner-Door Condiment Tray  
Adjustable Shelves  
Locking Casters

# FEATURES

- #304 Stainless Steel Construction
- Double-Lined, Spring-Assisted Hood
- LED Front Panel Lighting
- Interior Halogen Lighting
- Heavy-Duty 9mm Cooking Grates
- 26,000 BTU Cast Red Brass Burners
- 18,000 BTU IR Back Burner
- 7,000 BTU Smoker Burner (30" & 42" Model)
- Heat-Zone Separator
- Manual Flash Tube Ignition
- Rotisserie Kit Included
- Storage Bracket For Rotisserie Spit
- Flame Thrower Ignition
- Built-In or Cart Model Available
- Stainless Steel Carts Available
- Matching Side Burner Available

ALT42"



# THE OVEN

The Oven is one of the newest additions to the Summerset family. From appetizers to desserts, The Oven will bake it all. Now you can add pizzas, poultry, brownies and more to your outdoor menu. To top it off its #304 stainless steel construction is sure to outlast the competition. Buon appetito!



EASY-VIEW WINDOW



INTERIOR LIGHTING



3 COOKING RACKS



CONVENIENT UTENSIL STORAGE DRAWER

## SSTO-1 THE OVEN

16,000 BTU Main Burner  
Total Cooking Surface: 969 sq. in.  
See Diagram Below for Cut-Out Dimensions



## CART-SSTO THE OVEN CART

Stainless Steel Construction  
Single Access Door  
Folding Shelves  
Locking Casters

## SSTOAK-1 THE OVEN ACCESSORY KIT

Includes:  
15"x14" Pizza Stone  
Wooden Pizza Peel  
Stainless Cutter/Spatula  
Stainless Serving Spatula  
7" Stainless Wheel Pizza Cutter  
Leather Glove  
Smoker Box



# FEATURES

- #304 Stainless Steel Construction
- 16,000 BTU #304 Stainless Burner
- Push-Button Ignition
- Interior Lighting
- Easy-View Window
- Temperature Gauge
- Built-In Storage Drawer
- 3 Cooking Racks
- Pizza Stone Included
- Natural Gas Conversion Kit Included
- Accessory Kit Available (See Accessories Section)





**ALTSB-2**  
ALTURI DOUBLE SIDE BURNER

Total BTUs: 35,000  
Solid Brass Burners  
Cooking Surface: 21 1/2" x 11 1/2"  
Front Panel LED Lighting



**TRLSB-2**  
TRL DOUBLE SIDE BURNER

Total BTUs: 30,000  
Cooking Surface: 19 1/4" x 11 1/4"  
Front Panel LED Lighting



**SIZSB-2**  
SIZZLER DOUBLE SIDE BURNER

Total BTUs: 30,000  
Cooking Surface: 19 1/2" x 10 1/2"

**ALT-SS**  
ALTURI SEAR SIDE BURNER

Total BTUs: 15,000  
Infrared Burner (Up to 1600°F)  
Adjustable High/Low Technology \*Patent Pending  
Cooking Surface: 21 1/4" x 11 1/2"  
Front Panel LED Lighting



**SSEAR-1**  
SEAR SIDE BURNER

Total BTUs: 15,000  
Infrared Burner (Up to 1600°F)  
Adjustable High/Low Technology \*Patent Pending  
Cooking Surface: 18 1/2" x 11 1/2"



**SSSB-1**  
SINGLE SIDE BURNER

Total BTUs: 15,000  
Cooking Surface: 9 1/2" x 9 1/2"





# REFRIGERATION



**SSRFR-1**  
SUMMERSET REFRIGERATOR

Storage Capacity: 4.6 ft<sup>3</sup>  
Reversible Door w/ Lock & Key  
Interior Light  
Glass Shelving  
Crisping Drawers  
Overall Dimensions:  
(W) 21<sup>5/8</sup>" x (H) 33<sup>1/2</sup>" x (D) 22<sup>1/2</sup>"



**ALTRFR-1**  
ALTURI REFRIGERATOR

Storage Capacity: 4.6 ft<sup>3</sup>  
#304 Stainless Steel Reversible Door  
w/ Lock & Key  
Interior Light  
Glass Shelving  
Crisping Drawers  
Overall Dimensions:  
(W) 21<sup>5/8</sup>" x (H) 33<sup>1/2</sup>" x (D) 22<sup>1/2</sup>"



**ORFR-1**  
OUTDOOR RATED REFRIGERATOR

Storage Capacity: 5.5 ft<sup>3</sup>  
Full Stainless Steel Construction  
UL Certified for Outdoor Use  
Reversible Door w/ Lock & Key  
Digital Thermostat  
Overall Dimensions:  
(W) 23<sup>1/2</sup>" x (H) 32<sup>3/4</sup>" x (D) 24<sup>3/4</sup>"

# OPTIONS



**SSRSL-1**  
#304 STAINLESS STEEL DOOR UPGRADE  
(For Model: SSRFR-1)

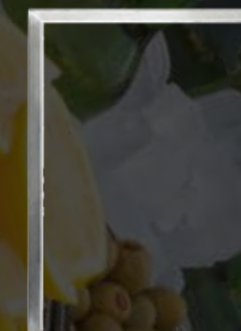

**SSRTK-1**  
REFRIGERATOR TRIM KIT  
(For Models: SSRFR-1/ALTRFR-1)

**SSORTK-1**

OUTDOOR RATED TRIM KIT  
(For Model: ORFR-1)

**NEW** ISLANDS

PORCELAIN TILE



GRANITE TILE

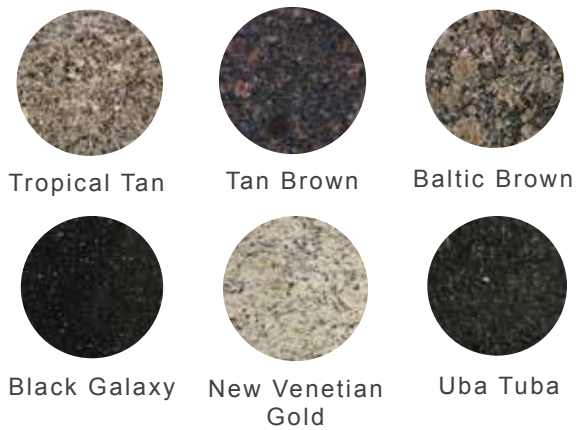

STUCCO FINISH

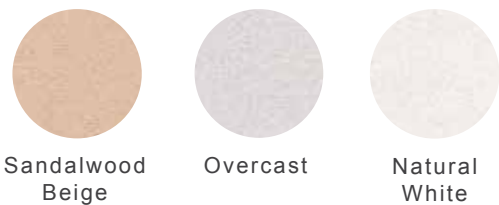

BRING THE INDOORS OUT WITH  
**SUMMERSET BBQ ISLANDS**

Enjoy creating new memories and exciting conversations with your family and friends around our custom BBQ Islands. All Summerset Professional Islands are constructed with rust-resistant 1" x 1" welded-steel framing, trex railing systems and complete electrical systems. Islands include stucco finish and porcelain tile countertops, with Ameristone and granite upgrades available.

AVAILABLE FINISHED, UNFINISHED & PARTIALLY FINISHED

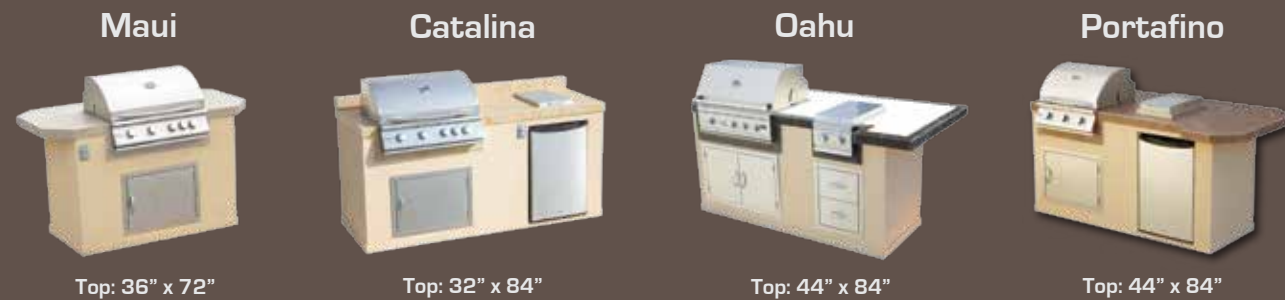

AMERISTONE FINISH



FINISH OPTIONS



**NEW**  
**FIRE PITS**

PORCELAIN TILE



GRANITE TILE

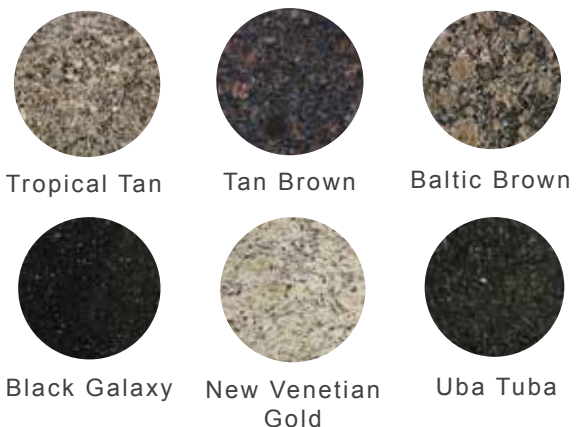

ENJOY THE LUXURY OF  
**SUMMERSET FIRE PITS**

Now you can have all the warmth and comfort of your living room in your own backyard. All SummerSet Professional Fire Pits are constructed with rust-resistant 1" x 1" welded-steel framing. Fire Pits include installation lines, fire glass, a stainless steel access door and a high quality 140,000 BTU #304 stainless steel burner. Available in porcelain or granite tops, with stucco or Ameristone finishes.

BRING THE INDOORS OUT WITH SUMMERSET FIRE PITS

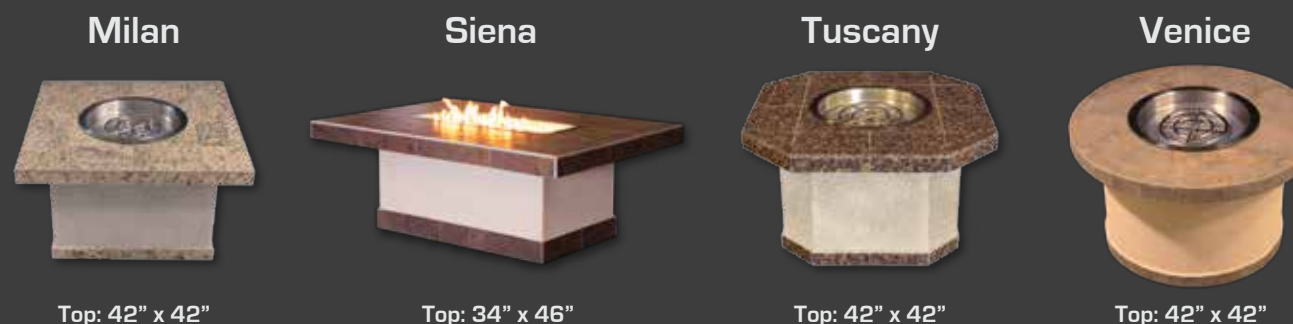

STUCCO FINISH

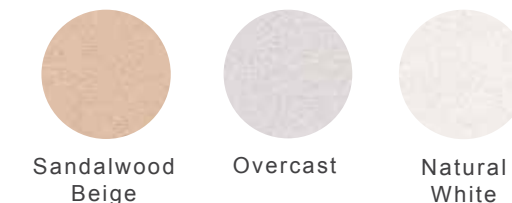

AMERISTONE FINISH



GLASS OPTIONS



BEAD OPTIONS

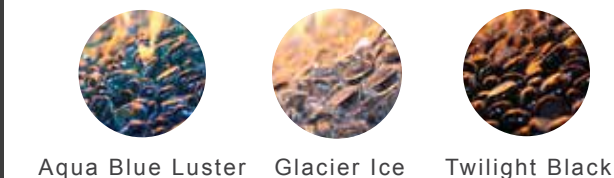

# COMPONENTS

---

**NEW**



**SSMD-1**  
MINI VERTICAL DOOR



**SSDV-1**  
VERTICAL DOOR



**SSDVL-1**  
LARGE VERTICAL DOOR



**SSDR-1**  
SINGLE DRAWER



**SSDR-2**  
DOUBLE DRAWER



**SSDR-3**  
TRIPLE DRAWER



**SSHD-1**  
HORIZONTAL DOOR



**SSDD-30**  
30" DOUBLE DOOR



**SSDD-42**  
42" DOUBLE DOOR



**SSTDC-1**  
TOWEL/DRAWER COMBO



**SSDC-1**  
2-DRAWER/DOOR COMBO

**NEW**



**SSDC-3**  
3-DRAWER/DOOR COMBO

# COMPONENTS

---



**SSUD-1**  
UTILITY DRAWER



**SSHDR-2**  
DOUBLE HORIZONTAL DRAWER



**SSHDR-3**  
TRIPLE HORIZONTAL DRAWER



**SSNK-1**  
STAINLESS STEEL SINK



**SSBC-1**  
BEVERAGE CENTER



**SSIC-1**  
ICE CHEST



**SSTDH-1**  
TOWEL DRAWER

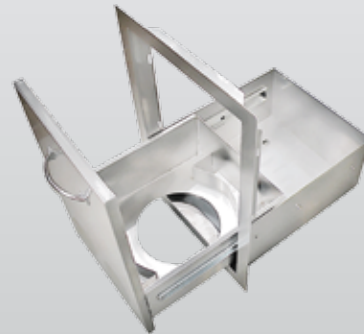

**SSLPD-1**  
PROPANE PULL OUT DRAWER



**SSTD-1**  
TRASH DRAWER



**SSTC-1**  
TRASH CHUTE



**SSIV-1**  
ISLAND VENT



**SSUS-1**  
UMBRELLA STANCHION

---

# BEVERAGE CENTER

With our grills heating things up, we have just the thing to keep you cool. Take your outdoor kitchen to the next level with the Alturi Beverage Center. Complete with a 40 lb. ice compartment, sink, towel holder, and speed rail with condiment tray and built-in bottle opener, this will make you the best host in the neighborhood. And don't worry, when the sun goes down the LEDs will light it up and keep the party going!

ALTURI #ALTBC-1  
SUMMERSET #SSBC-1



BUILT-IN BOTTLE OPENER



LED FRONT PANEL LIGHTING



SINK & FAUCET COMBO



40 LB. ICE COMPARTMENT

## ALTURI COMPONENTS

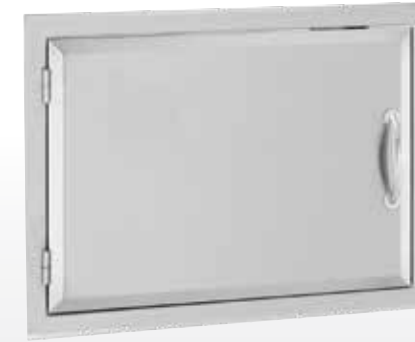

ALTHD-1  
HORIZONTAL DOOR



ALTDV-1  
VERTICAL DOOR



ALTDVL-1  
LARGE VERTICAL DOOR



ALTDD-30  
30" DOUBLE DOORS



ALTDD-42  
42" DOUBLE DOORS



ALTDC-1  
DOOR/DRAWER COMBO

# ALTURI COMPONENTS

---



**ALTDR-1**  
SINGLE DRAWER



**ALTDR-2**  
DOUBLE DRAWER



**ALTDR-3**  
TRIPLE DRAWER



**ALTCT-1**  
CONDIMENT TRAY



**ALTTDH-1**  
TOWEL HOLDER



**ALTTC-1**  
TRASH CHUTE



**ALTUD-1**  
UTILITY DRAWER



**ALTTD-1**  
TRASH DRAWER



**ALTTDC-1**  
TOWEL/DRAWER COMBO



**ALTSD-30**  
30" STORAGE DRAWER



**ALTIC-1**  
ICE CHEST



**ALTBC-1**  
BEVERAGE CENTER

# MASONRY COMPONENTS

**NEW**

Summerset introduces the all-new line of Masonry Components, perfect for islands with stone or brick finishes. The increased flange depth makes for a seamless fit and streamlined installation. These components can also be used to add an attractive contrast to any island with stucco or Ameristone finishes. With the durability of complete #304 stainless steel construction, the masonry line is an exciting new addition to Summerset™.



**SSDVL-M**  
LARGE VERTICAL DOOR



**SSDD-30M**  
30" DOUBLE DOORS



**SSDD-42M**  
42" DOUBLE DOORS



**SSDR-2M**  
DOUBLE DRAWER



**SSTDC-M**  
TOWEL/DRAWER COMBO



**SSTD-M**  
TRASH DRAWER



# ACCESSORIES



**GRILLCOV-1 | GRILL COVERS**

Weather-Resistant  
Tightens with Drawstring  
Available for All Grill Series



**CARTCOV-1 | GRILL CART COVERS**

Weather-Resistant  
Tightens with Drawstring  
Available for All Grill Series



**SSTO-COV | THE OVEN COVER**

Weather-Resistant  
Easy-Open Zipper Access  
Fits The Oven Only



**SSGL-1 | GRILL LINERS**

Insulating Jacket for Combustible Construction  
Available for All Grill & Side Burner Models

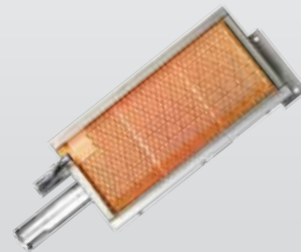

**SIZ-IRB | SIZZLER SEAR BURNER**

15,000 BTU Infrared Burner  
Reaches 1600°F  
Plug-n-Play  
Substitutes Any Main Burner  
Fits Sizzler Grills Only

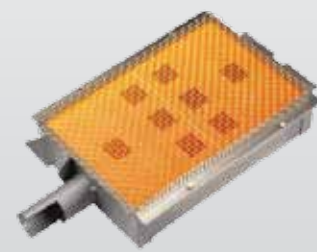

**SSIRB-L | TRL SEAR BURNER**

15,000 BTU Infrared Burner  
Reaches 1600°F  
Plug-n-Play  
Substitutes Any Main Burner  
Fits TRL Grills Only

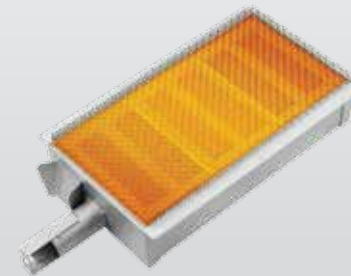

**ALT-IRB | ALTURI SEAR BURNER**

25,000 BTU Infrared Burner  
Reaches 1600°F  
Plug-n-Play  
Substitutes Any Main Burner  
Fits Alturi Grills Only



**SSMK-TRL  
SSMK-TRLD | SMOKER TRAY  
SSMK-SIZ**

Easy Drop-In Design  
Sits Beneath Cooking Grates  
Adds Smokin' Flavor to BBQ

Product	Model #	Cut-Out Dimensions ( W x H x D )	Diagram
<b>APPLIANCES</b>			
Sizzler 26" Grill	SIZ26	23¾" x 8½" x 20¾"	A
Sizzler 32" Grill	SIZ32	30⅝" x 8½" x 20¾"	A
TRL 32" Grill	TRL32	30½" x 10" x 20¾"	A
TRL 38" Grill	TRL38	38½" x 10" x 20¾"	A
TRLD 32" Grill	TRLD32	33¼" x 11" x 20"	A
TRLD 44" Grill	TRLD44	45¼" x 11" x 20"	A
Alturi 30" Grill	ALT30	28½" x 10 <sup>3</sup> / <sub>16</sub> " x 23 <sup>1</sup> / <sub>16</sub> "	A
Alturi 36" Grill	ALT36	34¼" x 10 <sup>3</sup> / <sub>16</sub> " x 23 <sup>1</sup> / <sub>16</sub> "	A
Alturi 42" Grill	ALT42	40½" x 10 <sup>3</sup> / <sub>16</sub> " x 23 <sup>1</sup> / <sub>16</sub> "	A
<b>SIDE BURNERS</b>			
( W x H x D )			
Single Side Burner	SSSB-1	8" x N/A x 15½"	B
Sizzler Double Side Burner	SIZSB-1	10¾" x 8½" x 20¾"	B
TRL Double Side Burner	TRLSB-2	11¾" x 9" x 19"	B
Sear Side Burner	SSEAR-1	11¾" x 9" x 19"	B
Alturi Double Side Burner	ALT-2B	13¼" x 10¼" x 23"	B
Alturi Sear Side Burner	ALT-SS	13¼" x 10¼" x 23"	B
<b>REFRIGERATION</b>			
( W x H x D )			
Summerset Refrigerator	SSRFR-1	21¾" x 33" x 23"	D
Outdoor Rated Refrigerator	ORFR-1	24" x 33¼" x 25"	D
Refrigerator Trim Kit	SSRTK-1	22¼" x 33½" x N/A	D

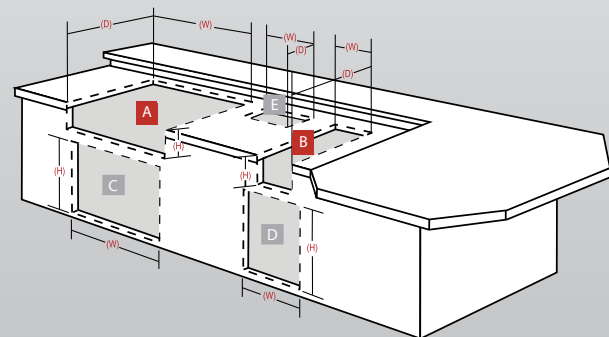

Product	Model #	Cut-Out Dimensions ( W x H x D )	Diagram
<b>DOORS</b>			
( W x H x D )			
Vertical Door	SSDV-1, ALTDV-1	14¼" x 19¼" x N/A	C
Vertical Door Mini	SSMD-1	14¼" x 16¼" x N/A	C
Vertical Door Large	SSDVL-1, SSDVL-M, ALTDVL-1	17¼" x 24¼" x N/A	C
Horizontal Door	SSHD-1, ALTHD-1	24¼" x 17¼" x N/A	C
Double Door 30"	SSDD-30, SSDD-30M, ALTDD-30	30¼" x 19½" x N/A	C
Double Door 42"	SSDD-42, SSDD-42M, ALTDD-42	42¼" x 19½" x N/A	C
2 Drawer/Door Combo	SSDC-1, ALTDC-1	30¼" x 19½" x 20¾"	C
3 Drawer/Door Combo	SSDC-3	29¾" x 20⅞" x 20½"	C
Storage Drawer 30"	ALTSD-30	28⅝" x 9⅞" x 24¼"	C
<b>DRAWERS</b>			
( W x H x D )			
Utility Drawer	SSUD-1, ALTUD-1	23¼" x 4" x 20¾"	C
Single Drawer	SSDR-1, ALTD-1	15¼" x 10⅞" x 20¾"	D
2-Drawer	SSDR-2, SSDR-2M, ALTD-2	15¼" x 19¼" x 20¾"	D
3-Drawer	SSDR-3, ALTD-3	15¼" x 27¾" x 20¾"	D
Double Horizontal Drawer	SSHDR-2	30⅞" x 6¼" x 20⅞"	D
Triple Horizontal Drawer	SSHDR-3	46" x 6¼" x 20⅞"	D
Liquid Propane Drawer	SSLPD-1	14¾" x 20½" x 17"	C
Trash Drawer	SSTD-1, SSTD-M, ALTD-1	18" x 24¾" x 20½"	D
Towel Drawer	SSTDH-1, ALTDH-1	15" x 8½" x 8¾"	D
Towel/2-Drawer	SSTDC-1, SSTDC-M, ALTD-1	15¼" x 27¾" x 8¾"	D
<b>UTILITY COMPONENTS</b>			
( W x H x D )			
Trash Chute	SSTC-1, ALTC-1	6¼" x N/A x 8¼"	E
Beverage Center	SSBC-1, ALTBC-1	28¼" x 10" x 23⅞"	B
15" Sink & Faucet	SSNK-1	14⅞" x N/A x 14⅞"	B
Ice Chest	SSIC-1, ALTIC-1	26¾" x 18¾" x 19½"	E
Island Vent	SSIV-1	22¼" x 33½" x N/A	-



## ALTURI SERIES

- Unlimited lifetime warranty on Red Brass Burners.
- Lifetime warranty on grill body construction.
- Lifetime warranty on grates.
- Limited lifetime warranty on all non-moving and non-electrical parts.
- Limited (5 year) warranty on burner covers.
- Limited (2 year) warranty on valves, rotisserie motor, regulator and temperature gauge.
- Limited (1 year) warranty on all lighting and electrical components.

## TRL/TRLD SERIES

- Lifetime warranty on all burners.
- Limited lifetime warranty on construction, workmanship and materials.
- Limited (10 year) warranty on grates, basin and drip tray.
- Limited (3 year) warranty on all burner covers.
- Limited (2 year) warranty on rotisserie motor and valves.

## SIDE BURNERS

- Limited (3 year) warranty on construction, workmanship and materials.
- Limited (2 year) warranty on valves and burners.

## SIZZLER SERIES

- Lifetime warranty on burners.
- Limited (2 year) warranty on construction and workmanship.
- Limited (1 year) warranty on valves, grates, burner covers, basin, and drip tray.
- Limited (1 year) warranty on rotisserie motor.

## THE OVEN

- Limited (5 year) warranty on construction.
- Limited (3 year) on burners.
- Limited (1 year) warranty on all internal parts, including grates, burner covers, ignitors, lights and external parts.

## REFRIGERATORS

- Limited (1 year) warranty.

## COMPONENTS

- Limited lifetime warranty on construction, workmanship and materials for all stainless steel components, including doors, drawers, ice chests, beverage centers, sinks and grill liners.
- Limited (5 year) warranty on carts.
- Limited (1 year) warranty on grill covers.

## ELECTRICAL

- Limited (1 year) warranty on transformers, LED lights, halogen lights, light housing and all electrical components.

Warranty is valid for original purchaser with proof of purchase only. Warranty is void upon transfer of ownership. Warranty covers manufacturer replacement parts only. Warranty will not apply for damage resulting from improper installations, abuse, extreme environments, grease fires or misuse. Coastal, humid and/or salt environments are subject to manufacturer review. All out-of-box claims must be made within 30 days. All warranty claims are valid only with proof of purchase and photo documentation of defective part. Warranty and registration forms available at [www.summersetgrills.com](http://www.summersetgrills.com). Contact your dealer to submit claims.



Professional Grills. Exceptional Service.



**Summerset Professional Grills**

1575 Sunflower Avenue, Costa Mesa, CA 92626

(800) 966-8126

[www.SummersetGrills.com](http://www.SummersetGrills.com)