



The Manual:

PVI-3.0/3.6/4.2-OUTD-S-US



POWER-ONE Trademarks:

Copyright © 2011 Power-One Renewable Energy Solutions, LLC. All rights reserved. No part of this document may be reproduced in any form or by any means without the prior written permission of Power-One Renewable Energy Solutions LLC. Power-One Renewable Energy Solutions LLC makes no representations, express or implied, with respect to this document or any of the equipment and/or software it may describe; including (without limitation) any implied warranties of utility, or merchantability for any particular purpose. All such warranties are expressly disclaimed. Power-One Renewable Energy Solutions, LLC, its subsidiaries, affiliates, distributors and dealers shall not be liable for any indirect, special, incidental, or consequential damages under any circumstances.

Power-One Renewable Energy LLC reserves the right to make changes to this document without notice and shall not be responsible for any damages, including indirect, special, incidental or consequential damages, caused by reliance on the content presented, including, but not limited to, any omissions, typographical errors, arithmetical errors or listing errors. All trademarks, logos, trade names, service marks and copyrighted materials used in this document are the property of their respective owners. Failure to designate a mark as registered does not mean that such mark is not a registered trademark. The Power-One name and logo are registered trademarks of Power-One, Inc. in the U.S.A. and other countries. All rights reserved. No licenses are conveyed herein, implicitly or otherwise, under any intellectual property rights.

Power-One
Renewable Energy Solutions LLC
740 Calle Plano
Camarillo, California, 93012
United States



Contents

| | |
|--|----|
| INSTRUCTIONS FOR USE OF THIS MANUAL | 8 |
| KEEP THESE INSTRUCTIONS! | 8 |
| USEFUL INFORMATION AND SAFETY REGULATIONS | 8 |
| 1.0 FOREWORD | 8 |
| 2.0 INTRODUCTION | 8 |
| 2.2.1 NAMEPLATE | 9 |
| 2.2.2 WARRANTY INFORMATION | 9 |
| 2.3 COMMISSIONING: | 10 |
| 2.4 MAINTENANCE AND SERVICE | 10 |
| 2.5 FIGURES AND IMAGES IN THIS MANUAL | 10 |
| 2.6 STORAGE OF THIS INFORMATION | 10 |
| 2.7 ADDITIONAL INFORMATION | 10 |
| 3.0 SAFETY | 10 |
| 3.1.2 OTHER SYMBOLS IN THIS DOCUMENT: | 11 |
| 3.2 GENERAL INSTALLATION WARNINGS | 11 |
| 3.2.1 ASSEMBLY WARNINGS | 12 |
| 3.2.2 ELECTRICAL CONNECTION WARNINGS | 12 |
| 3.2.3 OPERATION WARNINGS | 12 |
| 3.3 APPROPRIATE USAGE | 13 |
| 3.4 SAFETY INSTRUCTIONS | 14 |
| 3.5 LOCATION OF SAFETY NOTICES | 14 |
| 1.0 UNPACK AND INSPECT | 16 |
| 1.1 Incoming Inspection | 16 |
| 1.2 Selecting The Installation Location..... | 16 |
| 2: 1.0 NAMEPLATE | 21 |
| 2: 2.0 MOUNTING PVI-3.0/3.6/4.2-OUTD-S-US | 22 |
| 2a: 3.0 INSTALLATION PVI-3.0/3.6/4.2-OUTD-S-US | 23 |
| 3.1 Removing The Front Covers | 23 |
| 3.2 Electrical Wiring and Connections PVI-3.0/3.6/4.2-OUTD-S-US..... | 24 |
| 3.2.1 Considerations Before Performing Electrical Connections..... | 24 |
| 3.2.2 Field Wiring-Knockout-Details PVI-3.0/3.6/4.2-OUTD-S-US | 25 |
| 3.2.3 Initial Electrical Connections PVI-3.0/3.6/4.2-OUTD-S-US | 26 |
| 3.2.4 DC Array Connections | 27 |

| | |
|---|-----------|
| 3.2.5 AC Grid Connections | 28 |
| Figure 2:07b: Grid Standard..... | 29 |
| 3.2.6 Signal Wiring Connections..... | 29 |
| 3.2.6.1 Connect RS485 Monitoring Cable..... | 30 |
| 2a: 3.3 Configuration Settings - PVI-3.0/3.6/4.2-OUTD-S-US | 32 |
| 3.3.3 Independent Or Parallel Connection of Dual Inputs | 33 |
| 3.3.3.1 Independent Connection..... | 33 |
| 3.3.3.2 Parallel Connection | 34 |
| - + - + | 34 |
| 4: 1.0 AC AND DC WIRING AND OVER CURRENT PROTECTION | 37 |
| 4: 1.2 MULTI-UNIT CONFIGURATION..... | 38 |
| 1.2.1 Daisy Chain | 38 |
| 1.2.1.1 Connection & Cabling | 40 |
| 4.1.3 ADDRESSING EACH INVERTER..... | 40 |
| 1.3.1 Install Instructions:..... | 41 |
| 4: 0.1 COMMISSIONING | 43 |
| 4: 1.0 INVERTER START-UP and OPERATION..... | 43 |
| 1.1 NORMAL START- UP PROCEDURE | 44 |
| 1.2 SHUT-DOWN PROCEDURE..... | 45 |
| 1.3 POWER-DOWN PROCEDURES | 45 |
| 1.3.1 Disconnection Of AURORA Inverters | 46 |
| - + - + | 46 |
| 4: 2.0 OPERATIONS: USER INTERFACE, MONITORING AND DATA TRANSMISSION | 47 |
| 2.1 USER INTERFACE MODE..... | 47 |
| 2.2 DATA TYPES AVAILABLE | 49 |
| 2.2.1 Real-Time Operational Data..... | 49 |
| 2.2.2 Data Logged Internally..... | 49 |
| 2.3 LED INDICATORS | 49 |
| 2.4 MESSAGES AND ERROR CODES | 52 |
| 2.5 LCD DISPLAY | 53 |
| 2.5.1 Connection of the System to the Grid..... | 53 |
| 2.5.1.1 Field Adjustments for Frequency and Disconnection Time..... | 54 |
| 2.5.2 Error Messages..... | 58 |
| 2.5.3 First Phase- Electric Parameter Check | 59 |

| | |
|---|-----------|
| 2.5.4 Main Menu..... | 61 |
| 2.5.5 Statistics | 62 |
| 2.5.6 Lifetime..... | 62 |
| 2.5.7 Partial | 62 |
| 2.5.8 Last 7 days..... | 63 |
| 2.5.9 Last Month..... | 63 |
| 2.5.10 Last 365 Days | 63 |
| 2.5.11 User Period..... | 64 |
| 2.5.12 Settings..... | 64 |
| 2.5.13 Address | 65 |
| 2.5.14 Display Set | 65 |
| 2.5.15 Service | 66 |
| 2.5.16 New Password..... | 66 |
| 2.5.17 Cash | 66 |
| 2.5.18 Time..... | 66 |
| 2.5.19 Language | 66 |
| 2.5.20 Start-Up Voltage | 67 |
| 2.5.21 Alarm..... | 67 |
| 2.5.22 Remote Control..... | 67 |
| 2.5.23 UV Protection Time (PROT. TIME) | 68 |
| 2.5.24 MPPT | 68 |
| 2.5.25 Alarm Message..... | 68 |
| 2.5.25 Set Vgrid | 69 |
| 2.6 Information..... | 69 |
| 3.0 DATA CHECK AND COMMUNICATION..... | 70 |
| 5: 1.0 TROUBLESHOOTING..... | 72 |
| 1.2 LED INDICATORS | 72 |
| 1.3 MESSAGES and ERROR CODES | 74 |
| 1.4 LCD DISPLAY | 76 |
| 1.4.1 Connection of the System to the Grid..... | 76 |
| 1.5 PHASE ONE - ELECTRIC PARAMETER CHECK | 77 |
| 1.6 THE POWER ONE SERVICE CALL | 78 |
| Additional helpful information when troubleshooting with the Power-One Technical Service Engineers:..... | 78 |
| ➤ Provide a brief description of the fault. | 78 |

| | |
|---|-----------|
| 6: 1.0 MAINTENANCE | 80 |
| 1.1 SHUT-DOWN PROCEDURE | 80 |
| 1.2 POWER-DOWN PROCEDURES | 80 |
| 1.2.1 Disconnection Of AURORA UNO Inverter..... | 80 |
| 1.4 CR2032 LITHIUM BATTERY REPLACEMENT | 83 |
| 1.0 DATA SHEETS | 84 |
| 1.3 A DESCRIPTION OF THE SYSTEM | 92 |
| 1.3.1 Fundamental Elements of a Photovoltaic System: 'STRINGS' and 'ARRAYS' | 93 |
| 1.3.2 Inverter Input - The Photovoltaic Array | 94 |
| 1.3.3 Technical Description of AURORA UNO Inverter | 95 |
| 1.4 PROTECTIVE DEVICES WITHIN THE AURORA UNO INVERTER | 95 |
| 1.4.1 Inverter Output - the Grid Connection..... | 96 |
| 1.4.2 Data Transmission and Check..... | 96 |
| 1.4.3 Anti-Islanding..... | 96 |
| 1.4.4 Grounding/Differential Protection Fault..... | 96 |
| 1.4.5 ADDITIONAL PROTECTIVE DEVICES..... | 96 |
| 1.4.5.1 Power Derating | 97 |
| 1.4.5.2 FCC..... | 97 |

PART 1: INTRODUCTION & SAFETY

INSTRUCTIONS FOR USE OF THIS MANUAL

KEEP THESE INSTRUCTIONS!

This manual contains important instructions for safety and operation that must be followed during installation and maintenance of this photovoltaic inverter.

All operations regarding transport, installation, maintenance, and start-up must be carried out by qualified, trained technician or general contractor in compliance with all prevailing codes and regulations.

For a list of contractors certified to install this Power-One AURORA UNO Inverter, please contact Power-One Customer Service at 877-261-1374.

USEFUL INFORMATION AND SAFETY REGULATIONS

1.0 FOREWORD

This manual contains important instructions for the Power-One AURORA® UNO Inverter that must be followed during installation and maintenance of this inverter.

This grid-tied inverter operates only when properly connected to the AC distribution network and requires the services of qualified technical personnel to connect only after receiving appropriate approvals, as required by the local authority having jurisdiction.

This document is not intended to replace any local, state province, federal, or national laws, regulation or codes applicable to the installation and use of the inverter, including without limitation applicable electrical safety codes. All installations must conform to the laws, regulations, codes and standards applicable in the jurisdiction of installation. Power-One assumes no responsibility for the compliance or noncompliance with such laws or codes in connection with the installation of the inverter.

KEEP ALL DOCUMENTS IN A SAFE PLACE!

2.0 INTRODUCTION

The purpose of this document is to support the qualified technician, who has received training and/or has demonstrated skills and knowledge in construction to install and maintain this Power-One AURORA® UNO Photovoltaic (PV) Inverter.

This manual does not cover any details concerning equipment connected to the inverter such as the solar modules. Information concerning the connected equipment is available from the respective manufacturer.



2.1 Target Group

| | | |
|---|-----------------|--|
|  | CAUTION: | For safety reasons only a qualified technician, who has received training and/or has demonstrated skills and knowledge in construction and in operation of this unit, can install this inverter. |
|---|-----------------|--|

This manual is for qualified installers and/or licensed technicians who know and understand the National Electric Code and other applicable local code regulations. For a list of certified contractors to help install this unit, please contact Power-One Technical Support 1-877-261-1374.

2.2 VALIDITY AND AVAILABLE VERSIONS

There are three versions of the chassis, delineated by the presence of integral DC and/or AC disconnect

| | | |
|---|---|--|
|  | <p>PVI-3.0-OUTD-S-US Shipping Weight: 52 lbs/24kg Unit Weight: 49 lbs/23kg Dims: 37.75" x 15.75" x 15" / 959mmX400mmX381mm</p> | |
|  | <p>PVI-3.6-OUTD-S-US Shipping Weight: 52 lbs/24kg Unit Weight: 49 lbs/23kg Dims: 37.75" x 15.75" x 15" / 959mmX400mmX381mm</p> | |
|  | <p>PVI-4.2-OUTD-S-US Shipping Weight: 52 lbs/24kg Unit Weight: 49 lbs/23kg Dims: 37.75" x 15.75" x 15" / 959mmX400mmX381mm</p> | |

2.2.1 NAMEPLATE

The nameplate shown above is affixed to the inverter and provides the following information:

- 1) Manufacturer code
- 2) Model code
- 3) Serial number
- 4) Week/Year of production

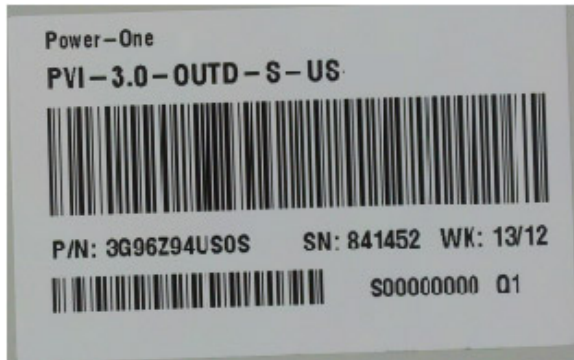

Sample product nameplate (PVI-3.0/3.6/4.2-S-US)

2.2.2 WARRANTY INFORMATION

After inspecting the AURORA UNO Inverter, it is necessary to fill out the warranty information on this unit and submitted it to Power-One. Submitting this information will register the unit with the manufacturer and the owner will receive technical updates regarding this Power-One photovoltaic inverter.

2.3 COMMISSIONING:

As part of the commissioning process, double check the following:

- Make sure that there is no ground fault.
- Double check the voltage doesn't exceed specified voltage ratings.
- See Part 4 on Operations for more information on commissioning and start-up.

2.4 MAINTENANCE AND SERVICE

The AURORA TRIO Inverter has no user-serviceable parts. Maintenance and service procedures must comply with the manufacturer's documentation. For more detailed information, please see Part 6 on Maintenance. Call Power-One Technical Support at 1-877-261-1374 for a list of qualified service contractors.

2.5 FIGURES AND IMAGES IN THIS MANUAL

The photos in this manual may differ slightly from the final model shipped. The color of the components may not match those illustrated, but the information is still applicable.

2.6 STORAGE OF THIS INFORMATION

Keep this document in a safe place near the AURORA UNO Inverter for easy access during installation and maintenance.

2.7 ADDITIONAL INFORMATION



More information on Power-One's AURORA UNO Inverter can be found at www.power-one.com



3.0 SAFETY

3.1 WARNINGS IN THIS DOCUMENT:

This is a list of special safety symbols used in this manual that highlight potential safety risks and/or useful information.





These symbols are as follows:

| Symbol | Usage |
|---|---|
|  DANGER: | Indicates a hazardous situation that if not avoided can result in deadly electric shock hazards, other serious physical injury, and/or fire hazards. |
|  WARNING: | Indicates directions which must be fully understood and followed in its entirety in order to avoid potential safety hazards including equipment damage, or personal injury. |
|  CAUTION: | Indicates a hazardous situation which, if not avoided, could result in minor or moderate injury. |



| | |
|---|---|
|  NOTE: | Contain actions and instructions that must be followed in order to avoid potential damage to the equipment and/or faults. |
|  INFORMATION: | Accompanies notes that call attention to supplementary information that ensure optimal operation of the system. |

3.1.2 OTHER SYMBOLS IN THIS DOCUMENT:

In addition to the safety and hazard symbols, the following symbols are also used in this installation guide:

| | |
|---|--|
|  | System earth conductor (main grounding protective earth, PE) |
|  | Alternating Current (AC) Value |
|  | Direct Current (DC) Value |
|  | Phase |
|  | Grounding (earth) |

The equipment has various labels. Those with a yellow background refer to safety concerns. Be sure to read all labels before beginning installation of the equipment. If any questions arise as to the meaning or intent of these notices, please contact Power-One Technical Support at 1-877-261-1374. The descriptions of the symbols used are as follows:

| | |
|--|--|
|  WARNING | DANGEROUS VOLTAGE The product works with high voltages. All work on the AURORA Inverter must follow the described documentation and must comply with all prevailing codes and regulations associated with high voltages. During inverter operation, parts will be energized at voltage levels. |
|  WARNING | HOT TEMPERATURE Some surfaces may become hot. Do not touch the product while it is in operation. |
|  | UL 1741 Standard for Safety for Inverters, Converters, Controllers and Interconnection System Equipment for use with Distributed Energy Resources. CSA CSA-C22.2 No. 107.1-01 - General Use Power Supplies. Rule Part 15, Subpart B - Unintentional Radiators Class B Limits |

3.2 GENERAL INSTALLATION WARNINGS

| | |
|--|--|
| | <ul style="list-style-type: none"> The AURORA UNO Inverter is designed and tested according to international safety requirements; however, certain safety precautions must be observed when installing and operating this inverter. Read and follow all instructions, cautions and warnings in this installation manual. If questions arise, please contact Power-One Technical Support at 1-877-261-1374 |
|--|--|

| | |
|---|---|
|  WARNING: | <ul style="list-style-type: none"> All operations regarding transport, installation and start-up, including maintenance must be carried out by qualified, trained personnel and in compliance with all prevailing local codes and regulations. |
| | <ul style="list-style-type: none"> This grid-tied inverter system operates only when properly connected to the AC-distribution network. Before connecting the services of AURORA UNO to the power distribution grid, contact the local power distribution grid company. This connection must be made only by qualified technical personnel to connect, and only after receiving appropriate approvals, as required by the local authority having jurisdiction. |
| | <ul style="list-style-type: none"> In order to minimize the potential of a shock hazard due to hazardous voltages, cover the entire solar array with dark material prior to connecting the array to any equipment. |
| | <ul style="list-style-type: none"> The Power-One AURORA UNO Inverter is designed and tested according to international safety requirements (UI 1741/IEEE 1547), but as with all electrical and electronic equipment, certain precautions must be observed and followed during installation. |
| | <ul style="list-style-type: none"> Keep this documentation in the immediate vicinity of the AURORA UNO Inverter. It must be accessible for approved technical service and maintenance personal at any time. |
| | <ul style="list-style-type: none"> Basic safety rules require using qualified and trained personnel possessing the skills necessary for assembly, mounting, start-up and operation of the product. |

3.2.1 ASSEMBLY WARNINGS

| | |
|---|---|
|  WARNING: | <ul style="list-style-type: none"> Prior to installation, inspect the unit to ensure absence of any transport or handling damage, which could affect insulation integrity or safety clearances; failure to do so could result in safety hazards. |
| | <ul style="list-style-type: none"> Assemble the inverter per the instructions in this manual. Use care when choosing installation location and adhere to specified cooling requirements. |
| | <ul style="list-style-type: none"> Unauthorized removal of necessary protections, improper use, incorrect installation and operation may lead to serious safety and shock hazards and/or equipment damage. |

3.2.2 ELECTRICAL CONNECTION WARNINGS

| | |
|---|---|
|  WARNING: | <ul style="list-style-type: none"> Make all electrical connections (e.g. conductor termination, fuses, PE connection, etc.) in accordance with prevailing regulations. When working with the inverter powered ON, adhere to all prevailing safety regulations to minimize risk of accidents. |
| | <ul style="list-style-type: none"> Systems with inverters typically require additional control (e.g., switches, disconnects) or protective devices (e.g., fusing circuit breakers) depending upon the prevailing safety rules. |

3.2.3 OPERATION WARNINGS

| | |
|--|---|
| | <ul style="list-style-type: none"> Anytime the inverter has been disconnected from the power network, use extreme caution as some components can retain charge sufficient to create a shock hazard; to minimize occurrence of such conditions, comply with all corresponding safety symbols and markings present on the unit and in this manual. |
|--|---|





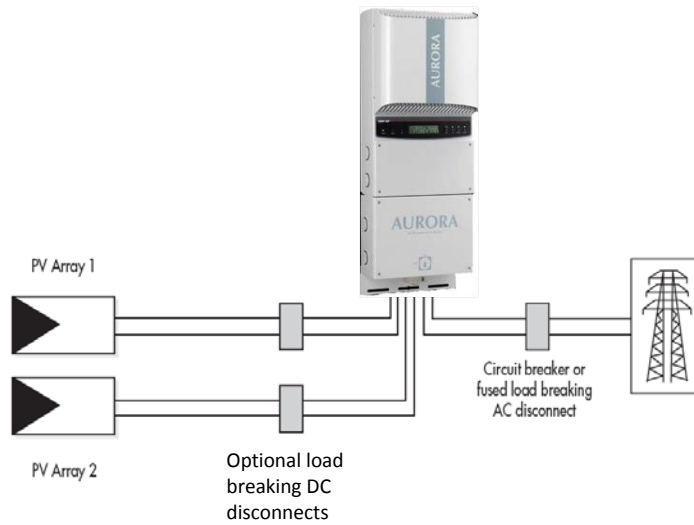

| | |
|---|---|
|  WARNING: | <ul style="list-style-type: none">• Ensure all covers and doors are closed and secure during operation. |
| | <ul style="list-style-type: none">• All operations regarding transport, installation and start-up, including maintenance must be performed by qualified, trained personnel and in compliance with all prevailing codes and regulations. |

3.3 APPROPRIATE USAGE

The AURORA UNO is a photovoltaic inverter that converts direct current of a PV array into alternating current and feeds that power into the power-distribution grid. This AURORA UNO Inverter is suitable for outdoor installation only.



3.4 SAFETY INSTRUCTIONS

| | |
|---|--|
|  DANGER: | Be sure all flammable materials including construction items are away from the unit. Do not install the inverter in or near potentially explosive areas. |
|  DANGER: | Normally grounded conductors may be ungrounded and energized when a ground-fault is indicated. <ul style="list-style-type: none">• Risk of electric shock• Test before touching• Work on the AURORA UNO inverter must be carried out by qualified personnel. |
|  WARNING: | Do not connect an AURORA UNO Inverter to the electrical distribution grid until after receipt of a letter of authorization from the authority having jurisdiction. |
|  WARNING: | Install the AURORA UNO Inverter in accordance with the electrical standards prescribed by the applicable National Electric Code and/or by other local codes and regulations. |
|  CAUTION: | The inverter weight is about 50lbs/23kg and is susceptible to tipping. It requires two or more persons to mount to bracket. Use proper lifting techniques to avoid personal injury. |
|  CAUTION: | Cuts and scratches due to sharp edges inside the AURORA UNO Inverter. Please use gloves and eye protection when working on this unit. |

3.5 LOCATION OF SAFETY NOTICES

Please note the location of safety notices on the AURORA UNO Inverter for notification and protection. They are located on both side panels of this unit.

PART 2: UNPACK & SELECT INSTALL LOCATION

1.0 UNPACK AND INSPECT

| | |
|--|--|
|  WARNING | <ul style="list-style-type: none"> • Install the AURORA Inverter in accordance with the electrical standards prescribed by the applicable National Electric Code and/or by other local regulations and codes. • Do not connect an AURORA Inverter to the electrical distribution grid until after receipt of a letter of authorization from the authority having jurisdiction. |
|--|--|

1.1 Incoming Inspection

It is the customer's responsibility to examine the condition of the unit shipped.

Upon receipt of Power-One's AURORA UNO Inverter, please perform the following check:

- Inspect the shipping container for any external damage.
- Inventory the contents against the listing of Table 0-1 and verify receipt of all items. Use care not to discard any equipment, parts, or manuals.
- Call the delivering carrier if damage or shortage is detected.
- If inspection reveals damage to the inverter, contact the supplier, or authorized distributor for a repair/return determination and instructions regarding the return/repair process.

| Table 0-1: Package contents | | |
|-----------------------------|------------------------------------|----------------------------|
| QTY | Description | |
| 1 | Aurora Inverter | |
| 1 | Aurora inverter mounting plate | |
| 1 | Bag containing hardware: | |
| | 4 | 6.3x70 screws |
| | 4 | SX10 wall plugs |
| | 1 | Red Cable AWG 10 |
| | 1 | Black Cable AWG 10 |
| | 1 | 6x10 screw |
| | 5 | d.18 washer |
| | 1 | Torx 20 wrench |
| | 1 | Frequency Adjustment Label |
| 1 | Installation and Operator's Manual | |
| 1 | Certificate of warranty | |
| 1 | CD-ROM with communication software | |

1.2 Selecting The Installation Location

Select the installation location based on the following considerations:

1. Select a well-ventilated location sheltered from direct sun radiation.
2. Choose a location that allows unobstructed airflow around the inverter.
3. Allow sufficient room around the inverter to enable easy installation and removal from the mounting surface.
4. Height from ground level should be such that the display and status LEDs are easy to read.

5. Access panels on the front surface of the inverter allow inspection and maintenance of hardware; and must not be blocked. Figure 0-1 shows the recommended minimum clearances around the inverter.
6. When possible, mount the AURORA UNO Inverter vertically. For other mounting orientations consult with Power-One.
7. Tilted mounting ($\pm 5^\circ$ from vertical) is acceptable, but will reduce heat dissipation and may result in self-derating.

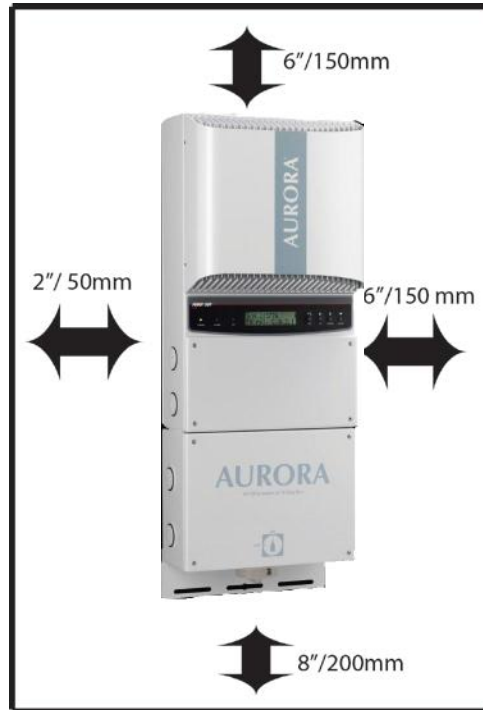

Figure 0-1 - Minimum Clearances around the AURORA Inverter



WARNING

The inverter surface may become hot to the touch during operation. To avoid burn injury, DO NOT touch the inverter surface during operation.



Figure 0-2a Recommended Arrangement

For installation of AURORA UNO Inverter

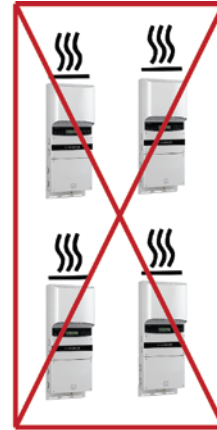



Figure 0-2b Unacceptable Arrangement

For installation of AURORA UNO Inverter

| | |
|--|--|
|  NOTE | <p>Do not mount the AURORA Inverter where exposed to direct sun radiation or any other heat source. This includes heat generated by other AURORA Inverters; otherwise, the inverter will self protect, resulting in derated power output.</p> <p>When the ambient temperature rises above 113°F/ 45°C the inverter may self-derate the output power.</p> <p>For full power of AURORA UNO Inverter (no derating), be sure the airflow through the heat sink is clear. Blockages will result in less than expected power output.</p> |
|--|--|

PART 3: MOUNTING & WIRING

Section 1:

PVI-3.0/3.6/4.2-OUTD-S-US

Section 2:

WIRING DETAILS

Read and apply all safety warnings when performing these tasks.

SECTION 1:

PVI-3.0/3.6/4.2-OUTD-S-US



2: 1.0 NAMEPLATE

The nameplate shown above is affixed to the inverter and provides the following information:

- 5) Manufacturer code
- 6) Model code
- 7) Serial number
- 8) Week/Year of production

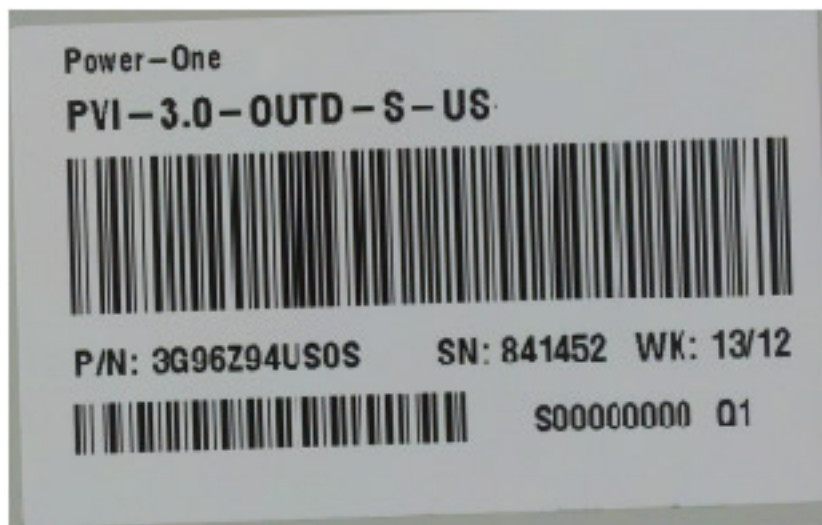

Sample product nameplate (PVI-3.0-OUTD-S-US)

2: 2.0 MOUNTING PVI-3.0/3.6/4.2-OUTD-S-US

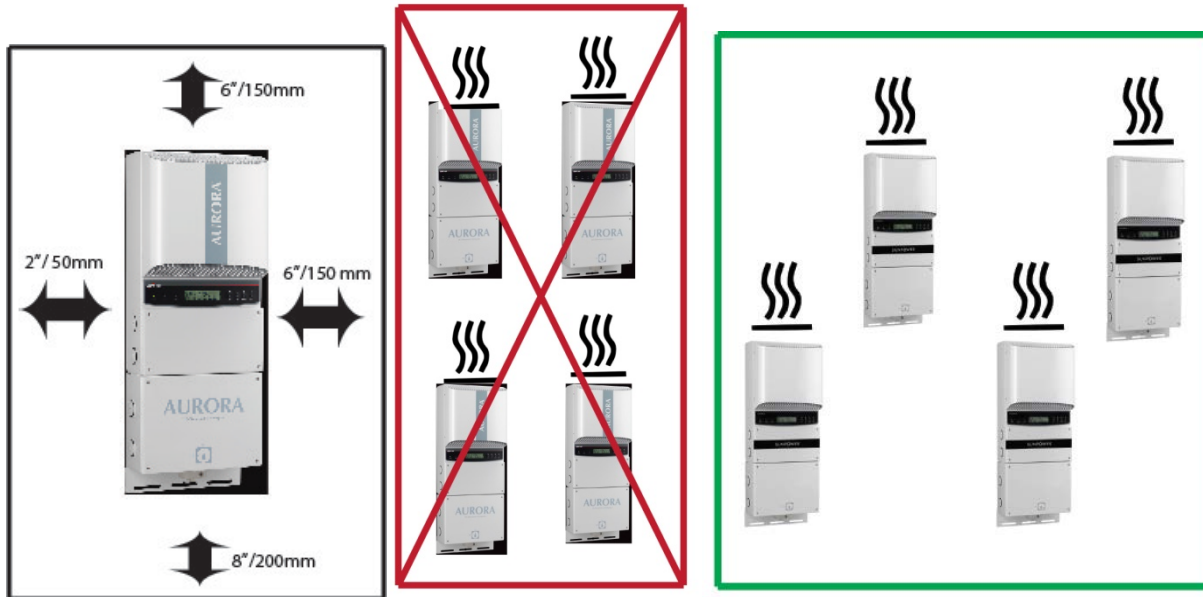

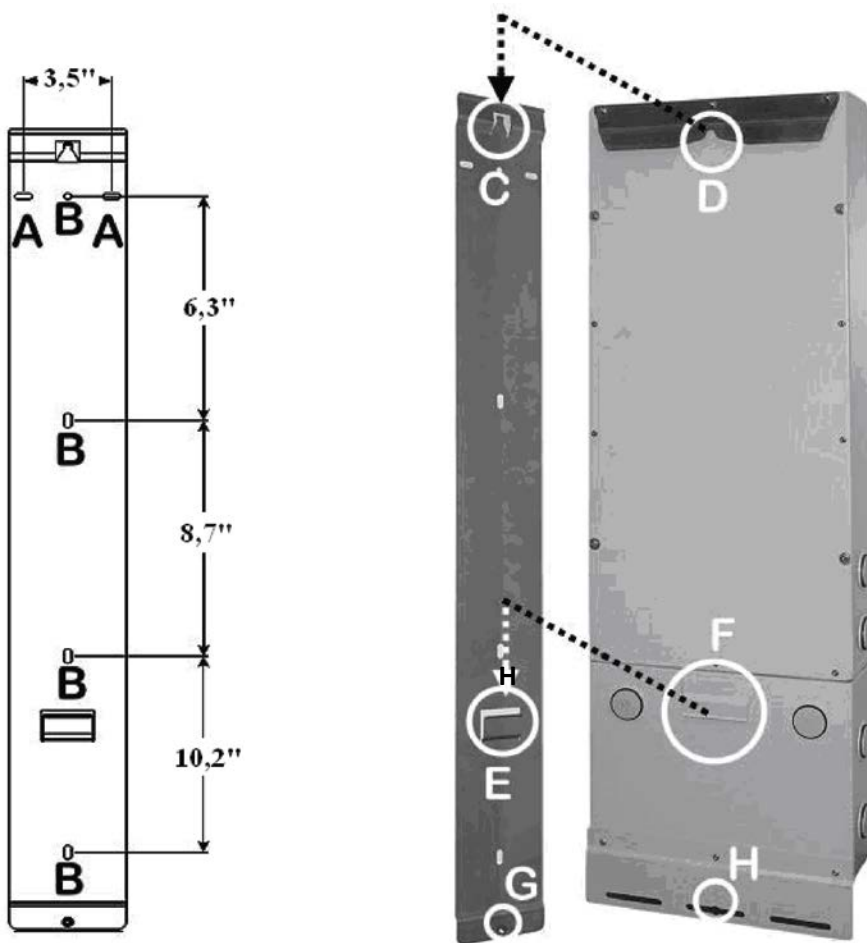

Figure 2:01 Bracket and Mounting Details

Step 1: Locate and mark the desired mounting location as shown above in mounting location.

Step 2: Orient the bracket such that the “C” hooks face outward and upward. (Figure.2:01)

Step 3: Using the hardware provided, level and mount the bracket to the surface using mounting holes shown in Figure 2:01.

Step 4: Hang the inverter on the mounted bracket by lifting the unit up over and above the mounting plate. Carefully guide the inverter and switchbox brackets and in the back of the inverter engage properly.

Step 5: Secure the bottom of the inverter using the machine screw (6x20mm) and washer (18mm diameter) provided. Insert machine screw through center hole of the bottom inverter mount,(H, Figure 2:01) and engage the PEMnut mounted in the bracket. (G, in Figure 2:01)

2a: 3.0 INSTALLATION PVI-3.0/3.6/4.2-OUTD-S-US

3.1 Removing The Front Covers

To access the wiring terminals in the inverter and switchbox (when provisioned) the inverter cover and switchbox cover must be removed. Refer to Figure 2:02

- To remove the front cover of the **inverter** compartment, loosen the four captive screws indicated using the Torx screwdriver provided.
- To remove the front cover of the **switchbox** Figure 2:02, loosen the four captive screws indicated using the Torx screwdriver provided in the box with the inverter.
- When connection operations are completed and the unit is connected, re-install the front covers and tighten the cover screws with at least 1.5Nm (13.2 in-lbs) torque to ensure proper waterproof sealing.



Figure 2:02- Location of Front Access Panels

3.2 Electrical Wiring and Connections PVI-3.0/3.6/4.2-OUTD-S-US

| | |
|---|--|
|  DANGER | <ul style="list-style-type: none"> • This section is dedicated to <u>initial</u> installation wiring of the AURORA UNO Inverter and assumes the unit has been physically mounted in its final location, but not yet wired. • If the inverter has been previously wired and connected to the PV array and/or the AC grid, refer to Part 4: Operations for disconnection procedures. |
|---|--|

3.2.1 Considerations Before Performing Electrical Connections

This section provides a systematic description of correct wiring procedures.

Please read the instructions provided and follow all safety warnings.

| | |
|--|---|
|  WARNING | <p>Failure to comply with these instructions can result in safety hazards and may lead to possible injury to personnel and/or equipment damage.</p> |
|--|---|

3.2.2 Field Wiring-Knockout-Details PVI-3.0/3.6/4.2-OUTD-S-US

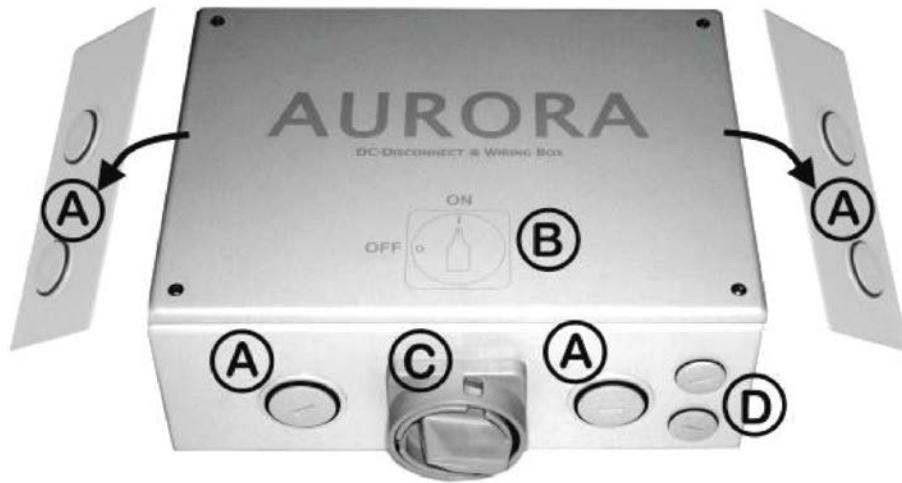

| Figure number | Description |
|---------------|--|
| A | DC and AC Power cable Knockouts Size: G1 |
| B | Silkscreen ON/OFF |
| C | DC Switch |
| D | Signal cable entries Size: G1"1/2 |

Figure 2:03 DC Switchbox Chassis Layout

To access the wiring components inside the switchbox shown in Figure 2:04, loosen the four cover panel captive screws shown in Figure 2:02, and remove the cover panel.



WARNING

The -S Version (PVI-3.0/3.6/4.2-OUTD-S-US) switchbox disconnects the DC current from the photovoltaic panels when the switch is in "OFF" position. It **DOES NOT** disconnect the AC connection to the grid. To disconnect the inverter from the AC grid, an AC switch (not included in this AURORA UNO switchbox) must be disconnected.

Due to the high voltage present on the power cable in the switchbox, ALWAYS disconnect the switchbox from the DC power cables, as described in the Part 4: Operations, prior to working on the cables.

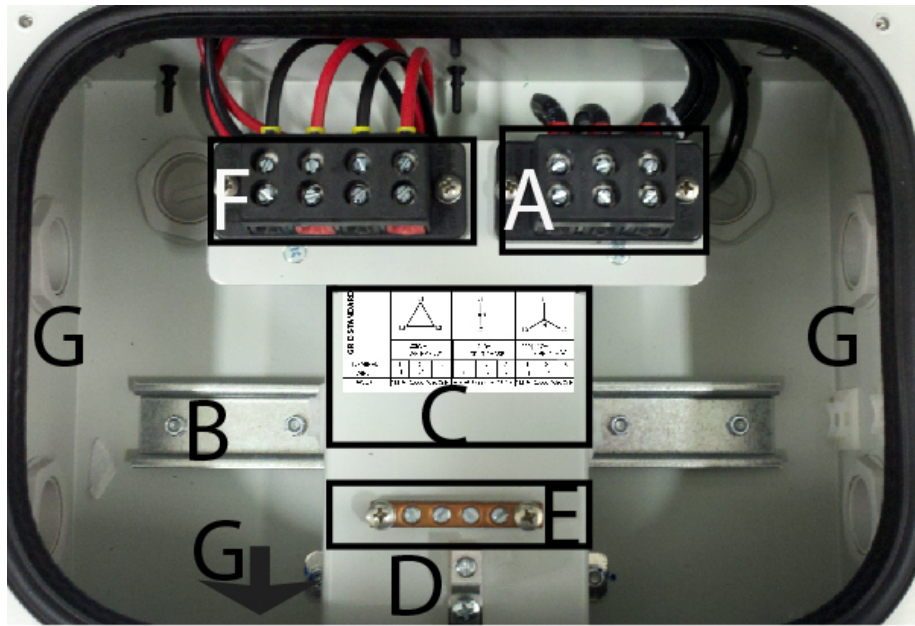



| Position: | Details: |
|-----------|--|
| A | Terminal Block AC OUT |
| B | DIN Bar for Accessories |
| C | Grid Standard Table |
| D | Main Ground –  Max Wire Size = AWG #4 (refer to local code for minimum wire size) |
| E | Ground |
| F | DC IN Terminal Block |
| G | Cable Knockouts |

Figure 2:04 Switchbox Wiring Connections Details (PVI-3.0/3.6/4.2-OUTD-S-US Version)

3.2.3 Initial Electrical Connections PVI-3.0/3.6/4.2-OUTD-S-US

| | |
|---|--|
|  <p>DANGER:</p> | <p>If the unit has been previously wired and energized, refer to Section 4: Operations for appropriate disconnection and maintenance procedures.</p> |
|---|--|

This section describes initial installation procedures for DC and AC wiring connections to the PVI-3.0/3.6/4.2-OUTD-S-US inverter. This version has an integral DC disconnect switch and associated switchbox.

- Typical system connection for this inverter is shown in 2:05.
- Relevant wiring connections are shown in Figure 2:03 and Figure 2:04.

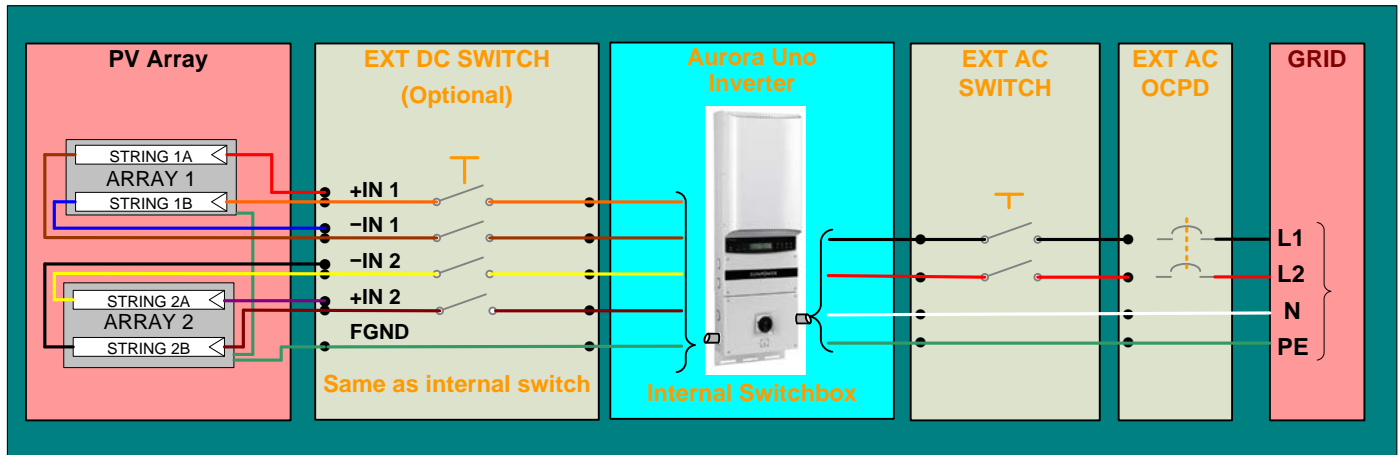

Figure 2:05: Electrical Connection Diagram PVI-3.0/3.6/4.2-OUTD-S-US

1. Refer to the photo of Figure 2:03 and locate the designated entry locations for the conduits from the DC array and to the AC grid.
2. Make sure the appropriate knockouts are employed for the use specified in order to maintain required spacing between wiring groups.

3.2.4 DC Array Connections



WARNING:

- Before attempting to connect the array wiring be certain the array sizing has been completed to the specific plan associated with the system being installed.
- To eliminate the potential for shock hazard during the connection procedure for the PV array wiring, either open-circuit all PV circuits prior to entry to the inverter and/or cover all panels with dark or opaque material in order to eliminate hazardous voltage at the terminals of the array wiring.

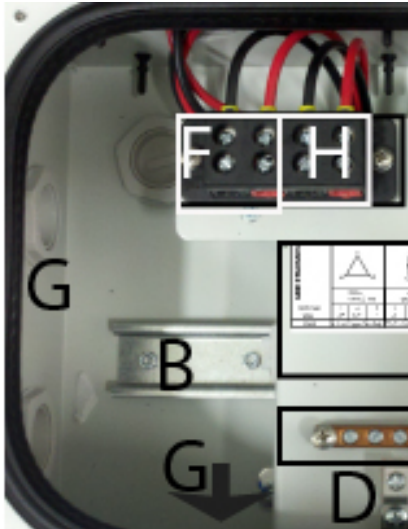

| Code | Details | |
|---------------------------------------|----------------------------------|---------------------|
| G | DC array conduit entry (KOs,3pl) | ¾ and 1" trade size |
| F | DC Array MPPT 1 input | Note 1 |
| H | DC Array MPPT2 input | |
| D | Array PE Ground | Note 2 |
| B | Din Rail for accessories | |
| Notes: | | |
| 1 Terminal accepts up to #20 to #6AWG | | |
| 2. Terminal accepts up to #4AWG. | | |

Figure 2:06- DC Array Wiring PVI-3.0/3.6/4.2-OUTD-S-US

- Refer to Figure 2:06. Locate the incoming DC array wiring at the inverter chassis. Measure the voltage to ensure the array output is non-hazardous.
- Once de-energized, connect the DC wiring to the MPPT1 and MPPT2 array terminals shown in inverter per the specific array design.
- If the array is wired for dual MPPT mode, run separate wires for POS and NEG for each array and ensure no jumpers are installed between the two inputs. See signaling section for more details.
- If the array is designed for the parallel MPPT input mode, ensure the jumpers shown in place. See signaling section for more details.
- Ensure the MPPT-mode switch is in the correct position to match the array design.

3.2.5 AC Grid Connections

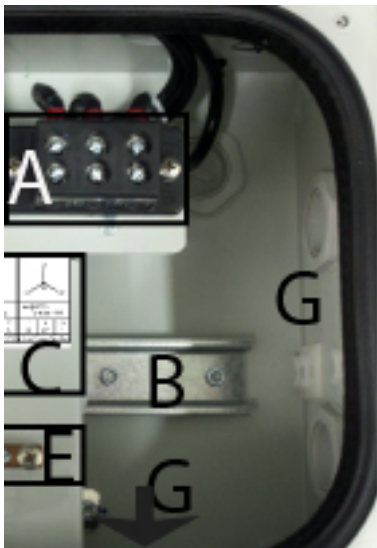

| Code | Details | |
|---------------------------------|----------------------------------|----------------------|
| A | AC grid output terminals | Note 1 |
| B | Din Rail | |
| C | Grid Standard connection table | |
| G | AC grid conduit entry (KOs, 3pl) | ¾" and 1" trade size |
| E | Main Ground ⓓ | Note 1 |
| Notes: | | |
| 1. Terminal accepts up to #4AWG | | |

Figure 2:07-AC Grid Connection

- Locate the AC grid wiring at the inverter switchbox. Measure the voltage to ensure all connections to the grid have been eliminated and no hazardous voltage is present.

| | | | | | | | | | | |
|----------------------|----------------------|--------------------------|----------|----------------------|--------------------------|---------|--------------------------|--------------------------|----------|--------|
| GRID STANDARD | | | | | | | | | | |
| | 208V~ 3-PH-Δ - 3W | | | 240V~ SPLIT-PHASE | | | 480 277V~ 3-PH-Y - 4W | | | |
| | TERMINAL WIRE | 1 L1* | 2 L2* | 3 - | 1 L1 | 2 L2 | 3 N | 1 N | 2 L1* | 3 - |
| | AWG# | #12-#4 -Copper Wire Only | | | #12-#4 -Copper Wire Only | | | #12-#4 -Copper Wire Only | | |

Figure 2:07b: Grid Standard

3.2.6 Signal Wiring Connections

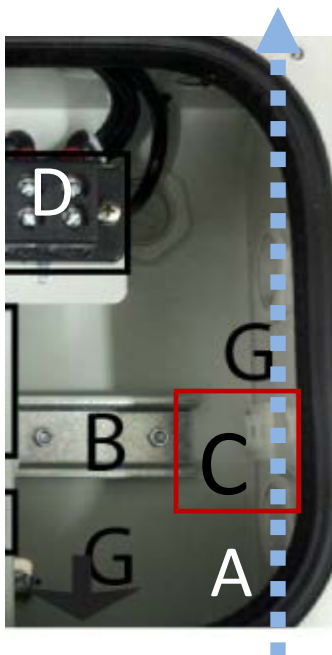

| Code | Details | |
|---|---|----------------------|
| A | RS485 Cable conduit entry (KOs) Chassis floor | ½" trade size |
| B | DIN rails for accessories | |
| C | Tie wrap anchor for signal cables | |
| D | AC grid connection terminal block (partial view) | |
| G | AC grid KOs, 4, pl | ¾" and 1" trade size |
| Note: Photo shows right side inside view of switchbox | | |

Figure 2:08 Switchbox Signal Wire Routing

- Route the cables through the switchbox keeping close to right wall of switchbox chassis (per dotted line in Fig. 2:08) and into the inverter chassis.
- Use tie wrap and plastic guide (item C, Figure 2:08.) to secure to wall
- Refer to Figure 2:03, and note the position where the monitoring and alarm cables (if used) enter the chassis.
- Refer to Figure 2:03. Locate the terminals for the alarm and monitoring connections within the chassis.
- Connect alarm cable to the mating connector (in hardware kit) and plug connector into position shown in Figure 2:09.

3.2.6.1 Connect RS485 Monitoring Cable

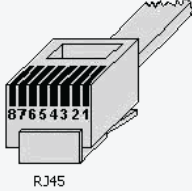
| | Pin # | Signal Name | Description | Notes |
|---|---------|-------------|---------------|-------|
|  | 1,2,6,8 | N/U | - | - |
| | 3 | +TR | + Data Line | 1 |
| | 4 | +R | Remote OFF | 2 |
| | 5 | -TR | - Data Line | 1 |
| | 7 | RTN | Signal Return | 1 |

1. Required for RS485 communication
 2. Required or Remote OFF control
 3. Common reference for logical signals

Table 3: RJ485 Connectors

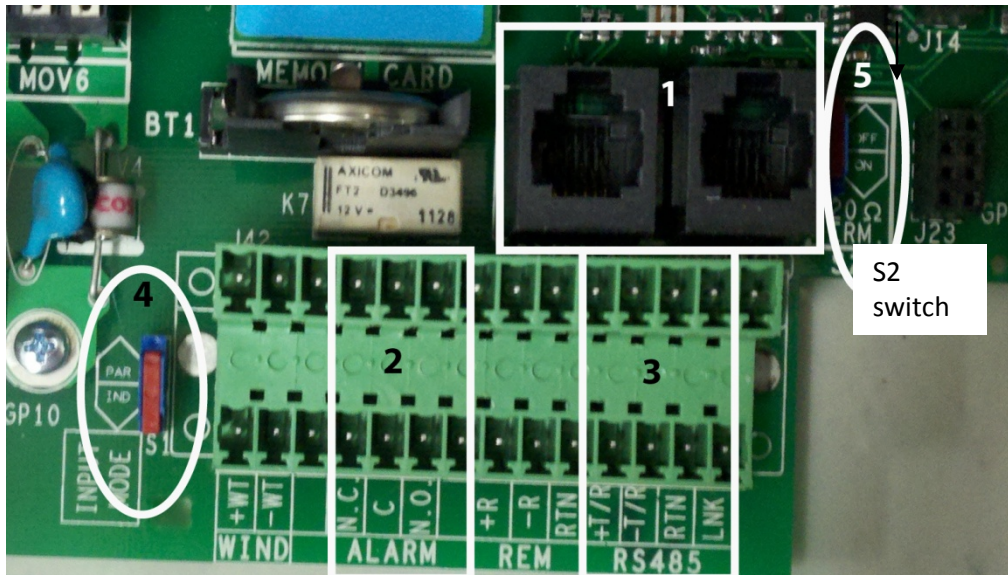

| Position | Details | Notes |
|----------|------------------------------------|--|
| 1 | RJ45 connectors for RS485 | Use with CAT5/6 cable and mating plug |
| 2 | Alarm Function connection | |
| 3 | RS485 connection | For use with standard RS485 cable |
| 4 | Input mode switch (S1) | For setting array input mode (PAR/IND) |
| 5 | RS-485 Bus Termination Switch (S2) | Electrical termination ON/OFF for end of bus |

Figure 2:09: Standard RS485 connection

- a. If using CAT5 cable for monitoring connections, connect RJ45 plug to end of cable as shown in Table 3, and plug into RJ45 jack shown in Figure 2:09; a second jack is in parallel to accommodate daisy chaining of communication line to other inverters.
- b. If using standard multi-wire cable connect the three RS-485 leads. Use (RTN, +T/R, -T/R) to corresponding points per Figure 2:09. Plug connector into position (Figure 2:09). To connect the wires to the terminal requires use of mating connector found in hardware bag. Connect wiring to the mating connector in positions shown, and plug into the terminal block shown in Fig 2:09)

If multiple inverters are used such that the RS485 cable must be daisy chained to another inverter, then there will be two cables,(i.e., an entering and an exiting cable). Each cable will have three wires to be connected. Connect one cable as noted above, and use second mating connector to connect wiring of the second cable, using same process. Plug second mating connector into second row of terminals.

NOTE: Typical application has no wire connection to pin on far right hand side.

2a: 3.3 Configuration Settings - PVI-3.0/3.6/4.2-OUTD-S-US

The Aurora Inverter is configurable with an independent MPPT for each DC input channel or with the two input DC channels connected in parallel with one MPPT. If the inverter is configured with two independent MPPTs, the max current for each channel shall not exceed 10Adc (3.0kW)/16Adc (3.6kW) 16Adc (4.2kW) and the power input for the single channel shall not exceed 6.8 kW.

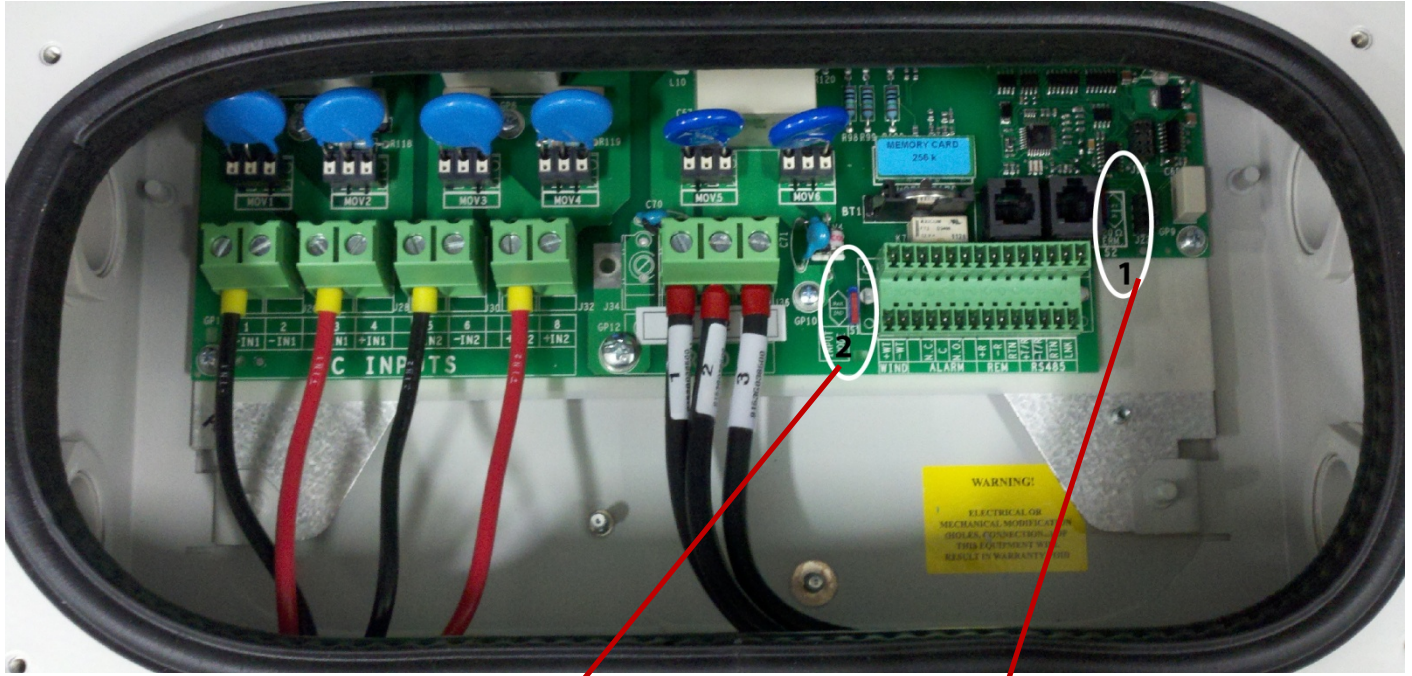
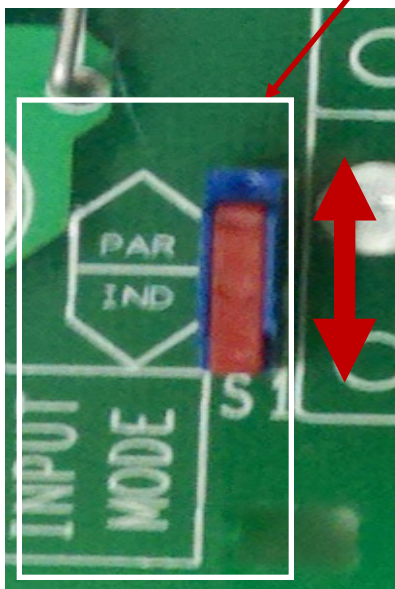
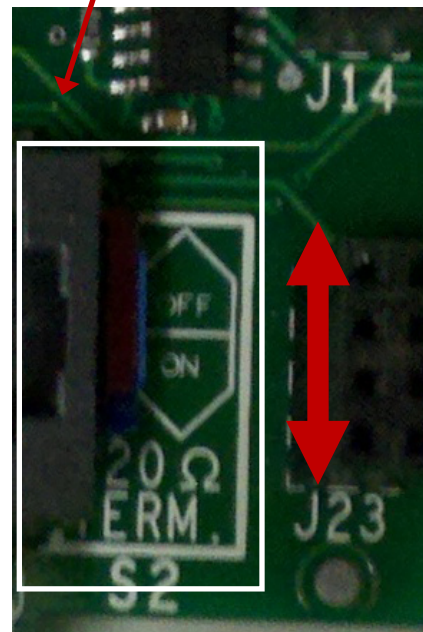



Figure 2:10: Configuration Settings



S2: PAR/IND INMODE SWITCH



S1:RS485 TERMINATION SWITCH

| | |
|---|---|
|  WARNING: | Once the installer has selected a grid standard and energized the inverter, an internal, 24 hour counter will start to count down. During the first 24 hours of grid connection it is possible to modify the chosen standard (in case of mistakes). After 24 hours, the chosen setting is finalized and cannot be changed without contacting Power-One Customer Service. User can check the counter residual time via the LCD scrolling menu. |
|  WARNING | Before selecting the inverter grid standard on the, accurately identify the required utility grid standard. |

3.3.3 Independent Or Parallel Connection of Dual Inputs

The Aurora inverters have dual inputs with independent MPPT circuits. The inverter when operated in the dual input mode can optimize two independent arrays. The inverter can also be operated in a single MPPT mode from a single array by connecting the inputs in parallel using jumpers and proper setting of the INMODE switch (see figure 2.10, above. The following sections show how to connect the inverter in either the INDependent or PARAllel mode.

3.3.3.1 Independent Connection

For applications where the two MPPT channels will be used independently:

- Place switch “INMODE” (shown in Figure 2:13a) in the “IND” (default position) position to configure the inverter controls in the independent mode.
- Connect the array to the terminal blocks shown in Figure 2:13b.
- Note, in this mode up to four strings can be connected (two per input) without need of external combiner fusing; **however, only one conductor can be landed at the inverter terminal block**, Therefore, when two strings must be connected to a single input channel, they must be paralleled externally or in the switchbox using suitable Listed terminations prior to connection at the input terminal block.
- After switching the AURORA UNO Inverter to independent mode configuration, re-install the front panel (apply 13.2 in-lbs of torque to each of the 4 screws).

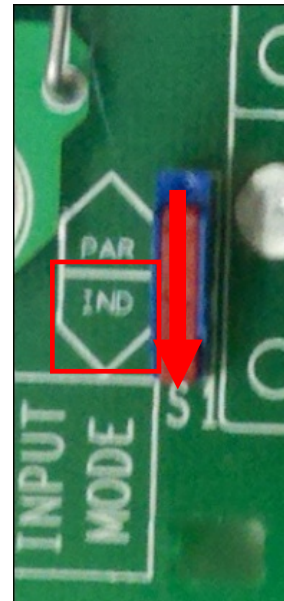

Figure 2:13a: Independent MPPT Configuration Switch

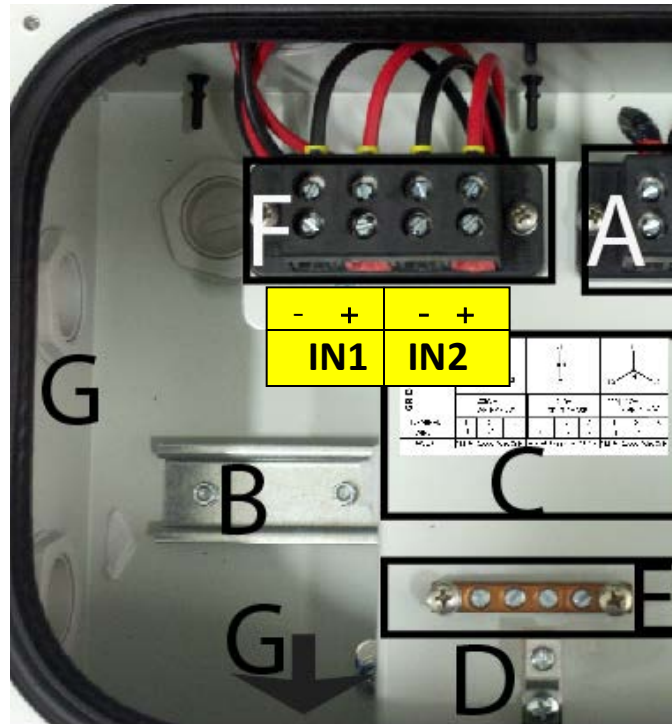

Figure 2:13b: DC input terminal wiring

3.3.3.2 Parallel Connection

To operate the inverter in the single MPPT mode:

- Place INMOD switch (shown in Figure 2:14a) in the “PAR” in order to configure the inverter controls in parallel mode.
- In the inverter box, parallel connect the two MPPT inputs using terminal [-IN1 and -IN2] and [+IN1 and +IN2] as shown in Figure 2:14b using two #10 AWG jumper wires (1 black and 1 red cable) supplied.
- Connect two strings to the input as shown in Fig 2:13b.
- Note: In the PARallel mode, only two strings can be directly connected to the inverter; if more than two strings are required, all strings must be combined in an external fused (2-pole) combiner box, or the IND mode must be used.

- After switching the AURORA UNO Inverter to parallel mode configuration, re-install the front panel (apply 13.2 in-lbs of torque to each of the 4 screws).

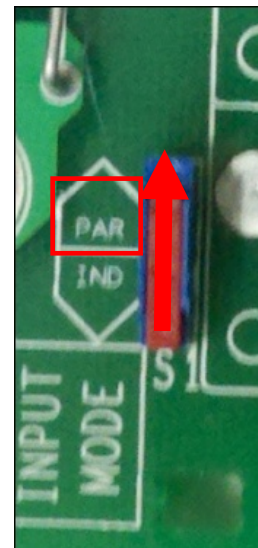

Figure 2:14a: Parallel MPPT Configuration Switch

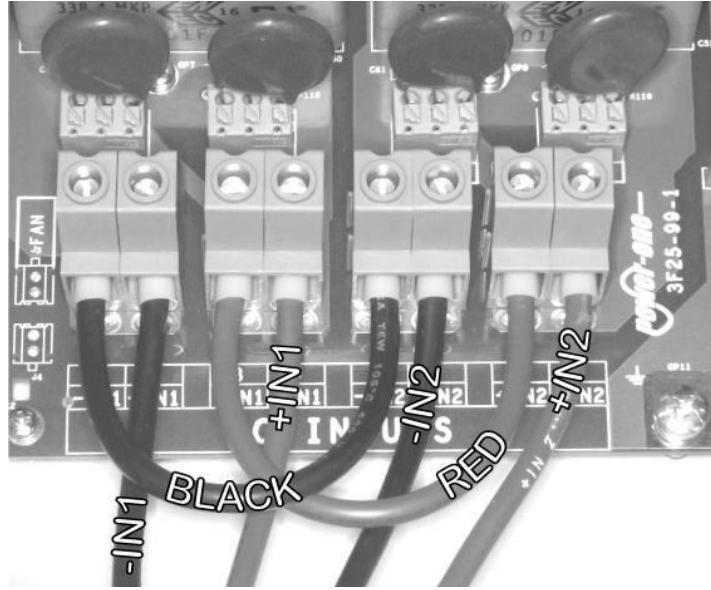

Figure 2:14b: Paralleling jumpers for *PAR* MPPT Configuration

SECTION 4: WIRING DETAILS

4: 1.0 AC AND DC WIRING AND OVER CURRENT PROTECTION



WARNING

Before selecting the grid standard on the unit, check accurately what is the necessary standard.

**Table 0-1: Wiring Details for
 No Switchbox version**

| Wire sizing parameter | DC side | | Wire sizing parameter | AC side | |
|--------------------------------------|--------------------------|----------------------|--------------------------------------|--------------------------|----------------------|
| | Rating | Comments | | Rating | Comments |
| Array wiring terminals | | | Grid wiring terminals | | |
| Rated temperature | 90° C | Screw terminal block | Rated temperature | 90° C | Screw terminal block |
| Wire Size Range | #20-#6 AWG | | Wire Size Range | #20-#6 AWG | |
| Tightening Torque | 13 in-lb | | Tightening Torque | 13 in-lb | |
| Number of wire landings per terminal | 2 | | Number of wire landings per terminal | 1 | |
| Allowable conductors per terminal | 1 | | Allowable conductors per terminal | 1 | |
| Max Current values | See Technical Data table | | Max Current values | See Technical Data table | |
| RS-485 Terminals | 75° C | | | | |
| | 8 in-lb | slotted screws | | | |

4: 1.2 MULTI-UNIT CONFIGURATION

1.2.1 Daisy Chain

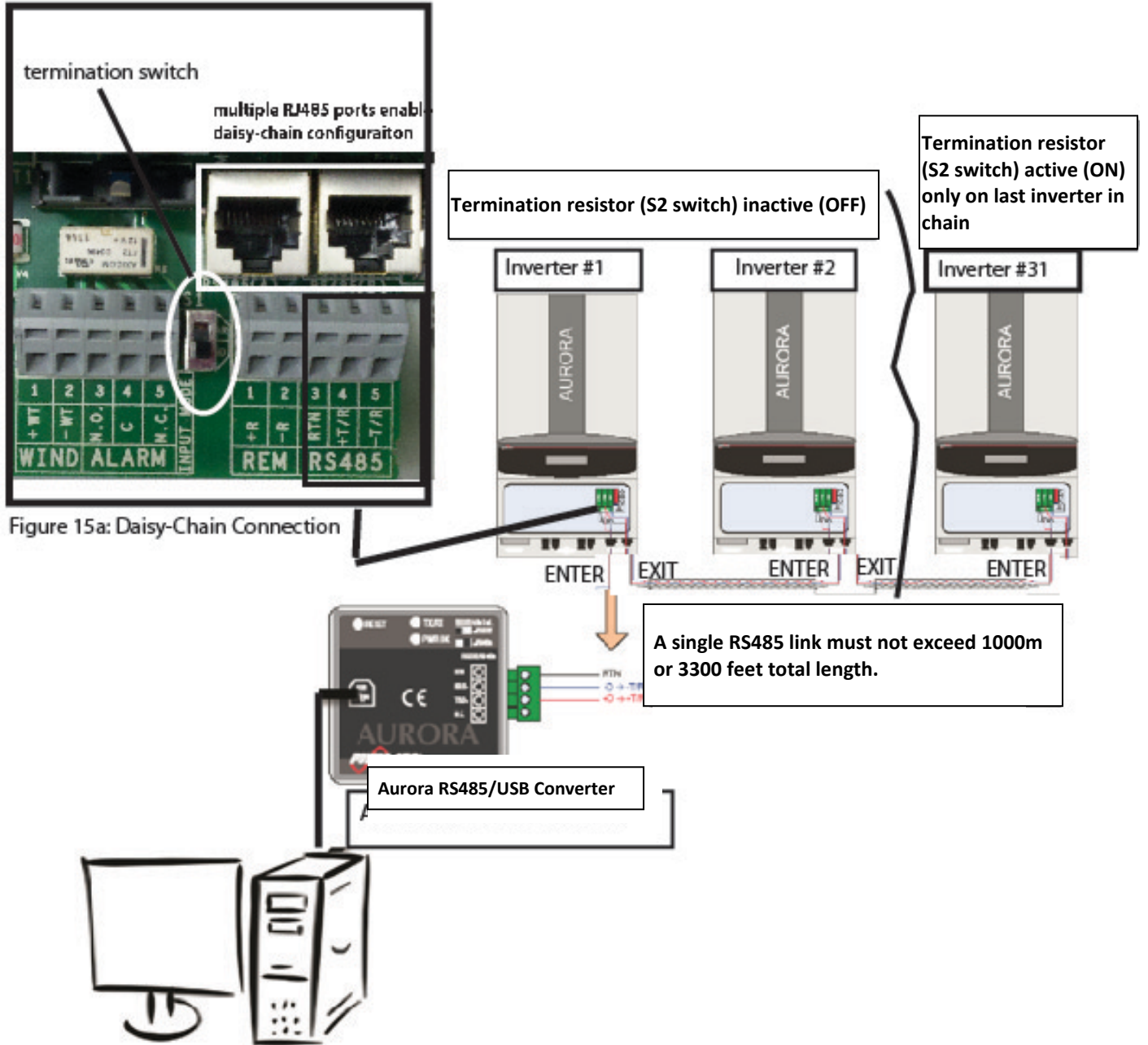

Figure 15a: Daisy-Chain Connection

Figure 15b: Daisy-Chain Configuration

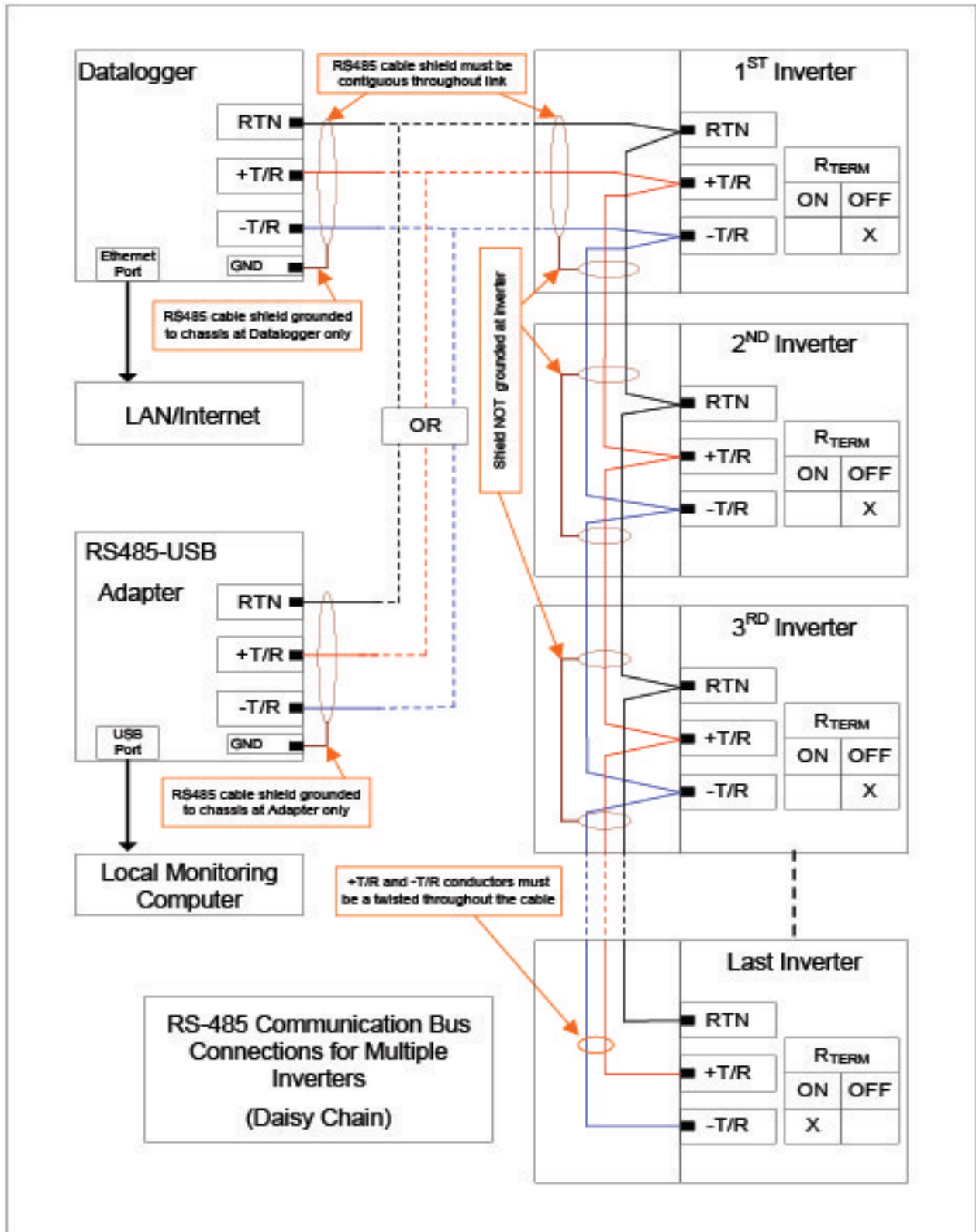

Figure 15C: Daisy Chain Communication wiring

The RS-485 terminal block or RJ45 connectors can be used to connect a single Aurora Inverter. This terminal block also enables a multi-unit wiring configuration called "daisy-chain configuration". See shown in Figure 15a and 15b

1.2.1.1 Connection & Cabling

Per the RS485 standard, it is possible to connect up to 31 AURORA Inverters on one RS485 bus link, however, the feasibility of this arrangement is very dependent on the type of cabling used for the link and the workmanship of the bus connections. Also, most data loggers are limited by the manufacturer as to the total number of slave units connectable. Please verify all aspects of the intended communication system and components before attempting to install a monitoring system.

The recommended length of total communication cable line for all inverters in the system is 1,000 meters [1094 yards] or less, and this distance capability depends strongly on the cable type used and installation workmanship.

Depending on the type of computer used, the cable line adaptor can be RS485-RS232 or RS485 to USB.

In order to ensure optimum communication on the RS-485 line, Power-One recommends connecting the RS-485 converter to a location between the first unit in the “daisy chain” or multi-unit system configuration and the computer; not in between two inverters in the series.

NOTE:

- The ON position means the RS485(B) port is inactive.
- The OFF position means the RS485(B) port is active.

STEP 1: Using the appropriate cable, connect all the Aurora Inverter units according to the “daisy-chain” cabling method ENTER- EXIT. Make sure to respect the correspondence between all the signals. See Figure 15c.

STEP 2: Locate the S2 switch. See Figure 15a. Push the switch **up** into the **OFF** position for every inverter in the chain except for the last inverter. The last inverter needs to have the S2 switch pushed **down** into the **ON** position.

4.1.3 ADDRESSING EACH INVERTER

When multiple inverters are connected in a daisy chain, it is necessary to assign a different RS-485 address to each unit.

Selecting this function enables the bus addresses (for the inverter connected to the RS485 communication bus) to be set to an appropriate value. Address values are assigned manually using any value in the range [2 to 64]. Press the **UP** and **DOWN** keys to scroll numbers. NOTE: Maximum 31 inverters in a line. (See Part 4: Operations Guide for further details.)

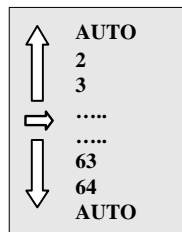

Do not select 'AUTO' as the RS485 address in a multi-unit, daisy-chain configuration.

Every AURORA device has a default address of [02] two, with the S2 switch in the OFF position.

Other third party RS485 converters, available on the market can also be used but Power-One does not assure correct connection operation since these devices have never been specifically tested. Also, please note that other commercial devices could require external termination impedance, which is not necessary for Aurora brand RS485 converters.

The diagram in Figure 2:15c shows how to connect multiple units into a daisy-chain configuration.

SOFTWARE:

Included in the shipment of the AURORA UNO Inverter is the AURORA Installer CD.

The installation of this software is optional as most of this functionality can be done through the inverter display. If it is desired to view the basic monitoring and setting options from a computer screen, follow the installation instructions in 1.3.1:

1.3.1 Install Instructions:

Remove the disk from its cover. Insert the disk into the computer to install the desired program onto the computer.

Connect the adapter from inverter to the computer. Depending on the configuration determine the type of converter needed (RS485-RS232 or RS485-USB).

For more a more comprehensive monitoring solution, please see Power-One's AURORA Vision product line at www.power-one.com

PART 4: OPERATIONS GUIDE

4: 0.1 COMMISSIONING

The procedure for commissioning AURORA Inverter is as follows:

- 1) Set the inverter's DC disconnect switch (external or part of switchbox version) to ON.
- 2) Set the AC disconnect switch (external or part of switchbox depending on version) to the inverter to ON.

NOTE: There is no specific order for closing the two switches.

- 3) Once both switches are closed, the inverter starts the grid connection sequence. This routine is indicated by the flashing green LED labelled POWER over the display.

This routine may take from 30 seconds up to several minutes, depending on grid condition. Three screens are shown in sequence on the LCD display during this routine:

- Grid voltage value and status compared to specified values (within/outside range).
 - Grid frequency value and status compared to specified values (within/outside range).
- 4) When the connection sequence is completed the AURORA Inverter starts operating. Proper operation is indicated by a warning sound and the green LED lights steadily green.
 - 5) If the grid check routine does not give a positive result, the unit will repeat the procedure until all grid voltage; frequency parameters and grid configuration are found or changed to be within the specified range. During this process, the green LED will keep flashing.

4: 1.0 INVERTER START-UP and OPERATION



WARNING

- Do not place any items on the AURORA Inverter during operation.
- Do not touch the heat sink when the inverter is operating, as some parts may be hot and cause burns.

1.1 NORMAL START- UP PROCEDURE

| Front Panel LED Operation | | | |
|---------------------------|--------------|---------------------|--------------------|
| LED | Label | LED Status | |
| | | LIT | UNLIT |
| 1 | POWER | Inverter power on | Inverter power off |
| 2 | ALARM | Active alarm | Normal operation |
| 3 | GFI | Active ground fault | Normal operation |



| Name of Key | Function Description |
|--------------|---|
| ENTER | Moves cursor from existing menu location to new menu location |
| ESC | Escapes action of previous ENTER |
| UP | Moves cursor upward in menu tree |
| DOWN | Moves cursor downward in menu tree |

The green 'Power' LED indicates that the ARUROA Inverter is operating correctly.

**Power-One Initializing...
Please wait...**

Missing Grid

If DC = > 200V

If DC = < 200V

Initializing stops until grid is found or settings are changed to match voltage.
Possible error codes:
W007: Grid Under Frequency
W006: Grid Over Frequency
W005: Output Under Voltage
W004: Output Over Voltage

**Next connections..
2 sec**

Waiting Sun...

Inverter is waiting for the sun/wind.
Possible error codes:
E002: Input Under Voltage
W011: Sun Low
E013: Wrong Mode (PAR/IND)

Unit cycles through various screens while connecting.

= Inverter OK. Cycles through Inverter statistics

= Error/Alert/Warning
May see any of the remaining error codes

Fault Description

Ground Fault

The yellow 'FAULT' LED indicates that the AURORA Inverter has detected a fault condition. A fault description will appear on the display. See troubleshooting section of this manual or contact Power-One Technical Support.

Red GFI Ground Fault on the DC side of the system.
Press ESC to restart
See troubleshooting section to help or contact Power-One Technical Support.

Depending on the DC input voltage present, the inverter behaves as follows:

- a) When the inverter is switched ON, it will start as soon as the input voltage value of 130 Vdc is reached.
- b) The inverter will display the message 'Waiting Sun' until the input voltage exceeds the set Vin start value.
- c) When the Vin start value is exceeded, the inverter will connect to the grid if it is identified or it will display the message 'Vac absent' if the grid is not connected.
- d) The inverter will remain connected to the grid if the input voltage is between 70% of the Vin start set and 520 Vdc. If the input voltage value is outside this range, the inverter disconnects itself from the grid.

1.2 SHUT-DOWN PROCEDURE

There are three options for shutting down the inverter:

- 1) Disconnect the DC and the AC grid, by disconnecting its associated switches (in any order). The inverter will shut down within a few seconds necessary to discharge the internal capacitors.
- 2) Disconnect the DC input by turning-off the associated disconnect switch and waiting for the UV port time out.
- 3) Disconnect the grid, by turning-off its associated disconnect switch and reduce DC input to less than 130 Vdc.

1.3 POWER-DOWN PROCEDURES

Once the inverter is wired and connected to the grid use the following procedures to disconnect for maintenance.

| | | |
|--|----------------|--|
| | WARNING | Before performing any operation on the switchbox power input, ALWAYS perform the appropriate disconnection procedure outlined below. |
|--|----------------|--|



Figure 4:02: Location of Front Access Panels

1.3.1 Disconnection Of AURORA Inverters

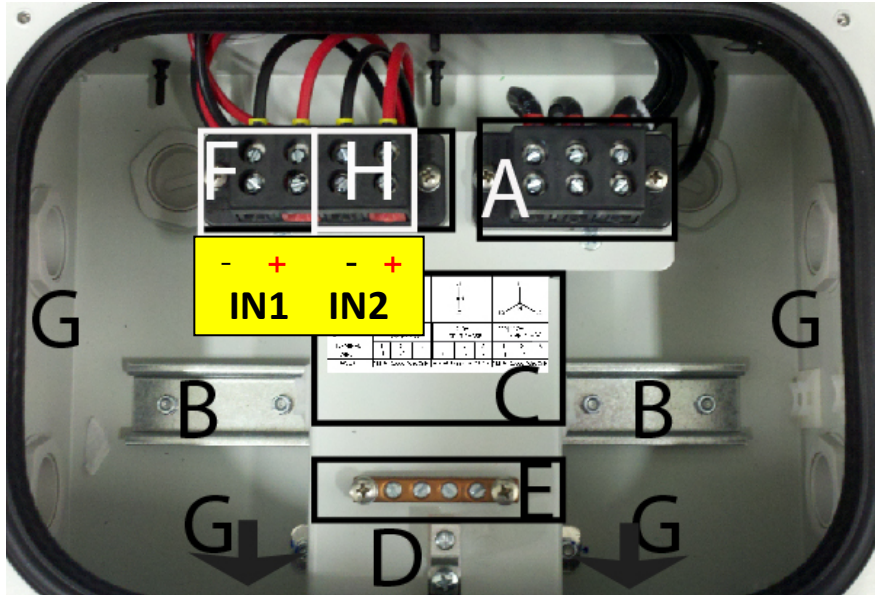

| Position: | Details: |
|-----------|---|
| A | Terminal Block AC OUT |
| B | DIN Bar for Accessories |
| C | Grid Standard Table |
| D | Main Ground –  Max Wire Size = AWG #4 (refer to local code for minimum wire size) |
| E | Ground bar |
| F | DC IN Terminal Block, MPPT Input 1 |
| H | DC IN Terminal Block, MPPT Input 2 |
| G | Cable Knockouts |

Figure 4:03: PVI-3.0/3.6/4.2-OUTD-S-US-Wiring Connection Details

Refer to Figure 4:03 Wiring Connection Details for the following procedure:

Step 1: Disconnect from the AC Grid by one of the following methods:

- a. Turn-OFF the external AC switch
- b. Turn-OFF the Over Current Protection Device (circuit breaker)

Step 2: Disconnect the inverter from the PV array by turning OFF the external DC disconnect switch connect the DC cable to the terminal block on the PCB. Be sure respecting marking (+In1, -In1, +In2, -In2) and carefully check the correct polarity of the DC cable.

Step 3: Remove the inverter cover seem (Figure 4:02). Using a voltmeter, check voltage levels at the DC input terminals and the AC output cables to ensure no hazardous voltages are present.

4: 2.0 OPERATIONS: USER INTERFACE, MONITORING AND DATA TRANSMISSION

2.1 USER INTERFACE MODE

Normally, the AURORA Inverter operates automatically and needs no particular supervision. When solar radiation is not enough to generate power for the grid (for example: at night), AURORA Inverter disconnects automatically and goes into a standby mode.

The operating cycle resumes automatically when sufficient sunlight becomes available.

The AURORA Inverter provides operational data to the user through the following instruments:

- LED Indicator lights
- LCD display
- Digital data transmission is via a dedicated RS-485 serial port using **AURORA Inverter Protocol** and a PC or a data logger equipped with an RS-485 port collects data. If an RS-485 line is used, it may be convenient to use the AURORA USB/RS-485_232 serial interface converter (model number PVI-USB-RS485_232). The optional AURORA PVI-UNIVERSAL data logger is also available, which allows a web-based monitoring platform.

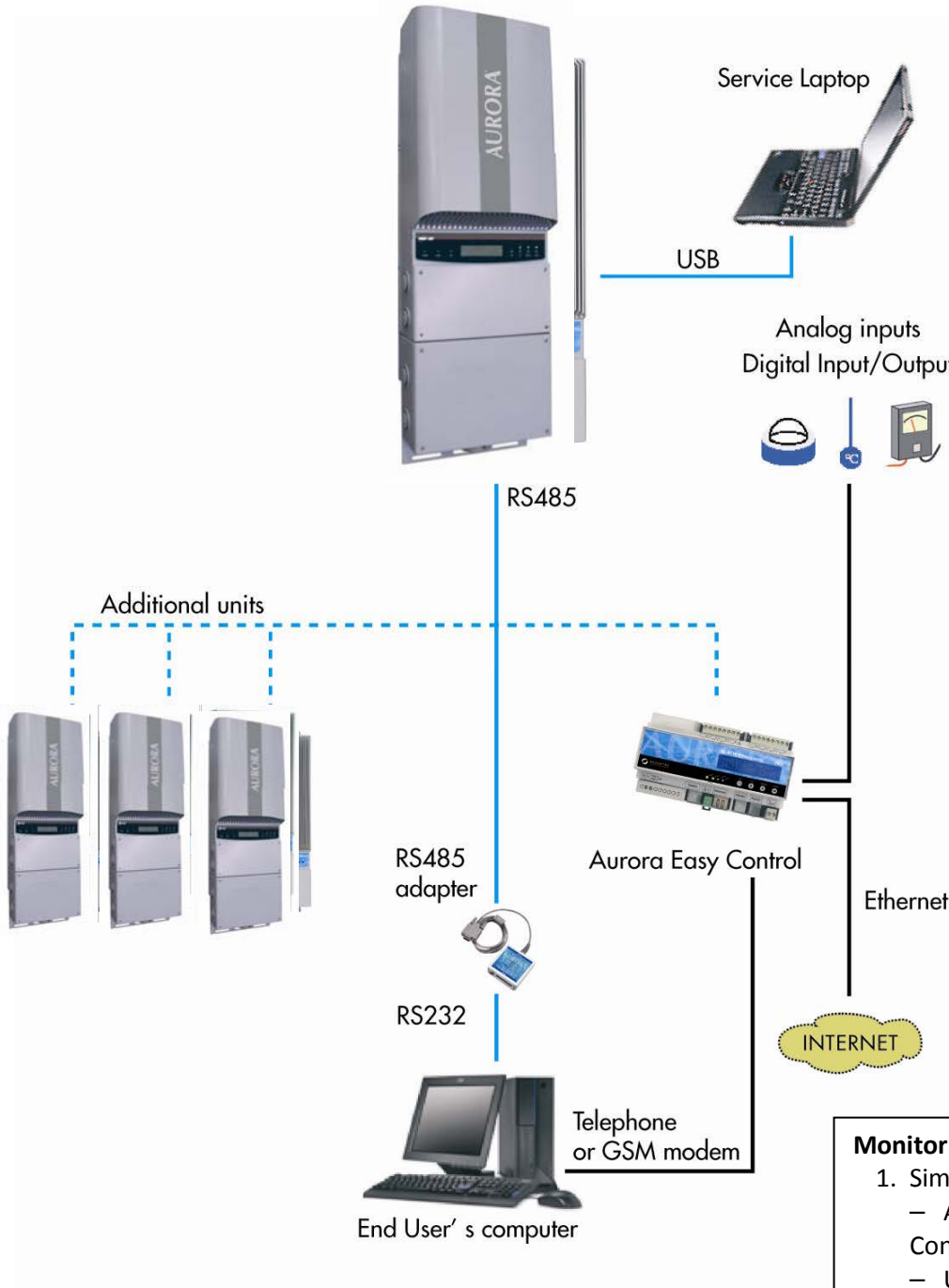

Figure 04:4- Data Transmission Options

Monitoring System Options

1. Simple Monitor
 - Aurora RS485/USB Line Converter
 - User Supplied PC
 - Use **Aurora Communicator** Software
2. Web Based Data Logger
 - Use **Aurora Universal** Data Logger
 - Optional I/O (Meters, Irradiance Sensors, etc.) can be connected
 - Ethernet (LAN) to Internet and connection to Aurora Web Portal service

2.2 DATA TYPES AVAILABLE

AURORA Inverter provides two types of data that can be collected using the display and/or the appropriate interface software.

2.2.1 Real-Time Operational Data

Real-time operational data can be transmitted on demand through the communication lines and are not stored inside the inverter. The free AURORA Communicator software (included on the installation CD) may be used to transmit data to a PC. Please check the Power-One website at www.power-one.com for the latest updated version.

The following data is available via the RS-485 link:

- Grid voltage
- Grid current
- Grid frequency
- Power transferred to the grid
- Voltage of photovoltaic array 1
- Current of photovoltaic array 1
- Voltage of photovoltaic array 2
- Current of photovoltaic array 2
- Serial Number/Code
- Week of production
- Firmware revision code
- Daily energy
- Leakage current of the system
- Total energy
- Partial energy
- Mean grid voltage
- Insulation resistance
- Leakage current to ground
- Date, time

2.2.2 Data Logged Internally

Power-One's AURORA Vision stores the following data internally:

- Total and partial counter of grid connection time.
- Total and partial counter of energy transferred to the grid.
- Daily Energy Production (365 values).
- Energy transferred to the grid every 10 seconds for the last 8,640 periods of 10 seconds (which on average cover more than 2 days of logged data).
- Last 100 fault conditions with error code and time stamp.
- Last 100 changes to grid connection parameters with parameter code and new value.

The first two types of data are displayed on the LCD display and through the RS-485 interface, while all other data can be displayed only through the RS-485 interface.

2.3 LED INDICATORS

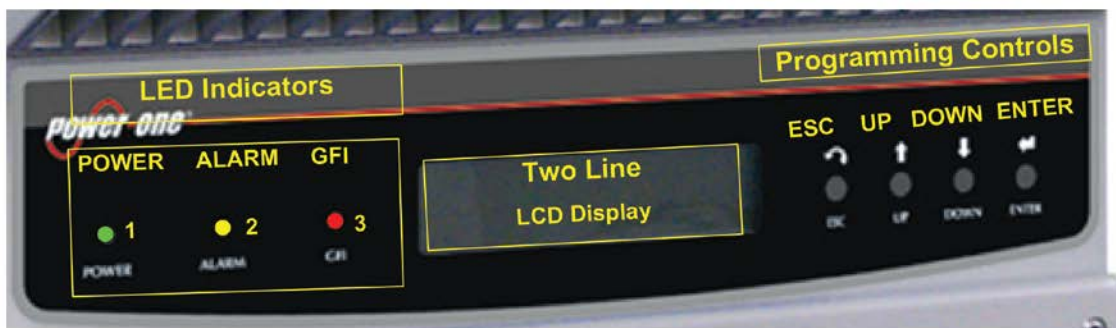



Figure 4:05: Location of the buttons and LEDs

There are three LEDs on the left side of the display:

1. The green 'Power' LED indicates that AURORA Inverter is operating correctly.
This LED flashes upon start-up, during the grid check routine. If a correct grid voltage is detected and solar radiation is strong enough to start-up the unit, the LED stays on steady. If not, the LED keeps flashing until solar radiation becomes strong enough to start-up the inverter. In this condition, the display will read '**Waiting Sun....**'
2. The yellow 'FAULT' LED indicates that the AURORA Inverter has detected a fault condition. A fault description will appear on the display.
3. The red 'GFI' (ground fault) LED indicates that AURORA Inverter is detecting a ground fault in the DC side of the photovoltaic system. When this kind of fault is detected, the AURORA Inverter disconnects from the grid and the corresponding fault indication appears on the LCD display. AURORA Inverter remains in this condition until the operator presses the ESC key to re-start the grid connection sequence. If pressing the ESC key doesn't clear the ground fault check the ground-fault, fuse located in the switchbox. If AURORA Inverter does not reconnect to the grid, contact Power-One Technical Service.

| | |
|--|--|
|  DANGER: | Normally grounded conductors may be ungrounded and energized when a ground-fault is indicated. <ul style="list-style-type: none">• Risk of electric shock• Test before touching• Work on the AURORA Inverter must be carried out by qualified personnel. |
|--|--|

The following table shows all the possible LED-signalling indications related to the operational status of AURORA Inverter.

Key:



LED on



LED off



LED flashing



Any of the above conditions

| | LED STATUS | OPERATIONAL STATUS | NOTES |
|---|--|--|--|
| 1 | 1: green: ☒ 2: yellow: ☒ 3: red: ☒ | AURORA self-disconnects during night-time | Input voltage less than 90 Vdc at both inputs |
| 2 | 1: green: ◻ 2: yellow: ☒ 3: red: ☒ | AURORA Inverter initialization, settings loading, and waiting for grid check | It is in transition status while operating conditions are being checked. |
| 3 | 1: green: ◻ 2: yellow: ☒ 3: red: ☒ | AURORA Inverter is powering the grid | Standard machine operation (search for maximum power point or constant voltage) |
| 4 | 1: green: ◻ 2: yellow: ◻ 3: red: ◼ | System insulation device faulty | Leakage to ground found |
| 5 | 1: green: ☒ 2: yellow: ◻ 3: red: ☒ | Defect – fault!!! | The fault can be inside or outside the inverter. See the alarm appearing on the LCD display. |
| 6 | 1: green: ☒ 2: yellow: ◻ 3: red: ☒ | Installation Phase: AURORA Inverter is disconnected from the grid. | During installation, it indicates set-up phase of the address for RS-485 communication. |
| 7 | 1: green: ◻ 2: yellow: ◻ 3: red: ☒ | Grid disconnection | Indicates a missing grid condition |



NOTE: Inverter status is indicated by the corresponding LED turning to a steady ON-condition or flashing, and by a message on the AURORA LCD displaying a description of the existing operation or fault condition (see the following sections).

2.4 MESSAGES AND ERROR CODES

| | |
|---|---|
|  <p>DANGER:</p> | <p>Normally grounded conductors may be ungrounded and energized when a ground-fault is indicated.</p> <ul style="list-style-type: none"> • Risk of electric shock • Test before touching • Work on the AURORA Inverter must be carried out by qualified personnel. |
|---|---|

The system status is identified through message or error signals displayed on the LCD display. The following tables briefly describe the two types of signals which may be displayed.

- **MESSAGES** identify the current status AURORA Inverter status. Messages do not relate to a fault. When a **(W)** with a number after it appears in the display, it indicates a **WARNING CODE** and is usually cleared through an orderly shutdown/re-set or a self-corrective action performed by the inverter. See the **(W)** codes in the following table.
- **ALARMS** or **(E)** codes identify a possible equipment failure, fault or incorrect inverter setting/ configuration. However, some of the **(E)** codes may require contacting SunPower Technical Support to assist in correcting a fault. Any and all attempts to correct or clear a fault must be performed by qualified personnel. Typically, the **(E)** can be cleared once the cause or fault is removed. Some of the **(E)** codes, (INT. Error) as indicated in the table below, may indicate a fatal error and require the support of Power-One Technical Support for diagnostics support. The appearance of an alarm signal will be managed as much as possible by AURORA Vision or, in case this is not possible, AURORA Vision will supply all the necessary information to perform the maintenance operations and to fix the fault on the equipment or system. See the **(E)** lines in the following table.

| Message | Error Warning | Error Type | Description | Message | Error Warning | Error Type | Description |
|------------|---------------|------------|--------------------------------------|-----------|---------------|------------|-----------------------|
| Sun Low | W001 | // | Input Voltage under Vstart threshold | Int.Error | // | E022 | Autotest Timeout |
| Input OC | // | E001 | Input Overcurrent | Int.Error | // | E023 | Dc-Injection Error |
| Input UV | W002 | // | Input Undervoltage | Grid OV | W004 | // | Output Overvoltage |
| Input OV | // | E002 | Input Overvoltage | Grid UV | W005 | // | Output Undervoltage |
| Int.Error | // | E003 | No parameters | Grid OF | W006 | // | Output Overfrequency |
| Bulk OV | // | E004 | Bulk Overvoltage | Grid UF | W007 | // | Output Underfrequency |
| Int.Error | // | E005 | Communication Error | Z Grid HI | W008 | // | Z grid out of range |
| Out OC | // | E006 | Output Overcurrent | Int.Error | // | E024 | Unknown Error - |
| Int. Error | // | E007 | IGBT Sat | ----- | // | E025 | Riso Low (Log Only) |
| Sun Low | W011 | // | Bulk Undervoltage | Int.Error | // | E026 | Vref Error |
| Int.Error | // | E009 | Internal Error | Int.Error | // | E027 | Vgrid Measures Fault |
| Grid Fail | W003 | // | Grid Fail | Int.Error | // | E028 | Fgrid Measures Fault |
| Int.Error | // | E010 | Bulk Low | Int.Error | // | E029 | Zgrid Measures Fault |
| Int.Error | // | E011 | Ramp Fail | | | | |
| Over Temp. | // | E014 | Overtemperature | Int.Error | // | E030 | Ileak Measures Fault |
| Cap. Fault | // | E015 | Bulk Capacitor Fail | Int.Error | // | E031 | Wrong V Measure |
| DC/DC Fail | // | E012 | DcDc Error revealed by inverter | Int.Error | // | E032 | Wrong I Measure |

| | | | | | | | |
|------------|----|------|--|-------------|------|------|--|
| Wrong Mode | // | E013 | Wrong Input setting (Single instead of dual) or wrong grounding mode | Empty Table | W009 | // | No wind table (only wind - W versions) |
| Inv. Fail | // | E016 | Inverter fail revealed by DcDc | Fan Fail | W010 | // | Fan Fail (No disconnection) |
| Int.Error | // | E017 | Start Timeout | Int.Error | // | E033 | UnderTemperature |
| Ground F. | // | E018 | I leak fail | | // | E034 | Interlock Fail (Not Used) |
| Int.Error | // | E019 | Ileak Sensor fail | | // | E035 | Remote Off |
| Int.Error | // | E020 | DcDc relay fail | | // | E036 | Vout Avg Error |
| Int.Error | // | E021 | Inverter relay fail | | W012 | // | Clock Battery Low (No disconnection) |
| | | | | | W013 | // | Clock Failure (No disconnection) |
| | | | | | | | |

Table 4:01 Messages and Error Codes

2.5 LCD DISPLAY

2.5.1 Connection of the System to the Grid

A two-line LCD display is located on the front panel. It shows the following:

- ✓ Inverter operating status and statistics;
- ✓ Service messages for the operator;
- ✓ Alarm and fault messages.

During regular operation, the display will cycle through available data. The display changes to a different screen every 5 seconds, or screens may be scrolled manually by pressing the UP (2nd key from display) and DOWN keys (3rd key from display).

A NOTE ON DISPLAY KEY OPERATION:

During regular operation, the display will cycle through available data. The display changes to a different screen every 5 seconds, or screens may be scrolled manually by pressing the UP (2nd key from display) and DOWN keys (3rd key from display). To return to the preceding menu, press the ESC key (1st key from display).

Activation of cyclical scrolling is indicated by the 2 arrows in the top left corner of the display (Figure. A).

Scrolling can be blocked by pressing the ENTER key (4th key from display). A padlock symbol will appear (Figure. A).

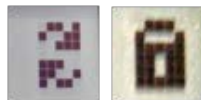
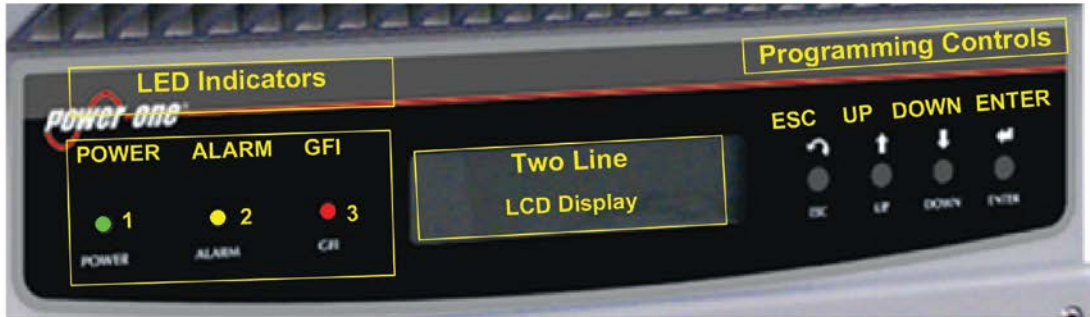

Figure A

Figure A- Display Key Operation



1) These two screens are displayed at inverter start-up:



2) The following screens may appear while waiting for the connection to be established:



- While the system checks for grid connection to be established ('Missing Grid'), the yellow LED next to the display turns on steady, while the green LED flashes.
- When waiting for solar radiation ('Waiting Sun'), the green LED turns on steady.
- As soon as the 'Missing Grid' and 'Waiting Sun' conditions are met successfully, the inverter is connected.

3) This display shows the time (seconds) remaining to complete the output voltage and frequency values check.



4) This display shows the instant output voltage value and whether it is within/outside range.

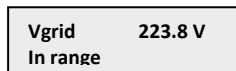

5) This displays the instant output frequency value and whether it is within/outside range.

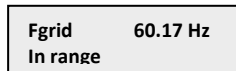

6) If the measured instant values of voltage (point 4) and frequency (point 5) are outside the allowed range, the following screens are scrolled alternately:

Next connections (screen 3) → Vgrid (screen 4) → Fgrid (screen 5)

2.5.1.1 Field Adjustments for Frequency and Disconnection Time

| | |
|-----------------|--|
| Warning: | Be fully aware of the field dynamics and how a frequency range change would impact the field. Improper values entered could cause the inverter to shut down. |
| | A warning will occur if an improper number is entered the Aurora Manager _TL |
| | Changes to the frequency range and timeout parameters MUST be done by a qualified contractor or authorized personnel. |

This inverter has been factory programmed to automatically disconnect from the utility distribution system at a default frequency setting of $f > 60.5\text{Hz}$ and $f < 59.3\text{Hz}$.

For the inverter to operate at the frequency condition and timeout parameters shown below, please follow steps 1 and 2.

Conditions:

| <u>Frequency Condition</u> | <u>Disconnect Time Interval</u> |
|----------------------------|---------------------------------|
| $f > 60.5\text{ Hz}$ | within 10 cycles (160ms) |
| $f = 57\text{ Hz}$ | within 300 seconds |
| $f < 57\text{ Hz}$ | within 10 cycles (160ms) |

Steps to follow:

1. Install the Aurora TL Manager onto a computer/laptop. This software is on the CD that accompanied this manual.
2. Change the frequency range and timeout parameters to the below values. See Figure 4:06a for screen capture example.

| Grid Parameters: | | | |
|----------------------------|------------------------------------|--|---|
| Required Setting | Symbol | Definition | Action |
| $f >$ to 60.5 Hz | $f >$ | Indicates the value of the maximum allowable over-frequency setpoint . For a UL1741/ IEEE1547 certified inverter the default value is 60.5Hz | Setting $f >$ to 60.5Hz causes grid disconnect within 160ms when line frequency rises above 60.5Hz |
| $f >>$ to 60.5 Hz | $f >>$ | Indicates absolute maximum allowable OF setpoint . | Setting $f >$ to 60.5Hz causes grid disconnect within 160ms when line frequency rises above 60.5Hz |
| $f <$ to 59.30 Hz | $f <$ | Indicates the value of the adjustable UF set-point . For line frequency below this value, a disconnect timer is set to count down the ride through time[Timeout $f <$] If the timer reaches full count the inverter will be disconnected from the grid. If the measured frequency rises above this value, the disconnect timer is reset. | This setting indicates the disconnect timer will initiate at 59.3Hz |
| $f <<$ to 57 Hz | $f <<$ | Indicates the absolute minimum allowable under-frequency condition allowable on a UL1741/IEEE1547 certified inverter | This setting will cause the inverter to disconnect from the grid anytime when line frequency falls below 57Hz |
| Timeout $f >$ to 160 ms | Timeout $f >$ | Indicates the timeout associated with an over-frequency condition ($f > 60.5\text{Hz}$) | This setting will cause the inverter to disconnect from the grid anytime when line frequency rises above 60.5Hz |
| Timeout $f <$ to 300000 ms | Timeout $f <$ | Indicates the value of the timeout associated with an under-frequency condition below the value of parameter $f <$ | The inverter will operate for up to 300000ms (5min) for an under-frequency below the $f <$ set-point as long as the frequency does not fall below |

| | | | |
|--|--|--|------------------|
| | | | the f<< setpoint |
|--|--|--|------------------|

Frequency range and timeout parameters

The parameters below are accessible from the software. These are default voltage settings and must not under any circumstances be modified.

| Grid Parameters: | | | |
|------------------|--------|--|----------------------|
| Required Setting | Symbol | Definition | Action |
| DEFAULT | U> | Indicates the value of the maximum allowable adjustable over-voltage set point | DO NOT CHANGE |
| DEFAULT | U>> | Indicates the value of the absolute maximum allowable over-voltage set point | DO NOT CHANGE |
| DEFAULT | U< | Indicates the value of the minimum allowable adjustable under-voltage set point | DO NOT CHANGE |
| DEFAULT | U<< | Indicates the value of the absolute minimum allowable under-voltage set point | DO NOT CHANGE |

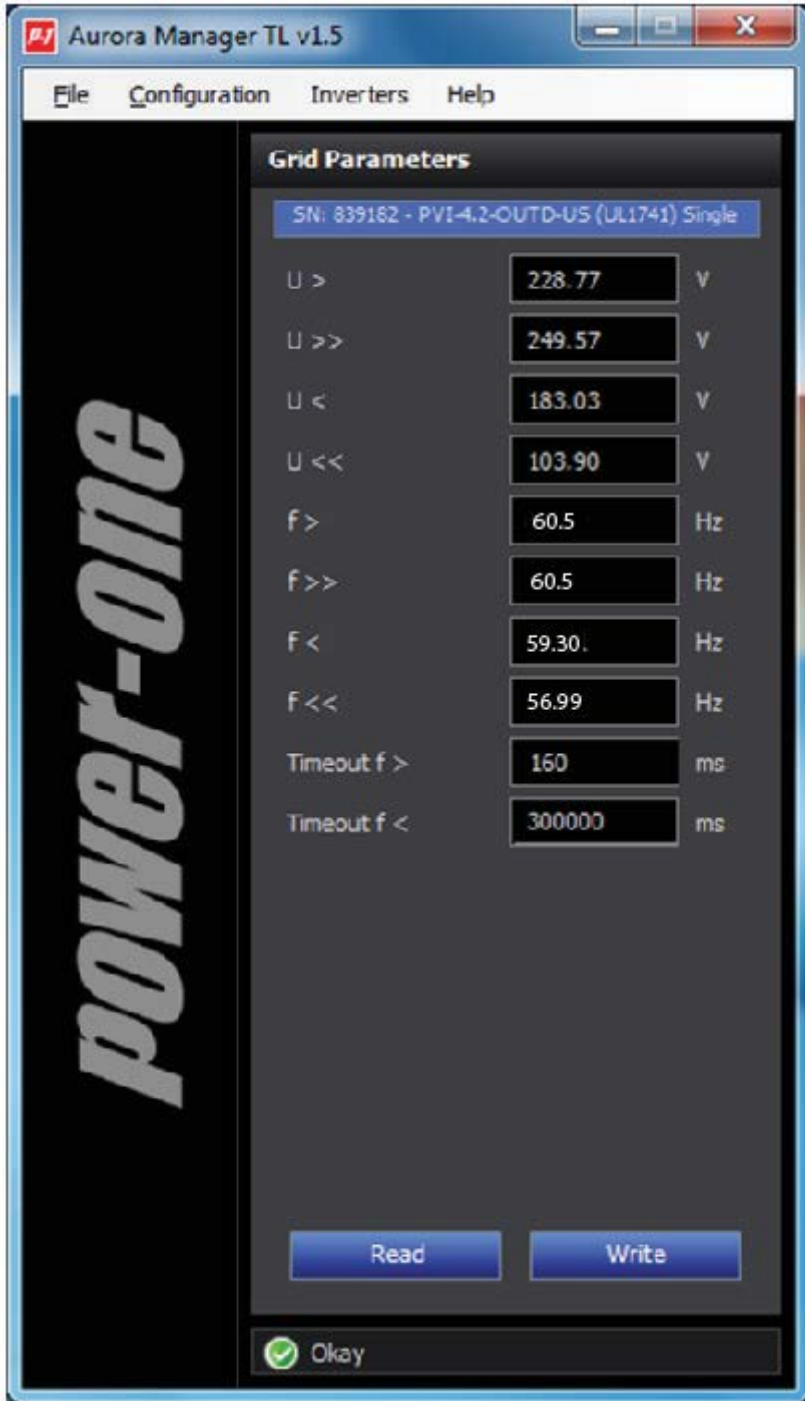

Figure 4:06a: Screen Capture of Aurora TL Manager with Changed Frequency and Timeout Values

Once the frequency range and timeout values have been changed:

- 1 Power down the unit (both AC and DC power) to save all changes.
- 2 Apply the appropriate label to the unit.

| | |
|-------|---|
| Note: | When the frequency and timeout is changed, completely power down the inverter turning OFF both AC and DC power in order to preserve the new data. |
|-------|---|

2.5.1.2 Apply Label:

If the inverter's frequency range is field adjusted to changed to disconnect in the under the conditions in Section 2.5.1.1.2, apply the following label to the external, side panel of inverter to indicate frequency change. See Figure 4:06b

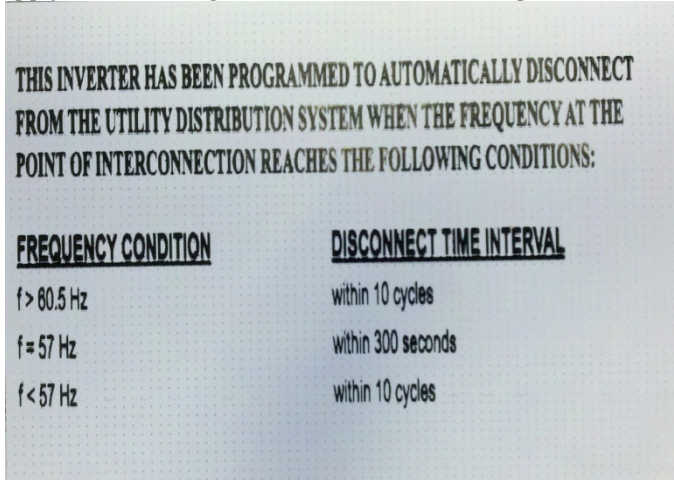

Figure 4.06b: Notification Label: Frequency Range and Timeout Parameter Change

| | |
|--------------|---|
| Note: | To comply with safety regulations, this label must be placed on the inverter immediately following the change to the frequency range. |
|--------------|---|

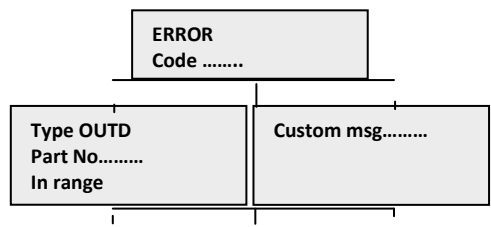

Figure 4:08: Location of Notification Label: Frequency Range Change

2.5.2 Error Messages

After the connection is established, the inverter runs a test cycle. If the wrong data is found, the cycle is interrupted and an error code is displayed. Please refer to Table 4:01 for error codes and their meanings.

To customize the message shown on the display, you must carry out the programming procedure described in Section 2.5.25, 'Alarm Message'. The system will continue to cycle through the following screens until the error has been rectified:



| |
|---------------|
| S/N |
| Firmware..... |
| In range |

Once the error is cleared, the inverter resets all functions in progress and re-starts the connection (Section 1.2):

- Missing grid
- Waiting sun

2.5.3 First Phase- Electric Parameter Check

1A) If the measurements taken previously (see section 2.1) are found to be correct, the system will proceed to the next checks. The 12 screens outlined below are shown alternately as listed in the Note A: 'A FEW POINTERS ON DISPLAY KEY OPERATION'.

| |
|-----------|
| Type OUTD |
| PN----- |

2A) This display shows the inverter serial number and firmware revision level.

| |
|-----------------|
| S/N----- xxxxxx |
| FW rel. C.0.1.1 |

3A)

| |
|---------------|
| E-da 0 Wh |
| \$-da 0.0 EUR |

- E-da: Daily energy output.
- \$-da: Daily energy savings. The value is expressed in the set currency.

4A)

| |
|-----------------|
| E-tot ----- |
| E-par 0 KWh EUR |

- E-tot: Total energy output (since first installation).
- E-par : Partial energy output during the period selected by us.

5A)

| |
|---------------|
| P-out 0 W |
| T-boost1 - °C |

P-out: Measures instant output power.

The second line of the display shows the higher of the two temperatures:

- T-boost1: Booster channel 1 switching device temperature.
- T-boost2: Booster channel 2 switching device temperature.

6A)

| |
|----------------|
| Ppk W |
| Ppk-DavW |

Ppk: Maximum peak power achieved since the 'partial' function was activated.

Ppk-Day: Indicates the maximum peak power achieved during the day. The counter will reset when unit is powered OFF
7A)

| | |
|-----------|-------|
| Vgrid | 197 V |
| Vgrid Avg | 0 V |

- Vgrid: Measures instant grid voltage
- Vgrid Avg: Average grid voltage calculated over the last 10 minutes of inverter operation

8A)

| | |
|-------|----------|
| Igrid | 0.8 A |
| Fgrid | 60.18 Hz |

- Igrid: Measures instant grid current
- Fgrid: Measures instant grid frequency

9A)

| | |
|-------|-------|
| Vin1 | 0 V |
| I in1 | 0.0 A |

- Vin1: Instant input voltage value measured at channel 1 input.
- Iin1: Instant input current value measured at channel 1 input.

10A)

| | |
|-------|-------|
| Vin2 | 0 V |
| I in2 | 0.0 A |

- Vin2: Instant input voltage value measured at channel 2 input.
- Iin2: Instant input current value measured at channel 2 input.

If the inverter configuration is set for single input (Parallel) mode, the following screen appears instead of the two screens previously described.

| | |
|------|-------|
| Vin | 0 V |
| I in | 0.0 A |

11A)

| | |
|-------|-----|
| Pin 1 | 0 W |
| Pin 2 | 0 W |

- Pin1: Measures instant input power of channel 1.
- Pin2: Measures instant input power of channel 2.

If the inverter configuration is set for single input (Parallel) mode, the following screen appears instead of the two screens previously described.

| | |
|-----|-----|
| Pin | 0 W |
|-----|-----|

12A)

Ileak 7 mA

- Ileak: Value of the leakage current passing through the grounding fuse and displayed only when the connected positive or negative terminal is being grounded.

Inverter OK
Wed 17 May 11 23

If all items described above tested OK, the inverter shows a corresponding message in the display top line along with the date and time. Clock malfunctioning or other non-function-related faults (meaning faults that do not affect the inverter's ability to generate energy) are shown in the second line of the display instead of the date and time.

The following error messages are provided:

- CLOCK FAILURE: Indicates clock malfunction; contact SunPower Technical Support.
- BATTERY LOW
- ADJ. TIME: Appears the first time the unit is powered up or after the battery has been replaced.
- FAN FAILURE: Does not affect the inverter's proper operation; replace the fan at the first convenient opportunity.
- MEMORY FAILURE: Data logging malfunction. Call SunPower Technical Support.

2.5.4 Main Menu

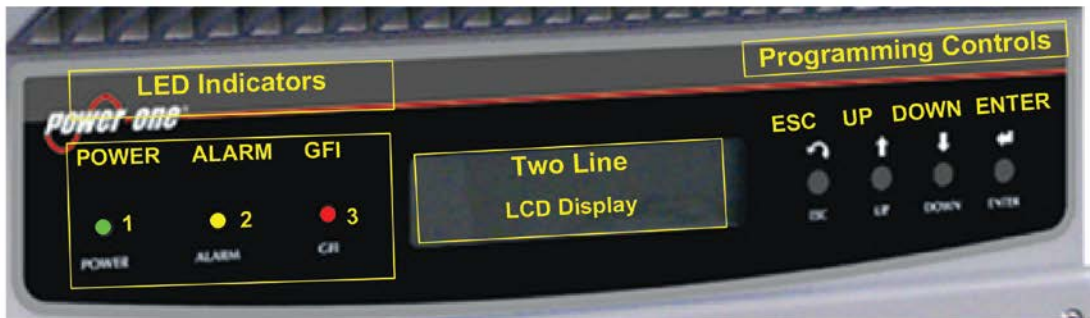

When the grid connection sequence and all electrical parameter checks are completed, other screens become available, which enable monitoring of the inverter's operation from different viewpoints.

Pressing the ESC key (1st key from display) gives access to three new screens:



A NOTE ON DISPLAY KEY OPERATION:

- Press the UP (2nd key from display) and DOWN keys (3rd key from display) to scroll through items.
- Press the ESC key (1st key from display) to go back to the previous session described in the highlighted area preceding section 0.
- Press ENTER (4th key from display) to open the selected submenu.

Note 4:01- Display Key Operation

2.5.5 Statistics

Select the STATISTICS menu to display the following sub-menu:

| |
|---------------|
| ⇐ Lifetime |
| Partial |
| Today |
| Last 7 days |
| Last Month |
| Last 30 Days |
| Last 365 Days |
| User period |

The display shows only two lines; use the keys at the side of the display to scroll through items or open the corresponding sub-menus as described in Note 4:01 above. An arrow on the left side of the display highlights the current selection as shown in the following screen shot:



2.5.6 Lifetime

Select **Lifetime** to view the following information:

| | |
|-------|-----|
| Time | h |
| E-tot | KWh |
| Val. | EUR |
| CO2 | kg |

- Time: Lifetime operation time
- E-tot: Total energy produced
- Val. : Economic gain
- CO₂: CO₂ saving compared to fossil fuels

2.5.7 Partial

Select **Partial** to view the following information:

| | |
|-------|-----|
| Time | h |
| E-par | KWh |
| Ppeak | W |
| Val. | EUR |
| CO2 | kg |

- Time: Total operation time since the counter was last reset. *
- E-par: Total energy produced since the counter was last reset. *
- PPeak: Maximum peak power measured since the 'partial' counter was activated
- Val. : Economic gain since the counter was last reset.*
- CO₂: CO₂ saving compared to fossil fuels since counter was last reset. *

* Hold the ENTER key (4th key from display) depressed for over 3 seconds to reset all counters in this submenu. After this time, a warning sound is repeated 3 times.

TODAY

Select **Today** to view the following information:

| | |
|-------|-----|
| E-tod | KWh |
| Ppeak | W |
| Val. | EUR |
| CO2 | kg |

- E-tod: Total energy produced during the day.
- Ppeak: Peak power value achieved during the day.
- Val. : Economic gain during the day.
- CO₂: CO₂ saving for the day compared to fossil fuels.

2.5.8 Last 7 days

Select **Last 7 Days** to view the following information:

| | |
|------|-----|
| E-7d | KWh |
| Val. | EUR |
| CO2 | kg |

- E-7d: Total energy output over the last 7 days.
- Val. : Economic gain over the last 7 days.
- CO₂: CO₂ saving over the last 7 days compared to fossil fuels.

2.5.9 Last Month

Select **Last Month** to view the following information:

| | |
|-------|-----|
| E-mon | KWh |
| Val. | EUR |
| CO2 | kg |

- E-mon: Total energy output this month.
- Val. : Economic gain this month.
- CO₂: CO₂ saving this month compared to fossil fuels.

LAST 30 DAYS

Select **Last 30 Days** to view the following information:

| | |
|-------|-----|
| E-30d | KWh |
| Val. | EUR |
| CO2 | kg |

- E-30d: Total energy output over the last 30 days.
- Val. : Economic gain over the last 30 days.
- CO₂: CO₂ saving over the last 30 days compared to fossil fuels.

2.5.10 Last 365 Days

Select **Last 365 Days** to view the following information:

| | |
|-------|-----|
| E-365 | KWh |
| Val. | EUR |
| CO2 | kg |

- E-365: Total energy output over the last 365 days.

- Val. : Economic gain over the last 365 days.
- CO2: CO2 saving over the last 365 days compared to fossil fuels.

2.5.11 User Period

Select **User Period** to view the energy saving during a period specified by the user:



- Press ENTER from the 'User period' screen to access the following sub-menu:



- Use the display keys to set the start and end date of the period as follows:
 - Use ENTER to move from one field to the next (from left to right).
 - Use ESC to go back to the previous field (from right to left).
 - Press ESC repeatedly to go back to the previous menus as described in section 2.5.3.
 - To set the day:
 - Press DOWN to scroll numbers backwards (from 31 to 1).
 - Press UP to scroll numbers forwards (from 1 to 31).
 - To set the month:
 - Press DOWN to scroll months from December to January.
 - Press UP to scroll months from January to December.

If the dates set are inconsistent, the screen below alerts the user to the problem:

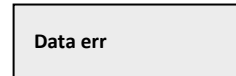

2.5.12 Settings

Select **SETTING** from the Main Menu and [ENTER] to display the **Password** screen, which enables the user to access the Settings Menu:



- To enter this menu, the correct four digit password must be entered.
 - At initial set up, enter the default password [0000] unless the default password has been modified by the user (per Note 4:01) in which case, enter the correct user password.
 - Follow instructions below to enter password digits into their proper location:
 - Use ENTER to move from one digit location to the next (from left to right).
 - Use ESC to go back to the previous figure (from right to left).
 - Press DOWN to scroll numbers backwards (from 9 to 0).
 - Press UP to scroll numbers forwards (from 0 to 9).
 - Press ESC repeatedly to go back to the previous menus as described in section 2.5.3
- After entering the required password, press ENTER to access to the **Settings Menu**:

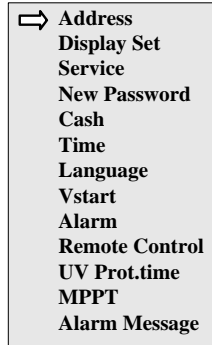

The front panel display has only two lines; therefore, the display keys must be used to scroll through the menu items and/or open the corresponding sub-menus (see Note 4:01). An arrow on left side of the display highlights the current selection. Once the chosen item is selected, press [ENTER] to access the desired sub-menu. The following section provides descriptions of each of the available sub-menus.

2.5.13 Address

Selecting this function enables the bus addresses (for the inverter connected to the RS485 communication bus) to be set to an appropriate value. Address values are assigned manually using any value in the range [2 to 64]. Press the UP and DOWN keys to scroll numbers.

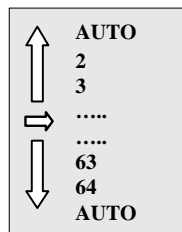

If desired, the RS485 address can be selected automatically by the system. This function is active when **AUTO** is selected from the address list.

NOTE: If wiring multiple units using a daisy chain configuration, do not select AUTO configuration.



2.5.14 Display Set

Selecting this function displays the following sub-menu enabling the user to set display features parameters:

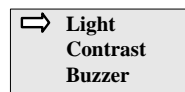

The following sections describe the available settings:

- **Light** - select this menu choice and [ENTER] to open the Display light sub-menu:

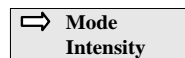

- Select **MODE** and [ENTER] to allow setting the display backlighting.

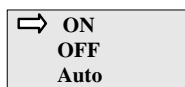

- **ON:** Light always ON.
- **OFF:** Light always OFF.
- **AUTO:** Automatic light setting - light turns ON every time a key is pressed and stays on for 30 seconds before fading OFF.
- Select **INTENSITY** and [ENTER] to allow adjustment of the backlighting intensity from 1 to 9.
- **Contrast:** Select this menu choice and [ENTER] to adjust display lighting contrast
 - Available display light tones go from 0 to 9.
 - Press UP and DOWN keys to scroll the numbers and then press ENTER to confirm the selection.
- **Buzzer:** Select this menu choice and [ENTER] to set key tone setting, choices are:
 - **ON:** The key tone is ON.
 - **OFF:** The key tone is OFF.

2.5.15 Service

This is a controlled access area of the operating system used by the factory to set certain control functions. Access is via an Advanced Password, which is a dedicated security code based on the unit serial number and access controlled by Power-One. Installers may need to access this menu for certain adjustments during the installation process, and Power-One will provide Advanced Password access to authorized installers to allow specific actions upon completion of required documentation.

2.5.16 New Password

Selecting this function allows changing the default password (0000) to a personal code.

To set a personal code, use the display keys as follows:

- Use ENTER to move from one digit to the next (from left to right).
- Use ESC to go back to the previous digit (from right to left).
- Press ESC repeatedly to go back to the previous menus as described in section 2.5.3.
- Press DOWN to scroll numbers backwards (from 9 to 0).
- Press UP to scroll numbers forwards (from 0 to 9).

2.5.17 Cash

Selecting this function enables the user to set the measurement units for earnings based on energy output.

| | |
|---------|-------|
| Name | EUR |
| Val/KWh | 00.50 |

- **Name:** Set desired currency, using the keys in the usual manner. The default currency is the Euro.
- **Val/KWh:** This indicates the cost of 1 kWh expressed in the currency set. The default setting is Euro 0.50.

2.5.18 Time

Selecting this function allows adjustment of the system time and date settings.

| | |
|------|-------------|
| Time | 14:21 |
| Date | 17 May 2006 |

2.5.19 Language

Selecting this function allows setting of the language desired for system prompts. Choices are Italian or English (default).

| |
|-----------|
| ⇒ English |
| Italiano |

2.5.20 Start-Up Voltage

Selecting this function enables modification of the start-up voltage associated with each of the input channels to match requirements of the connected PV array. The voltage can be set over the range [120V to 350V]. The default setting for AURORA Inverter is 200V. Use the display keys to change the value of this parameter.



2.5.21 Alarm

Selecting this function accesses the inverter's alarm function, which is used for external controls or, for example, to activate a visual and/or audible alarm. The function has two different modes of operation. Select the desired mode using the up/down arrow keys and press [ENTER] to open the relevant sub-menu:

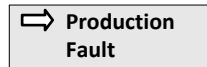

The function controls a set of dry relay contacts, which can be wired by the user as either normally open (N.O.) or normally closed (N.C.); contacts are rated at 250V/1A. The terminals for this function are accessed via the front panel as shown in Figure 4:05.

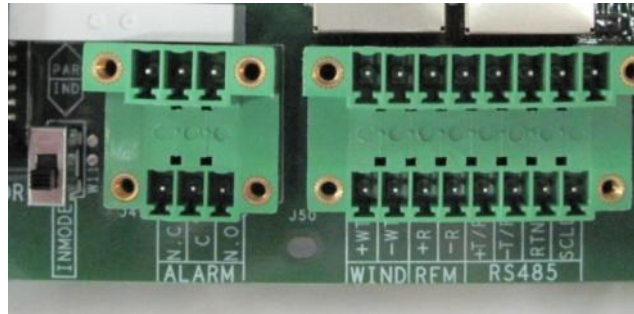

Figure4:08: Alarm contact terminal block

The two operational modes are described below:

- **PRODUCTION:** In this mode, the relay is activated only when the inverter is connected to the grid.
For example, if the N.O.(Normally Open)contact is chosen, the contact will remain open (closed) as long as the inverter is not connected to the grid. Once grid connection occurs and the inverter begins to export power, the relay switches its status and closes (opens). Upon disconnection from the grid, the relay contact returns to its rest position, i.e. open (closed).
- **FAULT:** In this mode, the alarm relay triggers when the system logs a fault condition, based on the error codes (E-code) described in Section 2.4
For example, if the N.O. (Normally Open) contact is chosen, the contact will remain open (closed) as long as no E-code fault is logged (E-code faults disconnect the inverter from the grid). When any E-code is logged, the relay will change state and stay latched until the next successful grid reconnection, at which time it is reset.
NOTE: the alarm function does not switch when warning codes (W-code) are logged.

2.5.22 Remote Control

Selecting this function accesses the remote ON/OFF function used to disable the inverter operation by an external switch or an external controller. Set as follows:

- **DISABLE:** Disables the ON/OFF function, so that inverter operation will operate normally, depending only on grid access and external solar radiation. (default).

• ENABLE - Activates the ON/OFF function, requiring an external contact closure to activate the inverter. Hardware access to the ON/OFF function is via terminals +R and -R, shown in Figure 4:08. When the function is active,

- Turn ON the inverter terminals by shorting terminals +R and -R.
- Turn OFF the inverter by removing the short between terminals +R and -R.

With the function enabled, the ON/OFF input status is indicated on the inverter display.



When set to OFF, the display will cycle through the following screens:



2.5.23 UV Protection Time (PROT. TIME)

Selecting this function allows setting of the inverter connection time after the input voltage drops below the under voltage limit, set at 90V.

For example: If UV Prot.time is set at 60 seconds, and Vin voltage drops below 90V, the inverter stays connected to the grid (at 0 power) for up to 60 seconds afterwards.

The default value is 60 seconds, but can be set over the range of [1 s to 3,600 s].

2.5.24 MPPT

Selecting this function enables setting parameters associated with the Maximum Power Point Tracker (MPPT) function. Following sections provide details of these settings:

- MPPT Amplitude: Set this parameter to choose the amplitude of the disturbance introduced in DC used by the MPPT circuit to establish the optimal work point. There are 3 options (LOW, MEDIUM, HIGH). The default setting is LOW.

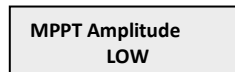

- MPPT Scan - the periodic scan of the MPPT circuit to detect if the system is on its maximum-power point can be enabled (default) or disabled.

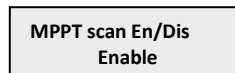

- Scan Interval - allows setting of the time interval between scans when system searches for real maximum power point. The default setting is 15 minutes.

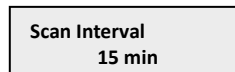

2.5.25 Alarm Message

Selecting this function allows access to the procedure to program the message shown on the display in the event of a logged error code:



After selecting the function, press [ENTER] to open the associated sub-menu.

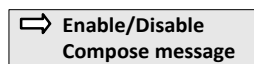

Select the desired function using display buttons to scroll between the options; once the desired option is selected, press [ENTER] to enter the sub-menu.

- ENABLE/DISABLE - the following screen will appear in the menu and the alarm message can either be disabled or enabled (default):

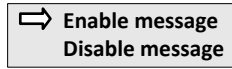

- With the ENABLE MESSAGE line is selected, press [ENTER] to open the sub-menu below.



- Select COMPOSE MESSAGE to access the field for the first line of a custom the message, where up to 16 characters may be entered:

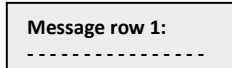

After entering the desired message, continue pressing [ENTER] until the field for the second line appears, where up to 16 characters may be entered:

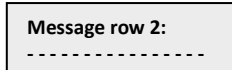

- To write the message always use the display keys in the following way:
 - Use ENTER (4th key) to move from one figure to the next (from left to right).
 - Use ESC (1st key) to go back to the previous position (from right to left).
 - Press ESC repeatedly to go back to the previous menus as described in section 2.5.3.
 - Use UP (2nd key) to scroll upwards through the numbers, letters and symbols.
 - Use DOWN (3rd key) to scroll downwards through the numbers, letters and symbols.

2.5.25 Set Vgrid

Selecting this function allows access to a sub-menu which allows setting the nominal grid voltage and grid type to which the inverter is to be connected:

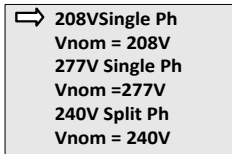

To choose a single phase 208V grid connection, move the cursor to the **208V Single Ph** line and press the [ENTER] button to open the following sub-menu:

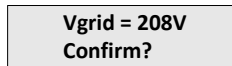

Press the [ENTER] key to confirm.

Similarly, to choose one of the other preset grid voltage/type combinations, move the cursor to the associated row and repeat the steps above.

2.6 Information

Selecting this menu allows display all AURORA Inverter data, the chosen language, and enables reading and/or modification of the grid standard by means of the special selector switches.

- Part No. (part number)

- Serial No. – Wk – Yr (serial number, week, year)
- Fw rel (firmware revision level)

3.0 DATA CHECK AND COMMUNICATION

The AURORA Inverters have remote monitoring and capabilities which are accessed externally using an RS485 communication port. The AURORA Inverter is provisioned with the communication capability as a standard feature, and all that is needed for remote monitoring is monitoring hardware which connects to the RS485 port and collects the available data. Following sections detail the wiring connections necessary to implement the RS485 bus. See Part 3 for specific wiring directions.

PART 5: TROUBLESHOOTING

5: 1.0 TROUBLESHOOTING

AURORA UNO Inverters comply with the standards set for grid-tied operation, safety, and electromagnetic compatibility.

Before the product is dispatched various tests are carried out successfully to ensure: functioning, protection devices, performance and durability.

Such tests, together with the Power-One quality assurance system, support optimal operation of the AURORA Inverter.

In case of any possible malfunction of the inverter, solve problems as follows:

- Work under safe conditions. Check that the connections between AURORA, photovoltaic field and power distribution network have been made correctly as stated in Part 1 Introduction & Safety and Part 3 Wall Mount & Wire Configuration.
- Carefully observe which LED is flashing and read the signal appearing on the display; then try to identify the type of fault found by following the instructions given in the Sections below.

1.2 LED INDICATORS

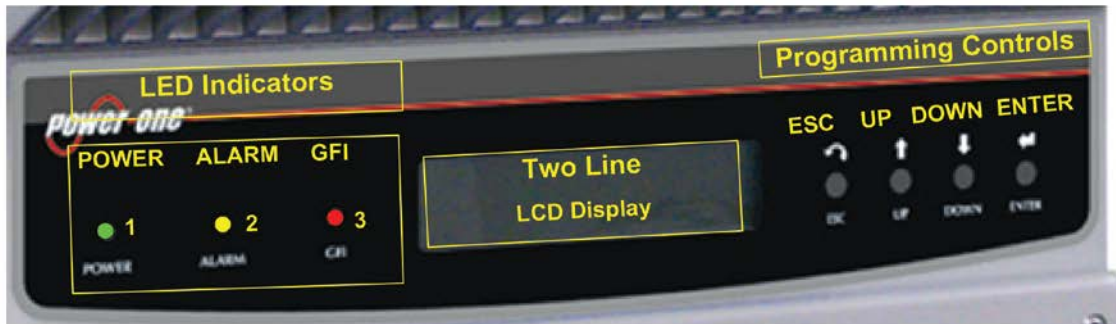

Figure 5:01- Location of the buttons and LEDs

There are three LEDs on the left side of the display:

4. The green 'Power' LED indicates that AURORA Inverter is operating correctly.

This LED flashes upon start-up, during the grid check routine. If a correct grid voltage is detected and solar radiation is strong enough to start-up the unit, the LED stays on steady. If not, the LED keeps flashing until solar radiation becomes strong enough to start-up the inverter. In this condition, the display will read **'Waiting Sun....'**

5. The yellow 'FAULT' LED indicates that the AURORA Inverter has detected a fault condition. A fault description will appear on the display.
6. The red 'GFI' (ground fault) LED indicates that AURORA Inverter is detecting a ground fault in the DC side of the photovoltaic system. When this kind of fault is detected, the AURORA Inverter disconnects from the grid and the corresponding fault indication appears on the LCD display. AURORA Inverter remains in this condition until the operator presses the ESC key to re-start the grid connection sequence. If pressing the ESC key doesn't clear the ground fault check the ground-fault, fuse located in the switchbox. If AURORA Inverter does not reconnect to the grid, see Section 1.6: The Power-One Service Call.
7. The following table shows all the possible LED-signalling indications related to the operational status of AURORA Inverter.

Key:

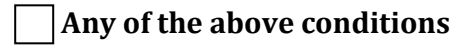
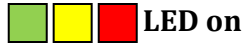

| | LED STATUS | OPERATIONAL STATUS | NOTES |
|---|--|--|--|
| 1 | 1: green: <input checked="" type="checkbox"/> 2: yellow: <input checked="" type="checkbox"/> 3: red: <input checked="" type="checkbox"/> | AURORA self-disconnects during night-time | Input voltage less than 90 Vdc at both inputs |
| 2 | 1: green: <input checked="" type="checkbox"/> 2: yellow: <input checked="" type="checkbox"/> 3: red: <input checked="" type="checkbox"/> | AURORA Inverter initialization, settings loading, and waiting for grid check | It is in transition status while operating conditions are being checked. |
| 3 | 1: green: <input type="checkbox"/> 2: yellow: <input checked="" type="checkbox"/> 3: red: <input checked="" type="checkbox"/> | AURORA Inverter is powering the grid | Standard machine operation (search for maximum power point or constant voltage) |
| 4 | 1: green: <input type="checkbox"/> 2: yellow: <input type="checkbox"/> 3: red: <input type="checkbox"/> | System insulation device faulty | Leakage to ground found |
| 5 | 1: green: <input checked="" type="checkbox"/> 2: yellow: <input type="checkbox"/> 3: red: <input checked="" type="checkbox"/> | Defect – fault!!! | The fault can be inside or outside the inverter. See the alarm appearing on the LCD display. |
| 6 | 1: green: <input checked="" type="checkbox"/> 2: yellow: <input checked="" type="checkbox"/> 3: red: <input checked="" type="checkbox"/> | Installation Phase: AURORA Inverter is disconnected from the grid. | During installation, it indicates set-up phase of the address for RS-485 communication. |
| 7 | 1: green: <input checked="" type="checkbox"/> 2: yellow: <input type="checkbox"/> 3: red: <input checked="" type="checkbox"/> | Grid disconnection | Indicates a missing grid condition |



NOTE: Inverter status is indicated by the corresponding LED turning to a steady ON-condition or flashing, and by a message on the AURORA LCD displaying a description of the existing operation or fault condition (see the following sections).

1.3 MESSAGES and ERROR CODES

| | |
|---|---|
|  DANGER: | <p>Normally grounded conductors may be ungrounded and energized when a ground-fault is indicated.</p> <ul style="list-style-type: none"> • Risk of electric shock • Test before touching • Work on the AURORA UNO inverter must be carried out by qualified personnel. |
|---|---|

The system status is identified through message or error signals displayed on the LCD display. The following tables briefly describe the two types of signals which may be displayed.

Messages identify the current status of the Aurora inverter. Messages do not relate to a fault. When a **(W)** with a number after it appears in the display, it indicates a **Warning Code** and is usually cleared through an orderly shutdown/re-set or a self corrective action performed by the inverter. See the (W) codes in the following table.

Alarms or **(E)** codes identify a possible equipment failure, fault or incorrect inverter setting or configuration. However, some of the (E) codes may require you to contact Power-One Technical Support to assist in correcting a fault. Any and all attempts to correct or clear a fault must be performed by qualified personnel. Typically, the (E) code can be cleared once the cause or fault is removed. Some of the (E) codes, **(Int. Error)** as indicated in the table below, may indicate a fatal error and require you to contact Power-One technical support for diagnostics and / or a product replacement.

| Message | Error Warning | Error Type | Description | Message | Error Warning | Error Type | Description |
|-----------|---------------|------------|--|-----------|---------------|------------|----------------------|
| Sun Low | W001 | // | -Input Voltage under Vstart threshold -Sun too low -PV Array strings may be configured incorrectly. - A factory default setting of 200VDC Min is required to start the Aurora inverter. | Int.Error | // | E022 | Autotest Timeout |
| Input OC | // | E001 | -Input Overcurrent -PV Array strings may be configured incorrectly. -Similar to W001 after MIN VDC start has been adjusted | Int.Error | // | E023 | Dc-Injection Error |
| Input UV | W002 | // | Input Undervoltage Similar to W001 after MIN VDC start has been adjusted. | Grid OV | W004 | // | Output Overvoltage |
| Input OV | // | E002 | Input Overvoltage | Grid UV | W005 | // | Output Undervoltage |
| Int.Error | // | E003 | No parameters | Grid OF | W006 | // | Output Overfrequency |

| | | | | | | | |
|---------------|------|------|---|----------------|------|------|--|
| Bulk OV | // | E004 | -Bulk Overvoltage -Contact Power-One Technical Support | Grid UF | W007 | // | Output Underfrequency |
| Int.Error | // | E005 | Communication Error | Z Grid HI | W008 | // | Z grid out of range |
| Out OC | // | E006 | -Output Overcurrent | Int.Error | // | E024 | Unknown Error - |
| Int. Error | // | E007 | -IGBT Sat -Contact Power-One Technical Support- possible. | ----- | // | E025 | Riso Low (Log Only) |
| Sun Low | W011 | // | Bulk Undervoltage | Int.Error | // | E026 | Vref Error |
| Int.Error | // | E009 | -Internal Error -Conduct inverter Re-Set* -Call Power-One Technical support if error isn't cleared. | Int.Error | // | E027 | Vgrid Measures Fault |
| Grid Fail | W003 | // | Grid Fail | Int.Error | // | E028 | Fgrid Measures Fault |
| Int.Error | // | E010 | -Bulk Low -Conduct inverter reset * - if error doesn't clear, contact Power-One Technical Support | Int.Error | // | E029 | Zgrid Measures Fault |
| Int.Error | // | E011 | Ramp Fail | | | | |
| Over Temp. | // | E014 | Overtemperature | Int.Error | // | E030 | Ileak Measures Fault |
| Cap. Fault | // | E015 | Bulk Capacitor Failure Call Power-One Technical Support. | Int.Error | // | E031 | Wrong V Measure |
| DC/DC Fail | // | E012 | DcDc Error revealed by inverter | Int.Error | // | E032 | Wrong I Measure |
| Wrong Mode | // | E013 | -Wrong Input setting (Single instead of dual) or wrong grounding mode -Wrong DC array input (verify PAR/IND MPPT switch is correct. Conduct inverter reset*. If error isn't cleared call Power- One Technical Support. | Empty Table | W009 | // | No wind table (only wind -W versions) |
| Inv. Fail | // | E016 | Inverter fail revealed by DcDc | Fan Fail | W010 | // | Fan Fail (No disconnection) |
| Int.Error | // | E017 | -Start Timeout -Conduct inverter reset* -If error doesn't clear contact Power- One Technical Support. | Int.Error | // | E033 | UnderTemperature |
| Ground F. | // | E018 | - I leak fail - Ground-fault is present. Inspect field wiring-verify there are no pinched wires or damaged wire | | // | E034 | Interlock Fail (Not Used) |

| | | | | | | | |
|-----------|----|------|---|--|------|------|--------------------------------------|
| | | | insulation-conduct inverter reset*-contact Power-One Technical Support. | | | | |
| Int.Error | // | E019 | Ileak Sensor fail | | // | E035 | Remote Off |
| Int.Error | // | E020 | DcDc relay fail | | // | E036 | Vout Avg Error |
| Int.Error | // | E021 | Inverter relay fail | | W012 | // | Clock Battery Low (No disconnection) |
| | | | | | W013 | // | Clock Failure (No disconnection) |

*To conduct the inverter reset, turn the AC and the DC OFF. Turn DC ON and wait for sun. Turn AC ON.

Table 5:01 Messages and Error Codes

1.4 LCD DISPLAY

1.4.1 Connection of the System to the Grid

A two-line LCD display is located on the front panel shows the following:

- ✓ Inverter operating status and statistics;
- ✓ Service messages for the operator;
- ✓ Alarm and fault messages.

During regular operation, the display will cycle through available data. The display changes to a different screen every 5 seconds, or screens may be scrolled manually by pressing the UP (2nd key from display) and DOWN keys (3rd key from display).

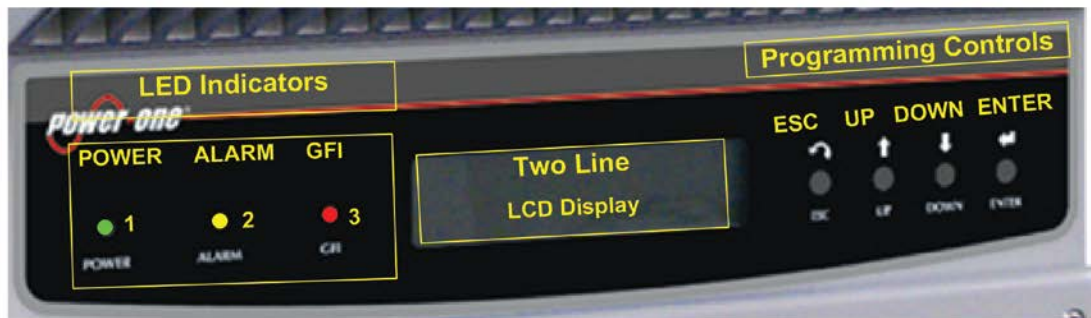

1) These two screens are displayed at inverter start-up:



6) The following screens may appear while waiting for the connection to be established:



- While the system checks for grid connection to be established ('Missing Grid'), the yellow LED next to the display turns on steady, while the green LED flashes.
- When waiting for solar radiation ('Waiting Sun'), the green LED turns on steady.
- As soon as the 'Missing Grid' and 'Waiting Sun' conditions are met successfully, the inverter is connected.

7) This display shows the time (seconds) remaining to complete the output voltage and frequency values check.

| |
|------------------------------------|
| Next connections: 2 secs |
|------------------------------------|

4) This display shows the instant output voltage value and whether it is within/outside range.

| |
|---|
| Vgrid 223.8 V In range |
|---|

5) This displays the instant output frequency value and whether it is within/outside range.

| |
|--|
| Fgrid 60.17 Hz In range |
|--|

6) If the measured instant values of voltage (point 4) and frequency (point 5) are outside the allowed range, the following screens are scrolled alternately:

Next connections (screen 3) → Vgrid (screen 4) → Fgrid (screen 5)

1.5 PHASE ONE - ELECTRIC PARAMETER CHECK

Clock malfunctioning or other non- function-related faults (meaning faults that do not affect the inverter's ability to generate energy) are shown in the second line of the display instead of the date and time.

The following error messages are provided:

- **CLOCK FAILURE:** Indicates clock malfunction; contact Power-One Customer Service
- **BATTERY LOW**
- **ADJ. TIME:** Appears the first time the unit is powered up or after the battery has been replaced.
- **FAN FAILURE:** Does not affect the inverter's proper operation; replace the fan at the first convenient opportunity.
- **MEMORY FAILURE:** Data logging malfunction. Call Power-One Customer Service.

If the malfunction cannot be cleared by following these instructions, contact the service center or the installer (see Section 1.6 below). Before contacting Power-One Technical Support, please make the following information available in order to maximize the effectiveness of the intervention:

1.6 THE POWER ONE SERVICE CALL

INFORMATION ON AURORA UNO INVERTER

- ✓ AURORA model?
- ✓ Serial number?
- ✓ Week of production?
- ✓ Which LED is flashing?
- ✓ Steady or flashing light?
- ✓ What signals are shown on the display?

NOTE: above information available directly from the LCD display

Additional helpful information when troubleshooting with the Power-One Technical Service Engineers:

- Provide a brief description of the fault.
- Information on the Photovoltaic Field
- Brand and model of photovoltaic panels
- Identify the System structure:
 - Maximum array voltage and current values
 - Number of strings in the array
 - Number of panels for each string
 - Can the fault be reproduced? If so, how?
 - Is the fault cyclical in nature? If so, how often?
 - Was the fault apparent at the time of installation?
 - If so, has it got worse?
 - Describe the atmospheric conditions at the time the fault appears/appeared.

Power-One Technical Support

Phone: 1-877-261-1374

PART 6: MAINTENANCE GUIDE

6: 1.0 MAINTENANCE

The AURORA UNO Inverter has no user-serviceable parts. Maintenance and service procedures must comply with the manufacturer's documentation. Call Power-One Technical Support at 1-877-261-1374 or a list of qualified service contractors.

1.1 SHUT-DOWN PROCEDURE

There are three options for shutting down the inverter:

- 4) Disconnect the DC and the AC grid, by disconnecting its associated switches (in any order). The inverter will shut down within a few seconds necessary to discharge the internal capacitors.
- 5) Disconnect the DC input by turning-off the associated disconnect switch and waiting for the UV port time out.
- 6) Disconnect the grid, by turning-off its associated disconnect switch and reduce DC input to less than 130 Vdc.

1.2 POWER-DOWN PROCEDURES

Once the inverter is wired and connected to the grid use the following procedures to disconnect for maintenance

| | |
|---|--|
|  WARNING | Before performing any operation on the switchbox power input, ALWAYS perform the appropriate disconnection procedure outlined below. |
|---|--|

1.2.1 Disconnection Of AURORA UNO Inverter



Figure 6:01- Location of Front Access Panels

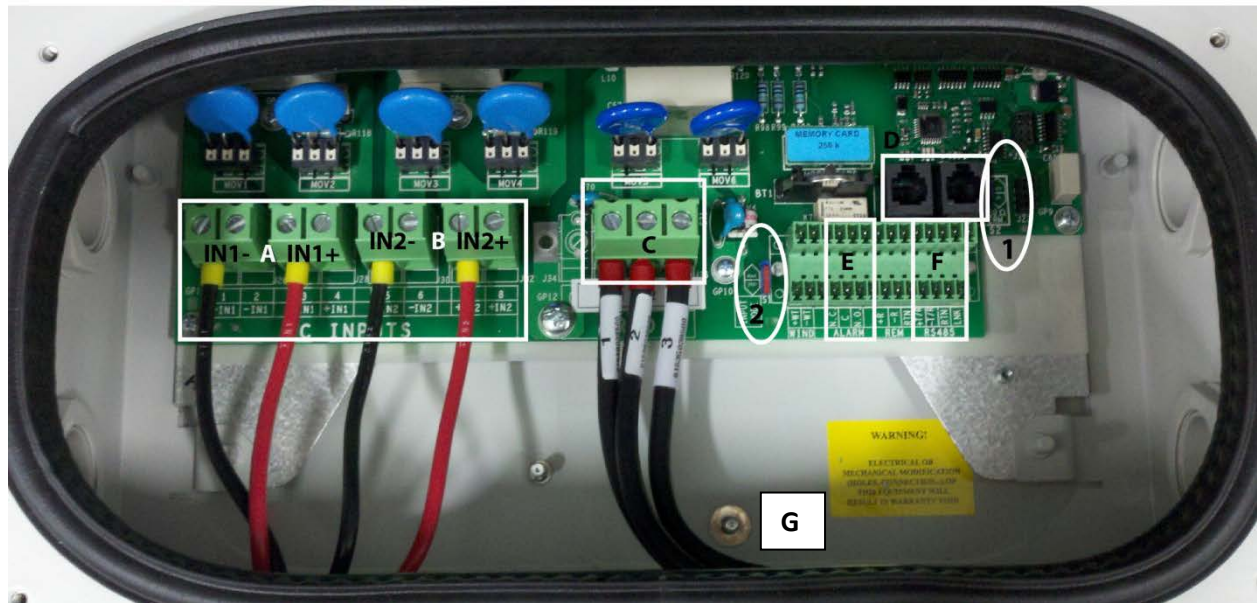

| Location Indicator | Details | | Location Indicator | Details | |
|---|--|---------------------|--------------------|--|---|
| A | DC Array: MPPT 1 input | Note 1 below | F | RS485 Bus Connection Via Screw Terminals | Note 3 below |
| B | DC Array: MPPT2 input | Note 1 below | G | Frame Ground  | Chassis mount Threaded stud |
| C | AC Connection Terminal | Note 1 below | 1 | RS485 Termination Switch | See Signal Connection Section for more detail |
| D | RS485 Bus Connection Via RJ485 Connector | Use with CAT5 Cable | 2 | MPPT Input Selector Switch | Choose PAR or IND MPPT Operation |
| E | Alarm Out Terminals for External Alarm | Note 3 below | | | |
| | | | | | |
| | | | | | |
| <p>Notes: 1. Terminals accept wire range up to #6AWG (Refer to local code for appropriate wire size); torque to 13in-lb. 2. Terminals accept wire range up to #6AWG (Refer to local code for appropriate wire size); torque to 13in-lb. 3. Mating terminals in hardware kit. Terminals accept wire size range up to #4AWG; torque to 13 in-lb.</p> | | | | | |

Figure 6:02 PVI-3.0/3.6/4.2/OUTD-S-US Wiring Connection Details

1.4 CR2032 LITHIUM BATTERY REPLACEMENT



WARNING

- Before performing any operation on the switchbox power input or on the inverter, ALWAYS perform the disconnection procedure as explained in Part 4: Operations of this manual.
- The replacement of this battery should be performed only by trained personnel.

Inside the AURORA UNO Inverter there is a CR2032 lithium battery. When this battery is at end-of-life, a message will be shown in the display informing that the battery needs to be replaced.

The battery is visible after removing the AURORA PV Inverter's front panel. Refer Figure 6.01 above for the procedure to remove the front panel.

To insert the new battery into its holder, slide the battery at a 30° angle pushing it into insertion as shown in Figure 6:04 below. When pushed on into insertion it should seat into the correct position within the holder.

After battery replacement is completed, re-install and secure the front panel of the inverter and perform the START-UP procedure in Part 4: Operations.

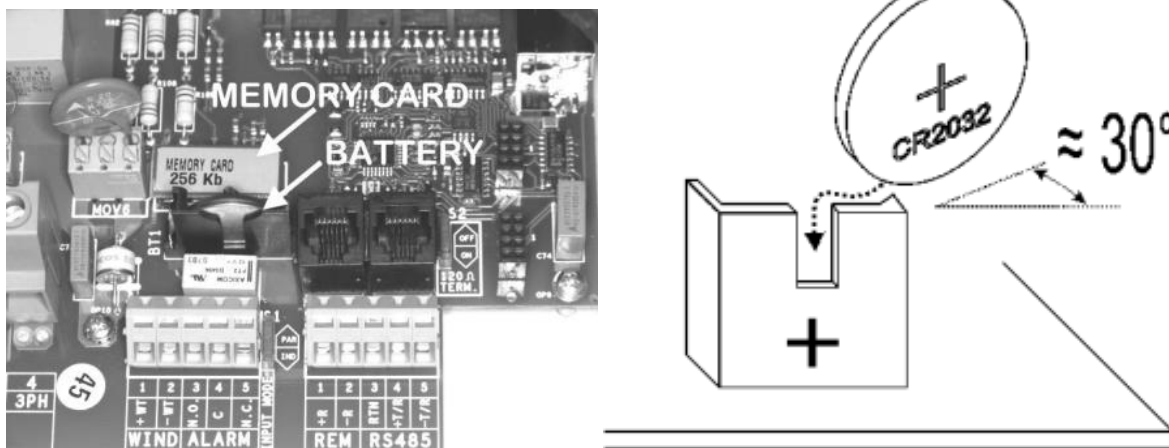

Figure 6:04 Lithium Battery Replacement

1.0 DATA SHEETS

| Technical Data | Values | PVI-3.0-OUTD-US | | | PVI-3.6-OUTD-US | | | PVI-4.2-OUTD-US | | |
|--|--------|--|--|--|--|--|--|--|--|--|
| Rated Grid AC Voltage | V | 208 | 240 | 277 | 208 | 240 | 277 | 208 | 240 | 277 |
| Input Side (DC) | | | | | | | | | | |
| Maximum Usable Power for Each Channel | W | 2000 | 2000 | 2000 | 3000 | 3000 | 3000 | 3000 | 3000 | 3000 |
| MPPT Voltage Range | V | 160-530 | 160-530 | 160-530 | 120-530 | 120-530 | 120-530 | 140-530 | 140-530 | 140-530 |
| Start- Up Voltage | V | 200 (adj. 120-350) | 200 (adj. 120-350) | 200 (adj. 120-350) | 200 (adj. 120-350) | 200 (adj. 120-350) | 200 (adj. 120-350) | 200 (adj. 120-350) | 200 (adj. 120-350) | 200 (adj. 120-350) |
| Absolute Maximum Voltage (Vmax) | V | 600 | 600 | 600 | 600 | 600 | 600 | 600 | 600 | 600 |
| Maximum Current (Idcmax) for both MPPT in Parallel | A | 20 | 20 | 20 | 32 | 32 | 32 | 32 | 32 | 32 |
| Maximum Usable Current per Channel | A | 10 | 10 | 10 | 16 | 16 | 16 | 16 | 16 | 16 |
| Number of Wire Landing Terminals per Channel | | 2 (1 on - S Vers ion) | 2 (1 on - S Vers ion) | 2 (1 on - S Vers ion) | 2 (1 on - S Vers ion) | 2 (1 on - S Vers ion) | 2 (1 on - S Vers ion) | 2 (1 on - S Vers ion) | 2 (1 on - S Vers ion) | 2 (1 on - S Vers ion) |
| Number of Independent MPPT Channels | | 2 | 2 | 2 | 2 | 2 | 2 | 2 | 2 | 2 |
| Array Wiring Termination | | Screw terminal block 3 Knock-Outs : 1 ½" | Screw terminal block 3 Knock-Outs : 1 ½" | Screw terminal block 3 Knock-Outs : 1 ½" | Screw terminal block 3 Knock-Outs : 1 ½" | Screw terminal block 3 Knock-Outs : 1 ½" | Screw terminal block 3 Knock-Outs : 1 ½" | Screw terminal block 3 Knock-Outs : 1 ½" | Screw terminal block 3 Knock-Outs : 1 ½" | Screw terminal block 3 Knock-Outs : 1 ½" |

| | | or 1" (w/ Ring Red ucer) | or 1" (w/ Ring Red ucer) | or 1" (w/ Ring Red ucer) | or 1" (w/ Ring Red ucer) | or 1" (w/ Ring Red ucer) | or 1" (w/ Ring Red ucer) | or 1" (w/ Ring Red ucer) | or 1" (w/ Ring Red ucer) | or 1" (w/ Ring Red ucer) |
|---|--|---|---|---|---|---|---|---|---|---|
| Output Side (AC) | | | | | | | | | | |
| Grid Standard | | 1Ø/ 2W or Split- Ø/3 W | 1Ø/ 2W or Split- Ø/3 W | 1Ø/ 2W or Split- Ø/3 W | 1Ø/ 2W or Split- Ø/3 W | 1Ø/ 2W or Split- Ø/3 W | 1Ø/ 2W or Split- Ø/3 W | 1Ø/ 2W or Split- Ø/3 W | 1Ø/ 2W or Split- Ø/3 W | 1Ø/ 2W or Split- Ø/3 W |
| Nominal Power | W | 300 0 | 300 0 | 300 0 | 360 0 | 360 0 | 360 0 | 420 0 | 420 0 | 420 0 |
| Voltage Range (Vmin-Vmax) | V | 183- 228 | 211- 264 | 244- 304 | 183- 228 | 211- 264 | 244- 304 | 183- 228 | 211- 264 | 244- 304 |
| Grid Frequency; Range** | H Z | 60;(59.3 - 60.5) | 60;(59.3 - 60.5) | 60;(59.3 - 60.5) | 60;(59.3 - 60.5) | 60;(59.3 - 60.5) | 60;(59.3 - 60.5) | 60;(59.3 - 60.5) | 60;(59.3 - 60.5) | 60;(59.3 - 60.5) |
| Maximum Current (Iac, max) | A _{RMS} | 14.5 | 14.5 | 12 | 17.2 | 16 | 16 | 20 | 20 | 20 |
| Power Factor | | > 0.99 5 | > 0.99 5 | > 0.99 5 | > 0.99 5 | > 0.99 5 | > 0.99 5 | > 0.99 5 | > 0.99 5 | > 0.99 5 |
| Total Harmonic Distortion At Rated Power | % | < 2 | < 2 | < 2 | < 2 | < 2 | < 2 | < 2 | < 2 | < 2 |
| Contributory Fault Current *** | A _P k/ A _{RMS} | 162 /11. 7 | 139. 7/1 0.6 | 92.2 /8.6 | 93.9 /12. 2 | 136. 5/1 2.5 | 164. 6/1 1.3 | 122. 4/1 3.5 | 164. 4/1 4.7 | 165. 9/1 2.3 |
| Efficiency | | | | | | | | | | |
| Maximum Efficiency | % | 96.9 | 96.9 | 96.9 | 97 | 97 | 97 | 97 | 97 | 97 |
| CEC Efficiency | % | 96 | 96 | 96 | 96 | 96 | 96 | 96 | 96 | 96 |
| Operating Parameters | | 208 | 240 | 277 | 208 | 240 | 277 | 208 | 240 | 277 |
| Consumption in Stand By (Night) | W _{RMS} | < 8.0 | < 8.0 | < 8.0 | < 8.0 | < 8.0 | < 8.0 | < 8.0 | < 8.0 | < 8.0 |
| Consumption During Operation | W _{RMS} | 20 | 20 | 20 | 20 | 20 | 20 | 20 | 20 | 20 |

| Topology | Transformerless | Transformerless | Transformerless | Transformerless | Transformerless | Transformerless | Transformerless | Transformerless | Transformerless | Transformerless |
|-------------------------------------|--|--|--|--|--|--|--|--|--|--|
| Mechanical Specifications | | | | | | | | | | |
| Enclosure rating | NEMA 4X | NEMA 4X | NEMA 4X | NEMA 4X | NEMA 4X | NEMA 4X | NEMA 4X | NEMA 4X | NEMA 4X | NEMA 4X |
| Cooling | Natural Convection | Natural Convection | Natural Convection | Natural Convection | Natural Convection | Natural Convection | Natural Convection | Natural Convection | Natural Convection | Natural Convection |
| Conduit Connections | Traditional size KOs: (2ea x1/2") and (2ea x 1-1/4", 3 places side, front, rear) | Traditional size KOs: (2ea x1/2") and (2ea x 1-1/4", 3 places side, front, rear) | Traditional size KOs: (2ea x1/2") and (2ea x 1-1/4", 3 places side, front, rear) | Traditional size KOs: (2ea x1/2") and (2ea x 1-1/4", 3 places side, front, rear) | Traditional size KOs: (2ea x1/2") and (2ea x 1-1/4", 3 places side, front, rear) | Traditional size KOs: (2ea x1/2") and (2ea x 1-1/4", 3 places side, front, rear) | Traditional size KOs: (2ea x1/2") and (2ea x 1-1/4", 3 places side, front, rear) | Traditional size KOs: (2ea x1/2") and (2ea x 1-1/4", 3 places side, front, rear) | Traditional size KOs: (2ea x1/2") and (2ea x 1-1/4", 3 places side, front, rear) | Traditional size KOs: (2ea x1/2") and (2ea x 1-1/4", 3 places side, front, rear) |
| Grid Wiring Termination Type | Screw Terminal Block Single wire, 90°C terminal wiring | Screw Terminal Block Single wire, 90°C terminal wiring | Screw Terminal Block Single wire, 90°C terminal wiring | Screw Terminal Block Single wire, 90°C terminal wiring | Screw Terminal Block Single wire, 90°C terminal wiring | Screw Terminal Block Single wire, 90°C terminal wiring | Screw Terminal Block Single wire, 90°C terminal wiring | Screw Terminal Block Single wire, 90°C terminal wiring | Screw Terminal Block Single wire, 90°C terminal wiring | Screw Terminal Block Single wire, 90°C terminal wiring |

| | | | | | | | | | | | |
|---|----------------------------|---------------------------------------|---------------------------------------|---------------------------------------|--|--|--|--|--|--|--|
| Environmental | | | | | | | | | | | |
| Ambient Air Temperature Range | °C (°F) | - | - | - | - | - | - | - | - | - | - |
| | | 13... +14 0 (- 25... +60) | 13... +14 0 (- 25... +60) | 13... +14 0 (- 25... +60) | 13... +14 0 (- 25... +60) | 13... +14 0 (- 25... +60) | 13... +14 0 (- 25... +60) | 13... +14 0 (- 25... +60) | 13... +14 0 (- 25... +60) | 13... +14 0 (- 25... +60) | 13... +14 0 (- 25... +60) |
| | | with dera ting abov e | with dera ting abov e | with dera ting abov e | with dera ting abov e | with dera ting abov e | with dera ting abov e | with dera ting abov e | with dera ting abov e | with dera ting abov e | with dera ting abov e |
| | | 131 (55) | 131 (55) | 131 (55) | 131 (55) | 131 (55) | 131 (55) | 131 (55) | 131 (55) | 131 (55) | 131 (55) |
| Acoustic Noise Emission Level | d B A @ 1 m | < 50 | < 50 | < 50 | < 50 | < 50 | < 50 | < 50 | < 50 | < 50 | < 50 |
| Relative Humidity | % R H | 0- 100 con dens ing | 0- 100 con dens ing | 0- 100 con dens ing | 0...1 00 con dens ing | 0...1 00 con dens ing | 0...1 00 con dens ing | 0- 100 con dens ing | 0- 100 con dens ing | 0- 100 con dens ing | 0- 100 con dens ing |
| Maximum Operating Altitude without Derating | ft(m) | 656 0 (200 0) | 656 0 (200 0) | 656 0 (200 0) | 656 0 (200 0) | 656 0 (200 0) | 656 0 (200 0) | 656 0 (200 0) | 656 0 (200 0) | 656 0 (200 0) | 656 0 (200 0) |
| Protection Devices | | | | | | | | | | | |
| Output | | | | | | | | | | | |
| Anti-Islanding Protection | | Per Rqmts UL 1741/IEEE 1547 | | | Per Rqmts UL 1741/IEEE 1547 | | | Per Rqmts UL 1741/IEEE 1547 | | | |
| External AC OCPD Rating | A _R MS | 20 | 20 | 15 | 25 | 20 | 20 | 25 | 25 | 25 | |
| Over-Voltage Protection Type | | Varistor, 2 (L - N / L - PE) | | | Vari stor, 2 (L - N / L - PE) | Vari stor, 2 (L - N / L - PE) | Vari stor, 2 (L - N / L - PE) | Vari stor, 2 (L - N / L - PE) | Vari stor, 2 (L - N / L - PE) | Vari stor, 2 (L - N / L - PE) | Vari stor, 2 (L - N / L - PE) |
| Input | | | | | | | | | | | |
| Reverse Polarity Protection | | Yes | Yes | Yes | Yes | Yes | Yes | Yes | Yes | Yes | Yes |

| | | | | | | | | | | |
|--|-----|--|--|--|--|--|--|--|--|--|
| Maximum Short Circuit Current Limit per Channel | A | 12.5 | 12.5 | 12.5 | 20 | 20 | 20 | 20 | 20 | 20 |
| Over-Voltage Protection Type | | Vari stor, 2 for each chan nel | Vari stor, 2 for each chan nel | Vari stor, 2 for each chan nel | Vari stor, 2 for each chan nel | Vari stor, 2 for each chan nel | Vari stor, 2 for each chan nel | Vari stor, 2 for each chan nel | Vari stor, 2 for each chan nel | Vari stor, 2 for each chan nel |
| PV Array Ground Fault Detection | | Pre start -up Riso and dyn amic GFD I (Req uire s Floa ting Arra ys) | Pre start -up Riso and dyn amic GFD I (Req uire s Floa ting Arra ys) | Pre start -up Riso and dyn amic GFD I (Req uire s Floa ting Arra ys) | Pre start -up Riso and dyn amic GFD I (Req uire s Floa ting Arra ys) | Pre start -up Riso and dyn amic GFD I (Req uire s Floa ting Arra ys) | Pre start -up Riso and dyn amic GFD I (Req uire s Floa ting Arra ys) | Pre start -up Riso and dyn amic GFD I (Req uire s Floa ting Arra ys) | Pre start -up Riso and dyn amic GFD I (Req uire s Floa ting Arra ys) | Pre start -up Riso and dyn amic GFD I (Req uire s Floa ting Arra ys) |
| DC Switch Current Rating (Per Contact) | A/V | 25 / 600 | 25 / 600 | 25 / 600 | 25 / 600 | 25 / 600 | 25 / 600 | 25 / 600 | 26 / 600 | 27 / 600 |
| Isolation Level | | Tran sfor merl ess (Flo atin g Arra y) | Tran sfor merl ess (Flo atin g Arra y) | Tran sfor merl ess (Flo atin g Arra y) | Transformerless (Floating Array) | | | Transformerless (Floating Array) | | |
| Safety and EMC Standard | | UL 174 1, CSA - C22. 2 N. 107. 1-01 | UL 174 1, CSA - C22. 2 N. 107. 1-02 | UL 174 1, CSA - C22. 2 N. 107. 1-03 | UL 174 1, CSA - C22. 2 N. 107. 1-01 | UL 174 1, CSA - C22. 2 N. 107. 1-02 | UL 174 1, CSA - C22. 2 N. 107. 1-03 | UL 174 1, CSA - C22. 2 N. 107. 1-01 | UL 174 1, CSA - C22. 2 N. 107. 1-02 | UL 174 1, CSA - C22. 2 N. 107. 1-03 |
| Safety Approval | | cCSA US | cCSA US | cCSA US | cCSA US | cCSA US | cCSA US | cCSA US | cCSA US | cCSA US |

| Features-Communication | | | | | | | | | | | | |
|---|--|---|---|---|--|---|---|---|--|---|---|---|
| User-Interface (Display) | | 16 characters x 2 lines LCD display | 17 characters x 2 lines LCD display | 18 characters x 2 lines LCD display | | 16 characters x 2 lines LCD display | 17 characters x 2 lines LCD display | 18 characters x 2 lines LCD display | | 16 characters x 2 lines LCD display | 17 characters x 2 lines LCD display | 18 characters x 2 lines LCD display |
| Remote Monitoring (1xRS485 incl.) | | AURORA - UNIVERSAL (opt.) | AURORA - UNIVERSAL (opt.) | AURORA - UNIVERSAL (opt.) | | AURORA - UNIVERSAL (opt.) | AURORA - UNIVERSAL (opt.) | AURORA - UNIVERSAL (opt.) | | AURORA - UNIVERSAL (opt.) | AURORA - UNIVERSAL (opt.) | AURORA - UNIVERSAL (opt.) |
| Wired Local Monitoring (1xRS485 incl.) | | PVI-USB - RS485_2 32 (opt.), PVI-DES KTO P (opt.) | PVI-USB - RS485_2 32 (opt.), PVI-DES KTO P (opt.) | PVI-USB - RS485_2 32 (opt.), PVI-DES KTO P (opt.) | | PVI-USB - RS485_2 32 (opt.), PVI-DES KTO P (opt.) | PVI-USB - RS485_2 32 (opt.), PVI-DES KTO P (opt.) | PVI-USB - RS485_2 32 (opt.), PVI-DES KTO P (opt.) | | PVI-USB - RS485_2 32 (opt.), PVI-DES KTO P (opt.) | PVI-USB - RS485_2 32 (opt.), PVI-DES KTO P (opt.) | PVI-USB - RS485_2 32 (opt.), PVI-DES KTO P (opt.) |
| Wireless Local Monitoring | | PVI-DES KTO P (opt.) with PVI-RAD IOM ODU LE (opt.) | PVI-DES KTO P (opt.) with PVI-RAD IOM ODU LE (opt.) | PVI-DES KTO P (opt.) with PVI-RAD IOM ODU LE (opt.) | | PVI-DES KTO P (opt.) with PVI-RAD IOM ODU LE (opt.) | PVI-DES KTO P (opt.) with PVI-RAD IOM ODU LE (opt.) | PVI-DES KTO P (opt.) with PVI-RAD IOM ODU LE (opt.) | | PVI-DES KTO P (opt.) with PVI-RAD IOM ODU LE (opt.) | PVI-DES KTO P (opt.) with PVI-RAD IOM ODU LE (opt.) | PVI-DES KTO P (opt.) with PVI-RAD IOM ODU LE (opt.) |

| | | | | | | | | | | | |
|--|-------|--------------------|--------------------|--------------------|--------------------|--------------------|--------------------|--------------------|--------------------|--------------------|--|
| | | | |) | | | |) |) |) | |
| Standard Warranty | years | 10 | 10 | 10 | 10 | 10 | 10 | 10 | 10 | 10 | |
| Extended Warranty | years | 15&20 | 15&20 | 15&20 | 15&20 | 15&20 | 15&20 | 15&20 | 15&20 | 15&20 | |
| Available Models | | | | | | | | | | | |
| Standard- No switchbox- Floating Array | | PVI-3.0-OUT D-US | PVI-3.0-OUT D-US | PVI-3.0-OUT D-US | PVI-3.6-OUT D-US | PVI-3.6-OUT D-US | PVI-3.6-OUT D-US | PVI-4.2-OUT D-US | PVI-4.2-OUT D-US | PVI-4.2-OUT D-US | |
| DC Switch Option - Floating Array | | PVI-3.0-OUT D-S-US | PVI-3.0-OUT D-S-US | PVI-3.0-OUT D-S-US | PVI-3.6-OUT D-S-US | PVI-3.6-OUT D-S-US | PVI-3.6-OUT D-S-US | PVI-4.2-OUT D-S-US | PVI-4.2-OUT D-S-US | PVI-4.2-OUT D-S-US | |
| | | | | | | | | | | | |
| | | | | | | | | | | | |
| *All data is subject to change without notice | | | | | | | | | | | |
| ** Adjustable low trip point to 57Hz. Contact manufacturer for details | | | | | | | | | | | |
| ***Inverter can apply that much current- Breaker will open | | | | | | | | | | | |
| ** Adjustable low trip point see 2.5.1.1. Contact manufacturer for details | | | | | | | | | | | |
| ***Inverter can apply that much current- Breaker will open | | | | | | | | | | | |

1.2 Technical Data

1.3 Voltage and frequency limits

The UL1741 requires, for voltage and frequency, the following limits for utility interaction:
Condition Simulated utility source
Voltage (V) Frequency (Hz) Maximum time (sec) at 60 Hz before cessation of current to the simulated utility



The PVI-4.2(3.6,3.0)-OUTD-x-US voltage and frequency limits are listed in the following table:

| Condition | Simulated utility source | | Maximum time (sec) at 60 Hz before cessation of current to the simulated utility |
|-----------|---|--|--|
| | Voltage (V) | Frequency (Hz) | |
| A | $V < 50\% V_{nom}$ | Rated (Default/Fixed) | 0.16 sec (Fixed) |
| B | $50\%V_{nom} \leq V < 88\% V_{nom}$ | Rated | 2 sec (Fixed) |
| C | $110\%V_{nom} \leq V < 120\% V_{nom} (*)$ | Rated | 1 sec (Fixed) |
| D | $V \geq 120\% V_{nom} (*)$ | Rated (Default, Fixed) | 0.16 sec (Fixed) |
| E | Rated | $f > 60.5$ (Default) | 0.16 sec (Default) |
| F | Rated | $f < 59.3$ (Default) (Adj. Set Points 59.7 Hz to 57 Hz) | 0.16 sec (Default) (Adj. Set Points 0.16s to 300s) |
| G | Rated | $f < 57.0$ (Default, Fixed) | 0.16 sec (Fixed) |
| H | Rated | $f > 60.5$ (Fixed) | 0.16 sec (Fixed) |

(*) Note: For model at 277V High Voltage is fixed at $110\% V_{nom}$ and Very High Voltage is fixed at $111\% V_{nom}$.

(**)Note: for model at 208V Very Low Voltage is fixed at $55\% V_{nom}$. Minimum adjustable Low Voltage level is $55\% V_{nom}$.

1.3 A DESCRIPTION OF THE SYSTEM

AURORA UNO grid-tied inverters provide the capability to supply the utility grid with energy obtained from PV panels. To use the DC generated by a Photovoltaic field efficiently, it must be transformed into alternating current (AC) via a conversion process known as DC-AC inversion.

This process is the basis of all grid-tied inverters and is achieved very efficiently by the AURORA Inverter without the use of rotating elements. When the inverter output is connected in parallel to the utility power grid, the alternating current output from the inverter flows directly into the distribution circuit, and is connected in turn to the public distribution utility grid.

The photovoltaic energy system can thus feed all the connected user electrical loads:

- If the energy supply from the photovoltaic system is lower than the user's load requirement, the quantity of energy necessary to guarantee normal functioning of the connected appliances is taken from the public distribution network.
- If the energy supply from the photovoltaic system is greater than the user's load requirement (i.e. an excess of energy is produced) it is sent directly into the public network, thus becoming available to other users.

Depending on prevailing codes and regulations of the installation area, the energy produced can be sold to the utility or credited against future consumption, thereby producing energy savings.

1.3.1 Fundamental Elements of a Photovoltaic System: 'STRINGS' and 'ARRAYS'

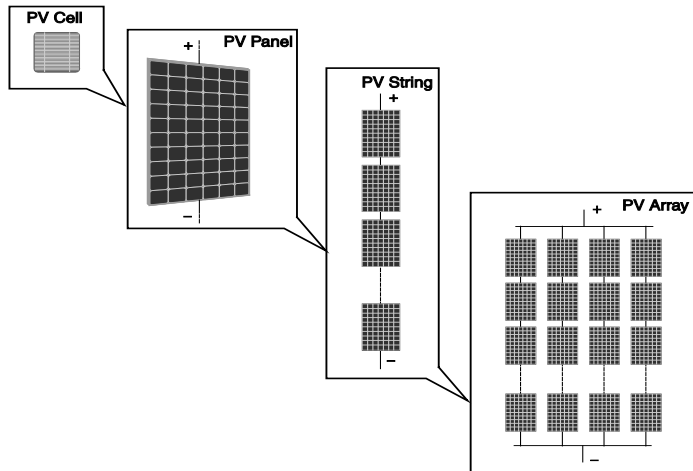

Figure 7:01- Array Composition

In order to significantly reduce installation costs of the photovoltaic system, especially related to the wiring problem on the inverter DC side and the subsequent distribution on the AC side, the STRING technology was developed. The terminology is as follows:

- A photovoltaic panel is composed of a great number of photovoltaic cells fixed onto a single supporting base.
- A STRING consists of a certain number of panels connected in series.
- An ARRAY is one or more strings connected in parallel.

Large photovoltaic systems can be composed of several arrays, connected to one or more AURORA Inverters.

By maximizing the number of panels in each string, the cost and complexity of the connection systems of the plant can be reduced.

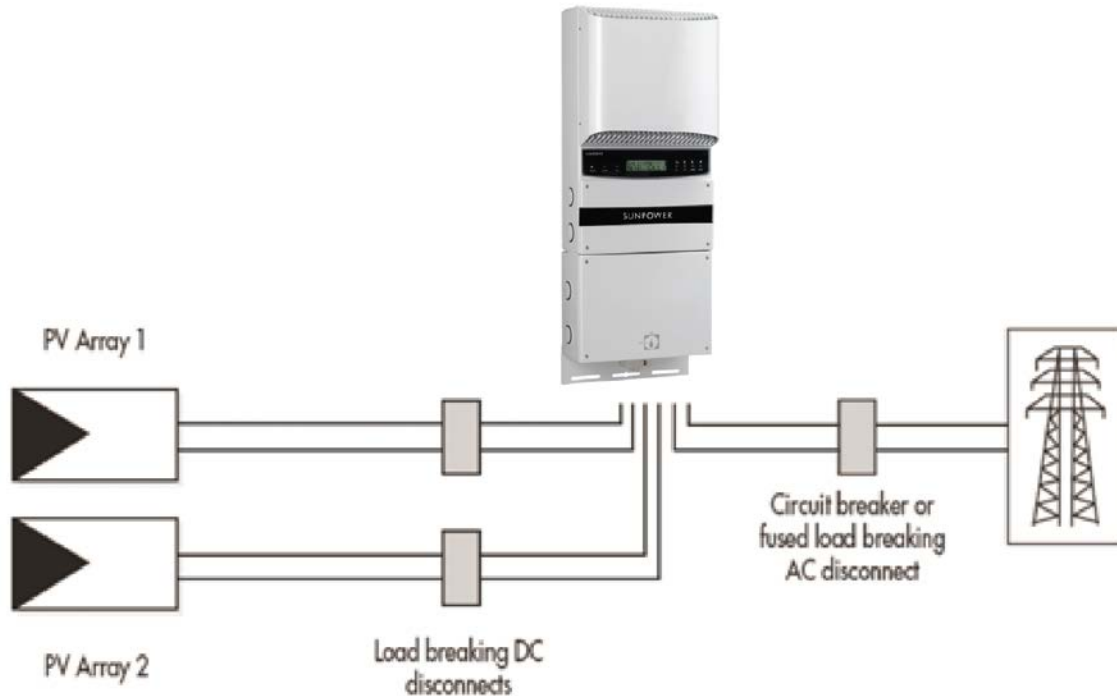

Figure 7:01 - Simplified Diagram of a Photovoltaic System

1.3.2 Inverter Input - The Photovoltaic Array

The input of a photovoltaic (PV) inverter is intended to be connected to a PV array. The input circuitry includes Maximum Power Point Tracking (MPPT) circuitry, which maximizes the output of the PV array under all allowable environmental conditions.

All AURORA UNO models are provisioned with two independent inputs, each equipped with its own MPPT circuit that enables the AURORA UNO Inverter to be connected to two independent arrays that are maximized for output power individually.

The MPPT circuitry has a specific operating range and the arrays must be designed to operate within this range. In order to properly operate the AURORA Inverter, proper array sizing must be completed and the results translated to a connectable system.

Array sizing is based on many variables and must be done for every array, as specifications are dependent on the type and quantity of PV panel used, and environmental factors such as expected high and low ambient temperatures to which the array will be subjected, as well as the orientation of the array panels to the sun.

In addition to properly sizing the array to match the inverter to which it is connected, the sizing of the interconnecting wiring is critical to ensure safe operation and high reliability. In North America, the wire sizing for the array and the grid interconnection are regulated and controlled by electric and building codes. Generally in the US, the National Electric Code (NEC) is used, but some areas use variations to this code. In Canada, the national code is the Electrical Safety Code (ESC); however, there are also local variations to this code (e.g., in Ontario the Ontario Electrical Safety Code (OESC) is the regulating document). The sizing and specification of a PV array requires trained individuals.

Decisions on how to structure a photovoltaic array depend on a number of factors and considerations, such as the type of panels, the available space, the future location of the system, long-term energy production targets, etc. Power-One offers a configuration program (AURORA Stringtool) that can aid the designer in setting

correct dimensioning of a photovoltaic array to match characteristics of AURORA Inverters is available on the Power-One website (<http://stringtool.power-one.com/>).

Array sizing concerns:

| | |
|---|--|
|  <p>WARNING</p> | <ul style="list-style-type: none"> • To avoid equipment damage, the string voltage must not exceed 520 Vdc for any reason. • The effect of the negative thermal coefficient on the PV module's open circuit voltage causes Over Current (OC) Voltage to occur in conditions of minimum ambient temperature. It is the responsibility of the installer to check the PV generator's configuration before connecting any PV array. • The AURORA UNO Inverter has a maximum allowable input current limit of 24Adc for each MPPT input channel. |
|---|--|

| | |
|---|---|
|  <p>NOTE:</p> | <p>The default value of the input voltage required to start the inverter (Vstart) is 200 Vdc; however, this can be set from the control panel over the range between 120 Vdc and 350 Vdc. This voltage level is required for the AURORA Inverter to start its grid connection sequence. Once connected, the inverter will transfer the maximum available power for any Vdc input voltage value in a range between 70% of the value set by Vstart and 520 Vdc to the grid.</p> |
|---|---|

1.3.3 Technical Description of AURORA UNO Inverter

The main segments of the design are the independent input DC-DC converters (termed 'boosters', one for each MPPT channel) and the main output inverter. Both of the DC-DC converters and the output inverter operate at a high switching frequency to enable a compact design and low weight.

These versions of Power-One's AURORA Inverters utilize "high-frequency switching" transformers, to provide a high-level of galvanic isolation between inverter input (array) and output (grid). This circuitry provides galvanic isolation from the secondary (AC side), while maintaining very high performance in terms of energy yield and export.

An AURORA UNO with two independent input DC-DC converters; each converter is typically dedicated to a separate array and has independent Maximum Power Point Tracking (MPPT) circuitry and control. This means that the two arrays can be installed with different positions, facing different directions and with different string lengths; each array is controlled by an MPPT control circuit.

The AURORA UNO's high efficiency and extra large heat dissipation system enables operation at maximum power over a broad range of ambient temperatures.

Two independent *Digital Signal Processors* (DSP) and one central microprocessor control the inverter; and therefore, two independent computers control the grid connection in full compliance with safety standards and regulations.

The AURORA UNO Inverter operating system (program) communicates with all of the sub-systems within the inverter performing necessary data processing, calculations to guarantee optimal performance levels of the system and high-power harvesting in all installation and load conditions, while maintaining full compliance with prevailing safety directives, laws and regulations.

1.4 PROTECTIVE DEVICES WITHIN THE AURORA UNO INVERTER

1.4.1 Inverter Output - the Grid Connection

The inverter converts energy harvested from the PV array into a form that can be transported to the connected AC grid, and by doing so, enables the energy to be used to power grid-loads.

Connections of an inverter to the grid is a very controlled process not only in the actual electrical connection, but the regulatory processes required to gain approval from the controlling utility and other regulatory bodies. AURORA UNO Inverters meet the requirements of all interconnection standards.

1.4.2 Data Transmission and Check

The AURORA Inverters have a sophisticated communication capability that enables monitoring of single or multiple inverters over a single communication link. Remote monitoring is implemented over an RS-485-based serial interface using a version of the AURORA Protocol. There is an optional web-based data logging system (AURORA Universal) also available for remote monitoring via the Internet via LAN, or GSM digital modem. The PVI-Desktop is another monitoring option that enables (with the use of the PVI-Radio-module installed in each inverter) the ability to monitor wirelessly operation of up to six inverters within a 1000-foot radius. The PVI desktop is not a web-based monitoring system and is intended for local ('in-house') monitoring applications.

1.4.3 Anti-Islanding

When the local utility AC grid fails due to a line fault or otherwise interrupted (e.g., equipment maintenance) the AURORA UNO Inverter must be physically disconnected in a fail-safe manner to protect any personnel working on the network. The AURORA system accomplishes this in full compliance with all prevailing standards and regulations. To avoid any possible operation without the presence of an active grid connection, the AURORA design includes an automatic disconnection protection system called 'Anti-Islanding'. All AURORA models are equipped with an anti-islanding protection system certified to both US and Canadian standards (UL Std N.1741 and CSA-C22.2 N.107.1-01)

1.4.4 Grounding/Differential Protection Fault

AURORA UNO Inverter has a sophisticated ground protection circuit that continually monitors the ground connection for significant changes in fault current. When a ground fault current sufficient to cause safety hazards is detected, this circuit shuts down the inverter and illuminates a red LED on the front panel indicating a ground fault condition. The AURORA Inverter is equipped with a terminal for the system ground conductors.

| | |
|--|---|
|  DANGER: | <p>Normally grounded conductors may be ungrounded and energized when a ground-fault is indicated.</p> <ul style="list-style-type: none"> • Risk of electric shock • Test before touching • Work on the AURORA UNO Inverter must be carried out by qualified personnel. |
|--|---|

| | |
|--|--|
|  NOTE: | <p>The protective devices for ground fault detection and control comply with CSA-C22.2 N.107.1-01 and UL Std N.1741.</p> |
|--|--|

1.4.5 ADDITIONAL PROTECTIVE DEVICES

AURORA UNO Inverter is equipped with additional protections to guarantee the safe operation under any circumstances. Such protections include:

- Constant monitoring of grid voltage to ensure that voltage and frequency remain within the specified operational limits (in accordance with UL 1741 standard);

- Automatic power limitation (derating) controlled by internal temperature monitoring to avoid overheating (heat sink temperature $\geq 158^{\circ}\text{F}$).

1.4.5.1 Power Derating

In order to ensure inverter operation under safe conditions both from the temperature and electrical point of view, the unit automatically decreases power input to the grid. Power derating can occur in two cases:

- **Power reduction due to environmental conditions**

Power reduction and temperature, at which it occurs, depends on many operating parameters other than ambient temperature; such as input voltage, grid voltage, and power available from the photovoltaic panels. AURORA Inverter can thus decrease power output during certain periods of the day according to these parameters.

In any case, the AURORA Inverter ensures maximum power up to 50°C provided it is not directly exposed to the sun.

- **Power reduction due to input voltage**

Necessary conditions for power derating due to environmental conditions and to input voltage can occur at the same time, but in this instance power derating will always consider the lowest value detected.

1.4.5.2 FCC

The equipment specified in this manual complies with Part 15 of the FCC rules. Operation is subject to following two conditions:

- (1) This equipment may not cause harmful interference.
- (2) This equipment must accept any interference received, including interference that may cause undesired operation.

###