



The Manual:

PVI-5000-6000-OUTD-US



POWER-ONE Trademarks:

Copyright © 2011 Power-One Renewable Energy Solutions, LLC. All rights reserved. No part of this document may be reproduced in any form or by any means without the prior written permission of Power-One Renewable Energy Solutions LLC. Power-One Renewable Energy Solutions LLC makes no representations, express or implied, with respect to this document or any of the equipment and/or software it may describe; including (without limitation) any implied warranties of utility, or merchantability for any particular purpose. All such warranties are expressly disclaimed. Power-One Renewable Energy Solutions, LLC, its subsidiaries, affiliates, distributors and dealers shall not be liable for any indirect, special, incidental, or consequential damages under any circumstances.

Power-One Renewable Energy LLC reserves the right to make changes to this document without notice and shall not be responsible for any damages, including indirect, special, incidental or consequential damages, caused by reliance on the content presented, including, but not limited to, any omissions, typographical errors, arithmetical errors or listing errors. All trademarks, logos, trade names, service marks and copyrighted materials used in this document are the property of their respective owners. Failure to designate a mark as registered does not mean that such mark is not a registered trademark. The Power-One name and logo are registered trademarks of Power-One, Inc. in the U.S.A. and other countries. All rights reserved. No licenses are conveyed herein, implicitly or otherwise, under any intellectual property rights.

Power-One
Renewable Energy Solutions LLC
740 Calle Plano
Camarillo, California, 93012
United States



Contents

INSTRUCTIONS FOR USE OF THIS MANUAL	8
KEEP THESE INSTRUCTIONS!	8
USEFUL INFORMATION AND SAFETY REGULATIONS	8
1.0 FOREWORD	8
2.0 INTRODUCTION	8
2.1 Target Group	8
2.2.1 Nameplate.....	9
2.2.2 Warranty Information	9
2.3 COMMISSIONING:	9
2.4 MAINTENANCE AND SERVICE	10
2.5 FIGURES AND IMAGES IN THIS MANUAL	10
2.6 STORAGE OF THIS INFORMATION	10
2.7 ADDITIONAL INFORMATION	10
3.0 SAFETY	10
3.1 Warnings in This Document:.....	10
3.1.2 Other Symbols in this Document:.....	10
3.2 GENERAL INSTALLATION WARNINGS.....	11
3.2.1 Assembly Warnings	12
3.2.2 Electrical Connection Warnings	12
3.2.3 Operation Warnings	12
3.3 APPROPRIATE USAGE	13
3.4 SAFETY INSTRUCTIONS	13
3.5 LOCATION OF SAFETY NOTICES	14
1.0 UNPACK AND INSPECT	16
1.1 Incoming Inspection	16
1.2 Selecting The Installation Location.....	16
2a: 2.0 MOUNTING PVI-5000-6000-OUTD-US	20
2a: 3.0 INSTALLATION PVI-5000-6000-OUTD-US	21
3.1 Removing the Front Covers	21
3.2 Electrical Wiring and Connections PVI-5000-6000-OUTD-US.....	21
3.2.1 Considerations Before Performing Electrical Connections.....	22

3.2.2 Field Wiring-Knockout- Details PVI-5000-6000-OUTD-US	22
3.2.3 Initial Electrical Connections PVI-5000-6000-OUTD-US	24
3.2.4 DC Array Connections	24
3.2.5 AC Grid Connections	26
Figure 2:07b: Grid Standard.....	26
3.2.6 Signal Wiring Connections	27
3.2.6.1 Connect RS485 Monitoring Cable.....	27
PAR/IND INMODE SWITCH	30
3.3.2 Independent Or Parallel Connection of Dual Inputs	30
3.3.2.1 Independent Connection.....	30
3.3.2.2 Parallel Connection	31
4: 1.0 AC AND DC WIRING AND OVER CURRENT PROTECTION	34
4: 1.2 MULTI-UNIT CONFIGURATION.....	35
1.2.1 Daisy Chain	35
1.2.1.1 Connection & Cabling	37
4.1.3 ADDRESSING EACH INVERTER.....	37
1.3.1 Installation Instructions:	37
4: 0.1 COMMISSIONING	40
4.1.0 INVERTER START-UP and OPERATION.....	41
1.2 SHUT-DOWN PROCEDURE.....	42
1.3 POWER-DOWN PROCEDURES	42
1.3.1 Disconnection Of AURORA Inverters	42
4: 2.0 OPERATIONS: USER INTERFACE, MONITORING AND DATA TRANSMISSION	44
2.1 USER INTERFACE MODE.....	44
2.2 DATA TYPES AVAILABLE	45
2.2.1 Real-Time Operational Data.....	45
2.2.2 Data Logged Internally.....	46
2.3 LED INDICATORS	46
2.4 MESSAGES AND ERROR CODES	48
2.5 LCD DISPLAY	49
2.5.1 Connection of the System to the Grid.....	49
2.5.1.1 Field Adjustments for Frequency and Disconnection Time.....	50
2.5.2 Error Messages.....	54
2.5.3 First Phase- Electric Parameter Check	55

2.5.4 Main Menu.....	57
2.5.5 Statistics	58
2.5.6 Lifetime.....	58
2.5.7 Partial	58
2.5.8 Last 7 days.....	59
2.5.9 Last Month.....	59
2.5.10 Last 365 Days	60
2.5.11 User Period.....	60
2.5.12 Settings.....	60
2.5.13 Address	61
2.5.14 Display Set.....	61
2.5.15 Service.....	62
2.5.16 New Password.....	62
2.5.17 Cash	62
2.5.18 Time.....	62
2.5.19 Language	63
2.5.20 Start-Up Voltage	63
2.5.21 Alarm.....	63
2.5.22 Remote Control.....	64
2.5.23 UV Protection Time (PROT. TIME).....	64
2.5.24 MPPT	64
2.5.25 Alarm Message.....	64
2.5.25 Set Vgrid	65
2.5.26 Information	66
3.0 DATA CHECK AND COMMUNICATION	66
5: 1.0 TROUBLESHOOTING.....	68
1.2 LED INDICATORS	68
1.3 MESSAGES and ERROR CODES	70
1.4 LCD DISPLAY	72
1.4.1 Connection of the System to the Grid.....	72
1.5 FIRST PHASE- ELECTRIC PARAMETER CHECK.....	73
1.6 THE Power-One SERVICE CALL.....	74
6: 1.0 MAINTENANCE.....	76
1.1 SHUT-DOWN PROCEDURE.....	76
1.2 POWER-DOWN PROCEDURES	76

1.2.1 Disconnection Of AURORA Inverter	76
1.3 CR2032 LITHIUM BATTERY REPLACEMENT	78
1.0 DATA SHEETS	81
1.4 DESCRIPTION OF THE SYSTEM	87
1.4.1 Fundamental Elements of a Photovoltaic System: 'STRINGS' and 'ARRAYS'	88
1.4.2 Inverter Input - The Photovoltaic Array	89
1.4.3 Technical Description of AURORA Inverter	90
1.5 PROTECTIVE DEVICES WITHIN THE AURORA INVERTER.....	90
1.5.1 Inverter Output - the Grid Connection.....	91
1.5.2 Data Transmission and Check.....	91
1.5.3 Anti-Islanding.....	91
1.5.4 Grounding/Differential Protection Fault.....	91
1.6.5 ADDITIONAL PROTECTIVE DEVICES.....	91
1.6.5.1 Power Derating.....	92
1.6.5.2 FCC.....	92

PART 1: INTRODUCTION & SAFETY

INSTRUCTIONS FOR USE OF THIS MANUAL

KEEP THESE INSTRUCTIONS!

This manual contains important instructions for safety and operation that must be followed during installation and maintenance of this photovoltaic inverter.

All operations regarding transport, installation, maintenance, and start-up must be carried out by qualified, trained technician or general contractor in compliance with all prevailing codes and regulations.

For a list of contractors certified to install this Power-One AURORA® Inverter, please contact Power-One Technical Support at 1-877-261-1374.

USEFUL INFORMATION AND SAFETY REGULATIONS

1.0 FOREWORD

This manual contains important instructions for the Power-One AURORA® Inverter that must be followed during installation and maintenance of this inverter.

This grid-tied inverter operates only when properly connected to the AC distribution network and requires the services of qualified technical personnel to connect only after receiving appropriate approvals, as required by the local authority having jurisdiction.

This document is not intended to replace any local, state province, federal, or national laws, regulation or codes applicable to the installation and use of the inverter, including without limitation applicable electrical safety codes. All installations must conform to the laws, regulations, codes and standards applicable in the jurisdiction of installation. Power-One assumes no responsibility for the compliance or noncompliance with such laws or codes in connection with the installation of the inverter.

KEEP ALL DOCUMENTS IN A SAFE PLACE!

2.0 INTRODUCTION

The purpose of this document is to support the qualified technician, who has received training and/or has demonstrated skills and knowledge in construction to install and maintain this Power-One AURORA® Photovoltaic (PV) Inverter.



This manual does not cover any details concerning equipment connected to the inverter such as the solar modules. Information concerning the connected equipment is available from the respective manufacturer.

2.1 Target Group

	CAUTION: For safety reasons only a qualified technician, who has received training and/or has demonstrated skills and knowledge in construction and in operation of this unit, can install this inverter.
---	--

This manual is for qualified installers and/or licensed technicians who know and understand the National Electric Code and other applicable local code regulations. For a list of certified contractors to help install this unit, please contact Power-One Technical Support at 1-877-261-1374.

2.2 Validity and Available Versions

	<p>PVI-5000-OUTD-US 45.50" x 14.25" x 15.50"/ 1156mmX62mmX394mm Shipping Weight: 78 lbs Unit Weight: 75 lbs</p>	
	<p>PVI-6000-OUTD-US 45.50" x 14.25" x 15.50"/ 1156mmX62mmX394mm Shipping weight: 78 lbs Unit Weight: 75 lbs</p>	

2.2.1 Nameplate

The nameplate shown above is affixed to the inverter and provides the following information:

- 1) Manufacturer code
- 2) Model code
- 3) Serial number
- 4) Week/Year of production



Sample product nameplate (PVI-5000-OUTD-US)

2.2.2 Warranty Information

After inspecting the AURORA Inverter, it is necessary to fill out the warranty information on this unit and submitted it to Power-One. Submitting this information will register the unit with the manufacturer and the owner will receive technical updates regarding this Power-One photovoltaic inverter.

2.3 COMMISSIONING:

As part of the commissioning process, double check the following:

- Make sure that there is no ground fault.
- Double check the voltage doesn't exceed specified voltage ratings.
- See Part 4 on Operations for more information on commissioning and start-up.

2.4 MAINTENANCE AND SERVICE

The AURORA Inverter has no user-serviceable parts. Maintenance and service procedures must comply with the manufacturer's documentation. For more detailed information, please see Part 6 on Maintenance.

2.5 FIGURES AND IMAGES IN THIS MANUAL

The photos in this manual may differ slightly from the final model shipped. The color of the components may not match those illustrated, but the information is still applicable.

2.6 STORAGE OF THIS INFORMATION

Keep this document in a safe place near the AURORA Inverter for easy access during installation and maintenance.

2.7 ADDITIONAL INFORMATION





For more information on this product contact your local Power-One dealer.

3.0 SAFETY

3.1 Warnings in This Document:

This is a list of special safety symbols used in this manual that highlight potential safety risks and/or useful information.





These symbols are as follows:

Symbol	Usage
 DANGER:	Indicates a hazardous situation that if not avoided can result in deadly electric shock hazards, other serious physical injury, and/or fire hazards.
 WARNING:	Indicates directions which must be fully understood and followed in its entirety in order to avoid potential safety hazards including equipment damage, or personal injury.
 CAUTION:	Indicates a hazardous situation which, if not avoided, could result in minor or moderate injury.
 NOTE:	Contain actions and instructions that must be followed in order to avoid potential damage to the equipment and/or faults.
 INFORMATION:	Accompanies notes that call attention to supplementary information that ensure optimal operation of the system.



3.1.2 Other Symbols in this Document:

In addition to the safety and hazard symbols, the following symbols are also used in this installation guide:



	System earth conductor (main grounding protective earth, PE)
	Alternating Current (AC) Value
	Direct Current (DC) Value
	Phase
	Grounding (earth)

The equipment has various labels. Those with a yellow background refer to safety concerns. Be sure to read all labels before beginning installation of the equipment. If any questions arise as to the meaning or intent of these notices, please contact Power-One Technical Support at 1-877-261-1374. The descriptions of the symbols used are as follows:

 WARNING	DANGEROUS VOLTAGE The product works with high voltages. All work on the AURORA Inverter must follow the described documentation and must comply with all prevailing codes and regulations associated with high voltages. During inverter operation, parts will be energized at voltage levels.
 WARNING	HOT TEMPERATURE Some surfaces may become hot. Do not touch the product while it is in operation.
	UL 1741 Standard for Safety for Inverters, Converters, Controllers and Interconnection System Equipment for use with Distributed Energy Resources. CSA CSA-C22.2 No. 107.1-01 - General Use Power Supplies. Rule Part 15, Subpart B - Unintentional Radiators Class B Limits

3.2 GENERAL INSTALLATION WARNINGS

 WARNING:	<ul style="list-style-type: none"> The AURORA Inverter is designed and tested according to international safety requirements; however, certain safety precautions must be observed when installing and operating this inverter. Read and follow all instructions, cautions and warnings in this installation manual. If questions arise, please contact Power-One Technical Support at 1-877-261-1374.
	<ul style="list-style-type: none"> All operations regarding transport, installation and start-up, including maintenance must be carried out by qualified, trained personnel and in compliance with all prevailing local codes and regulations.
	<ul style="list-style-type: none"> This grid-tied inverter system operates only when properly connected to the AC-distribution network. Before connecting the services of AURORA to the power distribution grid, contact the local power distribution grid company. This connection must be made only by qualified technical personnel to connect, and only after receiving appropriate approvals, as required by the local authority having jurisdiction.

	<ul style="list-style-type: none"> In order to minimize the potential of a shock hazard due to hazardous voltages, cover the entire solar array with dark material prior to connecting the array to any equipment.
	<ul style="list-style-type: none"> The Power-One AURORA Inverter is designed and tested according to international safety requirements (UL 1741/IEEE 1547), but as with all electrical and electronic equipment, certain precautions must be observed and followed during installation.
	<ul style="list-style-type: none"> Keep this documentation in the immediate vicinity of the AURORA Inverter. It must be accessible for approved technical service and maintenance personnel at any time.
	<ul style="list-style-type: none"> Basic safety rules require using qualified and trained personnel possessing the skills necessary for assembly, mounting, start-up and operation of the product.

3.2.1 Assembly Warnings

 WARNING:	<ul style="list-style-type: none"> Prior to installation, inspect the unit to ensure absence of any transport or handling damage, which could affect insulation integrity or safety clearances; failure to do so could result in safety hazards.
	<ul style="list-style-type: none"> Assemble the inverter per the instructions in this manual. Use care when choosing installation location and adhere to specified cooling requirements.
	<ul style="list-style-type: none"> Unauthorized removal of necessary protections, improper use, incorrect installation and operation may lead to serious safety and shock hazards and/or equipment damage.

3.2.2 Electrical Connection Warnings

 WARNING:	<ul style="list-style-type: none"> Make all electrical connections (e.g. conductor termination, fuses, PE connection, etc.) in accordance with prevailing regulations. When working with the inverter powered ON, adhere to all prevailing safety regulations to minimize risk of accidents.
	<ul style="list-style-type: none"> Systems with inverters typically require additional control (e.g., switches, disconnects) or protective devices (e.g., fusing circuit breakers) depending upon the prevailing safety rules.

3.2.3 Operation Warnings





 WARNING:	<ul style="list-style-type: none"> Anytime the inverter has been disconnected from the power network, use extreme caution as some components can retain charge sufficient to create a shock hazard; to minimize occurrence of such conditions, comply with all corresponding safety symbols and markings present on the unit and in this manual.
	<ul style="list-style-type: none"> Ensure all covers and doors are closed and secure during operation.
	<ul style="list-style-type: none"> All operations regarding transport, installation and START-UP, including maintenance must be performed by qualified, trained personnel and in compliance with all prevailing codes and regulations.

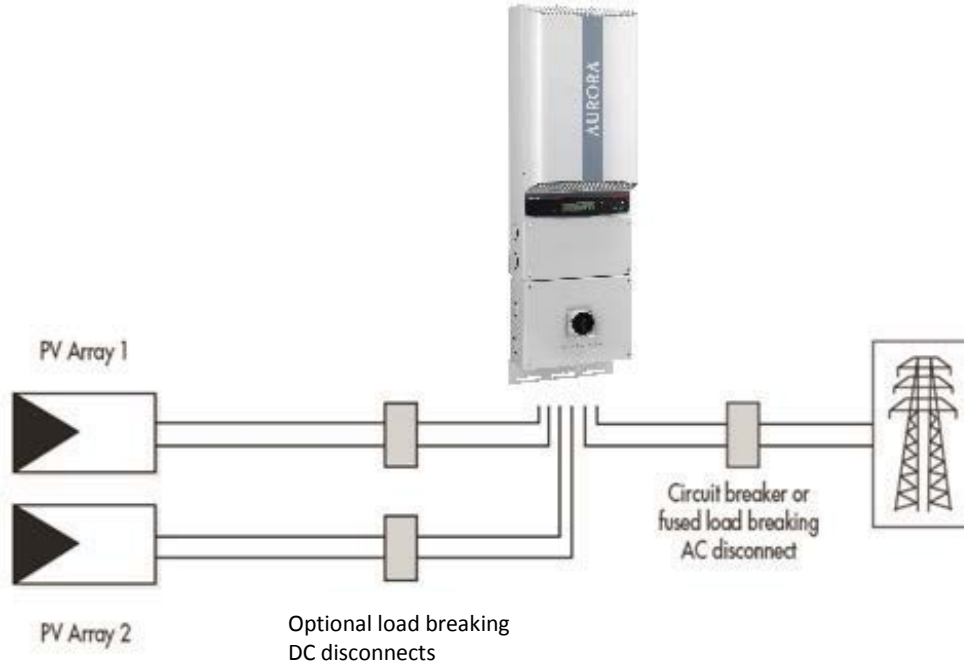

3.3 APPROPRIATE USAGE

The AURORA Inverter is a photovoltaic inverter that converts direct current of a PV array into alternating current and feeds that power into the power-distribution grid. This AURORA Inverter is suitable for outdoor installation only.



3.4 SAFETY INSTRUCTIONS

 DANGER:	Be sure all flammable materials including construction items are away from the unit. Do not install the inverter in or near potentially explosive areas.
 DANGER:	Normally grounded conductors may be ungrounded and energized when a ground-fault is indicated. <ul style="list-style-type: none"> • Risk of electric shock • Test before touching • Work on the AURORA Inverter must be carried out by qualified personnel.
 WARNING:	Do not connect an AURORA Inverter to the electrical distribution grid until after receipt of a letter of authorization from the authority having jurisdiction.
 WARNING:	Install the AURORA Inverter in accordance with the electrical standards prescribed by the applicable National Electric Code and/or by other local codes and regulations.

 CAUTION:	The inverter weight is about 75lbs and is susceptible to tipping. It requires two or more persons to mount to bracket. Use proper lifting techniques to avoid personal injury.
 CAUTION:	Cuts and scratches due to sharp edges inside the AURORA Inverter. Please use gloves and eye protection when working on this unit.

3.5 LOCATION OF SAFETY NOTICES

Please note the location of safety notices on the AURORA Inverter for notification and protection. They are located on both side panels of this unit.

PART 2: UNPACK & SELECT INSTALL LOCATION

1.0 UNPACK AND INSPECT

 WARNING	<ul style="list-style-type: none"> • Install the AURORA Inverter in accordance with the electrical standards prescribed by the applicable National Electric Code and/or by other local regulations and codes. • Do not connect an AURORA Inverter to the electrical distribution grid until after receipt of a letter of authorization from the authority having jurisdiction.
--	--

1.1 Incoming Inspection

It is the customer’s responsibility to examine the condition of the unit shipped.

Upon receipt of Power-One’s AURORA Inverter, please perform the following check:

- Inspect the shipping container for any external damage.
- Inventory the contents against the listing of Table 0-1 and verify receipt of all items. Use care not to discard any equipment, parts, or manuals.
- Call the delivering carrier if damage or shortage is detected.
- If inspection reveals damage to the inverter, contact the supplier, or authorized distributor for a repair/return determination and instructions regarding the return/repair process.

Table 0-1: Package contents	
QTY	Description
1	Aurora Inverter
1	Aurora Inverter mounting plate
1	Bag containing hardware:
	4 6.3x70 screws
	4 SX10 wall plugs
	1 Red Cable AWG 10
	1 Black Cable AWG 10
	1 6x10 screw
	5 d.18 washer
	1 Torx 20 wrench
	1 Frequency Change Label
1	Installation and Operator's Manual
1	Certificate of warranty
1	CD-ROM with communication software

1.2 Selecting The Installation Location

Select the installation location based on the following considerations:

1. Select a well-ventilated location sheltered from direct sun radiation.
2. Choose a location that allows unobstructed airflow around the inverter.
3. Allow sufficient room around the inverter to enable easy installation and removal from the mounting surface.
4. Height from ground level should be such that the display and status LEDs are easy to read.
5. Access panels on the front surface of the inverter allow inspection and maintenance of hardware; and must not be blocked. Figure 0-1 shows the recommended minimum clearances around the inverter.

6. When possible, mount the AURORA Inverter vertically. For other mounting orientations consult with Power-One.
7. Tilted mounting ($\pm 5^\circ$ from vertical) is acceptable, but will reduce heat dissipation and may result in self-derating.



Figure 0-1 - Minimum Clearances around the AURORA Inverter



 WARNING	The inverter surface may become hot to the touch during operation. To avoid burn injury, DO NOT touch the inverter surface during operation.
---	--



Figure 0-2a Recommended Arrangement
 For installation of AURORA Inverter



Figure 0-2b Unacceptable Arrangement
 For installation of AURORA Inverter

 NOTE	Do not mount the AURORA Inverter where exposed to direct sun radiation or any other heat source. This includes heat generated by other AURORA Inverters; otherwise, the inverter will move into a “self-protect mode” resulting in derated power output. When the ambient temperature rises above 122°F/ 50°C the inverter may self-derate the output power. For full power of AURORA Inverter (no derating), be sure the airflow through the heat sink is clear. Blockages will result in less than expected power output.
---	---

PART 3: MOUNTING & WIRING

Section 1:

PVI-5000-6000-OUTD-US

Section 2:

WIRING DETAILS

Read and apply all safety warnings when performing these tasks.

SECTION 1: PVI-5000-6000-OUTD-US



2a: 2.0 MOUNTING PVI-5000-6000-OUTD-US

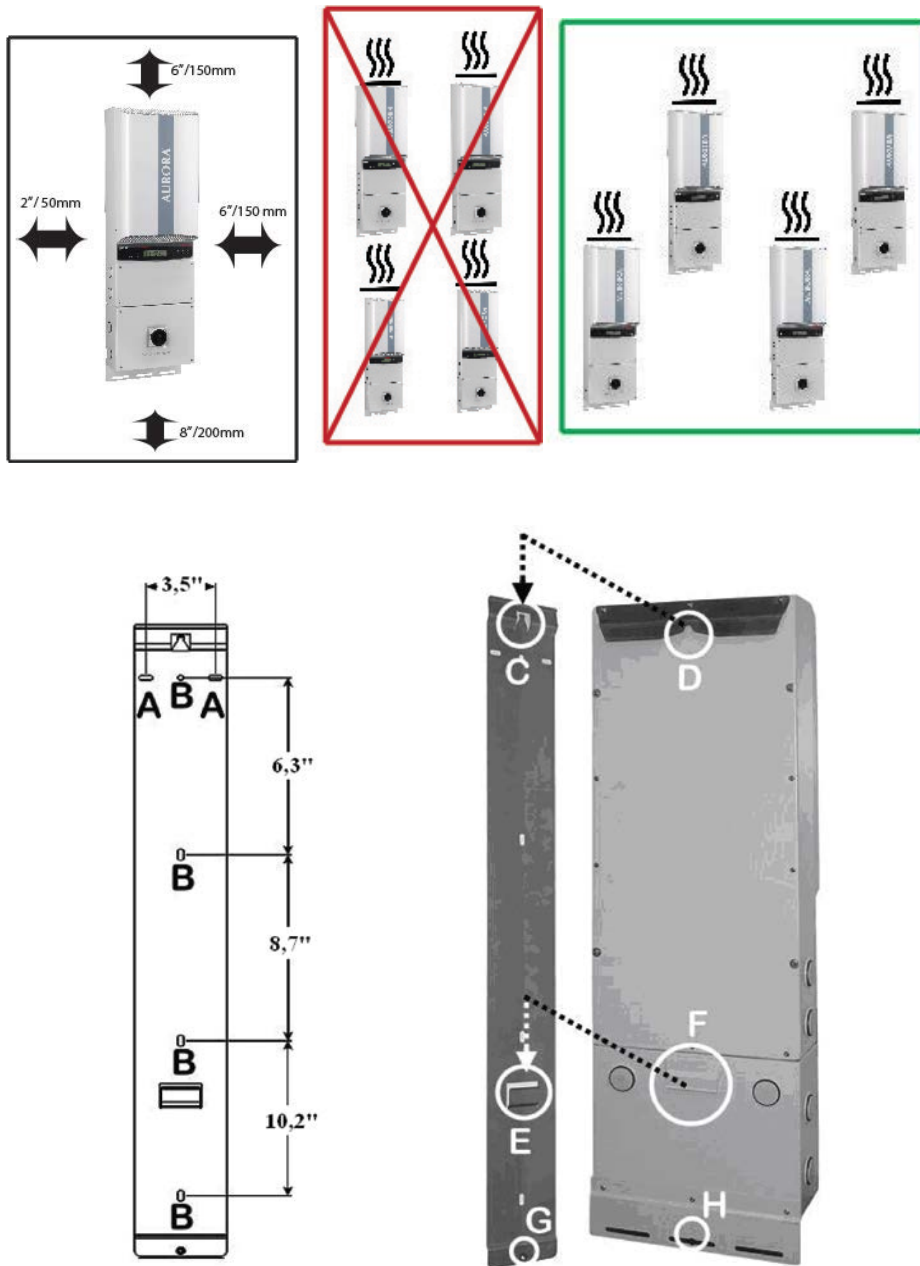

Figure 2:01 Bracket and Mounting Details

Step 1: Locate and mark the desired mounting location as shown above in mounting location.

Step 2: Orient the bracket such that the “C” hooks face outward and upward. (Figure.2:01)

Step 3: Using the hardware provided, level and mount the bracket to the surface using mounting holes shown in Figure 2:01.

Step 4: Hang the inverter on the mounted bracket by lifting the unit up over and above the mounting plate. Carefully guide the inverter and switchbox brackets and in the back of the inverter engage properly.

Step 5: Secure the bottom of the inverter using the machine screw (6x20mm) and washer (18mm diameter) provided. Insert machine screw through center hole of the bottom inverter mount. (H, Figure: 2:01), and engage the PEMut mounted in the bracket. (G Figure: 2:01)

2a: 3.0 INSTALLATION PVI-5000-6000-OUTD-US

3.1 Removing the Front Covers

To access the wiring terminals in the inverter and switchbox (when provisioned) the inverter cover and switchbox cover must be removed. Refer to Figure 2:02

- To remove the front cover of the **inverter** compartment, loosen the captive screws indicated using the Torx screwdriver provided.
- To remove the front cover of the **switchbox** compartment, loosen the captive screws indicated using the Torx screwdriver provided in the box with the inverter.
- When connection operations are completed, re-install the front covers and tighten the cover screws with at least 1.5Nm (13.2 in-lbs) torque to ensure proper waterproof sealing.



Figure 2:02- Location of Front Access Panels

3.2 Electrical Wiring and Connections PVI-5000-6000-OUTD-US

 DANGER	<ul style="list-style-type: none">• This section is dedicated to <u>initial</u> installation wiring of the AURORA Inverter and assumes the unit has been physically mounted in its final location, but not yet wired.• If the inverter has been previously wired and connected to the PV array and/or the
---	--

	AC grid, refer to Part 4: Operations for disconnection procedures.
--	--

3.2.1 Considerations Before Performing Electrical Connections

This section provides a systematic description of correct wiring procedures.

Please read the instructions provided and follow all safety warnings.

 WARNING	Failure to comply with these instructions can result in safety hazards and may lead to possible injury to personnel and/or equipment damage.
--	--

3.2.2 Field Wiring-Knockout- Details PVI-5000-6000-OUTD-US

To access the wiring components inside the switchbox shown in Figure 2:04, loosen the four cover panel captive screws shown in Figure 2:02, and remove the cover panel.



Code	Description	Code	Description
A	DC Power cable KO's; trade size 3/4", 1"	E	AC Power Cable screw terminals; trade size 1"
B	AC Power Cable KOs; trade size 3/4", 1"	F	DC Power cable screw terminals; trade size 3/4" / 1"
C	DC Switch	G	Ground cable KO 1/2" trade size.
D	Signal cable screw terminals: 1/2" trade size	H	Cover panel screw, Torx 20, 4pl.

Figure 2:03 DC Switchbox Chassis Layout



WARNING

The PVI-5000-6000-OUTD-US switchbox disconnects the DC current from the photovoltaic panels when the switch is in “OFF” position. It **DOES NOT** disconnect the AC connection to the grid. To disconnect the inverter from the AC grid, an AC switch (not included in this AURORA Inverter’s switchbox) must be disconnected. Due to the high voltage present on the power cable in the switchbox, ALWAYS disconnect the switchbox from the DC power cables, as described in the Part 4: Operations, prior to working on the cables.

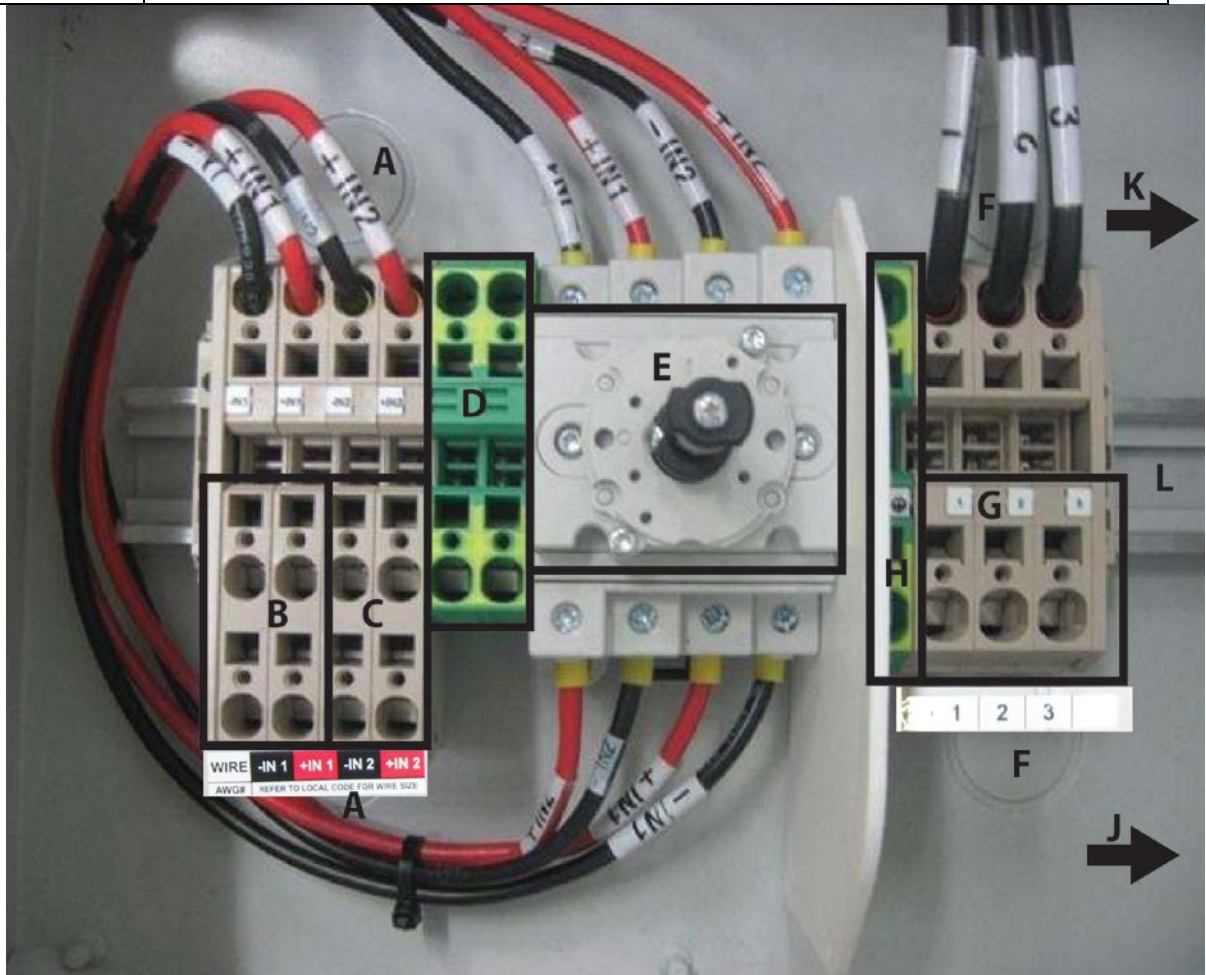

Location Code	Details		Location Code	Details	
A	DC array conduit entry (KOs,3places)	¾ and 1” trade size	F	AC grid conduit entry (KOs, 3 places)	¾” and 1” trade size
B	DC Array MPPT 1 input		G	AC grid output terminals	Single phase: 2W Split phase: 3W (NOTE 2)
C	DC Array MPPT2 input		H	Main Ground	Note 2
D	Array PE Ground	Note 1	J	RS485 Cable conduit entry (KOs)	½” trade size
E	DC Switch		K	Plastic conduit for signal cables	
			L	DIN rails for accessories	

Notes:

1. Terminal accepts up to #20 to #6AWG.
2. Terminal accepts up to #12 to #4AWG.

Figure 2:04 Switchbox Wiring Connections Details (PVI-5000/6000-OUTD-S-US Version)

3.2.3 Initial Electrical Connections PVI-5000-6000-OUTD-US



DANGER:

If the unit has been previously wired and energized, refer to Section 4: Operations for appropriate disconnection and maintenance procedures.

This section describes initial installation procedures for DC and AC wiring connections to the PVI-5000-6000-OUTD-US inverter. This version has an integral DC disconnect switch and associated switchbox.

- Typical system connection for this inverter is shown in 2:05.
- Relevant wiring connections are shown in Figure 2:03 and Figure 2:04.

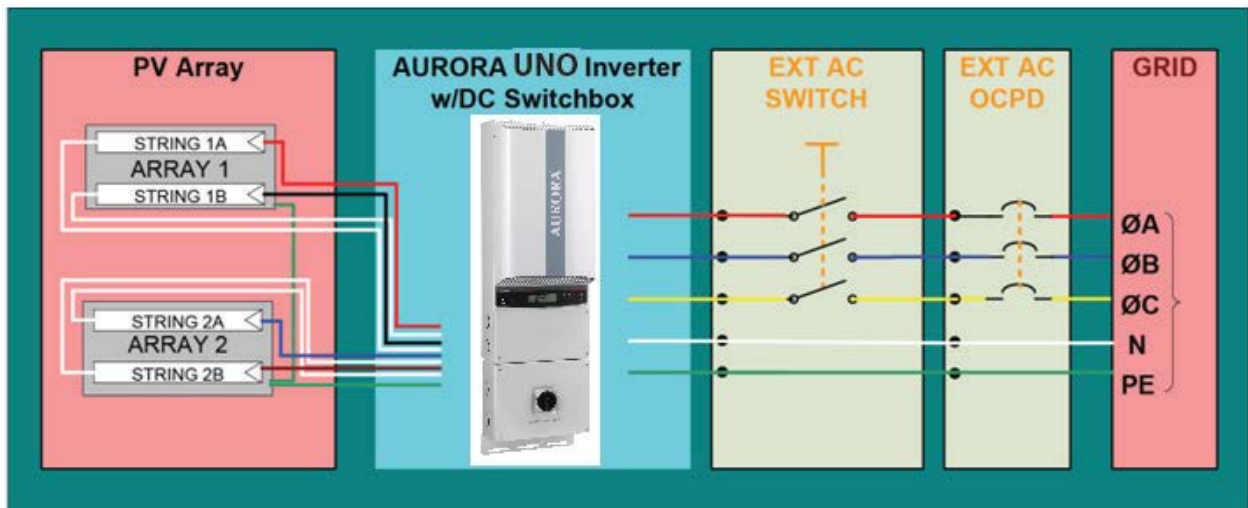

Figure 2:05: Electrical Connection Diagram PVI-5000-6000-OUTD- US

1. Refer to the photo of Figure 2:03 and locate the designated entry locations for the conduits from the DC array and to the AC grid.
2. Make sure the appropriate knockouts are employed for the use specified in order to maintain required spacing between wiring groups.

3.2.4 DC Array Connections



WARNING:

- Before attempting to connect the array wiring be certain the array sizing has been completed to the specific plan associated with the system being installed.
- To eliminate the potential for shock hazard during the connection procedure for the PV array wiring, either open-circuit all PV circuits prior to entry to the inverter and/or cover all panels with dark or opaque material in order to eliminate hazardous voltage at the terminals of the array wiring.

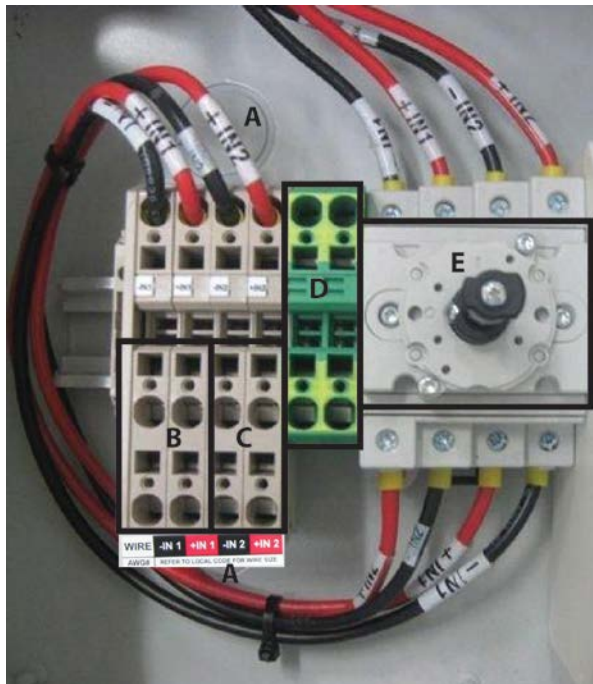

Code	Details	
A	DC array conduit entry (KOs, 3pl)	¾ and 1" trade size
B	DC Array MPPT 1 input	Note 1
C	DC Array MPPT2 input	
D	Array PE Ground	Note 1
E	DC Switch	

Notes:
 1 Terminal accepts up to #20 to #6AWG
 2. Terminal accepts up to #4AWG.

Figure 2:06- DC Array Wiring PVI-5000-6000-OUTD-US

- Refer to Figure 2:06. Locate the incoming DC array wiring at the inverter chassis. Measure the voltage to ensure the array output is non-hazardous.
- Once de-energized, connect the DC wiring to the MPPT1 and MPPT2 array terminals shown in inverter per the specific array design.
- If the array is wired for dual MPPT mode, run separate wires for POS and NEG for each array and ensure no jumpers are installed between the two inputs. See signaling section for more details.
- If the array is designed for the parallel MPPT input mode, ensure channeling jumpers are in place. See signaling section for more details.
- Ensure the input mode switch is in the correct position to match the array design parallel or independent array configuration.

3.2.5 AC Grid Connections



Code	Details	
F	AC grid conduit entry (KOs, 3pl)	¾" and 1" trade size
G	AC grid output terminals	Note 1,2
H	Main Ground 	Note 1
Notes: 1. Terminal accepts up to #4AWG		

Figure 2:07-AC Grid Connection

- Locate the AC grid wiring at the inverter switchbox. Measure the voltage to ensure all connections to the grid have been eliminated and no hazardous voltage is present.



GRID STANDARD										
	208V~ 3-PH-Δ - 3W			240V~ SPLIT-PHASE			480 277V~ 3-PH-Y - 4W			
	TERMINAL WIRE	1 L1*	2 L2*	3 -	1 L1	2 L2	3 N	1 N	2 L1*	3 -
	AWG#	#12-#4 -Copper Wire Only			#12-#4 -Copper Wire Only			#12-#4 -Copper Wire Only		

Figure 2:07b: Grid Standard

3.2.6 Signal Wiring Connections

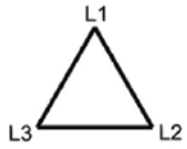

Code	Details	
F	AC grid conduit entry (KOs, 3pl)	¾" and 1" trade size
G	AC grid output terminals	Single phase=2W Split phase= 3W
J	RS485 Cable conduit entry (KOs)	½" trade size
K	Plastic conduit for signal cables	
L	DIN rails for accessories	

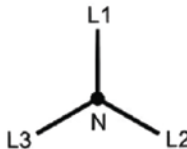
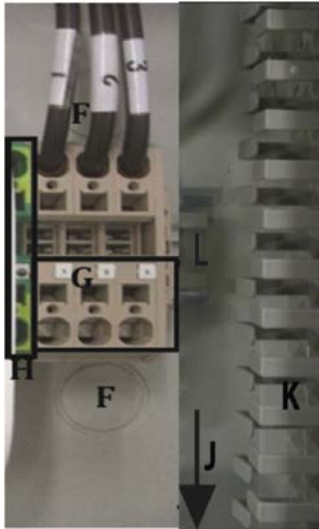
Figure 2:08 Signal Wire Routing

- Route the cables through the switchbox and into the inverter chassis using plastic guide (item K, Figure 2:08.)
- Refer to Figure 2:03, and note the position where the monitoring and alarm cables (if used) enter the chassis.
- Refer to Figure 2:03. Locate the terminals for the alarm and monitoring connections within the chassis.
- Connect alarm cable to the mating connector (in hardware kit) and plug connector into position shown in Figure 2:09.

3.2.6.1 Connect RS485 Monitoring Cable

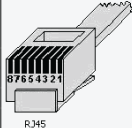
	Pin #	Signal Name	Description	Notes
	1,2,6,8	N/U	-	-
3	+TR	+ Data Line	1	
4	+R	Remote OFF	2	
5	-TR	- Data Line	1	
7	RTN	Signal Return	1	

1. Required for RS485 communication
 2. Required or Remote OFF control
 3. Common reference for logical signals

Table 3: RJ45 Connectors

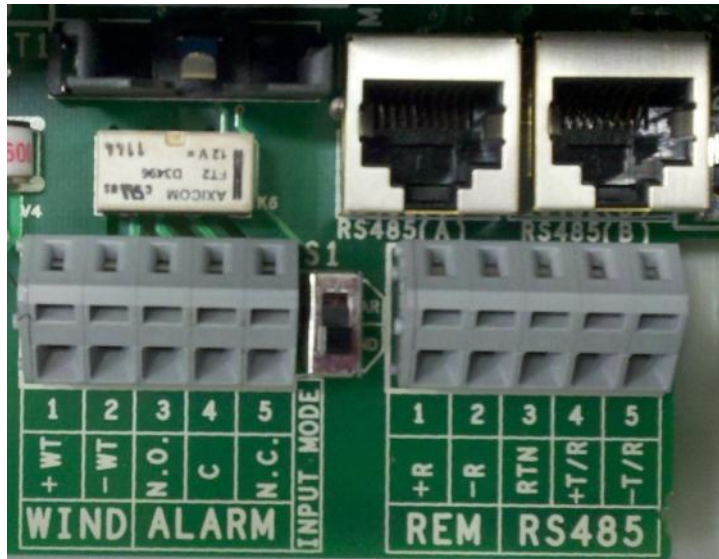

Figure 2:09: Standard RS485 connection

- a. If using CAT5 cable for monitoring connections, connect RJ45 plug to end of cable as shown in Table 3, and plug into RJ45 jack shown in Figure 2:09; a second jack is in parallel to accommodate daisy chaining of communication line to other inverters.
- b. If using standard multi-wire RS-485 cable connect the three RS485 leads (-RTN, +T/R, -T/R) to corresponding points per Figure 2:09.

To connect the wires to the terminal requires releasing the terminal spring clamp. This is accomplished as follows:

- Insert the flat blade of a small screw driver into the connector release hole marked RELEASE in Fig 2:09
- While holding the release open, insert the appropriate wire into the connector hole marked CLAMP in Fig 2.09.
- Hold the wire in place in the clamp and remove the screwdriver from the RELEASE hole to clamp the wire in the terminal.

If multiple inverters are used such that the RS485 cable must be daisy chained to another inverter, then there will be two cables, (i.e., an entering and an existing cable). Each cable will have three wires that must be connected to the terminal block. Strip insulation from all six wires and connect like wire pairs (e.g., RTN+RTN) together by twisting conductors together. Insert the twisted pair of wires into the appropriate terminal in the block (3 places).

2a: 3.3 Main Inverter Connection Board PVI-5000-6000-OUTD-US

The Aurora Inverter is configurable with an independent MPPT for each DC input channel or with the two input DC channels connected in parallel with one MPPT. If the inverter is configured with two independent MPPTs, the max current for each channel shall not exceed 18 Adc (5/6kW) and the power input for the single channel shall not exceed 4kW.



Figure 2:10 Main Inverter Connection Board

Location Indicator	Details		Location Indicator	Details	
A	DC Array: MPPT 1 input	Note 1 below	F	RS485 Bus Connection Via RJ45 Connector	Use with CAT5 Cable
B	DC Array: MPPT2 input	Note 1 below	G	RS485 Bus Connection Via Terminals	
C	AC Grid Output Terminals	Note 2 below	H	RS485 Termination Switch	See Signal Connection Section for more detail
D	Alarm Out Terminals for External Alarm	Note 3 below			
E	In Mode Input Selector Switch (IND or PAR)	Note 3			
Notes:					
1. Terminals accept wire range up to #4AWG (Refer to local code for appropriate wire size); torque to 13in-lb.					
2. Terminals accept wire range up to #4AWG (Refer to local code for appropriate wire size); torque to 13in-lb.					

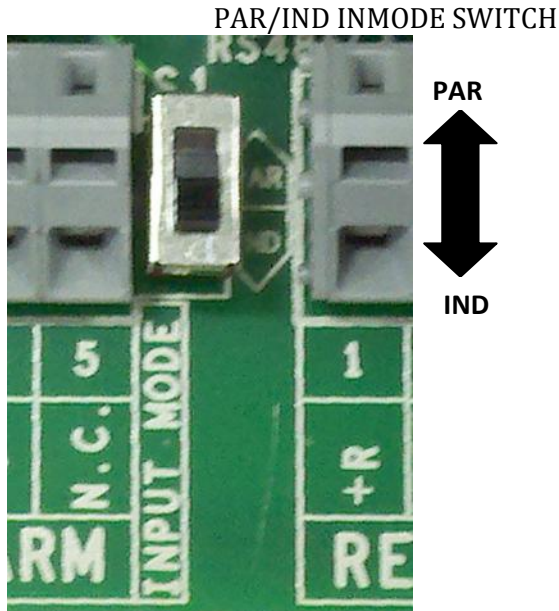

3.3.2 Independent Or Parallel Connection of Dual Inputs

The AURORA Inverters have dual inputs with independent MPPT circuits. The inverter when operated in the dual input mode can optimize two independent arrays. The inverter can also be operated in a single MPPT mode from a single array by connecting the inputs in parallel using jumpers and proper setting of the INMODE switch (see figure 2.10, above). The following sections detail how to connect the inverter in either the INdependent or PARallel mode.

3.3.2.1 Independent Connection

For applications where the two MPPT channels will be used independently:

- Place “INMODE” switch (shown in Figure 2:13a) in the “IND” (default position) position to configure the inverter controls in the independent mode.
- Connect the array to the terminal blocks as shown in Fig 2:13b. Note in this mode up to four strings can be connected (two per input) without need of external combiner fusing.
- After switching the AURORA Inverter to independent mode configuration, re-install the front panel (apply 13.2 in-lbs of torque to each of the 4 screws).

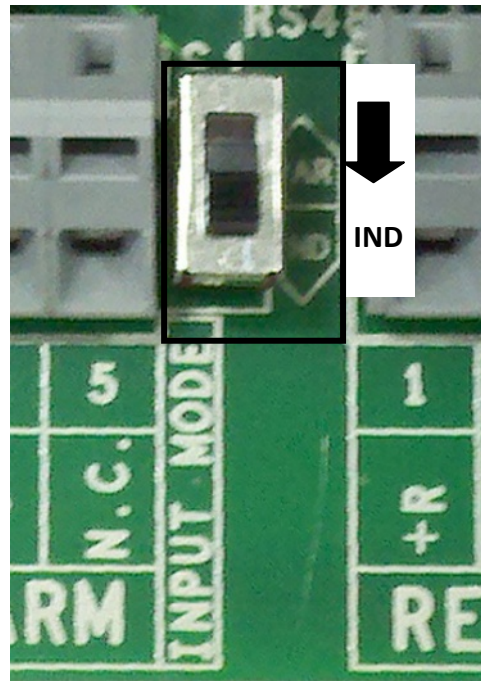
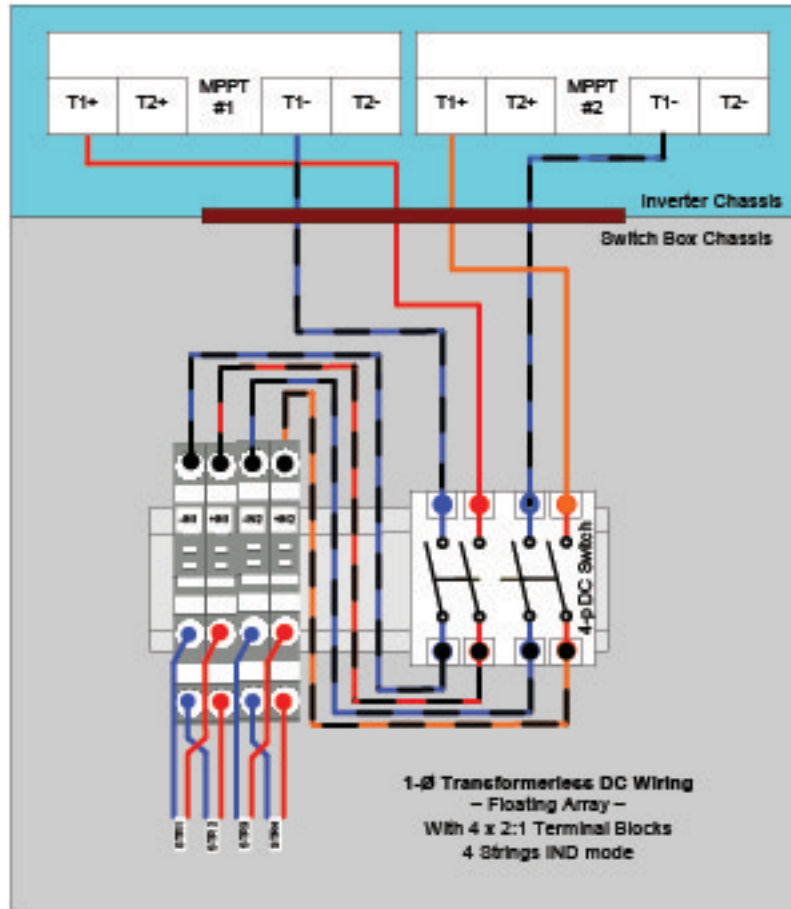

Figure 2:13a: Independent MPPT Configuration Switch



2:13b: Switchbox Jumpers for IND Input Connection

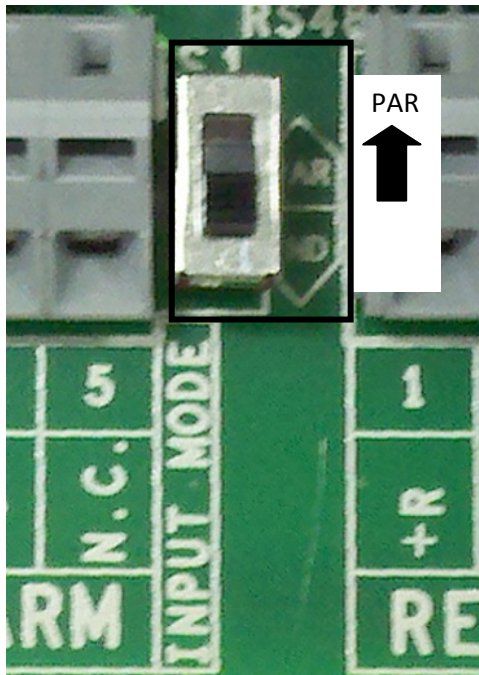

Figure 2:14a: Parallel MPPT Configuration Switch

3.3.2.2 Parallel Connection

To operate the inverter in the single MPPT mode:

- Place INMODE switch (shown in Figure 2:14a) in the “PAR” in order to configure the inverter controls in parallel mode supplied.
- Connect two strings to the input as shown in Fig 2:13b. Note that only two strings can be directly connected to the inverter in this mode; if more than two strings are required, all strings must be combined in an external fused combiner box, or the IND mode must be used.
- Parallel the two MPPT inputs using terminal [-IN1 and -IN2] and [+IN1 and +IN2] as shown in Figure 2:14b using two #10 AWG jumper wires (1 black and 1 red cable) to connect the input.

- After switching the AURORA Inverter to parallel mode configuration, re-install the front panel (apply 13.2 in-lbs of torque to each of the 4 screws)

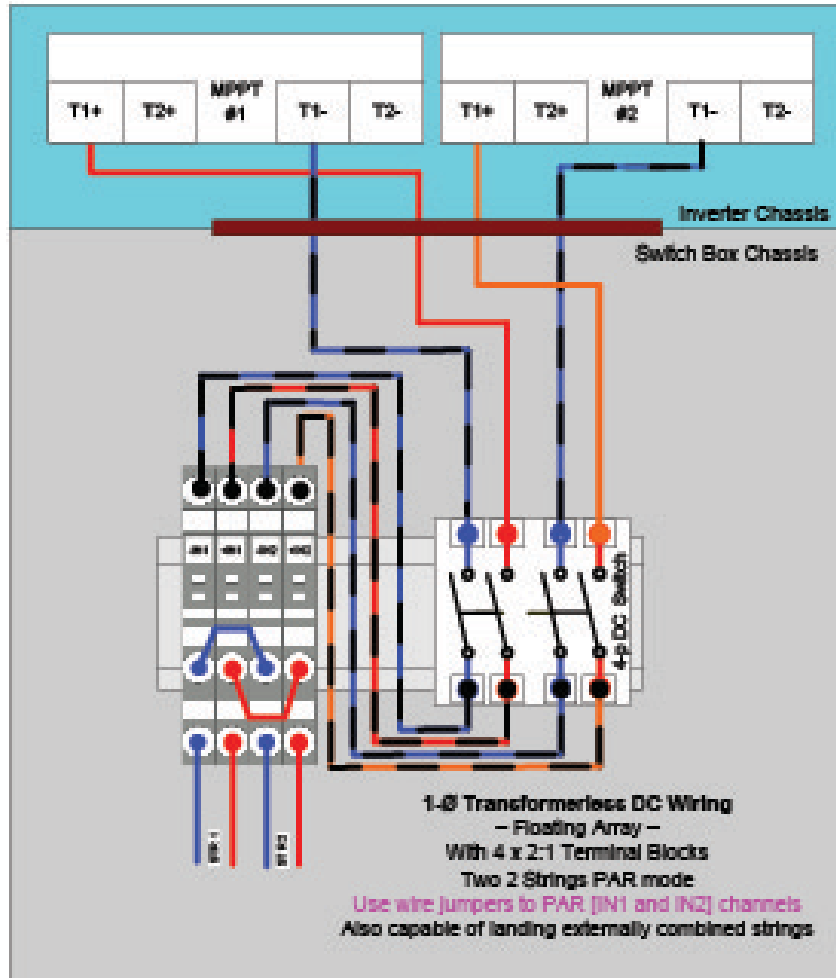

Figure 2:14b: Switchbox Jumpers for Parallel Input Connection

SECTION 4: WIRING DETAILS

4: 1.0 AC AND DC WIRING AND OVER CURRENT PROTECTION

 WARNING	Before selecting the grid standard on the unit, check accurately what is the necessary standard.
--	--

Table 0-2: Wiring Details					
Wire sizing parameter	DC side		Wire sizing parameter	AC side	
	Rating	Comments		Rating	Comments
Array wiring terminals	90° C		Grid wiring terminals	90° C	
Rated temperature Wire Size Range	#12-#4 AWG	Per Manufacturers Rating	Rated temperature Wire Size Range	#12-#4 AWG	Per manufacture rs rating
Tightening Torque	NR	Pressure Clamp	Tightening Torque	NR	Pressure Clamp
Number of wire landings per terminal	2		Number of wire landings per terminal	1	
Allowable conductors per terminal	1		Allowable conductors per terminal	1	
Max Current values	See Technical Data Table		Max Current Values	See Technical Data Table	
RS-485 Terminals	75° C				
	8 in-lb	slotted screws			

4: 1.2 MULTI-UNIT CONFIGURATION

1.2.1 Daisy Chain

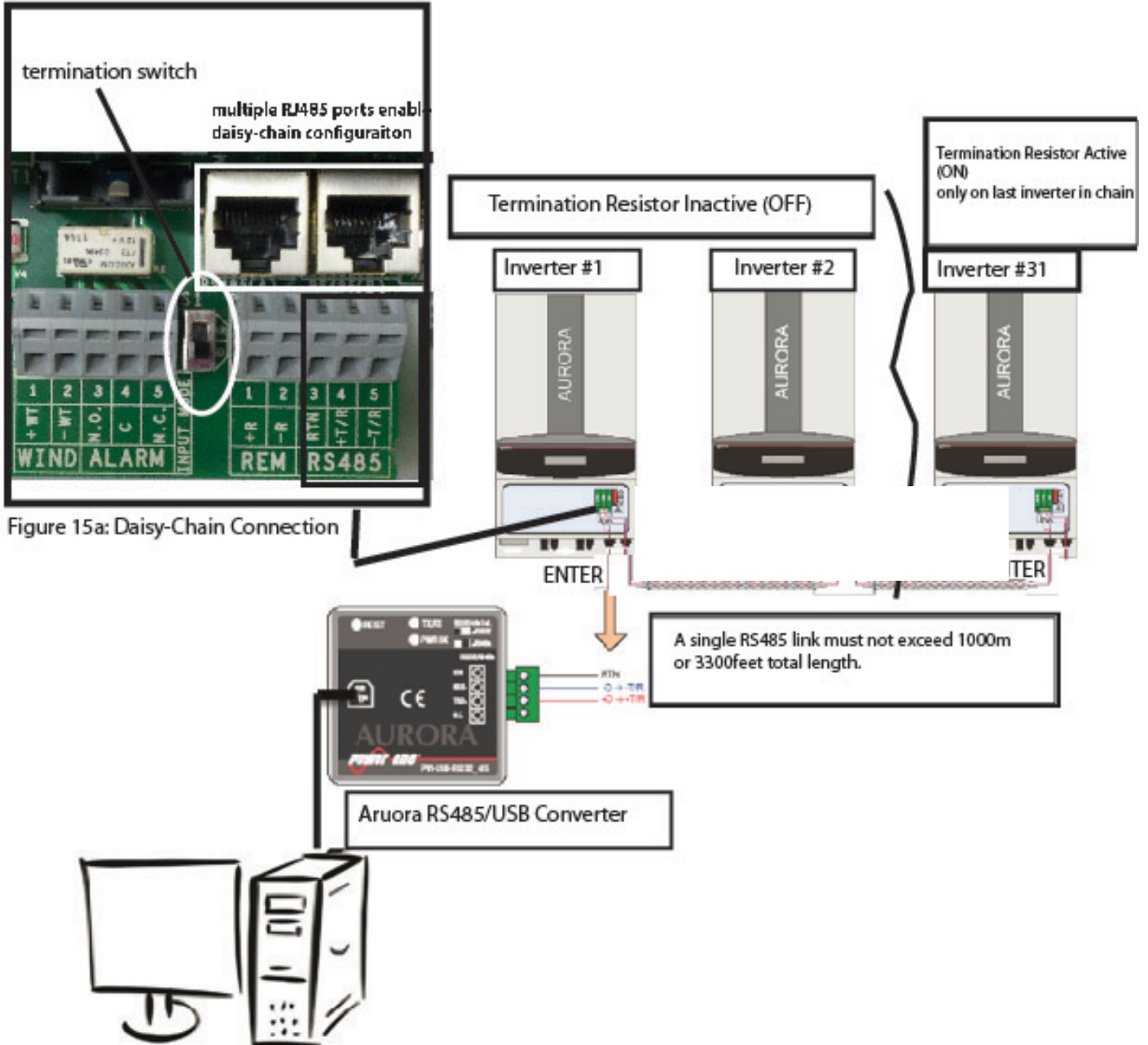

Figure 15a: Daisy-Chain Connection

Figure 15b: Daisy-Chain Configuration

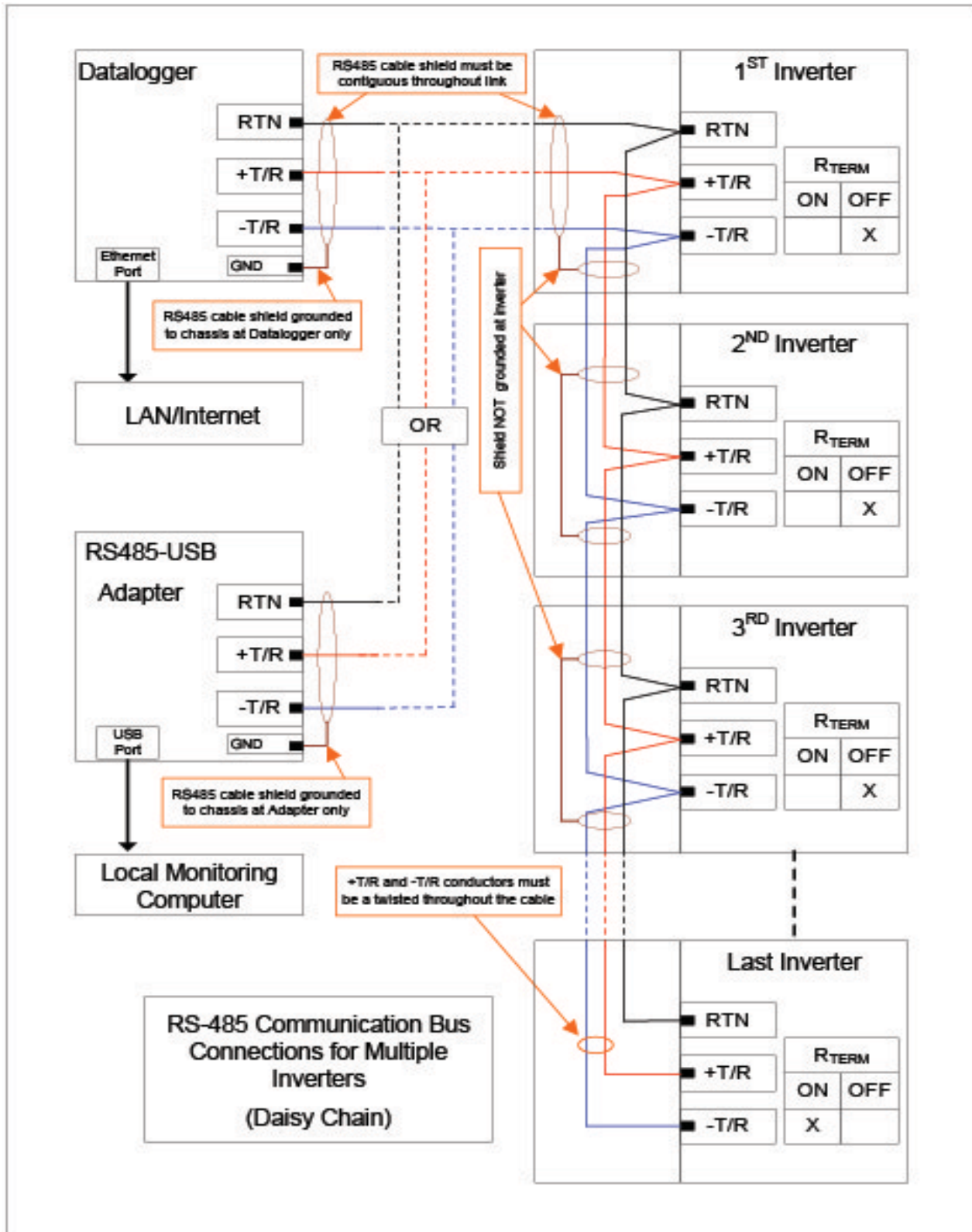

Figure 15c: Daisy Chain Communication wiring.

The RS-485 terminal block or RJ45 connectors can be used to connect a single AURORA Inverter. This terminal block also enables a multi-unit wiring configuration called “daisy-chain configuration”. See shown in Figure 15a and 15b

1.2.1.1 Connection & Cabling

It is possible to connect up to 31 AURORA Inverters in one line.

The recommended length of total communication cable line for all inverters in the system is 1,000 meters [1094 yards] or less.

Depending on the type of computer used, the cable line adaptor can be RS485-RS232 or RS485 to USB.

In order to ensure optimum communication on the RS-485 line, connect the RS-485 converter to a location between the first unit in the “daisy chain” or multi-unit system configuration and the computer.

NOTE: For the termination resistor shown in 15b, the following applies.

- The ON position means the RS485(B) port is inactive.
- The OFF position means the RS485(B) port is active.

STEP 1: Using the appropriate cable, connect all the AURORA Inverter units according to the “daisy-chain” cabling method ENTER- EXIT. Make sure to respect the correspondence between all the signals. See Figure 15a.

STEP 2: Locate the S2 switch. See Figure 15a. Push the switch **up** into the **OFF** position for every inverter in the chain except for the last inverter. The last inverter needs to have the S2 switch pushed **down** into the **ON** position.

4.1.3 ADDRESSING EACH INVERTER

When multiple inverters are connected in a daisy chain, it is necessary to assign a different RS-485 address to each unit.

Selecting this function enables the bus addresses (for the inverter connected to the RS485 communication bus) to be set to an appropriate value. Address values are assigned manually using any value in the range [2 to 64]. Press the **UP** and **DOWN** keys to scroll numbers. **NOTE:** Maximum 31 inverters in a line. (See Part 4: Operations Guide for further details.

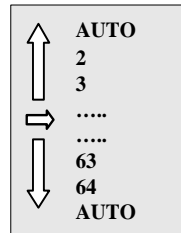

Do not select ‘AUTO’ as the RS485 address in a multi-unit, daisy-chain configuration.

Every AURORA device has a default address of [02] two, with the S2 switch in the OFF position.

Other third party RS485 converters, available on the market can also be used; however, Power-One does not assure correct connection operation since these devices have not undergone extensive specification testing. Also, please note that other commercial devices could require external termination impedance, which is not necessary for AURORA brand RS485 converters.

The diagram in Figure 2:15c shows how to connect multiple units into a daisy-chain configuration.

SOFTWARE:

Included in the shipment of the AURORA Inverter is the AURORA Installer CD.

The installation of this software is optional as most of this functionality can be done through the inverter display.

If it is desired to view the basic monitoring and setting options from a computer screen, follow the installation instructions in 1.3.1:

1.3.1 Installation Instructions:

Remove the disk from its cover. Insert the disk into the computer to install the desired program onto the computer.

Connect the adapter from inverter to the computer. Depending on the configuration determine the type of converter needed (RS485-RS232 or RS485-USB).

PART 4: OPERATIONS GUIDE

4: 0.1 COMMISSIONING

The procedure for commissioning AURORA Inverter is as follows:

- 1) Set the inverter's DC disconnect switch (external or part of switchbox version) to ON.
- 2) Set the AC disconnect switch (external) to the inverter to ON.

NOTE: There is no specific order for closing the two switches.

- 3) Once both switches are closed, the inverter starts the grid connection sequence. This routine is indicated by the flashing green LED labelled POWER over the display.

This routine may take from 30 seconds up to several minutes, depending on grid condition. Three screens are shown in sequence on the LCD display during this routine:

- Grid voltage value and status compared to specified values (within/outside range).
 - Grid frequency value and status compared to specified values (within/outside range).
- 4) When the connection sequence is completed the AURORA Inverter starts operating. Proper operation is indicated by a warning sound and the power LED light is steadily green.
 - 5) If the grid check routine does not give a positive result, the unit will repeat the procedure until all grid voltage; frequency parameters and grid configuration are found or changed to be within the specified range. During this process, the green LED will keep flashing.

4.1.0 INVERTER START-UP and OPERATION

 WARNING	<ul style="list-style-type: none"> Do not place any items on the AURORA Inverter during operation. Do not touch the heat sink when the inverter is operating, as some parts may be hot and cause burns.
--	---

1.1 NORMAL START- UP PROCEDURE

Front Panel LED Operation			
LED	Label	LED Status	
		LIT	UNLIT
1	POWER	Inverter power on	Inverter power off
2	ALARM	Active alarm	Normal operation
3	GFI	Active ground fault	Normal operation



Name of Key	Function Description
ENTER	Moves cursor from existing menu location to new menu location
ESC	Escapes action of previous ENTER
UP	Moves cursor upward in menu tree
DOWN	Moves cursor downward in menu tree

The green 'Power' LED indicates that the AURORA UNO Inverter is operating correctly.

**Power-One Initializing...
Please wait...**

Missing Grid

If DC = > 200V

If DC = < 200V

Initializing stops until grid is found or settings are changed to match voltage.
Possible error codes:
W007: Grid Under Frequency
W006: Grid Over Frequency
W005: Output Under Voltage
W004: Output Over Voltage

**Next connections..
2 sec**

Waiting Sun...

Inverter is waiting for the sun/wind.
Possible error codes:
E002: Input Under Voltage
W011: Sun Low
E013: Wrong Mode (PAR/IND)

Unit cycles through various screens while connecting.

 = Inverter OK. Cycles through Inverter statistics

 = Error/Alert/Warning
May see any of the remaining error codes

Fault Description

Ground Fault

The yellow 'FAULT' LED indicates that the AURORA Inverter has detected a fault condition. A fault description will appear on the display. See troubleshooting section of this manual or contact Power-One Technical Support.

Red GFI Ground Fault on the DC side of the system.
Press ESC to restart
See troubleshooting section to help or contact Power-One Technical Support.

Depending on the DC input voltage present, the inverter behaves as follows:

- a) When the inverter is switched ON, it will start as soon as the input voltage value of 120 Vdc is reached.
- b) The inverter will display the message 'Waiting Sun' until the input voltage exceeds the Vin start setting.
- c) When the Vin start value is exceeded, the inverter will connect to the grid if it is identified or it will display the message "missing grid" if the grid is not connected.
- d) The inverter will remain connected to the grid if the input voltage is between 70% of the Vin start set and 600 Vdc. If the input voltage value is outside this range, the inverter disconnects itself from the grid.

1.2 SHUT-DOWN PROCEDURE

There are three options for shutting down the inverter:

- 1) Disconnect the DC and the AC grid, by disconnecting its associated switches (in any order). The inverter will shut down within a few seconds necessary to discharge the internal capacitors.
- 2) Disconnect the DC input by turning-off the associated disconnect switch and waiting for the UV port time out.
- 3) Disconnect the grid, by turning-off its associated disconnect switch and reduce DC input to less than 90 Vdc.

1.3 POWER-DOWN PROCEDURES

Once the inverter is wired and connected to the grid use the following procedures to disconnect for maintenance.

	WARNING	Before performing any operation on the switchbox power input, ALWAYS perform the appropriate disconnection procedure outlined below.
--	----------------	--

1.3.1 Disconnection Of AURORA Inverters



Figure 4:02: Location of Front Access Panels

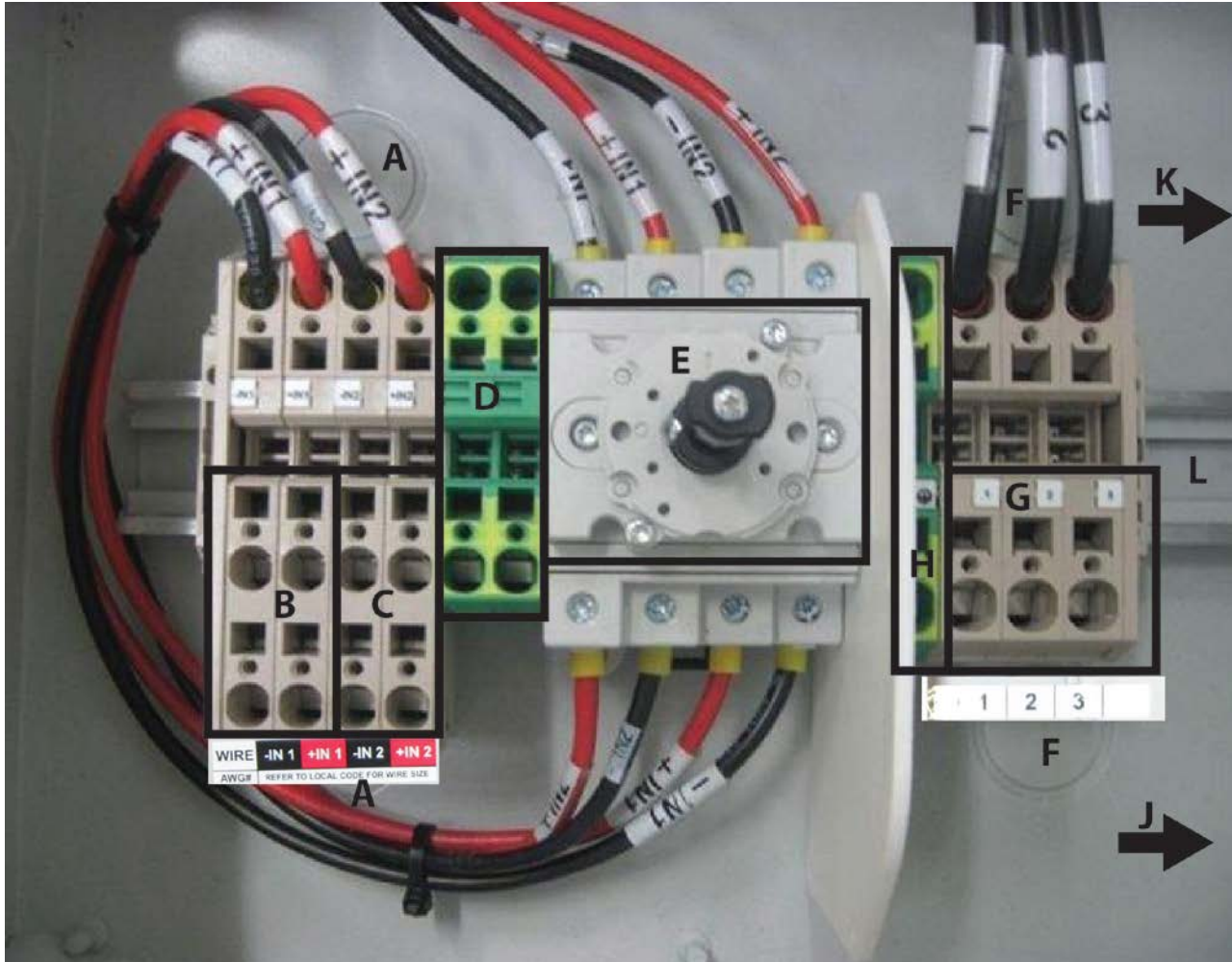

Location Code	Details		Location Code	Details	
A	DC array conduit entry (KOs,3pl)	¾ and 1" trade size	F	AC grid conduit entry (KOs, 3pl)	¾" and 1" trade size
B	DC Array MPPT 1 input	Note 1	G	AC grid output terminals	Note 2 Reference Chart 2.08 AC Grid Connections
C	DC Array MPPT 2 input		H	Main Ground 	Note 2
D	Array PE Ground	Note 1	J	RS485 Cable conduit entry (KOs)	½" trade size
E	DC Switch		K	Plastic conduit for signal cables	
			L	DIN rail	
Notes:					
	3.	Terminal accepts up to #20 to #6AWG			
	4.	Terminal accepts up to #12 to #4AWG			

Figure 4:03: PVI-5000-6000-OUTD-US-Wiring Connection Details

Refer to Figure 4:03 Wiring Connection Details for the following procedure:

Step 1: Disconnect from the AC Grid by one of the following methods:

- a. Turn-OFF the external AC switch
- b. Turn-OFF the Over Current Protection Device (circuit breaker)

Step 2: Disconnect the inverter from the PV array by turning OFF the external DC disconnect switch.

Step 3: Remove the inverter cover (Figure 4:02). Using a voltmeter, check voltage levels at the DC input terminals and the AC output cables to ensure no hazardous voltages are present.

NOTE: The above procedure disconnects power from the main inverter chassis, but not the DC Switch Box.

4: 2.0 OPERATIONS: USER INTERFACE, MONITORING AND DATA TRANSMISSION

2.1 USER INTERFACE MODE

Normally, the AURORA Inverter operates automatically and needs no particular supervision. When solar radiation is not enough to generate power for the grid (for example: at night), AURORA Inverter disconnects automatically and goes into a standby mode.

The operating cycle resumes automatically when sufficient sunlight becomes available.

The AURORA Inverter provides operational data to the user through the following instruments:

1. LED Indicator lights
2. LCD display
3. Digital data transmission is via a dedicated RS-485 serial port using AURORA Inverter Protocol and a PC or a data logger equipped with an RS-485 port collects data. If an RS-485 line is used, it may be convenient to use the AURORA USB/RS-485_232 serial interface converter (model number PVI-USB-RS485_232).

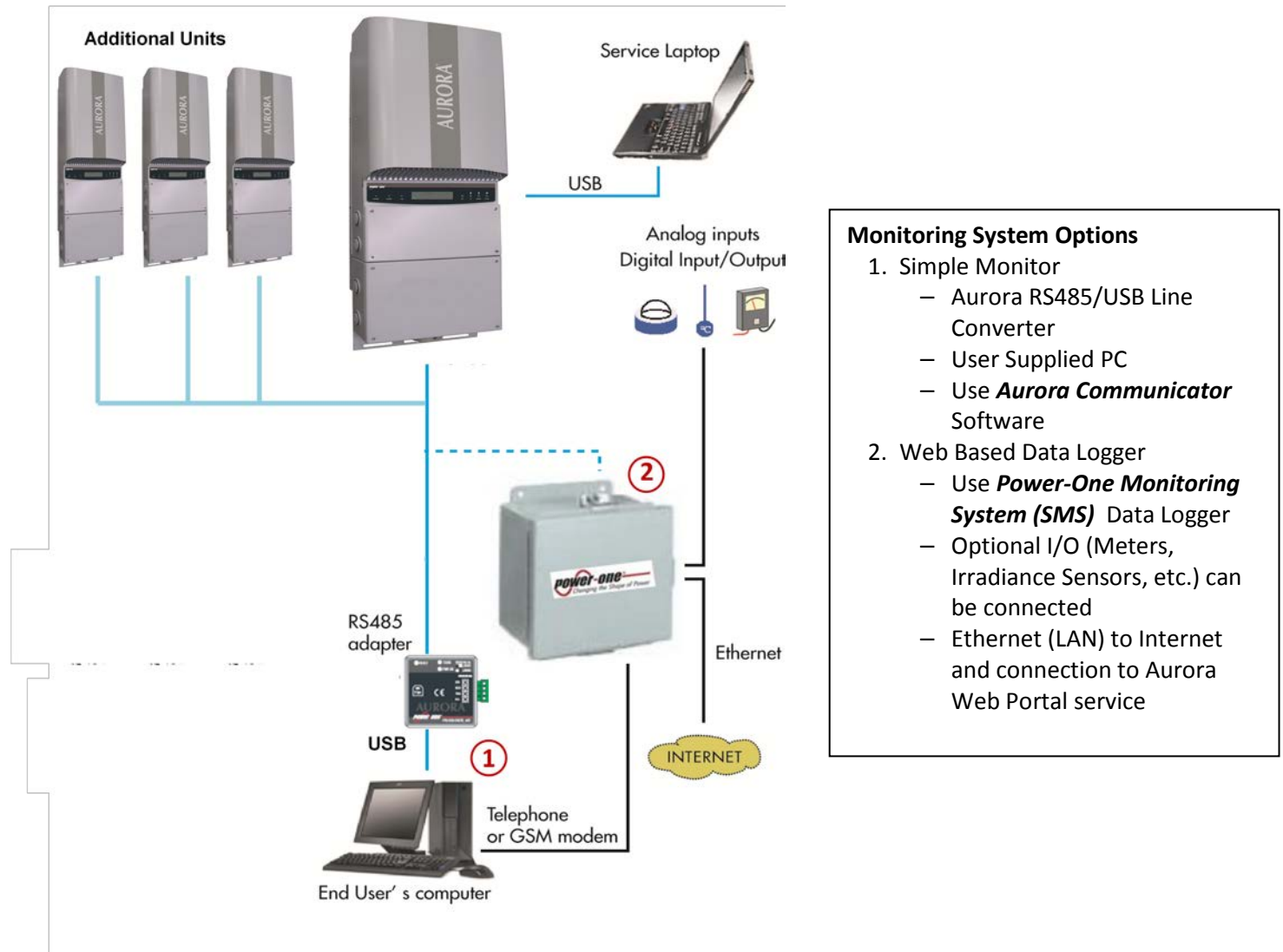

Figure 04:4- Data Transmission Options

2.2 DATA TYPES AVAILABLE

AURORA Inverter provides two types of data that can be collected using the display and/or the appropriate interface software.

2.2.1 Real-Time Operational Data

Real-time operational data can be transmitted on demand through the communication lines and are not stored inside the inverter. The free AURORA Communicator software (included on the installation CD) may be used to transmit data to a PC. Please check the Power-One website at www.power-one.com for the latest updated version.

The following data is available via the RS-485 link:

- Grid voltage
- Grid current
- Grid frequency
- Power transferred to the grid
- Voltage of photovoltaic array 1
- Current of photovoltaic array 1
- Voltage of photovoltaic array 2
- Current of photovoltaic array 2
- Serial Number/Code
- Week of production

- Firmware revision code
- Daily energy
- Leakage current of the system
- Total energy
- Partial energy
- Mean grid voltage
- Insulation resistance
- Leakage current to ground
- Date, time

2.2.2 Data Logged Internally

Power-One's AURORA Vision stores the following data internally:

- Total and partial counter of grid connection time.
- Total and partial counter of energy transferred to the grid.
- Daily Energy Production (365 values).
- Energy transferred to the grid every 10 seconds for the last 8,640 periods of 10 seconds (which on average cover more than 2 days of logged data).
- Last 100 fault conditions with error code and time stamp.
- Last 100 changes to grid connection parameters with parameter code and new value.

The first two types of data are displayed on the LCD display and through the RS-485 interface, while all other data can be displayed only through the RS-485 interface.

2.3 LED INDICATORS

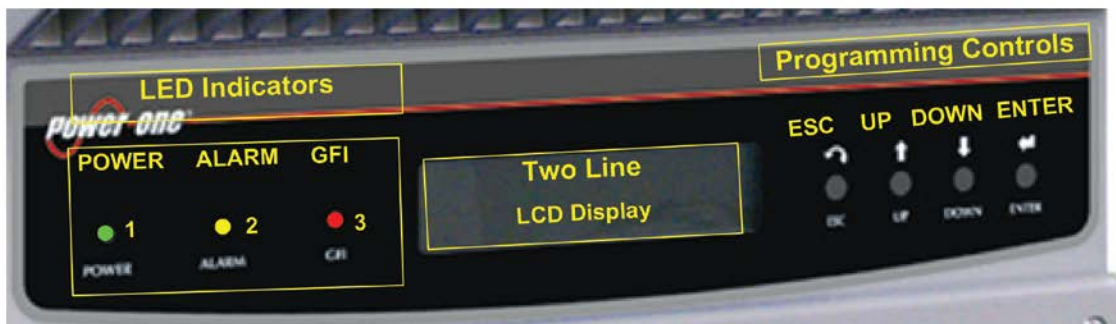



Figure 4:05: Location of the buttons and LEDs

There are three LEDs on the left side of the display:

1. The green 'Power' LED indicates that AURORA Inverter is operating correctly.
This LED flashes upon start-up, during the grid check routine. If a correct grid voltage is detected and solar radiation is strong enough to start-up the unit, the LED stays on steady. If not, the LED keeps flashing until solar radiation becomes strong enough to start-up the inverter. In this condition, the display will read '**Waiting Sun....**'
2. The yellow 'FAULT' LED indicates that the AURORA Inverter has detected a fault condition. A fault description will appear on the display.
3. The red 'GFI' (ground fault) LED indicates that AURORA Inverter is detecting a ground fault in the DC side of the photovoltaic system. When this kind of fault is detected, the AURORA Inverter disconnects from the grid and the corresponding fault indication appears on the LCD display. AURORA Inverter remains in this condition until the operator presses the ESC key to re-start the grid connection sequence. If pressing the ESC key doesn't clear the ground fault check the ground-fault, fuse located in the switchbox. If AURORA Inverter does not reconnect to the grid, contact Power-One Technical Service.

 DANGER:	<p>Normally grounded conductors may be ungrounded and energized when a ground-fault is indicated.</p> <ul style="list-style-type: none"> • Risk of electric shock • Test before touching • Work on the AURORA Inverter must be carried out by qualified personnel.
--	---

The following table shows all the possible LED-signalling indications related to the operational status of AURORA Inverter.

Key:

 LED on

 LED off

 LED flashing

 Any of the above conditions

	LED STATUS	OPERATIONAL STATUS	NOTES
1	1: green: <input checked="" type="checkbox"/> 2: yellow: <input checked="" type="checkbox"/> 3: red: <input checked="" type="checkbox"/>	AURORA self-disconnects during night-time	Input voltage less than 90 Vdc at both inputs
2	1: green: <input checked="" type="checkbox"/> 2: yellow: <input checked="" type="checkbox"/> 3: red: <input checked="" type="checkbox"/>	AURORA Inverter initialization, settings loading, and waiting for grid check	It is in transition status while operating conditions are being checked.
3	1: green: <input type="checkbox"/> 2: yellow: <input checked="" type="checkbox"/> 3: red: <input checked="" type="checkbox"/>	AURORA Inverter is powering the grid	Standard machine operation (search for maximum power point or constant voltage)
4	1: green: <input type="checkbox"/> 2: yellow: <input type="checkbox"/> 3: red: <input type="checkbox"/>	System insulation device faulty	Leakage to ground found
5	1: green: <input checked="" type="checkbox"/> 2: yellow: <input type="checkbox"/> 3: red: <input checked="" type="checkbox"/>	Defect - fault!!!	The fault can be inside or outside the inverter. See the alarm appearing on the LCD display.
6	1: green: <input checked="" type="checkbox"/> 2: yellow: <input checked="" type="checkbox"/> 3: red: <input checked="" type="checkbox"/>	Installation Phase: AURORA Inverter is disconnected from the grid.	During installation, it indicates set-up phase of the address for RS-485 communication.
7	1: green: <input checked="" type="checkbox"/> 2: yellow: <input type="checkbox"/> 3: red: <input checked="" type="checkbox"/>	Grid disconnection	Indicates a missing grid condition



NOTE: Inverter status is indicated by the corresponding LED turning to a steady ON-condition or flashing, and by a message on the AURORA LCD displaying a description of the existing operation or fault condition (see the following sections).

2.4 MESSAGES AND ERROR CODES

 <p>DANGER:</p>	<p>Normally grounded conductors may be ungrounded and energized when a ground-fault is indicated.</p> <ul style="list-style-type: none"> • Risk of electric shock • Test before touching • Work on the AURORA Inverter must be carried out by qualified personnel.
---	---

The system status is identified through message or error signals displayed on the LCD display. The following tables briefly describe the two types of signals which may be displayed.

- **MESSAGES** identify the current status AURORA Inverter status. Messages do not relate to a fault. When a **(W)** with a number after it appears in the display, it indicates a **WARNING CODE** and is usually cleared through an orderly shutdown/re-set or a self-corrective action performed by the inverter. See the **(W)** codes in the following table.
- **ALARMS** or **(E)** codes identify a possible equipment failure, fault or incorrect inverter setting/ configuration. However, some of the **(E)** codes may require contacting Power-One Technical Support to assist in correcting a fault. Any and all attempts to correct or clear a fault must be performed by qualified personnel. Typically, the **(E)** can be cleared once the cause or fault is removed. Some of the **(E)** codes, (INT. Error) as indicated in the table below, may indicate a fatal error and require the support of Power-One Technical Support for diagnostics support. The appearance of an alarm signal will be managed as much as possible by AURORA Vision or, in case this is not possible, AURORA Vision will supply all the necessary information to perform the maintenance operations and to fix the fault on the equipment or system. See the **(E)** lines in the following table.

Message	Error Warning	Error Type	Description	Message	Error Warning	Error Type	Description
Sun Low	W001	//	Input Voltage under Vstart threshold	Int.Error	//	E022	Autotest Timeout
Input OC	//	E001	Input Overcurrent	Int.Error	//	E023	Dc-Injection Error
Input UV	W002	//	Input Undervoltage	Grid OV	W004	//	Output Overvoltage
Input OV	//	E002	Input Overvoltage	Grid UV	W005	//	Output Undervoltage
Int.Error	//	E003	No parameters	Grid OF	W006	//	Output Overfrequency
Bulk OV	//	E004	Bulk Overvoltage	Grid UF	W007	//	Output Underfrequency
Int.Error	//	E005	Communication Error	Z Grid HI	W008	//	Z grid out of range
Out OC	//	E006	Output Overcurrent	Int.Error	//	E024	Unknown Error -
Int. Error	//	E007	IGBT Sat	-----	//	E025	Riso Low (Log Only)
Sun Low	W011	//	Bulk Undervoltage	Int.Error	//	E026	Vref Error
Int.Error	//	E009	Internal Error	Int.Error	//	E027	Vgrid Measures Fault
Grid Fail	W003	//	Grid Fail	Int.Error	//	E028	Fgrid Measures Fault
Int.Error	//	E010	Bulk Low	Int.Error	//	E029	Zgrid Measures Fault
Int.Error	//	E011	Ramp Fail				
Over Temp.	//	E014	Overtemperature	Int.Error	//	E030	Ileak Measures Fault
Cap. Fault	//	E015	Bulk Capacitor Fail	Int.Error	//	E031	Wrong V Measure
DC/DC Fail	//	E012	DcDc Error revealed by inverter	Int.Error	//	E032	Wrong I Measure
Wrong	//	E013	Wrong Input setting	Empty	W009	//	No wind table (only wind -

Mode			(Single instead of dual) or wrong grounding mode	Table			W versions)
Inv. Fail	//	E016	Inverter fail revealed by DcDc	Fan Fail	W010	//	Fan Fail (No disconnection)
Int.Error	//	E017	Start Timeout	Int.Error	//	E033	UnderTemperature
Ground F.	//	E018	I leak fail		//	E034	Interlock Fail (Not Used)
Int.Error	//	E019	Ileak Sensor fail		//	E035	Remote Off
Int.Error	//	E020	DcDc relay fail		//	E036	Vout Avg Error
Int.Error	//	E021	Inverter relay fail		W012	//	Clock Battery Low (No disconnection)
					W013	//	Clock Failure (No disconnection)

Table 4:01 Messages and Error Codes

2.5 LCD DISPLAY

2.5.1 Connection of the System to the Grid

A two-line LCD display is located on the front panel. It shows the following:

- ✓ Inverter operating status and statistics;
- ✓ Service messages for the operator;
- ✓ Alarm and fault messages.

During regular operation, the display will cycle through available data. The display changes to a different screen every 5 seconds, or screens may be scrolled manually by pressing the UP (2nd key from display) and DOWN keys (3rd key from display).

A NOTE ON DISPLAY KEY OPERATION:

During regular operation, the display will cycle through available data. The display changes to a different screen every 5 seconds, or screens may be scrolled manually by pressing the UP (2nd key from display) and DOWN keys (3rd key from display). To return to the preceding menu, press the ESC key (1st key from display).

Activation of cyclical scrolling is indicated by the 2 arrows in the top left corner of the display (Figure. A).

Scrolling can be blocked by pressing the ENTER key (4th key from display). A padlock symbol will appear (Figure. A).

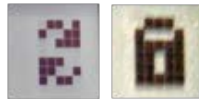
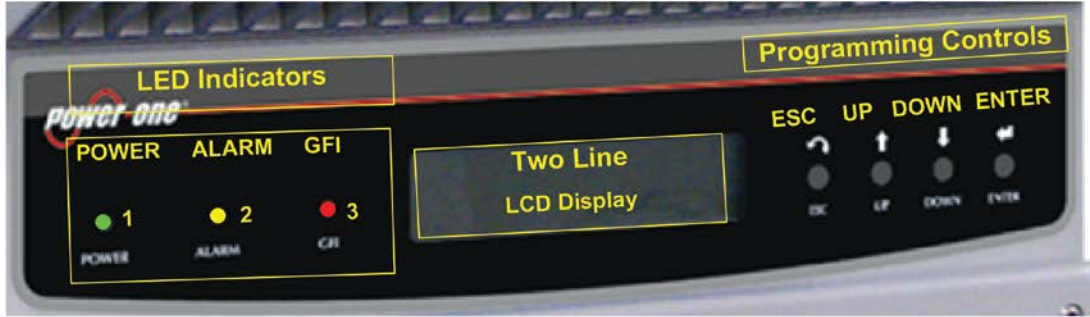

Figure A

Figure A- Display Key Operation



1) These two screens are displayed at inverter start-up:



2) The following screens may appear while waiting for the connection to be established:



- While the system checks for grid connection to be established ('Missing Grid'), the yellow LED next to the display turns on steady, while the green LED flashes.
- When waiting for solar radiation ('Waiting Sun'), the green LED turns on steady.
- As soon as the 'Missing Grid' and 'Waiting Sun' conditions are met successfully, the inverter is connected.

3) This display shows the time (seconds) remaining to complete the output voltage and frequency values check.



4) This display shows the instant output voltage value and whether it is within/outside range.



5) This displays the instant output frequency value and whether it is within/outside range.

6) If the measured instant values of voltage (point 4) and frequency (point 5) are outside the allowed range, the following screens are scrolled alternately:

Next connections (screen 3) → Vgrid (screen 4) → Fgrid (screen 5)

2.5.1.1 Field Adjustments for Frequency and Disconnection Time

	Be fully aware of the field dynamics and how a frequency range change would impact the field. Improper values entered could cause the inverter to shut down.
	A warning will occur if an improper number is entered the Aurora Manager_TL

Warning:	Changes to the frequency range and timeout parameters MUST be done by a qualified contractor or authorized personnel.
-----------------	---

This inverter has been factory programmed to automatically disconnect from the utility distribution system at a default frequency setting of $f > 60.5\text{Hz}$ and $f < 59.3\text{Hz}$.

For the inverter to operate at the frequency condition and timeout parameters shown below, please follow steps 1 and 2.

Conditions:

<u>Frequency Condition</u>	<u>Disconnect Time Interval</u>
$f > 60.5\text{ Hz}$	within 10 cycles (160ms)
$f = 57\text{ Hz}$	within 300 seconds
$f < 57\text{ Hz}$	within 10 cycles (160ms)

Steps to follow:

1. Install the AURORA TL Manager onto a computer/laptop. This software is on the CD that accompanied this manual.
2. Change the frequency range and timeout parameters to the below values. See Figure 4:06a for screen capture example.

Grid Parameters:			
Required Setting	Symbol	Definition	Action
$f >$ to 60.5 Hz	$f >$	Indicates the value of the maximum allowable over-frequency setpoint . For a UL1741/ IEEE1547 certified inverter the default value is 60.5Hz	Setting $f >$ to 60.5Hz causes grid disconnect within 160ms when line frequency rises above 60.5Hz
$f >>$ to 60.5 Hz	$f >>$	Indicates absolute maximum allowable OF setpoint .	Setting $f >$ to 60.5Hz causes grid disconnect within 160ms when line frequency rises above 60.5Hz
$f <$ to 59.30 Hz	$f <$	Indicates the value of the adjustable UF set-point . For line frequency below this value, a disconnect timer is set to count down the ride through time[Timeout $f <$] If the timer reaches full count the inverter will be disconnected from the grid. If the measured frequency rises above this value, the disconnect timer is reset.	This setting indicates the disconnect timer will initiate at 59.3Hz
$f <<$ to 57 Hz	$f <<$	Indicates the absolute minimum allowable under-frequency condition allowable on a UL1741/IEEE1547 certified inverter	This setting will cause the inverter to disconnect from the grid anytime when line frequency falls below 57Hz

Timeout f > to 160 ms	Timeout f >	Indicates the timeout associated with an over-frequency condition (f>60.5Hz)	This setting will cause the inverter to disconnect from the grid anytime when line frequency rises above 60.5Hz
Timeout f< to 300000 ms	Timeout f<	Indicates the value of the timeout associated with an under-frequency condition below the value of parameter f<	The inverter will operate for up to 300000ms (5min) for an under-frequency below the f< set-point as long as the frequency does not fall below the f<< setpoint

Frequency range and timeout parameters

The parameters below are accessible from the software. These are default voltage settings and must not under any circumstances be modified.

Grid Parameters:			
Required Setting	Symbol	Definition	Action
DEFAULT	U>	Indicates the value of the maximum allowable adjustable over-voltage set point	DO NOT CHANGE
DEFAULT	U>>	Indicates the value of the absolute maximum allowable over-voltage set point	DO NOT CHANGE
DEFAULT	U<	Indicates the value of the minimum allowable adjustable under-voltage set point	DO NOT CHANGE
DEFAULT	U<<	Indicates the value of the absolute minimum allowable under-voltage set point	DO NOT CHANGE

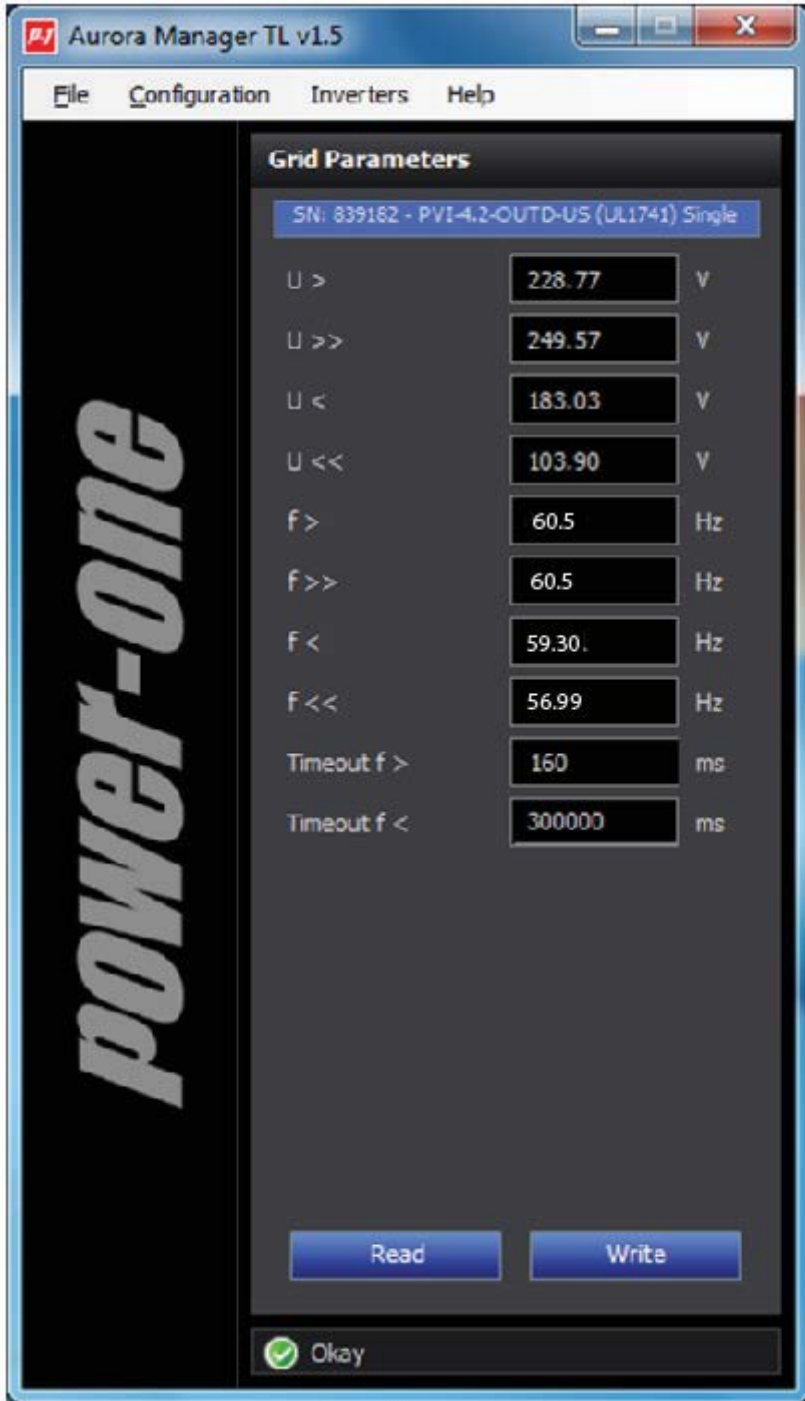

Figure 4:06a: Screen Capture of AURORA TL Manager with Changed Frequency and Timeout Values

Once the frequency range and timeout values have been changed:

- 1 Power down the unit (both AC and DC power) to save all changes.
- 2 Apply the appropriate label to the unit.

Note: When the frequency and timeout is changed, completely power down the inverter turning OFF both AC and DC power in order to preserve the new data.

2.5.1.2 Apply Label:

If the inverter's frequency range is field adjusted to changed to disconnect in the under the conditions in Section 2.5.1.1.2, apply the following label to the external, side panel of inverter to indicate frequency change. See Figure 4:06b

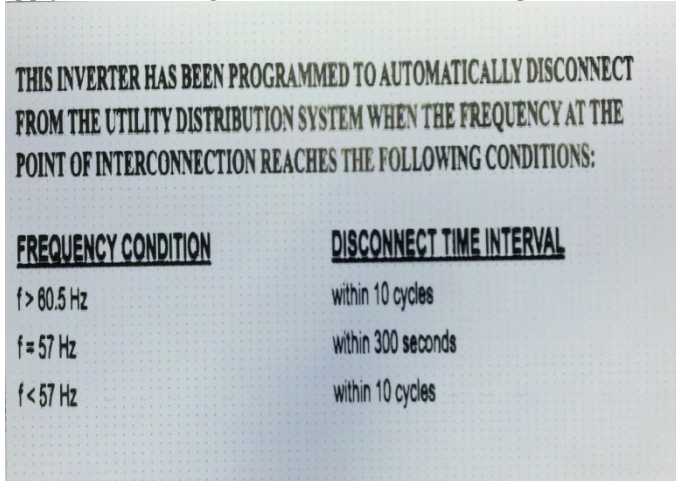

Figure 4.06b: Notification Label: Frequency Range and Timeout Parameter Change

Note:	To comply with safety regulations, this label must be placed on the inverter immediately following the change to the frequency range.
--------------	---

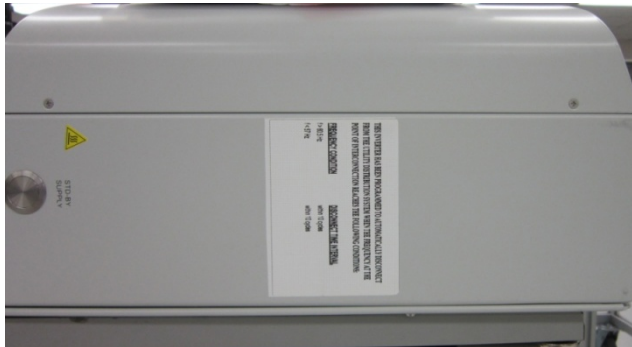
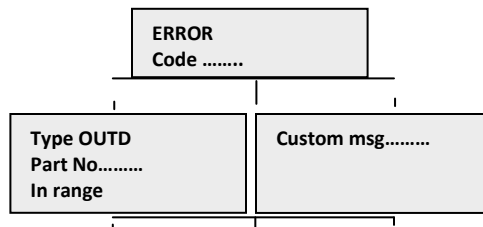

Figure 4:08: Location of Notification Label: Frequency Range Change

2.5.2 Error Messages

After the connection is established, the inverter runs a test cycle. If the wrong data is found, the cycle is interrupted and an error code is displayed. Please refer to Table 4:01 for error codes and their meanings.

To customize the message shown on the display, you must carry out the programming procedure described in Section 2.5.25, 'Alarm Message'. The system will continue to cycle through the following screens until the error has been rectified:



```
S/N .....  
Firmware.....  
In range
```

Once the error is cleared, the inverter resets all functions in progress and re-starts the connection (Section 1.2):

- Missing grid
- Waiting sun

2.5.3 First Phase- Electric Parameter Check

1A) If the measurements taken previously (see section 2.1) are found to be correct, the system will proceed to the next checks. The 12 screens outlined below are shown alternately as listed in the Note A: 'A FEW POINTERS ON DISPLAY KEY OPERATION'.

```
Type OUTD  
PN-----
```

2A) This display shows the inverter serial number and firmware revision level.

```
S/N----- xxxxxx  
FW rel. C.0.1.1
```

3A)

```
E-da  0 Wh  
$-da  0.0 EUR
```

- E-da: Daily energy output.
- \$-da: Daily energy savings. The value is expressed in the set currency.

4A)

```
E-tot  -----  
E-par  0 KWh EUR
```

- E-tot: Total energy output (since first installation).
- E-par : Partial energy output during the period selected by us.

5A)

```
P-out  0 W  
T-boost1  - °C
```

P-out: Measures instant output power.

The second line of the display shows the higher of the two temperatures:

- T-boost1: Booster channel 1 switching device temperature.
- T-boost2: Booster channel 2 switching device temperature.

6A)

Ppk	W
Ppk-DayW

Ppk: Maximum peak power achieved since the 'partial' function was activated.

Ppk-Day: Indicates the maximum peak power achieved during the day. The counter will reset when unit is powered OFF
7A)

Vgrid	197 V
Vgrid Avg	0 V

- Vgrid: Measures instant grid voltage
- Vgrid Avg: Average grid voltage calculated over the last 10 minutes of inverter operation

8A)

Igrid	0.8 A
Fgrid	60.18 Hz

- Igrid: Measures instant grid current
- Fgrid: Measures instant grid frequency

9A)

Vin1	0 V
Iin1	0.0 A

- Vin1: Instant input voltage value measured at channel 1 input.
- Iin1: Instant input current value measured at channel 1 input.

10A)

Vin2	0 V
Iin2	0.0 A

- Vin2: Instant input voltage value measured at channel 2 input.
- Iin2: Instant input current value measured at channel 2 input.

If the inverter configuration is set for single input (Parallel) mode, the following screen appears instead of the two screens previously described.

Vin	0 V
Iin	0.0 A

11A)

Pin 1	0 W
Pin 2	0 W

- Pin1: Measures instant input power of channel 1.
- Pin2: Measures instant input power of channel 2.

If the inverter configuration is set for single input (Parallel) mode, the following screen appears instead of the two screens previously described.

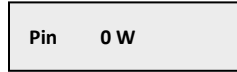

12A)

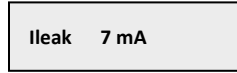

- Ileak: Value of the leakage current passing through the grounding fuse and displayed only when the connected positive or negative terminal is being grounded.

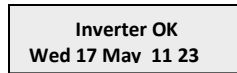

If all items described above tested OK, the inverter shows a corresponding message in the display top line along with the date and time. Clock malfunctioning or other non-function-related faults (meaning faults that do not affect the inverter's ability to generate energy) are shown in the second line of the display instead of the date and time.

The following error messages are provided:

- CLOCK FAILURE: Indicates clock malfunction; contact Power-One Technical Support.
- BATTERY LOW
- ADJ. TIME: Appears the first time the unit is powered up or after the battery has been replaced.
- FAN FAILURE: Does not affect the inverter's proper operation; replace the fan at the first convenient opportunity.
- MEMORY FAILURE: Data logging malfunction. Call Power-One Technical Support.

2.5.4 Main Menu

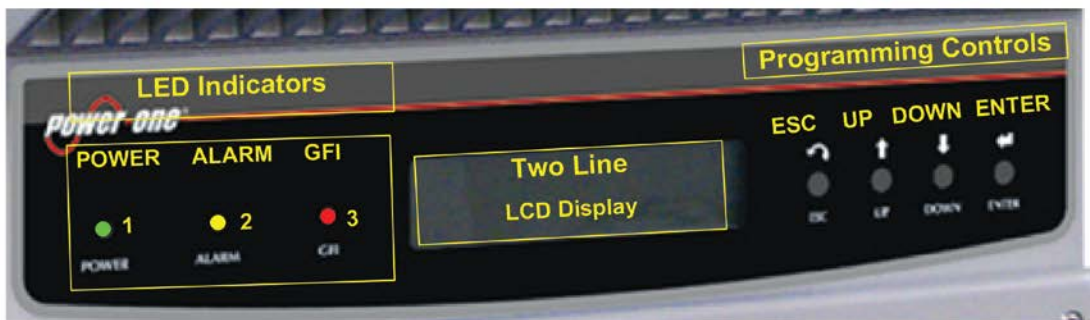

When the grid connection sequence and all electrical parameter checks are completed, other screens become available, which enable monitoring of the inverter's operation from different viewpoints.

Pressing the ESC key (1st key from display) gives access to three new screens:



A NOTE ON DISPLAY KEY OPERATION:

- Press the UP (2nd key from display) and DOWN keys (3rd key from display) to scroll through items.
- Press the ESC key (1st key from display) to go back to the previous session described in the highlighted area preceding section 0.
- Press ENTER (4th key from display) to open the selected submenu.

Note 4:01- Display Key Operation

2.5.5 Statistics

Select the STATISTICS menu to display the following sub-menu:



The display shows only 2 lines; use the keys at the side of the display to scroll through items or open the corresponding sub-menus as described in Note 4:01 above. An arrow on the left side of the display highlights the current selection as shown in the following screen shot:



2.5.6 Lifetime

Select **Lifetime** to view the following information:

Time	h
E-tot	KWh
Val.	EUR
CO2	kg

- Time: Lifetime operation time
- E-tot: Total energy produced
- Val. : Economic gain
- CO₂: CO₂ saving compared to fossil fuels

2.5.7 Partial

Select **Partial** to view the following information:



Time	h
E-par	KWh
Ppeak	W
Val.	EUR
CO2	kg

- Time: Total operation time since the counter was last reset. *
- E-par: Total energy produced since the counter was last reset. *
- PPeak: Maximum peak power measured since the 'partial' counter was activated
- Val. : Economic gain since the counter was last reset.*
- CO₂: CO₂ saving compared to fossil fuels since counter was last reset. *

* Hold the ENTER key (4th key from display) depressed for over 3 seconds to reset all counters in this submenu. After this time, a warning sound is repeated 3 times.

TODAY

Select **Today** to view the following information:

E-tod	KWh
Ppeak	W
Val.	EUR
CO2	kg

- E-tod: Total energy produced during the day.
- Ppeak: Peak power value achieved during the day.
- Val. : Economic gain during the day.
- CO₂: CO₂ saving for the day compared to fossil fuels.

2.5.8 Last 7 days

Select **Last 7 Days** to view the following information:

E-7d	KWh
Val.	EUR
CO2	kg

- E-7d: Total energy output over the last 7 days.
- Val. : Economic gain over the last 7 days.
- CO₂: CO₂ saving over the last 7 days compared to fossil fuels.

2.5.9 Last Month

Select **Last Month** to view the following information:

E-mon	KWh
Val.	EUR
CO2	kg

- E-mon: Total energy output this month.
- Val. : Economic gain this month.
- CO₂: CO₂ saving this month compared to fossil fuels.

LAST 30 DAYS

Select **Last 30 Days** to view the following information:

E-30d	KWh
Val.	EUR
CO2	kg

- E-30d: Total energy output over the last 30 days.
- Val. : Economic gain over the last 30 days.
- CO₂: CO₂ saving over the last 30 days compared to fossil fuels.

2.5.10 Last 365 Days

Select **Last 365 Days** to view the following information:

E-365	KWh
Val.	EUR
CO2	kg

- E-365: Total energy output over the last 365 days.
- Val. : Economic gain over the last 365 days.
- CO₂: CO₂ saving over the last 365 days compared to fossil fuels.

2.5.11 User Period

Select **User Period** to view the energy saving during a period specified by the user:

User period

- Press ENTER from the 'User period' screen to access the following sub-menu:

Start 23 June
End 28 August

- Use the display keys to set the start and end date of the period as follows:
 - Use ENTER to move from one field to the next (from left to right).
 - Use ESC to go back to the previous field (from right to left).
 - Press ESC repeatedly to go back to the previous menus as described in section 2.5.3.
 - To set the day:
 - Press DOWN to scroll numbers backwards (from 31 to 1).
 - Press UP to scroll numbers forwards (from 1 to 31).
 - To set the month:
 - Press DOWN to scroll months from December to January.
 - Press UP to scroll months from January to December.

If the dates set are inconsistent, the screen below alerts the user to the problem:

Data err

2.5.12 Settings

Select **SETTING** from the Main Menu and [ENTER] to display the **Password** screen, which enables the user to access the Settings Menu:

Password



- To enter this menu, the correct four digit password must be entered.
 - At initial set up, enter the default password [0000] unless the default password has been modified by the user (per Note 4:01) in which case, enter the correct user password.
 - Follow instructions below to enter password digits into their proper location:

- Use ENTER to move from one digit location to the next (from left to right).
 - Use ESC to go back to the previous figure (from right to left).
 - Press DOWN to scroll numbers backwards (from 9 to 0).
 - Press UP to scroll numbers forwards (from 0 to 9).
 - Press ESC repeatedly to go back to the previous menus as described in section 2.5.3
- After entering the required password, press ENTER to access to the **Settings Menu**:

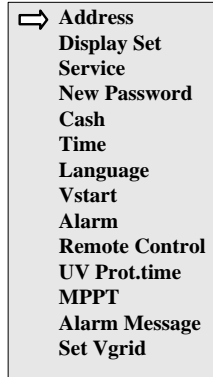

The front panel display has only two lines; therefore, the display keys must be used to scroll through the menu items and/or open the corresponding sub-menus (see Note 4:01). An arrow on left side of the display highlights the current selection. Once the chosen item is selected, press [ENTER] to access the desired sub-menu. The following section provides descriptions of each of the available sub-menus.

2.5.13 Address

Selecting this function enables the bus addresses (for the inverter connected to the RS485 communication bus) to be set to an appropriate value. Address values are assigned manually using any value in the range [2 to 64]. Press the UP and DOWN keys to scroll numbers.

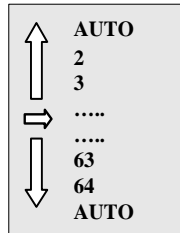

If desired, the RS485 address can be selected automatically by the system. This function is active when **AUTO** is selected from the address list.

NOTE: If wiring multiple units using a daisy chain configuration, do not select AUTO configuration.



2.5.14 Display Set

Selecting this function displays the following sub-menu enabling the user to set display features parameters:

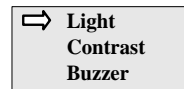

The following sections describe the available settings:

- **Light** - select this menu choice and [ENTER] to open the Display light sub-menu:

⇒ Mode
Intensity

- Select **MODE** and [ENTER] to allow setting the display backlighting.

⇒ ON
OFF
Auto

- **ON**: Light always ON.
- **OFF**: Light always OFF.
- **AUTO**: Automatic light setting - light turns on every time a key is pressed and stays on for 30 seconds before fading OFF.
- Select **INTENSITY** and [ENTER] to allow adjustment of the backlighting intensity from 1 to 9.
- **Contrast**: Select this menu choice and [ENTER] to adjust display lighting contrast
 - Available display light tones go from 0 to 9.
 - Press UP and DOWN keys to scroll the numbers and then press ENTER to confirm the selection.
- **Buzzer**: Select this menu choice and [ENTER] to set key tone setting, choices are:
 - **ON**: The key tone is ON.
 - **OFF**: The key tone is OFF.

2.5.15 Service

This is a controlled access area of the operating system used by the factory to set certain control functions. Access is via an Advanced Password, which is a dedicated security code based on the unit serial number and access controlled by Power-One. Installers may need to access this menu for certain adjustments during the installation process, and Power-One will provide Advanced Password access to authorized installers to allow specific actions upon completion of required documentation.

2.5.16 New Password

Selecting this function allows changing the default password (0000) to a personal code.

To set a personal code, use the display keys as follows:

- Use ENTER to move from one digit to the next (from left to right).
- Use ESC to go back to the previous digit (from right to left).
- Press ESC repeatedly to go back to the previous menus as described in section 2.5.3.
- Press DOWN to scroll numbers backwards (from 9 to 0).
- Press UP to scroll numbers forwards (from 0 to 9).

2.5.17 Cash

Selecting this function enables the user to set the measurement units for earnings based on energy output.

Name EUR
Val/KWh 00.50

- **Name**: Set desired currency, using the keys in the usual manner. The default currency is the Euro.
- **Val/KWh**: This indicates the cost of 1 kWh expressed in the currency set. The default setting is Euro 0.50.

2.5.18 Time

Selecting this function allows adjustment of the system time and date settings.

Time 14:21
Date 17 May 2006

2.5.19 Language

Selecting this function allows setting of the language desired for system prompts. Choices are Italian or English (default).



2.5.20 Start-Up Voltage

Selecting this function enables modification of the start-up voltage associated with each of the input channels to match requirements of the connected PV array. The voltage can be set over the range [120V to 350V]. The default setting for AURORA Inverter is 200V. Use the display keys to change the value of this parameter.



2.5.21 Alarm

Selecting this function accesses the inverter's alarm function, which is used for external controls or, for example, to activate a visual and/or audible alarm. The function has two different modes of operation. Select the desired mode using the UP/DOWN arrow keys and press [ENTER] to open the relevant sub-menu:

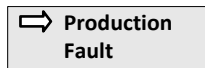

The function controls a set of dry relay contacts, which can be wired by the user as either normally open (N.O.) or normally closed (N.C.); contacts are rated at 250V/1A. The terminals for this function are accessed via the front panel as shown in Figure 4:05.

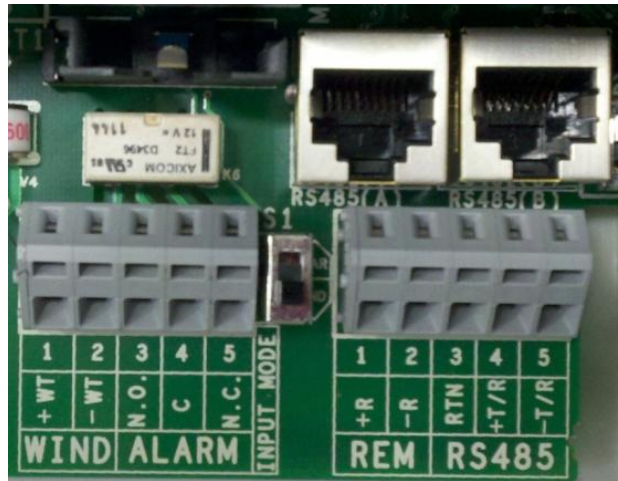

Figure 4:08: Alarm contact terminal block

The two operational modes are described below:

- **PRODUCTION:** In this mode, the relay is activated only when the inverter is connected to the grid.
For example, if the N.O.(Normally Open)contact is chosen, the contact will remain open (closed) as long as the inverter is not connected to the grid. Once grid connection occurs and the inverter begins to export power, the relay switches its status and closes (opens). Upon disconnection from the grid, the relay contact returns to its rest position, i.e. open (closed).
- **FAULT:** In this mode, the alarm relay triggers when the system logs a fault condition, based on the error codes (E-code) described in Section 2.4
For example, if the N.O. (Normally Open) contact is chosen, the contact will remain open (closed) as long as no E-code fault is logged (E-code faults disconnect the inverter from the grid). When any E-code is logged, the relay will change state and stay latched until the next successful grid reconnection, at which time it is reset.

Note: the alarm function does not switch when warning codes (W-code) are logged.

2.5.22 Remote Control

Selecting this function accesses the remote ON/OFF function used to disable the inverter operation by an external switch or an external controller. Set as follows:

- **DISABLE:** Disables the ON/OFF function, so that inverter operation will operate normally, depending only on grid access and external solar radiation. (default).
- **ENABLE** - Activates the ON/OFF function, requiring an external contact closure to activate the inverter.

Hardware access to the ON/OFF function is via terminals +R and -R, shown in Figure 4:08. When the function is active,

- Turn ON the inverter terminals by shorting terminals +R and -R.
- Turn OFF the inverter by removing the short between terminals +R and -R.

With the function enabled, the ON/OFF input status is indicated on the inverter display.



When set to OFF, the display will cycle through the following screens:



2.5.23 UV Protection Time (PROT. TIME)

Selecting this function allows setting of the inverter connection time after the input voltage drops below the under voltage limit, set at 90V.

For example: If UV Prot.time is set at 60 seconds, and Vin voltage drops below 90V, the inverter stays connected to the grid (at 0 power) for up to 60 seconds afterwards.

The default value is 60 seconds, but can be set over the range of [1 s to 3,600 s].

2.5.24 MPPT

Selecting this function enables setting parameters associated with the Maximum Power Point Tracker (MPPT) function. Following sections provide details of these settings:

- **MPPT Amplitude:** Set this parameter to choose the amplitude of the disturbance introduced in DC used by the MPPT circuit to establish the optimal work point. There are 3 options (LOW, MEDIUM, HIGH). The default setting is LOW.

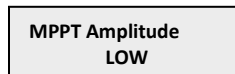

- **MPPT Scan** - the periodic scan of the MPPT circuit to detect if the system is on its maximum-power point can be enabled (default) or disabled.

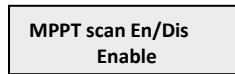

- **Scan Interval** - allows setting of the time interval between scans when system searches for real maximum power point. The default setting is 15 minutes.

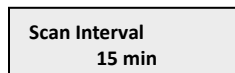

2.5.25 Alarm Message

Selecting this function allows access to the procedure to program the message shown on the display in the event of a logged error code:



After selecting the function, press [ENTER] to open the associated sub-menu.



Select the desired function using display buttons to scroll between the options; once the desired option is selected, press [ENTER] to enter the sub-menu.

- ENABLE/DISABLE - the following screen will appear in the menu and the alarm message can either be disabled or enabled (default):

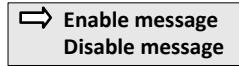

- With the ENABLE MESSAGE line is selected, press [ENTER] to open the sub-menu below.

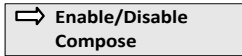

- Select COMPOSE MESSAGE to access the field for the first line of a custom the message, where up to 16 characters may be entered:

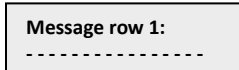

After entering the desired message, continue pressing [ENTER] until the field for the second line appears, where up to 16 characters may be entered:

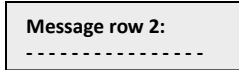

- To write the message always use the display keys in the following way:
 - Use ENTER (4th key) to move from one figure to the next (from left to right).
 - Use ESC (1st key) to go back to the previous position (from right to left).
 - Press ESC repeatedly to go back to the previous menus as described in section 2.5.3.
 - Use UP (2nd key) to scroll upwards through the numbers, letters and symbols.
 - Use DOWN (3rd key) to scroll downwards through the numbers, letters and symbols.

2.5.25 Set Vgrid

Selecting this function allows access to a sub-menu which allows setting the nominal grid voltage and grid type to which the inverter is to be connected:

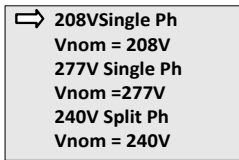

To choose a single phase 208V grid connection, move the cursor to the **208V Single Ph** line and press the [ENTER] button to open the following sub-menu:

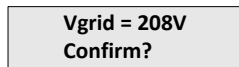

Press the [ENTER] key to confirm.

Similarly, to choose one of the other preset grid voltage/type combinations, move the cursor to the associated row and repeat the steps above.

2.5.26 Information

Selecting this menu allows display all AURORA Inverter data, the chosen language, and enables reading and/or modification of the grid standard by means of the special selector switches.

- Part No. (part number)
- Serial No. – Wk – Yr (serial number, week, year)
- Fw rel (firmware revision level)

3.0 DATA CHECK AND COMMUNICATION

The AURORA Inverters have remote monitoring and capabilities which are accessed externally using an RS485 communication port. The AURORA Inverter is provisioned with the communication capability as a standard feature, and all that is needed for remote monitoring is monitoring hardware which connects to the RS485 port and collects the available data. Following sections detail the wiring connections necessary to implement the RS485 bus. See Part 3 for specific wiring directions.

PART 5: TROUBLESHOOTING

5: 1.0 TROUBLESHOOTING

AURORA Inverters comply with the standards set for grid-tied operation, safety, and electromagnetic compatibility.

Before the product is dispatched various tests are carried out successfully to ensure: functioning, protection devices, performance and durability.

Such tests, together with the Power-One quality assurance system, support optimal operation of the AURORA Inverter.

In case of any possible malfunction of the inverter, solve problems as follows:

- Work under safe conditions. Check that the connections between AURORA, photovoltaic field and power distribution network have been made correctly as stated in Part 1 Introduction & Safety and Part 3 Wall Mount & Wire Configuration.
- Carefully observe which LED is flashing and read the signal appearing on the display; then try to identify the type of fault found by following the instructions given in the Sections below.

1.2 LED INDICATORS

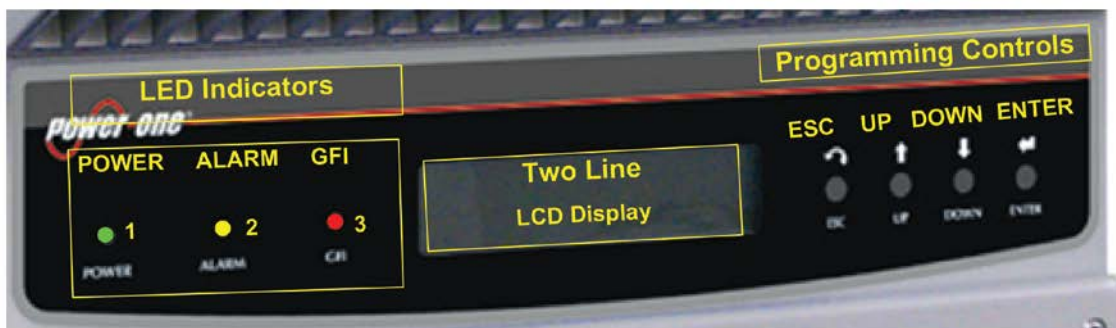

Figure 5:01- Location of the buttons and LEDs

There are three LEDs on the left side of the display:

4. The green 'Power' LED indicates that AURORA Inverter is operating correctly.
This LED flashes upon start-up, during the grid check routine. If a correct grid voltage is detected and solar radiation is strong enough to start-up the unit, the LED stays on steady. If not, the LED keeps flashing until solar radiation becomes strong enough to start-up the inverter. In this condition, the display will read **'Waiting Sun....'**
5. The yellow 'FAULT' LED indicates that the AURORA Inverter has detected a fault condition. A fault description will appear on the display.
6. The red 'GFI' (ground fault) LED indicates that AURORA Inverter is detecting a ground fault in the DC side of the photovoltaic system. When this kind of fault is detected, the AURORA Inverter disconnects from the grid and the corresponding fault indication appears on the LCD display. AURORA Inverter remains in this condition until the operator presses the ESC key to re-start the grid connection sequence. If AURORA Inverter does not reconnect to the grid, see Section 1.6: The Power-One Technical Support.
7. The following table shows all the possible LED-signalling indications related to the operational status of AURORA Inverter.

Key:

 LED on

 LED off

 LED flashing

 Any of the above conditions

	LED STATUS	OPERATIONAL STATUS	NOTES
1	1: green: <input checked="" type="checkbox"/> 2: yellow: <input checked="" type="checkbox"/> 3: red: <input checked="" type="checkbox"/>	AURORA self-disconnects during night-time	Input voltage less than 90 Vdc at both inputs
2	1: green: <input checked="" type="checkbox"/> 2: yellow: <input checked="" type="checkbox"/> 3: red: <input checked="" type="checkbox"/>	AURORA Inverter initialization, settings loading, and waiting for grid check	It is in transition status while operating conditions are being checked.
3	1: green: <input type="checkbox"/> 2: yellow: <input checked="" type="checkbox"/> 3: red: <input checked="" type="checkbox"/>	AURORA Inverter is powering the grid	Standard machine operation (search for maximum power point or constant voltage)
4	1: green: <input type="checkbox"/> 2: yellow: <input type="checkbox"/> 3: red: <input type="checkbox"/>	System insulation device faulty	Leakage to ground found
5	1: green: <input checked="" type="checkbox"/> 2: yellow: <input checked="" type="checkbox"/> 3: red: <input checked="" type="checkbox"/>	Defect – fault!!!	The fault can be inside or outside the inverter. See the alarm appearing on the LCD display.
6	1: green: <input checked="" type="checkbox"/> 2: yellow: <input checked="" type="checkbox"/> 3: red: <input checked="" type="checkbox"/>	Installation Phase: AURORA Inverter is disconnected from the grid.	During installation, it indicates set-up phase of the address for RS-485 communication.
7	1: green: <input checked="" type="checkbox"/> 2: yellow: <input checked="" type="checkbox"/> 3: red: <input checked="" type="checkbox"/>	Grid disconnection	Indicates a missing grid condition

 **NOTE:** Inverter status is indicated by the corresponding LED turning to a steady ON-condition or flashing, and by a message on the AURORA LCD displaying a description of the existing operation or fault condition (see the following sections).

1.3 MESSAGES and ERROR CODES

 DANGER:	<p>Normally grounded conductors may be ungrounded and energized when a ground-fault is indicated.</p> <ul style="list-style-type: none"> • Risk of electric shock • Test before touching • Work on the AURORA Inverter must be carried out by qualified personnel.
--	---

The system status is identified through message or error signals displayed on the LCD display. The following tables briefly describe the two types of signals which may be displayed.

Messages identify the current status of the AURORA Inverter. Messages do not relate to a fault. When a **(W)** with a number after it appears in the display, it indicates a **Warning Code** and is usually cleared through an orderly shutdown/re-set or a self corrective action performed by the inverter. See the (W) codes in the following table.

Alarms or **(E)** codes identify a possible equipment failure, fault or incorrect inverter setting or configuration. However, some of the (E) codes may require you to contact Power-One Technical Support to assist in correcting a fault. Any and all attempts to correct or clear a fault must be performed by qualified personnel. Typically, the (E) code can be cleared once the cause or fault is removed. Some of the (E) codes, **(Int. Error)** as indicated in the table below, may indicate a fatal error and require you to contact Power-One technical support for diagnostics and / or a product replacement.

Message	Error Warning	Error Type	Description	Message	Error Warning	Error Type	Description
Sun Low	W001	//	-Input Voltage under Vstart threshold -Sun too low -PV Array strings may be configured incorrectly. - A factory default setting of 200VDC Min is required to start the Aurora inverter.	Int.Error	//	E022	Autotest Timeout
Input OC	//	E001	-Input Overcurrent -PV Array strings may be configured incorrectly. -Similar to W001 after MIN VDC start has been adjusted	Int.Error	//	E023	Dc-Injection Error
Input UV	W002	//	Input Undervoltage Similar to W001 after MIN VDC start has been adjusted.	Grid OV	W004	//	Output Overvoltage
Input OV	//	E002	Input Overvoltage	Grid UV	W005	//	Output Undervoltage
Int.Error	//	E003	No parameters	Grid OF	W006	//	Output Overfrequency
Bulk OV	//	E004	-Bulk Overvoltage	Grid UF	W007	//	Output Underfrequency

			-Contact Power-One Technical Support				
Int.Error	//	E005	Communication Error	Z Grid HI	W008	//	Z grid out of range
Out OC	//	E006	-Output Overcurrent	Int.Error	//	E024	Unknown Error -
Int. Error	//	E007	-IGBT Sat -Contact Power-One Technical Support-possible.	-----	//	E025	Riso Low (Log Only)
Sun Low	W011	//	Bulk Undervoltage	Int.Error	//	E026	Vref Error
Int.Error	//	E009	-Internal Error -Conduct inverter Re-Set* -Call Power-One Technical Support if error isn't cleared.	Int.Error	//	E027	Vgrid Measures Fault
Grid Fail	W003	//	Grid Fail	Int.Error	//	E028	Fgrid Measures Fault
Int.Error	//	E010	-Bulk Low -Conduct inverter reset * - if error doesn't clear, contact Power-One Technical Support	Int.Error	//	E029	Zgrid Measures Fault
Int.Error	//	E011	Ramp Fail				
Over Temp.	//	E014	Overtemperature	Int.Error	//	E030	Ileak Measures Fault
Cap. Fault	//	E015	Bulk Capacitor Failure Call Power-One Technical Support.	Int.Error	//	E031	Wrong V Measure
DC/DC Fail	//	E012	DcDc Error revealed by inverter	Int.Error	//	E032	Wrong I Measure
Wrong Mode	//	E013	-Wrong Input setting (Single instead of dual) or wrong grounding mode -Wrong DC array input (verify PAR/IND MPPT switch is correct. Conduct inverter reset*. If error isn't cleared call Power-One Technical Support.	Empty Table	W009	//	No wind table (only wind -W versions)
Inv. Fail	//	E016	Inverter fail revealed by DcDc	Fan Fail	W010	//	Fan Fail (No disconnection)
Int.Error	//	E017	-Start Timeout -Conduct inverter reset* -If error doesn't clear contact Power-One Technical Support.	Int.Error	//	E033	UnderTemperature
Ground F.	//	E018	- I leak fail - Ground-fault is present. Inspect field wiring-verify there are no pinched wires or damaged wire insulation-conduct inverter reset*-		//	E034	Interlock Fail (Not Used)

			contact Power-One Technical Support.				
Int.Error	//	E019	Ileak Sensor fail		//	E035	Remote Off
Int.Error	//	E020	DcDc relay fail		//	E036	Vout Avg Error
Int.Error	//	E021	Inverter relay fail		W012	//	Clock Battery Low (No disconnection)
					W013	//	Clock Failure (No disconnection)

*To conduct the inverter reset, turn the AC and the DC OFF. Turn DC ON and wait for sun. Turn AC ON.

Table 5:01 Messages and Error Codes

1.4 LCD DISPLAY

1.4.1 Connection of the System to the Grid

A two-line LCD display is located on the front panel shows the following:

- ✓ Inverter operating status and statistics;
- ✓ Service messages for the operator;
- ✓ Alarm and fault messages.

During regular operation, the display will cycle through available data. The display changes to a different screen every 5 seconds, or screens may be scrolled manually by pressing the UP (2nd key from display) and DOWN keys (3rd key from display).

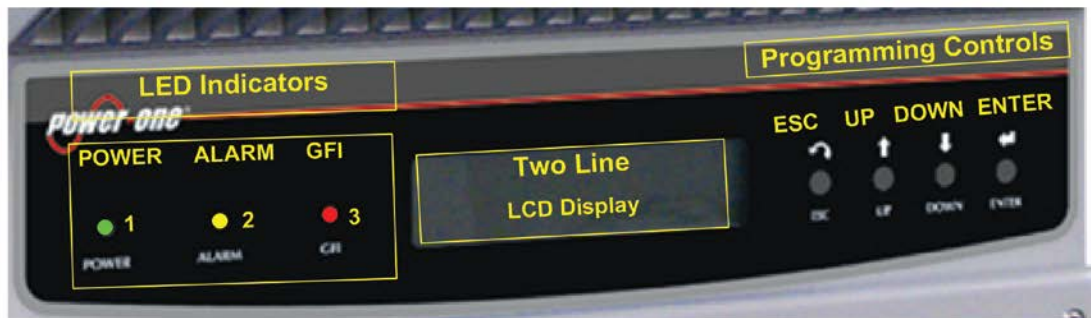

1) These two screens are displayed at inverter start-up:



6) The following screens may appear while waiting for the connection to be established:



- While the system checks for grid connection to be established ('Missing Grid'), the yellow LED next to the display turns on steady, while the green LED flashes.
- When waiting for solar radiation ('Waiting Sun'), the green LED turns on steady.
- As soon as the 'Missing Grid' and 'Waiting Sun' conditions are met successfully, the inverter is connected.

7) This display shows the time (seconds) remaining to complete the output voltage and frequency values check.



4) This display shows the instant output voltage value and whether it is within/outside range.

Vgrid	223.8 V
In range	

5) This displays the instant output frequency value and whether it is within/outside range.

Fgrid	60.17 Hz
In range	

6) If the measured instant values of voltage (point 4) and frequency (point 5) are outside the allowed range, the following screens are scrolled alternately:

Next connections (screen 3) → Vgrid (screen 4) → Fgrid (screen 5)

1.5 FIRST PHASE- ELECTRIC PARAMETER CHECK

Clock malfunctioning or other non- function-related faults (meaning faults that do not affect the inverter's ability to generate energy) are shown in the second line of the display instead of the date and time.

The following error messages are provided:

- **CLOCK FAILURE:** Indicates clock malfunction; contact Power-One Customer Service
- **BATTERY LOW**
- **ADJ. TIME:** Appears the first time the unit is powered up or after the battery has been replaced.
- **FAN FAILURE:** Does not affect the inverter's proper operation; replace the fan at the first convenient opportunity.
- **MEMORY FAILURE:** Data logging malfunction. Call Power-One Customer Service.

If the malfunction cannot be cleared by following these instructions, contact the service center or the installer (see Section 1.6 below). Before contacting Power-One Technical Support, please make the following information available in order to maximize the effectiveness of the intervention:

1.6 THE Power-One SERVICE CALL

INFORMATION ON AURORA INVERTER

- ✓ AURORA model?
- ✓ Serial number?
- ✓ Week of production?
- ✓ Which LED is flashing?
- ✓ Steady or flashing light?
- ✓ What signals are shown on the display?

NOTE: above information available directly from the LCD display

Additional helpful information when troubleshooting with the Power-One Technical Service Engineers:

- Provide a brief description of the fault.
- Information on the Photovoltaic Field
- Brand and model of photovoltaic panels
- Identify the System structure:
 - Maximum array voltage and current values
 - Number of strings in the array
 - Number of panels for each string
 - Can the fault be reproduced? If so, how?
 - Is the fault cyclical in nature? If so, how often?
 - Was the fault apparent at the time of installation?
 - If so, has it got worse?
 - Describe the atmospheric conditions at the time the fault appears/appeared.

Power-One Technical Support

Phone: 1-877-261-1374

PART 6: MAINTENANCE GUIDE

6: 1.0 MAINTENANCE

The AURORA Inverter has no user-serviceable parts. Maintenance and service procedures must comply with the manufacturer's documentation. Call Power-One Technical Support at 1-877-261-1374 for a list of qualified service contractors.

1.1 SHUT-DOWN PROCEDURE

There are three options for shutting down the inverter:

- 4) Disconnect the DC and the AC grid, by disconnecting its associated switches (in any order). The inverter will shut down within a few seconds necessary to discharge the internal capacitors.
- 5) Disconnect the DC input by turning-off the associated disconnect switch and waiting for the UV port time out
- 6) Disconnect the grid, by turning-off its associated disconnect switch and reduce DC input to less than 90 Vdc.

1.2 POWER-DOWN PROCEDURES

Once the inverter is wired and connected to the grid use the following procedures to disconnect for maintenance

 WARNING	Before performing any operation on the switchbox power input, ALWAYS perform the appropriate disconnection procedure outlined below.
--	--

1.2.1 Disconnection Of AURORA Inverter



Figure 6:01- Location of Front Access Panels



Location Indicator	Details		Location Indicator	Details	
A	DC Array: MPPT 1 input	Note 1 below	F	RS485 Bus Connection Via RJ485 Connector	Use with CAT5 Cable
B	DC Array: MPPT2 input	Note 1 below	G	RS485 Bus Connection Via Screw Terminals	Note 3 below
C	3 AC Grid Output Terminals	Note 2 below	H	RS485 Termination Switch	See Signal Connection Section for more detail
D	Alarm Out Terminals for External Alarm	Note 3 below			
E	MPPT Input Selector Switch	Choose PAR or IND MPPT Operation			

Notes: 1. Terminals accept wire range up to #4AWG (Refer to local code for appropriate wire size); torque to 13in-lb.
2. Terminals accept wire range up to #4AWG (Refer to local code for appropriate wire size); torque to 13in-lb.
3. Mating terminal in hardware kit. Terminals accept wire size range up to #4AWG; torque to 13 in-lb.

Figure 6:02 PVI-5000-6000-OUTD-US Wiring Connection Details

1.3 CR2032 LITHIUM BATTERY REPLACEMENT

 WARNING	<ul style="list-style-type: none"> • Before performing any operation on the switchbox power input or on the inverter, ALWAYS perform the disconnection procedure as explained in Part 4: Operations of this manual. • The replacement of this battery should be performed only by trained personnel.
--	--

Inside the AURORA Inverter there is a CR2032 lithium battery. When this battery is at end-of-life, a message will be shown in the display informing that the battery needs to be replaced.

The battery is visible after removing the AURORA PV Inverter's front panel. Refer Figure 6.01 above for the procedure to remove the front panel.

To insert the new battery into its holder, slide the battery at a 30° angle pushing it into insertion as shown in Figure 6:04 below. When pushed on into insertion it should seat into the correct position within the holder.

After battery replacement is completed, re-install and secure the front panel of the inverter and perform the START-UP procedure in Part 4: Operations.

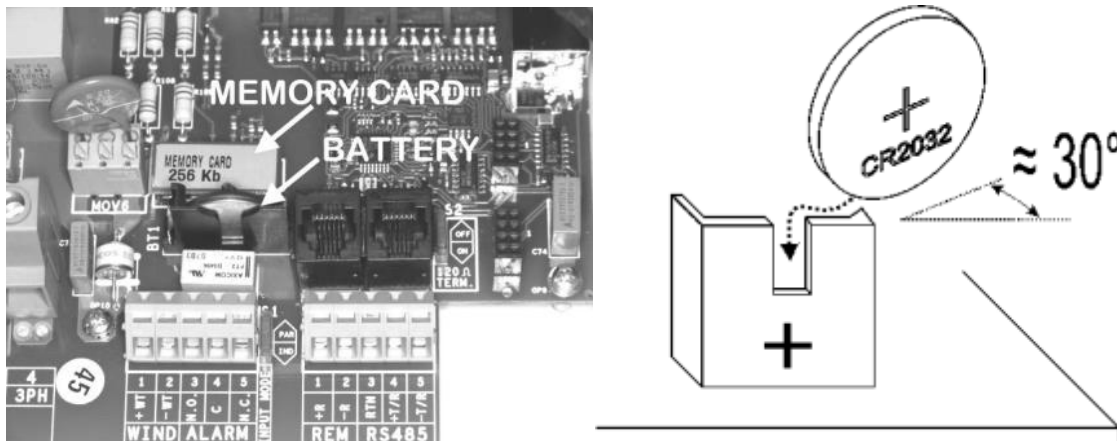



Figure 6:04 Lithium Battery Replacement

PART 7: THE APPENDIX

1.0 DATA SHEETS

 NOTE:	<p>If the input current supplied by the photovoltaic field connected to the inverter is above the maximum usable value and the input voltage is within the allowed range, the inverter will not be damaged.</p>
---	---

Technical Data	Values	PVI-5000-OUTD-US			PVI-6000-OUTD-US		
Rated Grid AC Voltage	V	208	240	277	208	240	277
Input Side (DC)							
Maximum Usable Power for Each Channel	W	4000	4000	4000	4000	4000	4000
MPPT Voltage Range	V	200-530	200-530	200-530	200-530	200-530	200-530
Start-Up Voltage	V	200 (adj. 120...350)	200 (adj. 120...350)	200 (adj. 120...350)	200 (adj. 120...350)	200 (adj. 120...350)	200 (adj. 120...350)
Absolute Maximum Voltage (Vmax)	V	600	600	600	600	600	600
Maximum Current (Idcmax) for both MPPT in Parallel	A	36	36	36	36	36	36
Maximum Usable Current per Channel	A	18	18	18	18	18	18
Number of Wire Landing Terminals per Channel		2	2	2	2	2	2
Number of Independent MPPT Channels		2	2	2	2	2	2

Array Wiring Termination			Screw terminal block 3 Knock-Outs: 1 ½" or 1" (w/ Ring Reducer.)	Screw terminal block 3 Knock-Outs: 1 ½" or 1" (w/ Ring Reducer.)	Screw terminal block 3 Knock-Outs: 1 ½" or 1" (w/ Ring Reducer.)	Screw terminal block 3 Knock-Outs: 1 ½" or 1" (w/ Ring Reducer.)	Screw terminal block 3 Knock-Outs: 1 ½" or 1" (w/ Ring Reducer.)	Screw terminal block 3 Knock-Outs: 1 ½" or 1" (w/ Ring Reducer.)
Output Side (AC)								
Grid Standard			1Ø/2W or Split-Ø/3W	1Ø/2W or Split-Ø/3W	1Ø/2W or Split-Ø/3W	1Ø/2W or Split-Ø/3W	1Ø/2W or Split-Ø/3W	1Ø/2W or Split-Ø/3W
Nominal Power	W		5000	5000	5000	6000	6000	6000
Voltage Range (Vmin-Vmax)	V		183-228	211-264	244-304	183-228	211-264	244-304
Grid Frequency; Range**	Hz		60;(59.3-60.5)	60;(59.3-60.5)	60;(59.3-60.5)	60;(59.3-60.5)	60;(59.3-60.5)	60;(59.3-60.5)
Maximum Current (Iac, max)	A		27	23	20	30	28	24
Power Factor			> 0.995	> 0.995	> 0.995	> 0.995	> 0.995	> 0.995
Total Harmonic Distortion At Rated Power	%		< 2	< 2	< 2	< 2	< 2	< 2
Contributory Fault Current ***	A _{PK} /A _R MS	2 4 0 V	36.25/25 .63	36.5/25. 81	31.75/22 .45	36.25/25 .63	36.5/25. 81	31.75/22 .45
Efficiency								
Maximum Efficiency	%		97.1	97.1	97.1	97.1	97.1	97.1
CEC Efficiency	%		96	96.5	96.5	96	96.5	96.5
Operating Parameters		2 4 0 V						
Consumption in Stand By (Night)	W _{RMS}	2 1 1. .. 2	< 8.0	< 8.0	< 8.0	< 8.0	< 8.0	< 8.0

		6 4 V						
Consumption During Operation	W_{RMS}	2 8. 0 A	20	20	20	20	20	20
Topology			Transfor merless	Transfor merless	Transfor merless	Transfor merless	Transfor merless	Transfor merless
Mechanical Specifications								
Enclosure rating			NEMA 4	NEMA 4	NEMA 4	NEMA 4	NEMA 4	NEMA 4
Cooling			Natural Convecti on	Natural Convecti on	Natural Convecti on	Natural Convecti on	Natural Convecti on	Natural Convecti on
Conduit Connections			Trade size KOs: (2eax1/2 ") and (2ea x 1- 1/4",3 places side, front, rear)	Trade size KOs: (2eax1/2 ") and (2ea x 1- 1/4",3 places side, front, rear)	Trade size KOs: (2eax1/2 ") and (2ea x 1- 1/4",3 places side, front, rear)	Trade size KOs: (2eax1/2 ") and (2ea x 1- 1/4",3 places side, front, rear)	Trade size KOs: (2eax1/2 ") and (2ea x 1- 1/4",3 places side, front, rear)	Trade size KOs: (2eax1/2 ") and (2ea x 1- 1/4",3 places side, front, rear)
Grid Wiring Termination Type		2 4 0 V	Screw Terminal Block Single wire, 90°C terminal wiring	Screw Terminal Block Single wire, 90°C terminal wiring	Screw Terminal Block Single wire, 90°C terminal wiring	Screw Terminal Block Single wire, 90°C terminal wiring	Screw Terminal Block Single wire, 90°C terminal wiring	Screw Terminal Block Single wire, 90°C terminal wiring
Dimensions (W/H/D)	in(mm)		12.8 x41.4x 8.7(325 x1052 x 222)	12.8 x41.4x 8.7(325 x1052 x 222)	12.8 x41.4x 8.7(325 x1052 x 222)	12.8 x41.4x 8.7(325 x1052 x 222)	12.8 x41.4x 8.7(325 x1052 x 222)	12.8 x41.4x 8.7(325 x1052 x 222)
Unit Weight	lb(kg)	3 5. 0 A	< 59.5(27.0)	< 59.5(27.0)	< 59.5(27.0)	< 59.5(27.0)	< 59.5(27.0)	< 59.5(27.0)
Shipping Weight	lbs (kg)		78(35.4)	78 (35.4)	78 (35.4)	78 (35.4)	78 (35.4)	78 (35.4)

Mounting System		Stainless Steel Wall bracket	Stainless Steel Wall bracket	Stainless Steel Wall bracket	Stainless Steel Wall bracket	Stainless Steel Wall bracket	Stainless Steel Wall bracket
Environmental							
Ambient Air Temperature Range	F(°C)	- 13...+14 0 (- 25...+60) with derating above 122 (50)	- 13...+14 0 (- 25...+60) with derating above 122 (50)	- 13...+14 0 (- 25...+60) with derating above 122 (50)	- 13...+14 0 (- 25...+60) with derating above 122 (50)	- 13...+14 0 (- 25...+60) with derating above 122 (50)	- 13...+14 0 (- 25...+60) with derating above 122 (50)
Acoustic Noise Emission Level	db A@ 1 m	< 50	< 50	< 50	< 50	< 50	< 50
Relative Humidity	%RH	0...100 condensi ng	0...100 condensi ng	0...100 condensi ng	0...100 condensi ng	0...100 condensi ng	0...100 condensi ng
Maximum Operating Altitude without Derating	ft(m)	6560 (2000)	6560 (2000)	6560 (2000)	6560 (2000)	6560 (2000)	6560 (2000)
Protection Devices							
Output							
Anti-Islanding Protection		Per Rqmts UL 1741/IE EE 1547	Per Rqmts UL 1741/IE EE 1547	Per Rqmts UL 1741/IE EE 1547	Per Rqmts UL 1741/IE EE 1547	Per Rqmts UL 1741/IE EE 1547	Per Rqmts UL 1741/IE EE 1547
External AC OCPD Rating	ARMS	35	30	25	40	35	30
Over-Voltage Protection Type		Varistor, 2(L-N/L- PE)	Varistor, 2(L-N/L- PE)	Varistor, 2(L-N/L- PE)	Varistor, 2(L-N/L- PE)	Varistor, 2(L-N/L- PE)	Varistor, 2(L-N/L- PE)
Input							
Reverse Polarity Protection		Yes	Yes	Yes	Yes	Yes	Yes

Maximum Short Circuit Current Limit per Channel	A	22	22	22	22	22	22
Over-Voltage Protection Type		Varistor, 2 for each channel	Varistor, 2 for each channel	Varistor, 2 for each channel	Varistor, 2 for each channel	Varistor, 2 for each channel	Varistor, 2 for each channel
PV Array Ground Fault Detection		Pre start-up Riso and dynamic GFDI (Requires Floating Arrays)	Pre start-up Riso and dynamic GFDI (Requires Floating Arrays)	Pre start-up Riso and dynamic GFDI (Requires Floating Arrays)	Pre start-up Riso and dynamic GFDI (Requires Floating Arrays)	Pre start-up Riso and dynamic GFDI (Requires Floating Arrays)	Pre start-up Riso and dynamic GFDI (Requires Floating Arrays)
DC Switch Current Rating (Per Contact)	A/V	25 / 600	25 / 600	25 / 600	25 / 600	25 / 600	25 / 600
Isolation Level		Transformerless (Floating Array)	Transformerless (Floating Array)	Transformerless (Floating Array)	Transformerless (Floating Array)	Transformerless (Floating Array)	Transformerless (Floating Array)
Safety and EMC Standard		UL 1741, CSA - C22.2 N. 107.1-01	UL 1741, CSA - C22.2 N. 107.1-01	UL 1741, CSA - C22.2 N. 107.1-01	UL 1741, CSA - C22.2 N. 107.1-01	UL 1741, CSA - C22.2 N. 107.1-01	UL 1741, CSA - C22.2 N. 107.1-01
Safety Approval		cCSA _{US}	cCSA _{US}	cCSA _{US}	cCSA _{US}	cCSA _{US}	cCSA _{US}
Features-Communication							
User-Interface (Display)		16 characters x 2 lines LCD display	16 characters x 2 lines LCD display	16 characters x 2 lines LCD display	16 characters x 2 lines LCD display	16 characters x 2 lines LCD display	16 characters x 2 lines LCD display
Remote Monitoring (1xRS485 incl.)		AURORA-UNIVERSAL (opt.)	AURORA - UNIVERSAL (opt.)	AURORA - UNIVERSAL (opt.)	AURORA - UNIVERSAL (opt.)	AURORA - UNIVERSAL (opt.)	AURORA - UNIVERSAL (opt.)

Wired Local Monitoring (1xRS485 incl.)		PVI-USB-RS485_2 32 (opt.), PVI-DESKTOP (opt.)	PVI-USB-RS485_2 32 (opt.), PVI-DESKTOP (opt.)	PVI-USB-RS485_2 32 (opt.), PVI-DESKTOP (opt.)		PVI-USB-RS485_2 32 (opt.), PVI-DESKTOP (opt.)	PVI-USB-RS485_2 32 (opt.), PVI-DESKTOP (opt.)	PVI-USB-RS485_2 32 (opt.), PVI-DESKTOP (opt.)
Wireless Local Monitoring		PVI-DESKTOP (opt.) with PVI-RADIOMODULE (opt.)	PVI-DESKTOP (opt.) with PVI-RADIOMODULE (opt.)	PVI-DESKTOP (opt.) with PVI-RADIOMODULE (opt.)		PVI-DESKTOP (opt.) with PVI-RADIOMODULE (opt.)	PVI-DESKTOP (opt.) with PVI-RADIOMODULE (opt.)	PVI-DESKTOP (opt.) with PVI-RADIOMODULE (opt.)
Standard Warranty	Years	10	10	10		10	10	10
Extended Warranty	Years	15 & 20	15 & 20	15 & 20		15 & 20	15 & 20	15 & 20
Available Models								
Standard-With DC Switch-Floating Array		PVI-5000-OUTD-US	PVI-5000-OUTD-US	PVI-5000-OUTD-US		PVI-6000-OUTD-US	PVI-6000-OUTD-US	PVI-6000-OUTD-US
*All data is subject to change without notice								
** Adjustable low trip point to 57Hz. See 2.5.1.1								
***Inverter can apply that much current- Breaker will open								

1.2 Technical Data

1.3 Voltage and frequency limits

The UL1741 requires, for voltage and frequency, the following limits for utility interaction:
Condition Simulated utility source.



The SPR-5000p/6000p-TL-1/ PVI-5000-OUTD-x-US voltage and frequency limits are listed in the following table:

Condition	Simulated utility source		Maximum time (sec) at 60 Hz before cessation of current to the simulated utility
	Voltage (V)	Frequency (Hz)	
A	$V < 50\% V_{nom}$ (**)	Rated (Default/Fixed)	0.16 sec (Fixed)
B	$50\%V_{nom} \leq V < 88\% V_{nom}$	Rated	2 sec (Fixed)
C	$110\%V_{nom} \leq V < 120\% V_{nom}$ (*)	Rated	1 sec (Fixed)
D	$V \geq 120\% V_{nom}$ (*)	Rated (Default, Fixed)	0.16 sec (Fixed)
E	Rated	$f > 60.5$ (Default)	0.16 sec (Default)
F	Rated	$f < 59.3$ (Default) (Adj. Set Points 59.7 Hz to 57 Hz)	0.16 sec (Default) (Adj. Set Points 0.16s to 300s)
G	Rated	$f < 57.0$ (Default, Fixed)	0.16 sec (Fixed)
H	Rated	$f > 60.5$ (Fixed)	0.16 sec (Fixed)

(*) Note: For model at 277V High Voltage is fixed at 110% V_{nom} and Very High Voltage is fixed at 111% V_{nom} .

(**)Note: for model at 208V Very Low Voltage is fixed at 55% V_{nom} . Minimum adjustable Low Voltage level is 55% V_{nom} .

1.4 DESCRIPTION OF THE SYSTEM

AURORA grid-tied inverters provide the capability to supply the utility grid with energy obtained from PV panels. To use the DC generated by a Photovoltaic field efficiently, it must be transformed into alternating current (AC) via a conversion process known as DC-AC inversion.

This process is the basis of all grid-tied inverters and is achieved very efficiently by the AURORA Inverter without the use of rotating elements. When the inverter output is connected in parallel to the utility power grid, the alternating current output from the inverter flows directly into the distribution circuit, and is connected in turn to the public distribution utility grid.

The photovoltaic energy system can thus feed all the connected user electrical loads:

- If the energy supply from the photovoltaic system is lower than the user's load requirement, the quantity of energy necessary to guarantee normal functioning of the connected appliances is taken from the public distribution network.
- If the energy supply from the photovoltaic system is greater than the user's load requirement (i.e. an excess of energy is produced) it is sent directly into the public network, thus becoming available to other users.

Depending on prevailing codes and regulations of the installation area, the energy produced can be sold to the utility or credited against future consumption, thereby producing energy savings.

1.4.1 Fundamental Elements of a Photovoltaic System: 'STRINGS' and 'ARRAYS'

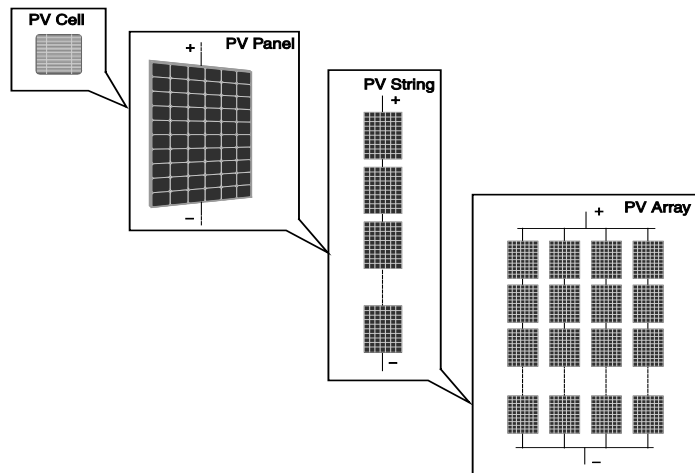

Figure 7:01- Array Composition

In order to significantly reduce installation costs of the photovoltaic system, especially related to the wiring problem on the inverter DC side and the subsequent distribution on the AC side, the STRING technology was developed. The terminology is as follows:

- A photovoltaic panel is composed of a great number of photovoltaic cells fixed onto a single supporting base.
- A STRING consists of a certain number of panels connected in series.
- An ARRAY is one or more strings connected in parallel.

Large photovoltaic systems can be composed of several arrays, connected to one or more AURORA Inverters.

By maximizing the number of panels in each string, the cost and complexity of the connection systems of the plant can be reduced.

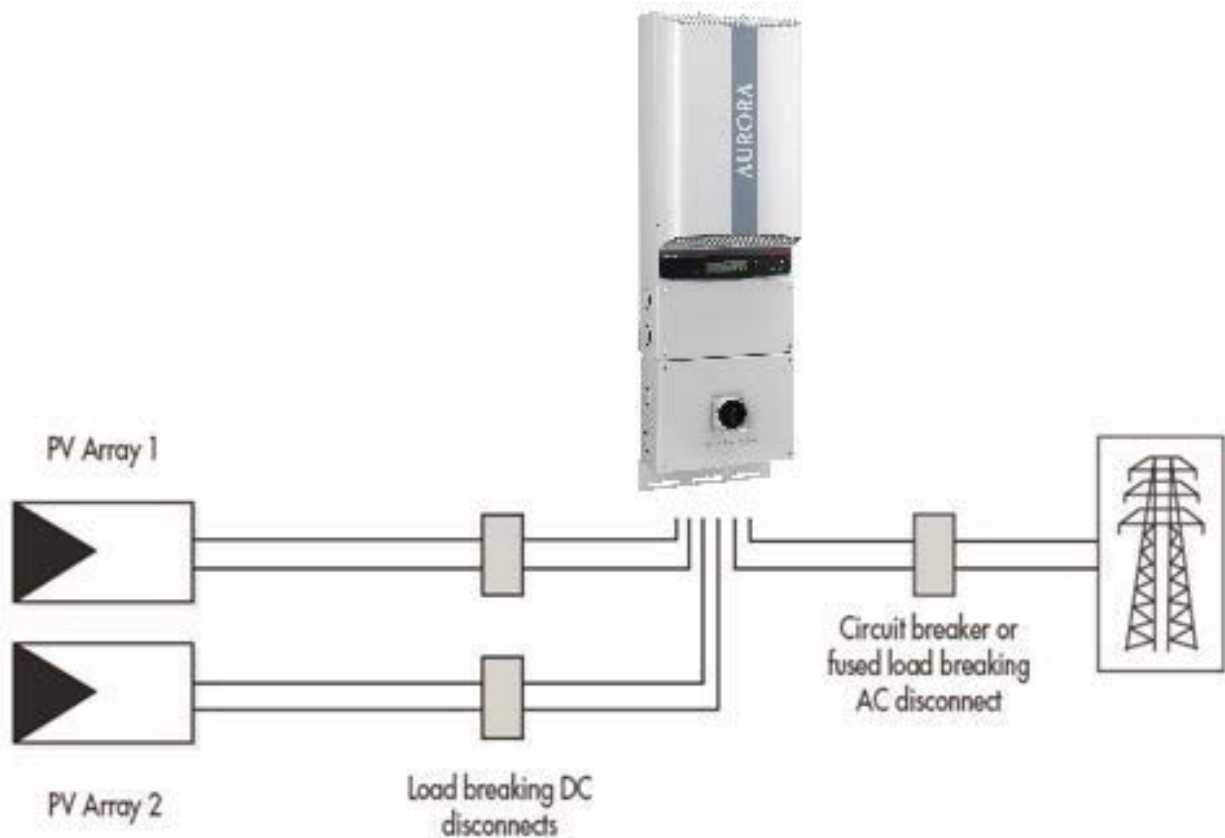

Figure 7:01 - Simplified Diagram of a Photovoltaic System

1.4.2 Inverter Input - The Photovoltaic Array

The input of a photovoltaic (PV) inverter is intended to be connected to a PV array. The input circuitry includes Maximum Power Point Tracking (MPPT) circuitry, which maximizes the output of the PV array under all allowable environmental conditions.

All AURORA models are provisioned with two independent inputs, each equipped with its own MPPT circuit that enables the AURORA Inverter to be connected to two independent arrays that are maximized for output power individually.

The MPPT circuitry has a specific operating range and the arrays must be designed to operate within this range. In order to properly operate the AURORA Inverter, proper array sizing must be completed and the results translated to a connectable system.

Array sizing is based on many variables and must be done for every array, as specifications are dependent on the type and quantity of PV panel used, and environmental factors such as expected high and low ambient temperatures to which the array will be subjected, as well as the orientation of the array panels to the sun.

In addition to properly sizing the array to match the inverter to which it is connected, the sizing of the interconnecting wiring is critical to ensure safe operation and high reliability. In North America, the wire sizing for the array and the grid interconnection are regulated and controlled by electric and building codes. Generally in the US, the National Electric Code (NEC) is used, but some areas use variations to this code. In Canada, the national code is the Electrical Safety Code (ESC); however, there are also local variations to this code (e.g., in Ontario the Ontario Electrical Safety Code (OESC) is the regulating document). The sizing and specification of a PV array requires trained individuals.

Decisions on how to structure a photovoltaic array depend on a number of factors and considerations, such as the type of panels, the available space, the future location of the system, long-term energy production targets, etc. Power-One offers a configuration program (AURORA Stringtool) that can aid the designer in setting correct dimensioning of a photovoltaic array to match characteristics of AURORA Inverters is available on the Power-One website (<http://stringtool.power-one.com/>).

Array sizing concerns:

 WARNING	<ul style="list-style-type: none">• To avoid equipment damage, the string voltage must not exceed 520 Vdc for any reason.• The effect of the negative thermal coefficient on the PV module's open circuit voltage causes Over Current (OC) Voltage to occur in conditions of minimum ambient temperature. It is the responsibility of the installer to check the PV generator's configuration before connecting any PV array.• The AURORA Inverter has a maximum allowable input current limit of 24Adc for each MPPT input channel.
---	--

 NOTE:	<p>The default value of the input voltage required to start the inverter (Vstart) is 200 Vdc; however, this can be set from the control panel over the range between 120 Vdc and 350 Vdc. This voltage level is required for the AURORA Inverter to start its grid connection sequence. Once connected, the inverter will transfer the maximum available power for any Vdc input voltage value in a range between 70% of the value set by Vstart and 520 Vdc to the grid.</p>
---	---

1.4.3 Technical Description of AURORA Inverter

The main segments of the design are the independent input DC-DC converters (termed 'boosters', one for each MPPT channel) and the main output inverter. Both of the DC-DC converters and the output inverter operate at a high switching frequency to enable a compact design and low weight.

These versions of Power-One's AURORA Inverters utilize "high-frequency switching" transformers, to provide a high-level of galvanic isolation between inverter input (array) and output (grid). This circuitry provides galvanic isolation from the secondary (AC side), while maintaining very high performance in terms of energy yield and export.

An AURORA with two independent input DC-DC converters; each converter is typically dedicated to a separate array and has independent Maximum Power Point Tracking (MPPT) circuitry and control. This means that the two arrays can be installed with different positions, facing different directions and with different string lengths; each array is controlled by an MPPT control circuit.

The AURORA's high efficiency and extra large heat dissipation system enables operation at maximum power over a broad range of ambient temperatures.

Two independent *Digital Signal Processors* (DSP) and one central microprocessor control the inverter; and therefore, two independent computers control the grid connection in full compliance with safety standards and regulations.

The AURORA Inverter operating system (program) communicates with all of the sub-systems within the inverter performing necessary data processing, calculations to guarantee optimal performance levels of the system and high-power harvesting in all installation and load conditions, while maintaining full compliance with prevailing safety directives, laws and regulations.

1.5 PROTECTIVE DEVICES WITHIN THE AURORA INVERTER



1.5.1 Inverter Output - the Grid Connection

The inverter converts energy harvested from the PV array into a form that can be transported to the connected AC grid, and by doing so, enables the energy to be used to power grid-loads. Connections of an inverter to the grid is a very controlled process not only in the actual electrical connection, but the regulatory processes required to gain approval from the controlling utility and other regulatory bodies. AURORA Inverters meet the requirements of all interconnection standards.

1.5.2 Data Transmission and Check

The AURORA Inverters have a sophisticated communication capability that enables monitoring of single or multiple inverters over a single communication link. Remote monitoring is implemented over an RS-485-based serial interface using a version of the AURORA Protocol. There is an optional web-based data logging system (AURORA Universal) also available for remote monitoring via the Internet via LAN, or GSM digital modem. The PVI-Desktop is another monitoring option that enables (with the use of the PVI-Radio-module installed in each inverter) the ability to monitor wirelessly operation of up to six inverters within a 1000-foot radius. The PVI desktop is not a web-based monitoring system and is intended for local ("in-house") monitoring applications.

1.5.3 Anti-Islanding

When the local utility AC grid fails due to a line fault or otherwise interrupted (e.g., equipment maintenance) the AURORA Inverter must be physically disconnected in a fail-safe manner to protect any personnel working on the network. The AURORA system accomplishes this in full compliance with all prevailing standards and regulations. To avoid any possible operation without the presence of an active grid connection, the AURORA design includes an automatic disconnection protection system called 'Anti-Islanding'. All AURORA models are equipped with an anti-islanding protection system certified to both US and Canadian standards (UL Std N.1741 and CSA-C22.2 N.107.1-01)

1.5.4 Grounding/Differential Protection Fault

AURORA Inverter has a sophisticated ground protection circuit that continually monitors the ground connection for significant changes in fault current. when a ground fault current sufficient to cause safety hazards is detected, this circuit shuts down the inverter and illuminates a red LED on the front panel indicating a ground fault condition. The AURORA Inverter is equipped with a terminal for the system ground conductors.

 DANGER:	Normally grounded conductors may be ungrounded and energized when a ground-fault is indicated. <ul style="list-style-type: none">• Risk of electric shock• Test before touching• Work on the AURORA Inverter must be carried out by qualified personnel.
--	--

 NOTE:	The protective devices for ground fault detection and control comply with CSA-C22.2 N.107.1-01 and UL Std N.1741.
--	---

1.6.5 ADDITIONAL PROTECTIVE DEVICES

AURORA Inverter is equipped with additional protections to guarantee the safe operation under any circumstances. Such protections include:

- Constant monitoring of grid voltage to ensure that voltage and frequency remain within the specified operational limits (in accordance with UL 1741 standard);

- Automatic power limitation (derating) controlled by internal temperature monitoring to avoid overheating (heat sink temperature $\geq 158^{\circ}\text{F}$).

1.6.5.1 Power Derating

In order to ensure inverter operation under safe conditions both from the temperature and electrical point of view, the unit automatically decreases power input to the grid. Power derating can occur in two cases:

- **Power reduction due to environmental conditions**

Power reduction and temperature, at which it occurs, depends on many operating parameters other than ambient temperature; such as input voltage, grid voltage, and power available from the photovoltaic panels. AURORA Inverter can thus decrease power output during certain periods of the day according to these parameters.

In any case, the AURORA Inverter ensures maximum power up to 50°C provided it is not directly exposed to the sun.

- **Power reduction due to input voltage**

Necessary conditions for power derating due to environmental conditions and to input voltage can occur at the same time, but in this instance power derating will always consider the lowest value detected.

1.6.5.2 FCC

The equipment specified in this manual complies with Part 15 of the FCC rules. Operation is subject to following two conditions:

- (1) This equipment may not cause harmful interference.
- (2) This equipment must accept any interference received, including interference that may cause undesired operation.

###