

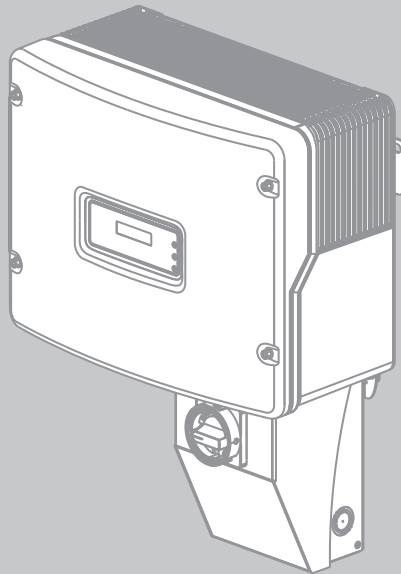

PV Inverter

SUNNY BOY 3000-US / 3800-US / 4000-US

User Manual



Copyright © 2012 SMA America, LLC. All rights reserved.

No part of this document may be reproduced, stored in a retrieval system, or transmitted, in any form or by any means, electronic, mechanical, photographic, magnetic or otherwise, without the prior written permission of SMA America, LLC.

Neither SMA America, LLC nor SMA Solar Technology Canada Inc. makes representations, express or implied, with respect to this documentation or any of the equipment and/or software it may describe, including (with no limitation) any implied warranties of utility, merchantability, or fitness for any particular purpose. All such warranties are expressly disclaimed. Neither SMA America, LLC nor its distributors or dealers nor SMA Solar Technology Canada Inc. nor its distributors or dealers shall be liable for any indirect, incidental, or consequential damages under any circumstances.

(The exclusion of implied warranties may not apply in all cases under some statutes, and thus the above exclusion may not apply.)

Specifications are subject to change without notice. Every attempt has been made to make this document complete, accurate and up-to-date. Readers are cautioned, however, that SMA America, LLC and SMA Solar Technology Canada Inc. reserve the right to make changes without notice and shall not be responsible for any damages, including indirect, incidental or consequential damages, caused by reliance on the material presented, including, but not limited to, omissions, typographical errors, arithmetical errors or listing errors in the content material.

All trademarks are recognized even if these are not marked separately. Missing designations do not mean that a product or brand is not a registered trademark.

The *Bluetooth*[®] word mark and logos are registered trademarks owned by Bluetooth SIG, Inc. and any use of such marks by SMA America, LLC and SMA Solar Technology Canada Inc. is under license.

SMA America, LLC
3801 N. Havana Street
Denver, CO 80239 U.S.A.

SMA Solar Technology Canada Inc.
2425 Matheson Blvd. E
8th Floor
Mississauga, ON L4W 5K5
Canada

IMPORTANT SAFETY INSTRUCTIONS

SAVE THESE INSTRUCTIONS

This manual contains important instructions for the following products:



- Sunny Boy 3000-US/3800-US/4000-US

This manual must be followed during installation and maintenance.

The product is designed and tested in accordance with international safety requirements, but as with all electrical and electronic equipment, certain precautions must be observed when installing and/or operating the product. To reduce the risk of personal injury and to ensure the safe installation and operation of the product, you must carefully read and follow all instructions, cautions and warnings in this manual.



Warnings in this Document

A warning describes a hazard to equipment or personnel. It calls attention to a procedure or practice, which, if not correctly performed or adhered to, could result in damage to or destruction of part or all of the SMA equipment and/or other equipment connected to the SMA equipment or personal injury.

Symbol	Description
 DANGER	DANGER indicates a hazardous situation which, if not avoided, will result in death or serious injury.
 WARNING	WARNING indicates a hazardous situation which, if not avoided, could result in death or serious injury.
 CAUTION	CAUTION indicates a hazardous situation which, if not avoided, could result in minor or moderate injury.
NOTICE	NOTICE is used to address practices not related to personal injury.

Markings on this Product

The following symbols are used as product markings with the following meanings.

Symbol	Description
	Warning regarding dangerous voltage The product works with high voltages. All work on the product must only be performed as described in the documentation of the product.
	Beware of hot surface The product can become hot during operation. Do not touch the product during operation.

General Warnings

⚠ WARNING

General Warnings

All electrical installations must be in accordance with the local and *National Electrical Code*® ANSI/NFPA 70 or the *Canadian Electrical Code*® CSA C22.1. This document does not and is not intended to replace any local, state, provincial, federal or national laws, regulations or codes applicable to the installation and use of the product, including without limitation applicable electrical safety codes. All installations must conform with the laws, regulations, codes and standards applicable in the jurisdiction of installation. SMA assumes no responsibility for the compliance or noncompliance with such laws or codes in connection with the installation of the product.

The product contains no user-serviceable parts except for the fan on the bottom of the enclosure and the handle covers on the sides of the unit. For all repairs and maintenance, always return the unit to an authorized SMA Service Center.

Before installing or using the product, read all of the instructions, cautions, and warnings in this manual.

Before connecting the product to the power distribution grid, contact the local utility company. This connection may only be performed by personnel.

Wiring of the product may only be performed by qualified personnel.

Table of Contents

- 1 Information on this Document. 9**
- 2 Safety 11**
 - 2.1 Intended Use. 11
 - 2.2 Safety Precautions. 12
- 3 Product Description 13**
 - 3.1 Sunny Boy. 13
 - 3.2 Type Labels. 15
 - 3.3 DC Disconnect 18
 - 3.4 Communication. 18
 - 3.5 Arc-Fault Circuit Interrupter (AFCI) 19
- 4 Operating the Display 20**
- 5 Troubleshooting 21**
 - 5.1 LED Signals 21
 - 5.2 Measurement Channels 24
 - 5.3 Display Messages. 25
 - 5.3.1 Status Messages 25
 - 5.3.2 Error Messages 26
 - 5.3.3 Resetting "Error AFCI" 30

- 6 Cleaning and Care 31**
- 6.1 Checking the Inverter 31
- 6.2 Checking the DC Disconnect 31
- 6.3 Cleaning the Inverter. 32
- 6.4 Cleaning the Fan Enclosure 32
- 6.5 Cleaning the Ventilation Grids 33
- 7 Compliance Information 34**
- 8 Contact 35**

1 Information on this Document

Validity

This document is valid for the following device types:

- SB 3000US
- SB 3000US-12
- SB 3800-US-10
- SB 3800-US-12
- SB 4000US
- SB 4000-US-12





Target group

This document is intended for end users.

Additional information

Additional information is available at www.SMA-America.com.

Symbols

Symbol	Description
 DANGER	DANGER indicates a hazardous situation which, if not avoided, will result in death or serious injury.
 WARNING	WARNING indicates a hazardous situation which, if not avoided, could result in death or serious injury.
 CAUTION	CAUTION indicates a hazardous situation which, if not avoided, could result in minor or moderate injury.
NOTICE	NOTICE is used to address practices not related to personal injury.
	Indicates information that is important for a specific topic or objective, but is not safety-relevant.
<input type="checkbox"/>	Indicates a requirement for meeting a specific goal.
<input checked="" type="checkbox"/>	Desired result
x	A problem that could occur

Typography

Typography	Usage	Example
"light"	<ul style="list-style-type: none"> • Display messages • Parameters • Terminals • Slots 	<ul style="list-style-type: none"> • The inverter switches to "Balanced" mode.
bold	<ul style="list-style-type: none"> • Elements to be selected • Elements to be entered 	<ul style="list-style-type: none"> • Select the FanTest parameter and set to 1.

Nomenclature

The following nomenclature is used in this document:

Complete designation	Designation in this document
SMA Solar America, LLC	SMA
SMA Solar Technology Canada Inc.	SMA
Sunny Boy 3000US/3800-US/4000US	Inverter/Sunny Boy

Abbreviations

Abbreviations	Designations	Explanations
AC	Alternating Current	-
AFCI	Arc-Fault Circuit Interrupter	-
DC	Direct Current	-
LED	Light-Emitting Diode	-
MPP	Maximum Power Point	-
MPPT	Maximum Power Point Tracker	-
OCU	Operational Control Unit	-
PV	Photovoltaics	-

2 Safety

2.1 Intended Use

The Sunny Boy is a PV inverter which converts the direct current of the PV array to alternating current and feeds it into the power distribution grid. The Sunny Boy is suitable for use with fuel cells, small wind turbine systems and other DC power sources.

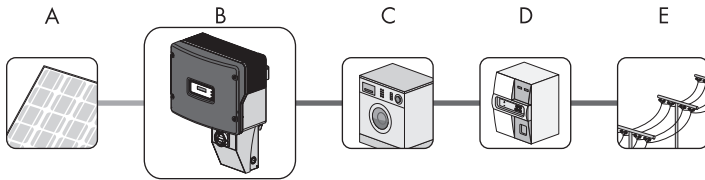

Figure 1: Principle of a PV plant with Sunny Boy

Position	Description
A	PV array
B	Sunny Boy with DC Disconnect
C	Loads
D	Energy meter
E	Power distribution grid

The Sunny Boy takes current from a DC source and converts it to alternating current for the power distribution grid. This current is then supplied to the local loads (C). Surplus energy is fed into the power distribution grid (E). The amount of current needed from the power distribution grid is reduced due to the current supplied to the load from the PV plant. An energy surplus may even result in the energy meter (D) of your plant running backward. This power may also be recorded as power credits by the local utility company depending on the interconnection agreement.

The Sunny Boy is suitable for indoor and outdoor use.

The Sunny Boy may only be operated with PV arrays of protection class II. The PV modules used must be suitable for use with the Sunny Boy and must be approved by the module manufacturer. Do not connect any energy sources other than PV modules to the Sunny Boy.

For safety reasons, it is forbidden to modify the product or install components that are not explicitly recommended or distributed by SMA.

Only use the Sunny Boy in accordance with the information provided in the enclosed documentation. Any other use can result in personal injury or property damage.

The enclosed documentation is an integral part of this product.

- Read and adhere to the documentation.
- Keep the documentation in a convenient place for future reference.

2.2 Safety Precautions

DANGER

Danger to life due to electric shock

The components in the inverter are live. Touching live components can result in serious injury or death.

- Do not open the inverter.
- Electrical installation, repairs and conversions may only be carried out by electrically qualified persons.
- Do not touch damaged inverters.

CAUTION

Risk of burns due to hot enclosure parts

Parts of the enclosure can become very hot during operation. Touching hot enclosure parts can result in burns.

- Only touch the enclosure lid and display during operation.

3 Product Description

3.1 Sunny Boy

The Sunny Boy is a PV inverter which converts the direct current of the PV array to alternating current and feeds it into the power distribution grid.

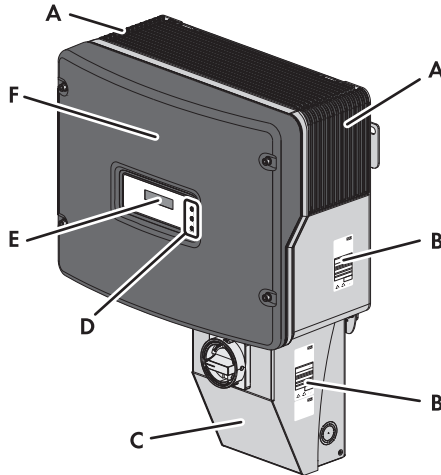





Figure 2: Sunny Boy design

Position	Description
A	Ventilation grids (left and right)
B	Type label
C	DC Disconnect
D	LEDs
E	Display
F	Enclosure lid

Symbols on the inverter

Symbol	Description	Explanation
	Tap symbol	Indicates display operation (see section 4).
	Green LED	The green LED indicates the operating state of the inverter (see section 5.1).
	Red LED	The red LED indicates the status of the grounding fuse (see section 5.1).
	Yellow LED	The yellow LED indicates an error or disturbance (see section 5.3.2).

3.2 Type Labels

Type label of the Sunny Boy

The type label provides a unique identification of the inverter. The type label is on the right-hand side of the enclosure.

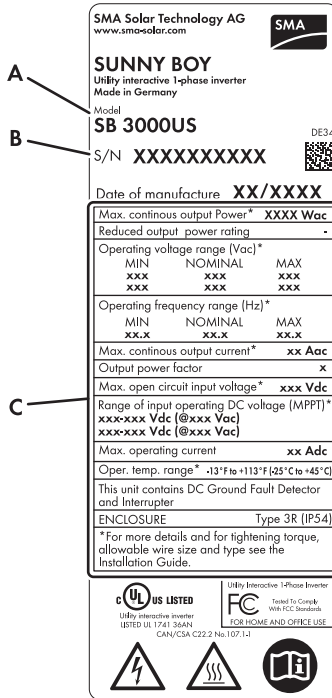

Figure 3: Layout of the Sunny Boy type label

Position	Description	Explanation
A	Model	Device type
B	Serial No.	Inverter serial number
C	Device-specific characteristics	-

You require the information on the type label to use the inverter safely and for customer support at the SMA Service Line. The type label must be permanently affixed to the inverter.

Type labels of the DC Disconnect

The type label provides a unique identification of the DC Disconnect. The type labels are on the right-hand side of the enclosure.

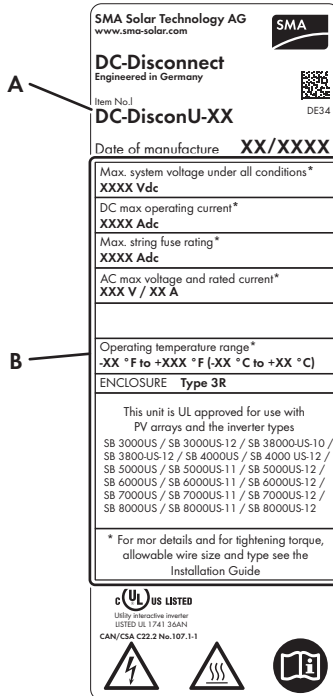

Figure 4: Layout of the DC Disconnect type label

Position	Description	Explanation
A	Item No.1	Device type
B	Device-specific characteristics	-

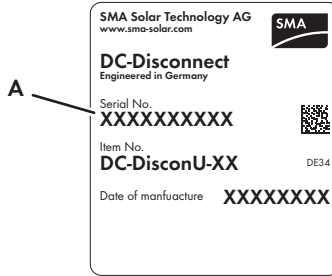

Figure 5: Layout of the DC Disconnect type label

Position	Description	Explanation
A	Serial No.	DC Disconnect serial number

You require the information on the type label to use the DC Disconnect safely and for customer support at the SMA Service Line. The type label must be permanently affixed to the DC Disconnect.

Symbols on the type labels

Symbol	Explanation
	<p>Observe the operating instructions</p> <p>Read the documentation of the product before working on it. Follow all safety precautions and instructions as described in the documentation.</p>
	<p>UL1741 is the standard applied by Underwriters Laboratories to the product to certify that it meets the requirements of the <i>National Electrical Code</i>[®], the <i>Canadian Electrical Code</i>[®] CSA C22.1, and IEEE-929-2000. IEEE 929-2000 provides recommendations regarding the proper equipment and functionality necessary to ensure compatible operation when power generation is connected to the power distribution grid.</p>

3.3 DC Disconnect

The DC Disconnect safely disconnects the PV array from the inverter.

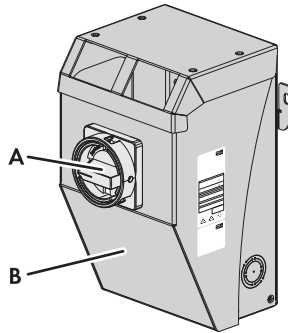

Figure 6: DC Disconnect design

Position	Description
A	Rotary switch
B	Cover

The DC Disconnect forms a conductive path between the PV array and the inverter. Actuating the DC Disconnect interrupts the flow of current and the DC cabling can be safely disconnected from the inverter.

3.4 Communication

The inverter can be fitted with a communication module to enable communication via cabling with special data capture devices or a PC with the corresponding software (for information about supported communication products for communication with the communication module, see www.SMA-America.com).

3.5 Arc-Fault Circuit Interrupter (AFCI)

In accordance with the *National Electrical Code*[®], Article 690.11, the Sunny Boy is equipped with a system for electric arc detection and interruption.

An electric arc with a power of 300 W or greater must be interrupted by the AFCI in the time specified by UL 1699B. A tripped AFCI may only be reset manually.

Only the following types of Sunny Boy are equipped with an automatic arc-fault circuit interrupter:

- SB 3000-US-12
- SB 3800-US-12
- SB 4000-US-12

The 2011 edition of the *National Electrical Code*[®], Article 690.11 stipulates that newly installed PV plants attached to a building must be fitted with a means of detecting and disconnection of serial electric arcs on the PV side.

The automatic arc-fault circuit interrupter can be deactivated in the "Installer" mode via the communication device if this function is not desired.

4 Operating the Display

The display shows the current operating data of the inverter (e.g. status, power, input voltage) and errors or disturbances.

The displayed operating data is updated every 5 seconds. The backlight shuts off automatically after 2 minutes.

You can operate the display by tapping on the enclosure lid:

- To activate the backlight, tap once.
- To move on from a displayed message, tap once.
- To display the serial number and designation of the inverter, the firmware version and the status of the Power Balancer (if active) in succession during operation, tap twice in succession.

5 Troubleshooting

5.1 LED Signals

The LEDs display the operating state of the inverter and indicate the messages in the display via various blink codes.

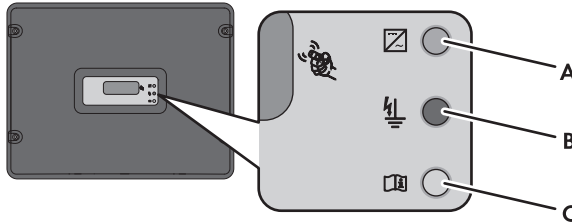

Figure 7: Position of the LEDs

Position	Description	Status	Explanation
A	Green LED	Glowing	Operation Indicates normal operation of the inverter.
		Blinks 3 times per second	Start The inverter is calibrating internal systems. The calibration lasts 10 seconds and the inverter begins normal operation.
			Stop The inverter has been set to stop mode manually.
		Blinks once per second	Waiting The inverter is checking the conditions for grid connection.

Position	Description	Status	Explanation
		Goes out briefly once per second	<p>Derating</p> <p>At temperatures above +113 °F (+45 °C), the inverter continues to operate but reduces the power so as to protect the internal components from overheating.</p> <p>Corrective measures:</p> <ul style="list-style-type: none"> • Ensure that the inverter has sufficient ventilation. • Ensure that air is emerging from the fan enclosure. If no air is emerging from the fan enclosure, clean the fan enclosure (see section 6.4).
B	Red LED	Glowing	<p>Grounding fuse tripped</p> <p>The grounding fuse has been tripped or is missing. The grounding fuse protects the PV plant if a ground fault is present in the PV array.</p> <p>Corrective measures:</p> <ul style="list-style-type: none"> • Contact installer.
C	Yellow LED	Glowing	<p>Control system error</p> <p>The inverter is no longer feeding into the power distribution grid.</p> <p>Corrective measures:</p> <ul style="list-style-type: none"> • Contact installer.
		Blinking	<p>AFCI self-test</p> <p>The inverter is performing an AFCI self-test.</p>
		Glow for 5 s, goes out for 3 s, blinks twice	<p>Grid failure</p> <p>The power distribution grid has failed or the AC miniature circuit-breaker has been triggered.</p> <p>Corrective measures:</p> <ul style="list-style-type: none"> • Ensure that there is no power distribution grid failure. • If there is no power distribution grid failure, contact the installer.

Position	Description	Status	Explanation
		Glows for 5 s, goes out for 3 s, blinks 4 times	High DC input voltage The inverter has detected a DC input voltage that is too high for safe operation. Corrective measures: <ul style="list-style-type: none"> Contact installer.
		Glows for 5 s, goes out for 3 s, blinks 5 times	Disturbance The inverter has detected an internal error that interrupts normal operation. Corrective measures: <ul style="list-style-type: none"> Contact installer.
B + C	Red LED + yellow LED	Glowing	Ground fault The inverter has detected a ground fault. The inverter will not restart automatically after detecting a ground fault. Corrective measures: <ul style="list-style-type: none"> Contact installer.
A + B + C	All LEDs	Glowing	Initialization The inverter is initializing. The available DC input current of the PV array is insufficient for feed-in operation. Data transmission is not possible during initialization.
A + B + C	All LEDs	None glowing	Standby The inverter is in standby mode. The input voltage is too low for operation.

5.2 Measurement Channels

The measured values of the inverter are shown on the display in the measurement channels. In addition, you can read out a variety of measurement channels and messages from the inverter using special communication devices (e.g. Sunny WebBox) or a PC with the relevant software (e.g. Sunny Explorer).

Measurement channel	Explanation
CO2 saved	Amount of CO ₂ saved during the operating time
E-Total	Total energy yield
Error	Description of error
Event-Cnt	Number of events
Fac	Power frequency
Grid Type	Type of power distribution grid to which the inverter is connected
h-on	Total operating hours
h-Total	Total number of operating hours in feed-in operation
I-dif	Residual current
Iac	Line current
Ipv	DC input current
Max Temperature	Maximum temperature measured at IGBT module
Max Vpv	Maximum DC input voltage
Mode	Current operating mode
Pac	Power fed into the power distribution grid
Power On	Total system start-up counter
Serial Number	Inverter serial number
Temperature	Temperature measured at IGBT module
Vac	Line voltage L1 - L2
Vac L1	Line voltage L1 - N
Vac L2	Line voltage L2 - N
Vpv	DC input voltage
Vpv-PE	Direct voltage to ground (for troubleshooting PV ground faults)
Vpv Setpoint	MPP tracking DC target voltage

5.3 Display Messages

5.3.1 Status Messages

Message	Explanation
Derating	Reduction of the power distribution grid feed-in power due to abnormal heat sink temperatures
Disturbance	Indicates an error status related to the power distribution grid. The error status will resolve itself.
Error	Error status that must be remedied
Grid monitoring	When the system starts, the inverter synchronizes with the power distribution grid.
MPP	The inverter is in MPP mode. The inverter adjusts the DC input voltage and the DC input current of the PV array to achieve the highest possible DC output power.
MPP-Search	When the system starts, the inverter checks the MPP tracking range.
Offset	When the system starts, the inverter calibrates the electronics.
Stop	The inverter has been manually set to system stop.
Turbine	The inverter is in turbine mode. This operating mode was specifically designed for use with wind turbine systems.
V-Const	The DC input voltage of the PV arrays is set at a given target value and the inverter is not operating in MPP mode. This operating mode is suitable for using the inverter with fuel cells or small hydroelectric power plants.
Wait	The DC input voltage is not high enough for the start.
Warning	System warning advising further investigation

5.3.2 Error Messages

In the event of an error, the relevant messages are shown on the display and the backlight is activated. Each error message is displayed for 5 seconds. After 5 seconds, the display scrolls through the regular operation messages. The error message will be displayed in the display sequence until the fault is rectified.

Message	Cause and corrective measures
Bfr-Srr	<p>Communication between micro-controllers is interrupted.</p> <p>The inverter disconnects itself from the power distribution grid. As soon as the error has been remedied, the inverter tries to feed into the power distribution grid again. If the inverter cannot feed into the power distribution grid after several attempts, the inverter triggers the permanent inhibition of operation.</p> <p>Corrective measures:</p> <ul style="list-style-type: none"> • Contact installer.
Derating	<p>The inverter reduces the output power due to high internal temperatures.</p> <p>Corrective measures:</p> <ul style="list-style-type: none"> • Ensure that the inverter has sufficient ventilation. • Ensure that air is emerging from the fan enclosure. If no air is emerging from the fan enclosure, clean the fan enclosure (see section 6.4).
Error AFCI	<p>The inverter has detected an electric arc in the PV system.</p> <p>Corrective measures:</p> <ul style="list-style-type: none"> • Restart the inverter (see section 5.3.3 "Resetting "Error AFCI"", page 30). • If the message occurs frequently, contact the installer.
EarthCurMax-B EarthCurMax-S	<p>The ground fault monitoring (GFDI) has detected an elevated residual current in the PV plant.</p> <p>Corrective measures:</p> <ul style="list-style-type: none"> • Contact installer.
EEPROM	<p>Temporary disturbance during reading or writing of data from the EEPROM.</p> <p>This data is not essential for safe operation. This message is for information purposes and has no effect on the performance of the inverter.</p>

Message	Cause and corrective measures
EEPROM p	Data from the EEPROM is defective. The inverter has switched itself off because the loss of data has disabled important inverter functions. Corrective measures: <ul style="list-style-type: none"> • Contact installer.
EeRestore	One of the duplicate records in the EEPROM is defective and has been reconstructed without loss of data. This message is for information purposes and has no effect on the performance of the inverter.
Fac-Bfr Fac-Srr	The AC power frequency has exceeded the permissible range. The inverter disconnects itself from the power distribution grid to prevent islanding. Corrective measures: <ul style="list-style-type: none"> • Contact installer.
GFDI Fuse Open	The grounding fuse has been tripped. Corrective measures: <ul style="list-style-type: none"> • Contact installer.
Grid-Timeout Grid-Fault-S	It was not possible to detect the system configuration of the power distribution grid. Corrective measures: <ul style="list-style-type: none"> • If the message occurs frequently, contact the installer.
Imax	Overcurrent was detected on the AC side. The current to the power distribution grid has exceeded the specifications. This may be caused by a serious system incident. Corrective measures: <ul style="list-style-type: none"> • Contact installer.
K1-Close	An internal test has failed.
K1-Open K2-Open	The inverter disconnects itself from the power distribution grid. As soon as the error has been remedied, the inverter tries to feed into the power distribution grid again. If the inverter cannot feed into the power distribution grid after several attempts, the inverter triggers the permanent inhibition of operation. Corrective measures: <ul style="list-style-type: none"> • Contact installer.

Message	Cause and corrective measures
MSD-FAC MSD-Idif MSD-VAC	<p>An internal measurement comparison error was detected.</p> <p>The measured values of the two processors (operation control unit and current control unit) are too far removed from each other.</p> <p>Corrective measures:</p> <ul style="list-style-type: none"> • Contact installer.
OFFSET	<p>The grid monitoring self-test failed.</p> <p>The inverter disconnects itself from the power distribution grid. As soon as the error has been remedied, the inverter tries to feed into the power distribution grid again. If the inverter cannot feed into the power distribution grid after several attempts, the inverter triggers the permanent inhibition of operation.</p> <p>Corrective measures:</p> <ul style="list-style-type: none"> • If the message occurs frequently, contact the installer.
ROM	<p>The internal test of the inverter control system firmware failed.</p> <p>The inverter disconnects itself from the power distribution grid. As soon as the error has been remedied, the inverter tries to feed into the power distribution grid again. If the inverter cannot feed into the power distribution grid after several attempts, the inverter triggers the permanent inhibition of operation.</p> <p>Corrective measures:</p> <ul style="list-style-type: none"> • If the message occurs frequently, contact the installer.
Shut-Down	<p>Overcurrent present at the DC input of the inverter.</p> <p>The inverter switches off.</p> <p>Corrective measures:</p> <ul style="list-style-type: none"> • Contact installer.
Vac-Bfr Vac-Srr	<p>The AC line voltage has exceeded the permissible range.</p> <p>The cause may be disconnection of the power distribution grid or an AC cable. The inverter disconnects itself from the power distribution grid to prevent islanding.</p> <p>Corrective measures:</p> <ul style="list-style-type: none"> • Contact installer.

Message	Cause and corrective measures
VacL1-Bfr VacL2-Bfr VacL1-Srr VacL2-Srr	<p>The AC input voltage is too high or too low on the indicated branch.</p> <p>The inverter disconnects itself from the power distribution grid. As soon as the error has been remedied, the inverter tries to feed into the power distribution grid again. If the inverter cannot feed into the power distribution grid after several attempts, the inverter triggers the permanent inhibition of operation.</p> <p>Corrective measures:</p> <ul style="list-style-type: none"> • Contact installer.
VpvMax !PV Overvoltage! !Disconnect DC!	<p>The DC input voltage is above the set maximum limiting value.</p> <p>Corrective measures:</p> <ul style="list-style-type: none"> • Immediately turn the rotary switch of the DC Disconnect to the Off position. • Contact installer.
Watchdog	<p>An internal program run disturbance was detected.</p> <p>The inverter disconnects itself from the power distribution grid. As soon as the error has been remedied, the inverter tries to feed into the power distribution grid again. If the inverter cannot feed into the power distribution grid after several attempts, the inverter triggers the permanent inhibition of operation.</p> <p>Corrective measures:</p> <ul style="list-style-type: none"> • Contact installer.
XFMR_TEMP_F	<p>A high transformer temperature was detected.</p> <p>The inverter ceases operation and the fan runs at maximum speed.</p> <p>Corrective measures:</p> <ul style="list-style-type: none"> • Ensure sufficient ventilation. • If the message occurs frequently, contact the installer.
XFMR_TEMP_W	<p>The inverter starts feed-in operation again once the transformer temperature has been reduced.</p> <p>Corrective measures:</p> <ul style="list-style-type: none"> • If the message occurs frequently, contact the installer.

5.3.3 Resetting "Error AFCI"

If the yellow LED is permanently glowing and the message "Error AFCI" is displayed, an electric arc has been detected in the PV system. The AFCI has been triggered and operation of the inverter is permanently inhibited.

1. Turn the rotary switch of the DC Disconnect to the **Off** position.

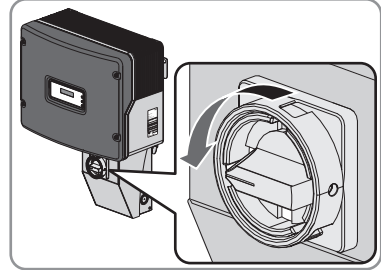

2. Wait until the display and all LEDs switch off.
3. Turn the rotary switch of the DC Disconnect to the **On** position.

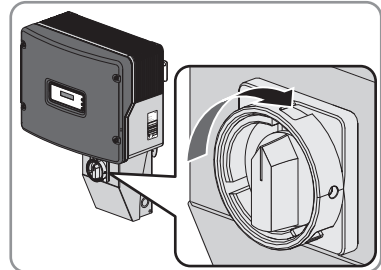

- The message "Error AFCI. Knock to reset." is displayed.
 - The message "Error AFCI. Knock to reset." is not displayed.
- Possible error cause: The disturbance was not remedied.
- Contact installer.
4. If the message "Error AFCI. Knock to reset." is displayed, tap the enclosure lid within 10 s.

- The inverter starts up.
- The inverter does not start up.

Possible error cause: You did not tap the enclosure lid within 10 s of the message appearing.

- Repeat steps 1 to 3.

6 Cleaning and Care

6.1 Checking the Inverter

- Ask the installer to check for correct inverter operation at regular intervals.
- Check whether the inverter has any visible external damage.

If the inverter has visible external damage, contact the installer.

6.2 Checking the DC Disconnect

- Check for visible external damage and discoloration of the DC Disconnect and the cables at regular intervals.

If the DC Disconnect has any visible external damage or the cables have externally visible discoloration or damage, contact the installer.

- Once a year, turn the rotary switch of the DC Disconnect from the **On** position to the **Off** position 10 times in succession. This cleans the contacts of the rotary switch and prolongs the electrical endurance of the DC Disconnect.

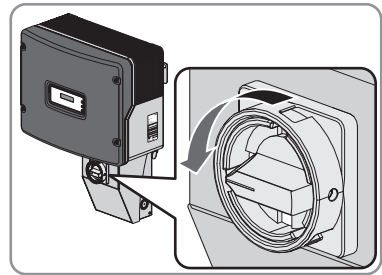

6.3 Cleaning the Inverter

- If the inverter is dirty, clean the enclosure lid, the display and the LEDs using only clean water and a cloth. Do not use any cleaning agents (e.g. solvents or abrasives) for this.

6.4 Cleaning the Fan Enclosure

If the inverter displays the message "Derating", the fan enclosure is probably dusty or dirty.

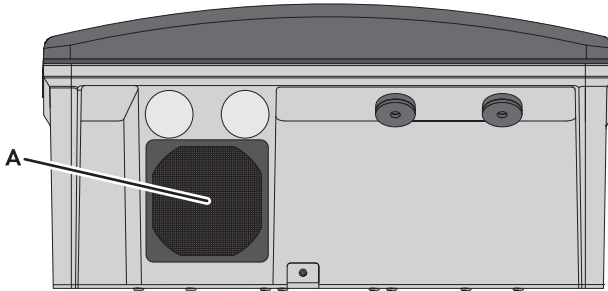

Figure 8: Position of the fan enclosure with fan

Position	Description
A	Fan enclosure with fan

- Check whether the fan enclosure is dusty or dirty.
 If the fan enclosure is dusty, clean the fan enclosure using a vacuum cleaner.
 If the fan enclosure is dirty, contact the installer.

6.5 Cleaning the Ventilation Grids

The ventilation grids must be clean for optimum heat dissipation of the device. Clean the ventilation grids regularly as follows:

1. Remove the ventilation grids to the side.

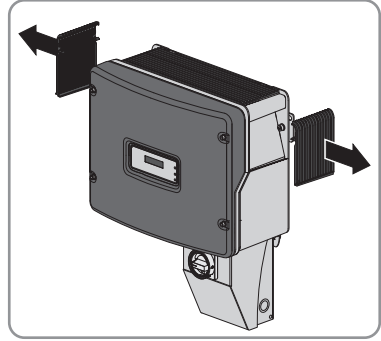

2.

NOTICE

Damage to the inverter caused by foreign bodies.

- Do not remove the ventilation grids permanently. They prevent foreign bodies from entering the enclosure.

3. Clean the ventilation grids with a soft brush, a paintbrush or compressed air.
4. Close the recessed grips with the ventilation grids. Ensure the assignment is correct. Each ventilation grid is assigned to an enclosure side on its interior: Left side "links/left" and right side "rechts/right".

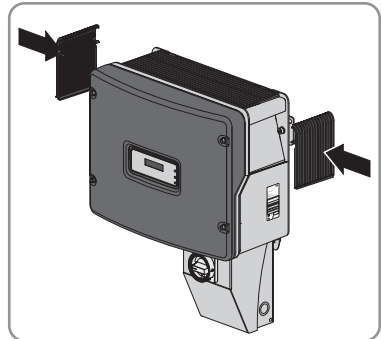

7 Compliance Information

FCC Compliance

This device complies with Part 15 of the FCC Rules. Operation is subject to the following conditions:

1. This device may not cause harmful interference, and
2. This device must accept any interference received, including interference that may cause undesired operation.

NOTE: This equipment has been tested and found to comply with the limits for a Class A & B digital device, pursuant to Part 15 of the FCC Rules. These limits are designed to provide reasonable protection against harmful interference in a residential installation. This equipment generates, uses, and can radiate radio frequency energy and, if not installed and used in accordance with the instructions, may cause harmful interference to radio communications. However, there is no guarantee that interference will not occur in a particular installation. If this equipment does cause harmful interference to radio or television reception, which can be determined by turning the equipment off and on, the user is encouraged to try to correct the interference by one or more of the following measures:

- Reorient or relocate the receiving antenna.
- Increase the separation between the equipment and the receiver.
- Connect the equipment into an outlet on a circuit different from that to which the receiver is connected.
- Consult the dealer or an experienced radio/TV technician for help.

The user is cautioned that changes or modifications not expressly approved by SMA America, Inc. could void the user's authority to operate this equipment.

IC Compliance

This device complies with Industry of Canada licence-exempt RSS standard(s). Operation is subject to the following two conditions:

- This device may not cause interference, and
- This device must accept any interference, including interferences that may cause undesired operation of the device.

8 Contact

If you have technical problems concerning our products, contact the SMA Service Line. We require the following information in order to provide you with the necessary assistance:

- Inverter device type
- Inverter serial number
- Firmware version of the inverter
- Type and number of the PV modules connected
- Mounting location and mounting height of the inverter
- LED signal and display message of the inverter
- Optional equipment, e.g. communication products

SMA Solar Technology America, LLC

6020 West Oaks Blvd, Ste 300

Rocklin, CA 95765

Tel. +1 916 625 0870

Tel. +1 877-MY SMA TECH

Tel. +1 877 697 6283 (Toll free, available for USA, Canada and Puerto Rico)

Fax +1 916 625 0871

Service@SMA-America.com

www.SMA-America.com

SMA Solar Technology Canada Inc.

2425 Matheson Blvd. E, 8th Floor

Mississauga, ON L4W 5K5

Canada

Tel. +1 877 506 1756 (Toll free, available for Canada)

Service@SMA-Canada.ca

www.SMA-Canada.ca

SMA Solar Technology

www.SMA-Solar.com

SMA America, LLC
www.SMA-America.com

