



PV Inverter

# **SUNNY BOY 5000-US / 6000-US / 7000-US / 8000-US**

**Installation Manual**





Copyright © 2011 SMA America, LLC. All rights reserved.

No part of this document may be reproduced, stored in a retrieval system, or transmitted, in any form or by any means, electronic, mechanical, photographic, magnetic or otherwise, without the prior written permission of SMA America, LLC.

Neither SMA America, LLC nor SMA Solar Technology Canada Inc. makes representations, express or implied, with respect to this documentation or any of the equipment and/or software it may describe, including (with no limitation) any implied warranties of utility, merchantability, or fitness for any particular purpose. All such warranties are expressly disclaimed. Neither SMA America, LLC nor its distributors or dealers nor SMA Solar Technology Canada Inc. nor its distributors or dealers shall be liable for any indirect, incidental, or consequential damages under any circumstances.

(The exclusion of implied warranties may not apply in all cases under some statutes, and thus the above exclusion may not apply.)

Specifications are subject to change without notice. Every attempt has been made to make this document complete, accurate and up-to-date. Readers are cautioned, however, that SMA America, LLC and SMA Solar Technology Canada Inc. reserve the right to make changes without notice and shall not be responsible for any damages, including indirect, incidental or consequential damages, caused by reliance on the material presented, including, but not limited to, omissions, typographical errors, arithmetical errors or listing errors in the content material.

All trademarks are recognized even if these are not marked separately. Missing designations do not mean that a product or brand is not a registered trademark.

The *Bluetooth*<sup>®</sup> word mark and logos are registered trademarks owned by Bluetooth SIG, Inc. and any use of such marks by SMA America, LLC and SMA Solar Technology Canada Inc. is under license.

SMA America, LLC  
3801 N. Havana Street  
Denver, CO 80239 U.S.A.

SMA Solar Technology Canada Inc.  
2425 Matheson Blvd. E, 8th Floor  
Mississauga, ON L4W 5K5, Canada

## IMPORTANT SAFETY INSTRUCTIONS

### SAVE THESE INSTRUCTIONS

This manual contains important instructions for Sunny Boy inverter, that must be followed during installation and maintenance of the inverter.

The Sunny Boy is designed and tested according to international safety requirements, but as with all electrical and electronic equipment, certain precautions must be observed when installing and/or operating the Sunny Boy. To reduce the risk of personal injury and to ensure the safe installation and operation of the Sunny Boy, you must carefully read and follow all instructions, cautions and warnings in this installation guide.

### Warnings in this document

A warning describes a hazard to equipment or personnel. It calls attention to a procedure or practice, which, if not correctly performed or adhered to, could result in damage to or destruction of part or all of the SMA equipment and/or other equipment connected to the SMA equipment or personal injury.



#### DANGER

DANGER indicates a hazardous situation which, if not avoided, will result in death or serious injury.



#### WARNING

WARNING indicates a hazardous situation which, if not avoided, could result in death or serious injury.



#### CAUTION

CAUTION indicates a hazardous situation which, if not avoided, could result in minor or moderate injury.

#### NOTICE

NOTICE is used to address practices not related to personal injury.

## Other symbols in this document

In addition to the safety and hazard symbols described on the previous pages, the following symbol is also used in this installation guide:



### Information

This symbol accompanies notes that call attention to supplementary information that you must know and use to ensure optimal operation of the system.

## Markings on this product

The following symbols are used as product markings with the following meanings.



Warning regarding dangerous voltage

The product works with high voltages. All work on the product must only be performed as described in the documentation of the product.



Beware of hot surface

The product can become hot during operation. Do not touch the product during operation.



Observe the operating instructions

Read the documentation of the product before working on it. Follow all safety precautions and instructions as described in the documentation.



Evaluated to the requirements of the Underwriters Laboratories Standard for Safety for Inverters, Converters, Controllers and Interconnection System Equipment for Use With Distributed Energy Resources, UL 1741.

## General warnings



### General warnings

All electrical installations must be done in accordance with the local and *National Electrical Code*® ANSI/NFPA 70 or the *Canadian Electrical Code*® CSA C22.1. This document does not and is not intended to replace any local, state, provincial, federal or national laws, regulation or codes applicable to the installation and use of the inverter, including without limitation applicable electrical safety codes. All installations must conform with the laws, regulations, codes and standards applicable in the jurisdiction of installation. SMA assumes no responsibility for the compliance or noncompliance with such laws or codes in connection with the installation of the inverter.

The Sunny Boy contains no user-serviceable parts except for the fans on the bottom of the enclosure and the filters behind the fans as well as the handle covers on the sides of the unit. For all repair and maintenance, always return the unit to an authorized SMA Service Center.

Before installing or using the Sunny Boy, read all of the instructions, cautions, and warnings on the Sunny Boy in this installation guide.

Before connecting the Sunny Boy to the electrical utility grid, contact the local utility company. This connection must be made only by qualified personnel.

Wiring of the Sunny Boy must be made by qualified personnel only.

# Table of Contents

<b>1</b>	<b>Information on this Manual.</b>	<b>11</b>
1.1	Validity	11
1.2	Target Group	11
1.3	Storing the Documentation	11
1.4	Additional Information	11
1.5	Nomenclature	11
<b>2</b>	<b>Safety</b>	<b>14</b>
2.1	Intended Use	14
2.2	Safety Instructions	16
2.3	Installation Overview	17
<b>3</b>	<b>Unpacking and Inspection.</b>	<b>18</b>
3.1	Scope of Delivery	18
<b>4</b>	<b>AC Voltage Configuration</b>	<b>19</b>
4.1	Opening the Sunny Boy	19
4.2	Locating Internal Component Parts	20
4.3	AC Voltage Configuration	21
4.4	Jumper for System Configuration	24
<b>5</b>	<b>Assembly.</b>	<b>26</b>
5.1	Safety	26
5.2	Requirements for the Mounting Location	27
5.3	Mounting with Wall Mounting Bracket	29
5.3.1	Possibilities for Mounting the Wall Mounting Bracket	31
5.3.2	Mounting the Wall Mounting Bracket	32
5.4	Mounting the DC Disconnect	32
5.4.1	Mounting the DC disconnect	34
5.4.2	Mounting the Sunny Boy on a Wall Mounting Bracket	35

<b>6</b>	<b>Electrical Connection</b> . . . . .	<b>36</b>
6.1	Connection Area of the Sunny Boy . . . . .	37
6.2	Sunny Boy Circuit Diagrams . . . . .	38
6.2.1	Wiring with DC disconnect . . . . .	39
6.3	Opening the Sunny Boy . . . . .	40
6.4	Opening the DC Disconnect . . . . .	41
6.5	AC Connection . . . . .	42
6.5.1	AC Connection Requirements . . . . .	42
6.5.2	AC Connection in the DC Disconnect . . . . .	43
6.5.3	Connecting the AC Cables in the Sunny Boy . . . . .	44
6.6	DC Connection . . . . .	46
6.6.1	DC Connection Requirements . . . . .	47
6.6.2	DC Input Grounding . . . . .	48
6.6.3	Connecting the DC Cables in the DC disconnect . . . . .	49
6.6.4	DC Connection with Additional DC Distribution . . . . .	54
6.7	Communication . . . . .	55
6.8	Closing the Sunny Boy . . . . .	56
6.9	Closing the DC Disconnect . . . . .	57
<b>7</b>	<b>Commissioning</b> . . . . .	<b>58</b>
7.1	Switching On the Sunny Boy . . . . .	58
7.2	The Sunny Boy Does Not Resume Operation . . . . .	59
<b>8</b>	<b>Displays and Messages</b> . . . . .	<b>62</b>
8.1	LED Operation Indicators . . . . .	63
8.2	LED Fault Indicators . . . . .	66
8.3	Status Messages on the LCD Display . . . . .	70
8.4	Setting the Display Language . . . . .	72
8.5	Measuring Channels and Parameters . . . . .	72
8.5.1	Measurement Channels . . . . .	73
8.5.2	Operating Mode . . . . .	74



8.5.3	Operating Parameters of the Sunny Boy . . . . .	74
8.5.4	Operating Parameters of the Sunny Boy . . . . .	74
8.5.5	Fixed Operating Parameters of the Sunny Boy . . . . .	77
<b>9</b>	<b>Troubleshooting . . . . .</b>	<b>78</b>
9.1	General. . . . .	78
9.2	Error Messages. . . . .	78
<b>10</b>	<b>Maintenance. . . . .</b>	<b>81</b>
10.1	Cleaning the Fans . . . . .	81
10.2	Cleaning the Handle Covers . . . . .	83
10.3	Checking the DC Disconnect . . . . .	83
10.4	Fan Test. . . . .	84
10.5	Exchanging the Fuses . . . . .	85
10.5.1	Exchanging the GFDI Fuse within the Sunny Boy . . . . .	86
10.5.2	Exchanging PV String Fuses within the DC disconnect . . . . .	86
10.6	Testing and Replacing the DC Varistors . . . . .	88
<b>11</b>	<b>Technical Data . . . . .</b>	<b>91</b>
11.1	Sunny Boy 5000-US (SB 5000US and SB 5000US-12) . . . . .	91
11.2	Sunny Boy 6000-US (SB 6000US and SB 6000US-12) . . . . .	93
11.3	Sunny Boy SB 7000-US (SB 7000US and SB 7000US-12) . . . . .	95
11.4	Sunny Boy SB 8000-US (SB 8000US and SB 8000US-12) . . . . .	97
11.5	DC Disconnect . . . . .	99
11.6	Trip Limits/Trip Times. . . . .	100
11.7	Torque Values and Cable Sizes . . . . .	101
<b>12</b>	<b>Spare Parts and Accessories. . . . .</b>	<b>101</b>
<b>13</b>	<b>Compliance Information . . . . .</b>	<b>102</b>
<b>14</b>	<b>Contact . . . . .</b>	<b>103</b>



# 1 Information on this Manual

## 1.1 Validity

This guide describes the mounting, installation, commissioning and maintenance of the following SMA inverters:

- Sunny Boy 5000-US (SB 5000US and SB 5000US-12)
- Sunny Boy 6000-US (SB 6000US and SB 6000US-12)
- Sunny Boy 7000-US (SB 7000US and SB 7000US-12)
- Sunny Boy 8000-US (SB 8000US and SB 8000US-12)

This guide does not contain any information on the devices that are connected to the Sunny Boy. Information concerning the connected devices is available from the manufacturers of the devices.

## 1.2 Target Group

This manual is for qualified personnel. Qualified personnel have received training and have demonstrated skills and knowledge in the construction and operation of this device. Qualified personnel are trained to deal with the dangers and hazards involved in installing electric devices.

## 1.3 Storing the Documentation

Store all manuals for the Sunny Boy in such a way that they may be accessed at any time.

## 1.4 Additional Information

Additional information on specific topics can be found in the download area at [www.SMA-America.com](http://www.SMA-America.com).

## 1.5 Nomenclature

In this document, SMA America Production, LLC and SMA Solar Technology Canada Inc. will be referred to as SMA.





## 2 Safety

### 2.1 Intended Use

The Sunny Boy is a PV inverter which converts the DC current of the PV array to AC current and feeds it into the power distribution grid. The Sunny Boy is suitable for use with fuel cells, small wind turbine systems, and other DC current sources. The Sunny Boy takes the current from a DC source and converts it into AC power for the power distribution grid. This power is then supplied to the local consumers (C). Surplus energy is fed into the power distribution grid (E). Due to the power that is consumed by the local devices, the amount of power required from the power distribution grid is reduced. An energy surplus may even result in the energy meter (D) of your plant running backward. This power may also be recorded as power credits by the electric utility company depending on the interconnection agreement.

#### Principle of a PV Plant with a Sunny Boy

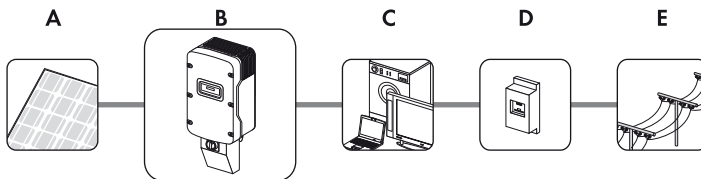

Position	Description
A	PV array
B	Sunny Boy with DC disconnect
C	Local consumers
D	Energy meter
E	Power distribution grid

#### Ground Fault Detection and Interruption in the PV Array

All Sunny Boy inverters have a system for detecting ground fault errors in the PV array (GFDI) according to the *National Electrical Code*® 690.5.

The PV array is operated in a grounded configuration. Depending on the plant type, the negative or positive conductor of the PV array is connected to the grounding system in the Sunny Boy. According to UL 1741, the GFDI protection is always active when sufficient DC voltage is present to switch on the LC display in the Sunny Boy.

If a ground fault current larger than 1 A is flowing, the Sunny Boy switches off and displays the interference. After the ground fault has been located and eliminated, the ground fault interference must be cleared manually. Following this, the Sunny Boy resumes operation.

## Arc Fault Circuit Interrupter AFCI

Only the following Sunny Boy types are equipped with an automatic arc fault circuit interrupter (AFCI):

- SB 5000US-12
- SB 6000US-12
- SB 7000US-12
- SB 8000US-12

Edition 2011 of the *National Electrical Code*<sup>®</sup>, Section 690.11, requires that all PV plants attached to a building are fitted with a means of detecting and interrupting serial electric arcs (AFCI) on the PV side.

An electric arc with a power of 300 W or greater must be interrupted by the AFCI in the time specified by UL 1699B. A triggered AFCI may only be reset manually.

The arc fault circuit interrupter (AFCI) can be deactivated in the "Electrically qualified person" mode via the communication device if this function is not desired.

## Anti-Islanding Protection

A stand-alone grid is a status. It occurs when the power distribution grid is switched off and the Sunny Boy is in operation. For this to happen, the remaining load must be resonant at 60 Hz and exactly match the power of the Sunny Boy. Although the appearance of these conditions is extremely unlikely, the Sunny Boy has an active safety algorithm to protect against islanding. The effect of this is that, in the event of the power distribution grid being switched off, the PV plant does not supply any power to a symmetrical load that is resonant at 60 Hz. In addition, the Sunny Boy regularly feeds leading and lagging reactive currents into the power distribution grid. This procedure is checked by the certification body in order to destabilize and switch off a stand-alone grid status.

## Operating Temperature

The Sunny Boy delivers full performance in ambient temperatures up to +113 °F (+45 °C). Due to the fan cooling, this level of performance can be achieved in closed rooms. The Sunny Boy does remain operational above +113 °F (+45 °C), but it reduces the level of performance so as to protect the internal component parts from overheating.

## Interconnection Code Compliance

The Sunny Boy has been checked by the certification body and certified according to the guidelines in UL 1741 Static Inverters and Charge Controllers for use in Photovoltaic Power Systems, IEEE 929-2000 Recommended Practice for Utility Interface of Photovoltaic Systems, and IEEE 1547 Standard for Interconnecting Distributed Resources with Electric Power Systems.



UL 1741 is the standard that is used for the Sunny Boy by the certification body in order to certify that it complies with the regulations in *National Electrical Code*<sup>®</sup> and IEEE 929-2000. IEEE 929-2000 states recommendations regarding the appropriate equipment and functionality that is required to guarantee fault-free operation when the power generation is connected to the power distribution grid.

The Sunny Boy is also certified according to *Canadian Electrical Code*<sup>®</sup> CSA C22.2 NO. 107.1-01 (General Use Power Supplies).



Prior to setting up and installing your PV plant, contact the on site grid operator or the responsible authority.

## 2.2 Safety Instructions

 <b>DANGER</b>
<p>High voltages in the inverter</p> <p>Electric shock when touching live components.</p> <ul style="list-style-type: none"> <li>• Prior to performing any work on the inverter, disconnect the inverter from any voltage sources.</li> <li>• Only connect the inverters as described in this manual.</li> <li>• Only electrically qualified persons may work on the inverter.</li> </ul>

 <b>CAUTION</b>
<p>The inverter can become hot during operation</p> <ul style="list-style-type: none"> <li>• Burn injuries may be possible when touching the enclosure.</li> <li>• During operation, touch the enclosure lid only.</li> </ul> <p>The Sunny Boy may down over due to inappropriate transport</p> <p>Contusions or bone fractures due to the heavy weight of the Sunny Boy.</p> <ul style="list-style-type: none"> <li>• Prior to transporting the Sunny Boy, take its weight of 148 lb. (67 kg) into consideration.</li> <li>• Use suitable lifting techniques for the transport.</li> </ul>



## 2.3 Installation Overview

This section provides a brief overview of the installation process of a Sunny Boy.

### Section 3: Unpacking and Inspection

This section provides instructions and information on unpacking the Sunny Boy and inspecting shipping damage.

### Section 4: AC Voltage Configuration

This section contains information on removing the cover, determining the position of the fundamental component parts in the inverter and selecting the suitable voltage configuration for the installation.

### Section 5: Mounting

This section provides guidelines to help you choose the best mounting location, recommendations for achieving optimal performance, safety measures and warnings to prevent injuries and/or damage to the device, and step-by-step instructions for mounting the Sunny Boy inverter.

### Section 6: Wiring the Sunny Boy

This section contains guidelines for selecting the correct line cross-section, safety measures and warnings to prevent injuries and/or damage to the device, and step-by-step instructions for connecting the Sunny Boy to a PV array, to an electric circuit in the home, and to the power distribution grid. Procedures are also included for connecting optional data communication cables.

### Section 7: Commissioning

Commissioning comprises applying DC input power to the Sunny Boy, observing the LED and LCD displays, and resolving any problems that occur.

### Section 8: Displays and Messages

This section provides information on messages that may appear during commissioning and operation.

### Section 9: Troubleshooting

This section provides information for troubleshooting and procedures for resolving problems that may occur during commissioning and operation.

### Section 10: Maintenance

This section contains the maintenance and cleaning of the Sunny Boy and safety measures and warnings for preventing injuries and damage to the device.

### Section 11: Technical Data

This section contains the technical data of the Sunny Boy, connection diagrams, and the correct tightening torques for connecting the cables and screws to the Sunny Boy.

### 3 Unpacking and Inspection

Check the delivery for completeness and any visible external damage. Contact your SMA specialty retailer or SMA if the delivery is incomplete or you find any damage.

If it is necessary to send the Sunny Boy back, use the original packaging.

Contact information is provided in the "Contact" section, page 103.

#### 3.1 Scope of Delivery

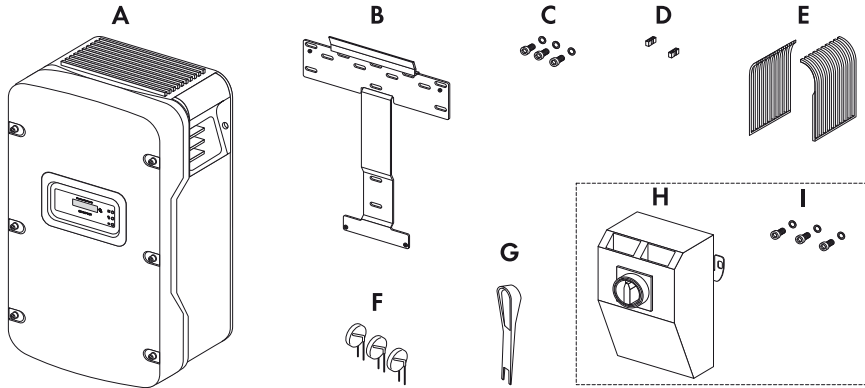

Position	Quantity	Description
A	1	Sunny Boy
B	1	Wall mounting bracket
C	1	Replacement screw and replacement conical spring washers for connecting the enclosure lid to the Sunny Boy.
	2	Screws and washers for fastening the Sunny Boy to the wall mounting bracket
D	2	Spare jumpers for fan test
E	2	Handle covers (left and right)
F	3	DC varistors*
G	1	Insertion tool for DC varistors*
H	1	DC Disconnect
I	1	Screw and washer for closing the DC Disconnect lid
	2	Screws and washers for fastening the DC Disconnect to the wall-mounting bracket

\* only SB 5000US-12/SB 6000US-12/SB 7000US-12/SB 8000US-12

## 4 AC Voltage Configuration

### 4.1 Opening the Sunny Boy

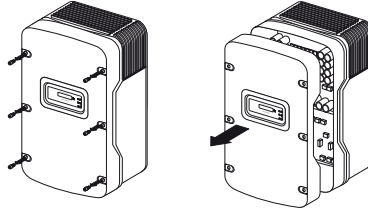

1. Remove the six screws and conical spring washers from the enclosure cover. Pull the cover forward smoothly.
2. Put the cover, screws, and conical spring washers to one side so that they do not get in the way.

#### NOTICE

Ingress of moisture when mounting and installing the Sunny Boy

Potential damage to the Sunny Boy.

- For conduit hubs, use UL listed raintight, wet location hubs for entry into the enclosure.
- Do not open the Sunny Boy in the event of rain or a high level of humidity (> 95 %).

Damage to the seal of the enclosure lid during frost

When opening the Sunny Boy during frost, the seal of the enclosure lid can be damaged. There may be an ingress of moisture damaging the Sunny Boy.

- Do not open the Sunny Boy when the outdoor temperature is below 23 °F ( - 5 °C).

Electrostatic discharges through touching component parts

Potential damage to the Sunny Boy.

- Ground yourself before touching any electronic component.

## 4.2 Locating Internal Component Parts

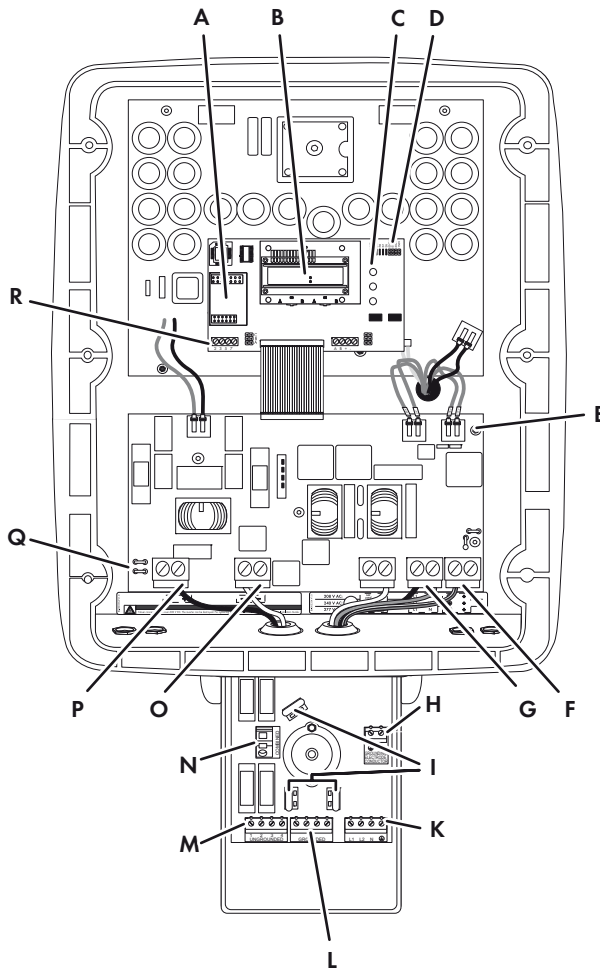

Position	Description
A	Sockets for optional communication Piggy-Back (RS485 or wireless)
B	Display
C	Status LEDs
D	Jumpers for configuring the AC voltage and the fan test
E	Terminal blocks for configuring the AC voltage
F	Ground terminal (PE)

Position	Description
G	Output AC conductor terminals (N, L1, and L2)
H	Connecting terminal plate, PV grounding conductor, + DC grounding conductor
I	DC varistor terminal with DC varistors *
K	Output AC conductor terminals (L1, L2, N and PE)
L	Terminal PV GROUNDED (PV array input)
M	Terminal PV UNGROUNDED (PV array input)
N	Combined terminal UNGROUNDED
O	Terminal DC - (PV array input)
P	Terminal DC+ (PV array input)
Q	Flat male tab for grounding the cable shield for communication
R	Terminal for optional communication (RS485)

\* only SB 5000US-12/SB 6000US-12/SB 7000US-12/SB 8000US-12

### 4.3 AC Voltage Configuration

**i** The Sunny Boy 8000-US must not be connected to a 208 V grid.

The Sunny Boy is compatible with the following grid types:

- 208 V AC (not Sunny Boy 8000-US)
- 240 V AC
- 277 V AC

The Sunny Boy is configured ex works for connection to the power distribution grid with a voltage of 240 V AC. The Sunny Boy can be configured for other voltages.

4 cables are inserted into the enclosure via a cable support sleeve. Each cable is labeled with its respective voltage.

1. Connect the cable with the correct voltage to the left terminal block (A).
2. To adjust the AC voltage, select the cable with the correct voltage at the right terminal block (C). Connect the selected cable to the left side of the left terminal block (A).
3. Secure all screw terminals. If spring-type terminals are available, close the levers of the terminals by pressing down.

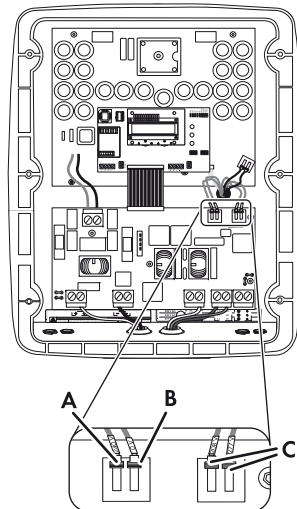

Tightening torque of the screw terminals for the left terminal block:

Gray terminal blocks (Weidmüller)	18 in-lb. (2 Nm)
Green terminal blocks (Phoenix)	22 in-lb. (2.5 Nm)



Do not remove the cable in the left terminal block with the marking 0 V (B). This always remains connected to the right side of the left terminal block.

- Connect and fasten all cables not being used to the right terminal block (C). Tightening torques of the screw terminals for the right terminal block (cables not being used):

Gray terminal blocks (Weidmüller)	11 in-lb. (1.2 Nm)
Green terminal blocks (Phoenix)	15 in-lb. (1.7 Nm)



If the Sunny Boy is configured for the wrong input voltage, this error message appears in the display:

Disturbance  
XFMR

- Check if the configuration of the AC voltage is correct.

## Automatic Grid Voltage Detection

The Sunny Boy automatically detects the grid voltage that it must feed in. Depending on the voltage and the phase angle between L1-N and L2-N, the inverter determines whether it is connected to a 208 V, 240 V, or 277 V grid. If the Sunny Boy is configured for the wrong grid voltage (for example, the inverter was configured for 240 V and then connected to a 208 V grid), the Sunny Boy displays an error message.

The table below contains the limiting values for voltage and frequency in the AC terminal:

Voltage range for 208 V nominal value, phase-phase (not Sunny Boy 8000-US)	183 V ... 229 V
Voltage range for 240 V nominal value, phase-phase	211 V ... 264 V
Voltage range for 277 V nominal value, phase-neutral conductor	244 V ... 305 V
Frequency range	59.3 Hz ... 60.5 Hz

If the power distribution grid uses a neutral conductor, the responsible authority can demand that a neutral conductor be connected to the inverter.

To set the configuration jumpers, observe the procedure in 4.4 "Jumper for System Configuration" (page 24).

To connect a neutral conductor to the Sunny Boy, observe section 6.5.2 "AC Connection in the DC Disconnect" (page 43) or section "AC Connection in the DC Disconnect" on page 43.

## Configuration of Grid Voltage

The figure on the next page illustrates common grid forms. Note that it is not the phase relationship that is important when connecting the Sunny Boy to the power distribution grid, but the voltage compatibility.

480 Delta: 277 WYE

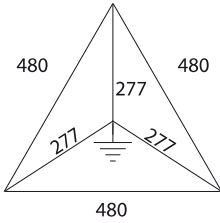

208 Delta: 120 WYE

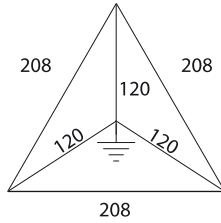

\* 240: 120 Split Phase

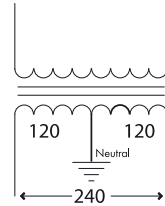

240 Delta: 120 Stinger

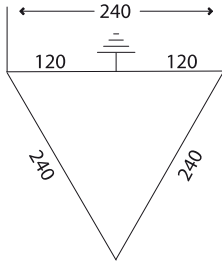

240 Delta

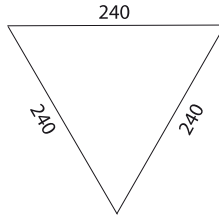

208 Delta \*

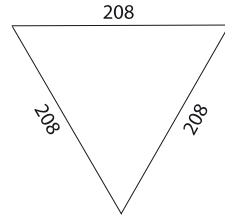

480 Delta  
DO NOT USE!

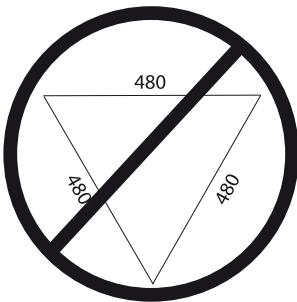

240 Delta:  
Corner grounded

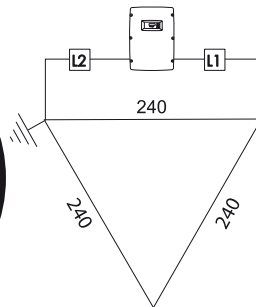

208 Delta:  
Corner grounded \*

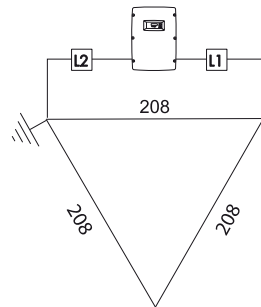

\*The Sunny Boy 8000-US must not be connected to a 208 V grid.



**When using grounded 240 V or 208 V Delta grids:**

- Connect terminal L2 to the grounded phase.

## 4.4 Jumper for System Configuration

By setting the jumper, you configure the Sunny Boy for different grid topologies. This means that operation in system configurations without neutral conductors, such as 208 V and 240 V Delta, is possible. The following figure provides an overview of the standard settings, the settings for grids without neutral conductors, and the settings for the fan test.



**In the event of frost, the fan cannot be inspected**

The fans are not activated under 32 °F (0 °C).

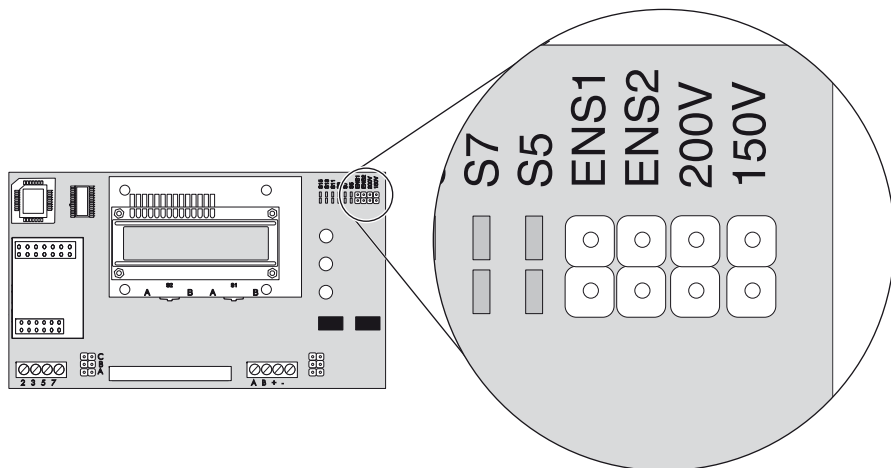

208V with neutral conductor\*240 V with neutral conductor or 277 V



208 V Delta, without neutral conductor or \*  
208 V Delta, grounded \*



240 V Delta, without neutral conductor or  
240 V Delta, grounded



Fan test

\* The Sunny Boy 8000-US must not be connected to a 208 V grid.



The following figures display the correct arrangement of the jumpers for the 240 V Delta system configuration: Note the order in which the inverters are connected to the phases.

**Configuration Examples for Jumpers with 240 V Delta, 120 V Stinger**

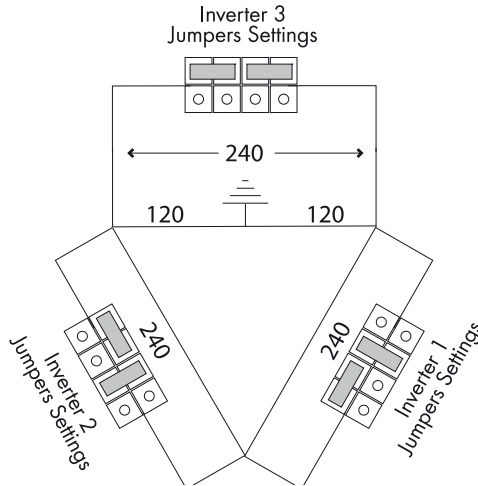

**Configuration Examples for Jumpers with 240 V Delta, Grounded**

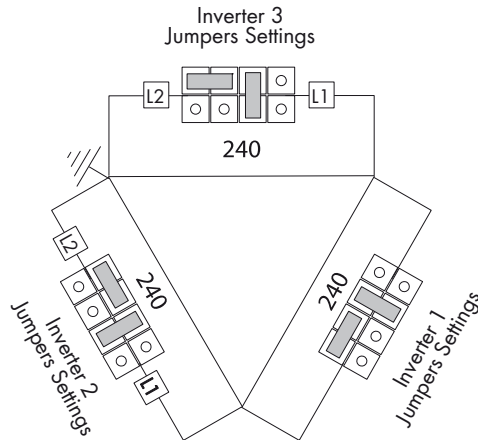

**When using grounded 240 V or 208 V Delta grids**

- Connect terminal L2 to the grounded phase.

## 5 Assembly

### 5.1 Safety



#### DANGER

Danger to life due to fire or explosions.

With electrical devices, there is always a certain danger that a fire may break out.

- Do not install the inverter in the vicinity of combustible materials.
- Do not install the inverter in potentially explosive areas.



#### CAUTION

The Sunny Boy may fall down due to inappropriate mounting

Contusions or bone fractures due to the heavy weight of the Sunny Boy.

- When mounting the Sunny Boy, take its weight of 148 lb. (67 kg) into consideration.
- Use appropriate mounting material for the mounting location of the inverter:
  - For mounting on plasterboard, do not use hollow wall anchors or toggle bolts.
  - Wooden supporting posts must be present behind the installation points on plasterboard.
- Use suitable lifting technique when mounting.

The inverter can become hot during operation

Burn injuries may be possible when touching the enclosure.

- Install the inverter in such a way that it cannot be touched accidentally.

## 5.2 Requirements for the Mounting Location

### Observe the following conditions during installation:

- The installation method and mounting location must be suitable for the weight and dimensions of the Sunny Boy (see section 11 "Technical Data" (page 91)).
- Note the dimensions of the DC disconnect (Page 34).
- Mount the inverter on a stable surface.
- The mounting location must be accessible at all times.

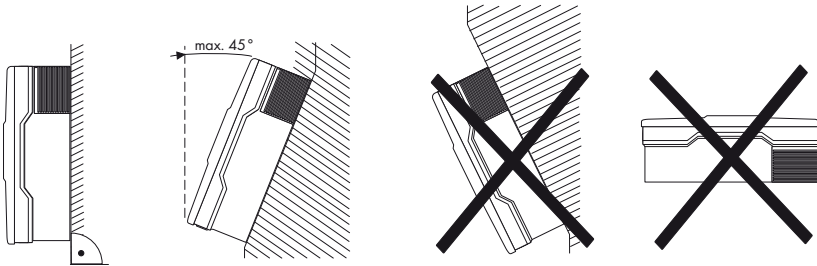

- Mount vertically or tilted backward at max. 45°.
- The connection area must point downward.
- Do not install the inverter tilting forward.
- Do not install the inverter horizontally.
- Install the inverter at eye level in order to be able to read out the operating state at any time.
- The ambient temperature must be below +113 °F (+45 °C).
- Do not expose the inverter to direct sunlight.
- In the living area, do not install inverters on a plasterboard wall or similar wall.

The Sunny Boy may emit noises when in use which can be regarded as a nuisance.

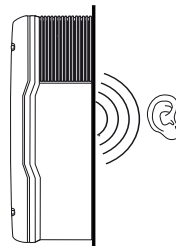

- Observe recommended clearances to the walls as well as to other inverters or objects. Thus, you will prevent the inverter's power output from being reduced due to excessive temperatures.



The *National Electrical Code*® may stipulate greater clearances (see *National Electrical Code*®, Section 110.26). Installations in Canada must be carried out in accordance with the applicable Canadian standards.

- If several inverters are mounted in areas with high ambient temperatures, increase the clearances and ensure a sufficient fresh-air supply. Thus, you will prevent the inverter power from being reduced due to too high temperatures.

**Recommended clearances**

Position	Clearance
Top	12 in. (300 mm)
Bottom	36 in. (900 mm)
Left	12 in. (300 mm)
Right	12 in. (300 mm)
Front	2 in. (50 mm)

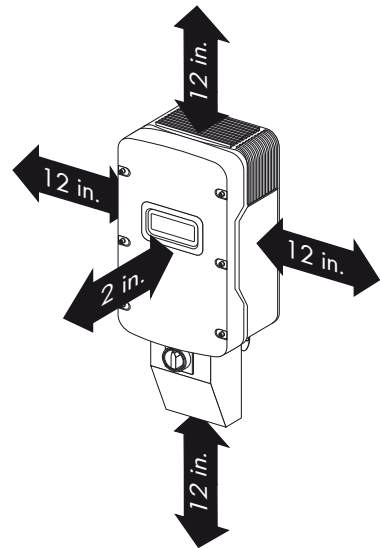

**If the Sunny Boy is installed outdoors**

- Observe minimum clearance to the ground of 36 in. (900 mm).

### Dimensions of the Sunny Boy

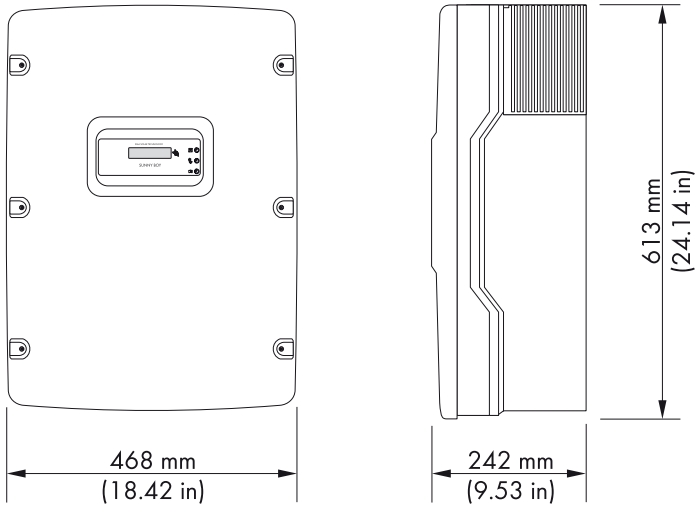

### 5.3 Mounting with Wall Mounting Bracket

The Sunny Boy is supplied with a T-shaped wall mounting bracket that is suitable for most walls. The wall must be vertical and stable enough to carry a weight of 145 lb. (67 kg) for a long period of time. For the wall material, use suitable fastening elements no smaller than ¼ in.

### Dimensions of the Wall Mounting Bracket

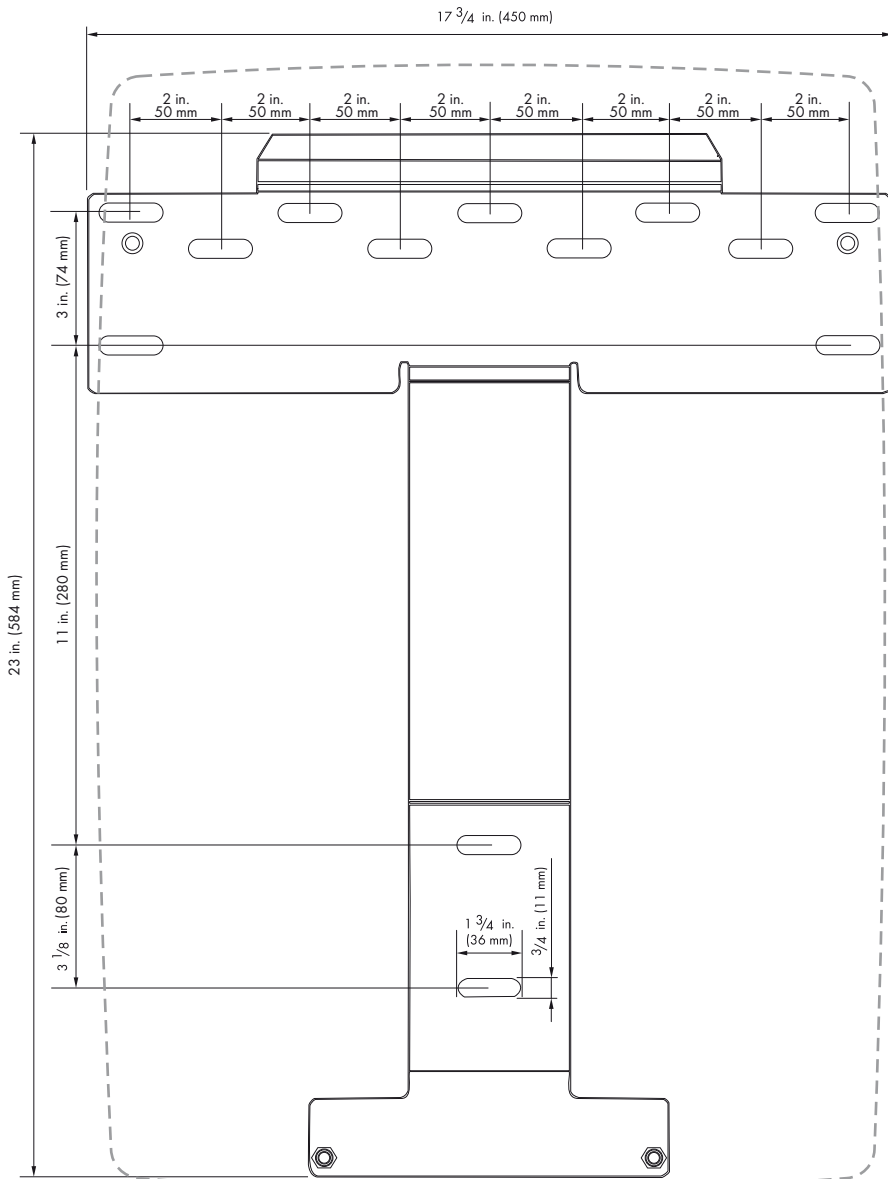

## 5.3.1 Possibilities for Mounting the Wall Mounting Bracket

### Mounting on a Stone Wall

Secure the wall mounting bracket with at least 3 screws. The position of the screws on the wall mounting bracket is as follows:

- 1 screw on the upper left side.
- 1 screw on the upper right side.
- 1 screw below.

Mount the wall mounting bracket as described in section 5.3.2 "Mounting the Wall Mounting Bracket" (page 32).

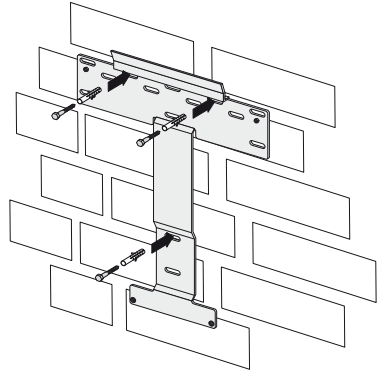

### Mounting on a Wooden Wall with a Stud or on a Pillar

Secure the wall mounting bracket with at least 3 screws. The position of the screws on the wall mounting bracket is as follows:

- 2 screws at the upper middle.
- 1 screw below.

Mount the wall mounting bracket as described in section 5.3.2 "Mounting the Wall Mounting Bracket" (page 32).

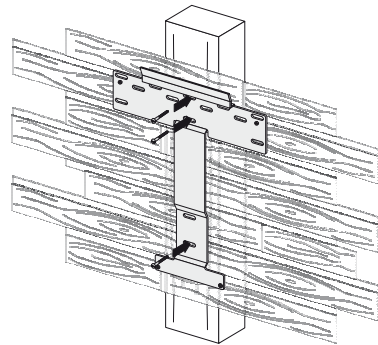

### Mounting on a Wooden Wall with Two Studs

Secure the wall mounting bracket with at least 4 screws. The position of the screws on the wall mounting bracket is as follows:

- 2 screws on the upper left side.
- 2 screws on the upper right side.

Use the four outer mounting holes on the left and right sides of the wall mounting bracket.

Mount the wall mounting bracket as described in section 5.3.2 "Mounting the Wall Mounting Bracket" (page 32).

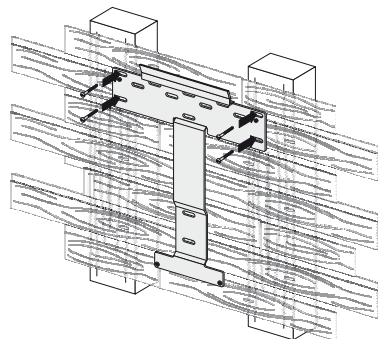

### 5.3.2 Mounting the Wall Mounting Bracket

1. Position the wall mounting bracket at the installation location. If possible, select eye level.
2. Align the wall mounting bracket with a spirit level. The bottom end of the wall mounting bracket reaches approximately to the bottom corner of the inverter.



#### WARNING

Electric shock due to damaged electric cables

Electric cables may be located behind the installation points which can be damaged when mounting the inverter.

- Ensure that no electric cables are located behind the installation points.

3. Use the wall mounting bracket as a template. Mark at least 3 holes in the horizontal or vertical position of the wall mounting bracket (see section 5.3.1 "Possibilities for Mounting the Wall Mounting Bracket" (page 31)).
4. Remove the mounting bracket and drill the holes at the markings.



#### Information for the installation

The diameter of the bore holes must correspond to the fastening elements that you use for mounting the inverter.

Mounting on a concrete wall:

- The hole diameter must be the same as the outer diameter of the screw anchors.
- Insert suitable screw anchors into the bore holes.

Mounting on a wall with wooden studs:

- The hole diameter must correspond to the screw diameter used. The screws should be stainless steel. The diameter of the screws must correspond to the diameter of the holes in the wall mounting bracket. The screws must be long enough to reach a depth in the wall of 1 1/2 in.

5. Insert the screws into the bore holes through the holes in the wall mounting bracket.
6. Tighten the screws clockwise until the wall mounting bracket hangs securely on the wall.

### 5.4 Mounting the DC Disconnect

#### Inserting the DC varistors



The supplied DC varistors must only be used for the following inverter types:  
SB 5000TLUS-12/SB 6000US-12/SB 7000US-12/SB 8000US-12.



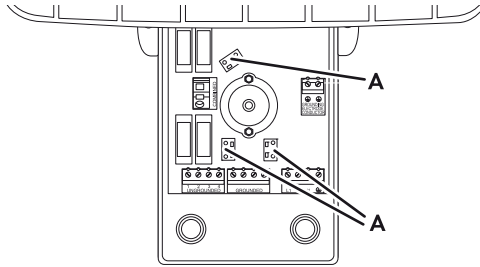

Position	Description
A	Terminals for DC varistors

1. Open the DC disconnect as described in Section 6.4 "Opening the DC Disconnect" (page 41).

2. Equip the 3 terminals (A) with DC varistors:

- Insert the insertion tool into the rectangular opening of the terminal.

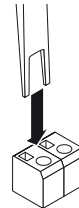

- Insert the DC varistor into the terminal.

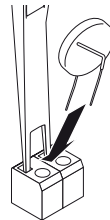

- Pull the insertion tool out of the rectangular opening of the terminal.

3. Ensure that all DC varistors in the terminals are securely in place.

4. Close the DC disconnect as described in Section 6.9 "Closing the DC Disconnect" (page 57).

### 5.4.1 Mounting the DC disconnect

#### Dimensions of the DC Disconnect

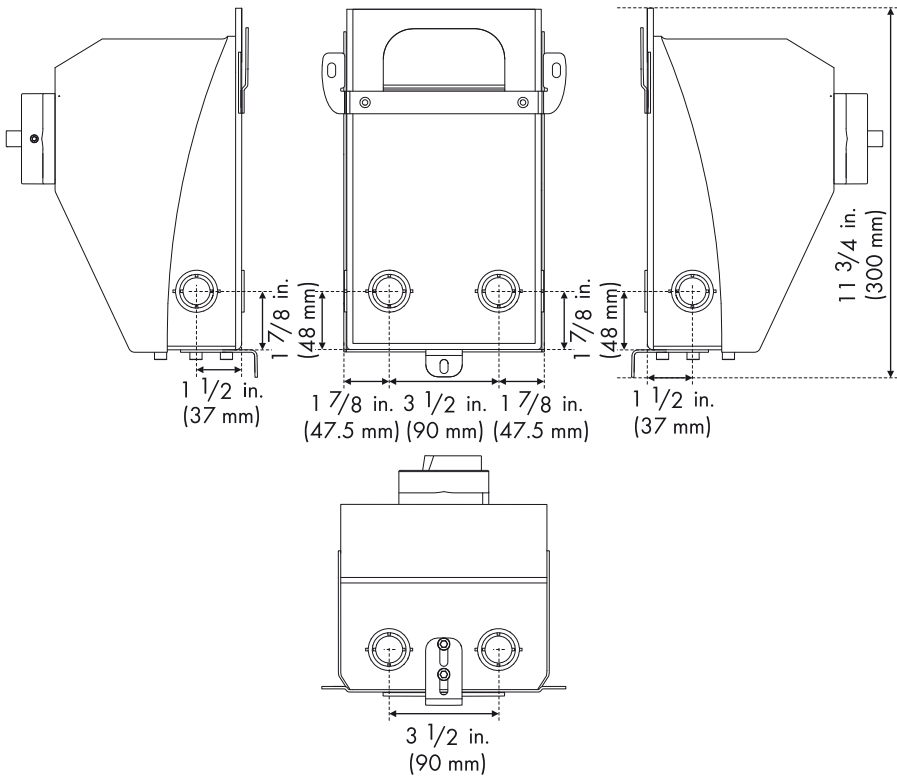

Attach the DC disconnect to the two lower holes of the wall mounting bracket using the two screws and washers provided.

1. Insert the screws with the washers through the holes of the anchorage brackets of the DC disconnect. The teeth of the washers must lie on the anchorage brackets of the DC disconnect.
2. Put the DC disconnect onto the wall mounting bracket.
3. Tighten the screws with a tightening torque of 44 in-lb. (5 Nm).

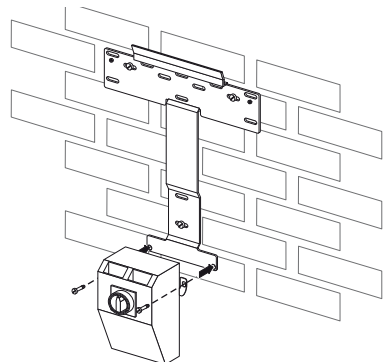

## 5.4.2 Mounting the Sunny Boy on a Wall Mounting Bracket



### CAUTION

The Sunny Boy may fall down due to inappropriate mounting  
Contusions or bone fractures due to the heavy weight of the Sunny Boy.

- Transport the Sunny Boy between two persons, using the side handles above and below.

or

- Put a steel bar with a maximum diameter of  $1\frac{1}{8}$  in. (30 mm) through the enclosure opening above and transport it between two people.

1. Remove the handle covers on the right and left side of the Sunny Boy.
2. Hook the Sunny Boy with the enclosure opening onto the rear panel in the wall mounting bracket. The Sunny Boy must be seated on the middle of the wall mounting bracket.

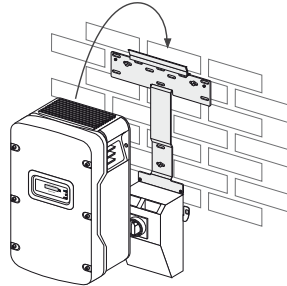

3. Screw the Sunny Boy onto the wall mounting bracket on both sides with the screws supplied.
4. Tighten the screws clockwise with a tightening torque of 44 in-lb. (5 Nm).

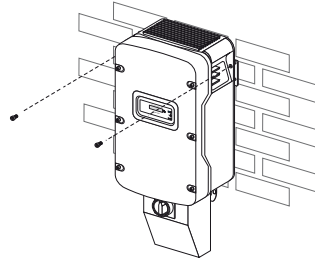

5. Place handle covers on the handles.  
To help you identify the sides, the ventilation grids are marked "rechts/right" and "links/left" on the inside.

The ventilation grids prevent dirt and insects from entering the inverter and can be reordered from SMA if required. See section 12 "Spare Parts and Accessories" (page 101).

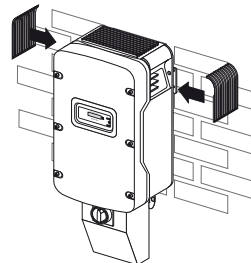

## 6 Electrical Connection



### DANGER

High voltages on the AC and DC cables

Risk of death or serious injury due to electric shock.

- Only connect the inverters as described in this manual.
- Only electrically qualified persons may work on the inverter.

### NOTICE

Ingress of moisture when mounting and installing the Sunny Boy

Potential damage to the Sunny Boy.

- For conduit hubs, use UL listed raintight, wet location hubs for entry into the enclosure.
- Do not open the Sunny Boy in the event of rain or a high level of humidity (> 95 %).

Damage to the seal of the enclosure lid during frost

When opening the Sunny Boy during frost, the seal of the enclosure lid can be damaged. There may be an ingress of moisture damaging the Sunny Boy.

- Do not open the Sunny Boy when the outdoor temperature is below 23 °F ( - 5 °C).

Electrostatic discharges through touching component parts

Potential damage to the Sunny Boy.

- Ground yourself before touching any electronic component.

Ground faults, unreliable and highly resistive connections due to *Wire Nuts*<sup>®</sup>

Potential damage to or failure of the Sunny Boy.

- Do not use *Wire Nuts*<sup>®</sup>.



### Electrical Installations

All electrical installations must be carried out according to the applicable electrical standards on site and the *National Electrical Code ANSI/NFPA 70*. Installations in Canada must be carried out according to the applicable Canadian standards.

Before connecting the Sunny Boy to the power distribution grid, contact your local electric utility company. This connection must be made only by qualified personnel.

## AC Grounding



### The AC outputs and the neutral conductors are not connected with PE

The circuits of the AC input and the AC output are isolated from the enclosure. The electrically qualified person is responsible for grounding the plant according to Section 250 of the *National Electrical Code* ANSI/NFPA 70.

The Sunny Boy must be connected to the AC grounding conductor of the power distribution grid via the ground terminal (PE) (see section 4.2 “Locating Internal Component Parts” (page 20)).

## PV Grounding

The grounding conductor in the framework of the PV array must be connected to the PV grounding conductor and the DC grounding conductor (see section 4.2 “Locating Internal Component Parts” (page 20)). The cross-section of the grounding conductor corresponds to the cross-section of the largest conductor in the DC system.

The PV array is operated in a grounded configuration. The grounding of a PV plant is established as per the specifications of Section 690.41 to 690.47 of the *National Electrical Code* ANSI/NFPA 70 and is the responsibility of the electrically qualified person. Installations in Canada must be carried out in accordance with the applicable Canadian standards.

## DC Grounding Conductor

A DC grounding conductor may be required by the Authority Having Jurisdiction (AHJ). Use the connecting terminal plate for the PV grounding conductor and DC grounding conductor (see section 4.2 “Locating Internal Component Parts” (page 20)).

## 6.1 Connection Area of the Sunny Boy

The DC input of the PV array and the output of the AC power distribution grid are connected inside the enclosure. The internal AC and DC connecting terminal plates are designed for a maximum size of 6 AWG. Suitable enclosure openings are on the underside of the Sunny Boy.

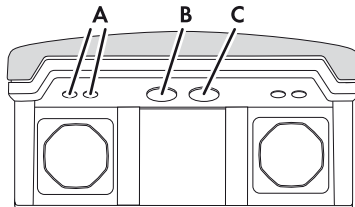

Position	Description
A	1/2 in. screws for communication cable with filler-plugs
B	3/4 in. DC opening with double membrane adapter
C	3/4 in. AC opening with double membrane adapter

## 6.2 Sunny Boy Circuit Diagrams

### Sunny Boy Connections for 208 V and 240 V AC Grids

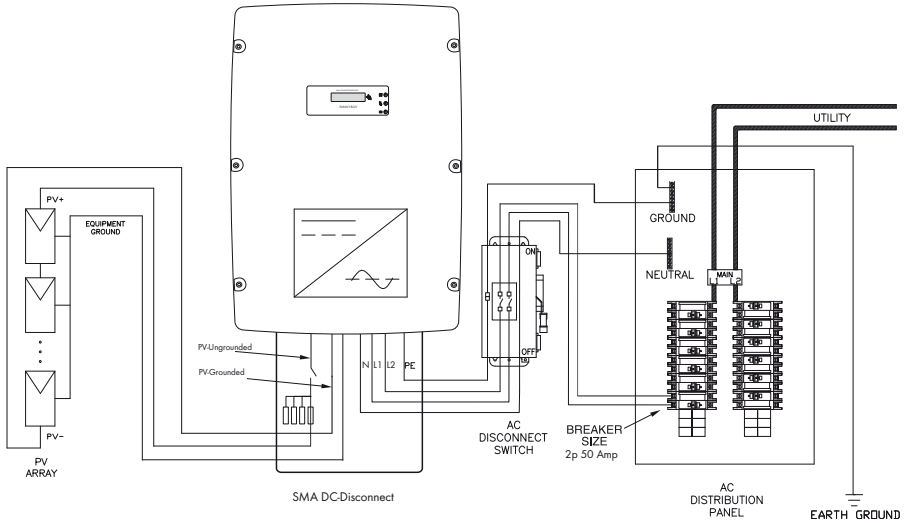

### Sunny Boy Connections for 277 V AC Grids

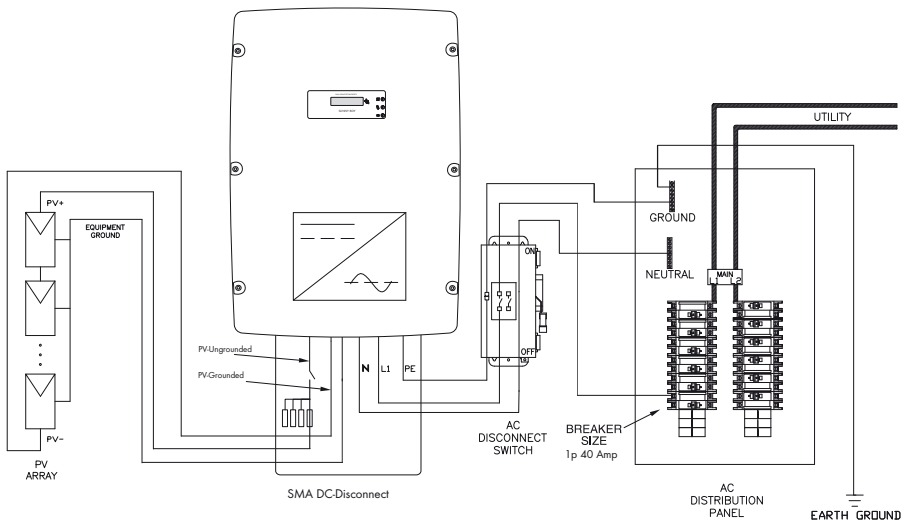

## 6.2.1 Wiring with DC disconnect

### Procedure and Order

1. Switch off all energy sources. Open all AC and DC disconnect switches and breakers.
2. Wiring from AC breaker to DC disconnect.
3. AC wiring from DC disconnect to Sunny Boy.
4. Wiring from PV array to DC disconnect.
5. DC wiring from DC disconnect to Sunny Boy.
6. Switch DC disconnect to position "1".
7. Switch on AC breaker.



### Removing Sunny Boy from Wiring

- Disconnect all AC disconnect switches.
- Switch DC disconnect to position "0".
- Always disconnect the AC side before the DC side.
- When the Sunny Boy is switched off, remove the wiring in reverse order.

## 6.3 Opening the Sunny Boy



### DANGER

High voltages are present in the Sunny Boy during operation.

Death or serious injury due to electric shock.

- Only open the Sunny Boy in the order described as follows.

1. Switch off all AC and DC breakers or switch-disconnectors. Ensure they cannot reconnect accidentally.
2. Wait at least 5 minutes until the residual voltage has been drained.
3. Remove the 6 screws and conical spring washers from the enclosure lid. Pull the lid smoothly off forwards.

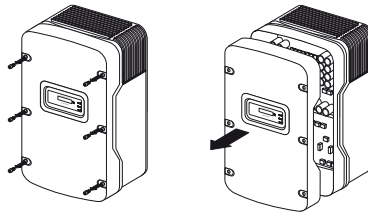

### NOTICE

Moisture can penetrate the open Sunny Boy

Potential damage to the Sunny Boy.

- Do not open the Sunny Boy in the event of rain or a high level of humidity (> 95 %).
- Handle the enclosure lid with care.

Damage to the seal of the enclosure lid during frost

When opening the Sunny Boy during frost, the seal of the enclosure lid can be damaged.

There may be an ingress of moisture damaging the Sunny Boy.

- Do not open the Sunny Boy when the outdoor temperature is below 23 °F ( - 5 °C).

Electrostatic discharges through touching component parts

Potential damage to the Sunny Boy.

- Ground yourself prior to touching a component part.

- The Sunny Boy is open.



## 6.4 Opening the DC Disconnect

1. Switch the DC disconnect to "0".

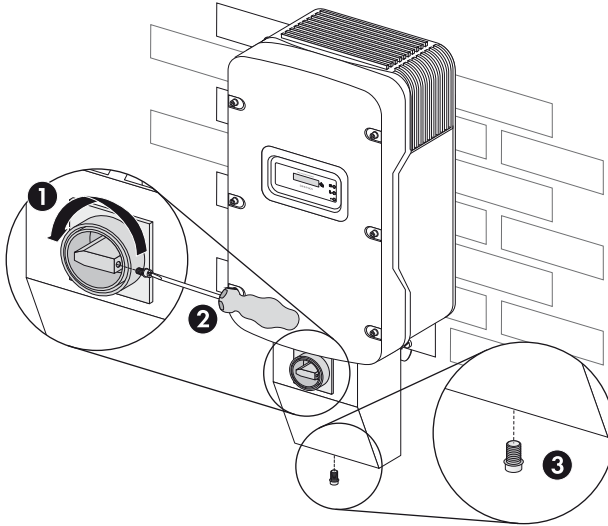

2. Loosen the screw on the rotary switch of the DC disconnect. Use a cross-head screwdriver (screw used: UNC no.  $5 \times \frac{3}{4}$  in., cross-head, flat-head, metal).



**Do not fully remove the screws.**

- If the rotary switch of the DC disconnect cannot be removed, loosen the screw further.

3. Remove the screw and the washer of the cover on the underside of the DC disconnect.
4. Remove the rotary switch.
5. Remove the cover of the DC disconnect:
  - Pull the cover on the underside forward.
  - In the process, simultaneously remove it from the enclosure.

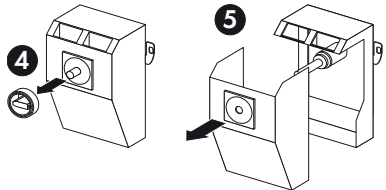

**DANGER**

High voltages at the DC terminals with connected PV modules  
Risk of death or serious injury when touching the DC terminal.

- Do not touch any live component of the DC terminals.

- The DC disconnect is open.

## 6.5 AC Connection



### CAUTION

Risk of fire

Overcurrent may lead to a cable fire.

- The electrical installation must include overvoltage protection for the AC output circuit.
- Set up the overvoltage protection for a maximum of 50 A.



Carry out all electrical installations according to all of the applicable on-site electrical standards and the *National Electrical Code*<sup>®</sup> (NE, ANSI/NFPA 70).

See *National Electrical Code*, Section 690-64(b) (2).

For installations in Canada, observe the applicable Canadian standards.

### 6.5.1 AC Connection Requirements

For all AC cable connections to the Sunny Boy, use a max. 6 AWG copper wire that is designed for +194 °F (+90 °C) – even if voltage drop and other considerations mean that the use of larger cable cross-sections is required.



#### Only use solid wire or stranded wire

- Do not use fine-wire strands.
- Use the free of charge "Sunny Design" at [www.SMA-America.com](http://www.SMA-America.com) to design your PV plant.

#### Ambient temperature

The higher the ambient temperature, the higher the power losses.

- Use cables with large cable cross-sections in installation sites with high ambient temperatures.

#### Routing method

The cables heat up during operation. If there are several cables in a conduit, the temperature of all cables increases.

- Use cables with a large cross-section if you lay several cables in one conduit.

## 6.5.2 AC Connection in the DC Disconnect



### If you replace an existing inverter

- In the switchbox, disconnect the cables for the AC line on which you are working.
1. Switch off the main switch in the main switchbox.
  2. Install a  $\frac{3}{4}$  in. cable gland in the breakout opening for the AC cables of the DC disconnect.
  3. Between the main switchbox and the breakout opening for the AC cables of the DC disconnect, install a  $\frac{3}{4}$  in. cable conduit.
  4. Pull the AC cables from the switchbox through the cable conduit into the DC disconnect.



### Open terminals fully before feeding through the cables

5. Connect the AC device grounding conductor to the PE terminal labeled  $\oplus$  in the DC disconnect.

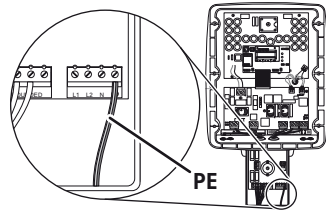

## 208 V and 240 V System Configuration

Do not connect the Sunny Boy 8000-US to a 208 V grid.

6. Connect conductor L1 (AC conductor 1 or UNGROUNDED) to terminal L1.
7. Connect conductor L2 (AC conductor 2) to terminal L2.
8. Connect conductor N (AC conductor N) to terminal N.

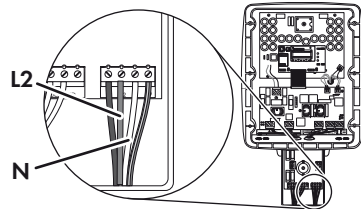
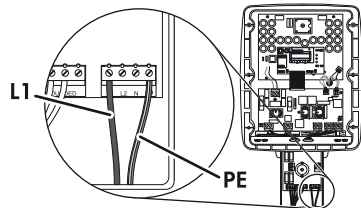

### When using grounded 240 V or 208 V Delta grids

- Connect terminal L2 to the grounded phase.

## 277 V System Configuration

9. Connect conductor L1 (AC conductor 1 or UNGROUNDED) to terminal L1. Do not use terminal L2.
10. Connect conductor N (AC conductor N) to terminal N.

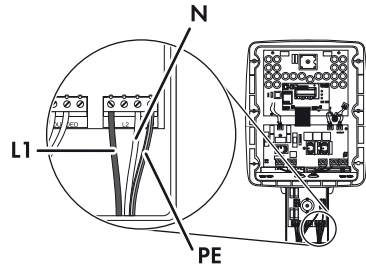

11. Tighten the cables with a torque of 15 in-lb. (1.7 Nm).
12. Check that all terminals have the correct wiring and that the cables are secure.

### 6.5.3 Connecting the AC Cables in the Sunny Boy

1. Using a screwdriver, make a hole in the rubber grommet in the inverter.

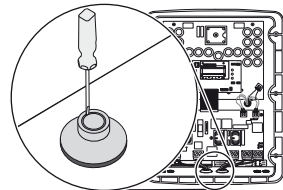

2. Remove the rubber membrane.

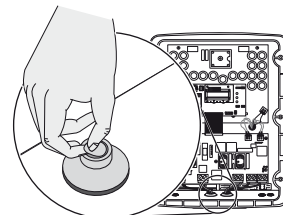

3. Feed the cable through the rubber grommet into the inverter.

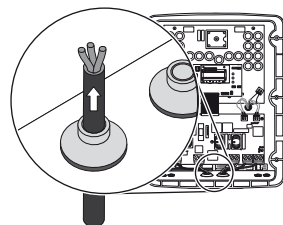

4. Pull the cable back slightly so as to seal the rubber grommet.

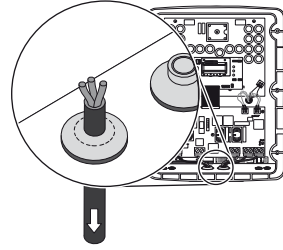

5. Connect the green-yellow cable of the SMA DC disconnect to the terminal labeled  $\oplus$ .

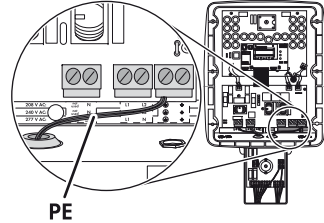

### 208 V and 240 V System Configuration

Do not connect the Sunny Boy 8000-US to a 208 V grid.

6. Connect the white cable of the DC disconnect to the terminal labeled N. Connect the black cable of the DC disconnect to the terminal labeled L1.

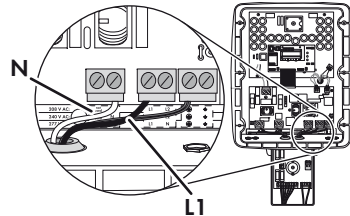

7. Connect the red insulated conductor to the terminal labeled L2.

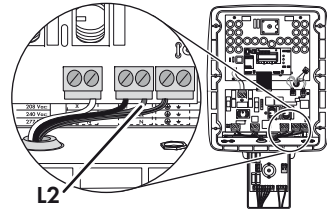

### 277 V System Configuration

8. Connect the white cable of the DC disconnect to the terminal labeled N. Connect the black insulated conductor of the DC disconnect to the terminal labeled L1.
9. Connect the red insulated conductor to the terminal labeled  $\perp$ .

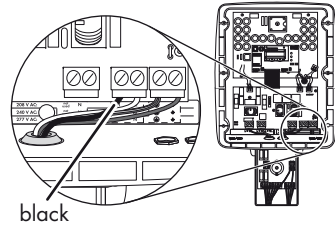

10. Tighten the AC terminal blocks in the inverter with the following torques:

Gray terminal blocks (Weidmüller)	10 ... 6 AWG: 18 in-lb. (2 Nm)
Green terminal blocks (Phoenix)	8 ... 6 AWG: 40 in-lb. (4.5 Nm)
	10 AWG: 22 in-lb. (2.5 Nm)

11. Check that all terminals have the correct wiring and that the cables are secure.

## 6.6 DC Connection

**DANGER**

High voltages on PV modules that are exposed to light  
 Risk of death due to electric shock from touching a DC conductor.

- Do not touch the DC conductor.

High voltages in the DC cables  
 Risk of death or serious injury from touching a DC cable.

- Only connect the DC cable from the PV module to the inverter as described in this manual.

**NOTICE**

Potential damage to the inverter due to overvoltage.

- The DC input voltage of the PV modules must not exceed the maximum values of the inverter. Observe the information on the type label.
- Check the polarity and the open-circuit voltage of the PV strings before connecting the DC cables to the inverter.
- Configure the DC input voltage range accordingly before connecting the PV modules to the inverter. Use "Sunny Design" on [www.SMA-America.com](http://www.SMA-America.com) for string configuration.

## Simplified Circuit Diagram of a PV Plant

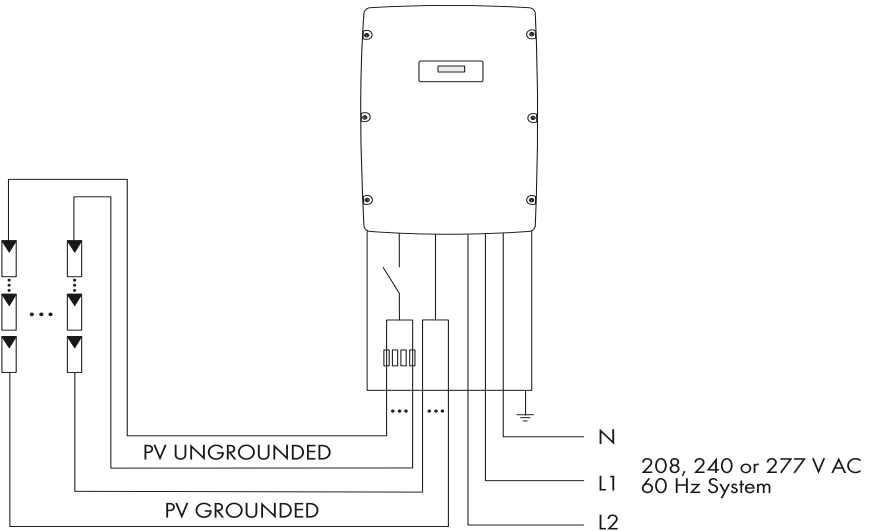

### 6.6.1 DC Connection Requirements

#### Cable Dimensioning

All electrical installations must be carried out according to all of the applicable on-site electrical standards and the *National Electrical Code*® ANSI/NFPA 70 or the *Canadian Electrical Code*® CSA C22.1 and the applicable standards in Canada.

When selecting the cable type and the line cross-section, observe the following requirements depending on the type of installation:

- For all DC copper wire cable connections, use size 10 ... 6 AWG (6 ... 16 mm<sup>2</sup>), which is designed for +194 °F (+90 °C).
- Use only solid wire or rough wire strands. Do not use fine-wire strands.
- Route the PV lines precisely in the entire PV plant and do not coil.



#### Correct String Configuration

- Use "Sunny Design" on [www.SMA-America.com](http://www.SMA-America.com) for string configuration.

## Fuses

The DC disconnect for the inverter must have a minimum rating of 600 V DC and 36 A continuous. The DC disconnect is supplied with 4 fuses (one fuse per string) designed for 15 A and 600 V DC. The 4 fuses of the DC disconnect may be used for a maximum of 20 A and 600 V DC.

When dimensioning the fuses, observe the *National Electrical Code*® 690.8 and 690.9.

### 6.6.2 DC Input Grounding

The Sunny Boy is configured ex works for plants with negative PV array grounding. Certain types of PV modules may make it necessary to ground the negative pole rather than the positive pole.

#### Position of the GFDI Fuse and the Jumper for Negative Grounding

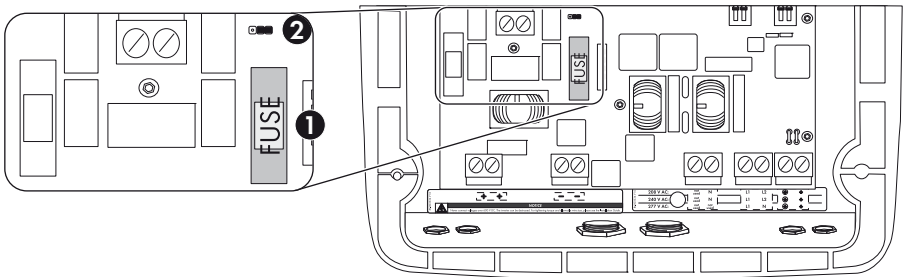

1. Insert the fuse in position (1).
2. Insert the jumper in position (2).

#### Position of the GFDI Fuse and the Jumper for Positive Grounding

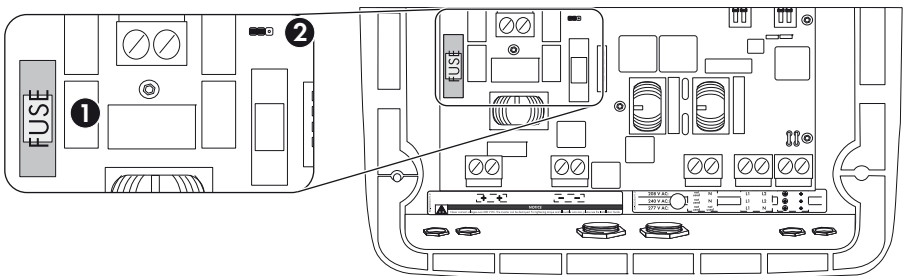

1. Insert the fuse in position (1).
2. Insert the jumper in position (2).



### 6.6.3 Connecting the DC Cables in the DC disconnect



Fully open the terminal before feeding through the cables

1. Open the AC breaker and secure against turning on again.
2. Install a  $\frac{3}{4}$  in. cable gland in the breakout opening for the DC cables of the DC disconnect. The breakout opening is on the left side of the DC disconnect. Secure the cable gland to the inner side of the SMA DC disconnect with the matching locknut.
3. Install a  $\frac{3}{4}$  in. cable conduit between the enclosure of the DC disconnect and the PV array.
4. Pull the DC cables, the grounding cables of the PV array, and the grounding conductor through the cable conduit and inside the SMA DC disconnect.



The DC disconnect has provisions for up to 4 PV strings. The terminal blocks PV UNGROUNDED and PV GROUNDED each have 4 termination points. This means that 4 pairs of DC input cables can be connected in parallel.

5. Connect the grounding cable of the PV array to the terminal (A) for the grounding conductor.
6. Connect the grounding conductor to the terminal (B) for the grounding conductor.

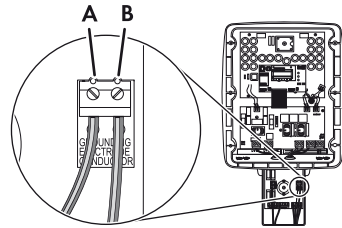

## Negative Grounding



In order to check whether your inverter is grounded as intended, observe section 6.6.2 "DC Input Grounding" (page 48).

7. Connect the positive DC cables to the terminal (A) labeled PV UNGROUNDED in the DC disconnect.

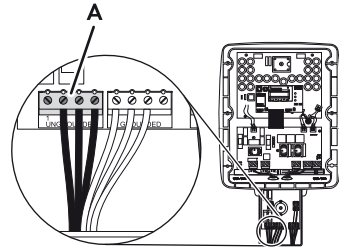

8. Connect the negative DC cables to the terminal (A) labeled PV GROUNDED in the DC disconnect.

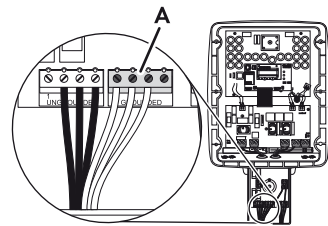

9. Tighten all cables in the terminal blocks in the DC disconnect with a torque of 15 in-lb. (1.7 Nm).
10. Using a screwdriver, make a hole in the left sealing grommet.

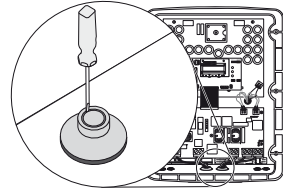

11. Remove the rubber membrane.

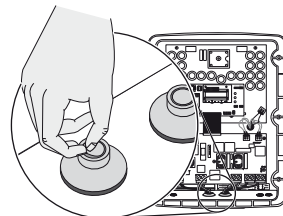

- Pull the DC cables from the SMA DC disconnect inside the Sunny Boy.

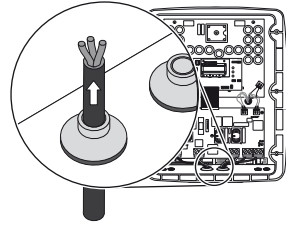

- Pull the cable back slightly so as to seal the sealing grommet.

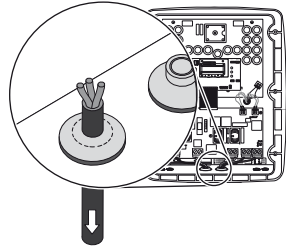

- Connect the black cable (PV UNGROUNDED) to the terminal labeled DC+ in the Sunny Boy.

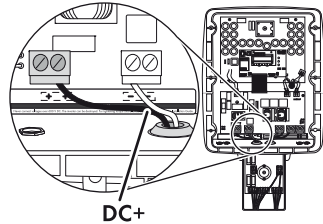

- Connect the white cable (PV GROUNDED) to the terminal labeled DC - in the Sunny Boy.

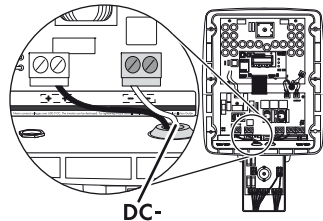

- Tighten all cables in the AC and DC terminal blocks in the Sunny Boy:

Gray terminal blocks (Weidmüller)	10 ... 6 AWG: 18 in-lb. (2 Nm)
Green terminal blocks (Phoenix)	8 ... 6 AWG: 40 in-lb. (4.5 Nm)
	10 AWG: 22 in-lb. (2.5 Nm)

- Check whether all connections are correctly wired. Carry out a tensile test to see whether all cables are tight.

## Positive Grounding



In order to check whether your inverter is grounded as intended, observe section 6.6.2 "DC Input Grounding" (page 48).

1. Connect the negative DC cable to the terminal labeled PV UNGROUNDED (A) in the DC disconnect.

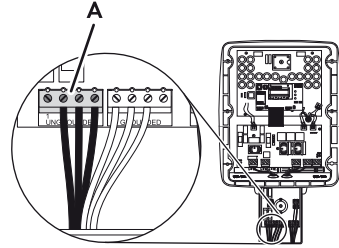

2. Connect the positive DC cable to the terminal labeled PV GROUNDED (A) in the DC disconnect.

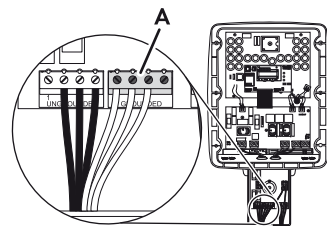

3. Tighten all cables in the terminal blocks in the DC disconnect with a torque of 15 in-lb. (1.7 Nm).
4. Using a screwdriver, make a hole in the left sealing grommet.

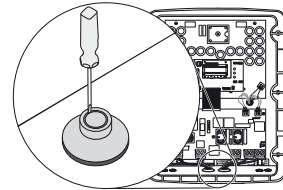

5. Remove the rubber membrane.

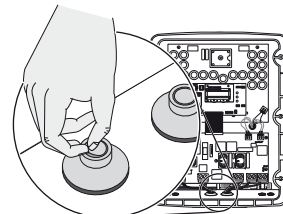

- 6. Pull the DC cables from the SMA DC disconnect inside the Sunny Boy.

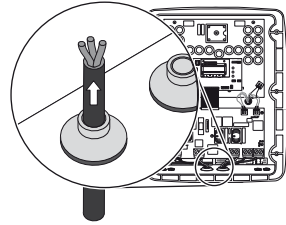

- 7. Pull the cable back slightly so as to seal the sealing grommet.

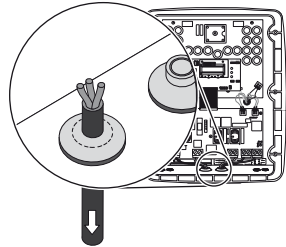

- 8. Connect the white cable (PV GROUNDED) to the terminal labeled DC+ in the Sunny Boy.

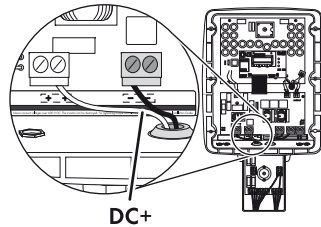

- 9. Connect the black cable (PV UNGROUNDED) to the terminal labeled DC - in the Sunny Boy.

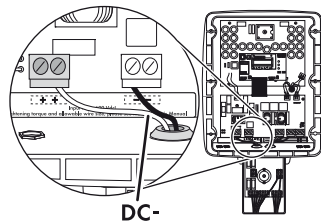

- 10. Tighten all cables in the AC and DC terminal blocks in the SMA DC disconnect:

Gray terminal blocks (Weidmüller)	10 ... 6 AWG: 18 in-lb. (2 Nm)
Green terminal blocks (Phoenix)	8 ... 6 AWG: 40 in-lb. (4.5 Nm)
	10 AWG: 22 in-lb. (2.5 Nm)

- 11. Check whether all connections are correctly wired. Carry out a tensile test to see whether all cables are tight.

## 6.6.4 DC Connection with Additional DC Distribution

For a parallel connection of more than 1 string in front of the integrated DC disconnect, use the COMBINED terminal on the non-grounded side.

### Using the Spring Terminal labeled COMBINED

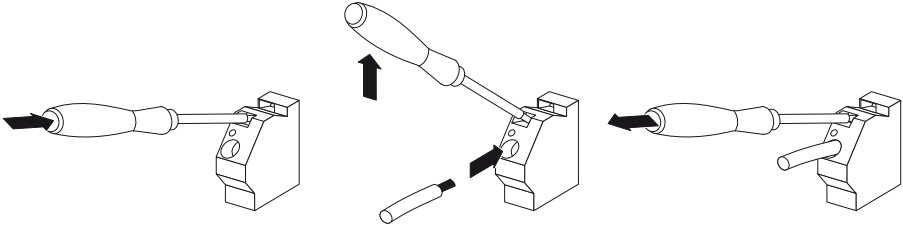

1. Insert an insulated screwdriver into the slot in the spring terminal provided.
2. Press the screwdriver upward.
  - ☑ The spring terminal is open.
3. Feed the stripped cable into the spring terminal.
4. Pull the screwdriver back into its original position.
5. Remove the screwdriver.
  - ☑ The spring terminal is closed and the cable is fixed.
6. Pull on the cable to check whether it is secure.

### Negative Grounding

1. Connect the positive DC cable to the terminal (A) labeled COMBINED in the DC disconnect.
2. Connect the negative DC cable (B) to the terminal labeled PV GROUNDED in the DC disconnect.

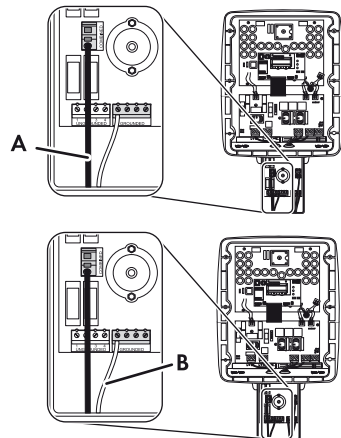

3. Tighten all cables in the terminal blocks in the DC disconnect with a torque of 15 in-lb. (1.7 Nm).

## Positive Grounding

1. Connect the negative DC cable to the terminal (A) labeled COMBINED in the DC disconnect.
2. Connect the positive DC cable to the terminal (B) labeled PV GROUNDED in the DC disconnect.

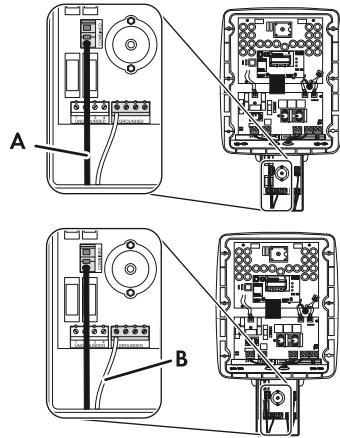

3. Tighten all cables in the terminal blocks in the DC disconnect with a torque of 15 in-lb. (1.7 Nm).

## 6.7 Communication

The Sunny Boy can be equipped with a communication interface in order to communicate with SMA communication products.

You will find further information and a list of applicable communication products at [www.SMA-America.com](http://www.SMA-America.com).

## 6.8 Closing the Sunny Boy



### NOTICE

Damage to the enclosure lid may affect the seal between the enclosure lid and the enclosure.

There may be an ingress of moisture.

Potential damage to the Sunny Boy.

- Handle the enclosure lid with care.
- Check the seal on the inner side of the enclosure lid for damage.
- When closing, no moisture may remain in the enclosure.

1. Mount the enclosure lid onto the Sunny Boy. The 6 holes in the cover must be aligned with the 6 thread bores of the enclosure.



### Check the line routing

Cables must not obstruct the seal of the enclosure lid. The enclosure lid must not exert any pressure on the connections.

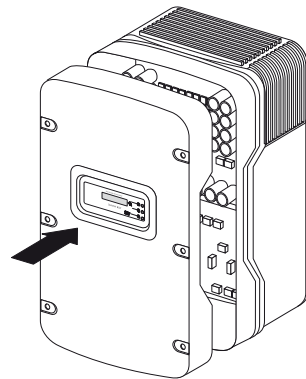

2. Hold the enclosure lid. Tighten the 6 screws with the conical spring washers through the holes in the enclosure lid into the threaded bores of the enclosure.



### The tothing of the conical spring washers must point toward the enclosure lid

Do not damage the thread of the screws.

Do not use power tools to tighten the screws.

3. Check whether the enclosure lid is laying evenly on the enclosure.
4. Tighten the 6 screws with 53 in-lb. (6 Nm).

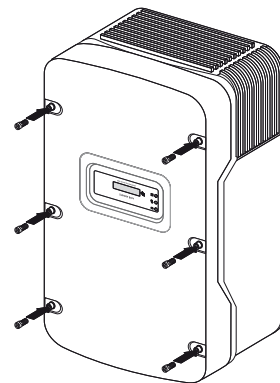

### All fastening elements are required for the grounding and weatherproof sealing of the Sunny Boy

- To fasten the enclosure lid, use all 6 screws with conical spring washers.



## 6.9 Closing the DC Disconnect



All string fuses must be securely mounted

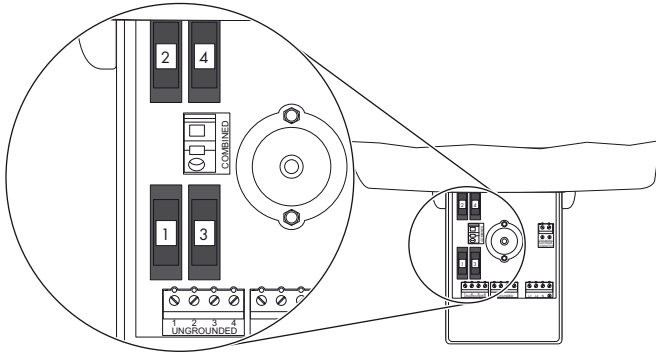

1. Mount the cover onto the DC disconnect and insert the rotary handle. Turn the rotary handle to position "0".
2. Tighten the screw on the right side of the rotary handle. Use a cross-head screwdriver (screw used: UNC no.  $5 \times \frac{3}{4}$  in. cross-head, flat-head).
3. Insert the screw and conical spring washer of the DC disconnect into the underside. Tighten the screw with a torque of 44 in-lb. (5 Nm).

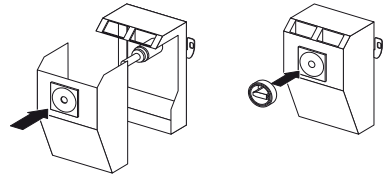

The tooting of the conical spring washer must point toward the cover for the DC disconnect to be grounded

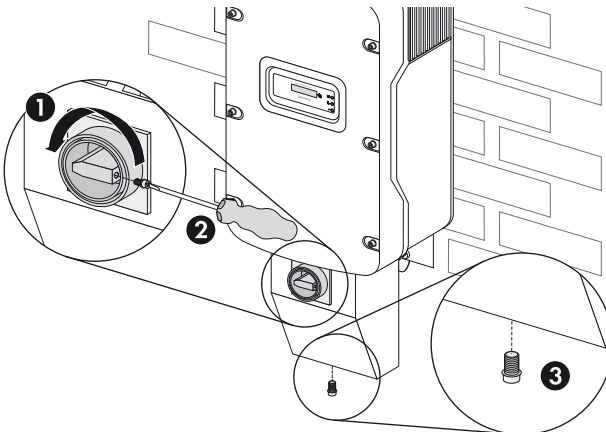

## 7 Commissioning



### DANGER

High voltages in the PV plant when exposed to sunlight.

Risk of death or serious injuries due to incorrect commissioning.

- Only commission the Sunny Boy in the following order.
- Do not insert the GFDI fuse into the Sunny Boy without a fuse holder.

### 7.1 Switching On the Sunny Boy

1. Remove all covers from the PV array.
2. Switch on the AC main conductor breaker.
3. Turn the DC disconnect to position "1".

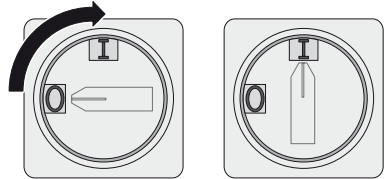

- The Sunny Boy performs an AFCI self-test.



#### AFCI self-test

Only the following types of Sunny Boy perform an AFCI self-test:

- SB 5000US-12
- SB 6000US-12
- SB 7000US-12
- SB 8000US-12

- ☑ If the AFCI self-test is successful: The Sunny Boy goes into "Waiting" mode and the green LED flashes. The "Waiting" mode ends when solar irradiation reaches a certain level. The green LED lights up permanently and the Sunny Boy feeds into the power distribution grid.



or

- ☑ If the AFCI self-test fails: The yellow LED flashes. The Sunny Boy repeats the AFCI self-test until it is successful. Observe section 7.2 "The Sunny Boy Does Not Resume Operation" (page 59).



If the feed-in to the power distribution grid was interrupted by a detected AC failure and then resumed, the inverter waits 5 minutes before feeding in again.

For this, the input voltage must be greater than the start voltage of the Sunny Boy. For the corresponding values, see section 11 "Technical Data" (page 91).

If the inverter is not able to feed into the power distribution grid three times in a row, it waits 10 minutes before the next attempt.

## 7.2 The Sunny Boy Does Not Resume Operation

**DANGER**

Danger to life due to high voltages in the PV system.  
Risk of death or serious injury due to electric shock.

- Only qualified personnel may perform work on the PV array.

- Watch the display and the LEDs.
- Observe section 8 "Displays and Messages" (page 62) and section 9 "Troubleshooting" (page 78).

### No Operation Despite Sufficient Irradiation

1. Check whether the input voltage is sufficient. For the input voltage values, see 11 "Technical Data" (page 91).
2. If the input voltage is not sufficient, perform troubleshooting in the PV array and rectify the fault.  
or
3. If the input voltage is sufficient, contact the SMA Service Line. Observe section 14 "Contact" (page 103).

## The Message "Disturbance AFCI" Is Displayed

An electric arc occurred in the PV system. The yellow LED is continuously lit up. The AFCI has been triggered and operation of the Sunny Boy is permanently inhibited.



**CAUTION**

Danger of fire from electric arc

- Only test the AFCI for false triggering in the order described below.
- Do not deactivate the AFCI permanently.

1. Turn the DC disconnect to position "0".

Wait for the display to go out.

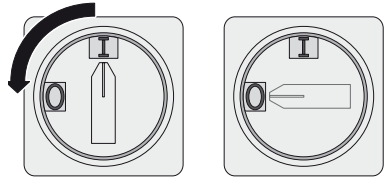

2. Perform troubleshooting in the PV system:  
Check all PV strings for the correct open-circuit voltage.

3. After the fault is rectified, restart the Sunny Boy: Turn the DC disconnect to position "1".

The Sunny Box starts and performs another AFCI self-test.

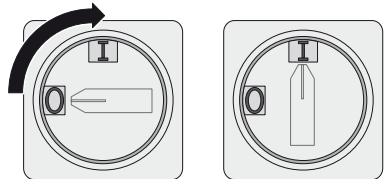

4. If the following message appears on the display, knock on the enclosure lid: "Electric arc detected – Knock to restart."

**i** **The message "Error AFCI. Knock to reset." appears for only 10 seconds. After this, it is no longer possible to restart the unit by knocking on the enclosure lid.**

- To restart the system, repeat step 1 to step 3.

- 5. If the AFCI self-test is successful: The Sunny Boy goes into "Waiting" mode and the green LED flashes.
- The "Waiting" mode ends when solar irradiation reaches a certain level. The green LED lights up permanently and the Sunny Boy feeds into the power distribution grid.



or

- 6. If the AFCI self-test fails: The Sunny Boy repeats the AFCI self-test until it is successful.
- 7. If the AFCI self-test continues to fail: Turn the DC disconnect to position "0" and switch off the AC disconnect switch to the inverter.

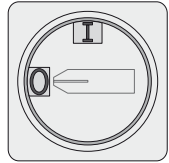
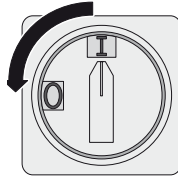

**If the AFCI self-test fails permanently**

- Contact the SMA Service Line. Observe section 14 "Contact" (page 103).

**In the event of inverter inspection**

- 1. Turn the DC disconnect to position "0".
  - The Sunny Boy switches itself off.
- 2. Disconnect the Sunny Boy on the AC side.

**The Message "EarthCurrentMax" Is Displayed**

A ground fault is present in the PV array. The GFDI fuse is cleared.

- 1. Turn the DC disconnect to position "0" and switch off the AC disconnect switch to the inverter.

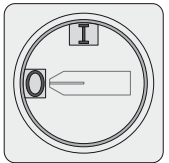
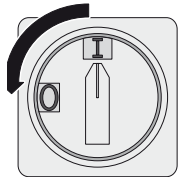

- 2. Perform troubleshooting in the PV array.

## 8 Displays and Messages

### The Sunny Boy LED Status Indicators

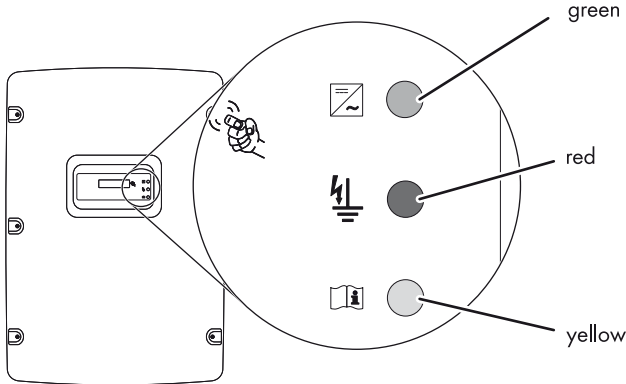

Each Sunny Boy inverter is equipped with three LED status indicators that display the operating mode of the inverter.

The green LED indicates standard operation of the inverter.



The red LED indicates the status of the GFDI fuse, located inside the Sunny Boy. If this LED lights up, the GFDI fuse has cleared or is not present.

The inverter does not feed into the power distribution grid.

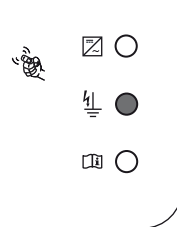

The yellow LED indicates that there is a fault in either the inverter or the PV plant. The inverter will not operate until the fault has been corrected.

The possible error messages and causes are explained later in section 9 "Troubleshooting" (page 78) and in section 8.2 "LED Fault Indicators" (page 66).



If the yellow LED and the red LED light up simultaneously, the inverter has a ground fault.

The ground fault may also trip the GFDI fuse.

- Observe section 8.2 "LED Fault Indicators" (page 66).

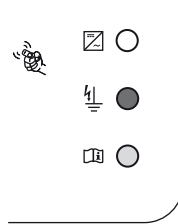

In "Turbine" mode, all GFDI fuses are suspended.

## 8.1 LED Operation Indicators

### Standby (Night)



The inverter is in standby mode. The input voltage is too low for operation.

### Initialization



The inverter initializes. The power available from the PV array is not sufficient for standard operation. Data transmission is not possible during initialization.



**In the event of inclement weather or low solar irradiation, all LEDs may light up simultaneously or flash. This is not an interference.**

The inverter is attempting to initialize. The power available from the PV array is not sufficient for standard operation.

### Start

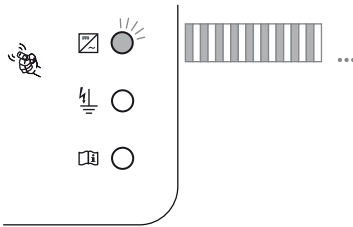

The inverter calibrates the internal systems. The calibration lasts 10 seconds and the inverter begins standard operation. If the inverter was manually placed into STOP mode, this status is displayed as well.

### Waiting

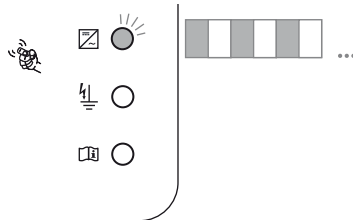

The inverter checks the grid requirements and whether enough voltage from the array is available to feed into the power distribution grid.



If the feed-in to the power distribution grid was interrupted and then resumed, the inverter always waits 5 minutes before feeding in.

If the inverter is not able to feed into power distribution grid three times in a row, it waits 10 minutes before the next attempt.



### Standard Operation

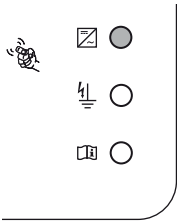

The inverter feeds into the power distribution grid in either "MPP", "Constant Voltage", or "Turbine" mode.

#### "MPP" mode:

The Sunny Boy adjusts the voltage and the current from the PV array in order to receive the highest possible PV output power.

#### "Constant Voltage" mode:

The array voltage is set to a fixed value. This value is set using the Sunny Boy Control or the Sunny Data Software. The parameter name is

#### "V-Const":

This mode is suitable for using the inverter with fuel cells or small hydroelectric power plants.

#### "Turbine" mode:

This mode is suitable for using the inverter with a rectified DC generator and dynamic power characteristic curve. The inverter can be adjusted to the form and slope of the power characteristic curve of a specific generator. A small wind turbine system is a suitable generator for this.

### Derating

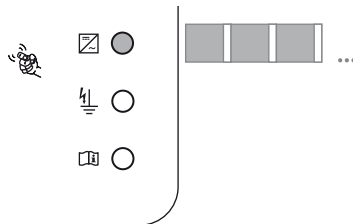

The Sunny Boy can be operated with nominal power at an ambient temperature of up to +113 °F (+45 °C). The Sunny Boy does remain operational at temperatures above +113 °F (+45 °C), but it reduces the level of performance so as to protect the internal component parts from overheating.



#### Unwanted derating due to blocked fan inlets

Clean the fan inlets regularly.

## 8.2 LED Fault Indicators



### CAUTION

Risk of electric shock

Normally grounded conductors may be ungrounded and energized when a ground-fault is indicated by the inverter.

- Check the PV-system for a ground fault and replace the ground fuse as described in this document.

### Ground Fault



If the yellow and red LEDs light up simultaneously, the inverter detected a ground fault. The inverter will not restart automatically after detecting a ground fault.

- Locate the ground fault and rectify it. Observe section 9 "Troubleshooting" (page 78).
- Then restart the inverter.



### GFDI fuse

The ground fault may also trip the GFDI fuse.

In "Turbine" mode, all GFDI fuses are deactivated.

## Cleared GFDI Fuse

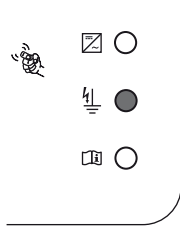

The GFDI fuse was cleared or is not present. This fuse protects the PV plant if a ground fault is present in the PV array.

- Locate and rectify the ground fault. Observe section 9 "Troubleshooting" (page 78).
- Then replace the GFDI fuse. The GFDI fuse is located in the fuse holder on the inverter board.

	<b>CAUTION</b>
<p>Risk of fire due to incorrectly dimensioned fuse.</p> <p>Risk of injury due to fire.</p> <ul style="list-style-type: none"> <li>• Only replace faulty fuses with fuses of the same type and size.</li> <li>• The Sunny Boy is shipped with a Littelfuse KLKD 1 Amp, 600 V AC/DC type fuse.</li> </ul>	

## Control System Fault



The yellow LED is continuously lit up. Operation of the Sunny Boy is permanently inhibited

The inverter no longer feeds into the power distribution grid and must be serviced by a qualified service technician.

- Follow section 7.2 "The Sunny Boy Does Not Resume Operation" (page 59) or contact SMA.

## Grid Failure

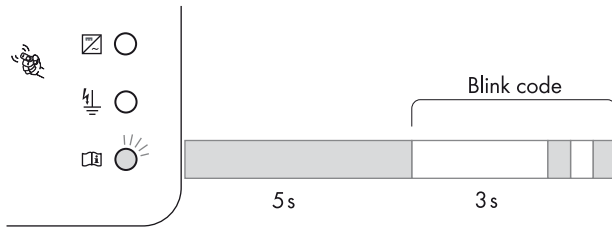

The yellow LED lights up for 5 seconds, goes out for 3 seconds, then flashes 2 times. This sequence is repeated 3 times. As long as a grid failure continues to be present, this flashing code will repeat itself.

The flashing code can be caused by one of the following conditions:

- Grid undervoltage ( $< V_{ac} \text{ Min}$ )
- Grid overvoltage ( $> V_{ac} \text{ Max}$ )
- Grid underfrequency ( $< f_{ac} \text{ Min}$ )
- Grid overfrequency ( $> f_{ac} \text{ Max}$ )
- Sudden change in the power frequency or the grid voltage

 <b>DANGER</b>
<p>Danger to life due to high voltages in the inverter.</p> <p>Risk of death or serious injury due to electric shock.</p> <ul style="list-style-type: none"> <li>• Only qualified personnel may perform work on the inverter.</li> </ul>

Monitor the status of the power distribution grid at the AC terminal blocks in the Sunny Boy and the AC disconnect switch between the Sunny Boy and the power distribution grid.

### High DC Input Voltage

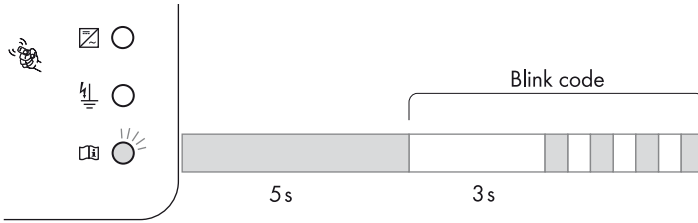

The yellow LED lights up for 5 seconds, goes out for 3 seconds, then flashes 4 times. This sequence is repeated 3 times. If the status does not change, the flashing code repeats itself.

The inverter has detected a DC input voltage that is too high for safe operation.

#### NOTICE

Damage to the inverter due to high DC input voltage.

- Disconnect the inverter from the PV array immediately.

### Inverter Interference

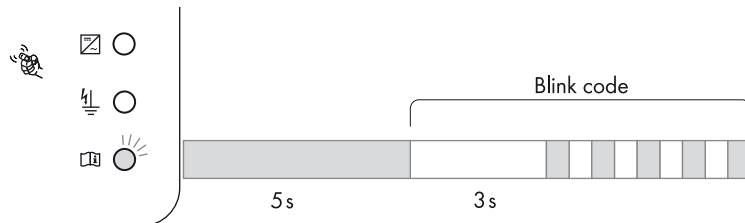

The yellow LED lights up for 5 seconds, goes out for 3 seconds, then flashes 5 times. The message is repeated 3 times. If the status does not change, the flashing code repeats itself.

The inverter has detected an internal fault that interrupts standard operation. The inverter must be maintained by a qualified service technician. Contact SMA.

### 8.3 Status Messages on the LCD Display

The Sunny Boy is equipped with the LCD "Sunny Display" in the enclosure lid as standard.

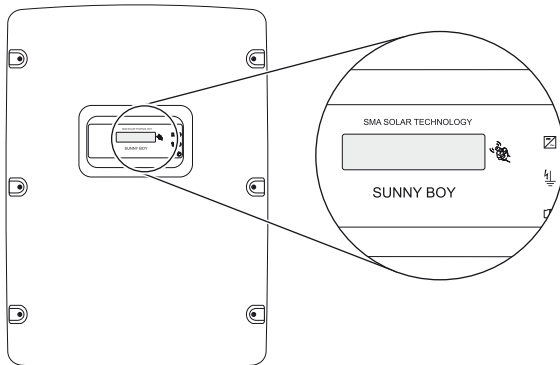

#### Activation of the Background Illumination

Tapping on the enclosure lid activates the background illumination. Additional taps will scroll through the display messages.

The background illumination shuts off automatically after 2 minutes.

#### INIT Messages

The inverter displays the following messages during initialization:

```
Sunny Boy
WRXKuxxx
```

After 6 seconds, the installed firmware versions of the operation control unit (OCU) and the current control system (SRR) are displayed.

```
BFR Version x.xx.
SRR Version x.xx
```

#### Operation Messages

The LCD scrolls consecutively through all operation messages. Every message is displayed for 5 seconds. After all messages have been displayed, the LCD repeats all of the messages.

Message 1 "E-Today": Total energy generated today. The current operating mode is displayed under this.

```
E-today 8.86kWh
Mode MPP
```

Message 2 "Gridtype": System configuration of the inverter and measured values of the voltage between the conductor and the neutral conductor.

```
Gridtype - 208V
L1 120V L2 120V
```

Message 3: Current AC power and current DC input voltage.

```
Pac 500W
UPV 380V
```

Message 4: Energy output accrued since the installation of the inverter and the total operating hours.

```
E-Total 724.4kWh
h-total   512h
```



Knocking on the lid of the inverter takes you to the next display message.

## Error Messages

If a fault occurs, the LCD switches into "Fault" mode and the background illumination is activated. The upper line of the display shows one of the following fault types:

### Interference

The Sunny Boy has detected a problem with the frequency of the power distribution grid. The message ends automatically as soon as the fault is rectified. Interference is caused if a measured value exceeds a preset limit.

```
Disturbance
Fac-Bfr
```

The display shows the value of the fault (at:) as well as the current value for the corresponding parameter (present:).

```
at:      59.29Hz
Present: 59.30Hz
```

### Warning

The GFDI fuse is cleared. Warning messages display a plant status that must be investigated. The inverter may be operational despite a warning message.

```
Warning
GFDI Fuse Open
```

### Error

The inverter has detected a problem with the internal ROM. A fault status prevents a restart of the inverter until the fault is rectified.

```
Error
ROM
```



Each error message is displayed for 5 seconds. After 5 seconds, the LCD scrolls through the regular operation messages.

The error message will be displayed in the display sequence until the fault is rectified.

### 8.4 Setting the Display Language

The LCD can display information in 1 of 4 different languages. The language is configured via 2 slide switches that are located on the lower edge of the LCD.

1. Open the Sunny Boy as described in Section 6.3 "Opening the Sunny Boy" (page 40).
2. Set the switches to the required language, as shown below.

Language	Switch S2	Switch S1
German	B	B
English	B	A
French	A	B
Spanish	A	A

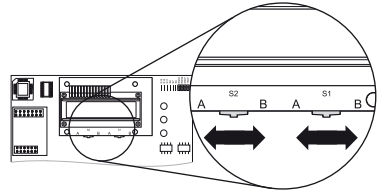

3. Close the Sunny Boy as described in Section 6.8 "Closing the Sunny Boy" (page 56).

The display language is set.

### 8.5 Measuring Channels and Parameters

The communication options support a number of measuring channels and messages from the Sunny Boy inverters. The following abbreviations are used:

- OCU      Operation Control Unit
- SRR      Current Control System (German abbreviation for "Stromregelungsrechner")

The OCU and SRR are redundant processor control systems for the utility protection functions.



## 8.5.1 Measurement Channels

Vpv:	PV input voltage
Vpv Setpoint:	MPPT DC target voltage
Iac:	Grid current
Vac:	Grid voltage L1 - L2
Vac L1:	Grid voltage L1 - N
Vac L2:	Grid voltage L2 - N
Fac:	Power frequency
Pac:	Power fed to grid
Vpv-PE:	PV voltage to earth (for troubleshooting PV ground faults)
Temperature:	Temperature measured at IGBT module
Ipv:	PV current
Max Temperature:	Max temperature measured at IGBT
Max Vpv:	Max. PV input voltage
I-dif:	Fault current
Vfan:	Fan voltage
E-Total:	Total energy yield
h-Total:	Total operating hours
h-on:	h-on displays how long sufficient DC voltage has been applied at the Sunny Boy and how long the Sunny Boy has been in operation. The displayed value contains the time when the Sunny Boy was unable to feed into the power distribution grid due to the DC voltage being too low or due to "STOP" mode.
Power On:	Total number of system starts
Event-Cnt:	Event counter
Serial Number:	Serial number of the Sunny Boy
CO2 saved:	Amount of CO2 saved during the operating time
Mode:	Current operating mode
Grid Type:	Type of grid the Sunny Boy is connected to
Error:	Description of fault

## 8.5.2 Operating Mode

Stop:	Manual system stop
Offset:	Offset calibration of the electronics (at start-up)
Waiting:	PV voltage is not high enough to start
Grid monitoring:	Synchronizing to grid (at start-up)
MPP-Search:	MPPT range test (at start-up)
MPP:	Sunny Boy is in MPP mode (standard operation)
V-Const:	Sunny Boy is in MPP mode with constant voltage
Derating:	Reduction of the power fed into the grid due to increased cooling element temperatures
Disturbance:	Fault status relating to the grid. As soon as the cause of the fault is no longer present, this fault will be reset automatically.
Error:	Inverter fault, user interaction required
Warning:	System warning advising further investigation

## 8.5.3 Operating Parameters of the Sunny Boy



**Changes to the preset parameters can negatively influence the operation and the performance of the inverter**

- Changes to the operating parameters must be made by trained qualified personnel.

Changes to the parameters labeled with \* can lead to changes regarding conformity with IEEE 1547 and must be approved by the on site electric utility company and/or the responsible authority.

## 8.5.4 Operating Parameters of the Sunny Boy

Name	Unit	Range	Standard	Password Level	Description
AfcilsOn		yes/no	yes	Electrically qualified person	Arc fault circuit interrupter (AFCI)
Antiland-Ampl*	deg	0 ... 10	0	Electrically qualified person	Amplification of the anti-island process
Antiland-Freq*	mHz	0 ... 2000	500	Electrically qualified person	Repetition rate of the anti-island process
CO2-Fact	lb./kWh	0 ... 2	1.7	Electrically qualified person	The Sunny Boy evaluates the yield and displays the approximate amount of CO <sub>2</sub> that the Sunny Boy has saved.  This CO <sub>2</sub> amount is calculated by multiplying the generated kWh (E-total) by the factor defined in the parameter "CO <sub>2</sub> ".

Name	Unit	Range	Standard	Password Level	Description
Default		USA/UL1741/ 2005, OFF_Grid, NON IEEE1547	USA/ UL1741/ 2005	Electrically qualified person	Used for adjusting the country specific parameter settings. Note: After changing one of the parameters marked with "**", the parameter "default" changes to "adjusted" automatically.
dFac-MAX*	Hz/s	0.005 ... 4	0.5 (for country setting USA/ UL1741/ 2005)	Electrically qualified person	Maximum "number of frequency changes" before the anti-islanding protection switches on
E_total	kWh	0 ... 200000	0	Electrically qualified person	Total energy yield of the inverter. Changing the value may be necessary if a Sunny Boy is replaced and you wish to compare the data obtained previously.
Fac-delta-*	Hz	0.2 ... 3	0.69 (for country setting USA/ UL1741/ 2005)	Electrically qualified person	Maximum permissible operating frequency above and below 60 Hz. Standard value is optimal for plants < 30 kW.
Fac-delta+*	Hz	0 ... 4.5	0.49 (for country setting USA/ UL1741/ 2005)	Electrically qualified person	
Fac-MinTripTime*	s	0.16 ... 300	0.16	Electrically qualified person	Switch-off time having fallen below power frequency. The standard value is optimal for plants < 30 kW.
Fan-Test		1 / 0	0	Electrically qualified person	By setting this parameter to "1" you can check the function of the fans. This test turns the fans at maximum speed.
h_Total	h	0 ... 200000	0	Electrically qualified person	Total operating hours of the inverter. Changing the value may be necessary if a Sunny Boy is replaced and you wish to compare the data obtained previously.
Memory Function		no function, Default param., Reset Op.Data, Reset errors	no function	Electrically qualified person	Default param.: Sets all parameters to the standard value. Reset Op.Data: Sets all parameters to the standard values that are displayed on the user level. Reset errors: Resets all permanent errors that lead to device disconnection.

Name	Unit	Range	Standard	Password Level	Description
Operating Mode		MPP-Operation, Turbine, V-const, Stop	MPP	Electrically qualified person	Operating modes of the Sunny Boy: MPP-Operation: Sets the Sunny Boy in Maximum Power Point Tracking Mode V-const: Constant Voltage Mode (target value defined in "Vconst-Setval") Turbine: Operating mode for wind turbine systems Stop: Disconnection from grid, no operation
V-Const Setval	G	<b>SB 5000-US -</b> <b>SB 7000-US:</b> 250 ... 600 <b>SB 8000-US:</b> 300 ... 600	600	Electrically qualified person	PV target voltage for constant voltage operation. These parameters only are important in the event that the parameter "Operating Mode" is set to "V-const".
Vac-Min*	%	0 ... 50	12	Electrically qualified person	Values are used to calculate the lower limit of permissible AC voltage. Standard value is optimal for plants < 30 kW. Standard value 12 results in a trip value of 88 %, as the list of trip limits shows.
Vac-Max*	%	0 ... 20	10	Electrically qualified person	Values are used to calculate the upper limit of permissible AC voltage. Standard value is optimal for plants < 30 kW. Standard value 10 results in a trip value of 110 %, as the list of trip limits shows.
Vac-Min-Fast*	%	0 ... 50	50	Electrically qualified person	Values are used to calculate the lower limit of allowable AC voltage for fast disconnection. Standard value is optimal for plants < 30 kW. Standard value 50 results in a trip value of 50 %, as the list of trip limits shows.
Vac-Max-Fast*	%	0 ... 20	20	Electrically qualified person	Values are used to calculate the upper limit of allowable AC voltage for fast disconnection. Standard value is optimal for plants < 30 kW. Standard value 20 results in a trip value of 120 %, as the list of trip limits shows.
Vac-Min-Reconnect	%	0 ... 50	11.7	Electrically qualified person	Values are used to calculate the lower and upper limits to reconnect to the grid after a grid failure.
Vac-Max-Reconnect	%	0 ... 20	5.83	Electrically qualified person	

Name	Unit	Range	Standard	Password Level	Description
V <sub>pv-Start</sub>	G	<b>SB 5000-US - SB 7000-US:</b> 250 ... 600 <b>SB 8000-US:</b> 300 ... 600	<b>SB 5000-US- SB 7000-US:</b> 300 <b>SB 8000-US:</b> 365	Electrically qualified person	Minimum DC voltage for the Sunny Boy to connect to the grid.

### 8.5.5 Fixed Operating Parameters of the Sunny Boy

Name	Unit	Range	Standard	Description
P <sub>limit</sub>	V	fixed	<b>SB 5000-US:</b> 5100 <b>SB 6000-US:</b> 6100 <b>SB 7000-US:</b> 7100 <b>SB 8000-US:</b> 8100	Upper limit of AC output power
SMA-SN				Serial number of the Sunny Boy
Software-OCU				Firmware version of the operation control unit (OCU)
Software-SRR				Firmware version of the current control system (SRR)

# 9 Troubleshooting

## 9.1 General

Every inverter is checked prior to leaving the plant. If there are faults in the operation of the inverter, perform the following steps to rectify the faults.

- Pay attention to Sunny Boy flashing codes. Look up the meaning of the flashing code being displayed in section 7 "Commissioning" (page 58).
- Monitor operating modes and error messages on the LCD of the Sunny Boy or via connected PV plant monitoring. Look up the meaning of messages being displayed in section 8 "Displays and Messages" (page 62).
- Monitor the DC and AC voltage at the terminals in the inverter. Please observe all safety precautions listed in the course of this manual.
- If the fault cannot be rectified, contact SMA Service Line. For contact data, see section 14 "Contact" (page 103).

If it is necessary to return the Sunny Boy for maintenance, use the original box in order to prevent shipping damage.

## 9.2 Error Messages

Error type	Error code	Description
Interference	Ocu-Srr	Communication between micro-controllers is interrupted.
Warning	Derating	The inverter reduces the output power due to high internal temperatures.
Interference	Disturbance AFCI	Electric arc in the PV system. Eliminate the fault in the PV system. Perform an AFCI self-test. Observe section "The Message "Disturbance AFCI" Is Displayed" (page 60).
Error	EarthCurMax-B	The ground current of the OCU between PV+ and GND is outside of the tolerable range.
Error	EarthCurMax-S	The ground current of the SRR between PV+ and GND is outside of the tolerable range.
Interference	EEPROM	Transfer fault while reading or writing data from the EEPROM. This data is not essential for safe operation. This fault does not have any influence on performance.
Error	EEPROM p	Data from the EEPROM are defective. The operation of the inverter is permanently inhibited as the data loss affects important functions of the inverter. Contact SMA.
Interference	EeRestore	Internal interference.

<b>Error type</b>	<b>Error code</b>	<b>Description</b>
Interference	Fac-Ocu, Fac-Srr	The AC power frequency is exceeding the permissible range. To prevent islanding, the Sunny Boy disconnects itself from the power distribution grid.  If the power frequency is within the tolerable range and the error message "Fac-Ocu" or "Fac-Srr" continues to be displayed, contact SMA.
Warning	GFDI Fuse Open	The GFDI fuse is cleared. Before replacing the fuse, check the PV array for a ground fault error.
Interference	Grid-Timeout, Grid-Fault-S	The system configuration cannot be detected (208 V/240 V/277 V).  If a 277 V grid is configured: Check whether the cables for L1 and N are located in the correct connection terminals.
Interference	Imax	Overcurrent on the AC side. The current to the AC grid exceeds the guidelines. The reason for this may be severe grid interference. If "Imax" appears frequently, check the AC grid. If you require help, contact SMA.
Interference	K1-Close	Relay test failed. Contact SMA.
Error	K1-Open, K2-Open	
Interference	MSD-FAC, MSD-Idif	Internal measurement comparison fault:
Error	MSD-VAC	The OCU and SRR values measured by the Sunny Boy differ too strongly from one another.  Contact SMA.
Interference	OFFSET	Grid monitoring self-test failed.
Error	ROM	The internal test of the Sunny Boy control system firmware failed. If this fault occurs frequently, contact SMA.
Interference	Shut-Down	Continuous internal overcurrent.
Interference	Vac-Ocu, Vac-Srr	The AC grid voltage is exceeding the permissible range. The cause may be disconnection from the power distribution grid or from an AC cable. To prevent islanding, the Sunny Boy disconnects itself from the power distribution grid.  If the error message "Vac-Ocu" or "Vac-Srr" is displayed despite the grid voltage being within the tolerable range, contact SMA.

<b>Error type</b>	<b>Error code</b>	<b>Description</b>
Interference	VacL1-Ocu, VacL2-Ocu, VacL1-Srr, VacL2-Srr	Voltage is too high or too low on the indicated branch.
Interference	VpvMax !PV Overvoltage! !Disconnect DC!	The DC input voltage is exceeding the maximum tolerable value. Disconnect the DC line immediately.
Interference	Watchdog	Watchdog for operation control triggered.
Interference	XFMR	The transformer is connected to the wrong grid. Check the connection of the transformer.  For grounded Delta grids: Monitor whether the grid grounding conductor is connected to terminal L2.  In the event of unbalanced load in 200 V and 240 V grids, swapping L1 and L2 may rectify the fault.
Interference	XFMR_TEMP_F	High transformer temperature. The Sunny Boy stops and the fans run at maximum speed.
Warning	XFMR_TEMP_W	After the reduction of the high transformer temperatures, the Sunny Boy restarts. Monitor the function of the fans.



## 10 Maintenance

Regular maintenance ensures a long operating life and optimal efficiency of the entire PV plant.

### 10.1 Cleaning the Fans

The Sunny Boy is fitted with two fans on its underside.

The fan intakes and handle covers should be cleaned periodically with a vacuum cleaner. For more thorough cleaning, completely remove the fans.



#### NOTICE

Potential damage to the fans due to compressed air.

- Do not use compressed air for cleaning.
- Use a soft brush or a cloth for cleaning.
- Always remove the fans for cleaning.

1. Disconnect the Sunny Boy on the AC and DC sides.
2. Wait 5 minutes until the residual voltage has been drained and the fans are no longer turning.

#### Cleaning the Fan Guard

3. Remove the ventilation grids.
  - Press both latches on the right edge of the fan guard to the right using a screwdriver and loosen from the bracket.
  - Carefully remove the fan guard.

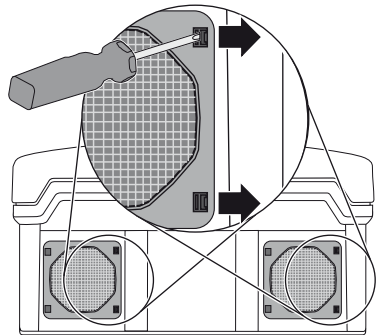

4. Clean the ventilation grid with a soft brush, a paint brush, a cloth or compressed air.

## Cleaning the Fans

5. Press the front latches backward and the rear latch forward.

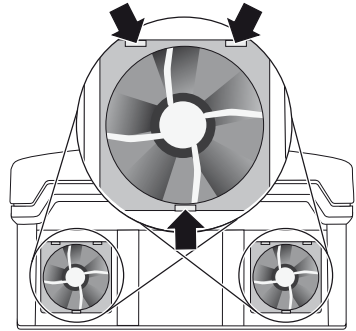

6. Remove the fan by pulling it slowly and carefully downward.
7. Unlock and remove the plug.  
The cables of the fans are long enough to disconnect the plug in the inside of the Sunny Boy.
8. Remove the fan.
9. Clean the fan with a soft brush, a paintbrush, or a cloth.
10. After cleaning, mount the fans and the ventilation grids in reverse order.
11. Check the function of the fans as described in section "Fan Test" on page 84.

## 10.2 Cleaning the Handle Covers

For optimal heat dissipation of the device, the handle covers must be clean. Clean the handle covers regularly.

### NOTICE

Insects can enter the Sunny Boy  
Potential damage to the Sunny Boy.

- The handle covers must not be removed permanently, otherwise the inverter is not protected against the ingress of insects.

1. Remove the handle covers. To do this, put your finger up into the space between the handle covers and the enclosure and pull the handle covers to the side
2. Clean the handle covers with a soft brush or a paintbrush.
3. Re-secure the handle covers on the inverter. The side on which they are to be mounted is stated on the inside of the handle covers ("links/left" and "rechts/right").

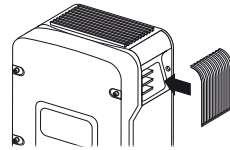
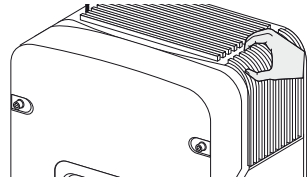

## 10.3 Checking the DC Disconnect



**In the case of normal use, the DC Disconnect does not require any maintenance.**

Operating the switch cleans the contacts and extends the life of the DC Disconnect.

It is recommended, though not compulsory, to:

- Check the DC disconnect regularly.
- Activate the DC disconnect 10 times in a row once a year.

Operating the switch cleans the contacts and extends the life of the DC disconnect.

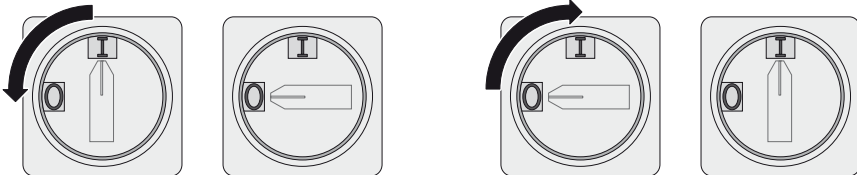

## 10.4 Fan Test



### **In the event of frost, the fan cannot be inspected**

The fans are not activated under 32 °F (0 °C).

You can check the operation of the fans in 2 ways:

- Set the parameter "Fan Test" in installer mode to "1". To do this, use the Sunny Data, Sunny Data Control, Sunny Boy Control, or the Sunny WebBox.

**or**

- Set the jumper on the sequential control system board. The jumper for checking the fans is included in the scope of supply of the Sunny Boy.

### **Setting the Parameter**

1. Ask for the installer password from SMA Service Line. See "Contact" on page 103.
2. Set the "Fan Test" parameter to "1" in installer mode.
3. Check the air flow of the fans.
  - The Sunny Boy draws in cold air through the fans and lets it out again through the handle covers.
  - Pay attention to unusual sounds.
4. After checking the fans, set the parameter "Fan Test" back to "0".

## Setting the Jumper



### The Sunny Boy recognizes the jumpers after the restart.

All LEDs must be off prior to a restart.

1. Disconnect the Sunny Boy on the AC and DC sides. Wait 5 minutes until the residual voltage has been drained.
2. Open the Sunny Boy as described in section 6.3 "Opening the Sunny Boy" (page 40).
3. Insert the jumper supplied into the slot on the sequential control system board shown below.

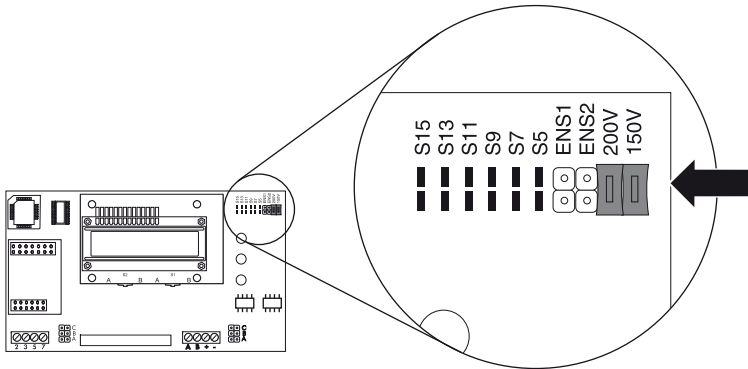

4. Close the Sunny Boy as described in section 6.8 "Closing the Sunny Boy" (page 56).
5. Check the air flow of the fans.
  - The Sunny Boy draws in cold air through the fans and lets it out again through the handle covers.
  - Pay attention to unusual sounds.
6. After checking the fans, remove the jumper.

## 10.5 Exchanging the Fuses



### CAUTION

Risk of fire due to incorrectly dimensioned fuse.

Risk of injury due to fire.

- Only replace faulty fuses with fuses of the same type and size.

### 10.5.1 Exchanging the GFDI Fuse within the Sunny Boy

1. Disconnect the Sunny Boy on the AC and DC sides.
2. Wait 5 minutes until the residual voltage has been drained and the fans are no longer turning.
1. Open the Sunny Boy as described in section 6.3 "Opening the Sunny Boy" (page 40).
2. Replace the fuse (A).

For the correct position of the fuse, observe section "DC Input Grounding" on page 48.

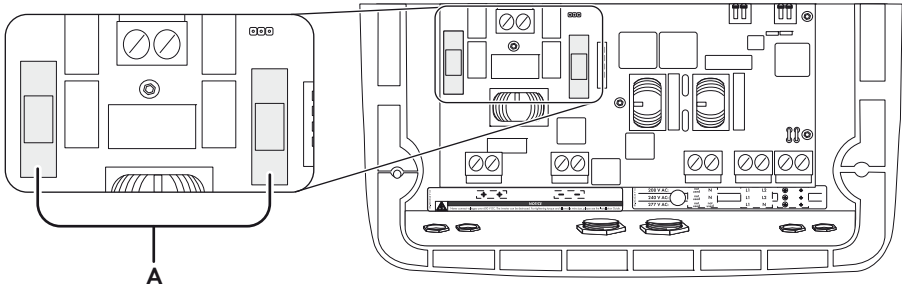

3. Completely insert the fuse into the terminal.
4. Close the Sunny Boy as described in section 6.8 "Closing the Sunny Boy" (page 56).
5. Switch the AC and DC disconnect switches back on.

### 10.5.2 Exchanging PV String Fuses within the DC disconnect

1. Disconnect the Sunny Boy on the AC and DC sides.
2. Wait 5 minutes until the residual voltage has been drained.
3. Open the DC disconnect as described in section 6.4 "Opening the DC Disconnect" (page 41).
4. Replace the fuse (1, 2, 3, or 4).

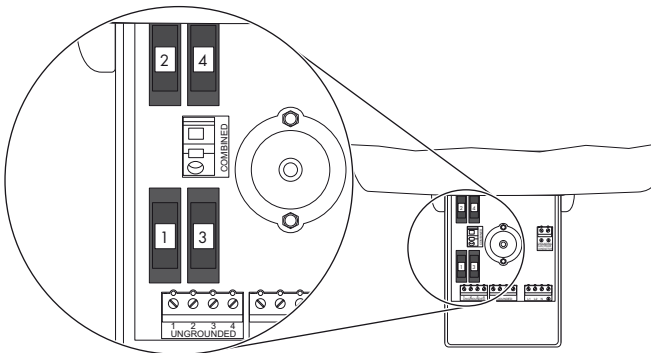

5. Close the DC disconnect as described in section 6.9 "Closing the DC Disconnect" (page 57).
6. Switch the AC and DC disconnect switches back on.

## PV String Fuse Sizing

If the fuses are designed too small, they may open too early and cause interference. If fuses are designed too large, they do not provide the required protection as they open too late.

For PV plants, the minimum and maximum size of a fuse connected in series is specified by the electrical nominal sizes of a PV module and by UL and the *National Electrical Code*. Contact the manufacturer of the PV modules in order to obtain the corresponding nominal sizes of the PV string fuses.

The minimum sizes of fuses and cables are calculated using the Short Circuit Current Rating (Isc) of the PV module. The *National Electrical Code* stipulates that all fuses and cables are designed to be at least 1.56x as large as the Isc of the PV module being used in the plant.

The correct size of the PV string fuse is specified by calculating 1.56x the Isc (of the PV module) and then rounding this up to the nearest standard size for fuses.



For example, if the Isc of the PV module is 6.9 Adc, then the size of the PV string fuses is determined as follows:  $1.56 \times 6.9 = 10.76$

The nearest standard size for fuses would be a 12 A and 600 Vdc fuse.

The size of a string fuse may not be greater than the maximum nominal value of a PV module fuse. Observe the data sheet of the PV module. If no maximum size for fuses is stated, contact the manufacturer of the PV module.

## DC Disconnect Requirements

*National Electrical Code* 690.15-18 enables the use of fuse holders as a suitable medium for disconnecting PV arrays for maintenance. Additional DC disconnects external to the inverter may be required by the local authority having jurisdiction.



### WARNING

Electric arc and electric shock when removing the fuses under load.

Risk of death or serious injury.

- Do not remove any fuses when the inverter is under load.

## PV String Fuses

The DC disconnect is shipped with 15 A, 600 V DC fuses in the fuse holders. The maximum nominal size for string fuses in the DC disconnect is 20 A at 600 V DC.



When dimensioning the fuses, observe the *National Electrical Code*<sup>®</sup> 690.8 and 690.9.

## 10.6 Testing and Replacing the DC Varistors

 Only the following inverter types are equipped with DC varistors:  
SB 5000US-12/SB 6000US-12/SB 7000US-12/SB 8000US-12.

In regions where storms or other DC overvoltages frequently occur, the DC varistors lose their functionality if the PV plant is not equipped with an additional overvoltage protection. To ensure that the functionality of the DC varistors remains at a constant level, SMA recommends in such cases to replace the DC varistors after an operating time of 10 years with new ones.

 **NOTICE**

No protection against overvoltage due to faulty or missing varistors  
Destruction of the inverter is possible.

- Do not operate the inverter with faulty varistors or no varistors at all.
- Replace faulty varistors immediately.

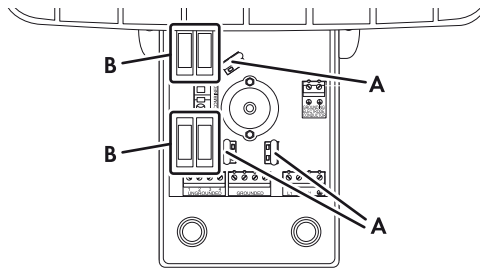

Position	Description
A	Terminals for DC varistors
B	Fuse holders for fuse extractor with string fuses

1. Disconnect the Sunny Boy on the AC and DC sides.
2. Wait 5 minutes for the components to cool down.
3. Open the DC disconnect as described in Section 6.4 "Opening the DC Disconnect" (page 41).

 **DANGER**

High voltages at the DC terminals with connected PV modules  
Risk of death or serious injury when touching the DC terminal.

- Do not touch any live component of the DC terminals.



4. Check the DC varistors (A) for discoloration and visible damage.
  - If one of the DC varistors is discolored or damaged, replace all DC varistors:



**DANGER**

Danger to life due to short circuits in the DC varistors  
Death or serious injury due to electric shock

- Check whether current is flowing the DC cables.

Tip: Use a current clamp to measure the current.

5. Disconnect the DC varistors:
  - Disconnect the string connectors of all ungrounded DC cables from the PV array.
  - Remove the four fuse extractors with the string fuses from the fuse holders (B) of the DC disconnect.
  - Remove the four string fuses from the fuse extractors.
  - Insert the four fuse extractors without the string fuses into the fuse holders (B) of the DC disconnect.
6. Ensure that no voltage is present at the DC varistors.
  - If no voltage is present, replace all DC varistors:



**Only use spare parts from SMA**

- Always replace the entire set of DC varistors.
  - Order number in Section 12 "Spare Parts and Accessories" (page 101).
- Insert the insertion tool into the rectangular opening of the terminal.

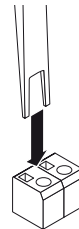

- Remove the DC varistor.

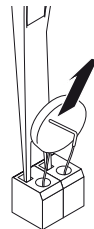

- Insert the new DC varistor into the terminal.

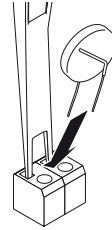

- Pull the insertion tool out of the rectangular opening of the terminal.

7. Ensure that all DC varistors in the terminals are securely in place.
  8. Re-insert all string fuses into the DC disconnect:
    - Remove the four fuse extractors without string fuses from the fuse holders (B) of the DC disconnect.
    - Equip the four fuse extractors with functional string fuses.
    - Insert the four fuse extractors with the string fuses in the fuse holders (B) of the DC disconnect.
  9. Close the DC disconnect as described in Section 6.9 "Closing the DC Disconnect" (page 57).
  10. Re-connect the string connectors of all ungrounded DC cables to the PV array.
- Testing and replacement of the DC varistors is completed.

## 11 Technical Data

### 11.1 Sunny Boy 5000-US (SB 5000US and SB 5000US-12)

#### PV Array Connection

Maximum MPP voltage	250 V ... 480 V
Nominal operating voltage	310 V
Range of input operating voltage	250 V ... 600 V
Maximum generator input power	6 250 W
Maximum DC power	5 300 W
PV start voltage	300 V
Maximum DC input current	21 A
Maximum input short-circuit current	36 A
Maximum utility backfeed current to PV array	50 A AC
DC voltage ripple	< 10 %

#### Grid Connection

AC operating voltage range at 208 V nominal value	183 V ... 229 V
AC operating voltage range at 240 V nominal value	211 V ... 264 V
AC operating voltage range at 277 V nominal value	244 V ... 305 V
AC operating frequency range	59.3 Hz ... 60.5 Hz
AC frequency, nominal value	60 Hz
Maximum continuous AC output power	5 000 W
Current THD	< 4 %
Maximum continuous AC output current at 208 V	24 A
Maximum continuous AC output current at 240 V	20.8 A
Maximum continuous AC output current at 277 V	18 A
Maximum output failure current	57.6 A
Maximum output overcurrent protection	50 A
Synchronization of inrush current	9.23 A
Trip limit accuracy	±2 %
Trip time accuracy	±0.1 %
Power consumption at night	0.1 W

#### General Data

Inverter technology	True sine, low-frequency transformer
Cooling concept	OptiCool

### Efficiency

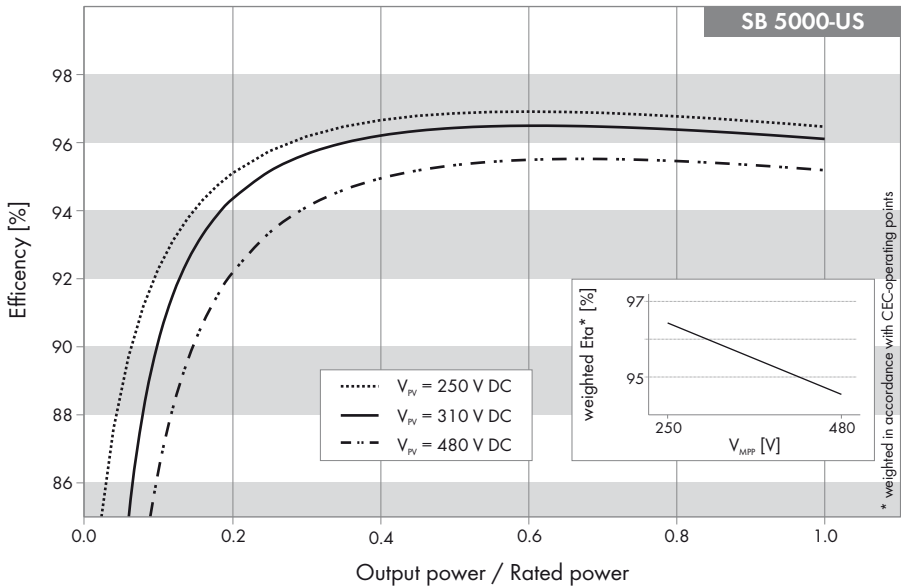

Range of output power factor	0.95 ... 1.0
Output power factor, nominal value	0.99
Peak inverter efficiency	96.8 %
CEC weighted efficiency at 208 V AC	95.5 %
CEC weighted efficiency at 240 V AC	95.5 %
CEC weighted efficiency at 277 V AC	95.5 %

### Ambient Conditions

Ambient temperature range <b>SB 5000US</b>	- 13 °F ... +113 °F ( - 25 °C ... +45 °C)
Ambient temperature range <b>SB 5000US-12</b>	- 40 °F ... +113 °F ( - 40 °C ... +45 °C)

### Mechanical Data

Width x height x depth	18 <sup>3</sup> / <sub>8</sub> in. x 24 <sup>1</sup> / <sub>8</sub> in. x 9 <sup>1</sup> / <sub>16</sub> in. (468 mm x 613 mm x 242 mm)
Weight	147 lb. (67 kg)
Noise emission	44 dB(A)
Electronics degree of protection	NEMA 3R

## 11.2 Sunny Boy 6000-US (SB 6000US and SB 6000US-12)

### PV Array Connection

Maximum MPP voltage	250 V ... 480 V
Nominal operating voltage	310 V
Range of input operating voltage	250 V ... 600 V
Maximum generator input power	7 500 W
Maximum DC power	6 400 W
PV start voltage	300 V
Maximum DC input current	25 A
Maximum input short-circuit current	36 A
Maximum utility backfeed current to PV array	50 A AC
DC voltage ripple	< 10 %

### Grid Connection

AC operating voltage range at 208 V nominal value	183 V ... 229 V
AC operating voltage range at 240 V nominal value	211 V ... 264 V
AC operating voltage range at 277 V nominal value	244 V ... 305 V
AC operating frequency range	59.3 Hz ... 60.5 Hz
AC frequency, nominal value	60 Hz
Maximum continuous AC output power	6 000 W
Current THD	< 4 %
Maximum continuous AC output current at 208 V	29 A
Maximum continuous AC output current at 240 V	25 A
Maximum continuous AC output current at 277 V	21.6 A
Maximum output failure current	57.6 A
Maximum output overcurrent protection	50 A
Synchronization of inrush current	9.23 A
Trip limit accuracy	±2 %
Trip time accuracy	±0.1 %
Power consumption at night	0.1 W

### General Data

Inverter technology	True sine, low-frequency transformer
Cooling concept	OptiCool

### Efficiency

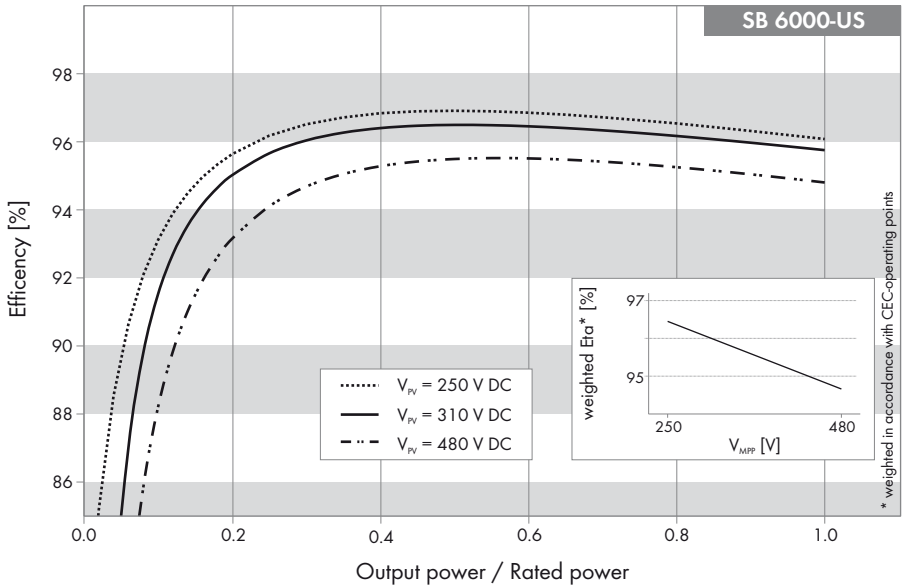

Range of output power factor	0.95 ... 1.0
Output power factor, nominal value	0.99
Peak inverter efficiency	97.0 %
CEC weighted efficiency at 208 V AC	95.5 %
CEC weighted efficiency at 240 V AC	95.5 %
CEC weighted efficiency at 277 V AC	96.0 %

### Ambient Conditions

Ambient temperature range <b>SB 6000US</b>	- 13 °F ... +113 °F ( - 25 °C ... +45 °C)
Ambient temperature range <b>SB 6000US-12</b>	- 40 °F ... +113 °F ( - 40 °C ... +45 °C)

### Mechanical Data

Width x height x depth	18 <sup>3</sup> / <sub>8</sub> in. x 24 <sup>1</sup> / <sub>8</sub> in. x 9 <sup>1</sup> / <sub>16</sub> in. (468 mm x 613 mm x 242 mm)
Weight	147 lb. (67 kg)
Noise emission	44 dB(A)
Electronics degree of protection	NEMA 3R

## 11.3 Sunny Boy SB 7000-US (SB 7000US and SB 7000US-12)

### PV Array Connection

Maximum MPP voltage	250 V ... 480 V
Nominal operating voltage	310 V
Range of input operating voltage	250 V ... 600 V
Maximum generator input power	8 750 W
Maximum DC power	7 500 W
PV start voltage	300 V
Maximum DC input current	30 A
Maximum input short-circuit current	36 A
Maximum utility backfeed current to PV array	50 A AC
DC voltage ripple	< 10 %

### Grid Connection

AC operating voltage range at 208 V nominal value	183 V ... 229 V
AC operating voltage range at 240 V nominal value	211 V ... 264 V
AC operating voltage range at 277 V nominal value	244 V ... 305 V
AC operating frequency range	59.3 Hz ... 60.5 Hz
AC frequency, nominal value	60 Hz
Maximum continuous AC output power	7 000 W
Current THD	< 4 %
Maximum continuous AC output current at 208 V	34 A
Maximum continuous AC output current at 240 V	29 A
Maximum continuous AC output current at 277 V	25.3 A
Maximum output failure current	57.6 A
Maximum output overcurrent protection	50 A
Synchronization of inrush current	9.23 A
Trip limit accuracy	±2 %
Trip time accuracy	±0.1 %
Power consumption at night	0.1 W

### General Data

Inverter technology	True sine, low-frequency transformer
Cooling concept	OptiCool

### Efficiency

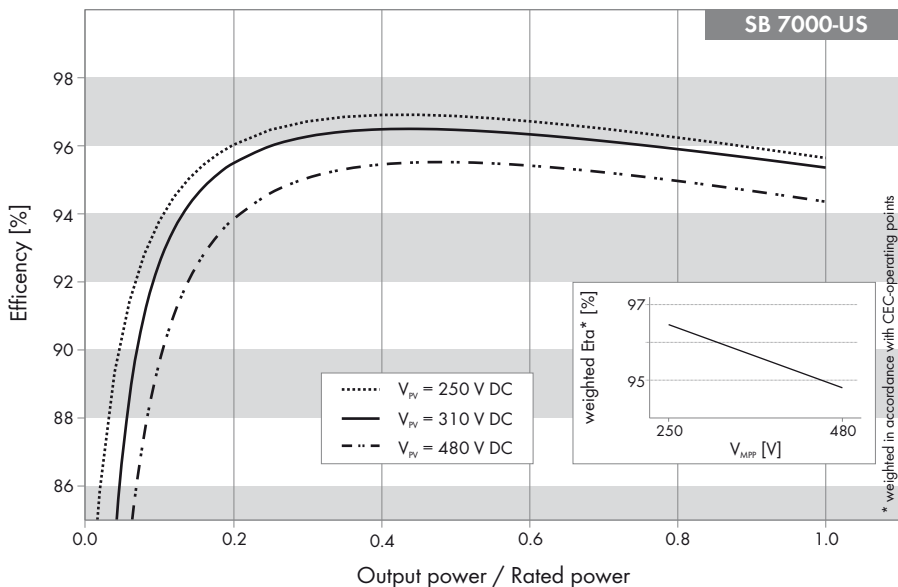

Range of output power factor	0.95 ... 1.0
Output power factor, nominal value	0.99
Peak inverter efficiency	97.1 %
CEC weighted efficiency at 208 V AC	95.5 %
CEC weighted efficiency at 240 V AC	96.0 %
CEC weighted efficiency at 277 V AC	96.0 %

### Ambient Conditions

Ambient temperature range <b>SB 7000US</b>	- 13 °F ... +113 °F ( - 25 °C ... +45 °C)
Ambient temperature range <b>SB 7000US-12</b>	- 40 °F ... +113 °F ( - 40 °C ... +45 °C)

### Mechanical Data

Width x height x depth	18 <sup>3</sup> / <sub>8</sub> in. x 24 <sup>1</sup> / <sub>8</sub> in. x 9 <sup>1</sup> / <sub>16</sub> in. (468 mm x 613 mm x 242 mm)
Weight	141 lb. (64 kg)
Noise emission	46 dB(A)
Electronics degree of protection	NEMA 3R



## 11.4 Sunny Boy SB 8000-US (SB 8000US and SB 8000US-12)

### PV Array Connection

Maximum MPP voltage	300 V ... 480 V
Nominal operating voltage	345 V
Range of input operating voltage	300 V ... 600 V
Maximum generator input power	10 000 W
Maximum DC power	8 600 W
PV start voltage	365 V
Maximum DC input current	30 A
Maximum input short-circuit current	36 A
Maximum utility backfeed current to PV array	50 A AC
DC voltage ripple	< 10 %

### Grid Connection

AC operating voltage range at 240 V nominal value	211 V ... 264 V
AC operating voltage range at 277 V nominal value	244 V ... 305 V
AC operating frequency range	59.3 Hz ... 60.5 Hz
AC frequency, nominal value	60 Hz
AC maximum continuous output power at 240 V	7 680 W
AC maximum continuous output power at 277 V	8 000 W
Current THD	< 4 %
Maximum continuous AC output current at 240 V	32 A
Maximum continuous AC output current at 277 V	29 A
Maximum output failure current	61.7 A
Maximum output overcurrent protection	50 A
Synchronization of inrush current	14.32 A
Trip limit accuracy	±2 %
Trip time accuracy	±0.1 %
Power consumption at night	0.1 W

### General Data

Inverter technology	True sine, low-frequency transformer
Cooling concept	OptiCool

## Efficiency

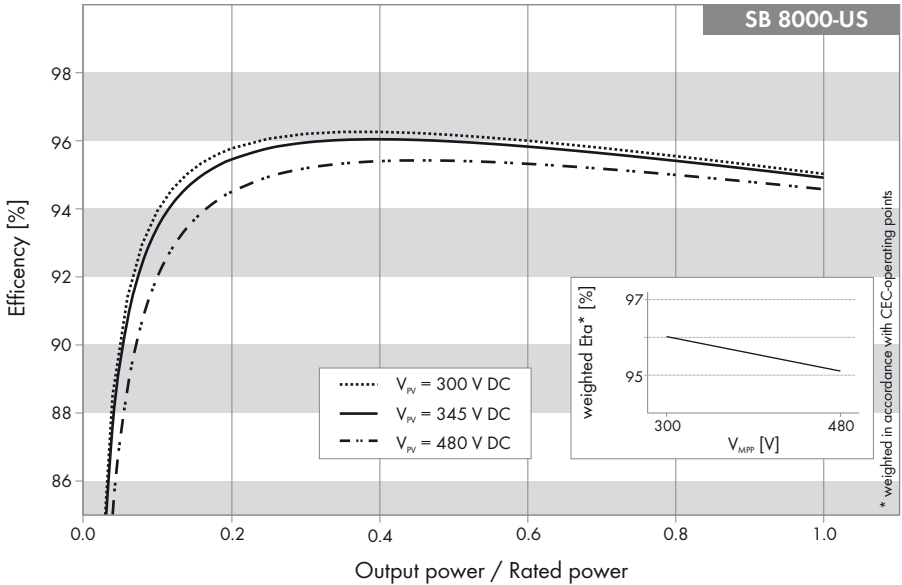

Range of output power factor	0.95 ... 1.0
Output power factor, nominal value	0.99
Peak inverter efficiency	96.5 %
CEC weighted efficiency at 240 V AC	96.0 %
CEC weighted efficiency at 277 V AC	96.0 %

## Ambient Conditions

Ambient temperature range <b>SB 8000US</b>	- 13 °F ... +113 °F ( - 25 °C ... +45 °C)
Ambient temperature range <b>SB 8000US-12</b>	- 40 °F ... +113 °F ( - 40 °C ... +45 °C)

## Mechanical Data

Width x height x depth	18 <sup>3</sup> / <sub>8</sub> in. x 24 <sup>1</sup> / <sub>8</sub> in. x 9 <sup>1</sup> / <sub>16</sub> in. (468 mm x 613 mm x 242 mm)
Weight	147 lb. (67 kg)
Noise emission	49 dB(A)
Electronics degree of protection	NEMA 3R

Specifications subject to change without notice. Values under nominal conditions.

## 11.5 DC Disconnect

Maximum DC input current	30 A
Maximum DC short-circuit current	36 A
Maximum system voltage	600 V
Maximum nominal size for string fuses	20 A
Maximum AC operating current	34 A
Dimensions W x H x D	7 <sup>7</sup> / <sub>8</sub> in. x 12 <sup>13</sup> / <sub>64</sub> in. x 7 <sup>31</sup> / <sub>64</sub> in. (200 mm x 310 mm x 190 mm)
Weight	8 lb. (3.5 kg)
Electronics degree of protection	NEMA 3R

Specifications subject to change without notice.

## 11.6 Trip Limits/Trip Times

### Frequency

Nominal Frequency	Trip Limit	Trip Frequencies	Trip Times
60 Hz	> 60.5 Hz	60.45 Hz ... 60.55 Hz	max. 0.1602 s
	< 57.0 Hz ... 59.8 Hz (standard 59.3 Hz)	56.95 Hz ... 59.85 Hz (standard 59.25 Hz ... 59.35 Hz)	adjustable, 0.16 s ... 300 s (standard max. 0.1602 s)
	< 57.0 Hz	56.95 Hz ... 57.05 Hz	max. 0.1602 s

### Voltage

Nominal Voltage	Trip Limit	Trip Voltages Conductor-Neutral Conductor*	Trip Voltages Conductor-Conductor*	Trip Times
208 V	50 %	57.6 V ... 62.4 V	99.8 V ... 108.2 V	max. 0.1602 s
	88 %	103.2 V ... 108.0 V	178.9 ... 187.2 V	max. 2.002 s
	110 %	129.6 V ... 134.4 V	224.6 V ... 233.0 V	max. 1.001 s
	120 %	141.6 V ... 146.4 V	245.4 V ... 253.8 V	max. 0.1602 s
240 V	50 %	57.6 V ... 62.4 V	115.2 V ... 124.8 V	max. 0.1602 s
	88 %	103.2 V ... 108.0 V	206.4 V ... 216.0 V	max. 2.002 s
	110 %	129.6 V ... 134.4 V	259.2 V ... 268.8 V	max. 1.001 s
	120 %	141.6 V ... 146.4 V	283.2 V ... 292.8 V	max. 0.1602 s
277 V	50 %	133.0 V ... 144.0 V	Not applicable	max. 0.1602 s
	88 %	238.2 V ... 249.3 V		max. 2.002 s
	110 %	299.2 V ... 310.2 V		max. 1.001 s
	120 %	326.9 V ... 337.9 V		max. 0.1602 s

\* The intervals result from the measuring accuracies listed below.

### Accuracy

Trip limits:  $\pm 2$  % of nominal grid voltage

Trip time:  $\pm 0.1$  % of nominal trip time

Trip frequency:  $\pm 0.1$  % of nominal frequency

## 11.7 Torque Values and Cable Sizes

Terminal	Torque	Cable Size
Gray AC & DC terminal blocks (Weidmüller), inverter	18 in-lb. (2 Nm)	10 ... 6 AWG
Green AC & DC terminal blocks (Phoenix), inverter	40 in-lb. (4.5 Nm)	8 ... 6 AWG
	22 in-lb. (2.5 Nm)	10 AWG
Gray terminal blocks for wires that are not used in the configuration of the AC voltage (Weidmüller)	22 in-lb. (2.5 Nm)	–
Green terminal blocks for wires that are not used in the configuration of the AC voltage (Phoenix)	15 in-lb. (1.7 Nm)	–
AC & DC terminal blocks, DC disconnect	15 in-lb. (1.7 Nm)	10 ... 6 AWG
Combined terminal block, DC disconnect	Spring terminal	10 ... 6 AWG
Grounding conductor terminal block, DC disconnect	15 in-lb. (1.7 Nm)	10 ... 6 AWG
Screws for fastening the Sunny Boy and the DC disconnect to the wall mounting bracket and closing the DC disconnect cover	44 in-lb. (5 Nm)	–
Cover screws	53 in-lb. (6 Nm)	–

## 12 Spare Parts and Accessories

If needed, you can order these from SMA or your SMA specialty retailer.

### Spare Parts

Name	Brief Description	SMA Order Number
DC varistors*	1 set varistors (DC), including insertion tool	SB-VDC-US01
Ventilation grid	"Right and left" ventilation grid set as a replacement part	45-7202

\* only SB 5000US-12/SB 6000US-12/SB 7000US-12/SB 8000US-12

### Accessories

Name	Brief Description	SMA Order Number
Power Balancer set	Retrofit kit for the Power Balancer function	PBL-SBUS-10-NR
RS485 retrofit kit	RS485 interface	485USPB-NR
Bluetooth retrofit kit	Bluetooth communication interface	BTPBINV-NR

## 13 Compliance Information

### FCC Compliance

This device complies with Part 15 of the FCC Rules. Operation is subject to the following conditions:

1. This device may not cause harmful interference, and
2. This device must accept any interference received, including interference that may cause undesired operation.

NOTE: This equipment has been tested and found to comply with the limits for a Class A & B digital device, pursuant to Part 15 of the FCC Rules. These limits are designed to provide reasonable protection against harmful interference in a residential installation. This equipment generates, uses, and can radiate radio frequency energy and if not installed and used in accordance with the instructions, may cause harmful interference to radio communications. However, there is no guarantee that interference will not occur in a particular installation. If this equipment does cause harmful interference to radio or television reception, which can be determined by turning the equipment off and on, the user is encouraged to try to correct the interference by one or more of the following measures:

- Reorient or relocate the receiving antenna.
- Increase the separation between the equipment and the receiver.
- Connect the equipment into an outlet on a circuit different from that to which the receiver is connected.
- Consult the dealer or an experienced radio/TV technician for help.

The user is cautioned that changes or modifications not expressly approved by SMA America, Inc. could void the user's authority to operate this equipment.

### IC Compliance

This device complies with Industry of Canada licence-exempt RSS standard(s). Operation is subject to the following two conditions:

- This device may not cause interference, and
- This device must accept any interference, including interferences that may cause undesired operation of the device.

## 14 Contact

If you experience technical problems with our products, please contact SMA Service Line. We require the following information in order to provide you with the necessary assistance:

- Inverter type
- Type and number of modules connected
- Type of communication
- Interference or warning messages from Sunny Boy
- Sunny Boy display message

### **SMA Solar Technology America, LLC**

6020 West Oaks Blvd, Ste 300

Rocklin, CA 95765

Tel. +1 916 625 0870

Tel. +1 877-MY SMA TECH

Tel. +1 877 697 6283 (toll free, available for USA, Canada, and Puerto Rico)

Fax +1 916 625 0871

Service@SMA-America.com

www.SMA-America.com

### **SMA Solar Technology Canada Inc.**

2425 Matheson Blvd E, 8th Floor

Mississauga, ON L4W 5K5, Canada

Tel. +1 877 506 1756 (toll free, available for Canada)

Service@SMA-Canada.ca

www.SMA-Canada.ca

**SMA America Production, LLC**

**www.SMA-America.com**

