

THANK YOU FOR PURCHASING A FINE U.S. MADE TOOL FROM THE PEOPLE WHO PIONEERED THE FIRST PRACTICAL BX CUTTER. PLEASE SPEND A FEW MINUTES TO READ THESE INSTRUCTIONS TO GET YEARS OF SATISFACTION

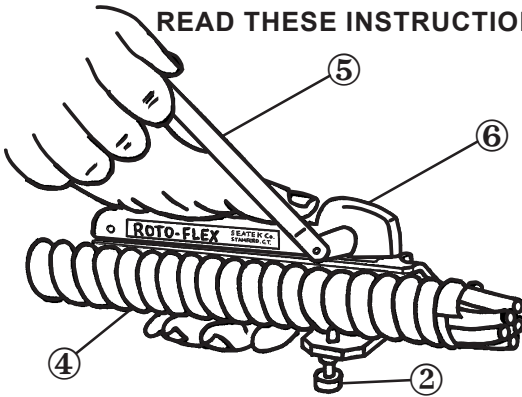

MADE IN
U.S.A

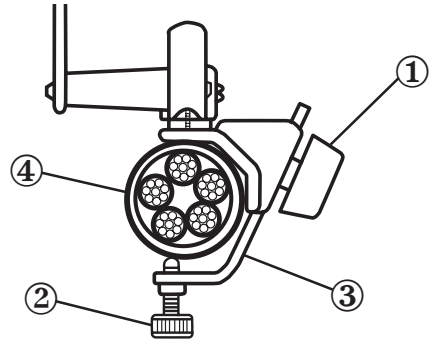

STEP 1 - CLAMPING BX, MC CABLE & FLEX USING THE ROTO-FLEX RF-170

The large black knob ① on the RF-170 locks the cable clamping bracket ③. To clamp a cable first make sure that the bottom thumb screw tip ② protrudes about 1/4" through the bracket. Move the bracket ③ by loosening knob ① about 1/4" of a turn to free the bracket. Then slide the bracket ③ until the tip of the clamping thumb screw falls into the valley of the cable convulsion ④. Then tighten the knob ① securely and lock the thumb screw ② holding the cable. This unique cable guide allows you to cut flex from 1/2" to 1-1/2" trade size as well as to strip MC cables from .84" to 1.82" in outside diameter.

WARNING!!

Never attempt to cut already installed BX, MC or Flex cables on live lines, since any contact between a live wire and ground can be lethal.

STEP 2 - CUTTING BX AND MC CABLES

Clamp the cable as described in STEP 1, squeeze the top and bottom housing together with your left hand and start turning the crank ⑤ as you continue to squeeze. When the blade spins freely release the top housing completely. Loosen the bottom thumb screw ② and remove the cable. Hold the cable on each side of the cut and unscrew the armor to remove it. The RF-170 has an outstanding feature permitting you to cut large diameter cables by allowing the top portion of the tool ⑤ to slide to three indexed positions (see label above). Since large cables have generally wider convolutions more travel is needed to cut through the convulsion. For cables up to about 1" in diameter use the middle position (0). For cables above 1" in diameter use the rear position (1), then the most forward position (2). Please note that the top housing can only be moved when you are not squeezing the tool.



STEP 3 - IMPORTANT NOTES:

1. The cable must be straight. If the cable is slightly curved, place the top of the curved section towards the blade. (The Roto-Flex can be rotated around the cable if necessary.) If the cable is curved away from the cutting blade it will not cut deep enough to cut through the convolutions.
2. The cable must be clamped securely to hold the armored casing against the shelf where the blade protrudes.
3. If the cut is slightly too shallow the casing can sometimes be separated by inserting the flat tip of a screwdriver into the slot made by the blade. Turn the screwdriver, the casing should then crack open.

ATTENTION: *The RF-170 has been set at the factory for armored casing with 5/32" wall thickness. Due to the lack of standardization of MC, AC and BX cable armor thickness, a depth of cut adjustment screw is provided to set blade penetration. Omit this process when cutting FLEX or liquid tight.*

1. Make a trial directly above a conductor to make sure that no wire insulation is nicked or cut.
2. Each half turn of the set screw moves the blade 25 thousandths of an inch (.025").
3. If the cut is too deep screw in the **Adjustment Screw** by turning it clockwise.
4. If the cut does not cut completely through the armor turn the **Adjustment Screw** counterclockwise.
5. Repeat the operation until you are satisfied the blade does not touch the insulation.

BLADE STORAGE & REPLACEMENT

The **RF-170** has a blade storage cartridge contained in the knob. To release this cartridge simply pop it out with the flat tip of a screwdriver. Place your spare blades inside (up to a maximum of six) and snap the cartridge back into the knob. For best results always use genuine **Cat. B-107** blades for aluminum cable. To change the blade refer to the instruction sheet provided with each blade package. **Always lubricate the blade shaft and thumb screw each time the blade is replaced.**

CUTTING LIQUID TIGHT CONDUIT

The same procedure as described above can be used to cut **liquid tight**. If the casing is not completely cut through make sure that the depth of cut adjustment screw is completely backed out. You will get better results by using our **SWING-SAW SW-130** which is specially designed to cut liquid tight - you'll get a clean square cut every time.







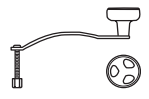
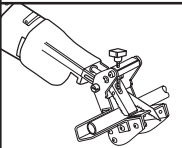

WARRANTY

All the ROTO-SPLIT and ROTO-FLEX models have a lifetime guaranty except for the blade. They are warranted to be free from defects in workmanship and material. Should any part of these tools be defective, they will be serviced or replaced free of charge (except for replacement blade).

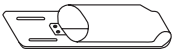
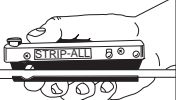
This warranty is void if these tools have been damaged by accident or mishandling. THIS WARRANTY IS IN LIEU OF ALL OTHER WARRANTIES EXPRESS OR IMPLIED, except for repair or replacement of parts, Seatek Company assumes no liability for damage to the replacement blade or other damages.

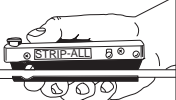
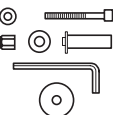
ACCESSORIES & TOOLS

REPLACEMENT BLADES 	B-102	BLUE SAPPHIRE BLADE FOR ALL ABOVE TOOLS. RS-101, RS-101A, RF-120A, RF-120B & RF-170.		101-110	HANDLE ASSEMBLY FOR RS-101, RS-101A, RF-120A, RF-120B AND RF-170 WITH BLADE CARTRIDGE STORED IN KNOB.	
	B-107	SAME AS ABOVE BUT FOR ALUMINUM (WORKS ON STEEL CASING TOO BUT ONLY FOR 1/2" TRADE SIZE & ABOVE).				CONSISTS OF AN ADJUSTABLE VISE THAT SECURES THE MATERIAL TO BE CUT WITH AN ADJUSTABLE QUICK CLAMPING SYSTEM. RANGE FROM 3/16" TO 2". THIS ACCESSORY FITS MILWAUKEE® BRAND RECIPROCATING SAWS INCLUDING THE 18 VOLT CORDLESS AND SUPER SAWZALL®.
	B-108	FOR ALL POWER TOOLS & MACHINES. RS-101-AP, PC-205A, RM-202A, B & C, RM-202M AND RSK-155A.				
LUBRICANT 	LS-105	LUBRICANT STICK FOR BLADES AND RS-101, RS-101A, RS-101AP, RF-120A, RF-120B & RF-170 AND ALL ROTOMATIC MODELS.	MIGHTY-MITER	MM-175		
LEATHER HOLDER 	LP-103	LEATHER TOOL HOLDER FOR RS-101, RS-101A, RS-101AP ZS-140, RF-170, & SW-130		SA-200	STRIPPER FOR JACKETED CABLES (PLASTIC, TEFLON OR RUBBER). STRAIGHT & RING CUTTING FROM 1/4" TO 5/8" DIA. WITH WIRE STRIPPER, FOLDING KNIFE BLADE & REPLACEMENT BLADE. PRECISION DEPTH OF CUT ADJUSTMENT.	
HARDWARE RETROFIT 	101-106	SPARE PART KIT FOR RS-101, RS-101A, RF-120A, RF-120B & RF-170. CONSISTING OF ONE SHAFT, ONE NUT, ONE 4-40 KNURLED SCREW, ONE THUMBSCREW FOR RS-101 ONLY.		STRIP-ALL		
POWER KIT 	101-107	POWER CONVERSION KIT. MOTORIZE ANY ROTO-SPLIT AND ROTO-FLEX (SAME PRINCIPLE AS POWER-SPLIT). CONSISTS OF B-108 BLADE, SHAFT, SCREW, WASHERS, HEX NUT & HEX WRENCH.		SW-130	COMPACT HAND TOOL TO CUT SQUARE ANY LIQUID TIGHT CONDUIT. CAN BE USED ON PLASTIC, COPPER, ALUMINUM & STEEL TUBING, THREADED RODS, EMT CONDUIT, SURFACE RACEWAYS ETC. MAXIMUM VISE JAW OPENING 1-1/2". BLADES ARE EASILY REPLACED.	
				"HINGENIOUS" FT-210	CAM ACTION, HINGED FISH TAPE PULLER, TWO HANDED ACTION FOR TWICE THE PULLING FORCE. MUCH SAFER AND PREVENTS KINKS IN TAPE.	



Co.
Inc.

A SMALL COMPANY WITH BIG IDEAS®

392 PACIFIC STREET, STAMFORD, CT 06902

PHONE (203) 324-0067 ☆ FAX (203) 324-7844 ☆ www.SeatekCo.com

All brands and product names are trademarks or registered trademarks of their respective companies

