

HOW TO MAKE A FREEZER PAPER CIRCLE USING THE TEMPLATE SHEET FROM YOUR BOOK.

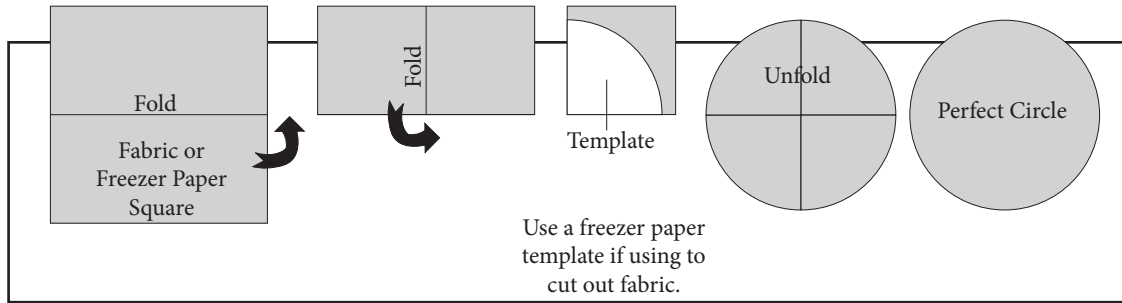

Details for instructions on Page 14 of your Skinny Robin or Fat Robin Mariner's Compass Book.

a) Cut freezer paper square a little bigger than the size circle you want to make. It doesn't have to be a perfect square.

b) Fold freezer paper square in

c) Fold freezer paper square in half again. Make sure that folds are aligned so you don't get a wonky square.

d) Open freezer paper up to full square.

Circle Templates for Block Finishing

Trace over line for your circle size.

----- Includes 1/4\" Seam Allowance
 _____ Finished Block Size
 - - - - - Circle Size for Background Fabric

e) Place freezer paper on top of template sheet, lining up the folds along the straight edge lines of the quarter circle drawing. Trace the line for the size circle you want to make.

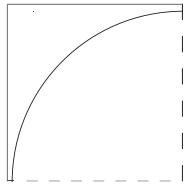

f) Fold paper back up and cut along your traced line, making sure to keep the folded edges lined up so you don't get a wonky circle.

TIP: Staple the bottom folded edges to keep them lined up while you cut the curved edge.

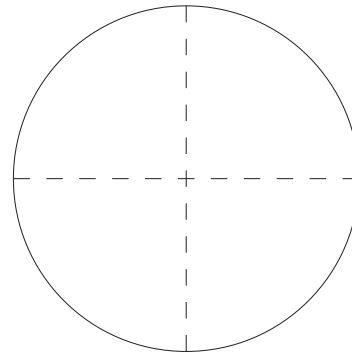

g) Unfold your freezer paper and you should have a perfect circle.

FACING METHOD FOR MAKING CIRCLE CENTER

a) Use the previous method to make a freezer paper circle, except this time trace the SOLID quarter circle line for your size block.

Skinny Robin Compass Centers (Also centers for Compass Sunflower Block - Pattern sold separately)

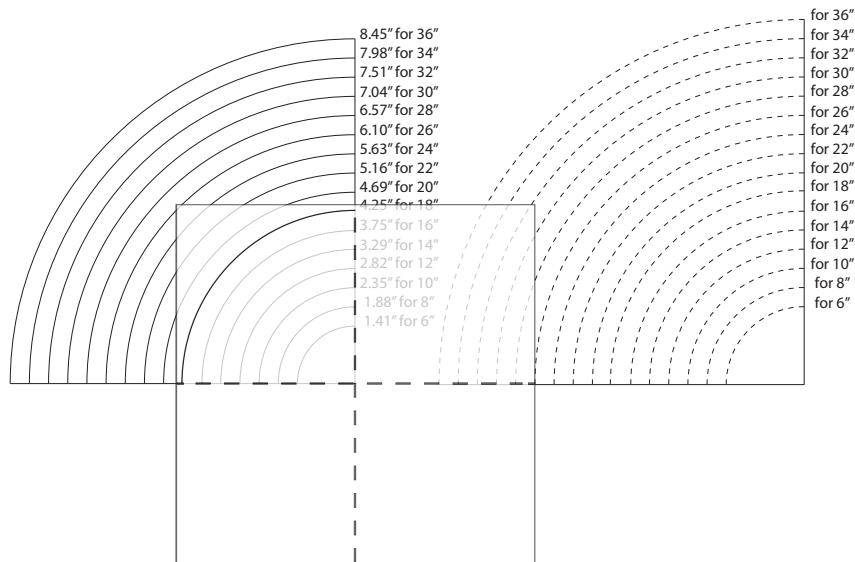

b) Cut two squares of your center fabric (you could also cut one of the squares out of a lighter weight facing material). Place fabric squares right sides together, and press freezer paper circle onto squares.

c) Stitch closely and completely around freezer paper circle. You will want to decrease your stitch length the smaller the circle. This will result in a more round finished circle. Remove freezer paper and trim to about 1/8" around stitching line. Make a slit in the back and turn. Pinch edges between your fingers and roll them out to stitching, making the circle as round as possible. Press and appliqué as desired.

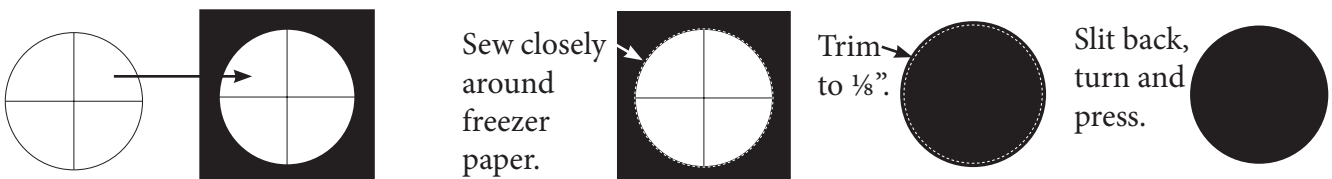

SEWING THE COMPASS BLOCK (CIRCLE) INTO A SQUARE

Details for instructions on Page 15 of your Skinny Robin or Fat Robin Mariner's Compass Book.

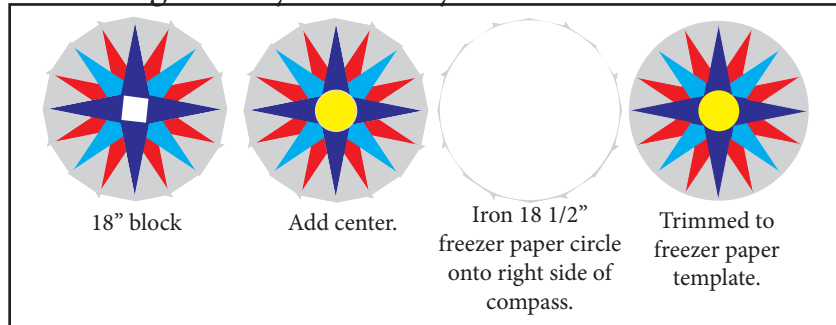

STEP 1 - TRIM YOUR RAW BLOCK

To SEW your compass block INTO your background square, you will need a FREEZER PAPER CIRCLE THAT IS $\frac{1}{2}$ " LARGER THAN THE FINISHED SIZE of your block.

If you cut strips for an 18" block, then you need an 18½" freezer paper circle.



a) Raw compass block.

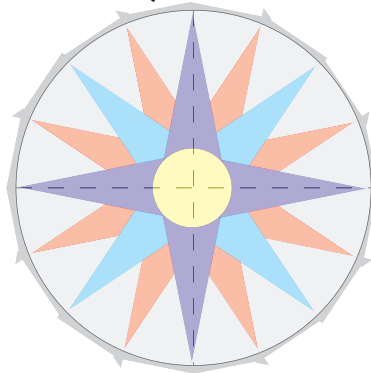

b) Press freezer paper onto RIGHT side of compass block, lining up freezer paper edge along N, S, E, and W points. Make sure there is $\frac{1}{4}$ " freezer paper extending beyond all of the point (seam allowance.) Tip: Fold freezer paper $\frac{1}{4}$ " to inside at N, S, E, and W points, and center the freezer paper within these points.



c) Trim raw block flush with freezer paper.

STEP 2 - CUT HOLE OUT OF BACKGROUND SQUARE

You will also need a

FREEZER PAPER QUARTER CIRCLE THAT IS 1" SMALLER THAN THE ABOVE CIRCLE.

If you cut the above freezer paper circle 18½", then you will need a 17½" quarter circle.

Rule of thumb - You always cut the hole out of the background so that it is 1" SMALLER THAN THE UNFINISHED SIZE OF YOUR COMPASS BLOCK.

For example, if you made an 18" block and trim it with a $\frac{1}{4}$ " seam allowance, it will now measure 18½". This means your background hole needs to be 1" smaller, so you need a 17½" freezer paper quarter circle.

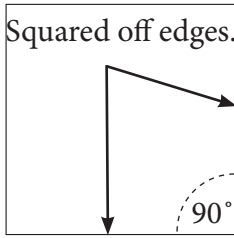

Circle Templates for Block Finishing

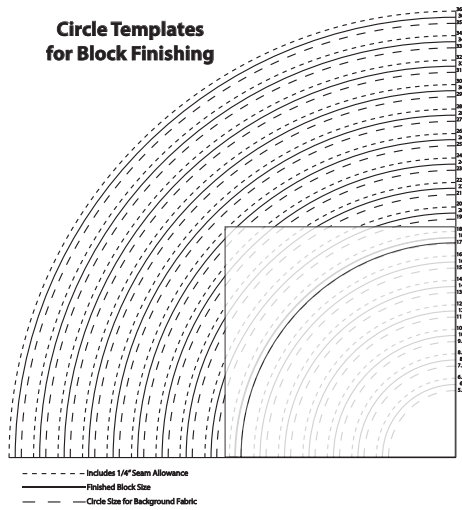

a) Cut freezer paper square a little bigger than the size quarter circle you want to make (remember this will be half of the full circle size, plus a little extra). Square off the bottom and right side edges.

b) Place freezer paper on top of template sheet, lining up the squared off edge along the straight edge lines of the quarter circle drawing. Trace the line for the size circle you want to make.

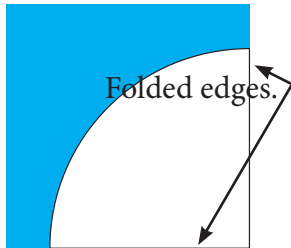
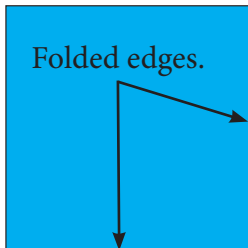

c) Fold your fabric square just like you did when you made your freezer paper circle in previous "How to make a freezer paper circle" instructions.

d) Press freezer paper quarter circle onto folded background square, lining up straight edges of freezer paper with folded edges of fabric. Cut fabric flush with curved edge of freezer paper.

e) After cutting out the circle, fold the background square again in half matching the side folds and lightly press. This will give you another set of reference points when you pin this background square to the raw block.

STEP 3 - PIN AND SEW BACKGROUND SQUARE TO TRIMMED COMPASS

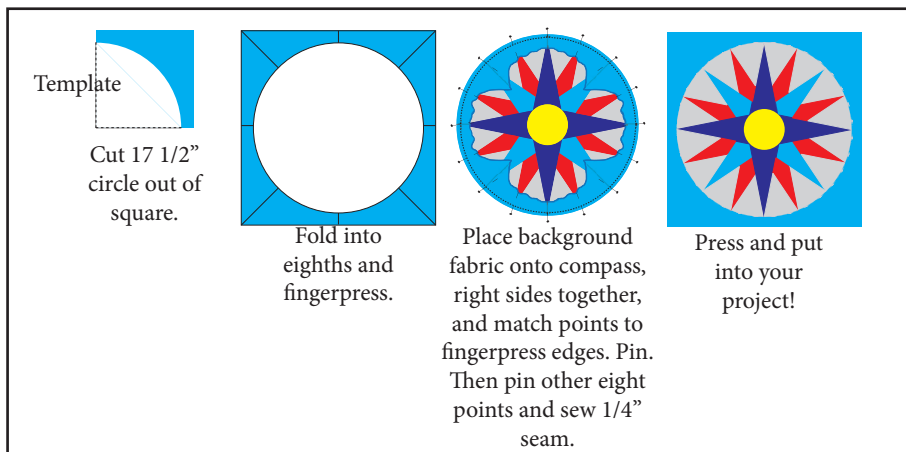

Continue to follow the instructions on Page 15 of your Skinny Robin or Fat Robin Mariner's Compass Book to sew your raw block into the background square.

APPLIQUEING COMPASS BLOCK ONTO BACKGROUND

Details for instructions on Page 15 of your Skinny Robin or Fat Robin Mariner's Compass Book.

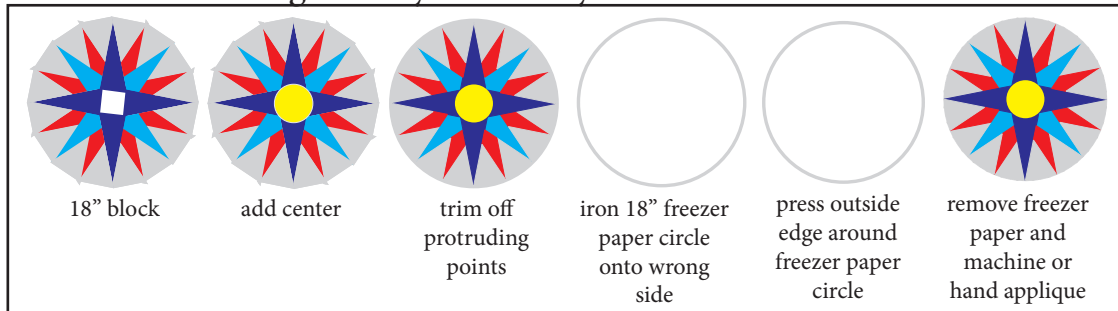

To **APPLIQUE** your compass block onto your background square, you will need a **FREEZER PAPER CIRCLE THAT IS THE FINISHED SIZE** of your block. If you cut strips for an 18" block, then you need an 18" freezer paper circle.



a) Compass block after trimming off protruding points.

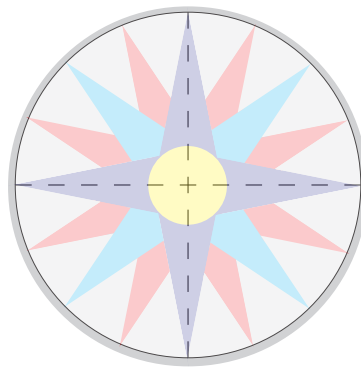

b) Press freezer paper onto **WRONG** side of compass block, lining up freezer paper edge along 'stitching x's' and freezer paper folds with N, S, E, and W points.

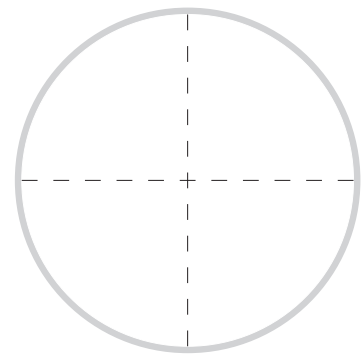

c) Press outside compass edge around freezer paper circle. Remove freezer paper and machine or hand applique.