







### Fixtures

-  = Viper Performance EXT
-  = Quantum Wash EXT
-  = Sharpys (Vector)
-  = Arena Par Zoom (10 Chan)
-  = Source 4 19°
-  = DFD Opto

# AWE Theater Overview

Date: 5/15/17

DB: A. Miller

Page 1 of 6

Dimmer  
Land

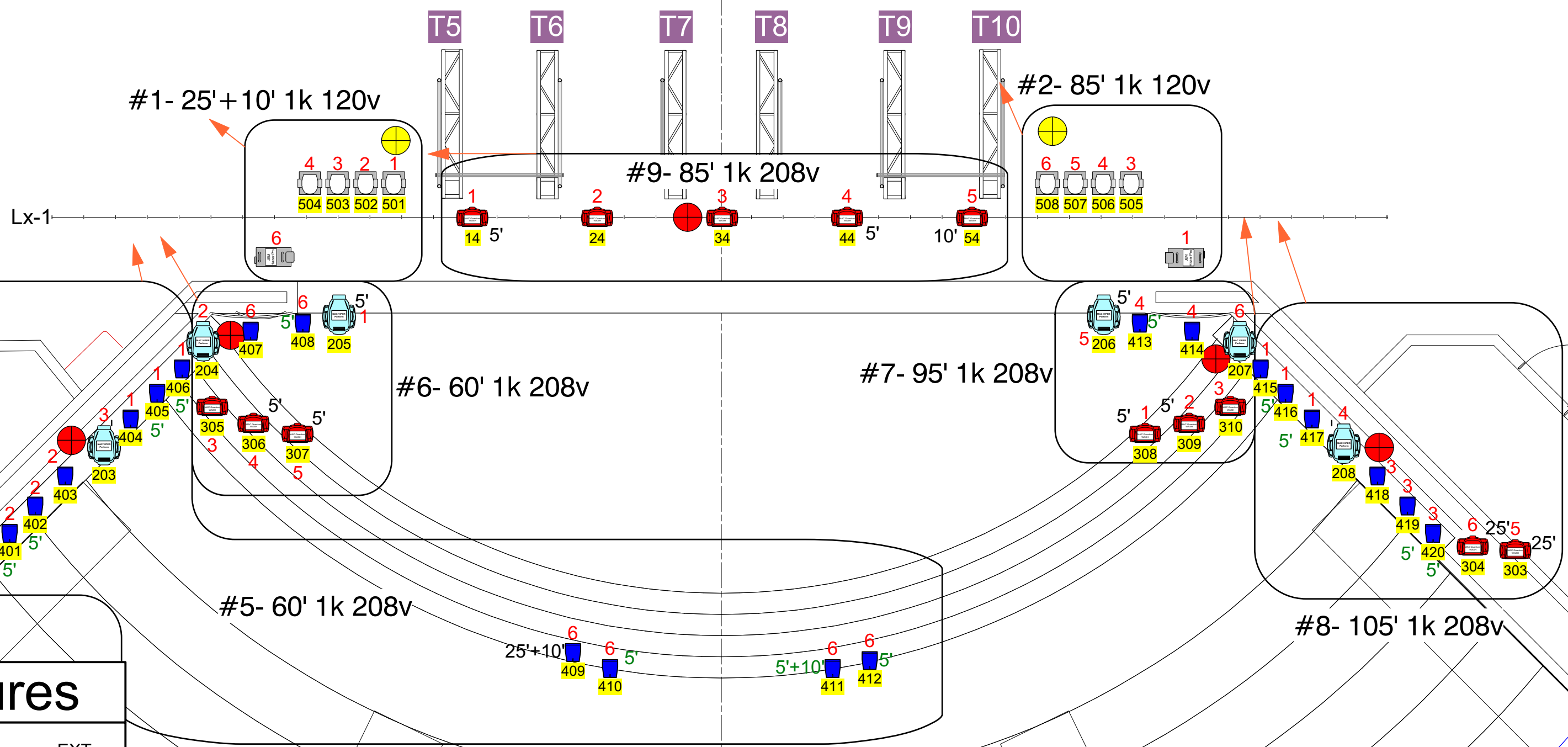

# Fixtures

- = Viper Performance EXT
- = Quantum Wash EXT
- = Sharp (Vector)
- = Arena Par Zoom (10 Chan)
- = Source 4 19°
- = DFD Opto





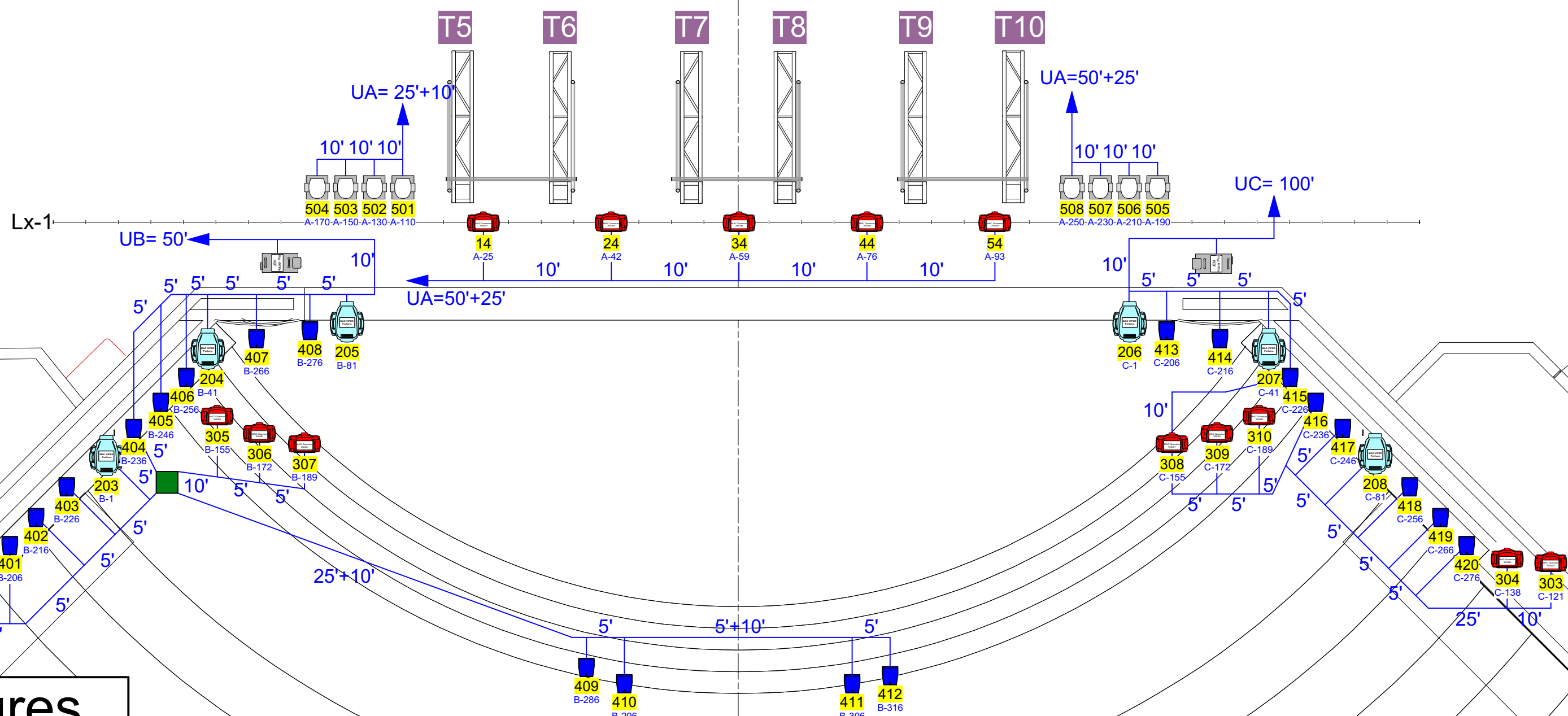

# Robot Power

- = Soca to L6-20 BO 208 volt
- = Soca to L6-20 BO 120 volt
- = 1k Multi
- 1** = circuit number
- 5'** = L6-20
- 5'** = Powercon to Powercon

# Stage Mover Power



# Fixtures

-  = Viper Performance EXT
-  = Quantum Wash EXT
-  = Sharp (Vector)
-  = Arena Par Zoom (10 Chan)
-  = Source 4 19°
-  = DFD Opto

## Data Key

— = 5-Pin DMX

# Stage Mover Data

Date: 5/15/17

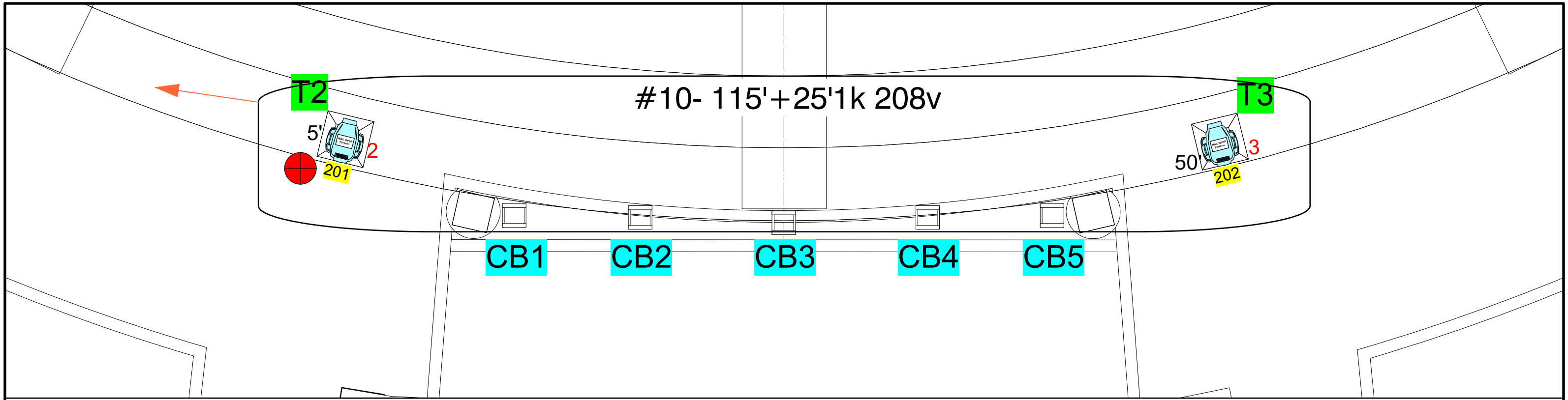

DB: A. Miller

Page 3 of 6









## Center

### Robot Power

-  = Soca to L6-20 BO 208 volt
-  = Soca to L6-20 BO 120 volt
-  = 1k Multi
- 1** = circuit number
- 5' = L6-20
- 5' = Powercon to Powercon

### Fixtures

-  = Viper Performance EXT
-  = Quantum Wash EXT
-  = Sharpie (Vector)
-  = Arena Par Zoom (10 Chan)
-  = Source 4 19°
-  = DFD Opto

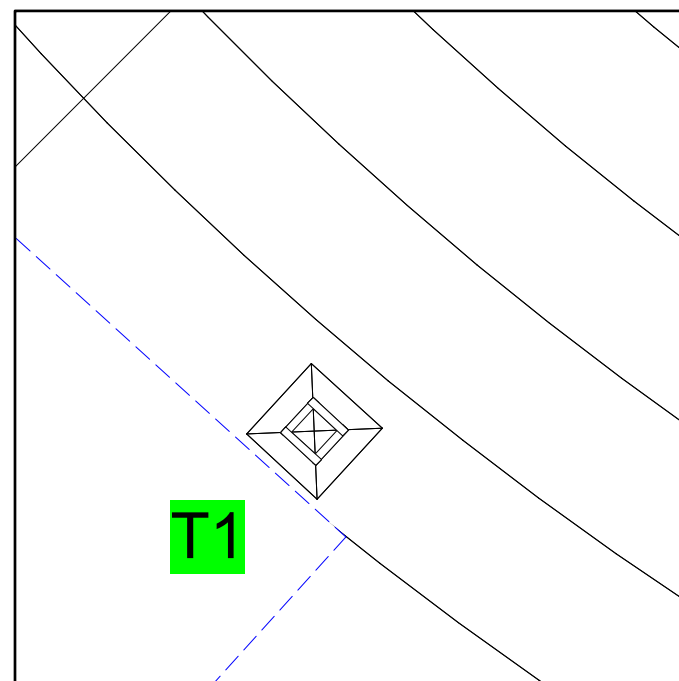

House Left

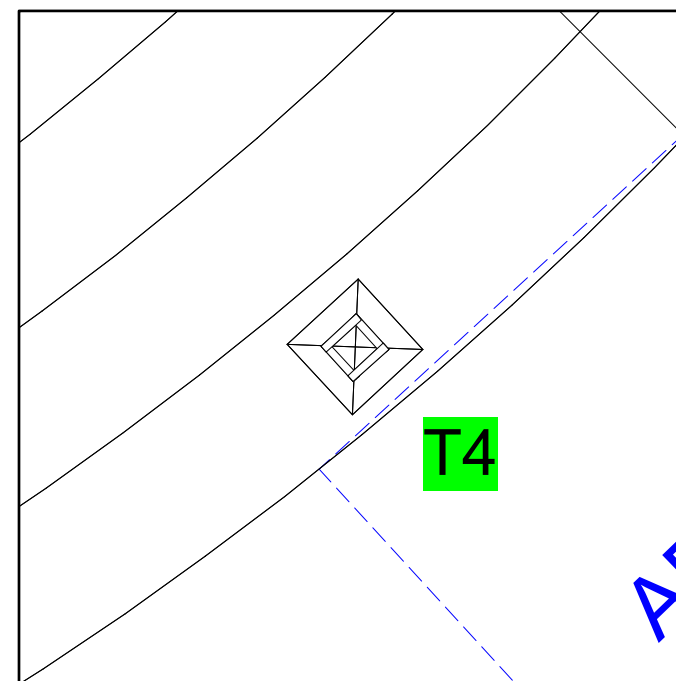

House Right

## FOH Mover Power

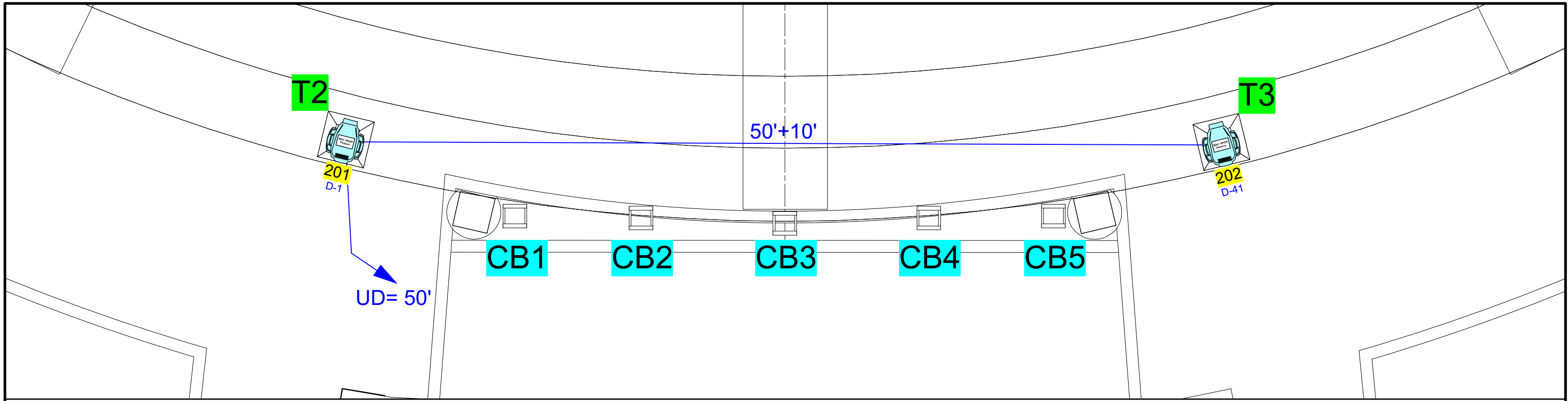







## Center

### Data Key

— = 5-Pin DMX

### Fixtures

-  = Viper Performance EXT
-  = Quantum Wash EXT
-  = Sharpie (Vector)
-  = Arena Par Zoom (10 Chan)
-  = Source 4 19°
-  = DFD Opto

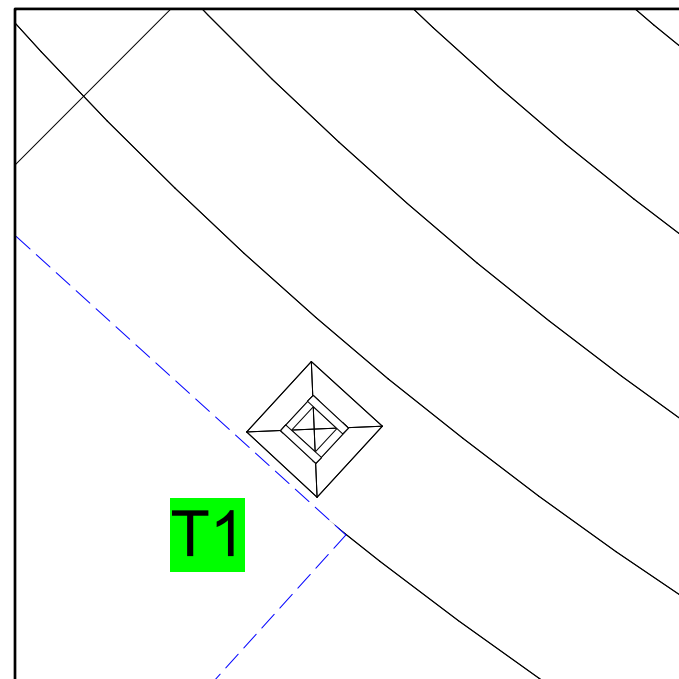

## House Left

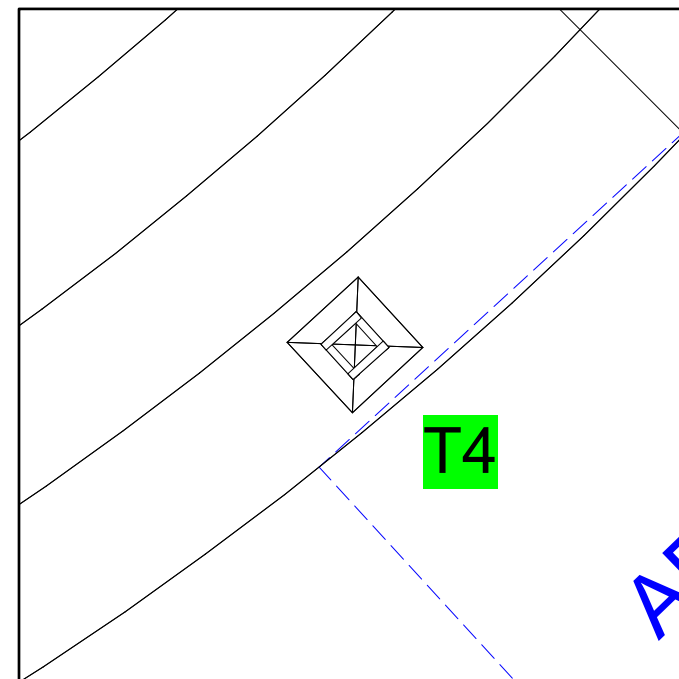

## House Right

## FOH Mover Data

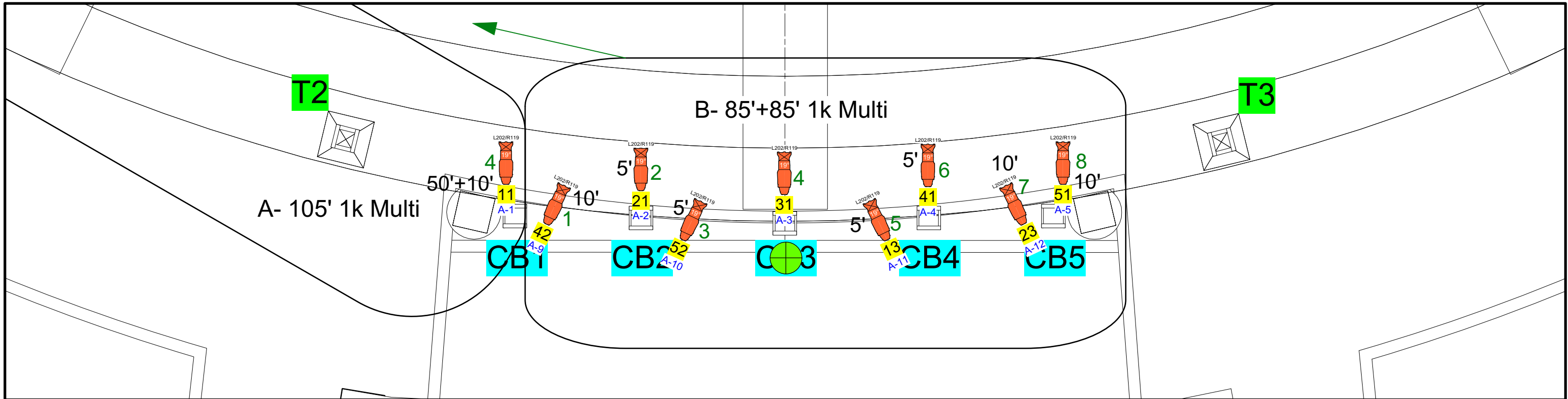

## Center

### Conventional Power

- = Soca to Edison BO 120 volt
- = 1k Multi 208volt
- 1** = circuit number
- 5'** = Edison

### Fixtures

- = Viper Performance EXT
- = Quantum Wash EXT
- = Sharpie (Vector)
- = Arena Par Zoom (10 Chan)
- = Source 4 19°
- = DFD Opto

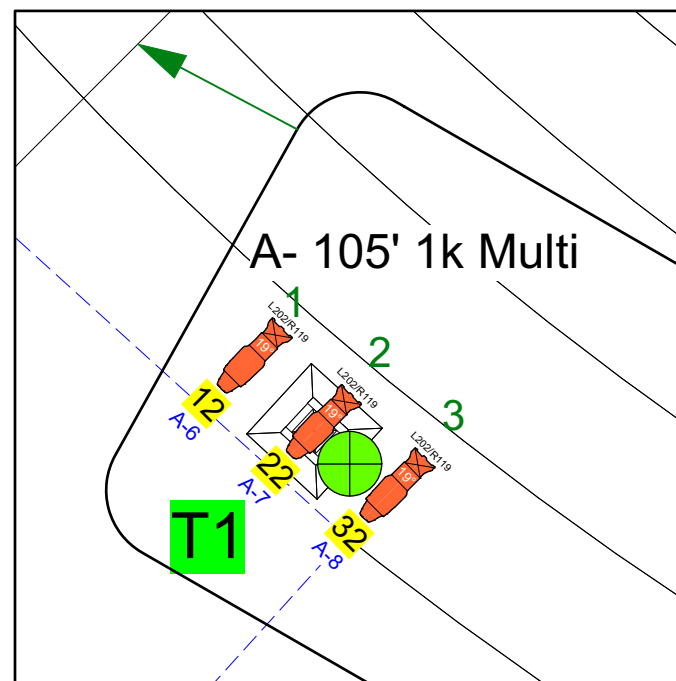

## House Left

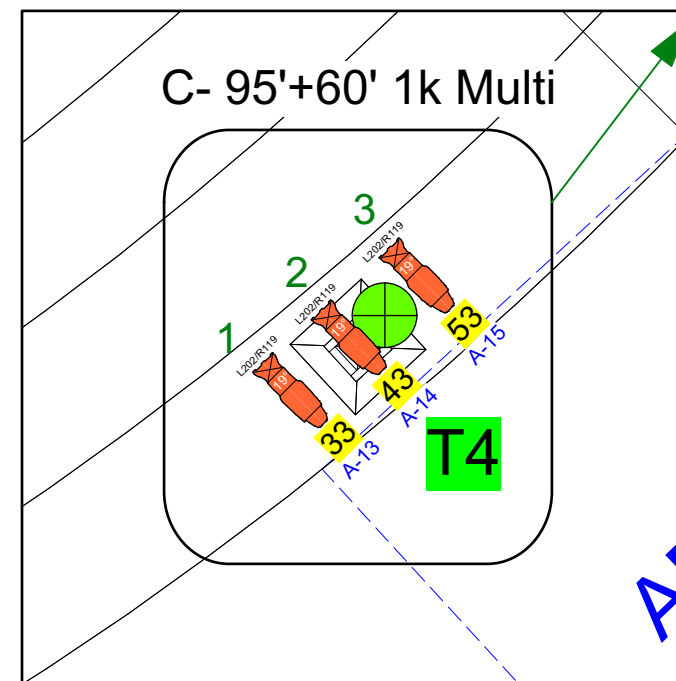

## House Right

# FOH Conv. Power