



The NARS Series has been designed for those intersections where power is not available but good signage is required.

The NARS Series is available with reflective or nonreflective backgrounds and selected translucent colored films. Add custom logos or symbols to personalize.

Available as single or double faced fixtures.

- *All Aluminum Construction*
- *High Corrosion Resistant Housing and Brackets*
- *Highly Reflective Legend Panel*
- *Free-Swinging Brackets for Reduced Wind Loads*

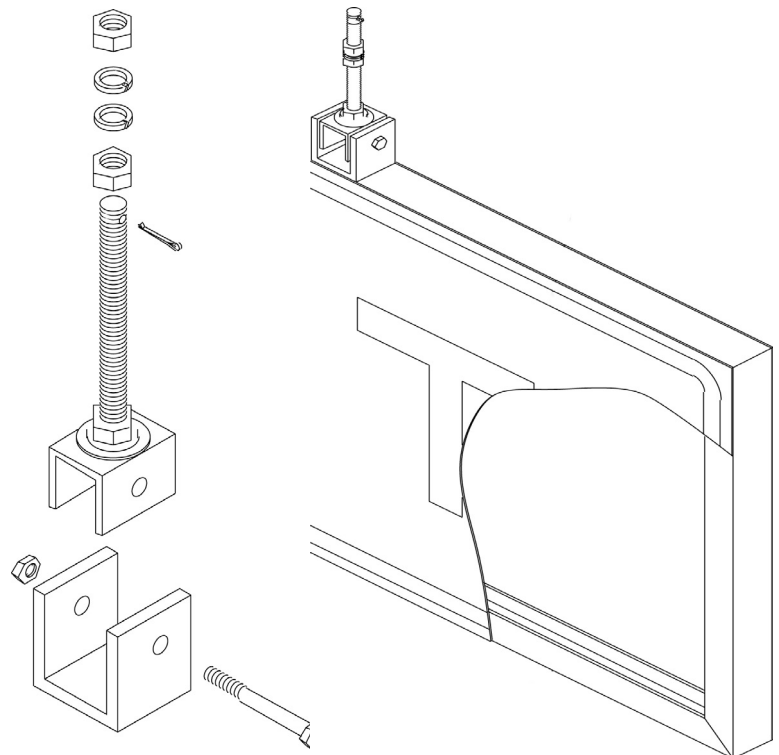

# Specifications

## Sign Frame

Sign frame is fabricated from 2" x 2" x 1/8" aluminum channel. Aluminum channel in 6063-T5 alloy resists corrosion, is durable, and trouble free. Corners are mitered, "MIG" welded, and ground smooth. Standard finish for sign frame is natural aluminum.

## Mounting Brackets

Standard bracket is free-swinging for mast arm mounting. Telescoping mounting brackets are also available for ease of leveling. Sign is also available with direct mounting to either mast arm of a vertical pole. All styles of mounting brackets are constructed from aluminum alloys with stainless steel hinge points and fasteners.

## Sign Panel

Sign panel is constructed of 6061-t6 aluminum and is secured to the frame by rivets, spaced approximately 6.5" apart.

## Weights

Maximum Weight (including adjustable bracket)

48" 30 lbs; 60" 35 lbs; 72" 40 lbs; 84" 45 lbs; 96" 50 lbs

### Product ID Model

NARS

### Sign Length

48"; 60"; 72"; 84"; 96"

### Height

18" Standard, Optional 24" and 30"

### Face

S- Single Face;  
D- Double Face

### Face Material

DG3

### Face Background Color

G- Green  
B- Interstate Blue  
B- Brown  
YB- Yellow w/Blk letters

### Finish and Color

NA - Natural aluminum (Std.)  
CC - Custom (please specify)

### Mounting

ES-33 - Mast Arm Clamps (std)  
MPM - Medium Post Mount  
Adjustable - Brackets

Specifications subject to change any time without notice. Copyright 2018 National Signal, Inc. All rights reserved. Printed in the United States.