



## **Skogan Court in River's Bend**

### **Customer Profile & Interior Selections**

Suite #:

Suite Address:

---

Customer Name(s):

Customer Address:

Home phone #:

Cell phone #:

Email:







Released to Construction Date:







---



Client Approval





---







Date



<p><b>Vinyl Plank</b></p> <p>Locations:  <b>Kitchen</b>  <b>Dining Room</b>  <b>Living Room</b>  <b>Half Bath</b>  <b>Entry Closet</b>  <b>Lower Hillway</b></p> <p><b>Stair treads &amp; risers</b>  <b>Entry to main level</b></p> <p><b>*Refer to architectural plans for standard floor transitions</b></p>	<p>Contractor: <b>RGO Flooring</b>          Manufacturer: <b>Shaw</b>          Series: <b>Uncommon Ground 6</b>          Size: <b>6" x 36"</b>          Style: <b>0188V</b>          Colour: <b>02140 Provence</b>          Construction: <b>20 mil LVT</b></p> 	<p>Contractor: <b>RGO Flooring</b>          Manufacturer: <b>Shaw</b>          Series: <b>Uncommon Ground 6</b>          Size: <b>6" x 36"</b>          Style: <b>0188V</b>          Colour: <b>02500 French Grey</b>          Construction: <b>20 mil LVT</b></p> 	<p>Contractor: <b>RGO Flooring</b>          Manufacturer: <b>Shaw</b>          Series: <b>Uncommon Ground 6</b>          Size: <b>6" x 36"</b>          Style: <b>0188V</b>          Colour: <b>02720 Adirondack</b>          Construction: <b>20 mil LVT</b></p> 
<p><b>Metal Nosing</b></p> <p>Locations:  <b>Stair treads &amp; risers</b>  <b>Entry to main level</b></p>	<p>Contractor: <b>RGO Flooring</b>          Manufacturer: <b>Prosol</b>          Finish: <b>Titanium</b></p> 	<p>Contractor: <b>RGO Flooring</b>          Manufacturer: <b>Prosol</b>          Finish: <b>Titanium</b></p> 	<p>Contractor: <b>RGO Flooring</b>          Manufacturer: <b>Prosol</b>          Finish: <b>Titanium</b></p> 

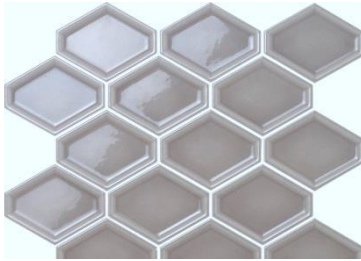

<p><b>Floor Tile</b></p> <p>Locations: <b>Front Entry</b> <b>Ensuite #1</b> <b>Main Bath</b></p>	<p>Contractor: <b>RGO Flooring</b>                  Manufacturer: <b>Tierra Sol</b>                  Series: <b>Angora Mosera</b>                  Material: <b>Porcelain</b>                  Size: <b>12" x 24"</b>                  Installation: <b>Offset</b>                  Colour: <b>Sand Natural</b>                  Code: <b>FGANMSA1224</b>                  Grout: <b>Custom #382 Bone</b></p> 	<p>Contractor: <b>RGO Flooring</b>                  Manufacturer: <b>Tierra Sol</b>                  Series: <b>Angora zera annex</b>                  Material: <b>Porcelain</b>                  Size: <b>12" x 24"</b>                  Installation: <b>Offset</b>                  Colour: <b>Oyster Natural</b>                  Code: <b>FGANZAOYSTER</b>                  Grout: <b>Custom #10</b>  <b>Antique White</b></p> 	<p>Contractor: <b>RGO Flooring</b>                  Manufacturer: <b>Tierra Sol</b>                  Series: <b>Angora Kalahari</b>                  Material: <b>Porcelain</b>                  Size: <b>12" x 24"</b>                  Installation: <b>Offset</b>                  Colour: <b>Sand Natural</b>                  Code: <b>FGANKSA1224N</b>                  Grout: <b>Custom #382 Bone</b></p> 
<p><b>Carpet</b></p> <p>Locations: <b>Master Bedroom</b> <b>(Includes closet)</b></p> <p><b>Bedroom #2</b> <b>(Includes closet)</b></p> <p><b>Bedroom #3</b> <b>(Includes closet)</b></p> <p><b>Upper Hallway</b></p> <p><b>Stairs Main level to</b> <b>Upper level</b></p>	<p>Contractor: <b>RGO Flooring</b>                  Manufacturer: <b>Coronet</b>                  Series: <b>Opus II</b>                  Colour: <b>Pampa Beige 16320</b>                  Fiber: <b>100% BCF solution</b>  <b>dyed polyester</b>                  Underlay: <b>7lb</b></p> 	<p>Contractor: <b>RGO Flooring</b>                  Manufacturer: <b>Coronet</b>                  Series: <b>Opus II</b>                  Colour: <b>Scenic Grey 84725</b>                  Fiber: <b>100% BCF solution</b>  <b>dyed polyester</b>                  Underlay: <b>7lb</b></p> 	<p>Contractor: <b>RGO Flooring</b>                  Manufacturer: <b>Coronet</b>                  Series: <b>Opus II</b>                  Colour: <b>Macrame 14722</b>                  Fiber: <b>100% BCF solution</b>  <b>dyed polyester</b>                  Underlay: <b>7lb</b></p> 
<p><b>Unfinished Concrete</b></p> <p>Location: <b>Garage Floor</b> <b>Mechanical room</b> <b>Unfinished lower</b> <b>level portion</b></p>			

<p><b>Cabinetry</b></p> <p>Location:</p> <p><b>Kitchen &amp; Island Main Bath Ensuite #1 (includes tall vanity pantry)</b></p>	<p>Contractor: <b>Legacy Kitchens</b>                  Manufacturer: <b>Kitchen Craft</b>                  Series: <b>Aurora Line</b>                  Door Style: <b>Salem Solid</b>                  Wood Type: <b>Maple</b>                  Stain: <b>Winter</b>                  Crown Mould:  <b>Sub mould &amp; Crown to match cabinet door style to ceiling</b>                  Light Valance:  <b>To Match cabinet door style</b>                  Island Base:  <b>To Match cabinet door style</b></p>  <p><b>Cabinet Accessories Included:</b></p> <ul style="list-style-type: none"> <li>• Cutlery Tray insert</li> <li>• Drawers ¾ extension</li> <li>• Maple melamine cabinet drawers &amp; interiors</li> </ul> <p>See cabinetry plan attached for layout</p>	<p>Contractor: <b>Legacy Kitchens</b>                  Manufacturer: <b>Kitchen Craft</b>                  Series: <b>Aurora Line</b>                  Door Style: <b>Salem Solid</b>                  Wood Type: <b>Maple</b>                  Stain: <b>Thunder</b>                  Crown Mould:  <b>Sub mould &amp; Crown to match cabinet door style to ceiling</b>                  Light Valance:  <b>To Match cabinet door style</b>                  Island Base:  <b>To Match cabinet door style</b></p>  <p><b>Cabinet Accessories Included:</b></p> <ul style="list-style-type: none"> <li>• Cutlery Tray insert</li> <li>• Drawers ¾ extension</li> <li>• Maple melamine cabinet drawers &amp; interiors</li> </ul> <p>See cabinetry plan attached for layout</p>	<p>Contractor: <b>Legacy Kitchens</b>                  Manufacturer: <b>Kitchen Craft</b>                  Series: <b>Aurora Line</b>                  Door Style: <b>Salem Solid</b>                  Wood Type: <b>Alder</b>                  Stain: <b>Tuscan</b>                  Crown Mould:  <b>Sub mould &amp; Crown to match cabinet door style to ceiling</b>                  Light Valance:  <b>To Match cabinet door style</b>                  Island Base:  <b>To Match cabinet door style</b></p>  <p><b>Cabinet Accessories Included:</b></p> <ul style="list-style-type: none"> <li>• Cutlery Tray insert</li> <li>• Drawers ¾ extension</li> <li>• Maple melamine cabinet drawers &amp; interiors</li> </ul> <p>See cabinetry plan attached for layout</p>
--	---	---	---



<p><b>Vanity Mirrors</b></p> <p>Location:</p> <p><b>Ensuite #1 Half Bath Main Bath</b></p>	<p>Contractor: <b>Akita Glass</b> Type: <b>Clip style Mirror</b> Glass: <b>5mm</b></p>  <p><b>Mirror frame height = 36"</b> <b>Two Mirrors Ensuite #1</b> <b>One Mirror Ensuite #2</b> <b>One Mirror Powder Room</b> <b>Mirrors not to extend over toilets</b></p>	<p>Contractor: <b>Akita Glass</b> Type: <b>Clip style Mirror</b> Glass: <b>5mm</b></p>  <p><b>Mirror frame height = 36"</b> <b>Two Mirrors Ensuite #1</b> <b>One Mirror Ensuite #2</b> <b>One Mirror Powder Room</b> <b>Mirrors not to extend over toilets</b></p>	<p>Contractor: <b>Akita Glass</b> Type: <b>Clip style Mirror</b> Glass: <b>5mm</b></p>  <p><b>Mirror frame height = 36"</b> <b>Two Mirrors Ensuite #1</b> <b>One Mirror Ensuite #2</b> <b>One Mirror Powder Room</b> <b>Mirrors not to extend over toilets</b></p>
<p><b>Hardware</b></p> <p>Location:</p> <p><b>Kitchen &amp; Island Ensuite #1 Main Bath</b></p>	<p><b>Handle</b> Contractor: <b>Legacy Kitchens</b> Manufacturer: <b>Amerock</b> Series: <b>Blackrock</b> Size: <b>128 mm</b> Model: <b>BP55277G10</b> Finish: <b>Satin Nickel</b> Location: <b>Cabinet Doors</b></p>  <p><b>Knob</b> Manufacturer: <b>Amerock</b> Series: <b>Blackrock</b> Size: <b>1.17" x 1.17"</b> Model: <b>BP55271G10</b> Finish: <b>Satin Nickel</b> Location: <b>Cabinet Drawers</b></p> 		

<p><b>Counter tops</b></p> <p>Location:</p> <p><b>Kitchen &amp; Island Ensuite 1 Main Bath</b></p>	<p>Contractor: <b>Jadestone</b> Material: <b>Quartz</b> Colour: <b>Almond Rocca</b> Thickness: <b>¾"</b> Profile: <b>J-200 Straight Eased Edge</b></p> 	<p>Contractor: <b>Jadestone</b> Material: <b>Quartz</b> Colour: <b>Baffin Bay</b> Thickness: <b>¾"</b> Profile: <b>J-200 Straight Eased Edge</b></p> 	<p>Contractor: <b>Jadestone</b> Material: <b>Quartz</b> Colour: <b>Tofino</b> Thickness: <b>¾"</b> Profile: <b>J-200 Straight Eased Edge</b></p> 
<p><b>Wall Tile Kitchen</b></p> <p>Location:</p> <p><b>Kitchen (Include returns)</b></p>	<p><b>Kitchen Backsplash</b> Contractor: <b>RGO Flooring</b> Manufacturer: <b>Julian Tile</b> Series: <b>Classica</b> Colour: <b>Avorio</b> Code: <b>CLVI36</b> Size: <b>3" x 6"</b> Installation: <b>Offset from counter to underside of cabinets – includes returns</b> Grout: <b>Custom #382 Bone</b></p> 	<p><b>Kitchen Backsplash</b> Contractor: <b>RGO Flooring</b> Manufacturer: <b>Tierra Sol</b> Series: <b>Nova Hex</b> Colour: <b>Smoke</b> Code: <b>WBNHSMIN</b> Style: <b>Bevel in</b> Installation: <b>Horizontal from counter to underside of cabinets – includes returns</b> Grout: <b>Custom #335 Winter Grey</b></p> 	<p><b>Kitchen Backsplash</b> Contractor: <b>RGO Flooring</b> Manufacturer: <b>Julian Tile</b> Series: <b>Classica</b> Colour: <b>Visione</b> Code: <b>CLVI36</b> Size: <b>3" x 6"</b> Installation: <b>Offset from counter to underside of cabinets – includes returns</b> Grout: <b>Custom #382 Bone</b></p> 

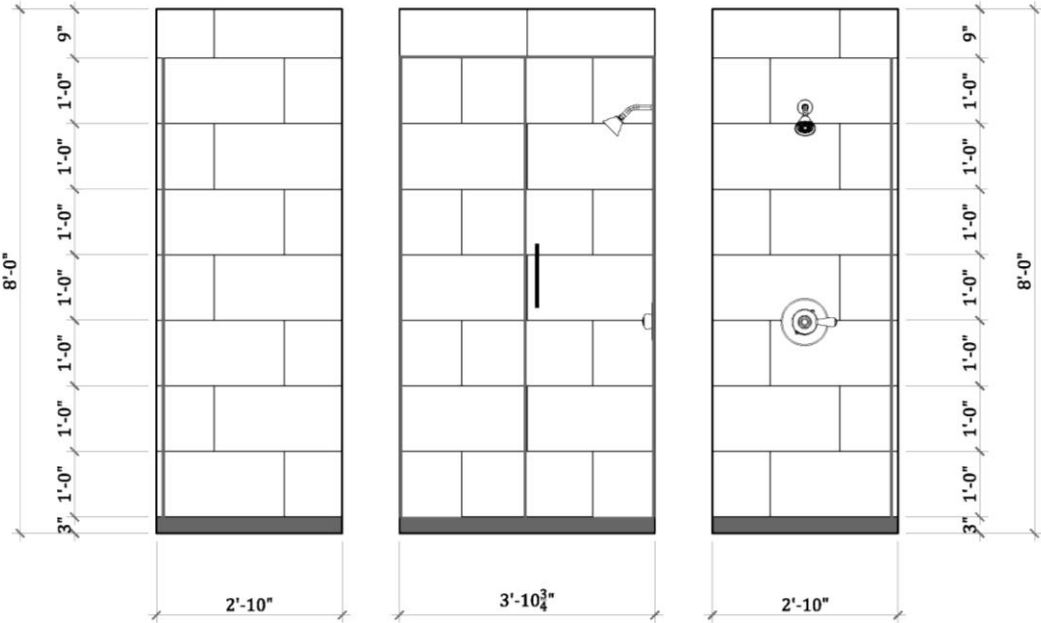
<p><b>Wall Tile</b> <b>Vanity</b> Location:  <b>Ensuite #1</b>  <b>Main Bath</b></p>	<p><b>Vanity Backsplash Tile</b> Contractor: <b>RGO Flooring</b> Manufacturer: <b>Tierra Sol</b> Series: <b>Angora Mosera</b> Material: <b>Porcelain</b> Size: <b>Mosaic Sheet</b> Installation: <b>6" High along Vanity backsplash (includes returns</b>  Colour: <b>Sand Natural</b> Code: <b>FGANMSA22MOS</b> Grout: <b>Custom #382 Bone</b></p> 	<p><b>Vanity Backsplash Tile</b> Contractor: <b>RGO Flooring</b> Manufacturer: <b>Tierra Sol</b> Series: <b>Angora Zera Annex</b> Material: <b>Porcelain</b> Size: <b>Mosaic Sheet</b> Installation: <b>6" High along Vanity backsplash (includes returns</b>  Colour: <b>Oyster Natural</b> Code: <b>FGANZAOYMOS</b> Grout: <b>Custom #10 Antique White</b></p> 	<p><b>Vanity Backsplash Tile</b> Contractor: <b>RGO Flooring</b> Manufacturer: <b>Tierra Sol</b> Series: <b>Angora Kalahari</b> Material: <b>Porcelain</b> Size: <b>Mosaic Sheet</b> Installation: <b>6" High along Vanity backsplash (includes returns)</b>  Colour: <b>Sand Natural</b> Code: <b>FGANKSASTRMOS</b> Grout: <b>Custom #382 Bone</b></p> 
--	---	---	---

<p><b>Wall Tile</b> <b>Walk in Shower</b></p> <p>Location: <b>Ensuite #1</b></p>	<p><b>Walk in Shower Tile</b> Contractor: <b>RGO Flooring</b> Manufacturer: <b>Tierra Sol</b> Series: <b>Angora Mosera</b> Material: <b>Porcelain</b> Size: <b>12" x 24"</b> Installation: <b>Offset</b> Colour: <b>Sand Natural</b> Code: <b>FGANMSA1224</b> Grout: <b>Custom #382 Bone</b></p> 	<p><b>Walk in Shower Tile</b> Contractor: <b>RGO Flooring</b> Manufacturer: <b>Tierra Sol</b> Series: <b>Angora zera annex</b> Material: <b>Porcelain</b> Size: <b>12" x 24"</b> Installation: <b>Offset</b> Colour: <b>Oyster Natural</b> Code: <b>FGANZAOYSTER</b> Grout: <b>Custom #10 Antique White</b></p> 	<p><b>Walk in Shower Tile</b> Contractor: <b>RGO Flooring</b> Manufacturer: <b>Tierra Sol</b> Series: <b>Angora Kalahari</b> Material: <b>Porcelain</b> Size: <b>12" x 24"</b> Installation: <b>Offset</b> Colour: <b>Sand Natural</b> Code: <b>FGANKSA1224N</b> Grout: <b>Custom #382 Bone</b></p> 
			



<p><b>Wall Tile Tub Shower Perimeter</b></p> <p>Location:  Main Bath</p>	<p><b>Tub Shower Perimeter Tile</b> Contractor: <b>RGO Flooring</b> Manufacturer: <b>Tierra Sol</b> Series: <b>Angora Mosera</b> Material: <b>Porcelain</b> Size: <b>12" x 24"</b> (cut to 4"-6" wide by 24") Installation: <b>Perimeter</b> Colour: <b>Sand Natural</b> Code: <b>FGANMSA1224</b> Grout: <b>Custom #382 Bone</b></p> 	<p><b>Tub Shower Perimeter Tile</b> Contractor: <b>RGO Flooring</b> Manufacturer: <b>Tierra Sol</b> Series: <b>Angora zera annex</b> Material: <b>Porcelain</b> Size: <b>12" x 24"</b> (cut to 4"-6" wide by 24") Installation: <b>Perimeter</b> Colour: <b>Oyster Natural</b> Code: <b>FGANZAOYSTER</b> Grout: <b>Custom #10 Antique White</b></p> 	<p><b>Walk in Shower Tile</b> Contractor: <b>RGO Flooring</b> Manufacturer: <b>Tierra Sol</b> Series: <b>Angora Kalahari</b> Material: <b>Porcelain</b> Size: <b>12" x 24"</b> (cut to 4"-6" wide by 24") Installation: <b>Perimeter</b> Colour: <b>Sand Natural</b> Code: <b>FGANKSA1224N</b> Grout: <b>Custom #382 Bone</b></p> 
<p><b>Wall Paint #1</b></p> <p>Location: Lower Level Main Level Upper Level Hallway Master Bedroom Bedroom #2 Bedroom #3</p>	<p>Contractor: <b>High Country Painting</b> Manufacturer: <b>Cloverdale Artisan Collection</b> Application: <b>1 primer &amp; 2 finish coats</b> Finish: <b>Eggshell</b> Colour: <b>CA011 Vellum</b></p>	<p>Contractor: <b>High Country Painting</b> Manufacturer: <b>Cloverdale Artisan Collection</b> Application: <b>1 primer &amp; 2 finish coats</b> Finish: <b>Eggshell</b> Colour: <b>CA031 Wool</b></p>	<p>Contractor: <b>High Country Painting</b> Manufacturer: <b>Cloverdale Artisan Collection</b> Application: <b>1 primer &amp; 2 finish coats</b> Finish: <b>Eggshell</b> Colour: <b>CA018 Oyster</b></p>
<p><b>Wall Paint #2</b></p> <p>Location:  Main Bath Ensuite Bath</p>	<p>Contractor: <b>High Country Painting</b> Manufacturer: <b>Cloverdale Artisan Collection</b> Application: <b>1 primer &amp; 2 finish coats</b> Finish: <b>Eggshell</b> Colour: <b>CA010 Birchbark</b></p>	<p>Contractor: <b>High Country Painting</b> Manufacturer: <b>Cloverdale Artisan Collection</b> Application: <b>1 primer &amp; 2 finish coats</b> Finish: <b>Eggshell</b> Colour: <b>CA010 Birchbark</b></p>	<p>Contractor: <b>High Country Painting</b> Manufacturer: <b>Cloverdale Artisan Collection</b> Application: <b>1 primer &amp; 2 finish coats</b> Finish: <b>Eggshell</b> Colour: <b>CA010 Birchbark</b></p>

**Kitchen  
Appliance  
Package**

**Stainless Steel Package**

**Range**

Contractor: Trail Appliances  
Manufacturer: Whirlpool  
Model: YWFE5510SOAS  
Style: Electric smooth top  
Size: 29 7/8" W x 46 7/8" H x 27 3/4" D  
Colour: Stainless w/ black accents



**Microwave Hood Fan**

Contractor: Trail Appliances  
Manufacturer: Whirlpool  
Model: YWMH31017AS  
Style: Over the range microwave hood fan combo  
Size: 29 15/16" W x 17 1/4" H x 16" D  
Colour: Stainless w/ black accents



**Top Freezer Fridge**

Contractor: Trail Appliances  
Manufacturer: Whirlpool  
Model: WRT541SZDM  
Style: 18 Cubic foot  
Size: 29 1/2" W x 66 1/4" H x 30 5/8" D  
Colour: Stainless w/ black accents







**Dishwasher**

Contractor: Trail Appliances  
Manufacturer: Whirlpool  
Model: WDF320PADS  
Style: Top mount control  
Size: 23 7/8" W x 34 1/2" H x 24 1/2" D  
Colour: Stainless w/ black accents



<p><b>Window Treatments</b></p> <p>Location: <b>All exterior windows (excluding rakes)</b></p>	<p>Contractor: <b>SF Design Studio</b>                  Manufacturer: <b>Madera Blinds Inc.</b>                  Style: <b>Venetian Blinds</b>                  Material: <b>2" Wood</b>                  Colour: <b>Oak #114</b>                  Installation: <b>Inside Mount</b>                  Details: <b>Up/Down Control: Cord</b>  <b>Tilt Control: Wand</b></p>	
<p><b>Pendant Chandelier (1)</b></p> <p>Location: <b>Dining Room</b></p>	<p>Contractor: <b>Starlight</b>                  Manufacturer: <b>Murray Feiss</b>                  Style: <b>Pendant</b>                  Model: <b>Kincaid Collection F2771/3 BS</b>                  Glass: <b>White Opal Etched</b>                  Finish: <b>Brushed Steel</b>                  Size: <b>18" x 18" H</b>                  Bulbs: <b>3 x LED bulbs</b></p>	
<p><b>Recessed Potlights (SP)</b></p> <p>Location: <b>Ensuite #1 Shower Water rated</b></p>	<p>Contractor: <b>Wayco</b>                  Style: <b>Aqua</b>                  Trim: <b>2-115</b>                  Glass: <b>F- Frosted</b>                  Finish: <b>White</b>                  Size: <b>4 1/2" Diameter</b>                  Lamp: <b>LED</b></p>	
<p><b>Recessed Potlights (P)</b></p> <p>Location: <b>Stairwell landings</b></p>	<p>Contractor: <b>WAYCO</b>                  Manufacturer: <b>Light Star</b>                  Series: <b>LSDL Series 4"</b>                  Trim: <b>White</b>                  Bulbs: <b>1 x LED bulb</b></p>	
<p><b>Flush Mount (2)</b></p> <p>Location: <b>Hallways Bedrooms Front Entry</b></p>	<p>Contractor: <b>Starlight</b>                  Manufacturer: <b>Murray Feiss</b>                  Style: <b>Pendant</b>                  Model: <b>Kincaid Collection FM371 BS</b>                  Glass: <b>White Opal Etched</b>                  Finish: <b>Brushed Steel</b>                  Size: <b>15" Diam. x 6.68" H</b>                  Bulbs: <b>2 x LED bulbs</b></p>	

<p><b>Utility Light (3)</b></p> <p>Location: <b>Laundry Room Pantry</b></p>	<p>Contractor: <b>Starlight</b>                  Style: <b>KUZCO LIGHTING 51562BN</b>                  Size: <b>15" Diameter</b>                  Bulbs: <b>2 x LED bulb</b></p>	
<p><b>Vanity Light (4)</b></p> <p>Locations: <b>Main Bath Powder Room</b></p>	<p>Contractor: <b>Starlight</b>                  Manufacturer: <b>Seagull Lighting</b>                  Style: <b>Vanity Wall Sconce</b>                  Model: <b>Oslo Collection 41162-05</b>                  Glass: <b>Cased Opal Etched Glass</b>                  Finish: <b>Chrome</b>                  Size: <b>20" W x 8. 5" H x 5.5 Ext.</b>                  Bulbs: <b>3 x LED bulbs</b></p>	
<p><b>Vanity Light (5)</b></p> <p>Location: <b>Ensuite #1 (2)</b></p>	<p>Contractor: <b>Starlight</b>                  Manufacturer: <b>Seagull Lighting</b>                  Style: <b>Vanity Wall Sconce</b>                  Model: <b>Oslo Collection 41161-05</b>                  Glass: <b>Cased Opal Etched Glass</b>                  Finish: <b>Chrome</b>                  Size: <b>12.5" W x 8. 5" H x 5.5 Ext.</b>                  Bulbs: <b>2 x LED bulbs</b></p>	
<p><b>Track Light (6)</b></p> <p>Location: <b>Kitchen Master bedroom closet</b></p>	<p>Contractor: <b>Starlight</b>                  Manufacturer: <b>Galaxy Lighting</b>                  Style: <b>Fixed track light</b>                  Model: <b>755593BN</b>                  Finish: <b>Brushed Nickel</b>                  Size: <b>6 ¼" H x 4 ¾" W x 25" L</b>                  Bulbs: <b>3 x LED bulb</b></p>	
<p><b>Keyless Fixture (K)</b></p> <p>Location: <b>Mechanical Room Garage</b></p>	<p>Contractor: <b>Wayco Electric</b>                  Bulbs: <b>1 x LED Bulb</b></p>	



<p><b>Exterior Wall Light</b></p> <p>Location:</p> <p>Main Front Deck Main Rear Deck Lower Rear Patio Front Door Exterior Garage Door</p>	<p>Contractor: <b>Starlight</b>                  Manufacturer: <b>DVI Lighting</b>                  Style: <b>Exterior Wall Light</b>                  Model: <b>DVP115014</b>                  Finish: <b>Black</b>                  Size: <b>6.5" H x 6" W x 3.5" L</b>                  Bulbs: <b>1 x LED bulbs</b></p>	
<p><b>Electrical Plugs &amp; Switches</b></p> <p>Location:</p> <p>Throughout Unit (Excludes kitchen backsplash)</p>	<p>Contractor: <b>WAYCO</b>                  Style: <b>Decora Switches</b>                  Colour: <b>White</b></p> <p><b>*Dimmer switch on dining room chandelier</b></p>	
<p><b>Electrical Plugs &amp; Switches</b></p> <p>Location:</p> <p>Kitchen backsplash</p>	<p>Contractor: <b>WAYCO</b>                  Style: <b>Decora Switches</b>                  Colour: <b>Stainless steel switch plate with black insert</b></p>	
<p><b>Electrical Cable Outlets</b></p> <p>Location:</p> <p>Master Bedroom Living Room</p>	<p>Contractor: <b>WAYCO</b>                  Colour: <b>White</b>  <b>Height of Master Bedroom cable and power outlet off floor 60"</b>  <b>Height of Living room cable and power outlet off floor 48"</b></p>	
<p><b>Electrical Phone Outlets</b></p> <p>Location:</p> <p>Master Bedroom Living Room</p>	<p>Contractor: <b>WAYCO</b>                  Colour: <b>White</b></p> <p><b>Phone outlet and power outlet located at standard height off floor</b></p>	
<p><b>Electrical Garburator Rough in</b></p> <p>Location:</p> <p>Kitchen sink</p>	<p>Supplier: <b>Master Mechanical</b>                  System: <b>Rough in system only</b></p>	





<p><b>Plumbing</b> <b>Gas Line</b></p> <p>Location: <b>Hot Water Tank(s)</b> <b>Main Rear Deck</b></p>	<p>System: <b>Gas line rough in</b></p>	
<p><b>Plumbing</b> <b>Kitchen Sink</b></p>	<p>Contractor: <b>Master Mechanical</b>                  Manufacturer: <b>Kindred</b>                  Model: <b>Undermount QCU1827/R bowl &amp; half</b>                  Colour: <b>Stainless Steel - Satin</b>                  Size: <b>O.D. 27 3/8" wide, 18 9/16 front to back, 8" deep</b>                  Note: <b>This sink requires a 33" wide cabinet</b></p>	
<p><b>Plumbing</b> <b>Kitchen Faucet</b></p>	<p>Contractor: <b>Master Mechanical</b>                  Manufacturer: <b>Delta</b>                  Model: <b>Leland 9178-DST</b>                  Finish: <b>Chrome</b>                  Installation type: <b>Single handle</b></p>	
<p><b>Plumbing</b> <b>Vanity Sink</b></p> <p>Location: <b>Ensuite#1 (2)</b> <b>Main Bath</b></p>	<p>Manufacturer: <b>Vortens</b>                  Model: <b>Holiday #3529 Undermount Sink</b>                  Material: <b>Vitreous China</b>                  Colour: <b>White</b>                  Size: <b>19" x 16" Oval</b></p>	
<p><b>Plumbing</b> <b>Pedestal Sink</b></p> <p>Location: <b>Half Bath</b></p>	<p>Contractor: <b>Master Mechanical</b>                  Manufacturer: <b>American Standard</b>                  Model: <b>Boulevard Pedestal Sink</b>                  Material: <b>Vitreous China</b>                  Colour: <b>White</b>                  Size: <b>24" W x 19" L x 35 1/2" H</b></p>	



<p><b>Plumbing Vanity Faucet</b></p> <p>Location:</p> <p>Ensuite #1 (2) Main Bath Half Bath</p>	<p>Contractor: <b>Master Mechanical</b>                  Manufacturer: <b>Delta</b>                  Model: <b>Lahara 3538-MPU-DST</b>                  Finish: <b>Chrome</b>                  Installation type: <b>Widespread</b></p>	
<p><b>Plumbing Toilets</b></p> <p>Location:</p> <p>Ensuite #1 Main Bath Half Bath</p>	<p>Contractor: <b>Master Mechanical</b>                  Manufacturer: <b>Kohler</b>                  Style: <b>High Efficiency flush</b>                  Colour: <b>White</b>                  Series: <b>Highline Collection</b>                  Model: <b>K-3658</b>                  Size: <b>29-1/2" L x 19-5/8" W x 30-3/8" H</b></p>	
<p><b>Plumbing Walk in Shower</b></p> <p>Location:</p> <p>Ensuite #1</p>	<p>Contractor: <b>Master Mechanical</b>                  Manufacturer: <b>MAAX</b>                  Series: <b>Rectangular Base 4834</b>                  Colour : <b>White</b>                  Material: <b>Acrylic</b>                  Model: <b>102002</b>                  Size: <b>47.75" W x 34" L x 3" H</b>                  Details: <b>Single threshold Center drain</b></p>	
<p><b>Plumbing Walk in Shower Faucet</b></p> <p>Ensuite #1</p>	<p>Contractor: <b>Master Mechanical</b>                  Manufacturer: <b>Delta</b>                  Style: <b>Wall Mount</b>                  Finish: <b>Chrome</b>                  Series: <b>Lahara Collection</b>                  Model: <b>Monitor 14 Series Shower Trim T14238</b></p>	
<p><b>Plumbing Frameless Glass &amp; Door Hardware (walk in shower only)</b></p> <p>Location:</p> <p>Ensuite #1</p>	<p>Supplier: <b>Akita Glass</b>                  Type: <b>10mil tempered glass</b>                  Manufacturer: <b>C R LAURENCE</b>                  Series: <b>CRL Vienna Hinge &amp; Handle Set</b>                  Finish: <b>Chrome</b>                  Model: <b>V1ES3CH</b></p>	

<p><b>Plumbing Tub Shower Unit</b></p> <p>Location:  Main Bath</p>	<p>Contractor: <b>Master Mechanical</b>                  Manufacturer: <b>MAAX</b>                  Series: <b>TSEA Plus</b>                  Colour : <b>White</b>                  Material: <b>Fiberglass</b>                  Model: <b>105674</b>                  Size: <b>60" W x 32" L x 78" H</b></p>	
<p><b>Plumbing Tub Shower Faucet Trim</b></p> <p>Location:  Main Bath</p>	<p>Contractor: <b>Master Mechanical</b>                  Manufacturer: <b>Delta</b>                  Style: <b>Wall Mount</b>                  Finish: <b>Chrome</b>                  Series: <b>Lahara Collection</b>  <b>Monitor 14 Series Tub Shower Trim</b>                  Model: <b>T14438</b></p>	
<p><b>Plumbing Bathroom Hardware</b></p> <p>Location:  Ensuite #1 Main Bath Powder Room</p>	<p>Contractor: <b>Master Mechanical</b>                  Manufacturer: <b>Taymor</b>                  Finish: <b>Polished Chrome</b>                  Series: <b>Odyssey Collection</b>                  Model: <b>Towel Bar 30"-02-D2430</b>  <b>Toilet roll holder -02-D2448</b>  <b>Towel ring -02-D2404</b>  <b>Robe Hook -02-D2402</b></p>	



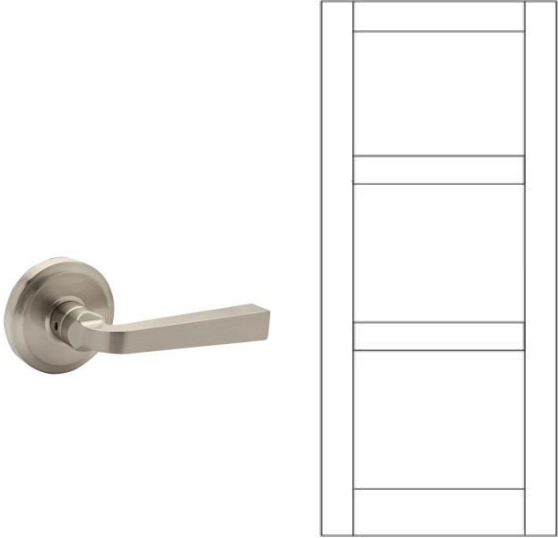

<p><b>Closet Shelving</b></p> <p>Location: Front Entry Bedroom #2 Bedroom #3 Master Bedroom Kitchen Pantry (4 shelves)</p>	<p>Supplier: <b>Enlightened Organizing</b> Shelf Style: <b>Wire Satin Nickel Finish</b> Rod Style: <b>Rod satin nickel</b></p> <p><b>**Please see floor plans for details on shelving areas Rod &amp; shelf unless otherwise noted</b></p> 
<p><b>Paint</b></p> <p>Location: Interior Ceilings Garage Walls &amp; ceiling</p>	<p>Contractor: <b>High Country Painting</b> Manufacturer: <b>Coverdale Artsian</b> Application: <b>1 primer &amp; 2 finish coats</b> Finish: <b>Flat</b> Colour: <b>CA007 Candle</b></p> 
<p><b>Exterior Front Entry Door &amp; Entry Set</b></p>	<p>Contractor: <b>Ginow Building materials</b> Type: <b>Stainable fiberglass door</b> Style: <b>To be determined</b> Colour: <b>Natural</b></p> <p><b>Exterior Door Hardware</b> Contractor: <b>Timbertown</b> Manufacturer: <b>Taymor</b> Model: <b>Ashford Handle Set w/ deadbolt</b> Colour: <b>Black</b></p> 

<p><b>Exterior Doors &amp; Hardware</b></p> <p>Location: <b>Rear Entry Level Patio</b> <b>Rear Main Floor Deck</b></p>	<p>Contractor: <b>Plygem</b> Style: <b>Single pane clear glass with Interior mini blinds</b> Material: <b>Fiberglass</b> Interior Colour: <b>Painted to match interior wall colour</b></p> <p>Contractor: <b>Timbertown</b> Manufacturer: <b>Taymor</b> Series: <b>Wells Lever handle Set</b> Colour: <b>Satin Nickel</b> <b>Passage 30-D006534SN</b> <b>With Dead bolt</b></p>  
<p><b>Garage Entry Door &amp; Hardware</b></p> <p>Location: <b>Main garage man door</b></p>	<p>Contractor: <b>Plygem</b> Style: <b>6 panel raised</b> Material: <b>Fiberglass</b> Interior Colour: <b>Painted to match interior wall colour</b></p> <p>Contractor: <b>Timbertown</b> Manufacturer: <b>Taymor</b> Series: <b>Wells Lever handle Set</b> Colour: <b>Satin Nickel</b> <b>Passage 30-D006534SN</b> <b>With Dead bolt</b></p>  

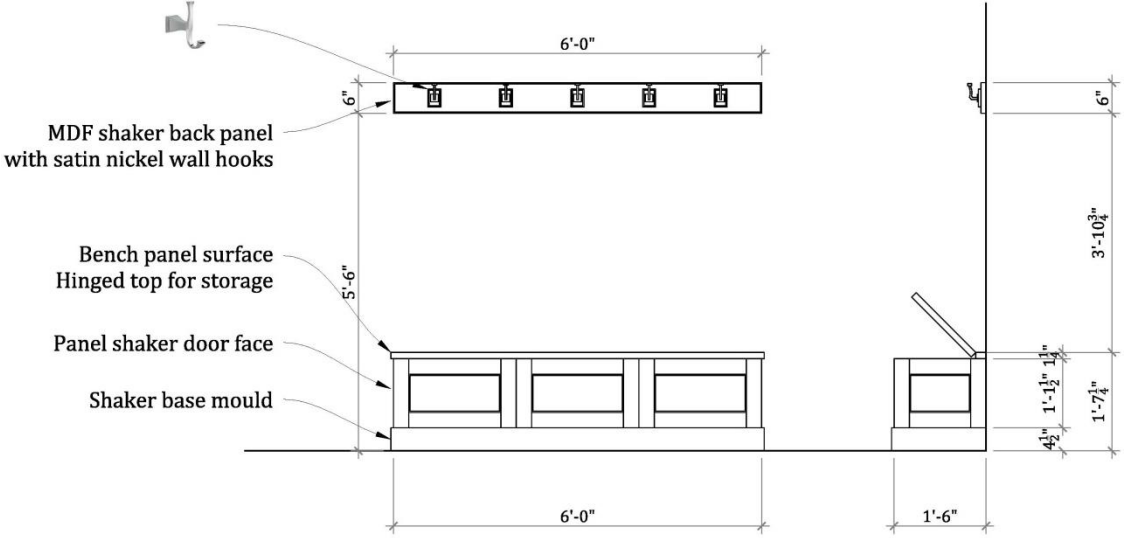
<p><b>Interior Doors &amp; Hardware</b></p> <p>Location:</p> <p><b>Throughout unit</b></p>	<p>Contractor: <b>Timbertown</b>                  Style: <b>3 panel shaker</b>                  Material: <b>MDF</b>                  Finish: <b>Satin- Painted</b>                  Colour: <b>Cloverdale Artisan CA007 Candle</b></p> <p>Contractor: <b>Timbertown</b>                  Manufacturer: <b>Taymor</b>                  Series: <b>Wells Lever handle Set</b>                  Colour: <b>Satin Nickel</b>  <b>Passage 30-D006534SN</b>  <b>With Dead bolt</b></p> 
<p><b>Interior Door Hinges &amp; Stops</b></p> <p>Location:</p> <p><b>Throughout Unit</b></p>	<p>Contractor: <b>Timbertown</b>                  Style: <b>Spring stop or hinge stop</b>  <b>As required by layout</b></p> <p>Series: <b>Satin Nickel</b></p>
<p><b>Stairwell Hand Rail</b></p> <p>Location:</p> <p><b>Lower level to main level</b>  <b>Main level to upper level</b></p>	<p>Contractor: <b>Timbertown</b>                  Material: <b>MDF</b>                  Finish: <b>Painted Benjamin Moore – CC50 White Down – Semi gloss</b>                  Model: <b>To be determined</b>                  Size: <b>To be determined</b>                  Hardware: <b>To be determined</b></p>
<p><b>Interior Window Trim</b></p> <p>Location:</p> <p><b>Throughout Unit</b></p>	<p>Contractor: <b>Timbertown</b>                  Material: <b>MDF</b>                  Finish: <b>Painted Cloverdale Artisan– CA007 Candle – Satin finish</b>                  Model: <b>MDF423</b>                  Size: <b>5/8" x 3"</b>                  Style: <b>Mitered corners top and bottom</b></p> 

<p><b>Interior Base Mould</b></p> <p>Location: Throughout Unit</p>	<p>Contractor: <b>Timbertown</b>                  Material: <b>MDF</b>                  Finish: <b>Painted Cloverdale Artsian-- CA007 Candle – Satin finish</b>                  Model: <b>MDF425A</b>                  Size: <b>1/2" x 6"</b>                  Style: <b>Mitered corners top</b></p> 
<p><b>Storage Bench</b></p> <p>Location: Front Entry</p>	<p>Contractor: <b>Tri Star</b>                  Material: <b>MDF</b>                  Finish: <b>Painted Benjamin Moore – CC50 White Down – Semi gloss</b>                  Hooks: <b>Delta Dryden Hook Chrome 75135</b></p>  <p>MDF shaker back panel with satin nickel wall hooks</p> <p>Bench panel surface Hinged top for storage</p> <p>Panel shaker door face</p> <p>Shaker base mould</p> <p>Dimensions: 6'-0" (width), 6" (height of back panel), 5'-6" (height of bench), 6'-0" (width of bench), 1'-6" (width of shaker base), 3'-10 3/4" (height of shaker base), 6 1/2" (height of shaker door), 1'-11 1/2" (width of shaker door), 1'-7/4" (width of shaker door).</p>

<p><b>Upgrade Option</b></p> <p><b>Laundry</b></p>	<p><b>Washer</b>                  Contractor: <b>Trail Appliances</b>                  Manufacturer: <b>Whirlpool</b>                  Colour: <b>White</b>                  Model: <b>WFW72HEDW</b>                  Size : <b>27" W x 39.75" H x 33.125" D</b>                  Style: <b>Side by side</b>                  Details: <b>4.8 cu. ft. I.E.C.* HE Front Load</b>  <b>8 wash cycles</b>  <b>Energy Star Rated</b></p> <p><b>Price: \$900.00 ( includes installation)</b></p> <p><b>Dryer (Electric)</b>                  Contractor: <b>Trail Appliances</b>                  Manufacturer: <b>Whirlpool</b>                  Colour: <b>White</b>                  Model: <b>YWED72HEDW</b>                  Size : <b>27" W x 38.75" H x 31" D</b>                  Style: <b>Side by side</b>                  Details: <b>7.4 cu. ft. I.E.C.* HE Front Load</b>  <b>6 cycles</b></p> <p><b>Price: \$800.00 ( includes installation)</b></p>	 
<p><b>Upgrade Option</b></p> <p><b>French Door Fridge</b></p>	<p>Contractor: <b>Trail Appliances</b>                  Manufacturer: <b>Whirlpool</b>                  Model: <b>WRF560SFYM</b>                  Style: <b>19.6 Cubic foot</b>                  Colour: <b>Stainless</b>                  Size: <b>29 1/2" W x 68 1/4" H x 34 5/8" D</b></p> <p><b>Price: \$400.00</b></p>	
<p><b>Upgrade Option</b></p> <p><b>Garburator</b></p>	<p>Manufacturer: <b>In Sink-Erator, Pro Series</b>                  Model: <b>PRO #333 - 3/4 Horsepower</b>                  Location: <b>Kitchen sink - installed in small bowl of sink</b>  <b>On air counter switch</b></p> <p><b>Price: \$900.00</b></p>	

<p><b>Vanity Mirrors</b></p> <p>Location:</p> <p><b>Ensuite #1</b></p> <p><b>Main Bath</b></p> <p><b>Half Bath</b></p>	<p>Contractor: <b>Legacy Kitchens</b> Manufacturer: <b>Kitchen Craft</b> Style: <b>2" Frame</b> Profile: <b>Square edge</b> Wood Type: <b>Match vanity cabinets</b> Stain: <b>Match vanity cabinets</b> Details: <b>Mirror frame height = 36"</b> <b>Two Mirrors Ensuite #1</b> <b>One Mirror Ensuite #2</b> <b>One Mirror Half Bath</b> <b>Mirrors not to extend over toilets</b></p> <p><b>Ensuite #1</b> <b>Price: \$600.00</b></p> <p><b>Main Bath</b> <b>Price: \$300.00</b></p> <p><b>Half Bath</b> <b>Price: \$300.00</b></p>	
<p><b>LED Strip Lighting</b></p>	<p>Contractor: <b>Wayco Electric</b> Bulbs: <b>LED Strips</b> Locations: <b>Kitchen Upper Cabinets</b></p> <p><b>Price: \$700.00</b></p>	

**Upgrade  
Option**

**Fireplace**

**Fireplace Insert**

Manufacturer: **Napoleon**  
Model: **BDG33**  
Vent Style: **Direct Vent**  
Size: **34.25" W x 29 3/8" H**  
Details: **With black bevelled trim kit**  
**22,000 BTU's**



**MDF Mantel Painted**

Supplier: **Tri Star**  
Style: **MDF Mantel**  
Finish: **OC-131 White Down – Semi gloss**  
Size: **6" H x 10" D**

**Fireplace Tile Veneer**

Contractor: **RGO**  
Style: **6" x 24" Tile**





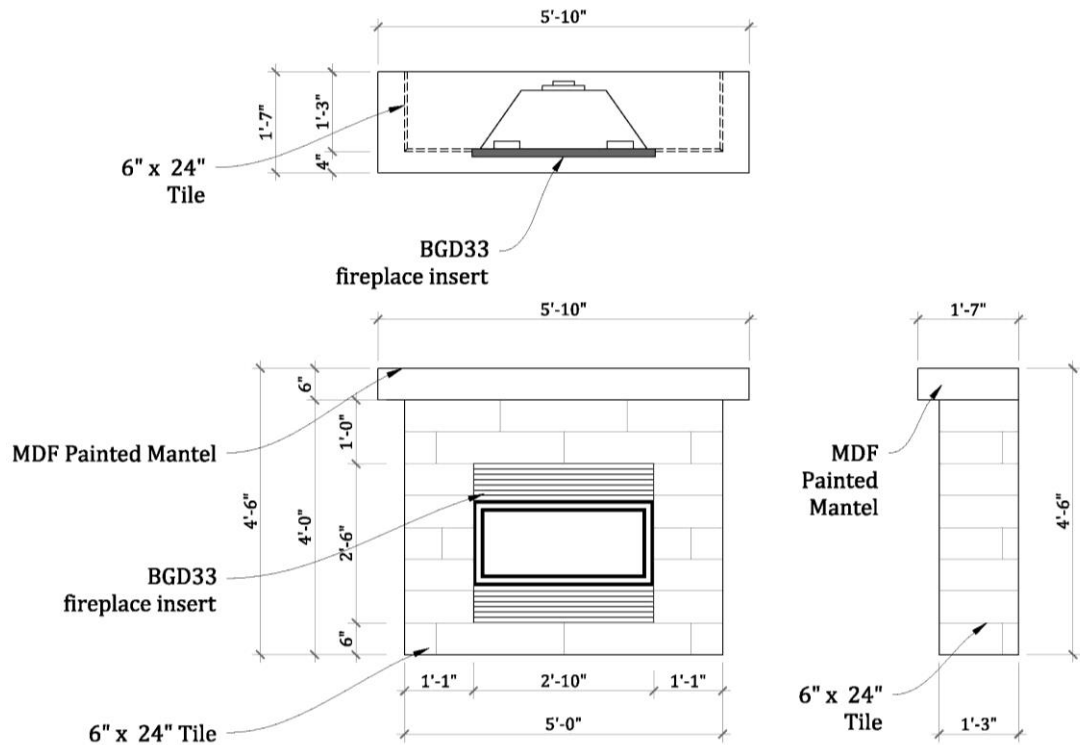

**NO HEARTH**

**Price: \$6,500**



<p><b>Upgrade Option</b></p> <p><b>Developed basement option 1</b></p>	<p><b>Flex Space, Bedroom &amp; bathroom developed</b></p> <p>Mouldings: <b>MDF painted baseboards &amp; window casing</b>  Walls: <b>Taped and finish painted drywall</b>  Flooring: <b>Standard Carpet in flex space and bedroom selection as per package</b>  <b>Standard tile in bathroom selection as per package</b></p> <p>Interior doors: <b>MDF 3 panel shaker painted CC-130 Cloud White</b>  Door hardware: <b>Taymor Wells Level stain nickel</b>  Bedroom Closet: <b>MDF 3 panel bi fold closet doors</b>  <b>Wire nickel rod &amp; shelf</b></p> <p>Bathroom: <b>Moulded tub/ shower insert Model: MAAX 105674</b>  <b>Undermount Sink Model: Vortens Holiday 3529</b>  <b>Vanity Faucet Model: Delta Lahara 3538-MPU-DST</b>  <b>Toilet: KOHLER Highline Collection</b>  <b>Tub Shower Faucet: Delta Lahara T14438</b>  <b>Bathroom Hardware: Taymor Odyssey Polished Chrome collection</b>  <b>Vanity Light Fixture: Seagull Lighting Oslo Collection 41162BLE-05</b>  <b>Standard vanity cabinet, quartz counter selection as per package</b>  <b>6" High tiled vanity backsplash selection as per package</b>  <b>1 row perimeter tile 4"- 6" wide around tub shower unit</b></p> <p><b>Price: \$32,000</b></p>
<p><b>Upgrade Option</b></p> <p><b>Developed basement option 2</b></p>	<p><b>Flex Space &amp; bathroom developed</b></p> <p>Mouldings: <b>MDF painted baseboards &amp; window casing</b>  Walls: <b>Taped and finish painted drywall</b>  Flooring: <b>Standard Carpet in flex space selection as per package</b>  <b>Standard tile in bathroom selection as per package</b></p> <p>Interior door: <b>MDF 3 panel shaker painted CC-130 Cloud White</b>  Door hardware: <b>Taymor Wells Level stain nickel</b>  Bathroom: <b>Moulded tub/ shower insert Model: MAAX 105674</b>  <b>Undermount Sink Model: Vortens Holiday 3529</b>  <b>Vanity Faucet Model: Delta Lahara 3538-MPU-DST</b>  <b>Toilet: KOHLER Highline Collection</b>  <b>Tub Shower Faucet: Delta Lahara T14438</b>  <b>Bathroom Hardware: Taymor Odyssey Polished Chrome collection</b>  <b>Vanity Light Fixture: Seagull Lighting Oslo Collection 41162BLE-05</b>  <b>Standard vanity cabinet, quartz counter selection as per package</b>  <b>6" High tiled vanity backsplash selection as per package</b>  <b>1 row perimeter tile 4"- 6" wide around tub shower unit</b></p> <p><b>Price: \$30,000</b></p>



<p><b>Upgrade Option</b></p> <p><b>Closet Shelving</b></p>	<p>Contractor: <b>Enlightened Organizing</b>                  Manufacturer: <b>John Louis Home</b>                  Type: <b>Rod &amp; Shelf</b>                  Colour : <b>Honey Maple</b>                  Locations: <b>All Bedrooms</b>  <b>Pantry ( 4 levels shelf)</b>  <b>Entry level closet</b></p>   <p><b>Price: \$2400</b></p>
<p><b>Upgrade Option</b></p> <p><b>Hardwood Flooring</b></p> <p>Locations:  <b>Kitchen</b>  <b>Living Room</b>  <b>Dining Room</b>  <b>Half Bath</b>  <b>Pantry</b></p> <p><b>Wood stair nosings</b>  <b>Tile treads &amp; Risers</b></p>	<p>Contractor: <b>RGO</b>                  Manufacturer: <b>Dansk</b>                  Collection: <b>Whistler</b>                  Colour : <b>Package #1 – Coastal Sand Oak</b>  <b>Package #2 – Rustic Taupe Oak</b>  <b>Package #3 – Satchel Brown Oak</b></p>   
<p><b>Upgrade Option</b></p> <p><b>Hardwood Flooring</b></p> <p>Locations:  <b>Master bedroom &amp; closet</b></p>	<p>Contractor: <b>RGO</b>                  Manufacturer: <b>Dansk</b>                  Collection: <b>Whistler</b>                  Colour : <b>Package #1 – Coastal Sand Oak</b>  <b>Package #2 – Rustic Taupe Oak</b>  <b>Package #3 – Satchel Brown Oak</b></p>   

Suite #

<p><b>Upgrade Option</b></p> <p><b>Vinyl Flooring</b></p> <p>Locations: <b>Master bedroom &amp; closet</b></p>	<p>Contractor: <b>RGO</b> Manufacturer: <b>Shaw</b> Collection: <b>Uncommon Ground 6</b> Colour : <b>Package #1 – 02140 Provence</b> <b>Package #2 – 02500 French Grey</b> <b>Package #3 – 02720 Adirondack</b></p> 
<p><b>Upgrade Option</b></p> <p><b>Vinyl Flooring</b></p> <p>Locations: <b>Stairs main to upper level</b></p> <p><b>Master bedroom &amp; closet</b></p> <p><b>Upper level bedrooms</b></p> <p><b>Upper level hallway</b></p>	<p>Contractor: <b>RGO</b> Manufacturer: <b>Shaw</b> Collection: <b>Uncommon Ground 6</b> Colour : <b>Package #1 – 02140 Provence</b> <b>Package #2 – 02500 French Grey</b> <b>Package #3 – 02720 Adirondack</b></p> 