

JENNY

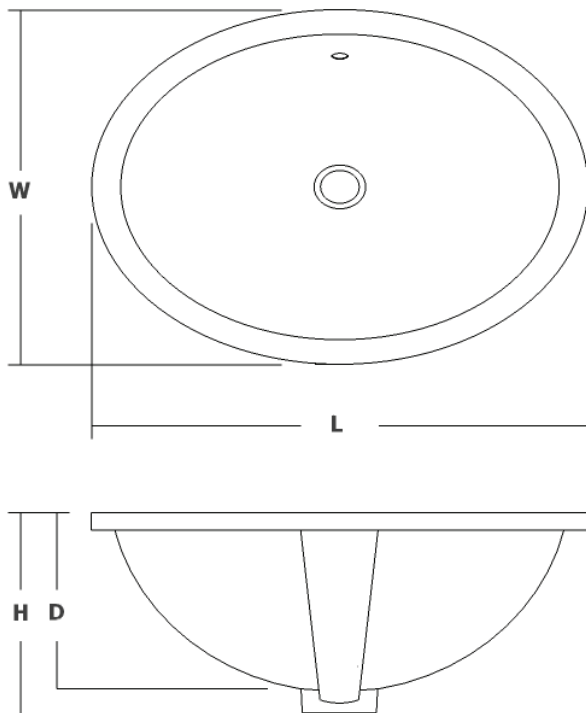

SPECIFICATIONS:

JENNY SERIES

Undermount Application: With Fully Glazed Rim Surface

Jenny: OD: 19.25"L x 13.75"W x 7.75"H x 5.75"D

ID: 17"L x 12"W

Drain: 1.5"

ASME A112.19.1/CSA B45.2 Compliant

