



Drive Thru Controller

Tech Guide

WASHLINK SYSTEMS DRIVE THRU CONTROLLER TECH GUIDE

This document provides comprehensive operational procedures for the Washlink Systems Drive Thru Controller (DTC).

In this manual, we will discuss the Installation, Setup and Operation of the DTC.

If further assistance is needed, please contact the Distributor from which the product was purchased.

When calling for assistance, you must have the following information available:

UL Number: _____

Distributor Name: _____

COPYRIGHT

2012 Washlink Systems. All rights reserved.

THIS DOCUMENT IS THE EXCLUSIVE PROPERTY OF WASHLINK SYSTEMS AND IS PREPARED ONLY FOR USE BY THE COMPANY PURCHASING THE EQUIPMENT. EDITING, COPYING, DISTRIBUTING, AND/OR SELLING THIS DOCUMENT IS STRICTLY PROHIBITED WITHOUT PRIOR WRITTEN CONSENT FROM WASHLINK SYSTEMS. WASHLINK SYSTEMS RESERVES THE RIGHT TO EDIT THIS DOCUMENT IN ANY MANNER DEEMED NECESSARY, AT ANY TIME, AND WITHOUT PRIOR NOTICE.

Operation Basics

Functions get enabled to work by the default cycle or if added with input 7 or 8

If function will turn on after the conditions have been met;
Function is enabled to work for the cycle
Corresponding input goes high
Input has been high for more than the on debounce
Output on delay time has expired

The function will turn off after the following conditions have been met;
Corresponding input goes low
Output on delay time has expired
Output off delay time has expired



Note: All inputs have debounce on and debounce off controls







Note: All outputs have on delay and off delay timer controls

Installation

The Washlink Systems DTC should be mounted securely to a stable and permanent wall. Choose a location in the equipment room that is easily accessible and provides protection from the elements.



Power Requirements

The Washlink Systems DTC requires 120vac (15A max) branch circuit protection for PLC. This power circuit is provided by the customer. This circuit should be connected to **Fuse 101 PLC**.

	Warning: All electrical work should be performed by a qualified and licensed electrician. All electrical work should meet or exceed National and Local codes and ordinances.
	Warning: Risk of electrical shock. More than one disconnect may be required to be de-energized before servicing equipment.
	Warning: To reduce the risk of fire, connect only to a 120vac circuit provided with 15a maximum branch circuit protection in accordance with the NEC, ANSI/NFPA 70 and local code authorities.
	Warning: Bonding between conduit connection is not automatic and must be provided as part of the installation.

Inputs

The DTC Input power is supplied by the PLC. All inputs are normally open.

	Warning: All Inputs are 0vdc. Any other voltage will damage the Controller and void warranty.
	Note: An interface relay may be needed to give the correct input contact type

Outputs

Each of the DTC outputs have a double pole double throw isolation relay. Each output relay has a test button as well as a manual override switch. The green indicator light on each relay will be illuminated when coil power is present. The devices to be wired to each relay are the responsibility of the customer.

INPUT	PLC INPUT TERMINAL	CONTACT TYPE	DESCRIPTION
1	i0.0	N.O.	Function Start Signal 1
2	i0.1	N.O.	Function Start Signal 2
3	i0.2	N.O.	Function Start Signal 3
4	i0.3	N.O.	Function Start Signal 4
5	i0.4	N.O.	Function Start Signal 5
6	i0.5	N.O.	Function Start Signal 6
7	i0.6	N.O.	Function Adder to Default Cycle, input 7
8	i0.7	N.O.	Function Adder to Default Cycle, input 8

FUNCTION	RELAY	PLC OUTPUT TERMINAL	DESCRIPTION
1	1	q0.0	Function 1
2	2	q0.1	Function 2
3	3	q0.2	Function 3
4	4	q0.3	Function 4
5	5	qi0.4	Function 5
6	6	q0.5	Function 6

User Interface

The next pages show how to use the HMI user interface, it will show the following;

- Adjust the Function Timers
- Adjust the Input 7 & 8 Debounce
- Adjust the Cycle Settings
- View the Real Time Input Status
- View the Input and Output Counters

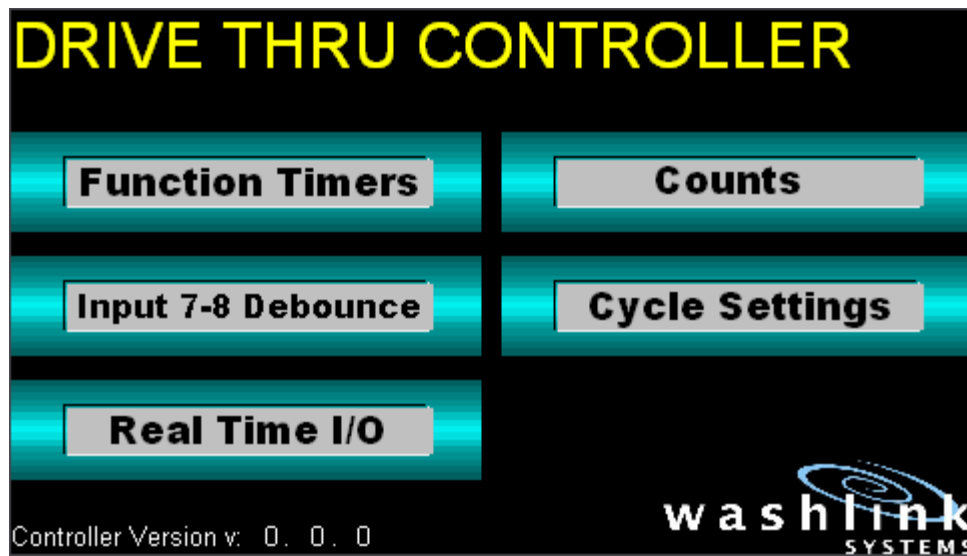

Function Timers

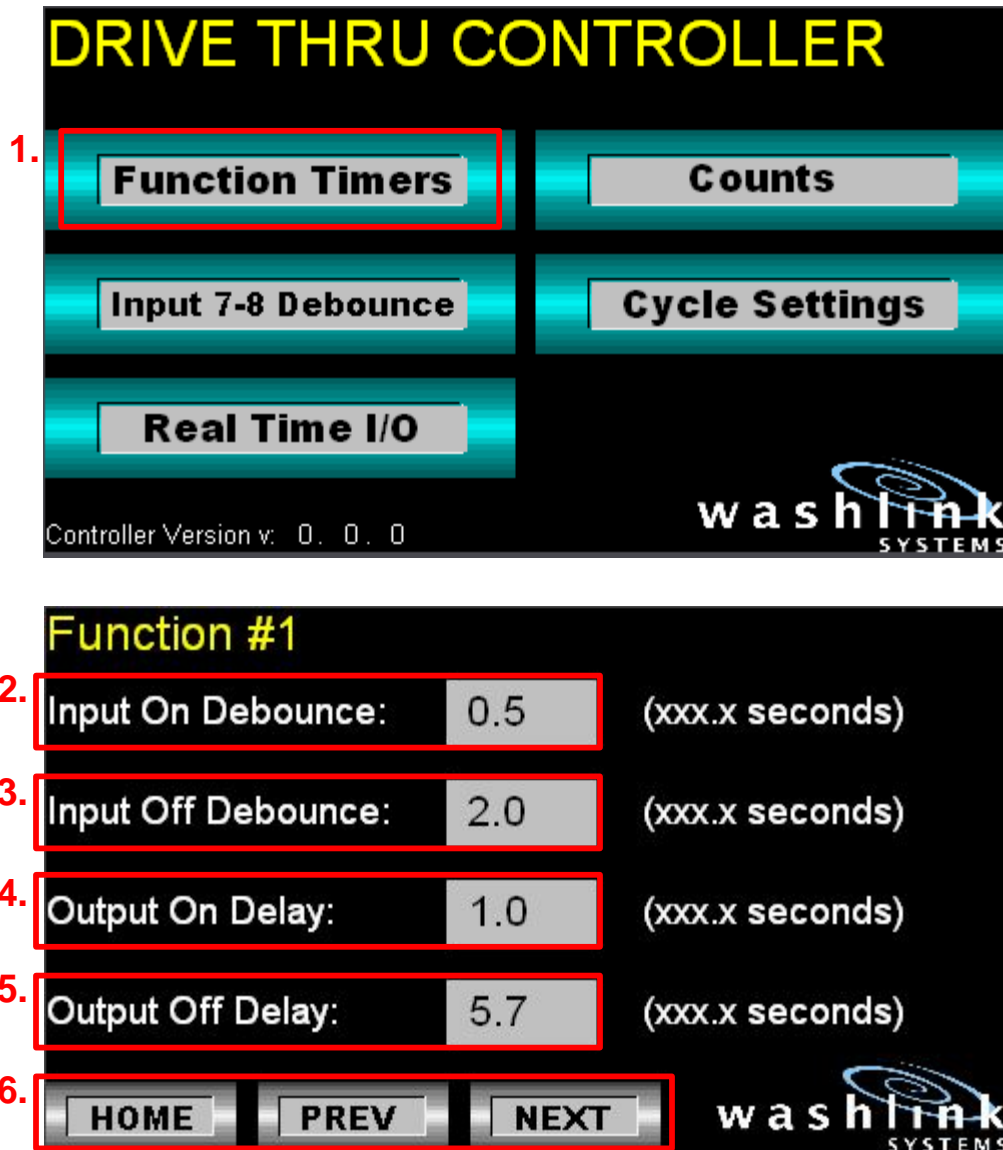

1. From the Home Screen, tap the Function Timers box.
2. Input On Debounce, this delays by the amount of time in seconds, until the controller reacts to the input.
3. Input Off Debounce, this extends the amount of time in seconds the controller thinks the input is activated.
4. Output On Delay, this delays by the amount of time in seconds, until the controller turns on this output.
5. Output Off Delay, this extends the amount of time in seconds the controller keeps the output on for.
6. Press PREV or NEXT to go to other functions to adjust or press HOME when finished.

Input 7-8 Debounce

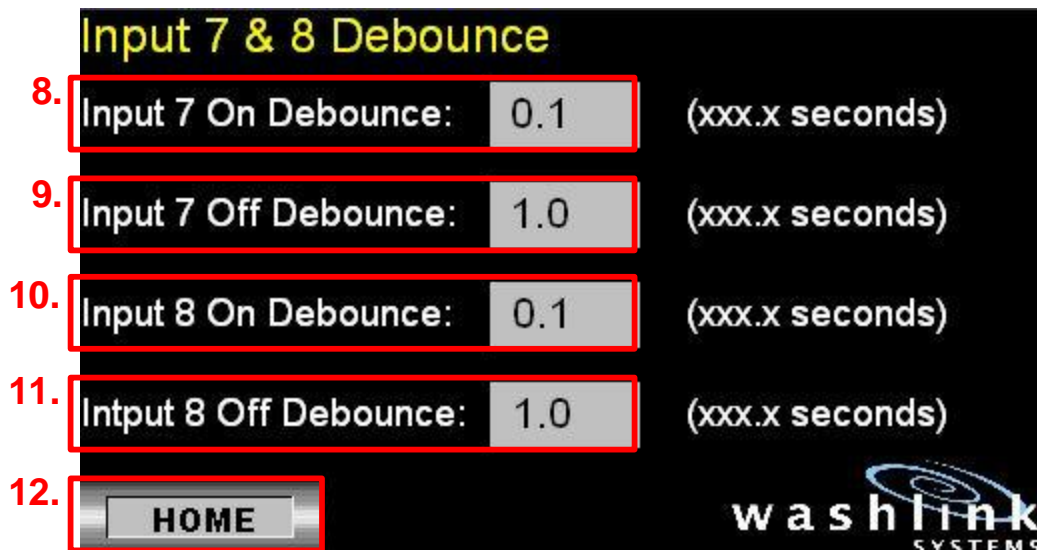
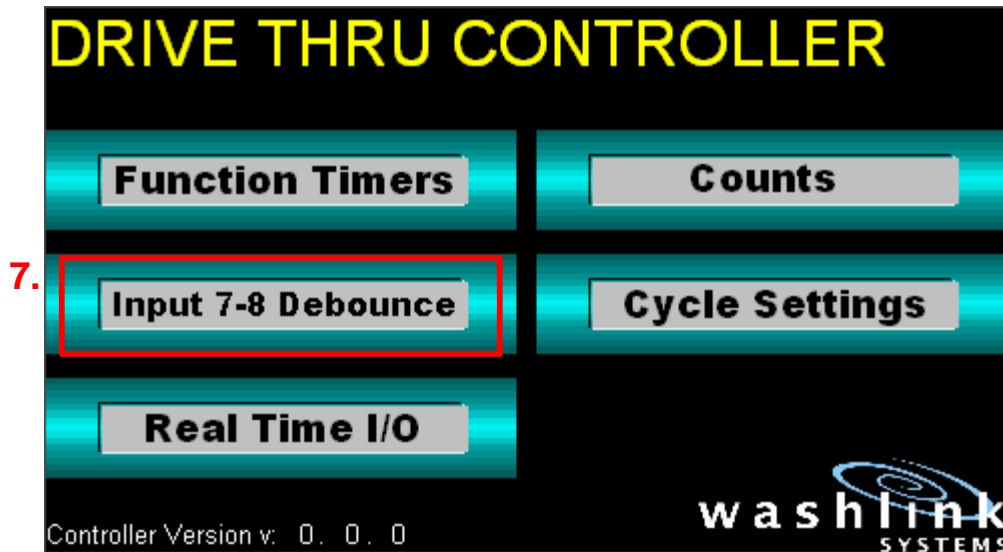

7. From the Home Screen, tap the Input 7-8 Debounce box.
8. Input 7 On Debounce, this delays by the amount of time in seconds, until the controller reacts to the input.
9. Input 7 Off Debounce, this extends the amount of time in seconds the controller thinks the input is activated.
10. Input 8 On Debounce, this delays by the amount of time in seconds, until the controller reacts to the input.
11. Input 8 Off Debounce, this extends the amount of time in seconds the controller thinks the input is activated.
12. Press HOME when finished.

Cycle Settings

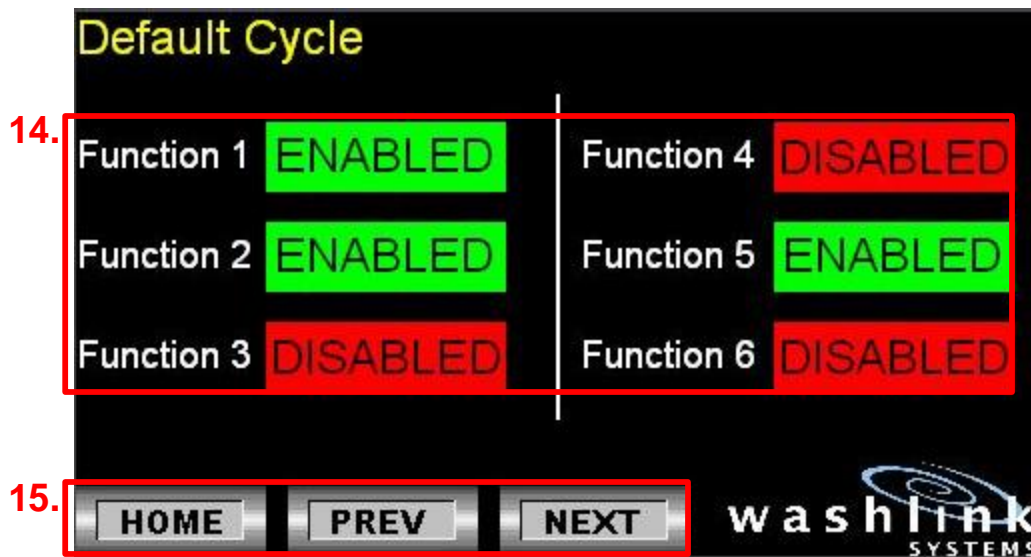
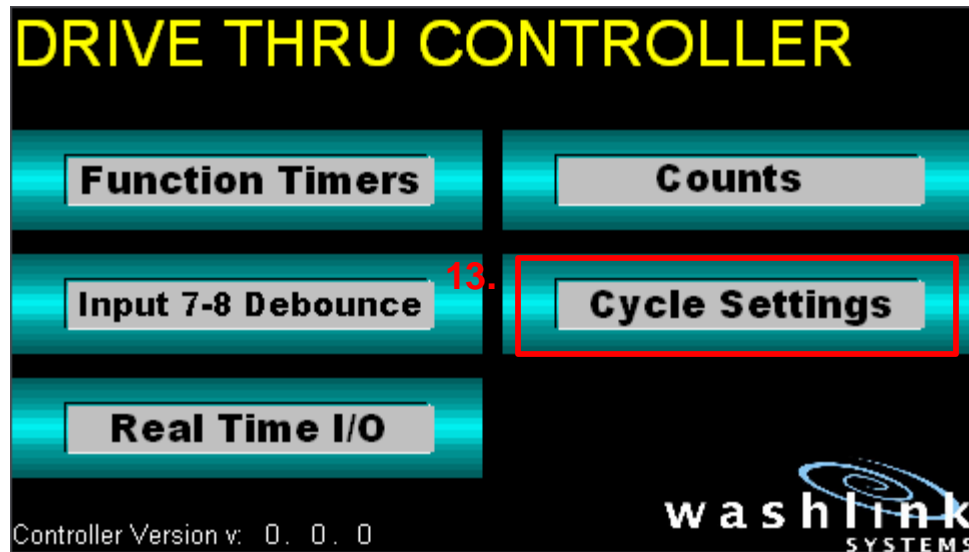

13. From the Home Screen, tap the Cycle Settings box.
14. Enable or Disable functions to turn on with the Default Cycle.
15. Press PREV or NEXT to go to other Cycles to adjust or press HOME when finished..

NOTE: The Default Cycle will allow the enabled functions to work after input 1 has been activated.

Input 7 & Input 8 Adder

Input 7 - Adder
These functions will be added to the Default Cycle

16. Function 1 DON'T ADD Function 4 DON'T ADD
Function 2 DON'T ADD Function 5 DON'T ADD
Function 3 DON'T ADD Function 6 DON'T ADD

17. HOME PREV NEXT washlink
SYSTEMS

Input 8 - Adder
These functions will be added to the Default Cycle

16. Function 1 DON'T ADD Function 4 DON'T ADD
Function 2 DON'T ADD Function 5 DON'T ADD
Function 3 DON'T ADD Function 6 DON'T ADD

17. HOME PREV NEXT washlink
SYSTEMS

16. Add functions to turn on with the Default Cycle.
17. Press to go to other Cycles to adjust or press HOME when finished.

 **NOTE:** These functions will be added to the Default Cycle as long as the input is activated prior to input 1 being activated.

Real Time Input & Output Status

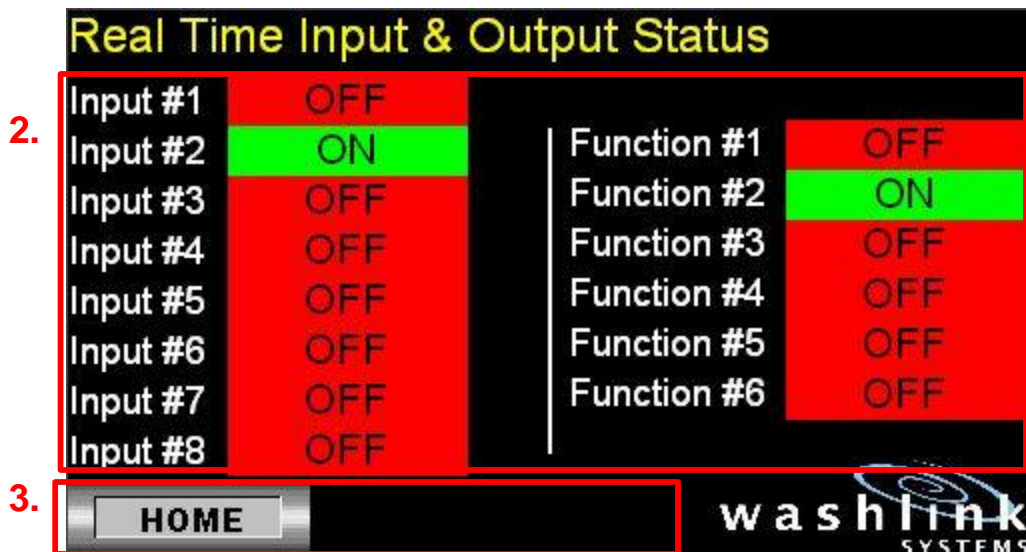
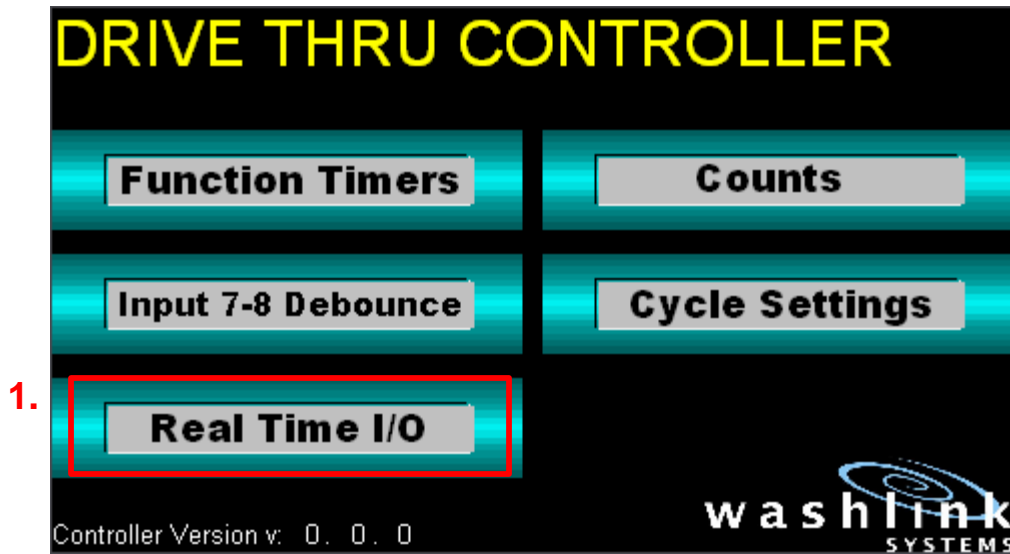

1. From the Home Screen, tap the Real Time I/O box.
2. This is the actual state of the inputs and outputs on the Controller
3. Press HOME when finished.

 **NOTE:** The input light may be on but the function not activated yet because of the input on and off debounce

Real Time Input & Output Status

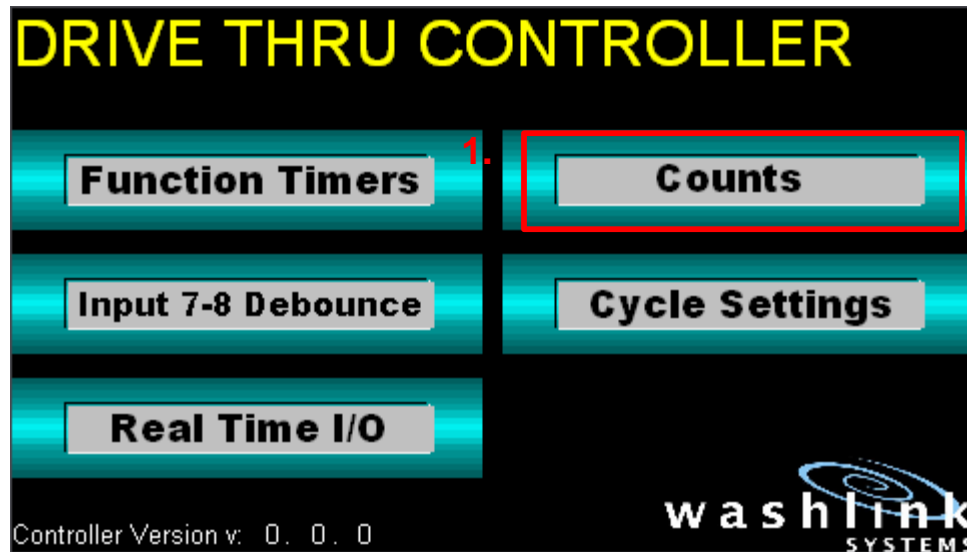

Lifetime Function Counts

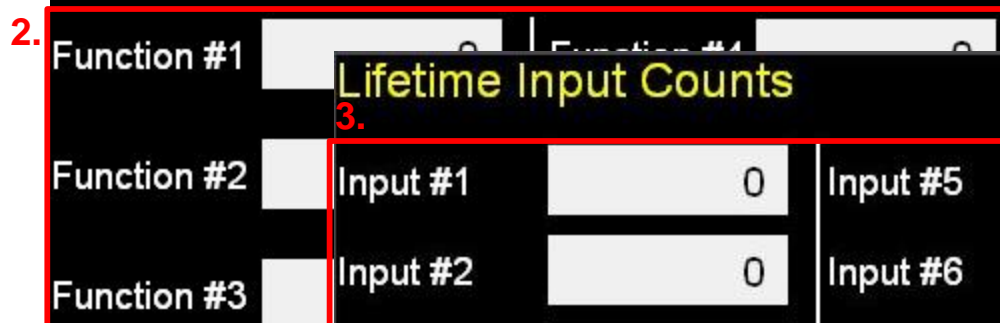

Lifetime Input Counts

Input #1	0	Input #5	0
Input #2	0	Input #6	0
Input #3	0	Input #7	0
Input #4	0	Input #8	0



1. From the Home Screen, tap the Counts box.
2. This displays the number of times the functions have turned on by the controller.
3. This displays the number of times the inputs have been activated past the on debounce time.
4. Press to go to other Counts or press HOME when finished.

NOTE: All counts are lifetime and can not be reset

Panel Build Information

The next pages show panel build information, they will show the following;

- Inside layout
- Output relay schedule
- PLC internal wiring

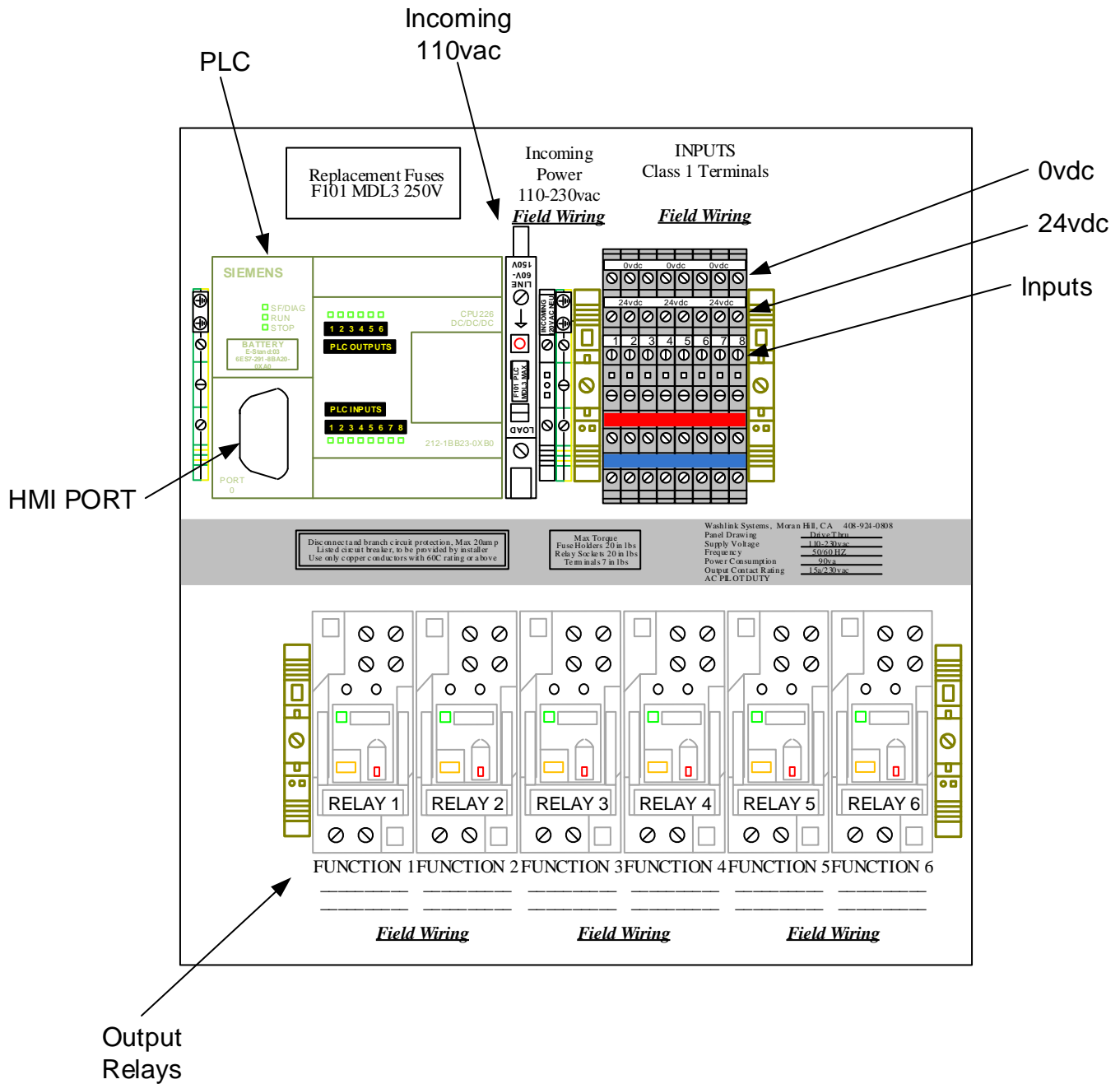

18805 Adams Ct., #110
Morgan Hill, CA 95037 USA
+1.408.924.0808
washlinksystems.com

REV	DATE	PAGE DESCRIPTION: PANEL LAYOUT	DTC
v4 0.5	5/4/2017		
DRAWN BY: SH			
CHECKED BY:			
DRAWN DATE: 1/4/2012			Page 14 of 19

NOT TO SCALE

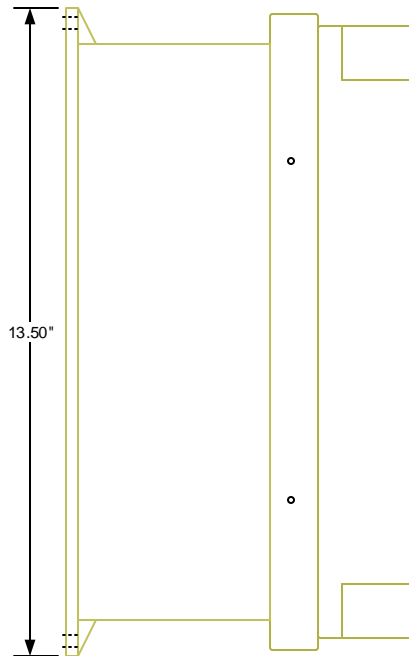
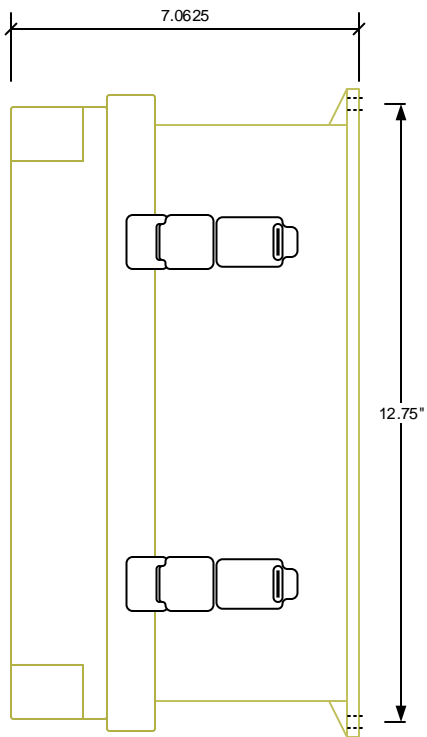

NOT TO SCALE

		18805 Adams Ct., #110 Morgan Hill, CA 95037 USA +1.408.924.0808 washlinksystems.com		
		REV DATE v4 0.5 5/4/2017	PAGE DESCRIPTION: Dimensions	
DRAWN BY: SH CHECKED BY: DRAWN DATE: 1/4/2012				Page 16 of 19

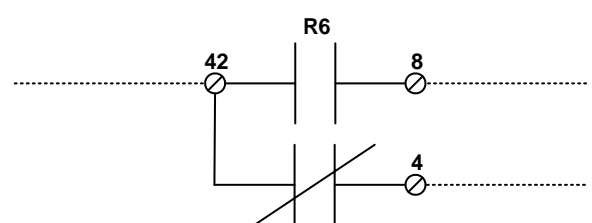
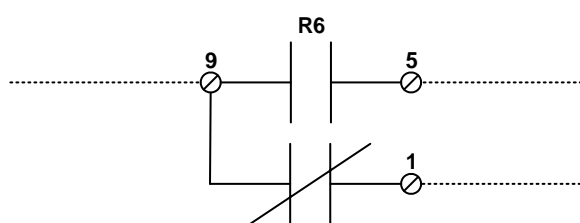
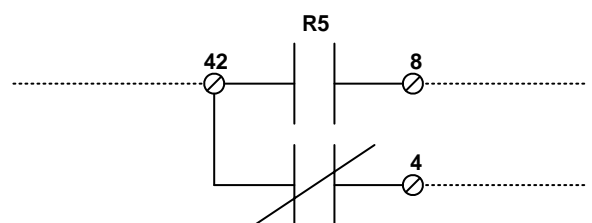
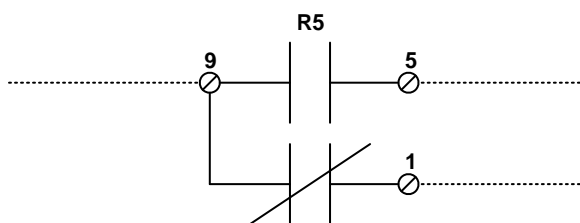
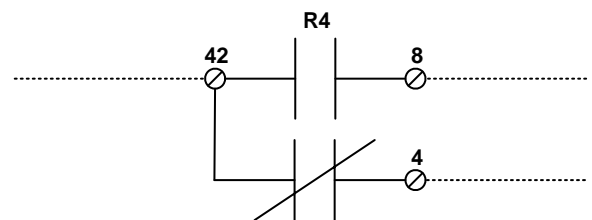
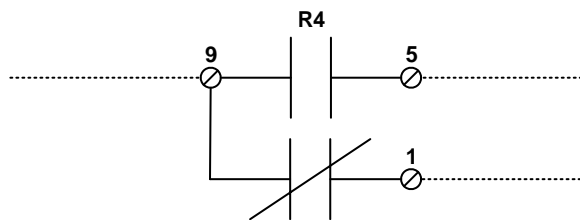
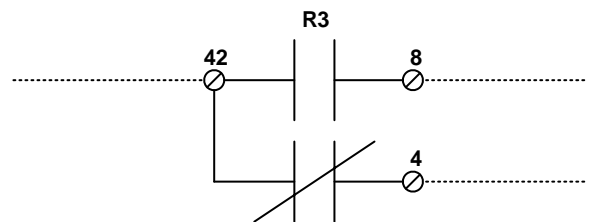
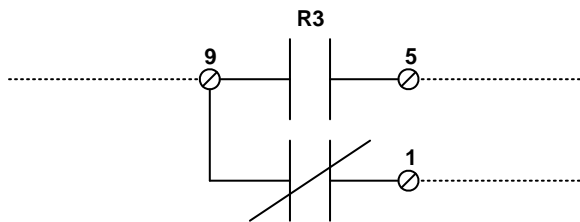
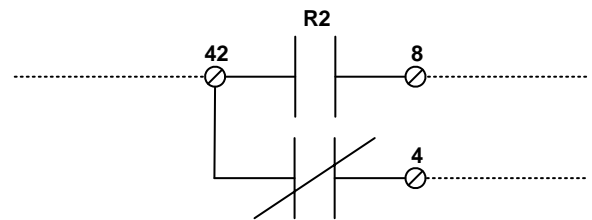
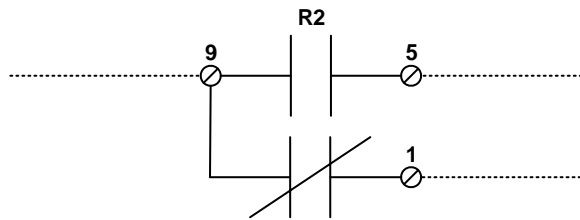
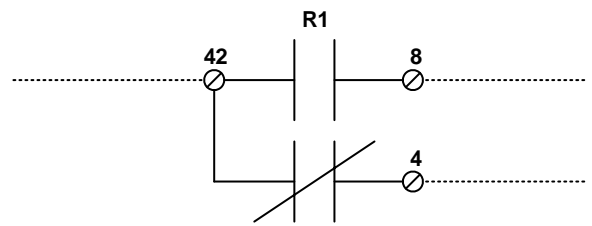
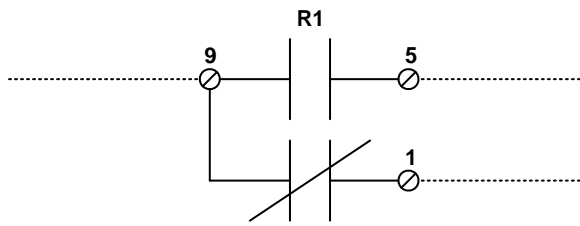

NOTE: All relays are dry contacts and the customers responsibility to bring power to the relay and wire the device from the relay

TORQUE SETTINGS
FUSE HOLDER - 20 in-lbs
RELAY SOCKET - 8 in-lbs
TERMINAL BLOCK - 7 in-lbs

NOT TO SCALE

		18805 Adams Ct., #110 Morgan Hill, CA 95037 USA +1.408.924.0808 washlinksystems.com	
		REV: v4.0.5 DATE: 5/4/2017 DRAWN BY: SH CHECKED BY: DRAWN DATE: 1/4/2012	PAGE DESCRIPTION: RELAY SCHEDULE

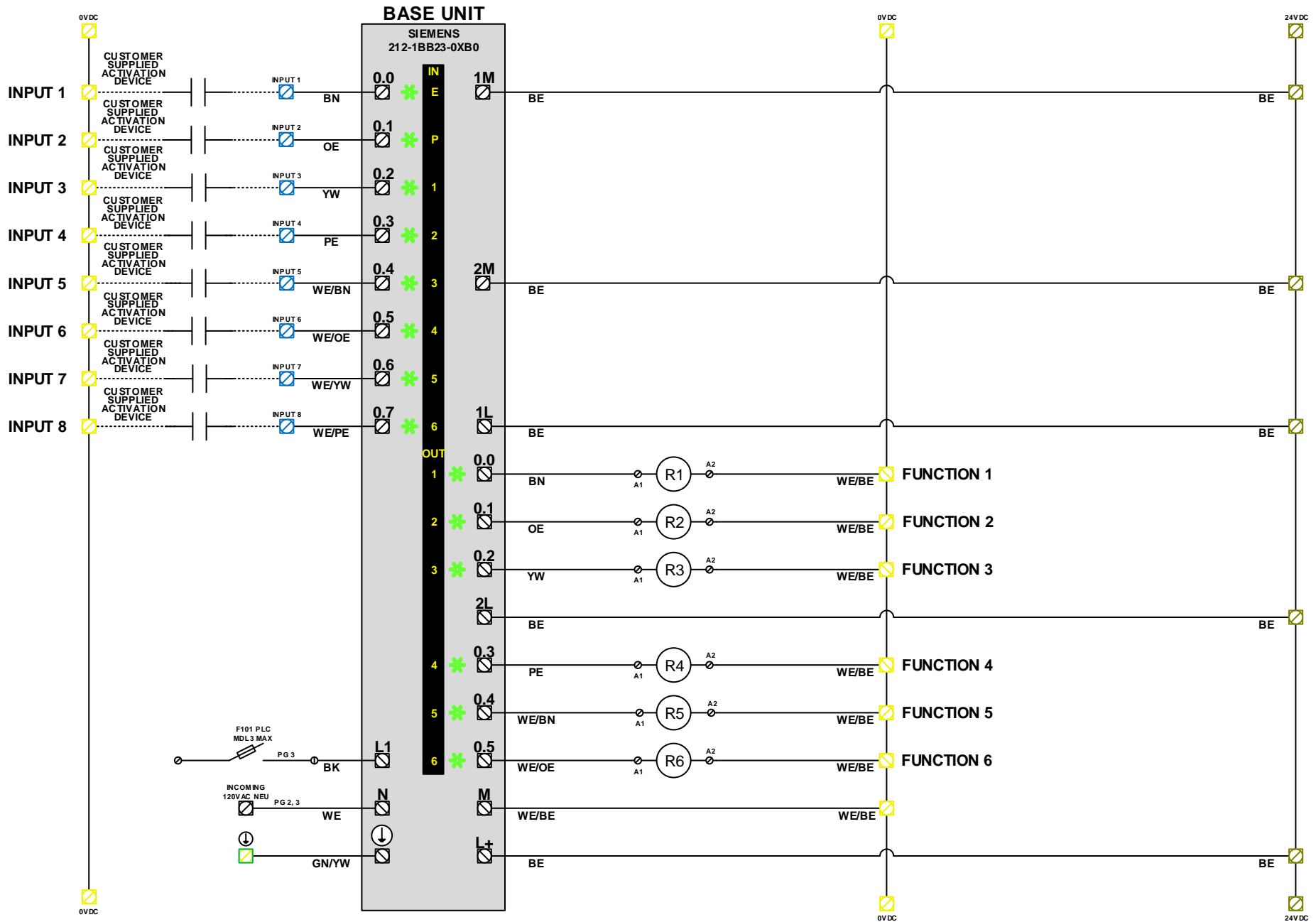

18805 Adams Ct., #110
Morgan Hill, CA 95037 USA
+1.408.924.0808
washlinksystems.com

REV	DATE	PAGE DESCRIPTION: PLC INPUT 1-8/OUTPUT 1-6	DTC
v4.0.5	5/4/2017		
DRAWN BY:	SH		
CHECKED BY:			
DRAWN DATE: 1/4/2012			Page 18 of 19

NOT TO SCALE

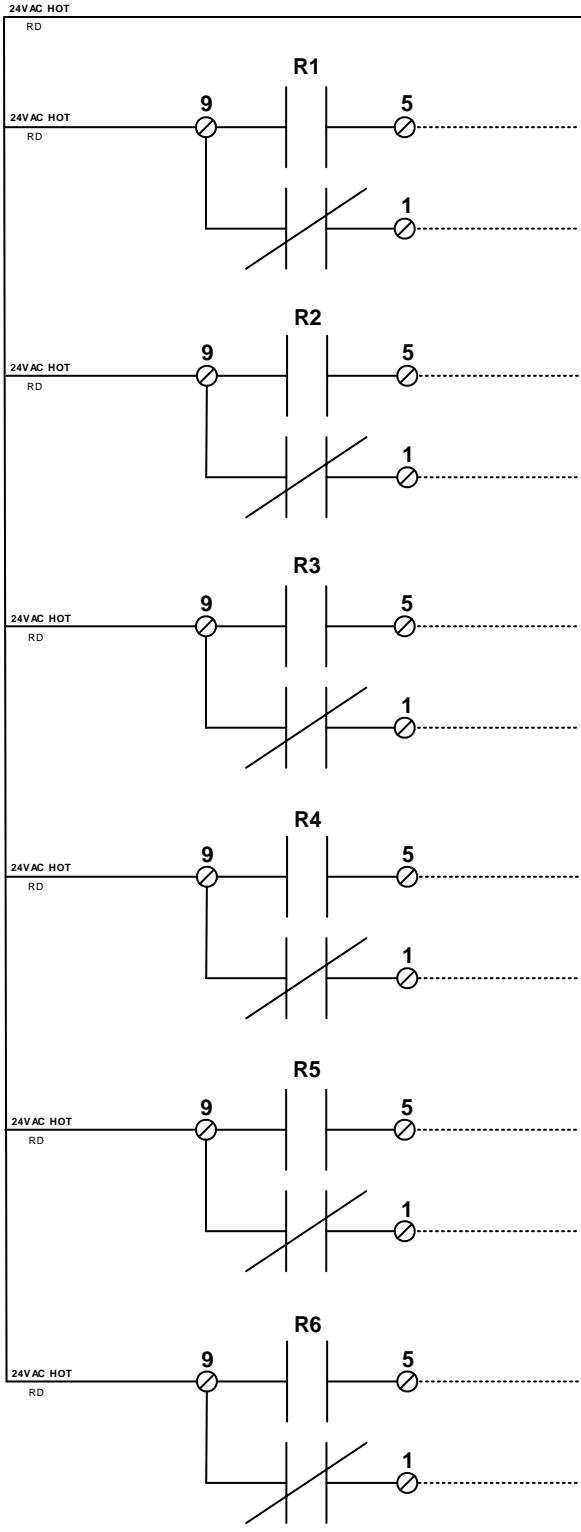
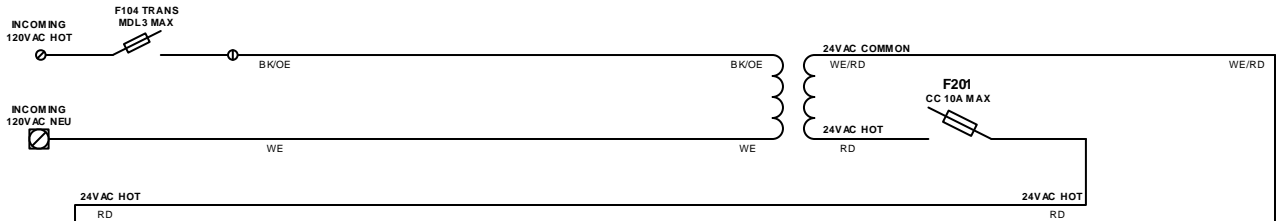

18805 Adams Ct., #110
 Morgan Hill, CA 95037 USA
 +1.408.924.0808
 washlinksystems.com

REV	DATE
v4.0.5	5/4/2017
DRAWN BY:	SH
CHECKED BY:	
DRAWN DATE:	1/4/2012

PAGE DESCRIPTION:

DTC

NOT TO SCALE