

DECK MOUNTED FLOW VALVES

INSTALLATION GUIDE

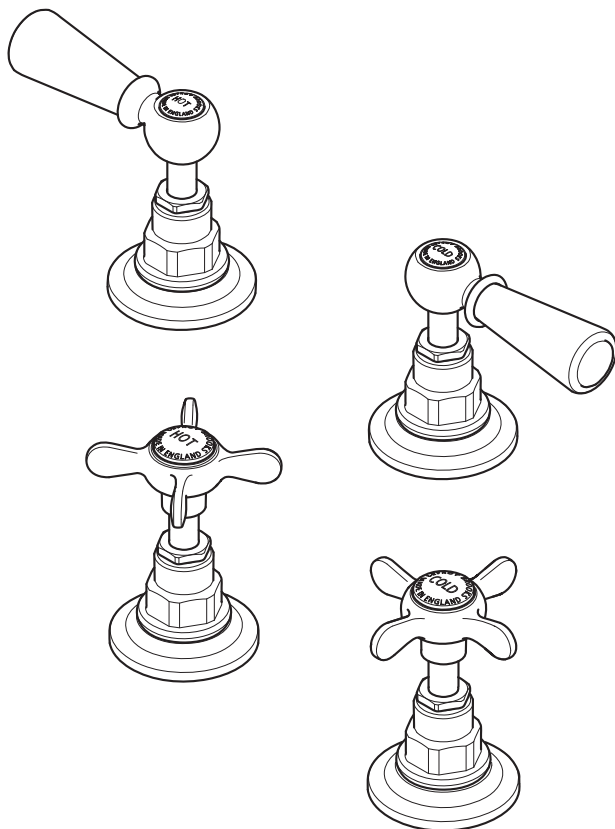

L E F R O Y B R O O K S

DIMENSIONS

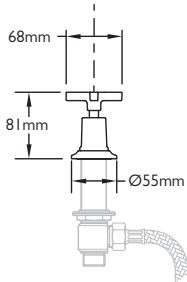

Mackintosh handwheel (MH)

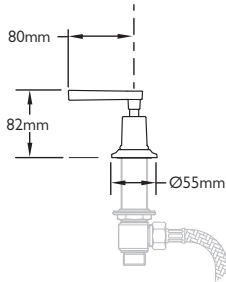

Mackintosh lever (MB, ML)

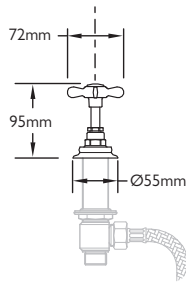

Classic handwheel (LB)

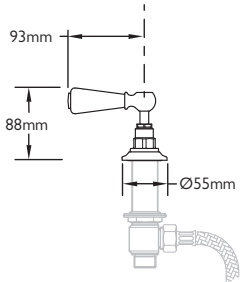

Black lever (BL)

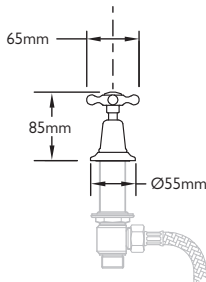

Connaught handwheel (CH)

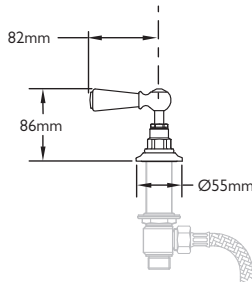

White lever (WV)

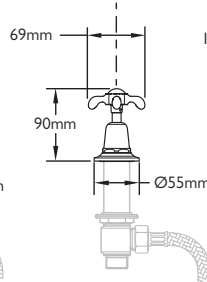

La Chapelle handwheel (FH)

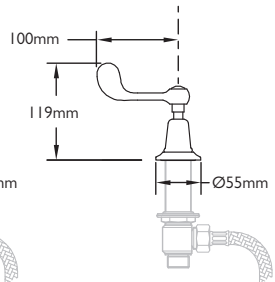

Connaught lever (CL)

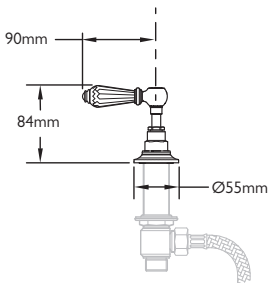

Black crystal lever (CR)

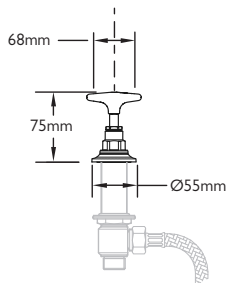

Classic star handwheel (LS)

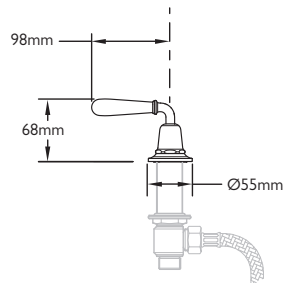

La Chapelle lever (FB FM FW)

Not to scale

DIMENSIONS AND IDENTIFICATION

Shown with handwheel. The dimensions shown also apply to lever models.

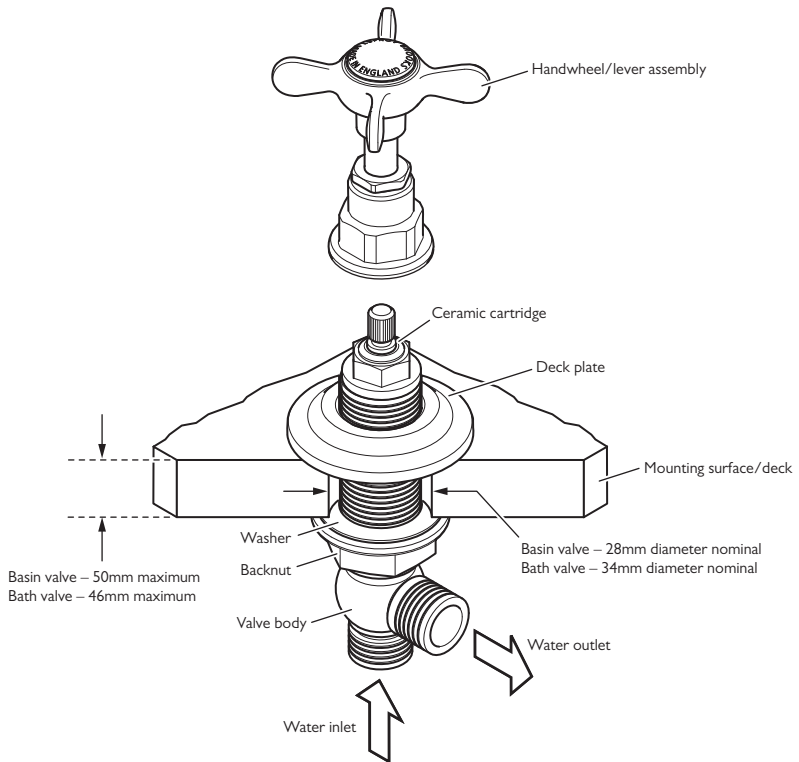

TYPICAL FLOW RATES

Bath valve

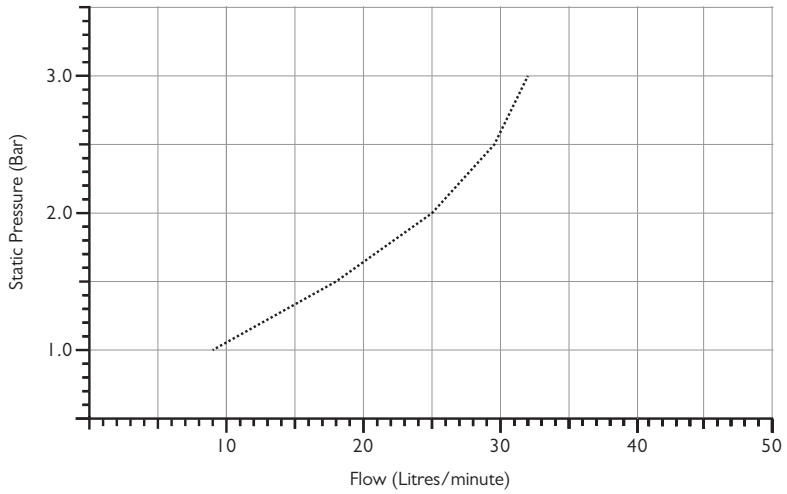

Basin valve

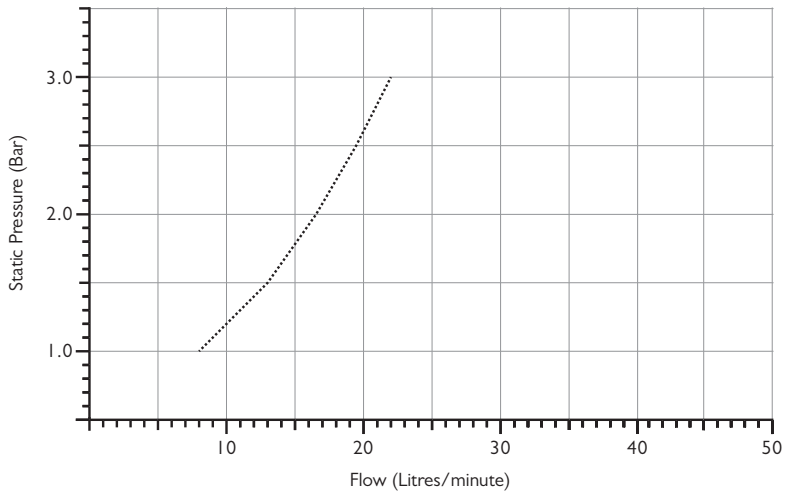

Note: Balance pressures shown are applied directly to the inlet of the valve; flow rates indicated are free flowing and may vary subject to restrictions created by installation, pipework, layout or application.

IMPORTANT INFORMATION

Professional installation

We recommend that our products are fitted by a fully qualified professional plumber. They should be installed correctly and in accordance with all local water regulations and the system protected by non-return valves (not supplied). All products should be accessible for routine servicing.

Suits all systems

This Lefroy Brooks product is potentially suitable for every possible application, type of boiler and water supply pressure. However, if your supply pressure is below 1 bar it is advisable to fit a water pump. For systems with combination boilers, it is not advisable to fit pumps (refer to boiler manufacturer).

Supply connections

The hot and cold water supplies should be connected using suitable ½" or ¾" connectors.

Supply temperature safety notice

To comply with local building regulations, current legislation, relevant standards and codes of practice a thermostatic mixing valve (TMV) should be fitted (not supplied) to the hot supply. This will restrict the temperature to a safe working maximum temperature. Maximum allowed temperatures vary subject to type of installation or specification of building.

Balancing flow

If there is a significant difference in water pressures between hot & cold supplies, we recommend an in-line flow suppressor/regulator (not supplied) be fitted. Where flexible hoses are fitted, this should be fitted to whichever has the greater flow rate, in an accessible position close to the valve. Do not fit the flow suppressor/regulator at the spout as this will increase the pressure in the flexible hoses.

Water quality

In hard water areas, a suitable water treatment system should be provided to prevent limescale deposits (calcium deposits) which may effect the long term performance of the ceramic cartridges. Exterior surfaces should be gently wiped with a dry soft cloth after use to minimise water stains and limescale deposits.

Flushing system

It is most important to flush out all pipework thoroughly before connecting the product.

This is the single most common cause of ceramic cartridge failure.

Servicing

All serviceable parts are available to maintain your Lefroy Brooks product.

FLOW VALVE INSTALLATION

Shown with handwheels. The same procedure also applies to lever models

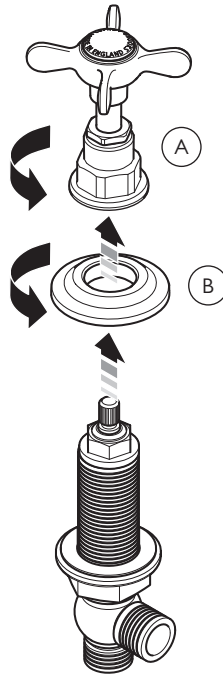

Before continuing please be aware that on lever models it is important to keep the flow valve bodies and lever assemblies together as supplied. Do not swap the lever assemblies from hot and cold valves.

- 1 Where necessary drill $\text{Ø}28\text{--}30\text{mm}$ holes in the mounting surface for basin flow valves or $\text{Ø}34\text{--}36\text{mm}$ holes for bath flow valves.

- 2 Support the flow valve body then unscrew (counter clockwise) and remove the handwheel/lever assembly (A) from the valve body.
- 3 Unscrew (counter clockwise) and remove the deck plate (B). Do not remove the backnut and washer.

FLOW VALVE INSTALLATION

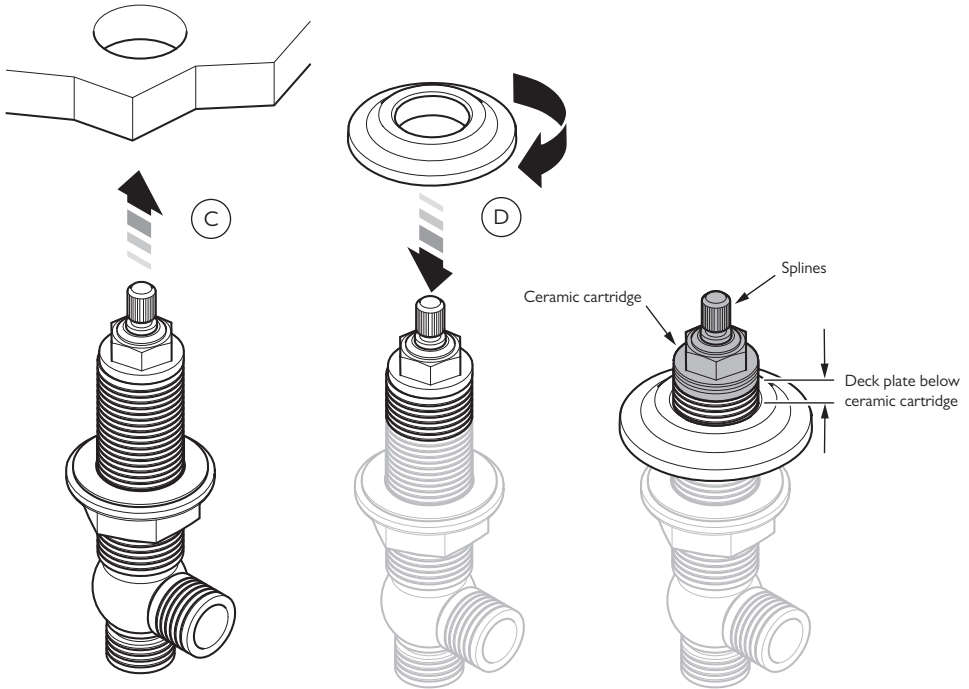

- 4 Locate the flow valve through the hole in the mounting surface (C).
- 5 Screw the deck plate onto the top of the flow valve, beyond the level of the ceramic cartridge (D).
- 6 On handwheel models rotate the splines on top of the ceramic cartridges so that they are in the fully clockwise position. On lever models rotate the splines on top of the 'hot' ceramic cartridge so that they are in the fully clockwise position and the splines on top of the 'cold' ceramic cartridge so that they are in the fully counter clockwise position. The handwheels/levers can be loosely located to achieve this.
- 7 Rotate the flow valve body so that the side outlet port is facing the required direction for connection.

FLOW VALVE INSTALLATION

Shown with handwheels. The same procedure applies to lever models

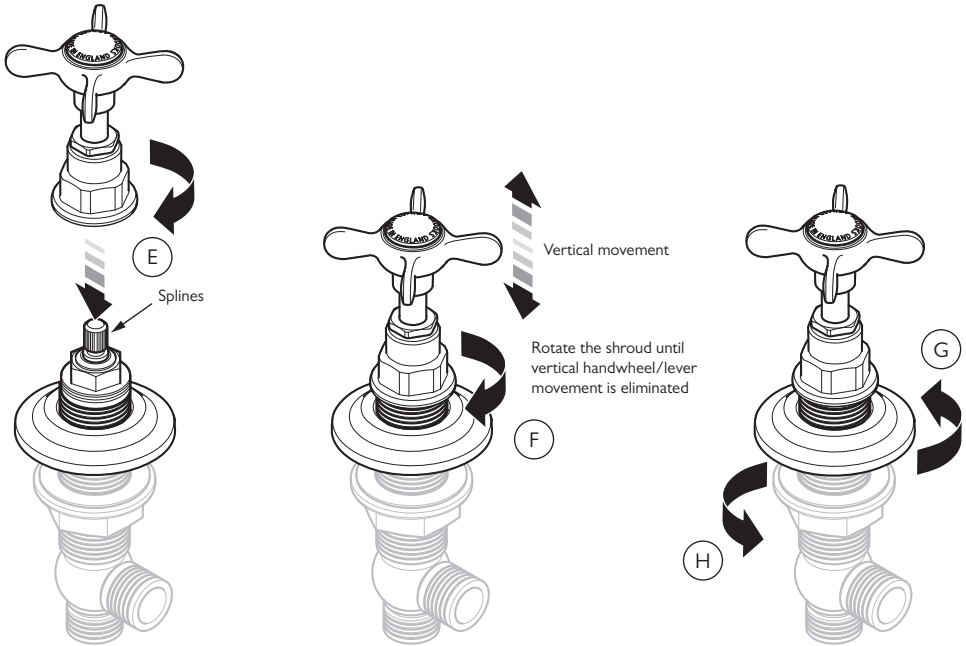

- 8 With the handwheel/lever 'hot/H' or 'cold/C' text aligned, locate the handwheel/lever assembly onto the splines of the cartridge (E). Rotate the shroud of the handwheel/lever assembly in a clockwise direction until vertical movement of the handwheel/lever is eliminated (F). DO NOT tighten the handwheel/lever assembly in place as this may damage the ceramic cartridge and will make operation of the handwheel/lever feel stiff. The aim is to simply rotate the handwheel/lever assembly shroud until the handwheel/lever no longer has any vertical/up and down movement.
- 9 Rotate the deck plate counter clockwise to meet the handwheel/lever assembly, leaving no gap between them (G).
- 10 Ensure that the handwheel/lever alignment is as required before securing the flow valve in place. The flow valve can be rotated to correct any small alignment issues. Tighten the backnut to secure the flow valve in place (H).

SERVICING – CARTRIDGE REPLACEMENT

Shown with handwheels. The same procedure applies to lever models

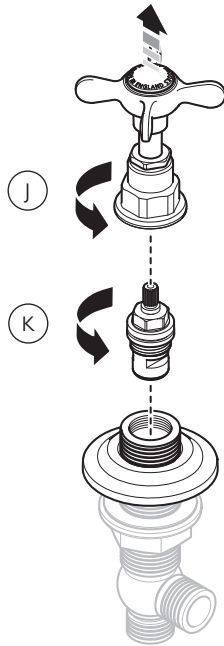

Before continuing please ensure that the water supplies have been isolated and drained where necessary.

1 To remove the ceramic cartridge, unscrew (counter clockwise) and remove the handwheel/lever assembly (J).

2 Support the flow valve body. Unscrew and remove the ceramic cartridge (counter clockwise) using a 17mm spanner (K).
3 Assemble in the reverse order.
4 Refer to steps 8–10 in the 'flow valve installation' section to ensure the handwheel/lever assembly is installed correctly.

SERVICING – REPLACING THE LEVER CERAMIC/CRYSTAL HANDLE ON BL, WL & CR MODELS

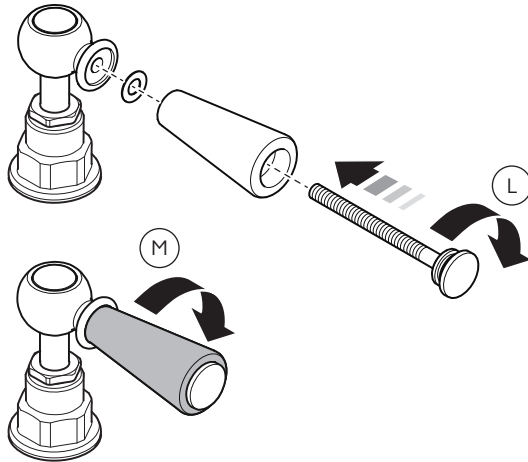

- 1 Push the threaded screw through the centre of the replacement ceramic handle.
- 2 Locate the end of the threaded screw into the hole in the lever body. Tighten the screw by hand (L).
- 3 To secure, grip the ceramic handle and rotate it in a clockwise direction (M).

SERVICING – REPLACING THE LEVER CERAMIC ON FB, FM & FW MODELS

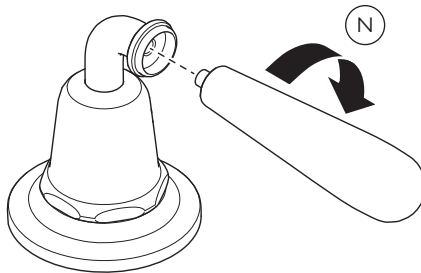

- 1 Unscrew the ceramic from the lever in a counter clockwise direction.
- 2 Fit the replacement lever by screwing into the lever body in a clockwise direction (N)

FAULT FINDING

The hot/cold flow valves are turned off but the spout drips continuously.

- Replace the ceramic cartridge(s). See below for spare part numbers and the 'servicing – cartridge replacement' section

The handwheel/lever feels loose and has vertical/up and down movement.

- Reset the handwheel/lever assembly (refer to steps 8 to 10 in the 'flow valve installation' section).

The handwheel/lever operation feels tight/stiff.

- Reset the handwheel/lever assembly (refer to steps 8 to 10 in the 'flow valve installation' section).

REPLACEMENT PARTS

Basin flow valve cartridges

PHL034 – Pair of ½" x ½ turn ceramic cartridges for handwheels (clockwise closing)

PHL035 – Pair of ½" x ¼ turn ceramic cartridges for levers (one clockwise closing (left side) and one counter clockwise closing (right side))

Bath flow valve cartridges

PHL037 – Pair of ¾" x ½ turn ceramic cartridges for handwheels (clockwise closing)

PHL036 – Pair of ¾" x ¼ turn ceramic cartridges for levers (one clockwise closing (left side) and one counter clockwise closing (right side))

Lever parts

PHL016 – (WL) White lever ceramic only

PHL020 – (BL) Black lever ceramic only

PHL066 – (WL & BL) Lever threaded screw and end cap

PHL009 – (LB) Pair of Classic Handwheel 'hot' and 'cold' ceramic indices

PHL015 – (WL & CL) Pair of White Lever and Connaught Lever 'hot' and 'cold' ceramic indices

PHL027 – (CH) Pair of Connaught Handwheel 'hot' and 'cold' ceramic indices

PHL095 – (CR) Black crystal lever, crystal only

PHL114 – (CR) Crystal lever threaded screw and end cap

PHL122 – (FB) La Chapelle lever, black ceramic and shaft

PHL123 – (FW) La Chapelle lever, white ceramic and shaft

PHL124 – (FM) La Chapelle lever, metal ceramic and shaft



CUSTOMER SUPPORT

+44 (0)1992 708 316

LEFROYBROOKS.CO.UK

Whilst every effort is made to ensure the accuracy of these, they are subject to change without notice as part of the company's product development process. The use of trademarks, product design and artwork is subject to licence or agreement with LBIP Ltd. The design registrations, trademark registrations and copyrights are protected by law and the use or reproduction outside the terms of an agreement is prohibited. The right to modify designs and dimensions is reserved. LBIP Ltd is a member of ACID (Anti Copying in Design).