

Tandem

for soprano and bass clarinet

Christopher Fisher-Lochhead

Tandem [2011-2013] for soprano and bass clarinet

Dedicated to Christie Finn and Felix Behringer

Rhythmic Notation

This piece uses a *time-space* system of rhythmic notation. Instead of relying on a vocabulary of symbols to express determinate rational rhythmic values (quarter-note, eighth-note, etc.), all of the rhythmic information is given by the notation's horizontal placement on the page. With the exception of two passages (indicated in the score), in which the timing is left entirely up to the performers, the space occupied by a single system is equivalent to six seconds.

While the use of such a system is often associated with a performance practice in which rhythmic specificity is not of the utmost importance, the rhythms indicated in this piece should be realized as exactly as possible. In this case, the purpose of such a seemingly imprecise means of notation is not to allow greater freedom in performance but to avoid the feeling of rationally regimented divisions of time.

To aid in the faithful realization of these rhythms, each system includes a reference staff with weighted gradations of time. The vertical notches on this staff correspond to (in order of decreasing size): 1 second, .5 seconds, .25 seconds, and .125 seconds. Additionally, rhythmic events which are meant to coincide are joined by a vertical line.

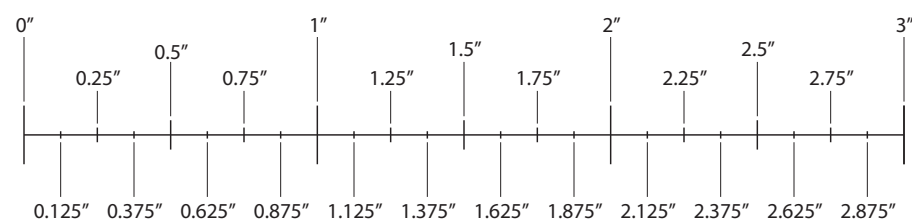

Attack/Sustain

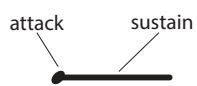

The material in this piece is constructed around a productive difference between punctual (pointillistic) and sustained musical/linguistic objects. Noteheads are used to indicate punctual attacks while solid black flagellae indicate sustain.



Hollow noteheads indicate unvoiced tone. For the voice, this means a tone in which the larynx does not vibrate. For the bass clarinet it means a tone with as little pitch as possible (the presence of some pitch is often unavoidable, especially in regard to slap tongues).



Solid noteheads indicate voiced/pitched tone.

Voice

Throughout this piece, the bass clarinetist is required to switch quickly between instrument and voice. The transitions are indicated by the abbreviations **BCI** and **V**.

dʒɪ kɔ ti tʃə Vocal phonemes are indicated using IPA characters.

t[ə] For unvoiced consonants, the vowel coloring is indicated in brackets.

V Ingressive airflow.

Bass Clarinet



Slap tongue.

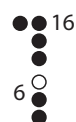

Fingerings for multiphonics are indicated above the clarinet staff.



Open slap tongue.



Air noise.



Overblow on a low fundamental.



Fluttertongue.

Pitch/Staff Types

This piece employs three different staff types, each corresponding to a specific type of pitch notation.

 **unpitched staff** - used for any material that does not have an appreciable pitch content (unvoiced phonemes, air noise, etc.)

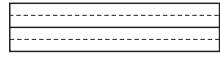
 **contour/register staff** - used to indicate the approximate register and contour of the pitch. The solid top and bottom lines indicate registral extremes, the solid middle line indicates the middle register, and the dashed lines indicate the spaces in between.

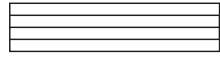
 **traditional staff** - used to indicate the exact pitch (accompanied by the appropriate clef).

Dramaturgy

The performance of this piece should contain a strong theatrical element. To begin with, the performers should set up facing each other on stage so as to highlight the dialogic (even adversarial) nature of the ensemble writing. Because the performers will not be relying on traditional rhythmic notation to coordinate their parts, it is necessary that they remain sensitive to what each other is doing. The intense focus of each player on the other required to execute the prescribed rhythms is more than a practical necessity, it is integral to the theatrical dynamic of the piece.

While actual expressive or “theatrical” indications in the score are rare, all of the indicated musical gestures should be performed in a manner such that their theatrical potentialities are emphasized. This does not mean adding an extraneous dramatic narrative to the prescribed musical events but rather finding the theatrical significance in the sounds themselves and their means of technical realization.

Tandem

Chris Fisher-Lochhead

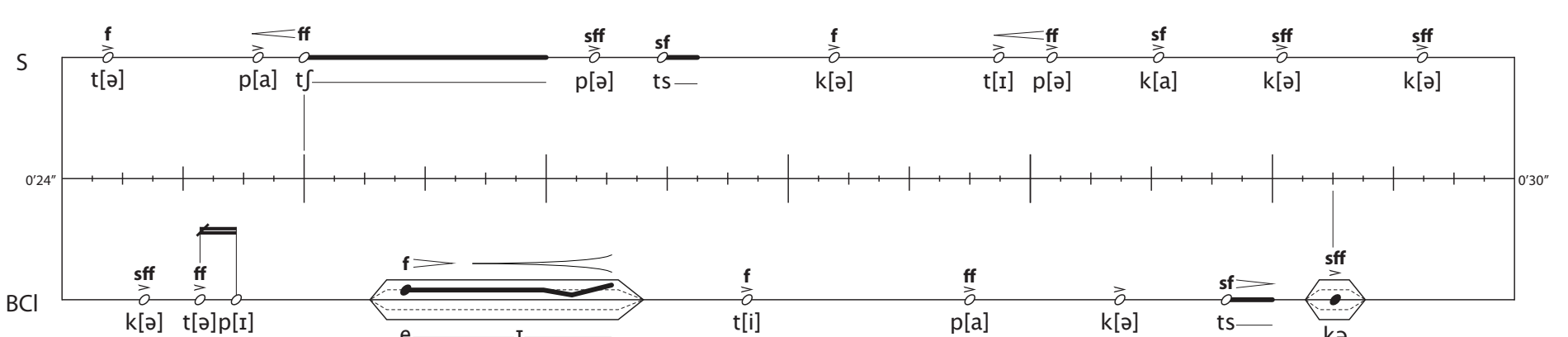
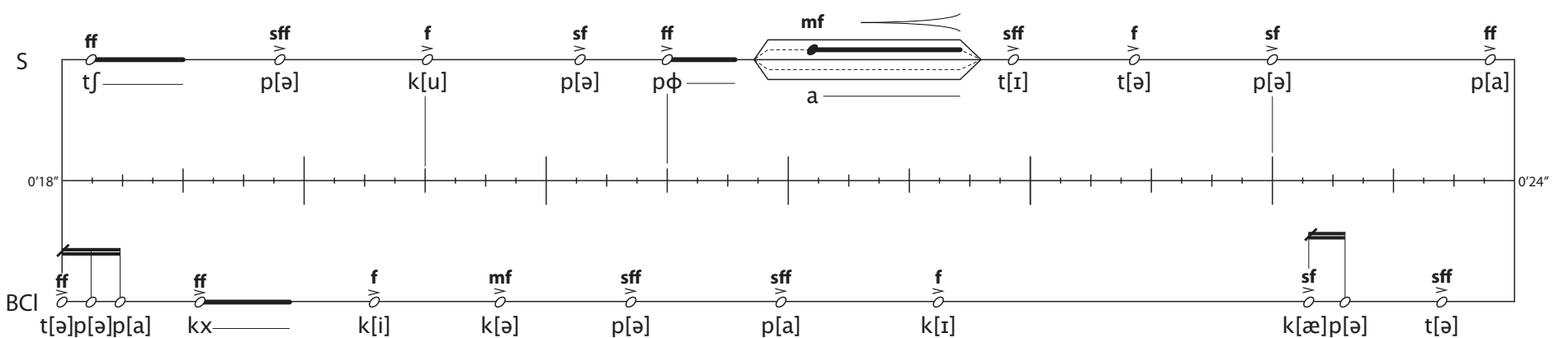
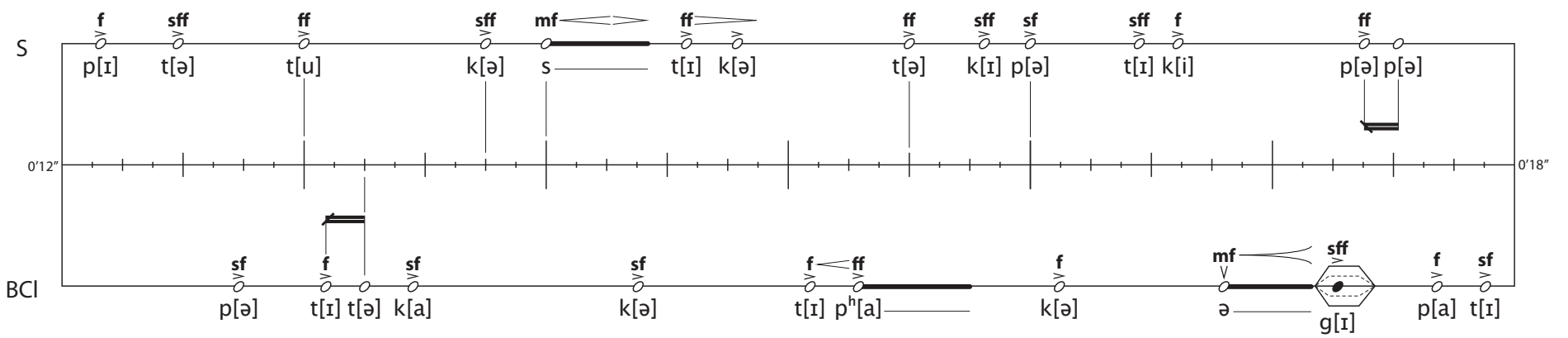
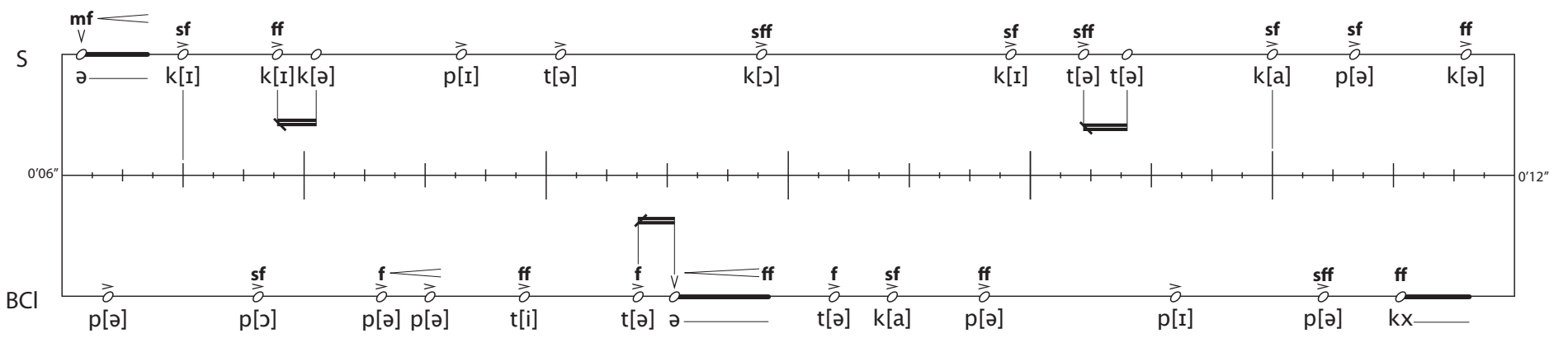
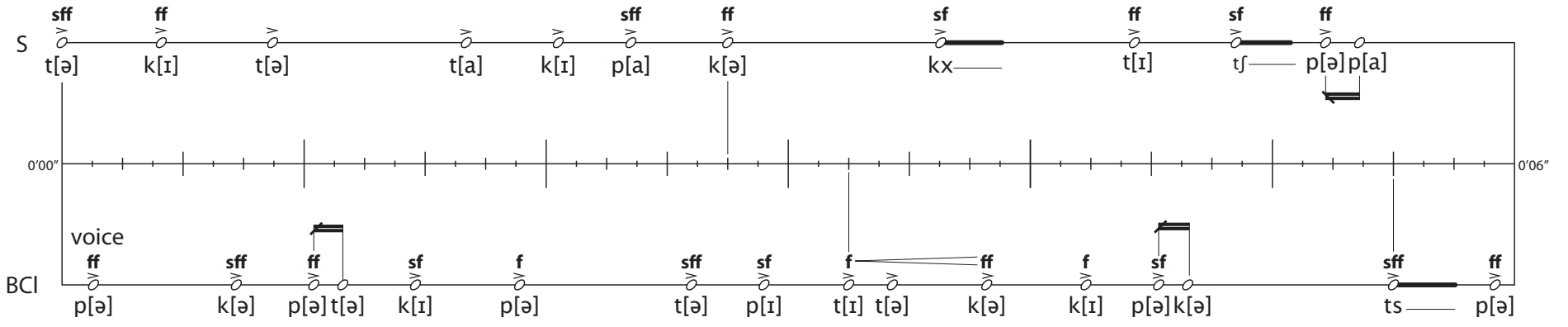

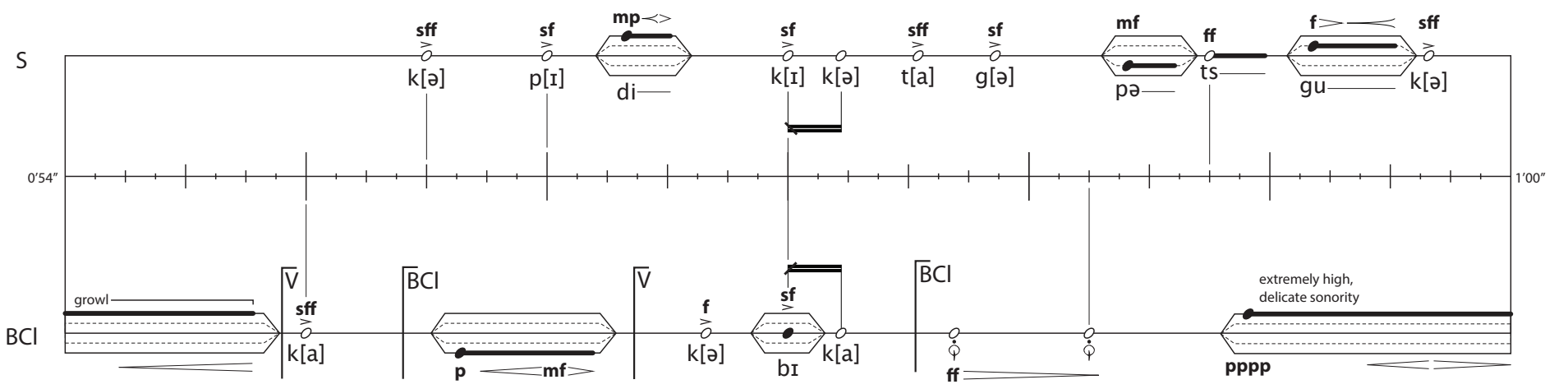
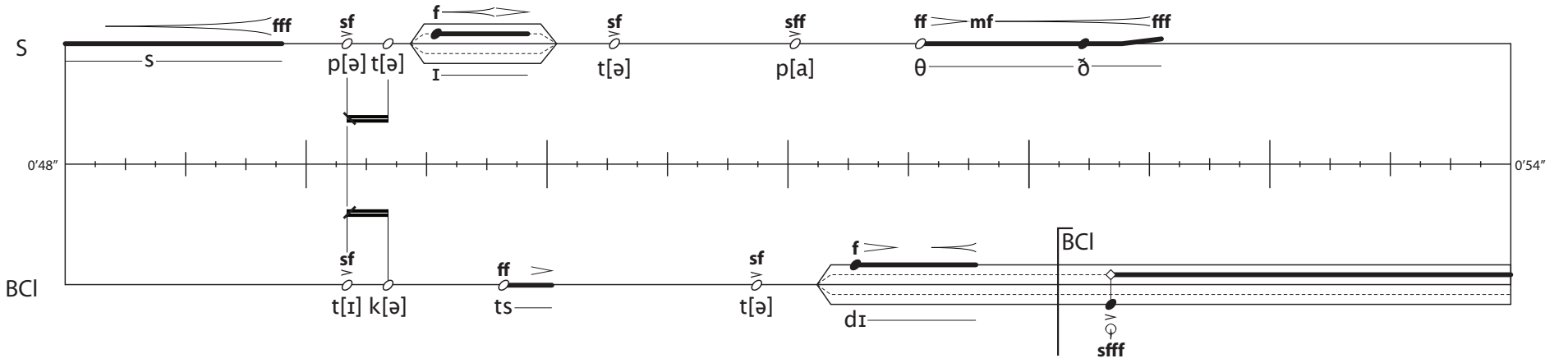
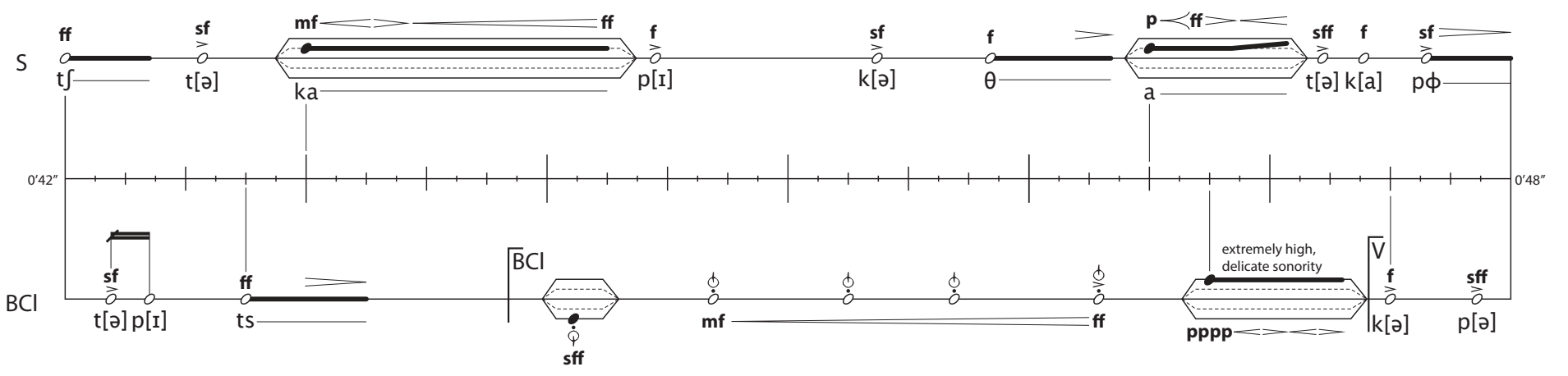
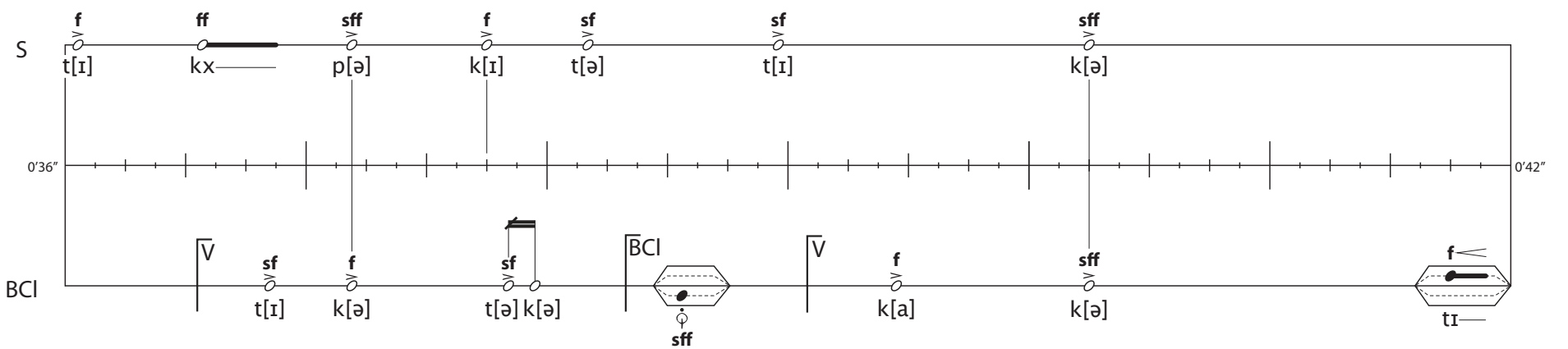
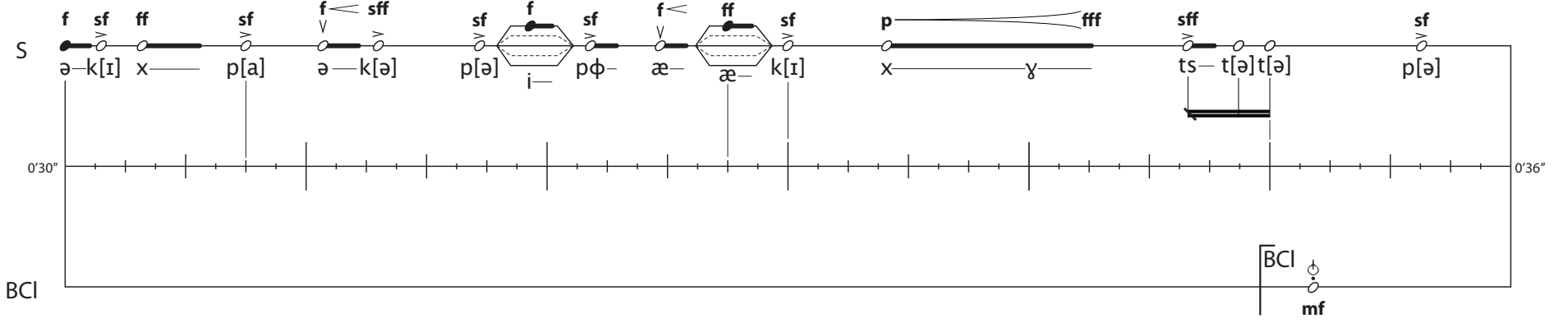

S
 ff p[a] t[ɔ] bə p[ə] sf pɪ k[a] sf p[ə] sff f tʃ sf kɪ

1'00" 1'06"

BCI
 mf f tə sf mp f sff p growl fff

S
 f p sf ti u gi sff ff sf t[u] p[ə] tʃ t[i] mf sf sff s z dɪ pə f t[i] sf f sf tʃ bə kɔ

1'06" 1'12"

BCI
 sf tʃ sff k[i] k[ɔ] k[i] BCI mp mf f

S
 ff ts sff tʃ da sf p[ə]k[i]p[ə] t[æ] p t[ə] sff mf f tʃ t[i] pφ mf sf tɪ də

1'12" 1'18"

BCI
 sff p f k[a] BCI mp f

S
 ff ts sf f gi t[i] mf ff a k[ə] ff ff tu bə ts f ff tə pə ta dɪ tʃ ff tɪ bə ti gə pə ka sf p[ə]

1'18" 1'24"

BCI
 sf p[a] sf sf mp f sf p[ə] p p[ə]

S
 sff k[ɔ] p ff ff sf mf bə ə ff f tu f sff k[ə] pp te

1'24" 1'30"

BCI
 f bə BCI n ff extremely high, piercing shriek mf ə BCI n mp sf t[i] sff tʃ

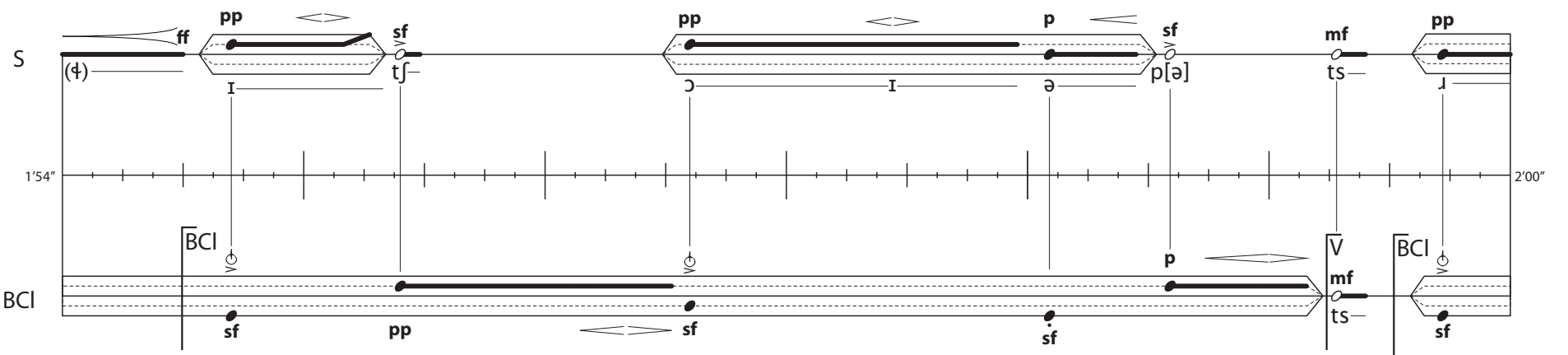
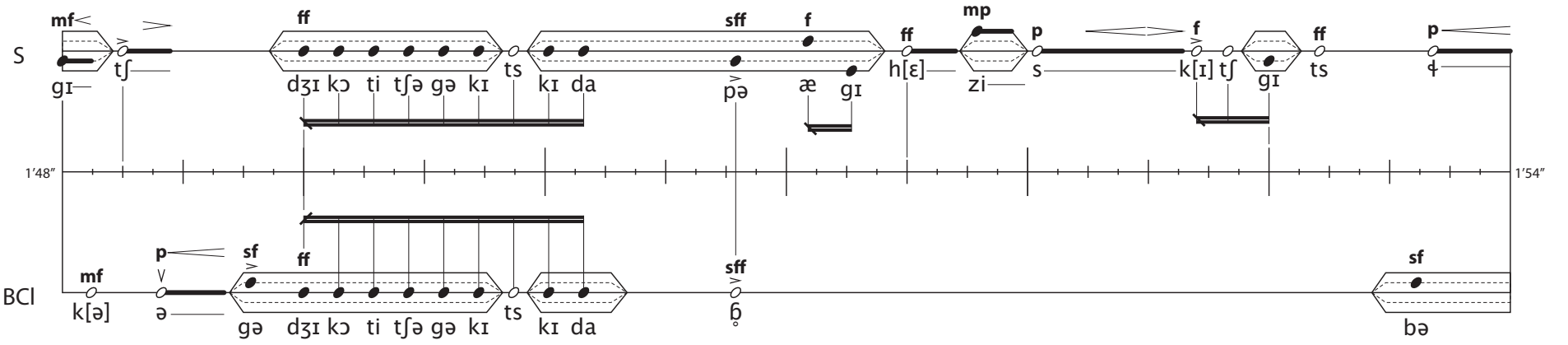
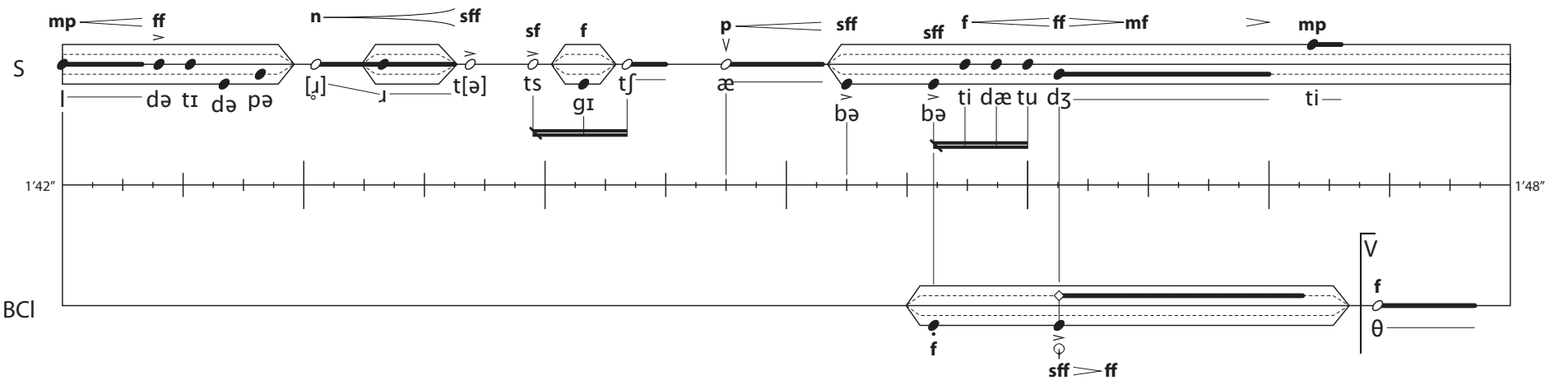
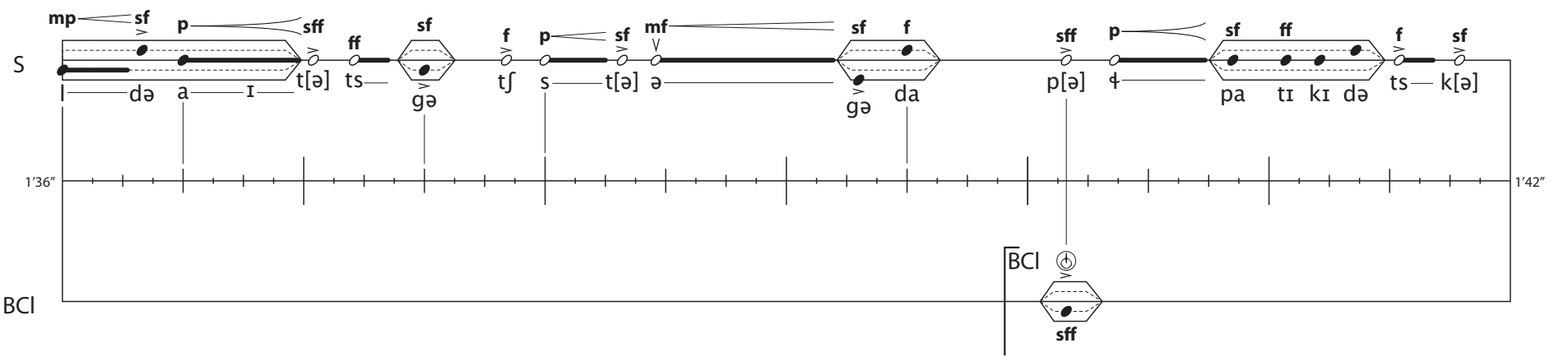
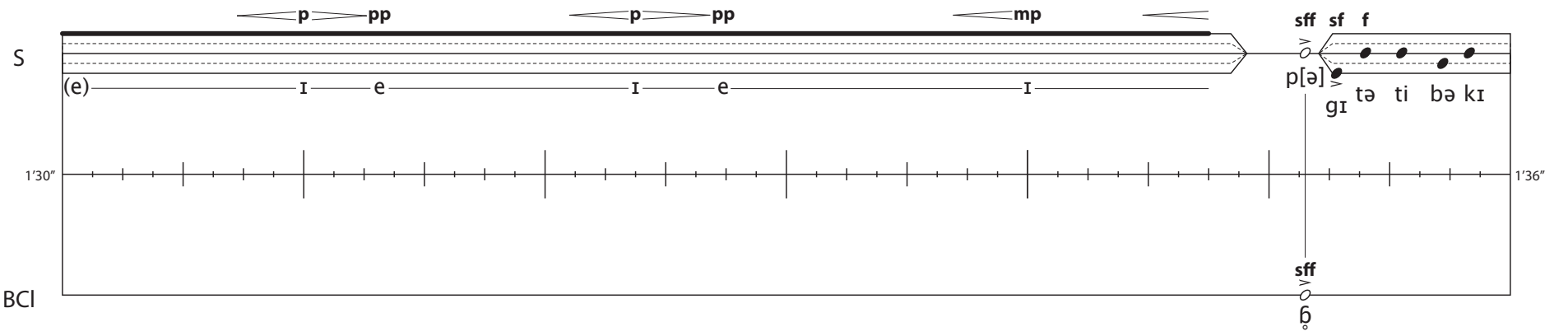

S
 (j) t[ɪ] t[ə] ə pə

2'00" 2'06"

BCI
 mp mf sf də n

S
 ə bə k[ə] z s ta ts ɪ də ti

2'06" 2'12"

BCI
 (n) p pp mp mf ppp sf BCI pp f sf p mp

S
 k[ɔ] z dʒæ kɪ tə ə bə tɪ pə t[æ] t[a] k[ɪ]

2'12" 2'18"

BCI
 f mp sf sff pp sff BCI mf pp f p ff sff

S
 t[ɪ] p[ə] ts θ bə t[ə] n ts tɪ kɪ pə ta bə dʒæ ta də tu də tɪ

2'18" 2'24"

BCI
 ff sf f sff BCI mf f ff sf BCI p pp

S
 ts də ti də t[ə] t[ɪ] ə ɔ ɪ ɔ ɪ

2'24" 2'30"

BCI
 ff sff pp k[ɔ]

S
p f mp mp mf pp
(I) tʃ a ɪ kɪ ɨ

2'30" 2'36"

BCI
p sf sff
e ɪ n də k[ɔ]

S
mp p mf
(ɨ) tʃe ɪ ts dʒ k[ə] k[ə] k[ə] k[ə]

2'36"

BCI
mf pp mf f mp fff
extremely high, delicate sonority

repeat ad lib., all the while increasing loudness and period of repetition.

S
sf p sf sf f mp ff mf p f sff mp
tʃ s z kɔ t[u] gə dʒ ɪ n ɔ ti ɨ bə ə

0'00" 0'06"

BCI
p mf mp f p sf
t[a] s t[a] s

S
sff ff mf f p sff mp
(ə) bə ɡɪ tɑdʒɪ θ ɔ ə tɪ də sɪ kɪ də n ts ɪ æ

0'06" 0'12"

BCI
ff mp fff sff f
θ n

The closing section is out of time and extremely slow. While there are no strict rhythmic indications, the way the swells in each part line up should remain unchanged.

S
z s sff ppp pp ppp pp
də m a ɪ ɨ j e ɪ n

0'12"

BCI
v ə n də t[ə] ppp pp ppp pp
16 6

S

ppp pp ppp pp ppp pp ppp pp

l a I | I | l a I n w ə I

BCI

S

ppp f pp

m u n hɛ ə I

BCI

Chicago, 2011-2013