

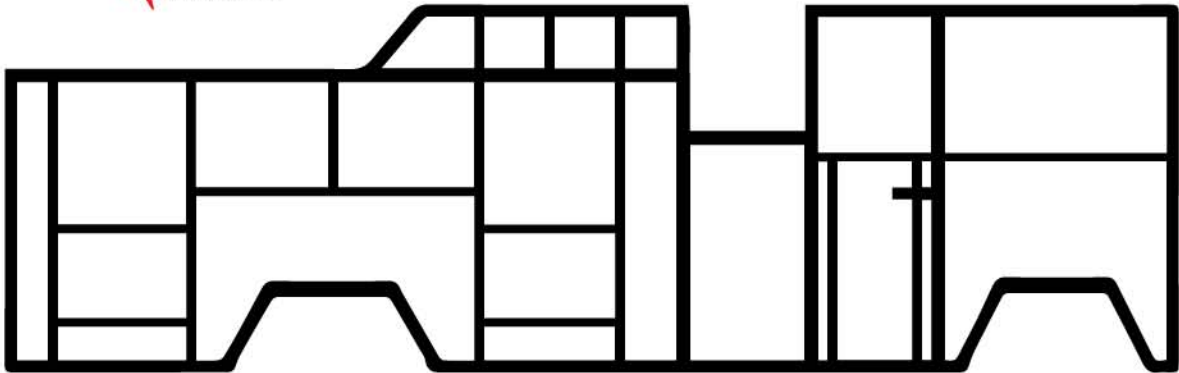

1
DRAW PIECES

A.



B.

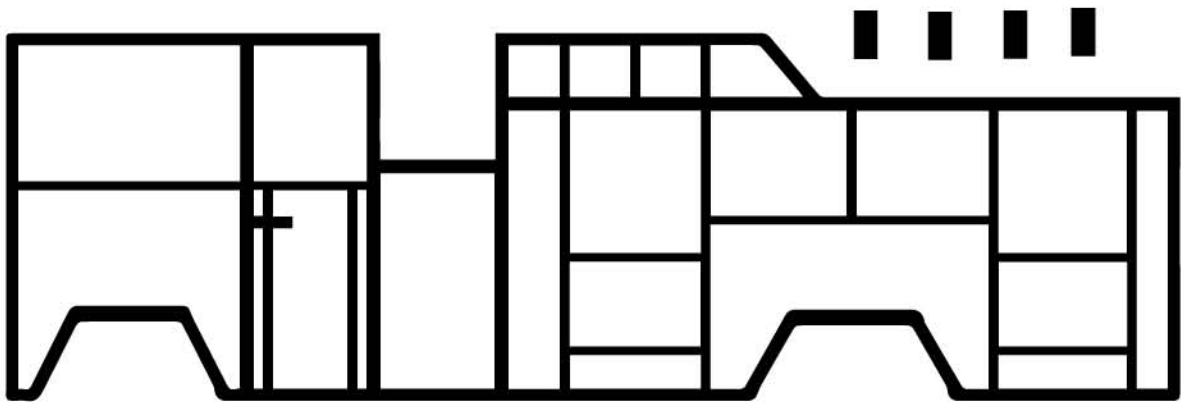

C.

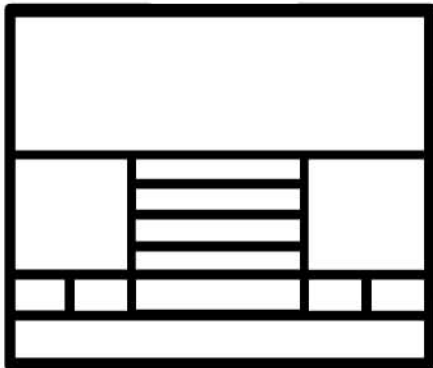

D.



F.



E.



G.

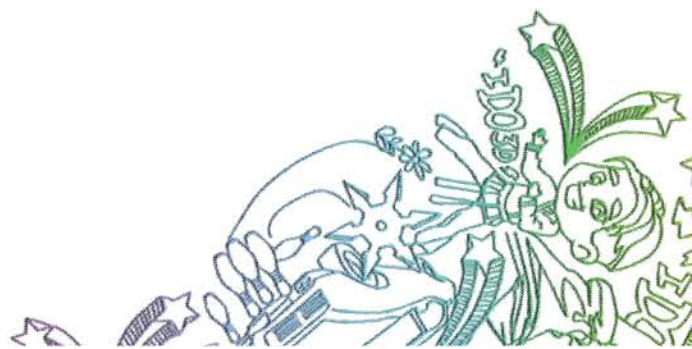

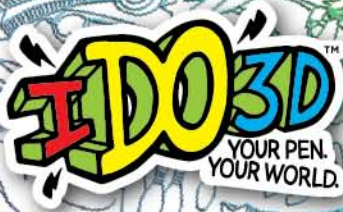

MAKE A FIRE TRUCK

COPYRIGHT REDWOODVENTURES LTD



1 DRAW PIECES

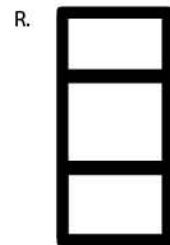
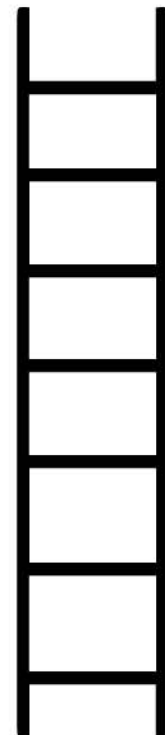
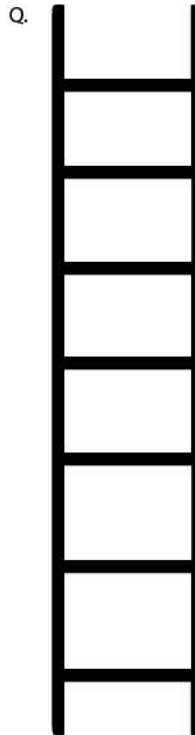
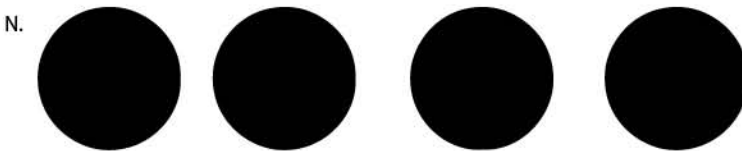
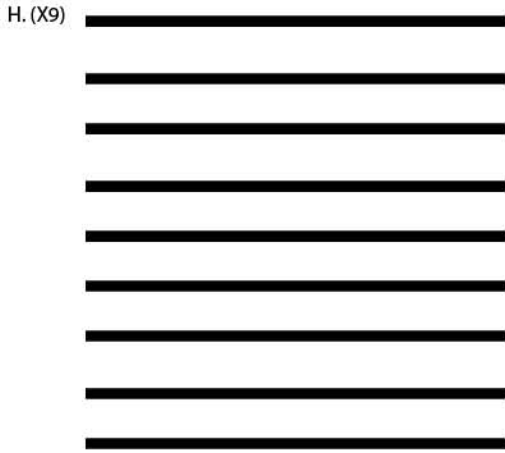

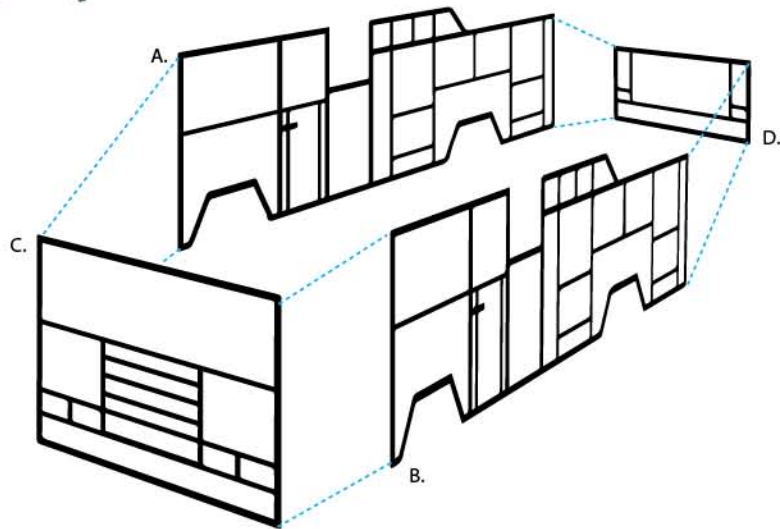

2
 ATTACH A, B, C AND D.

3
 ATTACH BRACES (H) TO FIRETRUCK.
 SEE DIAGRAM BELOW FOR PLACEMENT.

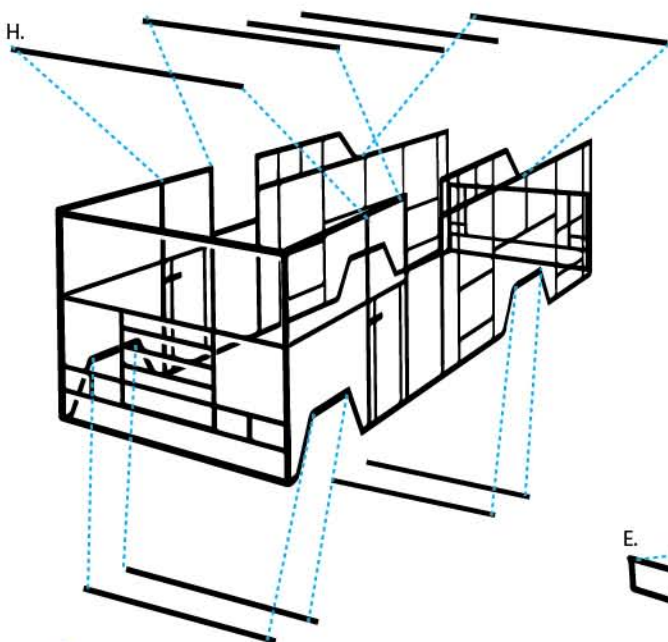

4
 ATTACH BRACES LIGHTS, BUMPERS, AND
 WHEELS TO FIRETRUCK.

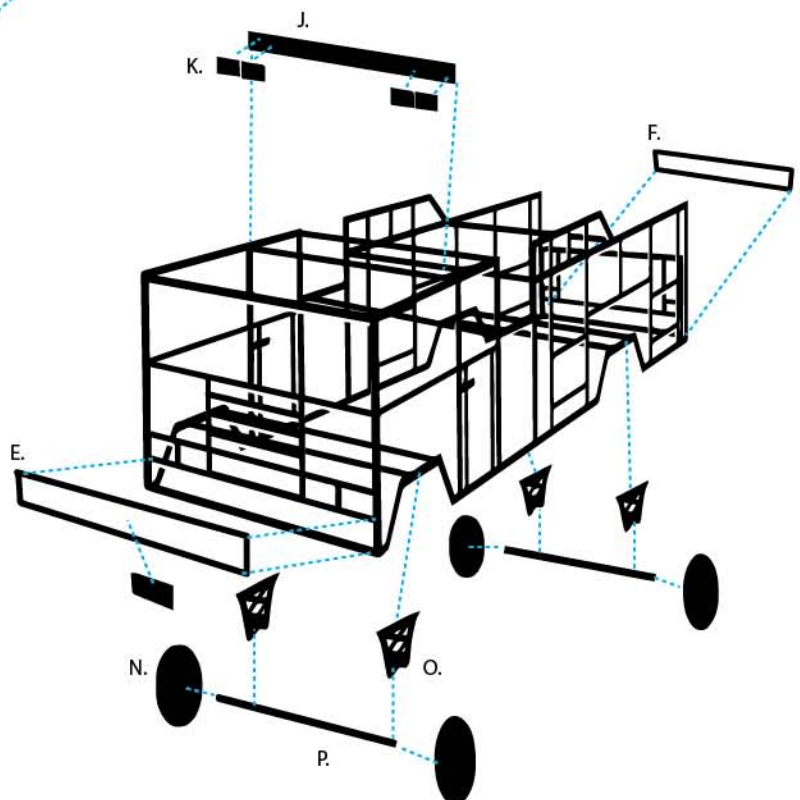

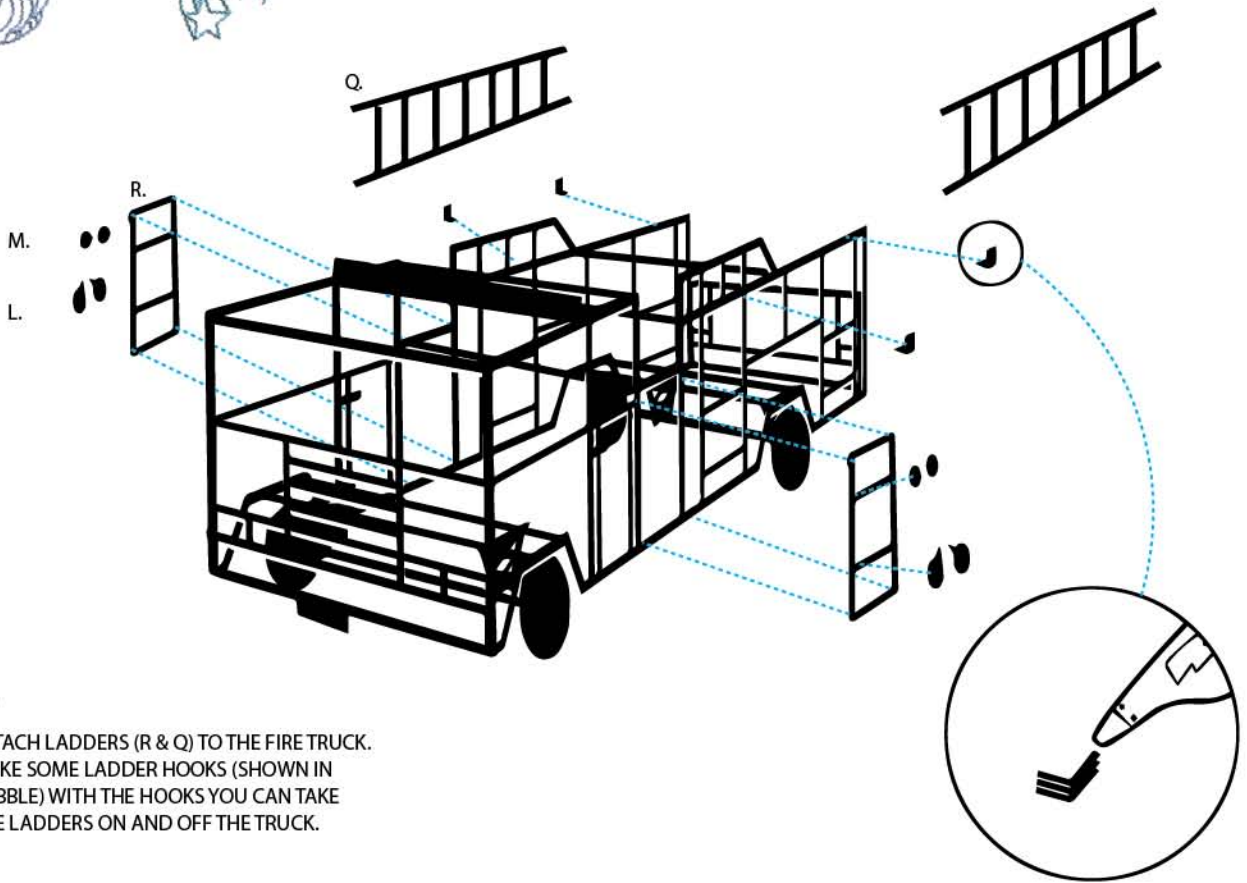

5 ATTACH LADDERS (R & Q) TO THE FIRE TRUCK. MAKE SOME LADDER HOOKS (SHOWN IN BUBBLE) WITH THE HOOKS YOU CAN TAKE THE LADDERS ON AND OFF THE TRUCK.

GOOD JOB!

