

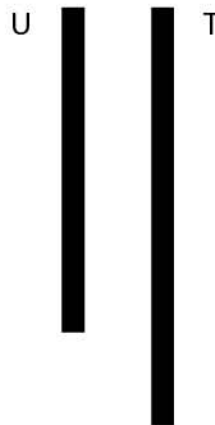

**1**  
 PLACE THE CLEAR SHEET ON TOP OF THESE  
 TEMPLATES AND TRACE PIECES A-Y.

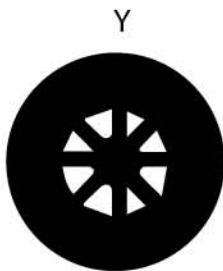
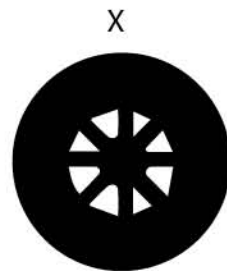
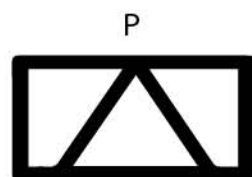
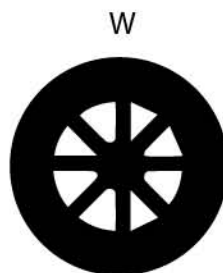
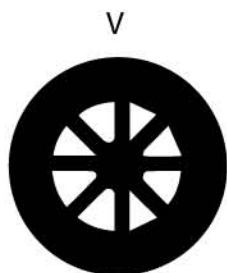
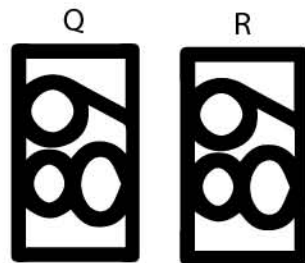
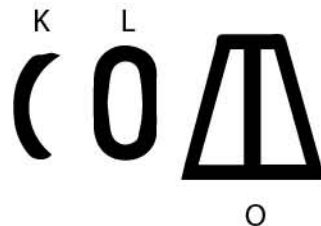
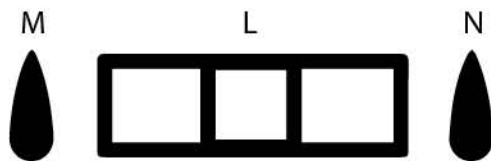
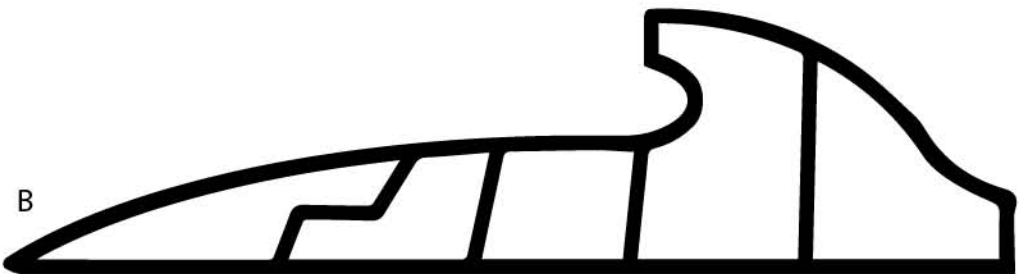
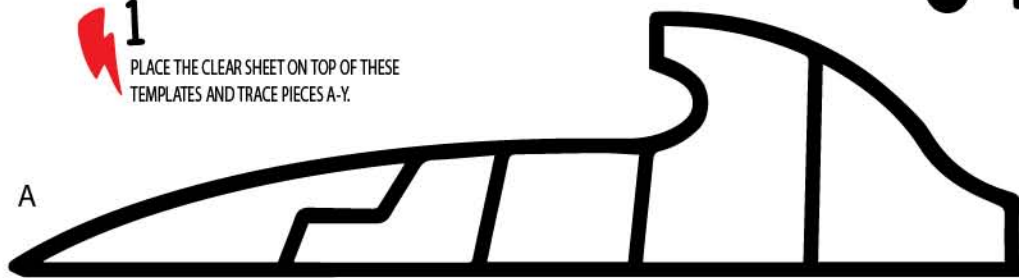

G (x8)

H (x7)



## MAKE A RACE CAR

COPYRIGHT REDWOODVENTURES LTD



**2**  
CONNECT AND BUILD PIECES A-K.

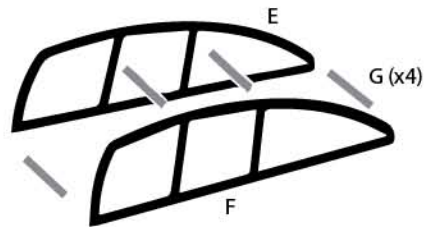
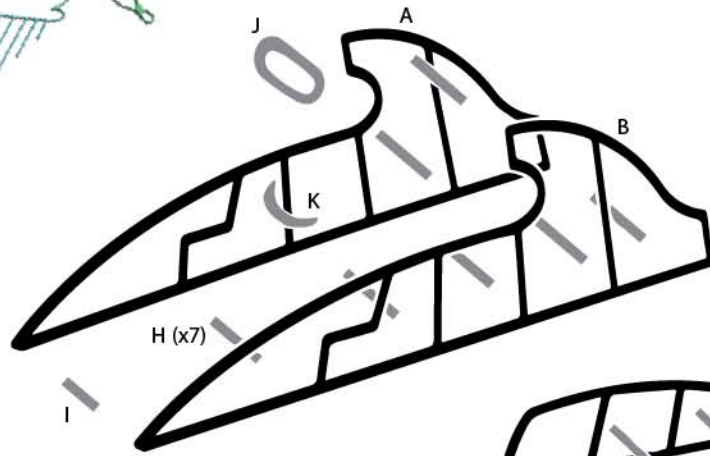
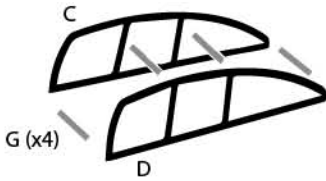

**3**  
CONNECT PIECES L-R.

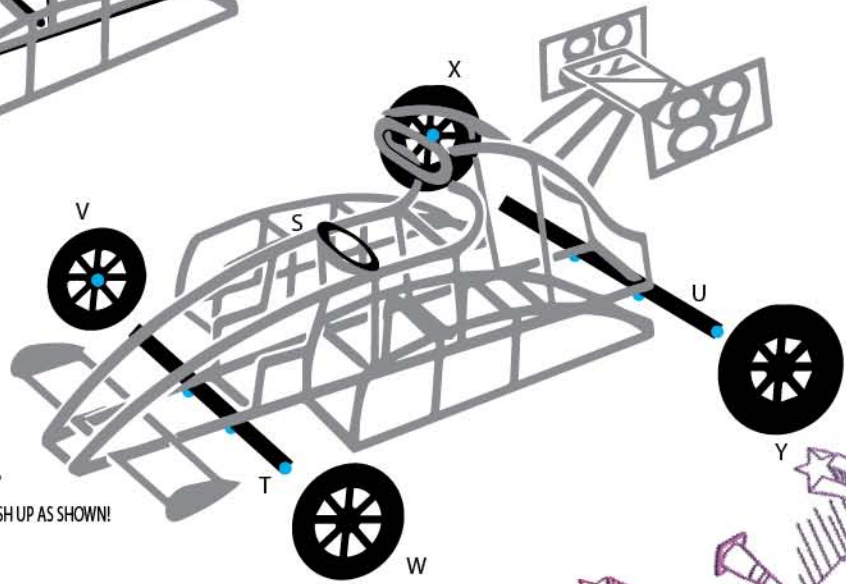
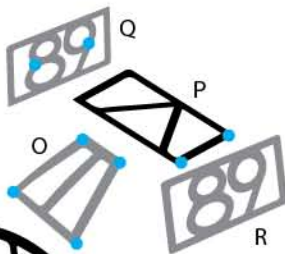
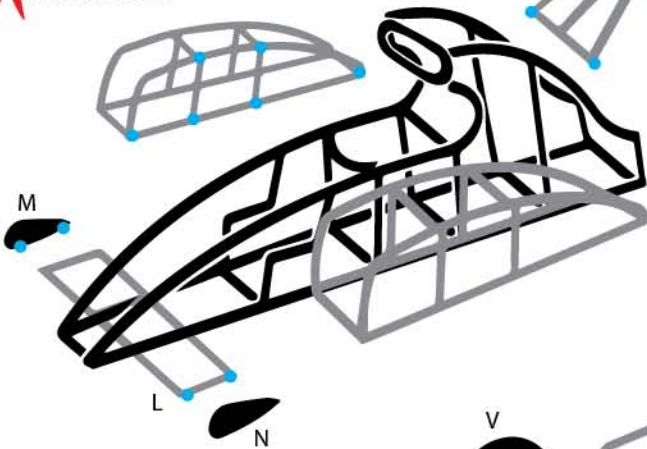

**4**  
FINISH UP AS SHOWN!

