

WARNING

Prior to export of this document, review for export license requirement is needed.

COPYRIGHT NOTICE

Copyright © 1998, 2002 Honeywell International Inc.
All rights reserved.

Reproduction of this publication or any portion thereof by any means without the express written permission of Honeywell International Inc. is prohibited. For further information contact the Manager, Technical Publications; Honeywell; One Technology Center; 23500 West 105th Street; Olathe, Kansas 66061. Telephone: (913) 782-0400.

Revision History and Instructions

Manual KAP 140 Pilot's Guide

Revision 2, May 2002

Part Number 006-18034-0000

This revision makes some of the changes for software version 03/01 more consistent throughout the Pilot's Guide. The affected pages are 9, 12, 13, 55, 58, 83, 86 and 109.

Revision History and Instructions

Manual KAP 140 Pilot's Guide

Revision 1, April 2002

Part Number 006-18034-0000

This revision incorporates changes for software version 03/01.

Revision History and Instructions

Manual KAP 140 Pilot's Guide

Revision 0, June 1998

Part Number 006-18034-0000

This is the original version of this publication.

This page intentionally left blank.

Introduction	1
General Description	2
KAP 140 Single Axis Autopilot System	2
KAP 140 Two Axis Autopilot System	2
KAP 140 Two Axis/Altitude Preselect Autopilot System	2
System Integration	4
Power Application and Preflight Tests	8
KAP 140 Single Axis Operation	9
System Operating Modes	12
Wing Leveler (ROL) Mode	12
Heading Select (HDG) Mode	13
Navigation (NAV) Mode Using a DG from HDG Mode (45° Intercept)	14
Navigation (NAV) Mode Using a DG from ROL Mode (All Angle Intercept)	16
Approach (APR) Mode Using a DG from HDG Mode (45° Intercept)	20
Approach (APR) Mode Using a DG from ROL Mode (All Angle Intercept)	22
Approach (APR) Mode Using an HSI	24
Back Course (REV) Mode Using a DG from HDG Mode (45° Intercept)	26
Back Course (REV) Mode Using a DG from ROL Mode (All Angle Intercept)	28
Back Course (REV) Mode Using an HSI	30
Operations With The KAP 140	32
Takeoff And Climb To Assigned Altitude	32
GPS Capture Using DG	34
GPS Capture Using HSI	36
Outbound On Front Course For Procedure Turn To LOC Approach Using DG	38
Outbound On Front Course For Procedure Turn To LOC Approach Using HSI	40
Front Course LOC Approach Using DG	42
Front Course LOC Approach Using HSI	44
Outbound on GPS Approach Using DG	46
Outbound on GPS Approach Using HSI	48
Inbound on GPS Approach Using DG	50
Inbound on GPS Approach Using HSI	52
KAP 140 Two Axis Operation	55
System Operating Modes	57
Vertical Speed (VS) Mode	58
Altitude Hold (ALT) Mode	59
Operations With The KAP 140	60
Takeoff And Climb To Assigned Altitude	60
GPS Capture Using DG	62

Table of Contents

GPS Capture Using HSI	64
Outbound On Front Course For Procedure Turn To ILS Approach Using DG	66
Outbound On Front Course For Procedure Turn To ILS Approach Using HSI	68
Front Course ILS Approach Using DG	70
Front Course ILS Approach Using HSI	72
Outbound on GPS Approach Using DG	74
Outbound on GPS Approach Using HSI	76
Inbound on GPS Approach Using DG	78
Inbound on GPS Approach Using HSI	80
KAP 140 Two Axis with Altitude Preselect Operation	83
System Operating Modes	86
Vertical Speed (VS) Mode	86
Altitude Hold (ALT) Mode	87
Altitude Alerting and Preselect	88
Altitude Alerter	88
Altimeter Setting	88
Altitude Preselect	89
Voice Messaging	89
Operations With The KAP 140	90
Takeoff And Climb To Assigned Altitude	90
GPS Capture Using DG	92
GPS Capture Using HSI	94
Outbound On Front Course For Procedure Turn To ILS Approach Using DG	96
Outbound On Front Course For Procedure Turn To ILS Approach Using HSI	98
Front Course ILS Approach Using DG	100
Front Course ILS Approach Using HSI	102
Outbound on GPS Approach Using DG	104
Outbound on GPS Approach Using HSI	106
Inbound on GPS Approach Using DG	108
Inbound on GPS Approach Using HSI	110
KCS 55A Compass System	113
KI 525A Indicator	114
Description of Indicator and Display Functions	114
Slaving Meter (KA 51B)	116
KMT 112 Magnetic Slaving Transmitter	117
KG 102A Directional Gyro	117
Abnormal Circumstances	119
Flight Procedures with the KCS 55A	120
Abnormal Procedures	127
Autopilot Malfunction	127

Introduction

The KAP 140 Autopilot System is a rate based digital autopilot system offering smooth performance and enhanced features found only in more expensive autopilots. The first of its type developed by Honeywell, this system brings digital technology and reliability into the light aircraft cockpit.

It is also significant that the KAP 140 series autopilots have been designed from their inception to interface with the Silver Crown package of products. Consider the advantage of having your avionics working together as an integrated system rather than as a group of components built by several manufacturers.

Your new KAP 140 roll axis features include wing leveler, heading select, and VOR/LOC intercept and tracking. The KAP 140 can also be coupled to GPS and RNAV receivers as well. Roll rate information is derived from the turn coordinator. Pitch axis features include vertical speed, glideslope and altitude hold along with the optional altitude preselect. Pitch information is derived from a pressure sensor and accelerometer. The KAP 140 Autopilot System operates independent of the aircraft's artificial horizon. Therefore, the autopilot retains roll stabilization and all vertical modes in the event of vacuum system failure.

Internal monitors keep constant track of the KAP 140's status and provide for automatic shutdown of the autopilot or trim system in the event of a malfunction. In addition to reliability, the KAP 140 is designed to be easily maintained in the field. Qualified Honeywell Service Centers are located around the world to provide assistance whenever necessary.

To fully realize the capability of your new panel mount digital autopilot system, you must understand the performance capabilities and basic operational requirements of the system. This pilot's guide provides information to aid in this and is divided up into six sections. The first section provides general familiarization of each autopilot system including the associated panel mounted displays. The second section describes the KAP 140 Single Axis Autopilot System. The third section describes the KAP 140 Two Axis Autopilot System. The fourth section describes the KAP 140 Two Axis/Altitude Preselect Autopilot System. The fifth section describes the optional KCS 55A slaved compass system. The Sixth section describes abnormal procedures.

General Description

KAP 140 Single Axis Autopilot System

The KAP 140 Single Axis system is an entry level digital panel-mount autopilot, offering lateral modes only with an electric trim option.



KAP 140 Two Axis/Altitude Preselect Autopilot System

The KAP 140 Two Axis system provides both lateral and vertical modes with altitude preselect.

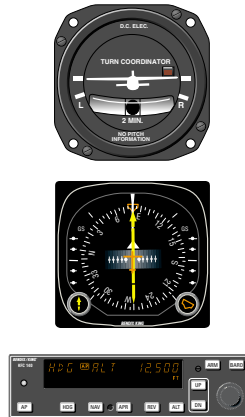

KAP 140 Two Axis Autopilot System

The KAP 140 Two Axis system provides both lateral and vertical modes.



	KAP 140 Two Axis Alt. Preselect	KAP 140 Two Axis	KAP 140 Single Axis
HSI	Optional	Optional	Optional
DG	Standard	Standard	Standard
Turn Coordinator	Standard	Standard	Standard
Automatic Electric Elevator Trim	Optional	Optional	
Manual Electric Trim	Optional	Optional	
FUNCTIONS/MODES			
ALT Hold (ALT)	Yes	Yes	
ALT Preselect/ALERT	Yes		
Heading Select (HDG)	Yes	Yes	Yes
NAV (VOR/RNAV/GPS)	Yes	Yes	Yes
Approach (APR)	Yes	Yes	Yes
Glideslope (GS)	Yes	Yes	
Back Course (REV)	Yes	Yes	Yes
Control Wheel Steering (CWS)	Optional	Optional	Optional
Vertical Speed Hld	Yes	Yes	
Auto Capture	Yes	Yes	Yes
Auto Track	Yes	Yes	Yes
All Angle Intercept	Standard (with DG or optional HSI)	Standard (with DG or optional HSI)	Standard (with DG or optional HSI)
Auto 45-degree Intercept	Standard (with DG only)	Standard (with DG only)	Standard (with DG only)
TEST			
Manual and Auto Trim Monitor	Both	Both	Both
Acceleration Monitor	Yes	Yes	

KAP 140 System Capabilities

System Integration

The individual system diagrams on pages 5, 6, and 7 show the components and their relationship in typical KAP 140 Single Axis, KAP 140 Two Axis, and KAP 140 Two Axis/Altitude Preselect systems. The actual components on individual systems may vary slightly in order to optimize certification and installation requirements.

Each system has a number of inputs: sensor outputs are shown in red; combination inputs are shown in blue; display outputs are shown in orange; and aircraft control shown in green. The systems diagrams reflect that the KAP 140 systems control both pitch and roll axes of the aircraft.

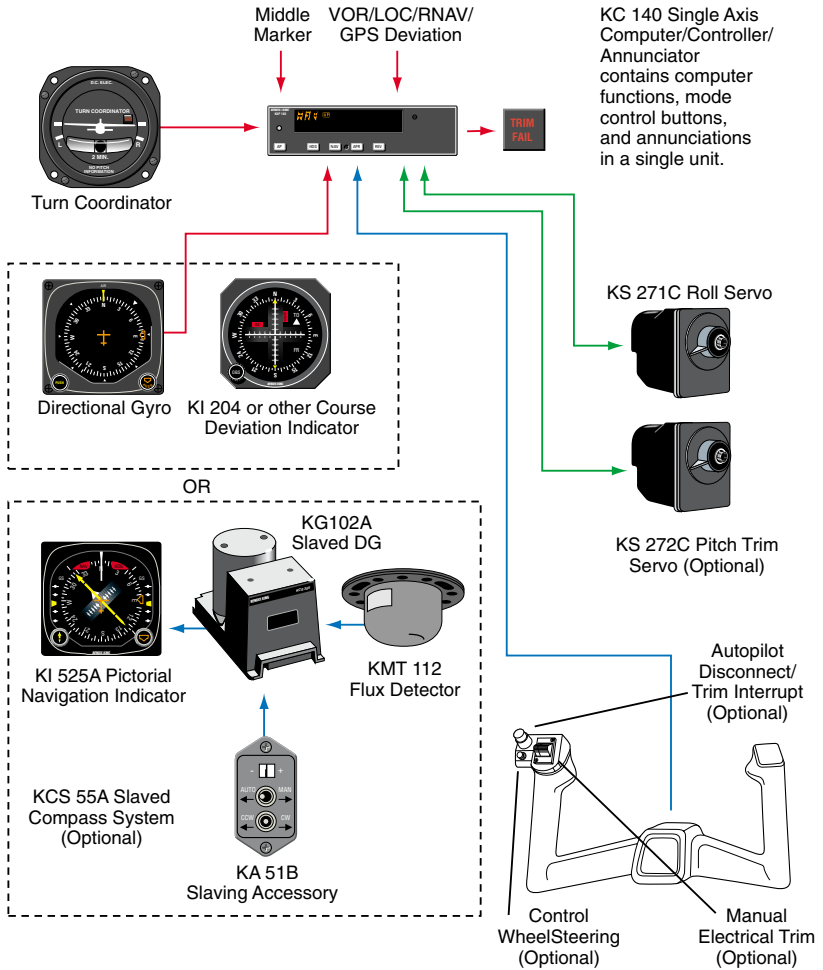

KAP 140 Single Axis System Diagram

Introduction

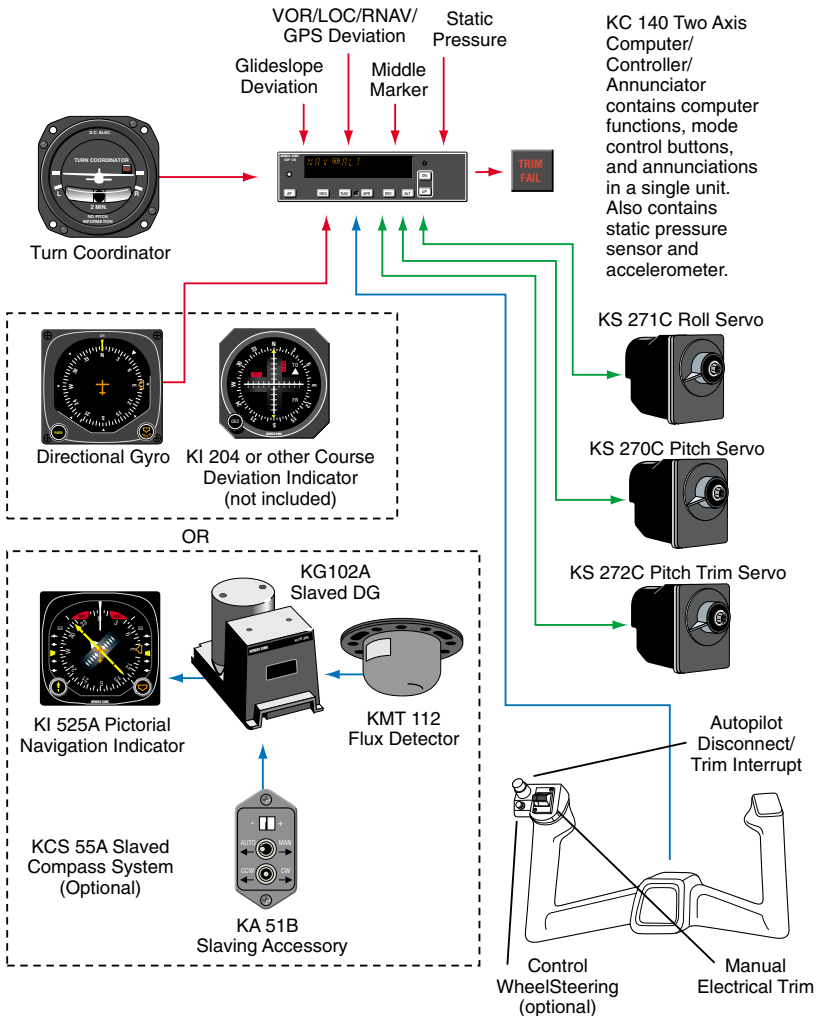

KAP 140 Two Axis System Diagram

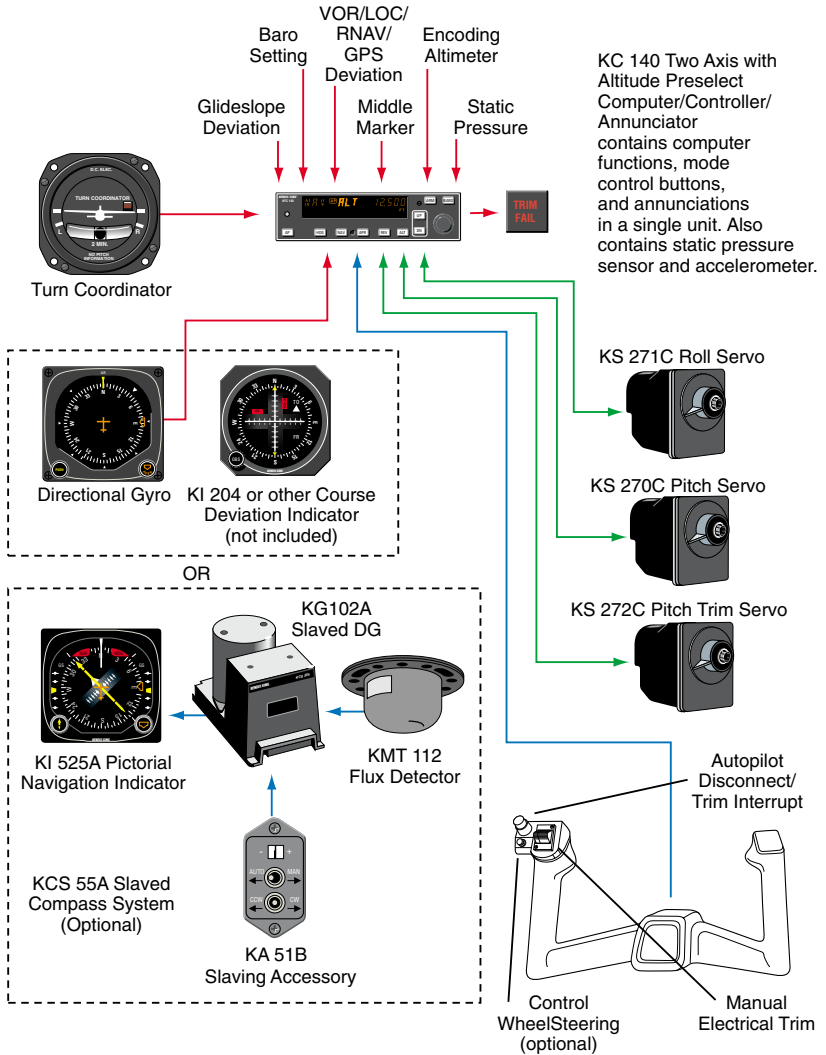

KAP 140 Two Axis/Altitude Preselect System Diagram

Power Application and Preflight Tests



KAP 140 Preflight Test



KAP 140 Preflight Test Complete

A preflight test is performed upon power application to the computer. This test is a sequence of internal checks that validate proper system operation prior to allowing autopilot engagement. The preflight test (PFT) sequence is indicated by “PFT” with an increasing number for the sequence steps. Successful completion of self test is identified by all display segments being illuminated (Display Test) and the disconnect tone sounding.

For two-axis units only:

NOTE: Following the preflight test, the red P warning on the face of the autopilot may illuminate indicating that the pitch axis cannot be engaged. This condition should be temporary, lasting no more than 30 seconds. The P will extinguish and normal operation will be available.

NOTE: The red P warning may illuminate when the autopilot is not engaged. This can occur when autopilot G limits have been exceeded during turbulence or aircraft maneuvering. Autopilot engagement is locked out during red P illumination.

If power to the autopilot is cycled in flight (i.e. through the autopilot circuit breaker for instance) it is possible that a 5 minute delay may be necessary prior to autopilot engagement to allow the pitch axis accelerometer circuit to stabilize. Engagement prior to stabilization may result in mildly erratic pitch axis behavior.

KAP 140 Single Axis Operation

The KAP 140 is a high-performance digital, panel-mounted autopilot system for light aircraft.

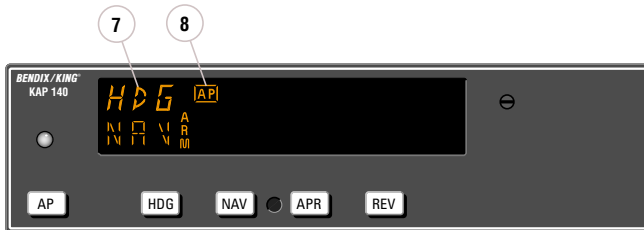

Single-axis Flight Control Computer

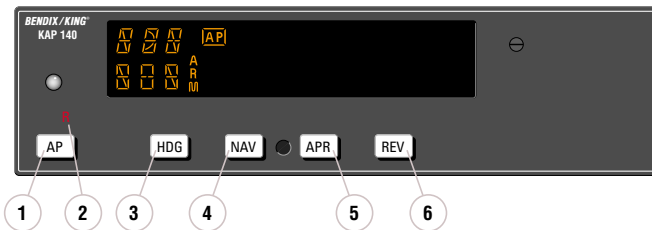

Full Single-axis KAP 140 Display

1. **AUTOPILOT ENGAGE/DISENGAGE (AP) BUTTON** - When pushed, engages autopilot if all logic conditions are met. The autopilot will engage in the basic roll (ROL) mode which functions as a wing leveler. When pressed again, will disengage the autopilot. For software version 03/01 and later, the **AP** button must be pressed and held for 0.25 seconds to engage the autopilot.
2. **ROLL AXIS (R) ANNUNCIATION** - When illuminated, indicates failure of the roll axis and will disengage the autopilot and not allow engagement.
3. **HEADING (HDG) MODE SELECTOR BUTTON** - When pushed, will select the Heading mode, which commands the airplane to turn to

and maintain the heading selected by the heading bug on either the DG or HSI. A new heading may be selected at any time and will result in the airplane turning to the new heading. Button can also be used to toggle between HDG and ROL modes. This button will engage the autopilot in units with software prior to software version 03/01.

4. **NAVIGATION (NAV) MODE SELECTOR BUTTON** - When pushed, will arm the navigation mode. The mode provides automatic beam capture and tracking of VOR, LOC or GPS as selected for presentation on the HSI or CDI. NAV mode is recommended for enroute navigation tracking.

Single Axis Operation

5. **APPROACH (APR) MODE SELECTOR BUTTON** - When pushed, will arm the Approach mode. This mode provides automatic beam capture and tracking of VOR, GPS and LOC, as selected for presentation on the HSI or CDI. APR mode is recommended for instrument approaches.

6. **BACK COURSE APPROACH (REV) MODE SELECTOR BUTTON** - When pushed, will arm the Back Course approach mode. This mode functions similarly to the approach mode except that the autopilot response to LOC signals is reversed.

7. **ROLL MODE DISPLAY** - Displays the active and armed roll modes (ROL, HDG, NAV ARM, NAV, APR ARM, APR, REV ARM, REV). Also displayed will be flashing AP annunciation (5 seconds) at each autopilot disconnect accompanied by an aural tone (for 2 seconds).

8. **AUTOPILOT ENGAGED (AP) ANNUNCIATION** - Illuminates whenever the autopilot is engaged. Flashes during pilot initiated or automatic disengagement. Only applicable for software versions 03/01 or later.

This page intentionally left blank

Single Axis Operation

System Operating Modes



Wing Leveler (ROL) Mode

In the roll mode, the autopilot maintains wings level flight.

1. Engage autopilot - Press **AP**. For software version 03/01 and later, the **AP** button must be pressed and held for 0.25 seconds to engage the autopilot.

NOTE: The KAP 140 engages into ***ROL*** mode as a default.



Heading Select (HDG) Mode

In the heading mode, the autopilot will fly a selected heading. The following steps should be taken to operate in the heading mode:

1. Move the heading “bug” to the desired heading on the DG or HSI using the Heading Select knob.

2. Engage autopilot - Press **AP**. For software version 03/01 and later, the **AP** button must be pressed and held for 0.25 seconds to engage the autopilot.

3. Depress the **HDG** button on the KAP 140 to engage the heading select mode. The autopilot will turn the aircraft in the shortest direction to intercept and fly the heading.

4. If you move the heading “bug” again while the heading select mode is engaged, the autopilot will immediately turn the aircraft in the direction of the newly selected heading.

5. Press **HDG** button again and the autopilot will return to the ROL mode.



Single Axis Operation



Navigation (NAV) Mode Using a DG from HDG Mode (45° Intercept)

In the navigation (NAV) mode, the autopilot intercepts and tracks VOR/RNAV and GPS courses.

To arm NAV mode (with the KAP 140 currently in the HDG mode):

1. Select the desired frequency for VOR or RNAV. For GPS, verify the desired waypoint or destination.
2. OBS Knob - SELECT desired course.
3. NAV Mode Selector Button - PRESS. Note NAV ARM annunciated.



NOTE: When NAV is selected, the autopilot will flash HDG for 5 seconds to remind the pilot to reset the HDG bug to the OBS course. Check the heading displayed on the DG against the magnetic compass and reset if necessary.

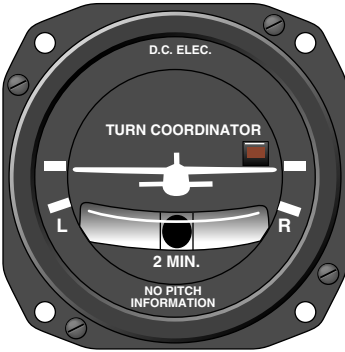

4. Heading Selector Knob - ROTATE BUG to agree with OBS course.

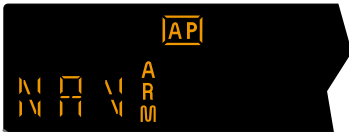

Note Instruments: CDI needle to left. Intercept heading 45° to the left of selected (heading bug) course.

5. If the Course Deviation Bar is greater than 2 to 3 dots: the autopilot will annunciate **NAV ARM**; when the computed capture point is reached the **ARM** annunciator will go out and the selected course will be automatically captured and tracked. If the D-Bar is less than 2 to 3 dots: the **HDG** mode will disengage upon selecting NAV mode; the **NAV** annunciator will illuminate and the capture/track sequence will automatically begin.

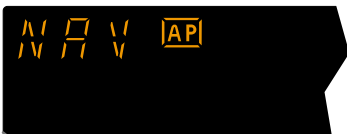

Single Axis Operation



Navigation (NAV) Mode Using a DG from ROL Mode (All Angle Intercept)

In the navigation (**NAV**) mode, the autopilot intercepts and tracks VOR/RNAV and GPS courses.

To arm **NAV** mode (with the KAP 140 currently in the ROL mode):

1. Maneuver the aircraft to the desired intercept angle prior to selecting **ROL** mode.
2. Select the desired frequency for VOR or RNAV. For GPS, verify the desired waypoint or destination.
3. OBS Knob - SELECT desired course.
4. **NAV** Mode Selector Button - PRESS. Note **NAV ARM** annunciated.



*NOTE: When **NAV** is selected, the autopilot will flash **HDG** for 5 seconds to remind the pilot to reset the HDG bug to the OBS course. Check the heading displayed on the DG against the magnetic compass and reset if necessary.*

5. Heading Selector Knob - ROTATE BUG to agree with OBS course.



Note Instruments: CDI needle to left. Intercept heading 30° to the left of selected (heading bug) course.

6. If the Course Deviation Bar is greater than 2 to 3 dots: the autopilot will annunciate **NAV ARM**; when the computed capture point is reached the **ARM** annunciator will go out and the selected course will be automatically captured and tracked. If the D-Bar is less than 2 to 3 dots: the **ROL** mode will disengage upon selecting **NAV** mode; the **NAV** annunciator will illuminate and the capture/track sequence will automatically begin.

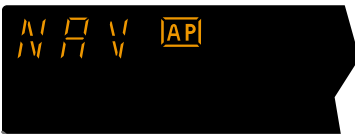

Note: Intercept angles greater than 45° can result in course overshoot when close to the station. Therefore, intercept angles greater than 45° are not recommended.

Single Axis Operation



Navigation (NAV) Mode Using an HSI

In the navigation (**NAV**) mode, the autopilot intercepts and tracks VOR/RNAV and GPS courses.

To arm **NAV** mode (with the KAP 140 currently in the **HDG** mode):

1. Select the desired frequency for VOR or RNAV. For GPS, verify the desired waypoint or destination.
2. Course Bearing Pointer - SET to desired course.
3. Heading Selector Knob - SET BUG to provide desired intercept angle.
4. **NAV** Mode Selector Button - PRESS.
Note **NAV ARM** annunciated.



5. If the Course Deviation Bar is greater than 2 to 3 dots: the aircraft will continue in **HDG** mode (or **ROL** if **HDG** is not selected) with **NAV ARM** annunciated; when the computed capture point is reached **HDG** will disengage, the **ARM** annunciator will go out and the selected course will be automatically captured and tracked. If the D-Bar is less than 2 to 3 dots: the **HDG** mode (or **ROL** if **HDG** is not selected) will disengage upon selecting **NAV** mode; the **NAV** annunciator will illuminate and the capture/ track sequence will automatically begin.

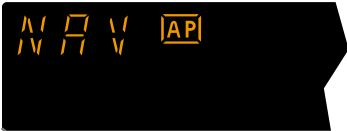

Note: Intercept angles greater than 45° can result in course overshoot when close to the station. Therefore, intercept angles greater than 45° are not recommended.

Single Axis Operation

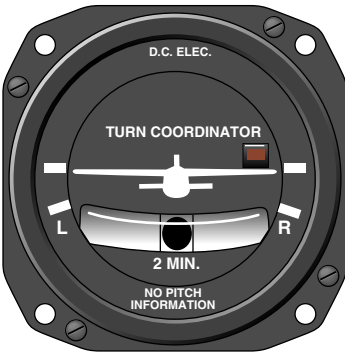

Approach (APR) Mode Using a DG from HDG Mode (45° Intercept)

The Approach (**APR**) mode allows the autopilot to intercept and track LOC, VOR/RNAV and GPS courses.

To arm **APR** mode (with the KAP 140 currently in the HDG mode):

1. Select the desired frequency for LOC, VOR or RNAV. For GPS, verify the desired approach.
2. OBS Knob - **SELECT** desired approach course. (For a localizer, set it to serve as a memory aid.)
3. **APR** Mode Selector Button - **PRESS**. Note **APR ARM** annunciated.



*NOTE: When **APR** is selected, the autopilot will flash **HDG** for 5 seconds to remind the pilot to reset the HDG bug to the desired approach course. Check the heading displayed on the DG against the magnetic compass and reset if necessary.*

4. Heading Selector Knob - ROTATE BUG to agree with desired approach course.

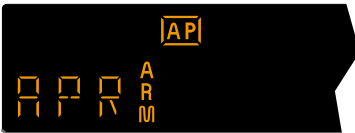

Note Instruments: CDI needle to left. Intercept heading 45° to the left of selected (heading bug) course.

5. If the Course Deviation Bar is greater than 2 to 3 dots: the autopilot will annunciate **APR ARM**; when the computed capture point is reached the **ARM** annunciator will go out and the selected course will be automatically captured and tracked. If the D-Bar is less than 2 to 3 dots: the **HDG** mode will disengage upon selecting **APR** mode; the **APR** annunciator will illuminate and the capture/track sequence will automatically begin.

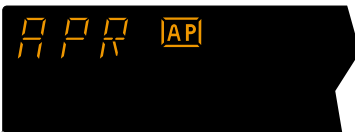

Single Axis Operation



Approach (APR) Mode Using a DG from ROL Mode (All Angle Intercept)

The Approach (**APR**) mode allows the autopilot to intercept and track LOC, VOR/RNAV and GPS courses.

To arm **APR** mode (with the KAP 140 currently in the ROL mode):

1. Maneuver the aircraft to the desired intercept angle prior to selecting **ROL** mode.
2. Select the desired frequency for LOC, VOR or RNAV. For GPS, verify the desired approach.
3. OBS Knob - **SELECT** desired approach course. (For a localizer, set it to serve as a memory aid.)
4. **APR** Mode Selector Button - **PRESS**. Note **APR ARM** annunciated.

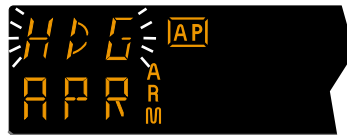
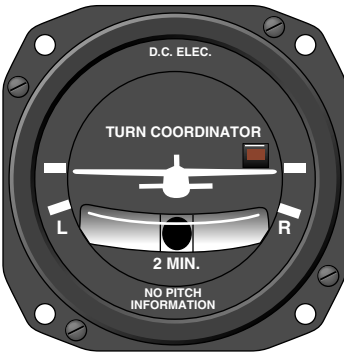

*NOTE: When **APR** is selected, the autopilot will flash **HDG** for 5 seconds to remind the pilot to reset the HDG bug to the desired approach course. Check the heading displayed on the DG against the magnetic compass and reset if necessary.*

5. Heading Selector Knob - ROTATE BUG to agree with desired approach course.



Note Instruments: CDI needle to left. Intercept heading 30° to the left of selected (heading bug) course.

6. If the Course Deviation Bar is greater than 2 to 3 dots: the autopilot will annunciate **APR ARM**; when the computed capture point is reached the **ARM** annunciator will go out and the selected course will be automatically captured and tracked. If the D-Bar is less than 2 to 3 dots: the **ROL** mode will disengage upon selecting **APR** mode; the **APR** annunciator will illuminate and the capture/track sequence will automatically begin.

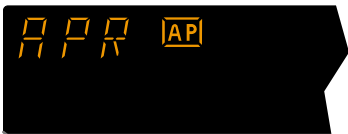

Note: Intercept angles greater than 45° can result in course overshoot when close to the station. Therefore, intercept angles greater than 45° are not recommended.

Single Axis Operation

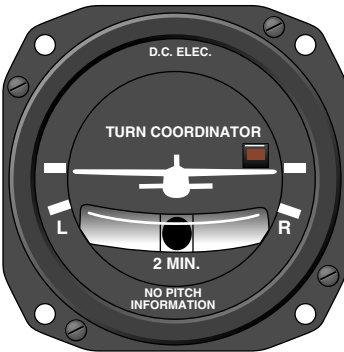

Approach (APR) Mode Using an HSI

The Approach (**APR**) mode allows the autopilot to intercept and track LOC, VOR/RNAV and GPS courses.

To arm **APR** mode (with the KAP 140 currently in the HDG mode):

1. Select the desired frequency for LOC, VOR or RNAV. For GPS, verify the desired approach.
2. Course Bearing Pointer - SET to desired course.
3. Heading Selector Knob - SET BUG to provide desired intercept angle.
4. APR Mode Selector Button - PRESS. Note **APR ARM** annunciated.



5. If the Course Deviation Bar is greater than 2 to 3 dots: the aircraft will continue in **HDG** mode (or **ROL** if **HDG** is not selected) with the **APR ARM** annunciated; when the computed capture point is reached **HDG** mode will disengage, the **ARM** annunciator will go out and the selected course will be automatically captured and tracked. If the D-Bar is less than 2 to 3 dots: the **HDG** mode (or **ROL** if **HDG** is not selected) will disengage upon selecting **APR** mode; the **APR** annunciator will illuminate and the capture/track sequence will automatically begin.

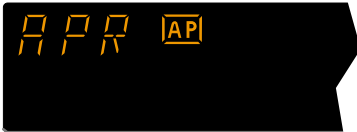

Note: Intercept angles greater than 45° can result in course overshoot when close to the station. Therefore, intercept angles greater than 45° are not recommended.

Single Axis Operation



Back Course (REV) Mode Using a DG from HDG Mode (45° Intercept)

The Back Course (**REV**) mode allows the autopilot to intercept and track a localizer back course.

To arm **REV** mode (with the KAP 140 currently in the HDG mode):

1. Select the desired frequency for LOC.
2. OBS Knob - SELECT front course inbound heading.
3. **REV** Mode Selector Button - PRESS. Note **REV ARM** annunciated.



NOTE: When **REV** is selected, the autopilot will flash **HDG** for 5 seconds to remind the pilot to reset the HDG bug to the front course inbound heading. Check the heading displayed on the DG against the magnetic compass and reset if necessary.

4. Heading Selector Knob - ROTATE BUG to agree with the FRONT COURSE inbound heading.



Note Instruments: CDI needle to the right. Intercept heading 45° to the left of the back course.

5. If the Course Deviation Bar is greater than 2 to 3 dots: the autopilot will annunciate **REV ARM**; when the computed capture point is reached the **ARM** annunciator will go out and the selected course will be automatically captured and tracked. If the D-Bar is less than 2 to 3 dots: the **HDG** mode will disengage upon selecting **REV** mode; the **REV** annunciator will illuminate and the capture/track sequence will automatically begin.



Single Axis Operation



Back Course (REV) Mode Using a DG from ROL Mode (All Angle Intercept)

The Back Course (**REV**) mode allows the autopilot to intercept and track a localizer back course.

To arm **REV** mode (with the KAP 140 currently in the ROL mode):

1. Maneuver the aircraft to the desired intercept angle prior to selecting **ROL** mode.
2. Select the desired frequency for LOC.
3. OBS Knob - SELECT front course inbound heading.
4. **REV** Mode Selector Button - PRESS. Note **REV ARM** annunciated.



*NOTE: When **REV** is selected, the autopilot will flash **HDG** for 5 seconds to remind the pilot to reset the HDG bug to the front course inbound heading. Check the heading displayed on the DG against the magnetic compass and reset if necessary.*

5. Heading Selector Knob - ROTATE BUG to agree with the FRONT COURSE inbound heading.



Note Instruments: CDI needle to the right. Intercept heading 30° to the left of the back course.

6. If the Course Deviation Bar is greater than 2 to 3 dots: the autopilot will annunciate **REV ARM**; when the computed capture point is reached the **ARM** annunciator will go out and the selected course will be automatically captured and tracked. If the D-Bar is less than 2 to 3 dots: the **HDG** mode will disengage upon selecting **REV** mode; the **REV** annunciator will illuminate and the capture/track sequence will automatically begin.

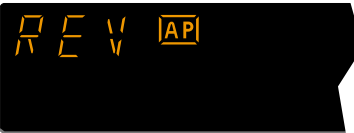

Note: Intercept angles greater than 45° can result in course overshoot when close to the station. Therefore, intercept angles greater than 45° are not recommended.

Single Axis Operation



Back Course (REV) Mode Using an HSI

The Back Course (**REV**) mode allows the autopilot to intercept and track a localizer back course.

To arm **REV** mode (with the KAP 140 currently in the HDG mode):

1. Select the desired frequency for LOC.
2. Course Bearing Pointer - SET to the FRONT COURSE inbound heading.
3. Heading Selector Knob - SET BUG to provide desired intercept angle.
4. **REV** Mode Selector Button - PRESS. Note **REV ARM** annunciated.

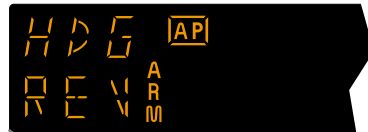

5. If the Course Deviation Bar is greater than 2 to 3 dots: the aircraft will continue in **HDG** mode (or **ROL** if **HDG** is not selected) with the **REV ARM** annunciated; when the computed capture point is reached **HDG** mode will disengage, the **ARM** annunciator will go out and the selected course will be automatically captured and tracked. If the D-Bar is less than 2 to 3 dots: the **HDG** mode (or **ROL** if **HDG** is not selected) will disengage upon selecting **REV** mode; the **REV** annunciator will illuminate and the capture/track sequence will automatically begin.



Note: Intercept angles greater than 45° can result in course overshoot when close to the station. Therefore, intercept angles greater than 45° are not recommended.

Single Axis Operation

OPERATIONS WITH THE KAP 140

Takeoff And Climb To Assigned Altitude

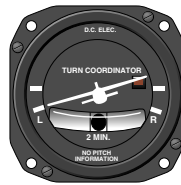
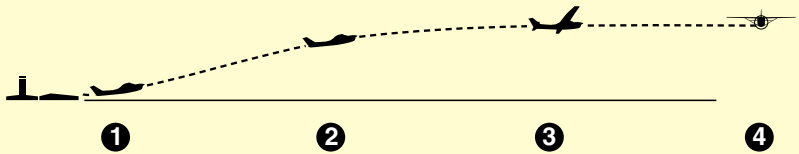

OR



OR



1. The aircraft is well off the ground and established at a desired climb rate.

The heading bug on the DG or HSI is turned to the desired heading of 080° (runway heading).

By depressing the **HDG** button on the KAP 140, the autopilot engages into the heading mode and maintains the selected heading of 080°.

*Note: Press and hold the **AP** button for 0.25 seconds to engage the autopilot (applicable only to software version 03/01 and later).*

2. The heading bug on the DG or HSI is turned to the new desired heading of 010° and the aircraft begins to respond with an immediate left turn.

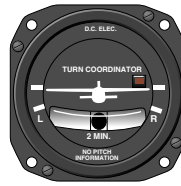
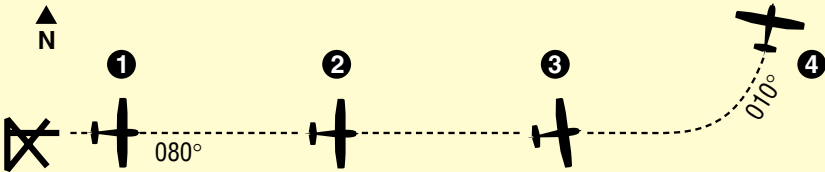

OR



OR



3. The autopilot is responding to the heading select mode with a left bank.

4. The autopilot has completed the turn and is now established on a 010° heading.

Note: The autopilot controls only the roll axis. The PILOT must maintain control of the pitch and yaw axis.

Single Axis Operation

GPS Capture Using DG

* Description of GPS operation based on Bendix/King GPS receiver. Others may require different operation.



1. Continuing on heading 010°, a GPS waypoint is established. A 30° intercept is desired.
2. The **HDG** button is depressed to select **ROL** mode which will allow an “all angle intercept”. GPS data is selected for the CDI and the OBS is set to 040°. The **NAV** button is depressed and **NAV ARM** is annunciated. **ROL** will change to **HDG** and flash for five seconds. **ROL** will then be redisplayed. While the **HDG** annunciation is flashing, move the heading bug to the desired course of 040°. The aircraft will remain wings level until the capture point.

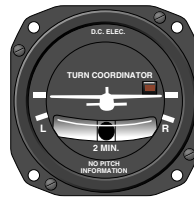
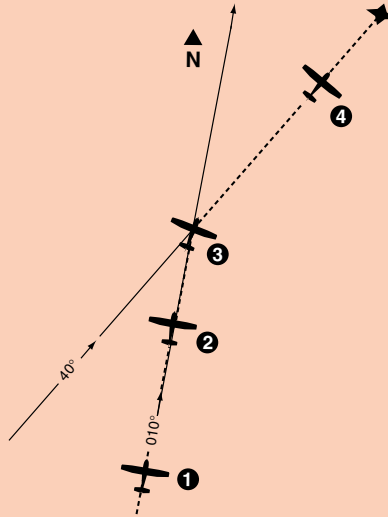

3. When the computed capture point is reached, the **ROL** annunciation changes to **NAV** and a right turn is initiated by the autopilot.

4. The turn is complete and the autopilot is tracking the GPS course.

Single Axis Operation

GPS Capture Using HSI

* Description of GPS operation based on Bendix/King GPS receiver. Others may require different operation.

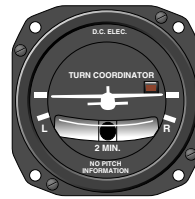

1. Continuing on heading 010°, a GPS waypoint is established. A 30° intercept is desired.
2. GPS data is selected for the HSI. The course pointer is set to 040°. The **NAV** button is depressed and **NAV ARM** is annunciated.

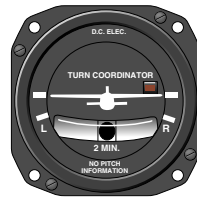
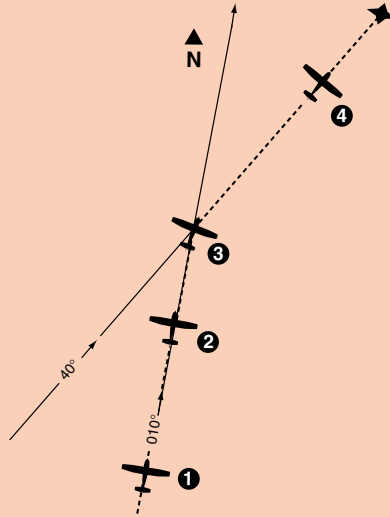

3. When the computed capture point is reached, the **HDG** annunciation changes to **NAV** and a right turn is initiated by the autopilot.

4. The turn is complete and the autopilot is tracking the GPS course.

Single Axis Operation

Outbound On Front Course For Procedure Turn To LOC Approach Using DG

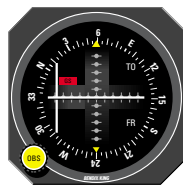
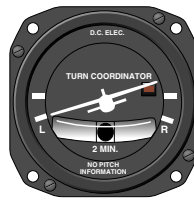
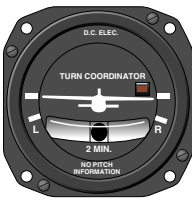

1. The aircraft is heading 270° with heading engaged. To intercept and fly the LOC front course outbound, set the front course on the OBS and depress the back course (**REV**) button. While the **HDG** annunciation is flashing move the heading bug to the front course 058°. Since **HDG** was active upon selection of **REV**, the autopilot will initiate a 45° intercept to the localizer. In this case, the aircraft will turn to 283°.

2. When the computed capture point is reached, auto-intercept mode is cancelled, the reverse localizer mode is automatically activated and a left turn outbound on the localizer is initiated by the autopilot.

Note: The left-right deviations of the CDI course deviation needle are reversed (you must turn right to center a deviation of the index to the left). This needle reversing takes place because you are flying outbound on a front course.

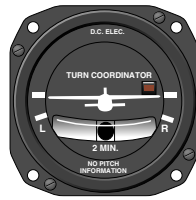
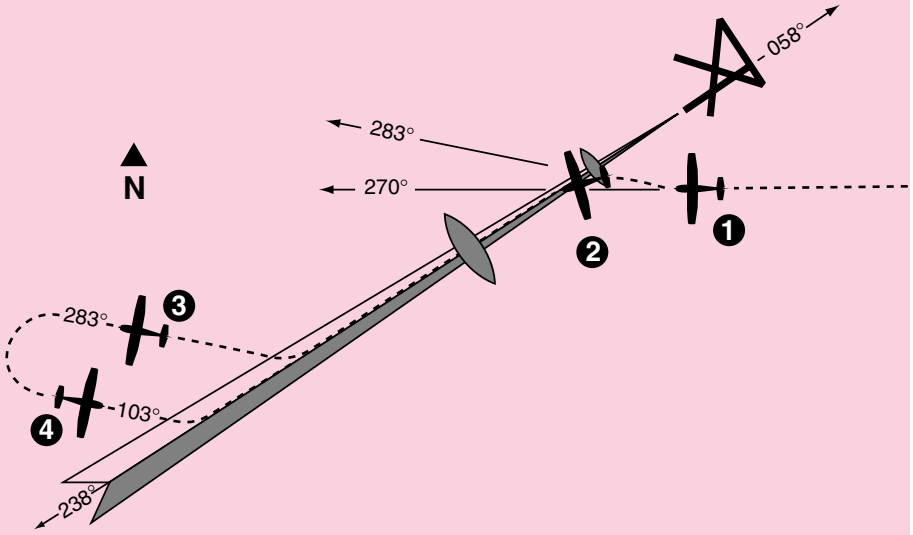

3. At the desired point, **HDG** mode is used to initiate the procedure turn. Select **HDG** and set the heading bug to 283°. During the procedure turn outbound, the CDI course index goes off scale to the right. The aircraft is flying away from the localizer centerline at a 45° angle on a selected heading of 283°.

4. Now you have reset the heading bug to 103° and made a 180° turn to this heading. This 103° heading will intercept the front course of 058°. You must now select the approach mode by depressing the **APR** button on the KAP 140. While the **HDG** annunciation is flashing move the heading bug to the front course 058°. Since the 45° intercept is 103°, the aircraft will not turn until the front course is captured.

* Check the heading displayed on the DG against the magnetic compass and reset if necessary.

Single Axis Operation

Outbound On Front Course For Procedure Turn To LOC Approach Using HSI

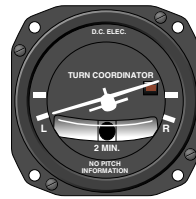
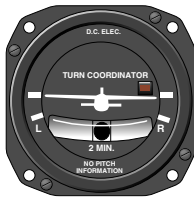

1. The aircraft is heading 270° with heading engaged. To intercept and fly the LOC front course outbound, set the front course on the HSI and depress the back course (**REV**) button. The back course (**REV**) mode is selected to go outbound on the front course. The capture point is now being computed based on closure rate.

2. When the computed capture point is reached, **HDG** mode is cancelled and reverse localizer mode is automatically activated and a left turn outbound on the localizer is initiated by the autopilot.

Note: The left-right deviations of the HSI course needle operate just as though you were flying a front course approach.

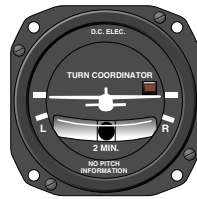
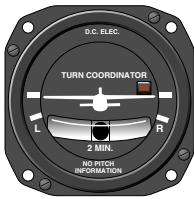
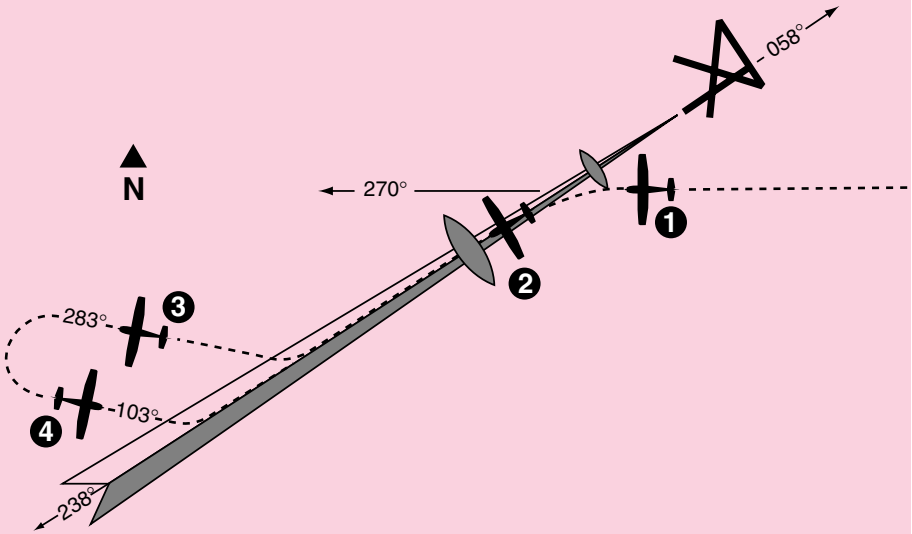

3. At the desired point, **HDG** mode is used to initiate the procedure turn. Select **HDG** and set the heading bug to 283°. During the procedure turn outbound, the deviation bar shows that the aircraft is flying away from the localizer centerline at a 45° angle on a selected heading of 283°.

4. Now you have reset the heading bug to 103° and made a 180° turn to this heading. The 103° heading will intercept the front course of 058°. You must now select the approach mode by depressing the **APR** button on the KAP 140. Automatic capture of the localizer will occur.

Single Axis Operation

Front Course LOC Approach Using DG

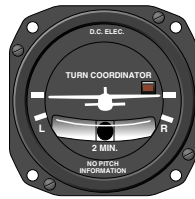
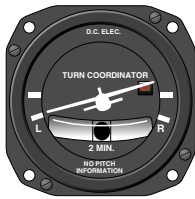

1. Continuing the maneuver on page 38, APR coupling occurs (**HDG** annunciation changes to **APR**). The autopilot will capture the localizer and the CDI course index will center.

2. The autopilot is following the localizer. The autopilot will make the bank changes as necessary to maintain localizer .

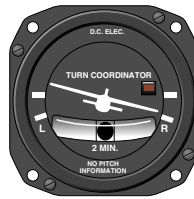
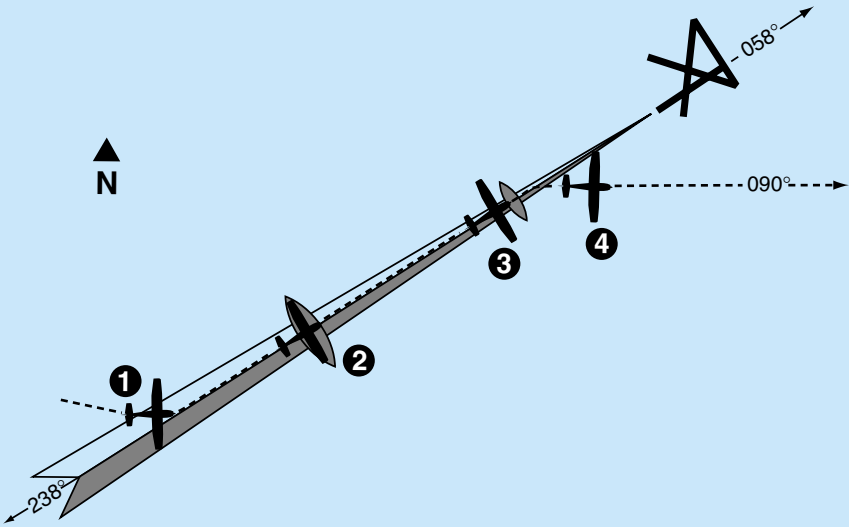

3. At the missed approach point, the pilot disengages the autopilot with the button on the control wheel. This cancels all operating modes. The flashing **AP** annunciations are displayed and a disconnect tone will sound.

4. The pilot initiates the missed approach and stabilizes the aircraft in the climb. The heading bug is set to the missed approach heading of 090°. By depressing the **HDG** button on the KAP 140, the autopilot engages into the heading mode, commencing a right turn to a heading of 090°.

*Note: Press and hold the **AP** button for 0.25 seconds to engage the autopilot (applicable only to software version 03/01 and later).*

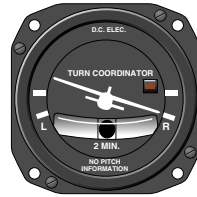
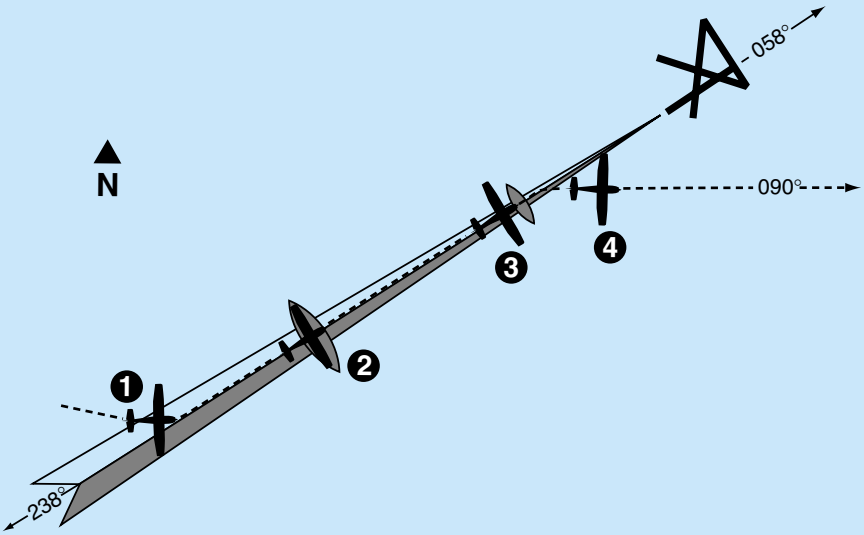

3. At the missed approach point, the pilot disengages the autopilot with the button on the control wheel. This cancels all operating modes.

4. The pilot initiates the missed approach and stabilizes the aircraft in the climb. The heading bug is set to the missed approach heading of 090°. By depressing the **HDG** button on the KAP 140, the autopilot engages into the heading mode, commencing a right turn to a heading of 090°.

*Note: Press and hold the **AP** button for 0.25 seconds to engage the autopilot (applicable only to software version 03/01 and later).*

Single Axis Operation

Outbound on GPS Approach Using DG

* Description of GPS operation based on Bendix/King GPS receiver. Others may require different operation.



1. The aircraft is in **APR** mode approaching the IAF. Approach arm is indicated on the GPS annunciator.*

2. Upon waypoint alerting at the IAF, the heading bug is set to 238°, the GPS's Leg/OBS mode switching is set to OBS mode and the OBS is set to 238°. The autopilot initiates a left turn to track the 238° GPS course.

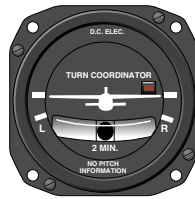
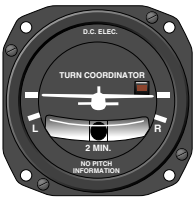
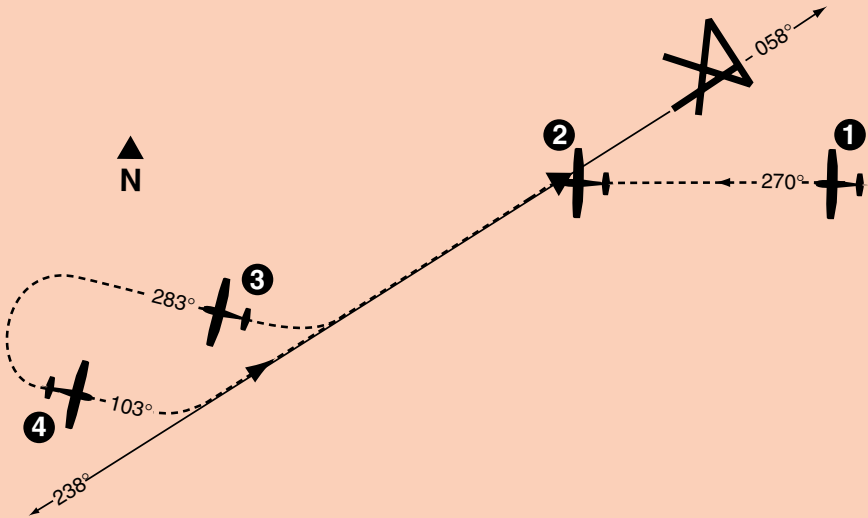

3. At the desired point, heading mode is used to initiate the procedure turn. During the procedure turn outbound, the deviation bar shows that the aircraft is flying away from the GPS course at a 45° angle on a selected heading of 283°.

4. The heading bug has been set to 103° and the aircraft has made a left turn to this heading. The GPS's Leg/OBS mode switching is set to Leg mode and the OBS is set to 058°. Select approach mode by depressing the **APR** button.

* Check the heading displayed on the DG against the magnetic compass and reset if necessary.

*The **HDG** annunciation will flash for five seconds then extinguish. While the **HDG** annunciation is flashing, move the heading bug to 058°. Since the 45° intercept is 103°, the aircraft will not turn until the course is captured.

Single Axis Operation

Outbound on GPS Approach Using HSI

* Description of GPS operation based on Bendix/King GPS receiver. Others may require different operation.



1. The aircraft is in **APR** mode approaching the IAF. Approach arm is indicated on the GPS annunciator.*
2. Upon waypoint alerting at the IAF, the course pointer is set to 238°, the GPS's Leg/OBS mode switching is set to OBS mode. The autopilot initiates a left turn to track the 238° GPS course.

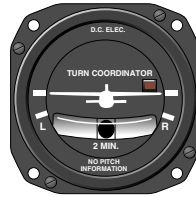
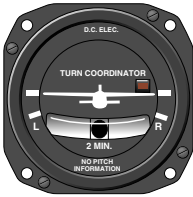
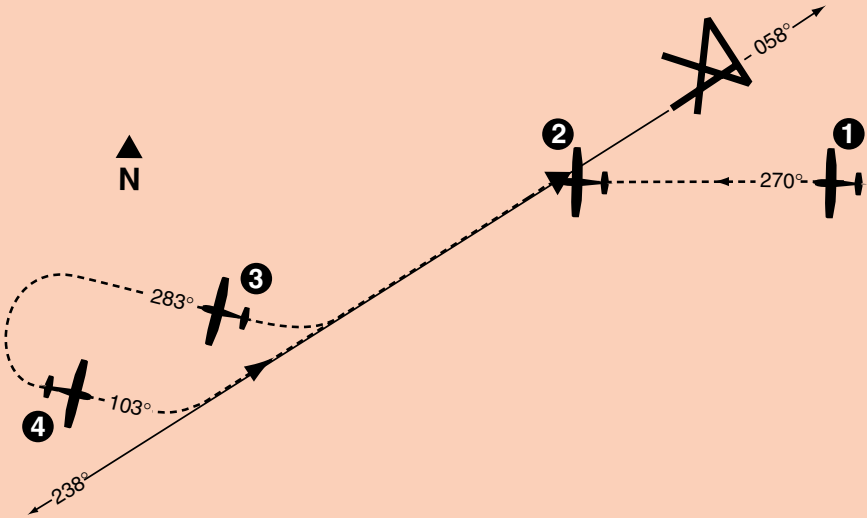

3. At the desired point, heading mode is used to initiate the procedure turn. During the procedure turn outbound, the deviation bar shows that the aircraft is flying away from the GPS course at a 45° angle on a selected heading of 283°.

4. The heading bug has been set to 103° and the heading bug has been set to 103° and the aircraft has made a left turn to this heading. The GPS's Leg/OBS mode switching is set to Leg mode and the course pointer is set to 103°. Select approach mode by depressing the **APR** button.

Single Axis Operation

Inbound on GPS Approach Using DG

* Description of GPS operation based on Bendix/King GPS receiver. Others may require different operation.

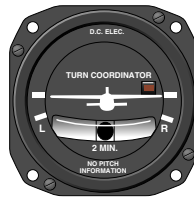

1. Continuing the maneuver on page 46, **APR** mode capture occurs. The autopilot initiates a left turn to track the 058° GPS course. Approach active is indicated on the GPS annunciator.*
2. The autopilot is following the GPS course. The autopilot will make the bank changes as necessary to maintain the GPS course.

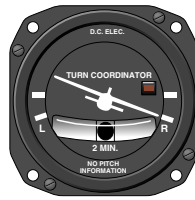
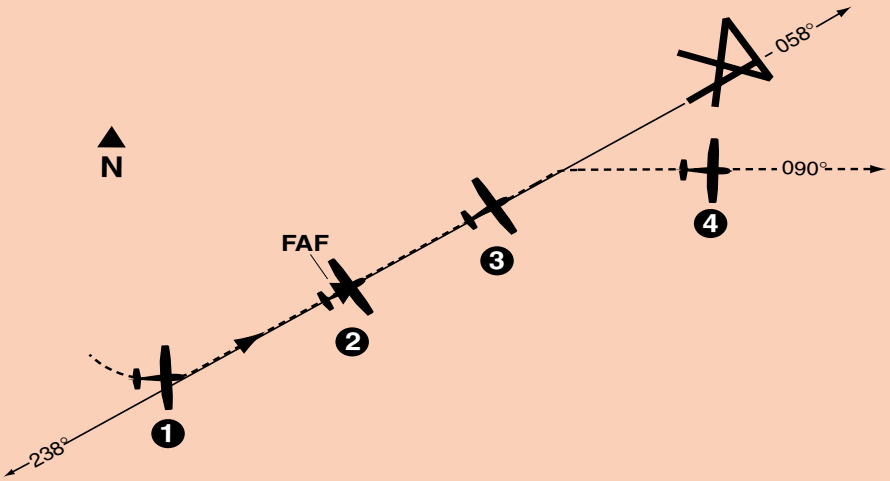

3. At the missed approach point, the pilot disengages the autopilot with the button on the control wheel. This cancels all operating modes. The flashing **AP** annunciations are displayed and a disconnect tone will sound.

4. The pilot initiates the missed approach and stabilizes the aircraft in the climb. The heading bug is set to the missed approach heading of 090°. By depressing the HDG button on the KAP 140, the autopilot engages into the heading mode, commencing a right turn to a heading of 090°.

*Note: Press and hold the **AP** button for 0.25 seconds to engage the autopilot (applicable only to software version 03/01 and later).*

Single Axis Operation

Inbound on GPS Approach Using HSI

* Description of GPS operation based on Bendix/King GPS receiver. Others may require different operation.

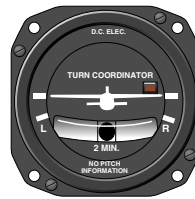
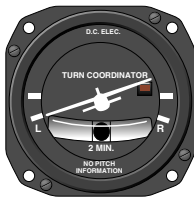

1. Continuing the maneuver on page 48, **APR** mode capture occurs. The autopilot initiates a left turn to track the 058° GPS course.* Approach active is indicated on the GPS annunciator.*
2. The autopilot is following the GPS course. The autopilot will make the bank changes as necessary to maintain the GPS course.

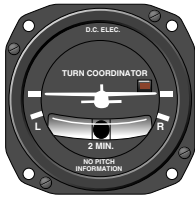
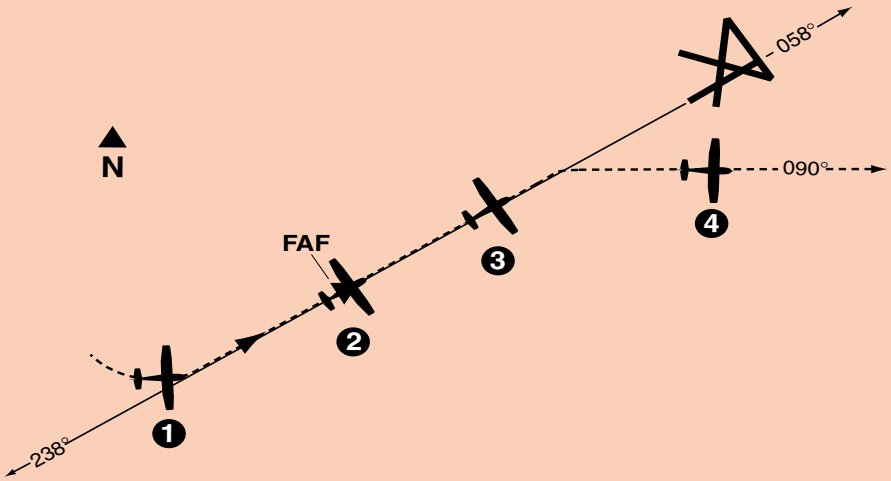

3. At the missed approach point, the pilot disengages the autopilot with the button on the control wheel. This cancels all operating modes. The flashing **AP** annunciations are displayed and a disconnect tone will sound.

4. The pilot initiates the missed approach and stabilizes the aircraft in the climb. The heading bug is set to the missed approach heading of 090°. By depressing the **HDG** button on the KAP 140, the autopilot engages into the heading mode, commencing a right turn to a heading of 090°.

*Note: Press and hold the **AP** button for 0.25 seconds to engage the autopilot (applicable only to software version 03/01 and later).*

This page intentionally left blank

KAP 140 Two Axis Operation

The KAP 140 is a digital, panel-mounted autopilot system for light aircraft.

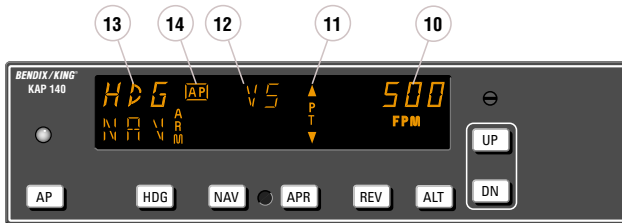

Two-axis Flight Control Computer

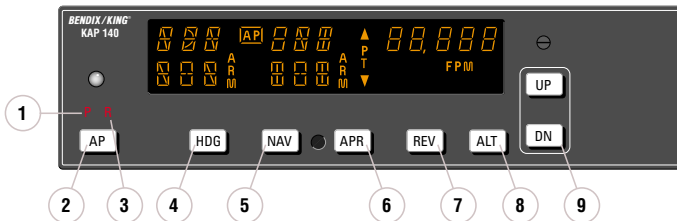

Full Two-Axis KAP 140 Display

1. PITCH AXIS, (P) ANNUNCIATOR
- When illuminated, indicates failure of the pitch axis and will disengage the autopilot when the failure occurs and not allow engagement of the pitch axis.

2. AUTOPILOT ENGAGE/DISENGAGE (AP) BUTTON - When pushed, engages autopilot if all logic conditions are met. The autopilot will engage in the basic roll (ROL) mode which functions as a wing leveler and in the vertical speed (VS) hold mode. The commanded vertical speed will be displayed in the upper right corner of autopilot display area. The captured VS will be the vertical speed present at the moment of AP button press. When pressed again, will disengage the autopilot. For software version 03/01

and later, the **AP** button must be pressed and held for 0.25 seconds to engage the autopilot.

3. ROLL AXIS (R) ANNUNCIATOR
- When illuminated, indicates failure of the roll axis and will disengage the autopilot and not allow engagement.

4. HEADING (HDG) MODE SELECTOR BUTTON - When pushed, will arm the Heading mode, which commands the airplane to turn to and maintain the heading selected by the heading bug on either the DG or HSI. A new heading may be selected at any time and will result in the airplane turning to the new heading. Button can also be used to toggle between HDG and ROL modes. This button will engage the autopilot in units with software prior to software version 03/01.

Two Axis Operation

5. **NAVIGATION (NAV) MODE SELECTOR BUTTON** - When pushed, will arm the navigation mode. The mode provides automatic beam capture and tracking of VOR, LOC or GPS as selected for presentation on the HSI or CDI. NAV mode is recommended for enroute navigation tracking. NAV mode may also be used for front course LOC tracking when GS tracking is not desired.

6. **APPROACH (APR) MODE SELECTOR BUTTON** - When pushed, will arm the Approach mode. This mode provides automatic beam capture and tracking of VOR, GPS, LOC, and Glideslope (GS) on an ILS, as selected for presentation on the HSI or CDI. APR mode is recommended for instrument approaches.

7. **BACK COURSE APPROACH (REV) MODE SELECTOR BUTTON** - When pushed, will arm the Back Course approach mode. This mode functions similarly to the approach mode except that the autopilot response to LOC signals is reversed, and GS is disabled.

8. **ALTITUDE HOLD (ALT) MODE SELECT BUTTON** - When pushed, will select the Altitude Hold mode. This mode provides tracking of the reference altitude. The reference altitude is the altitude at the moment the ALT button is pressed. If the ALT button is pressed with an established VS rate present, there will be altitude overshoot (approximately

10% of the VS rate), with the airplane returned positively to the reference altitude. This button will engage the autopilot in units with software prior to software version 03/01.

9. **VERTICAL TRIM (UP/DN) BUTTONS** - The action of these buttons is dependent upon the vertical mode present when pressed. If VS mode is active, button strokes will increment the vertical speed commanded either up or down at the rate of 100 ft/min per button press, or at the rate of approximately 300 ft/min per second if held continuously. If ALT mode is active, incremental button strokes will move the altitude hold reference altitude either up or down at 20 feet per press, or if held continuously will command the airplane up or down at the rate of 500 ft/min, synchronizing the altitude hold reference to the actual airplane altitude upon button release.

10. **VERTICAL SPEED DISPLAY** - Displays the commanded vertical speed in VS mode.

11. **PITCH TRIM (PT) ANNUNCIATION** - A flashing PT with arrows indicates the direction of required pitch trim. A solid PT without an arrow head is an indication of a pitch trim fault. During manual electric trim operation (autopilot disengaged), detection of a stuck MET switch will be indicated by a solid PT. When the fault is corrected, the annunciation will extinguish.

12. PITCH MODE DISPLAY - Displays the active and armed pitch modes (VS, ALT ARM, ALT, and GS).

13. ROLL MODE DISPLAY - Displays the active and armed roll modes (ROL, HDG, NAV ARM, NAV, APR ARM, APR, REV ARM, REV, GS ARM). Also displayed will be flashing AP annunciation (5 seconds) at each autopilot disconnect accompanied by an aural tone (for 2 seconds).

14. AUTOPILOT ENGAGED (**AP**) ANNUNCIATION - Illuminates whenever the autopilot is engaged. Flashes during pilot initiated or automatic disengagement. Only applicable for software versions 03/01 or later.

System Operating Modes

The lateral modes (HDG, NAV, APR and REV) operate identically as described in the KAP 140 Single Axis Operating Modes section. Please refer to that section for text descriptions of lateral mode operation.

Two Axis Operation



Vertical Speed (VS) Mode

The Vertical Speed (**VS**) mode allows variable vertical speed climbs and descents. The **ALT** button toggles between altitude hold and vertical speed modes.

*Note: The KAP 140 engages into **VS** mode as a default.*

To operate in the **VS** mode (with autopilot currently disengaged):

1. **AP** button - Press. Note **ROL**, **VS** and current vertical speed is displayed. If no other modes are selected the autopilot will operate in the **ROL** and vertical speed hold modes. For software version 03/01 and later, the **AP** button must be pressed and held for 0.25 seconds to engage the autopilot.
2. **UP** or **DN** button - Select desired climb or descent rate. Each button stroke will increment the vertical speed commanded up or down by 100 ft/min per button press, or at the rate of approximately 300 ft/min per second if held continuously.

To initiate a climb or descent from Altitude Hold (**ALT**) mode:

1. **ALT** button - Press. Note **ALT** changes to **VS** and current vertical speed is displayed.
2. **UP** or **DN** button - Select desired climb or descent rate. Each button stroke will increment the vertical speed commanded up or down by 100 ft/min per button press, or at the rate of approximately 300 ft/min per second if held continuously.

Note: When operating at or near the best rate of climb airspeed, at climb power settings, and using vertical speed hold, it is easy to decelerate to an airspeed where continued decreases in airspeed will result in a reduced rate of climb. Continued operation in vertical speed mode can result in a stall.



Altitude Hold (ALT) Mode

The Altitude Hold (**ALT**) mode maintains the pressure altitude acquired upon selection of altitude hold. The **ALT** button toggles between altitude hold and vertical speed modes.

To operate in the **ALT** mode (with autopilot currently in the Vertical Speed mode):

1. **ALT** button - Press. Note **ALT** is annunciated and autopilot maneuvers to maintain pressure altitude acquired at button selection.
2. **UP** or **DN** button - Select to change altitude. Incremented button strokes will move the reference altitude by 20 feet per press, or if held continuously will command a 500 ft/min altitude change, acquiring a new reference altitude upon button release.

Note: Incremented altitude changes should be limited to 500 ft. of change.

Two Axis Operation

OPERATIONS WITH THE KAP 140

Takeoff And Climb To Assigned Altitude

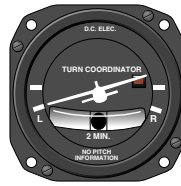
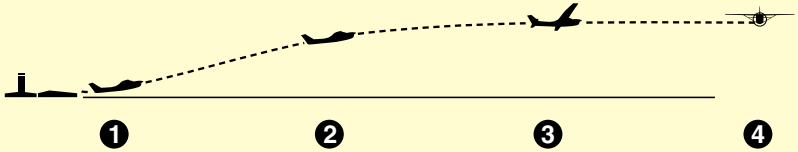

OR



OR



1. The aircraft is well off the ground and established at a safe climb rate.

The heading bug on the DG or HSI is turned to the desired heading of 080° (runway heading).

By depressing the **HDG** button on the KAP 140, the autopilot engages into the heading and vertical speed modes and maintains the selected heading of 080° and current rate of climb.

*Note: Press and hold the **AP** button for 0.25 seconds to engage the autopilot (applicable only to software version 03/01 and later).*

2. The heading bug on the DG or HSI is turned to the new desired heading of 010° and the aircraft begins to respond with an immediate left turn.

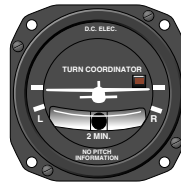
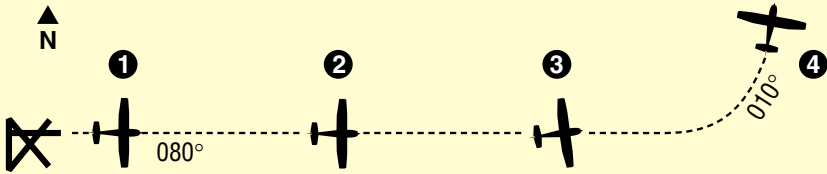

OR



OR



3. The autopilot is responding to the heading select mode with a left bank. The climb rate has been decreased, using the **DN** button, in preparation for level off.

4. The autopilot has completed the turn and is now established on a 010° heading. Desired altitude has been reached, altitude hold (**ALT**) has been engaged and the aircraft maintains the reference altitude.

Two Axis Operation

GPS Capture Using DG

* Description of GPS operation based on Bendix/King GPS receiver. Others may require different operation.



1. Continuing on heading 010°, a GPS waypoint is established. A 30° intercept is desired.

2. The **HDG** button is depressed to select **ROL** mode which will allow an “all angle intercept”. GPS data is selected for the CDI and the OBS is set to 040°. The **NAV** button is depressed and **NAV ARM** is annunciated. **ROL** will change to **HDG** and flash for five seconds. **ROL** will then be redisplayed. While the **HDG** annunciation is flashing, move the heading bug to the desired course of 040°. The aircraft will remain wings level until the capture point.

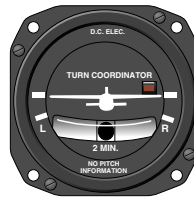
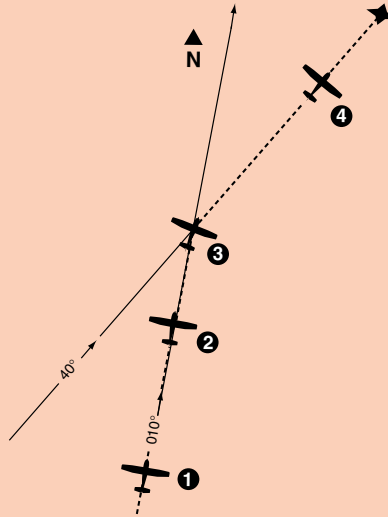

3. When the computed capture point is reached, the **ROL** annunciation changes to **NAV** and a right turn is initiated by the autopilot.

4. The turn is complete and the autopilot is tracking the GPS course.

Two Axis Operation

GPS Capture Using HSI

* Description of GPS operation based on Bendix/King GPS receiver. Others may require different operation.

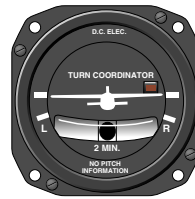

1. Continuing on heading 010°, a GPS waypoint is established. A 30° intercept is desired.
2. GPS data is selected for the HSI. The course pointer is set to 040°. The **NAV** button is depressed and **NAV ARM** is annunciated.

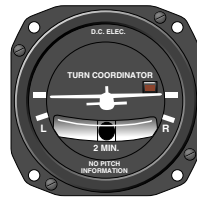
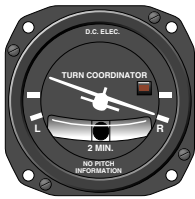
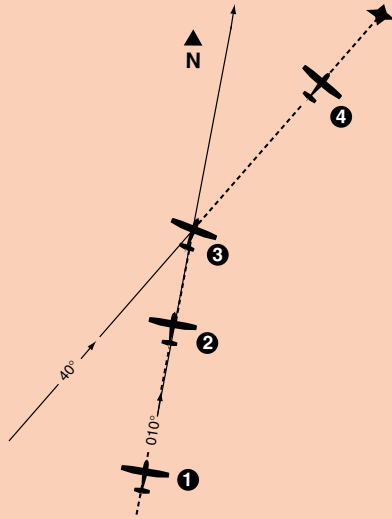

3. When the computed capture point is reached, the **HDG** annunciation changes to **NAV** and a right turn is initiated by the autopilot.

4. The turn is complete and the autopilot is tracking the GPS course.

Two Axis Operation

Outbound On Front Course For Procedure Turn To ILS Approach Using DG

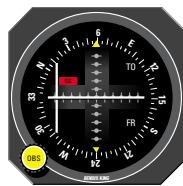
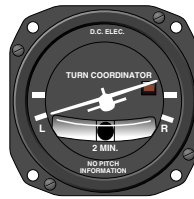

1. The aircraft is heading 270° with heading and altitude hold engaged. To intercept and fly the ILS front course outbound, set the front course on the OBS and depress the reverse course (**REV**) button. The **HDG** annunciation will flash for five seconds then extinguish. While the **HDG** annunciation is flashing, move the heading bug to the front course 058°. Since **HDG** was active upon selection of **REV**, the autopilot will initiate a 45° intercept to the localizer. In this case, the aircraft will turn to 283°.

2. When the computed capture point is reached, auto-intercept mode is cancelled and reverse localizer mode is automatically activated and a left turn outbound on the localizer is initiated by the autopilot.

Note: The left-right deviations of the CDI course deviation needle are reversed (you must turn right to center a deviation of the index to the left). This needle reversing takes place because you are flying outbound on a front course.

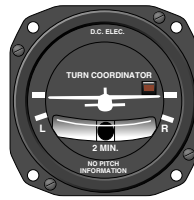
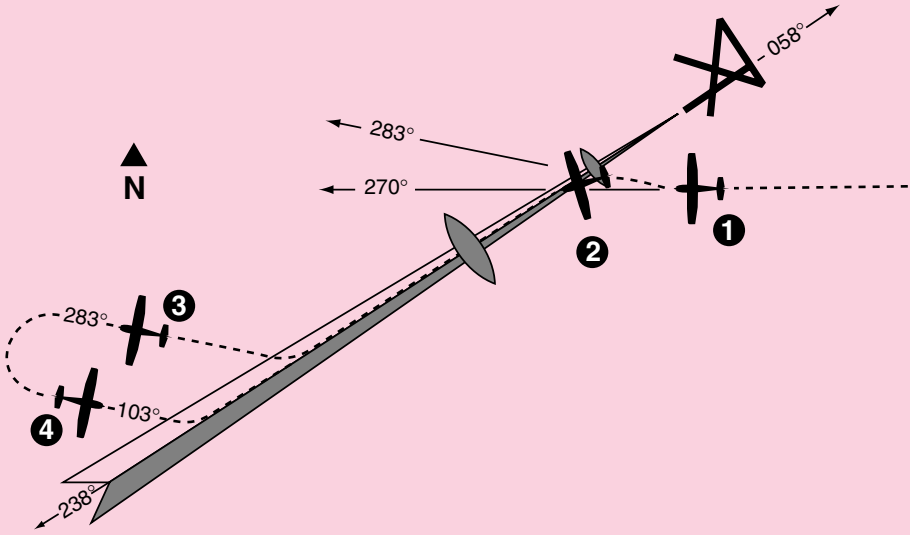

3. At the desired point, **HDG** mode is used to initiate the procedure turn. Select **HDG** and set the heading bug to 283°. During the procedure turn outbound, the CDI course index goes off scale to the right. The aircraft is flying away from the localizer centerline at a 45° angle on a selected heading of 283°.

4. Now you have reset the heading bug to 103° and made a 180° turn to this heading. This 103° heading will intercept the front course of 058°. You must now select the approach mode by depressing the **APR** button on the KAP 140.

* The **HDG** annunciation will flash for five seconds then extinguish. While the **HDG** annunciation is flashing, move the heading bug to the front course 058°. Since the 45° intercept is 103°, the aircraft will not turn until the front course is captured.

* Check the heading displayed on the DG against the magnetic compass and reset if necessary.

Two Axis Operation

Outbound On Front Course For Procedure Turn To ILS Approach Using HSI

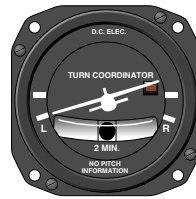
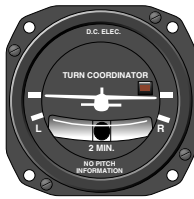

1. The aircraft is heading 270° with heading and altitude hold engaged. To intercept and fly the ILS front course outbound, set the front course on the HSI and depress the back course (**REV**) button. The back course (**REV**) mode is selected to go outbound on the front course. The capture point is now being computed based on closure rate.

2. When the computed capture point is reached, **HDG** mode is cancelled and reverse localizer mode is automatically activated and a left turn outbound on the localizer is initiated by the autopilot.

Note: The left-right deviations of the HSI course needle operate just as though you were flying a front course approach.

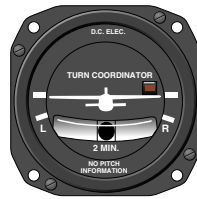
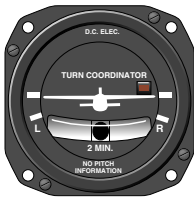
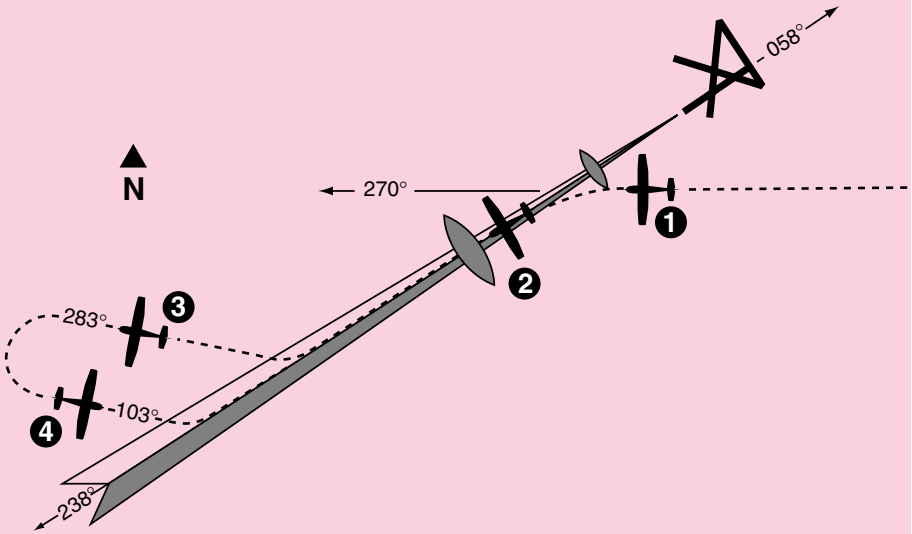

3. At the desired point, **HDG** mode is used to initiate the procedure turn. Select **HDG** and set the heading bug to 283°. During the procedure turn outbound, the deviation bar shows that the aircraft is flying away from the localizer centerline at a 45° angle on a selected heading of 283°.

4. Now you have reset the heading bug to 103° and made a 180° turn to this heading. The 103° heading will intercept the front course of 058°. You must now select the approach mode by depressing the **APR** button on the KAP 140. Automatic capture of the localizer will occur.

Two Axis Operation

Front Course ILS Approach Using DG

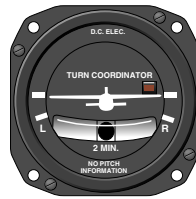
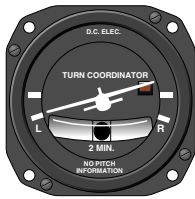
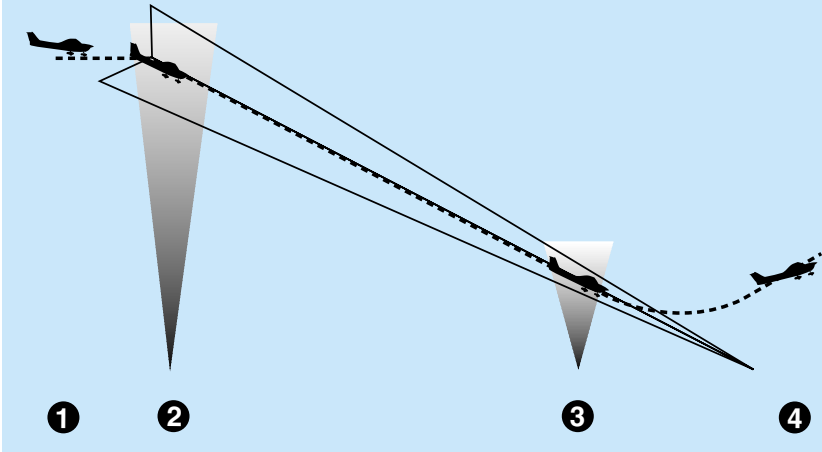

1. Continuing the maneuver on page 66, APR coupling occurs (**HDG** annunciation changes to **APR**), and the glideslope mode is automatically armed. The autopilot will capture the localizer and the CDI course index will center.

2. The autopilot is following the localizer. At the outer marker, the glideslope deviation needle is at midscale. Altitude hold is automatically disengaged when the glideslope is captured. The **ALT** annunciator extinguishes and **GS** is displayed. The autopilot will make pitch and bank changes as necessary to maintain localizer and glideslope.

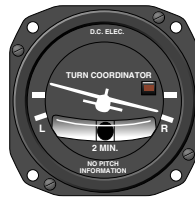
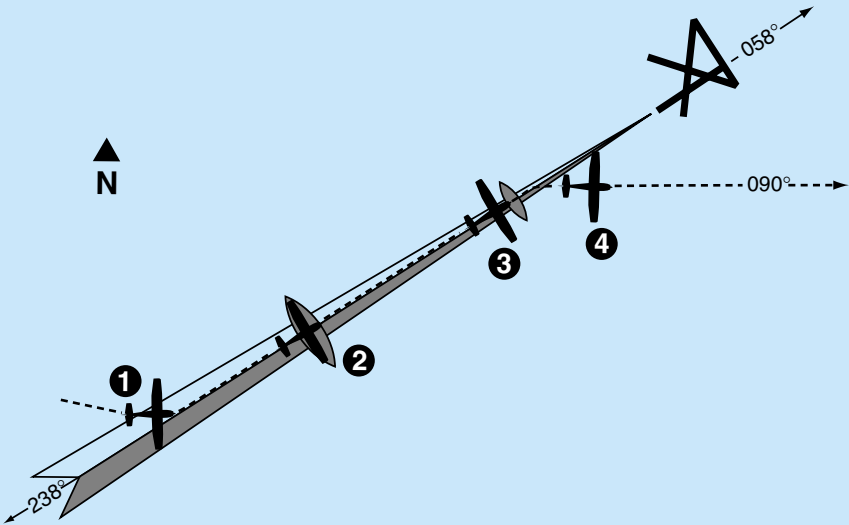

3. At the middle marker, the pilot disengages the autopilot with the button on the control wheel. This cancels all operating modes. The flashing **AP** annunciators are displayed and a disconnect tone will sound.

4. The pilot initiates the missed approach and stabilizes the aircraft in the climb. The heading bug is set to the missed approach heading of 090°. By depressing the **HDG** button on the KAP 140, the autopilot engages into the heading and vertical speed modes, commencing a right turn to a heading of 090° and maintaining the rate of climb existing at engagement.

*Note: Press and hold the **AP** button for 0.25 seconds to engage the autopilot (applicable only to software version 03/01 and later).*

Two Axis Operation

Front Course ILS Approach Using HSI

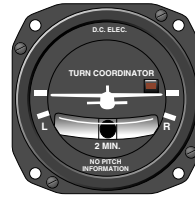
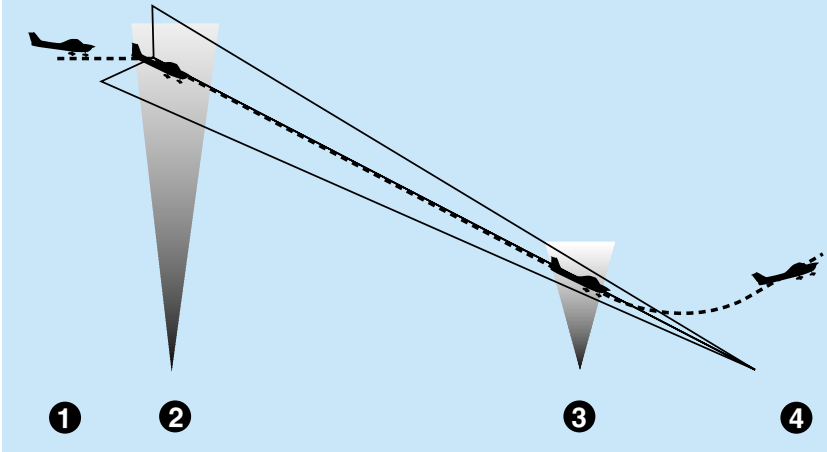

1. Continuing the maneuver on page 68, APR coupling occurs (**HDG** annunciation changes to **APR**), and the glideslope mode is automatically armed. The autopilot will capture the localizer and the CDI course index will center.

2. The autopilot is following the localizer. At the outer marker, the glideslope deviation needle is at midscale. Altitude hold is automatically disengaged when the glideslope is captured. The **ALT** annunciator extinguishes and **GS** is displayed. The autopilot will make pitch and bank changes as necessary to maintain localizer and glideslope.

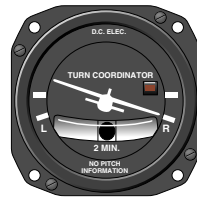
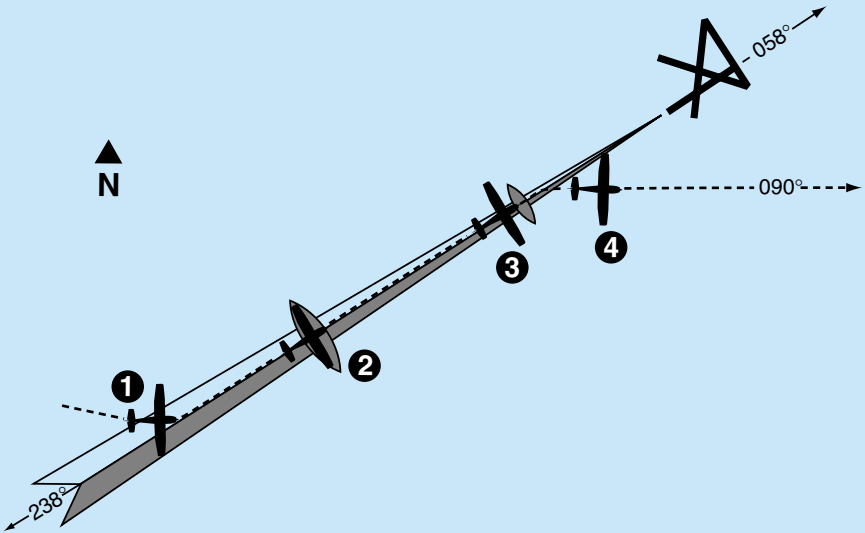

3. At the middle marker, the pilot disengages the autopilot with the button on the control wheel. This cancels all operating modes. The flashing **AP** annunciators are displayed and a disconnect tone will sound.

4. The pilot initiates the missed approach and stabilizes the aircraft in the climb. The heading bug is set to the missed approach heading of 090°. By depressing the **HDG** button on the KAP 140, the autopilot engages into the heading and vertical speed modes, commencing a right turn to a heading of 090° and maintaining the rate of climb existing at engagement.

*Note: Press and hold the **AP** button for 0.25 seconds to engage the autopilot (applicable only to software version 03/01 and later).*

Two Axis Operation

Outbound on GPS Approach Using DG

* Description of GPS operation based on Bendix/King GPS receiver. Others may require different operation.



1. The aircraft is in **APR** mode approaching the IAF. Approach arm is indicated on the GPS annunciator.*

2. Upon waypoint alerting at the IAF, the heading bug is set to 238°, the GPS's Leg/OBS mode switching is set to OBS mode and the OBS is set to 238°. The autopilot initiates a left turn to track the 238° GPS course.

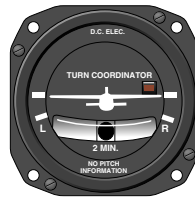
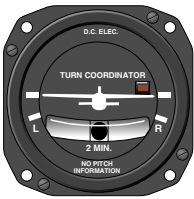
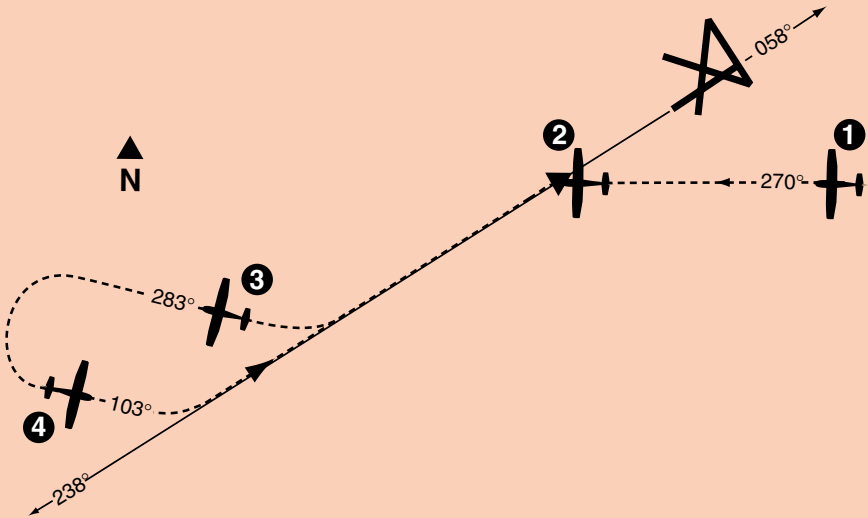

3. At the desired point, heading mode is used to initiate the procedure turn. During the procedure turn outbound, the deviation bar shows that the aircraft is flying away from the GPS course at a 45° angle on a selected heading of 283°.

4. The heading bug has been set to 103° and the aircraft has made a left turn to this heading. The GPS's Leg/OBS mode switching is set to Leg mode and the OBS is set to 058°. Select approach mode by depressing the **APR** button. The **HDG** announcement will flash for five seconds then extinguish. Move the heading bug within five seconds to 058°. Since the 45° intercept is 103°, the aircraft will not turn until the course is captured.

Two Axis Operation

Outbound on GPS Approach Using HSI

* Description of GPS operation based on Bendix/King GPS receiver. Others may require different operation.

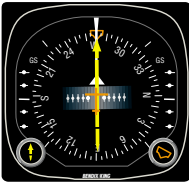
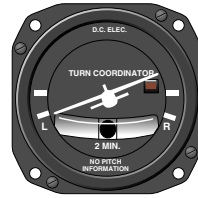
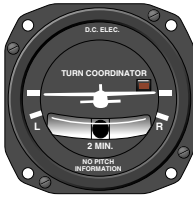

1. The aircraft is in **APR** mode approaching the IAF. Approach arm is indicated on the GPS annunciator.*
2. Upon waypoint alerting at the IAF, the course pointer is set to 238°, the GPS's Leg/OBS mode switching is set to OBS mode. The autopilot initiates a left turn to track the 238° GPS course.

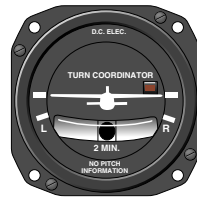
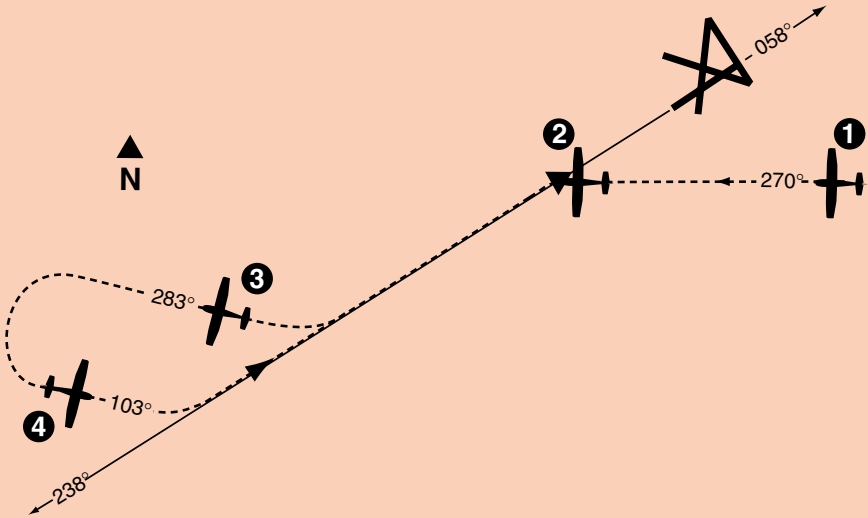

3. At the desired point, heading mode is used to initiate the procedure turn. During the procedure turn outbound, the deviation bar shows that the aircraft is flying away from the GPS course at a 45° angle on a selected heading of 283°.

4. The heading bug has been set to 103° and the heading bug has made a left turn to this heading. The GPS's Leg/OBS mode switching is set to Leg mode and the course pointer is set to 058°. Select approach mode by depressing the **APR** button.

Two Axis Operation

Inbound on GPS Approach Using DG

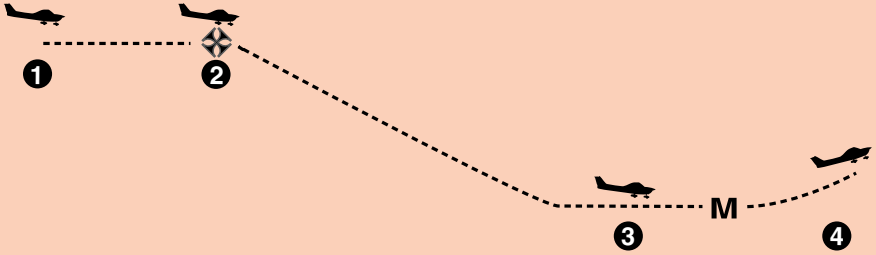

* Description of GPS operation based on Bendix/King GPS receiver. Others may require different operation.

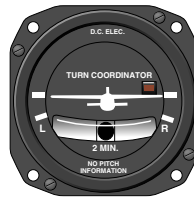

1. Continuing the maneuver on page 74, **APR** mode capture occurs. The autopilot initiates a left turn to track the 058° GPS course.
* Approach active is indicated on the GPS annunciator.

2. At the FAF, **ALT** is depressed to activate vertical speed mode. The desired descent rate is obtained using the **DN** button.
Remember, speed needs to be controlled with the throttle.

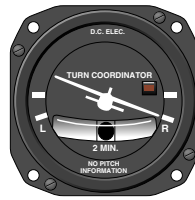
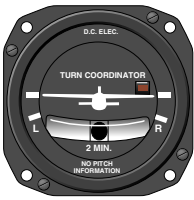
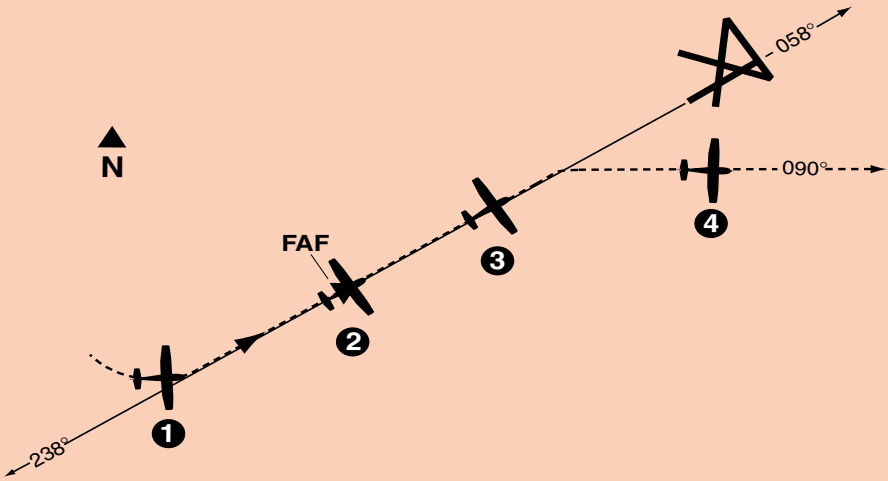

3. At the MDA, the **ALT** button is depressed causing the autopilot to level off and maintain a constant altitude. At the MAP the pilot disengages the autopilot with the button on the control wheel. A flashing **AP** annunciation is displayed and a distinctive tone will sound.

4. The pilot initiates the missed approach and stabilizes the aircraft in the climb. The heading bug is set to the missed approach heading of 090°. By depressing the **HDG** button on the KAP 140, the autopilot engages into the heading mode, commencing a right turn to a heading of 090°.

*Note: Press and hold the **AP** button for 0.25 seconds to engage the autopilot (applicable only to software version 03/01 and later).*

Two Axis Operation

Inbound on GPS Approach Using HSI

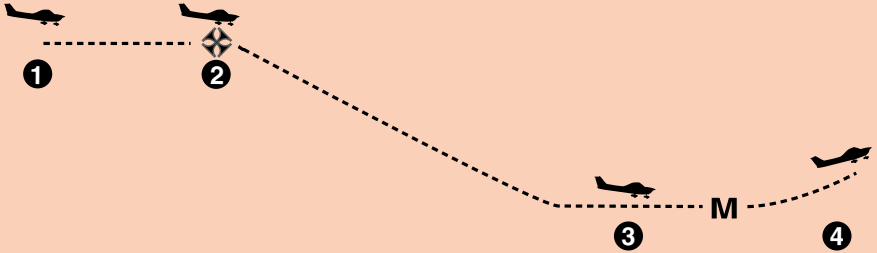

* Description of GPS operation based on Bendix/King GPS receiver. Others may require different operation.

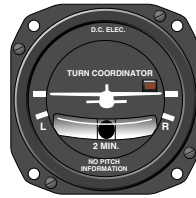

1. Continuing the maneuver on page 76, **APR** mode capture occurs. The autopilot initiates a left turn to track the 058° GPS course.
* Approach active is indicated on the GPS annunciator.

2. At the FAF, **ALT** is depressed to activate vertical speed mode. The desired descent rate is obtained using the **DN** button.
Remember, speed needs to be controlled with the throttle.

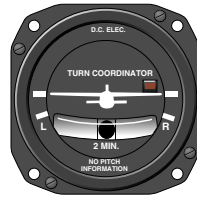
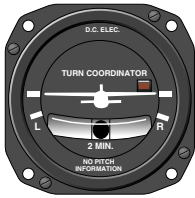
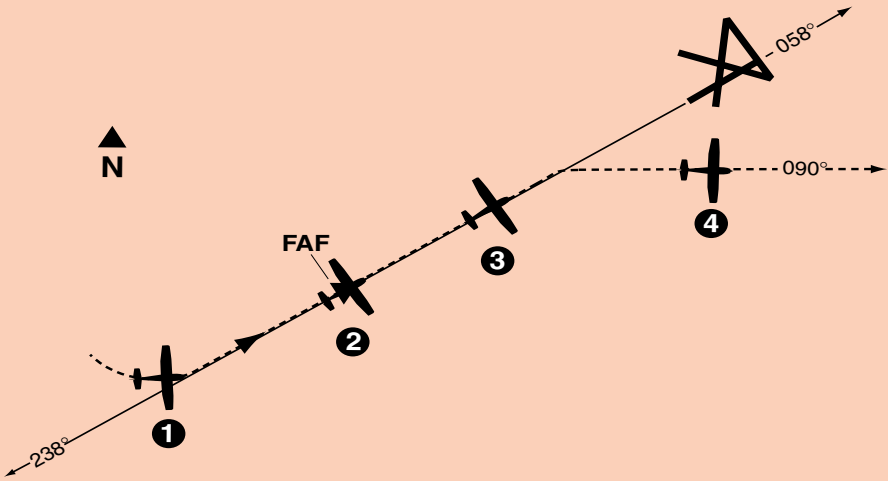

3. At the MDA, the **ALT** button is depressed causing the autopilot to level off and maintain a constant altitude. At the MAP the pilot disengages the autopilot with the button on the control wheel. A flashing **AP** annunciation is displayed and a distinctive tone will sound.

4. The pilot initiates the missed approach and stabilizes the aircraft in the climb. The heading bug is set to the missed approach heading of 090°. By depressing the **HDG** button on the KAP 140, the autopilot engages into the heading and vertical speed modes, commencing a right turn to a heading of 090° and maintaining the rate of climb existing at engagement.

*Note: Press and hold the **AP** button for 0.25 seconds to engage the autopilot (applicable only to software version 03/01 and later).*

This page intentionally left blank

KAP 140 Two Axis with Altitude Preselect Operation

The KAP 140 is a digital, panel-mounted autopilot system for light aircraft.

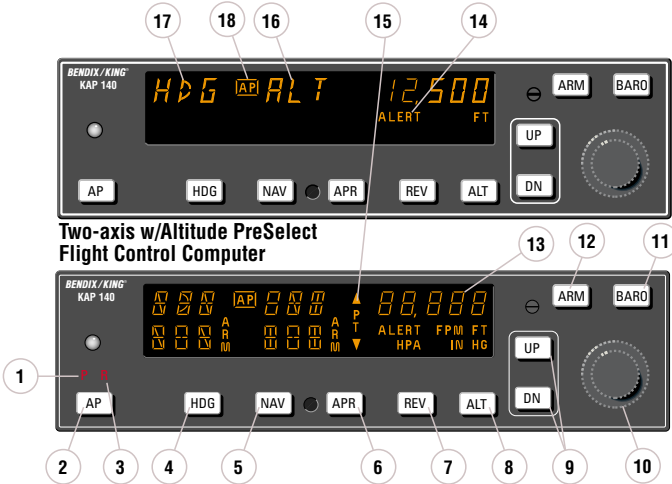

Full KAP 140 Two-Axis with Altitude Preselect Display

1. PITCH AXIS, (P) ANNUNCIATOR - When illuminated, indicates failure of the pitch axis and will disengage the autopilot when the failure occurs and not allow engagement of the pitch axis.
2. AUTOPILOT ENGAGE/DISENGAGE (AP) BUTTON - When pushed, engages autopilot if all logic conditions are met. The autopilot will engage in the basic roll (ROL) mode which functions as a wing leveler and in the vertical speed (VS) hold mode. The commanded vertical speed is displayed in the upper right corner of autopilot display area for three seconds after engagement or if either the UP or DN button is pressed. The captured VS will be the vertical speed present at the moment of AP button press. When pressed again, will disengage the autopilot. For software version 03/01

and later, the AP button must be pressed and held for 0.25 seconds to engage the autopilot.

3. ROLL AXIS (R) ANNUNCIATOR - When illuminated, indicates failure of the roll axis and will disengage the autopilot and not allow engagement.

4. HEADING (HDG) MODE SELECTOR BUTTON - When pushed, will arm the Heading mode, which commands the airplane to turn to and maintain the heading selected by the heading bug on either the DG or HSI. A new heading may be selected at any time and will result in the airplane turning to the new heading. Button can also be used to toggle between HDG and ROL modes. This button will engage the autopilot in units with software prior to software version 03/01.

Two Axis/Altitude Preselect Operations

5. **NAVIGATION (NAV) MODE SELECTOR BUTTON** - When pushed, will arm the navigation mode. The mode provides automatic beam capture and tracking of VOR, LOC or GPS as selected for presentation on the HSI or CDI. NAV mode is recommended for enroute navigation tracking. NAV mode may also be used for front course LOC tracking when GS tracking is not desired.

6. **APPROACH (APR) MODE SELECTOR BUTTON** - When pushed, will arm the Approach mode. This mode provides automatic beam capture and tracking of VOR, GPS, LOC, and Glideslope (GS) on an ILS, as selected for presentation on the HSI or CDI. APR mode is recommended for instrument approaches.

7. **BACK COURSE APPROACH (REV) MODE SELECTOR BUTTON** - When pushed, will arm the Back Course approach mode. This mode functions similarly to the approach mode except that the autopilot response to LOC signals is reversed, and GS is disabled.

8. **ALTITUDE HOLD (ALT) MODE SELECT BUTTON** - When pushed, will select the Altitude Hold mode. This mode provides tracking of the reference altitude. The reference altitude is the altitude at the moment the ALT button is pressed. If the ALT button is pressed with an established VS rate present, there will be altitude overshoot (approximately 10% of the VS rate), with the airplane returned positively to the reference altitude. This button will engage the autopilot in units with software prior to software version 03/01.

9. **VERTICAL TRIM (UP/DN) BUTTONS** - The action of these buttons is dependent upon the vertical mode present when pressed. If VS mode is active, the initial button stroke will bring up the commanded vertical speed in the display. Subsequent immediate button strokes will increment the vertical speed commanded either up or down at the rate of 100 ft/min per button press, or at the rate of approximately 300 ft/min per second if held continuously. If ALT mode is active, incremental button strokes will move the altitude hold reference altitude either up or down at 20 feet per press, or if held continuously will command the airplane up or down at the rate of 500 ft/min, synchronizing the altitude hold reference to the actual airplane altitude upon button release.

(Note that the altitude hold reference is not displayed. The display will continue to show the altitude alerter reference.)

10. **ROTARY KNOBS** - Used to set the altitude alerter reference altitude; or may be used immediately after pressing the BARO button, to adjust the autopilot baro setting to match that of the airplane's altimeter when manual adjustment is required. (In some installations the baro setting is automatically synced to that of the altimeter.)

11. **BARO SET (BARO) BUTTON** - When pushed and released, will change the display from the altitude alerter selected altitude to the baro setting display (either IN HG or HPA) for 3 seconds. If pushed and held for 2 seconds, will change the baro setting display from IN HG to HPA or

Two Axis/Altitude Preselect Operations

vice versa. Once the baro setting display is visible the rotary knobs may be used to manually adjust the baro setting if automatic baro correction is not available.

12. **ALTITUDE ARM (ARM) BUTTON** - When pushed will toggle altitude arming on or off. When ALT ARM is annunciated, the autopilot will capture the altitude alerter displayed altitude (provided the aircraft is climbing or descending in VS to the displayed altitude). When the autopilot is engaged, ALT arming is automatic upon altitude alerter altitude selection via the rotary knobs. Note that the alerter functions are independent of the arming process thus providing full time alerting, even when the autopilot is disengaged.

13. **ALTITUDE ALERTER/VERTICAL SPEED/BARO SETTING DISPLAY** - Normally displays the altitude alerter selected altitude. If the UP or DN button is pushed while in VS hold, the display changes to the command reference for the VS mode in FPM for 3 seconds. If the BARO button is pushed, the display changes to the autopilot baro setting in either IN HG or HPA for 3 seconds.

NOTE: This display may be dashed for up to 3 minutes on start up if a blind encoder is installed which requires a warm up period.

14. **ALTITUDE ALERT (ALERT) ANNUNCIATION** - The ALERT annunciate is illuminated 1000 ft. prior to the selected altitude, extinguishes 200 ft. prior to the selected altitude and illuminates momentarily when the selected altitude is

reached. Once the selected altitude is reached a flashing ALERT illumination signifies that the 200 ft. "safe band" has been exceeded and will remain illuminated until 1000 ft. from the selected altitude. Associated with the visual alerting is an aural alert (5 short tones) which occurs 1000 feet from the selected altitude upon approaching the altitude and 200 feet from the selected altitude on leaving the altitude.

15. **PITCH TRIM (PT) ANNUNCIATION** - A flashing PT with arrows indicates the direction of required pitch trim. A solid PT without an arrow head is an indication of a pitch trim fault. During manual electric trim operation (autopilot disengaged), detection of a stuck MET switch will be indicated by a solid PT. When the fault is corrected, the annunciation will extinguish.

16. **PITCH MODE DISPLAY** - Displays the active and armed pitch modes (VS, ALT, ARM, ALT and GS).

17. **ROLL MODE DISPLAY** - Displays the active and armed roll modes (ROL, HDG, NAV ARM, NAV, APR ARM, APR, REV ARM, REV, GS ARM). Also displayed will be flashing AP annunciation (5 seconds) at each autopilot disconnect accompanied by an aural tone (for 2 seconds).

18. **AUTOPILOT ENGAGED (AP) ANNUNCIATION** - Illuminates whenever the autopilot is engaged. Flashes during pilot initiated or automatic disengagement. Only applicable for software versions 03/01 or later.

Two Axis/Altitude Preselect Operations

System Operating Modes

The lateral modes (HDG, NAV, APR and REV) operate identically as depicted in the KAP 140 Single Axis Operating Modes section. Please refer to that section for text descriptions of lateral mode operation.



Vertical Speed (VS) Mode

The Vertical Speed (VS) mode allows variable speed climbs and descents. The **ALT** button toggles between altitude hold and vertical speed modes.

Note: The KAP 140 engages into VS mode as a default.

To operate in the **VS** mode (with autopilot currently disengaged):

1. **AP** button - Press. Note **ROL**, **VS** and current vertical speed is displayed. If no other modes are selected the autopilot will operate in the **ROL** and vertical speed hold modes. For software version 03/01 and later, the **AP** button must be pressed and held for 0.25 seconds to engage the autopilot.
2. **UP** or **DN** button - Select desired climb or descent rate. Each button stroke will increment the vertical speed commanded up or down by 100 ft/min per button press, or at the rate of approximately 300 ft/min per second if held continuously.

To initiate a climb or descent from Altitude Hold (**ALT**) mode:

1. **ALT** button - Press. Note **ALT**

changes to **VS** and current vertical speed is displayed.

2. **UP** or **DN** button - Select desired climb or descent rate. Each button stroke will increment the vertical speed commanded up or down by 100 ft/min per button press, or at the rate of approximately 300 ft/min per second if held continuously.

Note: VS command value will be displayed during Control Wheel Steering (CWS) and for three seconds following VS engagement or pressing the UP or DN button. Both altitude and vertical speed utilize the same display area. Altitude is always displayed except during vertical speed selection. If the VS command value is not displayed, pressing (and releasing) the UP or DN button will not change the indicated altitude reference but will display the VS command value.

Note: When operating at or near the best rate of climb airspeed, at climb power settings, and using vertical speed hold, it is easy to decelerate to an airspeed where continued decreases in airspeed will result in a reduced rate of climb. Continued operation in vertical speed mode can result in a stall.



Altitude Hold (ALT) Mode

The Altitude Hold (**ALT**) mode maintains the pressure altitude acquired upon selection of altitude hold. The **ALT** button toggles between altitude hold and vertical speed modes.

To operate in the **ALT** mode (with autopilot currently in the Vertical Speed mode):

1. **ALT** button - Press. Note **ALT** is annunciated and autopilot maneuvers to maintain pressure altitude acquired at button selection.
2. **UP** or **DN** button - Select to change altitude. Incremented button strokes will move the reference altitude by 20 feet per press, or if held continuously will command a 500 ft/min altitude change, acquiring a new reference altitude upon button release.

Note: Incremented altitude changes should be limited to 500 ft. of change.

Two Axis/Altitude Preselect Operations

Altitude Alerting and Preselect

The Altitude Preselect function allows capturing of a desired altitude and transferring into altitude hold. Manual input of desired altitude is accomplished through the rotary knobs on the faceplate of the KAP 140.

The Altitude Alerting function will visually and aurally announce approaching, acquiring and deviation from a selected altitude.

Altimeter Setting

Installations with remote baro input

1. BARO setting - CHECK. depressing the **BARO** button will display the baro setting for three seconds.



Installations without remote baro input

Upon successful completion of pre-flight test, the baro display will flash.

1. BARO setting - Enter barometric setting using the rotary knobs OR if correct as displayed, press **BARO**.



Note: It is recommended that the baro value be updated whenever the aircraft altimeter setting is changed.

Baro unit conversion

The barometric pressure display can be toggled between IN HG and HPA as needed by the pilot.

1. **BARO** button - Press and hold for two seconds.



Altitude Alerter

The function of the Altitude Alerter is independent of the autopilot.

1. ALTITUDE SELECT knob - ROTATE until the desired altitude is displayed.



*Note: The **ALERT** annunciation is illuminated 1000 ft. prior to the selected altitude, extinguishes 200 ft. prior to the selected altitude and illuminates momentarily when the selected altitude is reached. Once the selected altitude is reached, a flashing **ALERT** illumination signifies that the 200 ft. "safe band" has been exceeded and will remain illuminated until 1000 ft. from the selected altitude. Associated with the visual*

alerting is an aural alert (five short tones) which occurs 1000 ft. from the selected altitude upon approaching the altitude and 200 ft. from the selected altitude on leaving the altitude.



Altitude Preselect

1. ALTITUDE SELECT knob - ROTATE until desired altitude is displayed. ARM annunciation occurs automatically upon altitude selection when the autopilot is engaged.



2. Airplane - ESTABLISH desired vertical speed to intercept the selected altitude.



3. Upon altitude capture, **ALT ARM** will extinguish and **ALT** will be annunciated.

Note: Altitude preselect captures are not recommended on non-precision approaches to capture the MDA. Glideslope coupling will preclude an altitude capture on an ILS.



Voice Messaging

The following standard voice messages will be annunciated as conditions warrant:

1. **"TRIM IN MOTION, TRIM IN MOTION..."** - Pitch trim running for more than 5 seconds.
2. **"CHECK PITCH TRIM"** - An out of trim condition has existed for 15 seconds.
 - a. Airplane Control Wheel - **GRASP FIRMLY**, press **CWS** and check for an out of pitch trim condition. Manually retrim as required.
 - b. **CWS** button - **RELEASE**.
 - c. **AUTOPILOT OPERATION - CONTINUE** if satisfied that the out of trim condition was temporary. **DISCONTINUE** if evidence indicates a failure of the auto trim function.

The following optional voice messages will be annunciated if the system is configured for voice messaging:

1. **"ALTITUDE"** - 1000 feet before approaching selected altitude.
2. **"LEAVING ALTITUDE"** - 200 feet away, departing selected altitude.
3. **"AUTOPILOT"** - Autopilot has disengaged, either through pilot action or automatically.

Two Axis/Altitude Preselect Operations

OPERATIONS WITH THE KAP 140

Takeoff And Climb To Assigned Altitude

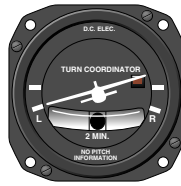
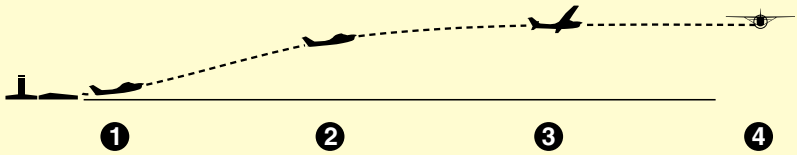

OR



OR



1. The aircraft is well off the ground and established at a safe climb rate.

The heading bug on the DG or HSI is turned to the desired heading of 080° (runway heading).

By depressing the **HDG** button on the KAP 140, the autopilot engages into the heading and vertical speed modes and maintains the selected heading of 080° and current rate of climb.

*Note: Press and hold the **AP** button for 0.25 seconds to engage the autopilot (applicable only to software version 03/01 and later).*

2. The heading bug on the DG or HSI is turned to the new desired heading of 010° and the aircraft begins to respond with an immediate left turn. A cruise altitude of 7,000 feet is entered using the rotary knobs. Altitude **ARM** annunciation occurs automatically upon selection.

Two Axis/Altitude Preselect Operations

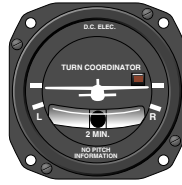
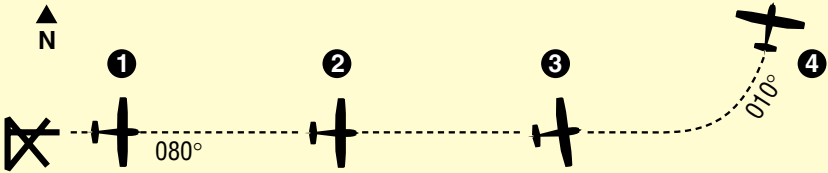

OR



OR



3. The autopilot is responding to the heading select mode with a left bank. The climb rate has been decreased, using the **DN** button, in preparation for level out. The vertical speed value will be displayed upon selection of the **DN** button and will remain for three seconds.

4. Desired altitude has been reached and automatic altitude capture occurs. The autopilot has completed the turn and is now established on a 010° heading.

Two Axis/Altitude Preselect Operations

GPS Capture Using DG

* Description of GPS operation based on Bendix/King GPS receiver. Others may require different operation.



1. Continuing on heading 010°, a GPS waypoint is established. A 30° intercept is desired.

2. The **HDG** button is depressed to select **ROL** mode which will allow an “all angle intercept”. GPS data is selected for the CDI and the OBS is set to 040°. The **NAV** button is depressed and **NAV ARM** is annunciated. **ROL** will change to **HDG** and flash for five seconds. **ROL** will then be redisplayed. While the **HDG** annunciation is flashing, move the heading bug to the desired course of 040°. The aircraft will remain wings level until the capture point.

Two Axis/Altitude Preselect Operations

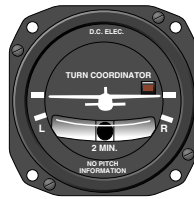
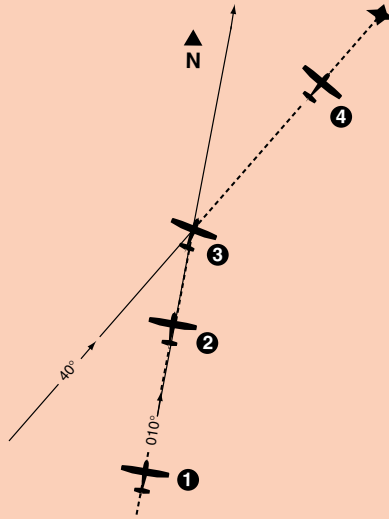

3. When the computed capture point is reached, the **ROL** annunciation changes to **NAV** and a right turn is initiated by the autopilot.

4. The turn is complete and the autopilot is tracking the GPS course.

Two Axis/Altitude Preselect Operations

GPS Capture Using HSI

* Description of GPS operation based on Bendix/King GPS receiver. Others may require different operation.

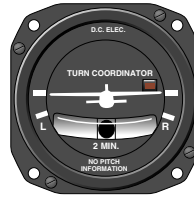

1. Continuing on heading 010°, a GPS waypoint is established. A 30° intercept is desired.
2. GPS data is selected for the HSI. The course pointer is set to 040°. The **NAV** button is depressed and **NAV ARM** is annunciated.

Two Axis/Altitude Preselect Operations

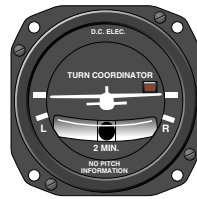
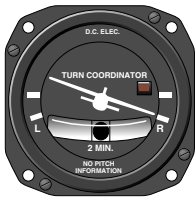
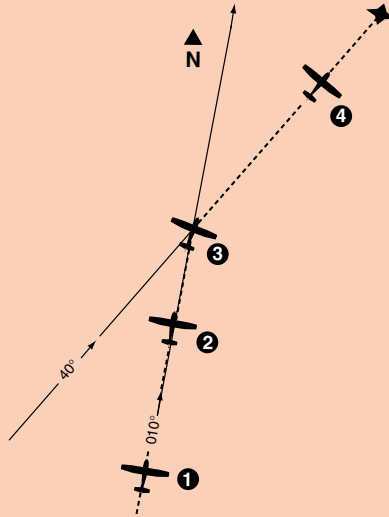

3. When the computed capture point is reached, the **HDG** annunciation changes to **NAV** and a right turn is initiated by the autopilot.

4. The turn is complete and the autopilot is tracking the GPS course.

Two Axis/Altitude Preselect Operations

Outbound On Front Course For Procedure Turn To ILS Approach Using DG

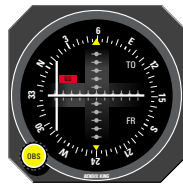
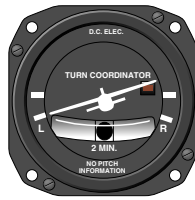

1. The aircraft is heading 270° with heading and altitude hold engaged. To intercept and fly the ILS front course outbound, set the front course on the OBS and depress the reverse course (**REV**) button. The **HDG** annunciation will flash for five seconds then extinguish. While the **HDG** annunciation is flashing, move the heading bug to the front course 058°. Since **HDG** was active upon selection of **REV** the autopilot will initiate a 45° intercept to the localizer signal. In this case, the aircraft will turn to 283°.

2. When the computed capture point is reached, auto intercept mode is cancelled and reverse localizer mode is automatically activated and a left turn outbound on the localizer is initiated by the autopilot.

Note: The left-right deviations of the CDI course deviation needle are reversed (you must turn right to center a deviation of the index to the left). This needle reversing takes place because you are flying outbound on a front course.

Two Axis/Altitude Preselect Operations

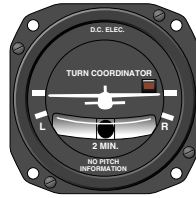
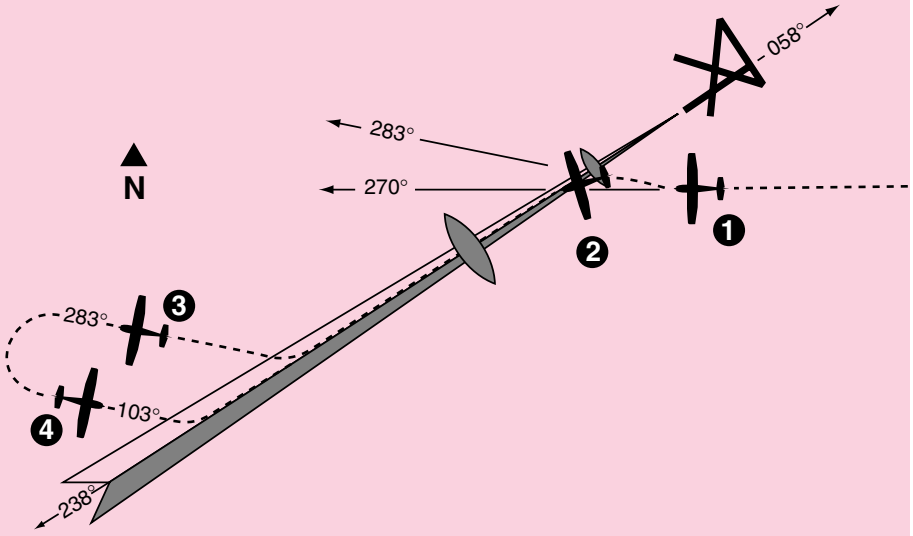

- At the desired point, **HDG** mode is used to initiate the procedure turn. Select **HDG** and set the heading bug to 283°. During the procedure turn outbound, the CDI course index goes off scale to the right. The aircraft is flying away from the localizer centerline at a 45° angle on a selected heading of 283°.

- Now you have reset the heading bug to 103° and made a 180° turn to this heading. This 103° heading will intercept the front course of 058°. You must now select the approach mode by depressing the **APR** button on the KAP 140.
 - * The **HDG** annunciation will flash for five seconds then extinguish. While the **HDG** annunciation is flashing, move the heading bug to the front course 058°. Since the 45° intercept is 103°, the aircraft will not turn until the front course is captured.

* Check the heading displayed on the DG against the magnetic compass and reset if necessary.

Two Axis/Altitude Preselect Operations

Outbound On Front Course For Procedure Turn To ILS Approach Using HSI

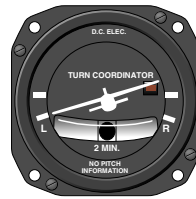
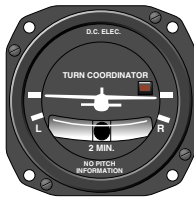

1. The aircraft is heading 270° with heading and altitude hold engaged. To intercept and fly the ILS front course outbound, set the front course on the HSI and depress the back course (**REV**) button. The back course (**REV**) mode is selected to go outbound on the front course. The capture point is now being computed based on closure rate.

2. When the computed capture point is reached, **HDG** mode is cancelled and reverse localizer mode is automatically activated and a left turn outbound on the localizer is initiated by the autopilot.

Note: The left-right deviations of the HSI course needle operate just as though you were flying a front course approach.

Two Axis/Altitude Preselect Operations

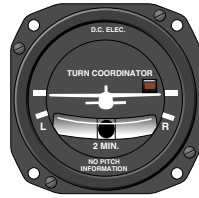
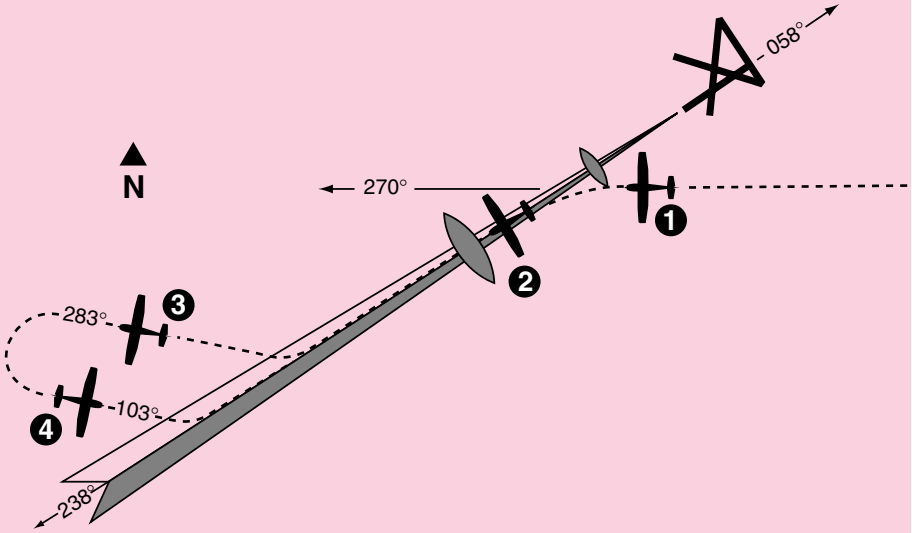

3. At the desired point, HDG mode is used to initiate the procedure turn. During the procedure turn outbound, the deviation bar shows that the aircraft is flying away from the localizer centerline at a 45° angle on a selected heading of 283°.

4. Now you have reset the heading bug to 103° and made a 180° turn to this heading. The 103° heading will intercept the front course of 058°. You must now select the approach mode by depressing the **APR** button on the KAP 140. Automatic capture of the localizer will occur.

Two Axis/Altitude Preselect Operations

Front Course ILS Approach Using DG

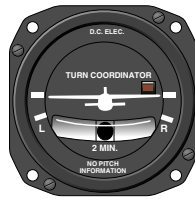
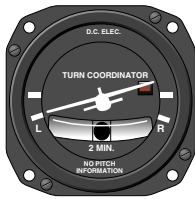
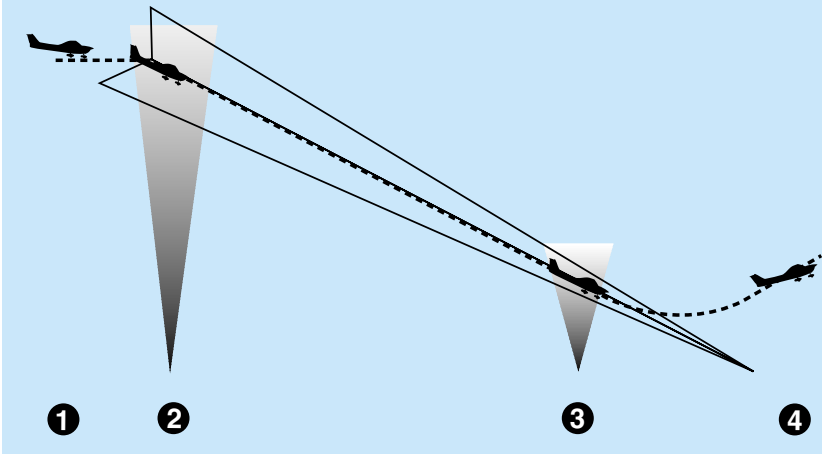

1. Continuing the maneuver on page 96, APR coupling occurs (**HDG** annunciation changes to **APR**), and the glideslope mode is automatically armed. The autopilot will capture the localizer and the CDI course index will center.

2. The autopilot is following the localizer. At the outer marker, the glideslope deviation needle is at midscale. Altitude hold is automatically disengaged when the glideslope is captured. The **ALT** annunciator extinguishes and **GS** is displayed. The autopilot will make pitch and bank changes as necessary to maintain localizer and glideslope.

Two Axis/Altitude Preselect Operations

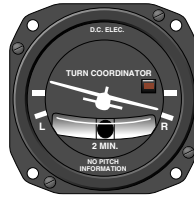
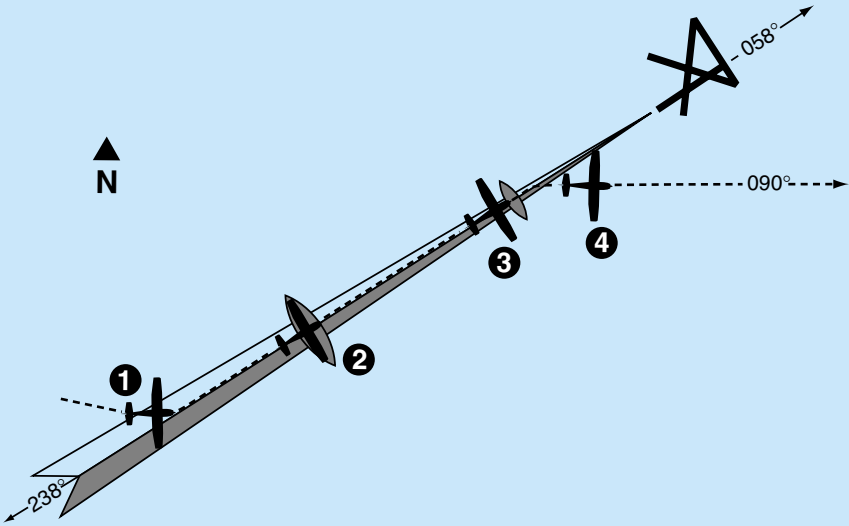

3. At the middle marker, the pilot disengages the autopilot with the button on the control wheel. This cancels all operating modes. The flashing **AP** annunciations are displayed and a disconnect tone will sound.

4. The pilot initiates the missed approach and stabilizes the aircraft in the climb. The heading bug is set to the missed approach heading of 090°. By depressing the **HDG** button on the KAP 140, the autopilot engages into the heading and vertical speed modes, commencing a right turn to a heading of 090° and maintaining the rate of climb existing at engagement.

*Note: Press and hold the **AP** button for 0.25 seconds to engage the autopilot (applicable only to software version 03/01 and later).*

Two Axis/Altitude Preselect Operations

Front Course ILS Approach Using HSI

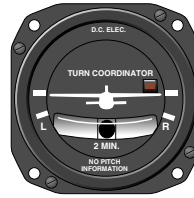
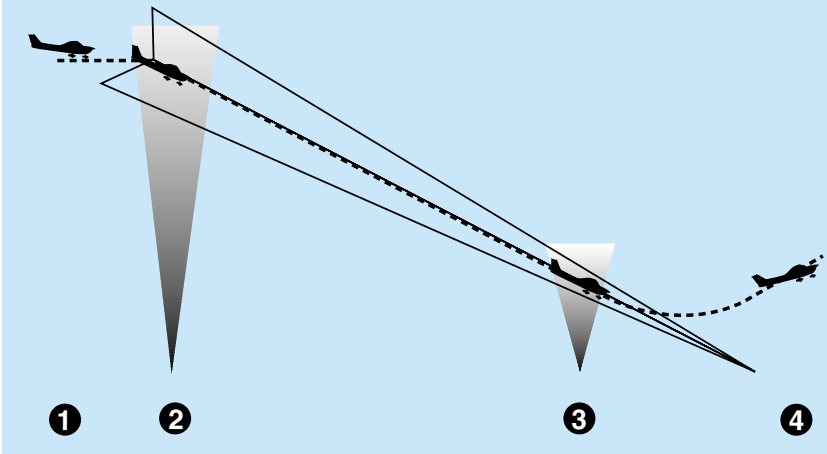

1. Continuing the maneuver on page 98, APR coupling occurs (**HDG** annunciation changes to **APR**), and the glideslope mode is automatically armed. The autopilot will capture the localizer and the CDI course index will center.

2. The autopilot is following the localizer. At the outer marker, the glideslope deviation needle is at midscale. Altitude hold is automatically disengaged when the glideslope is captured. The **ALT** annunciation extinguishes and **GS** is displayed. The autopilot will make pitch and bank changes as necessary to maintain localizer and glideslope.

Two Axis/Altitude Preselect Operations

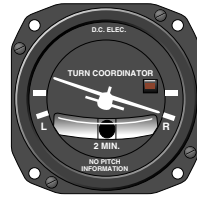
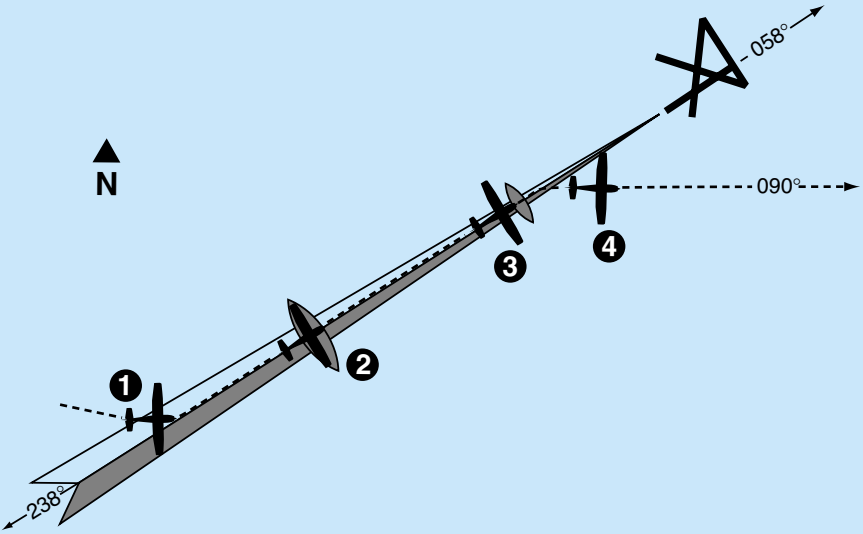

3. At the middle marker, the pilot disengages the autopilot with the button on the control wheel. This cancels all operating modes. The flashing **AP** annunciators are displayed and a disconnect tone will sound.

4. The pilot initiates the missed approach and stabilizes the aircraft in the climb. The heading bug is set to the missed approach heading of 090°. By depressing the **HDG** button on the KAP 140, the autopilot engages into the heading and vertical speed modes, commencing a right turn to a heading of 090° and maintaining the rate of climb existing at engagement.

*Note: Press and hold the **AP** button for 0.25 seconds to engage the autopilot (applicable only to software version 03/01 and later).*

Two Axis/Altitude Preselect Operations

Outbound on GPS Approach Using DG

* Description of GPS operation based on Bendix/King GPS receiver. Others may require different operation.

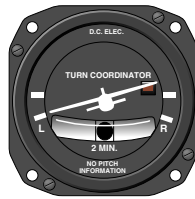
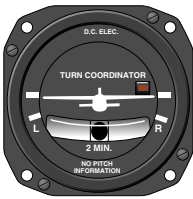

1. The aircraft is in **APR** mode approaching the IAF. Approach arm is indicated on the GPS annunciator.*
2. Upon waypoint alerting at the IAF, the heading bug is set to 238°, the GPS's Leg/OBS mode switching is set to OBS mode and the OBS is set to 238°. The autopilot initiates a left turn to track the 238° GPS course.

Two Axis/Altitude Preselect Operations

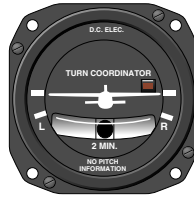
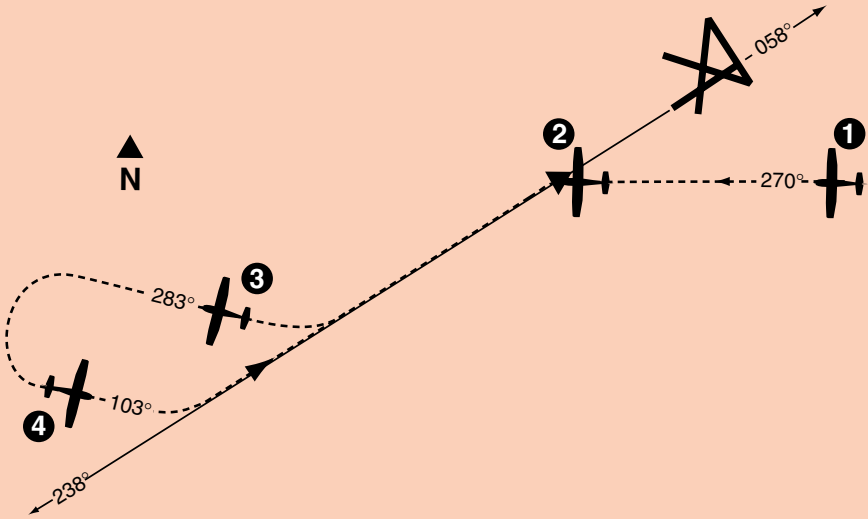

3. At the desired point, heading mode is used to initiate the procedure turn. During the procedure turn outbound, the deviation bar shows that the aircraft is flying away from the GPS course at a 45° angle on a selected heading of 283°.

4. The heading bug has been set to 103° and the aircraft has made a left turn to this heading. The GPS's Leg/OBS mode switching is set to Leg mode and the OBS is set to 058°. Select approach mode by depressing the **APR** button.

*The **HDG** annunciation will flash for five seconds then extinguish. While the **HDG** annunciation is flashing, move the heading bug to 058°. Since the 45° intercept is 103°, the aircraft will not turn until the course is captured.

* Check the heading displayed on the DG against the magnetic compass and reset if necessary.

Two Axis/Altitude Preselect Operations

Outbound on GPS Approach Using HSI

* Description of GPS operation based on Bendix/King GPS receiver. Others may require different operation.

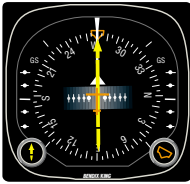
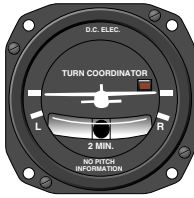

1. The aircraft is in **APR** mode approaching the IAF. Approach arm is indicated on the GPS annunciator.*
2. Upon waypoint alerting at the IAF, the course pointer is set to 238°, the GPS's Leg/OBS mode switching is set to OBS mode. The autopilot initiates a left turn to track the 238° GPS course.

Two Axis/Altitude Preselect Operations

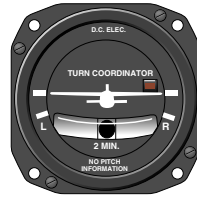
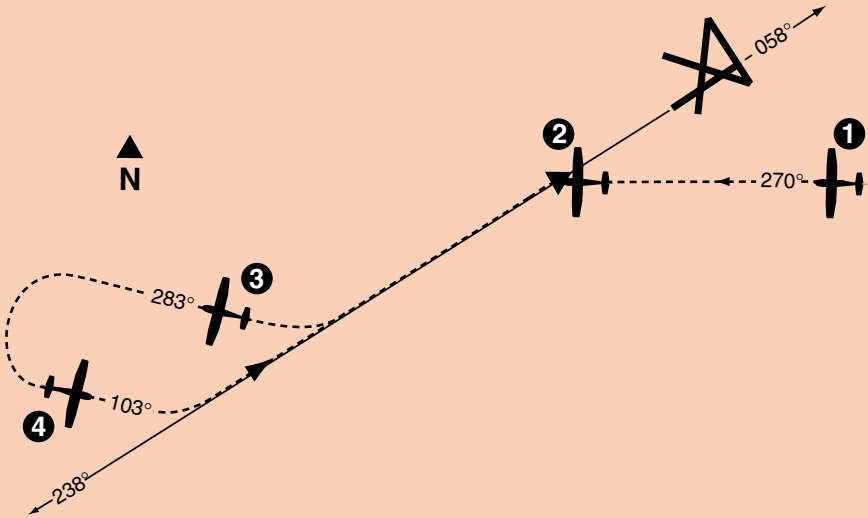

3. At the desired point, heading mode is used to initiate the procedure turn. During the procedure turn outbound, the deviation bar shows that the aircraft is flying away from the GPS course at a 45° angle on a selected heading of 283°.

4. The heading bug has been set to 103° and the aircraft has made a left turn to this heading. The GPS's Leg/OBS mode switching is set to Leg mode and the course pointer is set to 103°. Select approach mode by depressing the **APR** button.

Two Axis/Altitude Preselect Operations

Inbound on GPS Approach Using DG

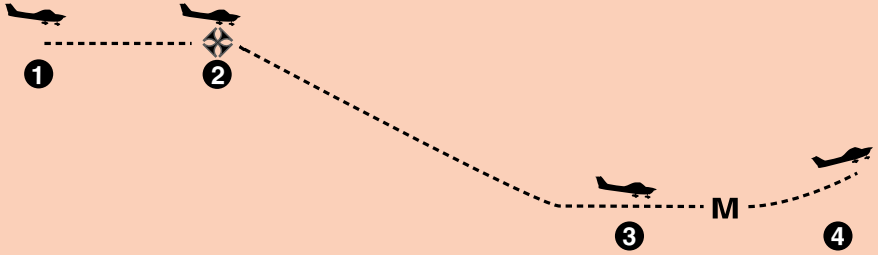

* Description of GPS operation based on Bendix/King GPS receiver. Others may require different operation.

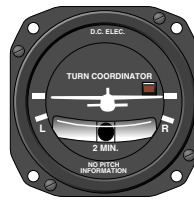
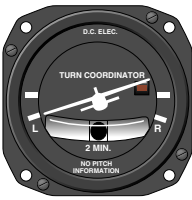

1. Continuing the maneuver on page 104, **APR** mode capture occurs. The autopilot initiates a left turn to track the 058° GPS course.
* Approach active is indicated on the GPS annunciator.

2. At the FAF, **ALT** is depressed to activate vertical speed mode. The desired descent rate is obtained using the **DN** button.
Remember, speed needs to be controlled with the throttle.

Two Axis/Altitude Preselect Operations

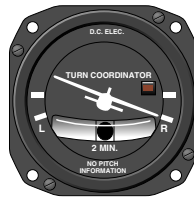
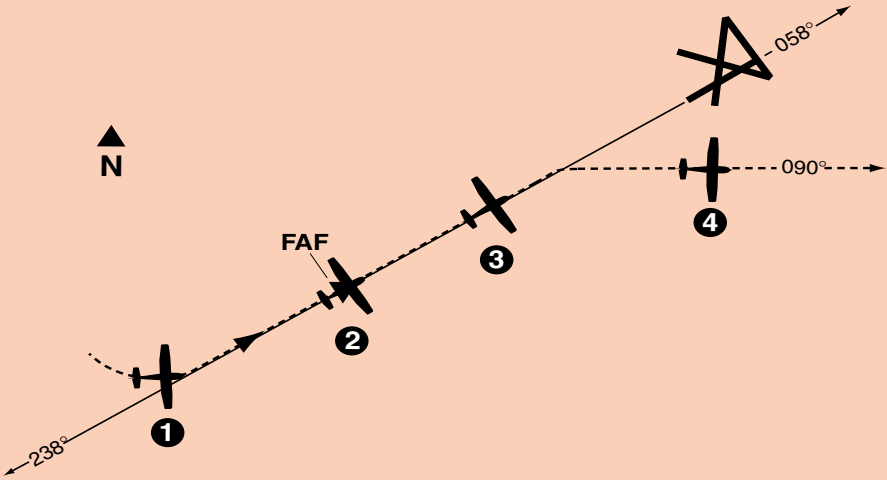

3. At the MDA, the **ALT** button is depressed causing the autopilot to level off and maintain a constant altitude. At the MAP the pilot disengages the autopilot with the button on the control wheel. A flashing **AP** annunciation is displayed and a distinctive tone will sound.

4. The pilot initiates the missed approach and stabilizes the aircraft in the climb. The heading bug is set to the missed approach heading of 090°. By depressing the **HDG** button on the KAP 140, the autopilot engages into the heading and vertical speed modes, commencing a right turn to a heading of 090° and maintaining the rate of climb existing at engagement.

*Note: Press and hold the **AP** button for 0.25 seconds to engage the autopilot (applicable only to software version 03/01 and later).*

Two Axis/Altitude Preselect Operations

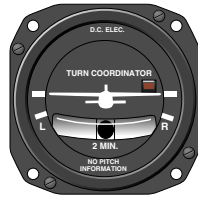
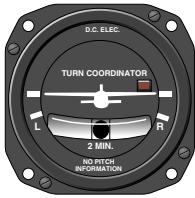
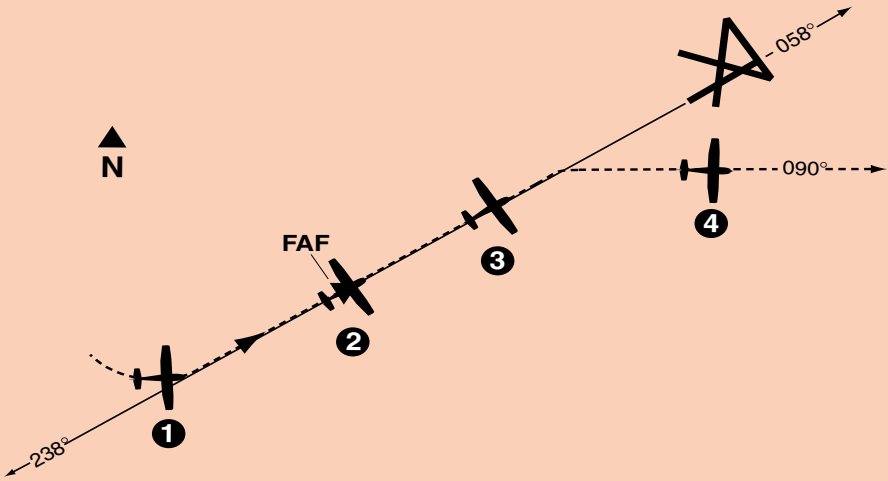

3. At the MDA, the **ALT** button is depressed causing the autopilot to level off and maintain a constant altitude. At the MAP the pilot disengages the autopilot with the button on the control wheel. The flashing **AP** annunciations are displayed and a distinctive tone will sound.

4. The pilot initiates the missed approach and stabilizes the aircraft in the climb. The heading bug is set to the missed approach heading of 090°. By depressing the **HDG** button on the KAP 140, the autopilot engages into the heading and vertical speed modes, commencing a right turn to a heading of 090° and maintaining the rate of climb existing at engagement.

*Note: Press and hold the **AP** button for 0.25 seconds to engage the autopilot (applicable only to software version 03/01 and later).*

Two Axis/Altitude Preselect Operations

This page intentionally left blank

KCS 55A Compass System

The KCS 55A Compass System, which includes the KA 51B Slaving Control and Compensator Unit, the KMT 112 Magnetic Slaving Transmitter and the KG 102 Directional Gyro as well as the KI 525A Pictorial Navigation Indicator is an optional part of the KAP 140 Autopilot System.

The panel-mounted KI 525A HSI combines the display functions of both the standard Directional Gyro and the Course Deviation Indicator's VOR/LOC/Glideslope information to provide the pilot with a single presentation of the complete horizontal navigation situation. This greatly simplifies course orientation, interception and tracking, while eliminating the need for scan coordination between two separate indicators.

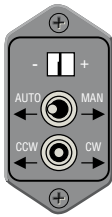

KA 51B



KI 525A

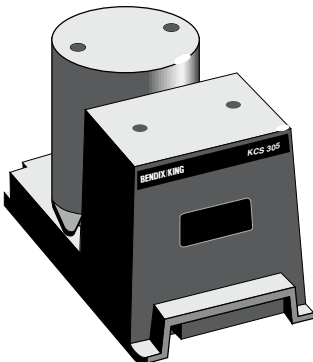

KG 102A

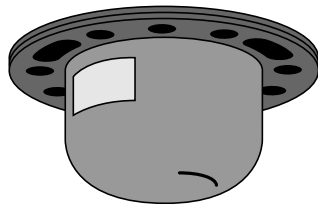

KMT 112

KCS 55A Compass System

Selected Course Pointer - On this two-part arrow, the “head” indicates the desired VOR or Localizer course and the “tail” indicates the reciprocal. This pointer is set by rotating the course select knob.

Course Select Knob - Used to rotate the course pointer to the desired course on the compass card. This knob corresponds to the Omni Bearing Selector (OBS) on standard NAV indicators.

VOR/RNAV and LOC Deviation - This bar corresponds to the “left/right” needle on standard course deviation indicators. When the aircraft is precisely on the VOR radial or Localizer course, it forms the center section of the selected course pointer and will be positioned under the symbolic aircraft. When off course or approaching a new course, it will move to one side or the other. Since the entire VOR and Localizer display rotates with the compass card, the angular relationship between the deviation bar and the symbolic aircraft provides a pictorial symbolic display of the aircraft’s position with respect to the selected course.

Deviation Scale - When tuned to a VOR frequency, each white dot represents two degrees of deviation left or right of course. When tuned to a Localizer, the deviation is 1/2 degree per dot. (When GPS data is selected for presentation, refer to the Pilot’s Guide for the GPS receiver.)

Heading Select Bug - A movable orange marker on the outer perimeter of the display, used primarily to select the desired heading you wish to fly. This desired heading is coupled to the KAP 140 Autopilot to provide the “Heading Select” function.

Heading Select Knob - Used to rotate the heading select bug to a desired point on the compass card.

To-From Indicator - A white triangle near the center of the display that indicates, with reference to the OBS setting, whether the course selected is “to” or “from” the selected VOR station and/or RNAV waypoint.

Dual Glideslope Pointers - Chartreuse triangular pointers on either side of the display drop into view when a usable glideslope signal is received and retract out of view when the glideslope signal becomes marginal. During an ILS approach, these pointers represent the vertical orientation of the aircraft with respect to the center of the glideslope beam. When on glideslope, the pointers will align with the center markers on the glideslope scale.

Glideslope Deviation Scale - White dots on each side of the display which, in conjunction with the glideslope pointers, indicate either “above”, “below”, or “on glideslope” during an ILS approach.

KCS 55A Compass System

Compass Warning Flag - A red flag labeled "HDG" becomes visible in the upper right quadrant of the display whenever the electrical power is inadequate or the directional gyro is not up to speed. Compass failures can occur which will not be annunciated by the "HDG" flag. Therefore, periodic comparison with the standby compass is advised.

NAV Warning Flag - A red flag labeled "NAV" becomes visible in the upper left quadrant of the display whenever a usable signal is not being received.

Slaving Meter (KA 51B)

This meter indicates any difference between the displayed heading and the magnetic heading. Right or up deflection indicates a clockwise error of the compass card. Left or down deflection indicates a counterclockwise error of the compass card. Whenever the aircraft is in a turn and the card rotates, it is normal for this meter to show a full deflection to one side or another.

NOTE: During level flight it is normal for the meter needle to continuously move from side to side and to be fully deflected during a turn. If the needle stays fully deflected, left or right, during level flight, the free gyro mode can be used to center it, as follows:

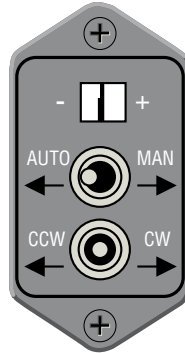

KA 51B Slaving Meter

Slave and Free Gyro Switch - When the switch is in the AUTO position, the system is in the slaved gyro mode. When the switch is in the MAN position, the system is in the free gyro mode.

Clockwise Adjustment - When the system is in the free gyro mode, holding the manual heading switch to the CW position will rotate the compass card to the right to eliminate left compass card error.

Counterclockwise Adjustment - When the system is in the free gyro mode, holding the manual heading switch to the CW position will rotate the compass card to the left to eliminate right compass card error.

The KA 51B Slaving Control and Compensator Unit is a small slaving accessory which can be used in installations where panel space is limited. The KA 51B can be mounted either vertically or horizontally.

KMT 112 Magnetic Slaving Transmitter

This unit senses the direction of the earth's magnetic field and continuously transmits this information through the slaving circuitry to the directional gyro which is automatically corrected for precession or "drift". This sensor is mounted remotely – usually in a wingtip – to eliminate the possibility of magnetic interference.

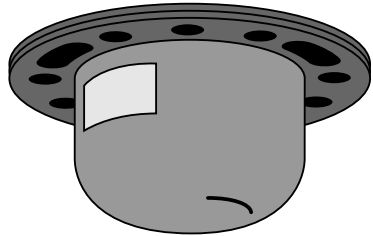

KMT 112 Magnetic Slaving Transmitter

KG 102A Directional Gyro

The directional gyro provides gyro stabilization for the system and contains the slaving circuitry necessary for operation of the system. Power may be for either 14 or 28 volts DC. This sensor is also remote mounted.

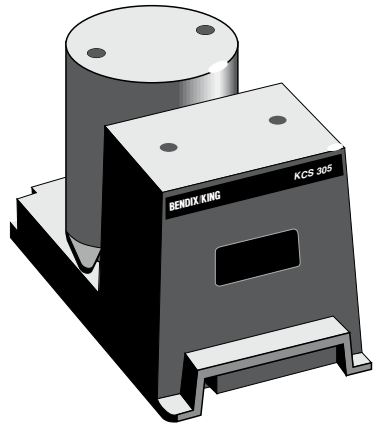

KG 102A Directional Gyro

Operating Instructions

1. Until power is applied to the KCS 55A System, and the directional gyro is up to speed, a red flag labeled "HDG" will be visible in the upper right quadrant of the KI 525A Indicator. In operation, this warning flag will be visible whenever the power being supplied is inadequate or the gyro is not up to speed.
2. With the application of power to the KCS 55A System, and gyro up to operating speed, the red "HDG" flag should disappear from view.
3. If the KCS 55A System is in the slaved gyro mode, the compass card will automatically fast slave at the rate of 180 degrees per minute toward the aircraft's magnetic heading. (Immediately after applying power, this compass card movement should be quite visible.) It will continue to fast slave until the proper magnetic heading is indicated, after which it will slave at a constant rate of three degrees per minute to keep the system aligned with the earth's magnetic field.

- Under some conditions it is possible for the system to stop slaving exactly 180 degrees from the correct heading. If this should occur, move the "Slave" switch on the KA 51B to the unslaved (free) position. Rotate the compass card ± 10 degrees from the incorrect heading by using the manual rotation switch and then return the system to slaved operation. The system will then slave to the correct heading.
4. For the free gyro operation, check the magnetic compass to determine the correct magnetic heading. Then use the manual slave switch to align the system with the earth's magnetic field. Periodic checks with the standby compass are recommended to check and correct for gyro precession.
 5. Until a usable navigation signal is being received by the NAV system, a red flag labeled "NAV" will be visible in the upper left quadrant of the KI 525A Indicator. In operation, this warning flag should be visible whenever an inadequate navigation signal is being received.
 6. For normal navigation to or from a VOR or VORTAC, set the NAV receiver to the desired VOR or VORTAC frequency and the red navigation flag (NAV) should disappear from view if a usable signal is being received.
 7. Rotate the course select knob to position the course pointer to the desired VOR course.
 8. The VOR deviation bar represents the selected course, and the relationship of this bar to the symbolic aircraft in the center of the instrument visually presents the actual relationship of the selected course to your aircraft heading. (In other words, if the symbolic aircraft on the display indicates approaching the deviation bar at 45 degrees, that is the angle at which your aircraft is actually approaching the selected course.
 9. To prepare for an ILS approach, tune the NAV receiver to the desired Localizer frequency. If a usable Localizer signal is being received, the NAV warning flag will disappear.
 10. For a front or back course approach, rotate the course select knob to set the course pointer on the inbound Localizer course. As with normal navigation (#6 above), the LOC deviation bar represents the desired course. The relationship between this bar and the symbolic aircraft gives a true picture of your aircraft's position with respect to the Localizer course. Always setting the course pointer to the inbound Localizer course provides the correct deviation bar sensing whether flying a front or back course approach.
 11. The glideslope deviation pointers should become visible on both sides of the display when a usable glideslope signal is received. If they do not come into view, a usable glideslope signal is not being received.

12. The glideslope pointers indicate the relative position of the glideslope path with respect to the aircraft. (In other words, if the pointers are above the center marker, the aircraft is below the glideslope.)

Abnormal Circumstances

If the Warning Flag (HDG) appears during operation, the compass card indications will be in error. Power may be removed from the KG 102A Directional Gyro by pulling the appropriate circuit breaker. The Selected Course, VOR/LOC Deviation Bar, the NAV flag, and the To/From Indicator will remain in operation.

If the Navigation Warning Flag (NAV) appears during operation, there are several possibilities: (1) the NAV receiver is not turned on, (2) the NAV receiver is improperly tuned, (3) the ground VOR or LOC station is malfunctioning, (4) the aircraft is out of range of the selected ground station, or (5) the aircraft NAV receiver has malfunctioned. (The compass card will continue to display the aircraft heading even if a usable NAV signal is not being received.)

If the glideslope pointers remain out of view during a front course ILS approach, wither the aircraft glideslope receiver or the ground station glideslope transmitter is malfunctioning. Glideslope is usually not available during a back course approach. (The VOR and LOC course display will continue to

function normally even if a usable glideslope signal is not being received.)

A continuous large deflection of the slaving meter or large discrepancies between the magnetic compass and the KI 525A compass card may indicate a failure in the slaving system. If a slaving failure should occur, the Slave/Free Switch should be moved to select the free gyro mode. Then, by using manual clockwise or counterclockwise corrections, the compass can be rotated to the correct heading as indicated on the standby compass. The KCS 55A system should continue to function normally except the heading information will be solely derived from the KG 102A Directional Gyro. There will be no automatic heading correction and periodic adjustments must be made manually to correct for precession by reference to the standby magnetic compass, as with any directional gyro.

Note: It is desirable to disconnect the autopilot under the following conditions:

1. HDG flag comes into view.
2. System is in fast slave.
3. During manual slaving.

The system has the capability to supply the autopilot with an automatic disconnect signal under these conditions.

Note: For system limitations in your particular aircraft type, refer to your Flight Manual Supplement.

KCS 55A Compass System

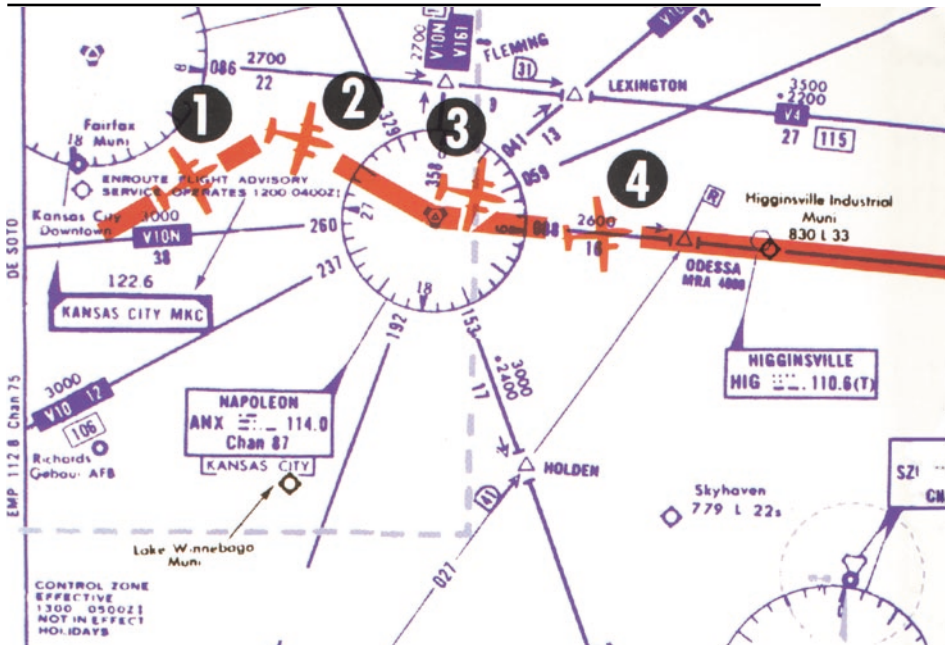

Flight Procedures with the KCS 55A

The next few pages depict a normal flight departure from MKC enroute to STL via Victor Airway V-12. (The charts shown here are for illustration purposes only, not to be used for navigation.) Careful study of these illustration of the KI525A HSI should give you a better idea of how simple and comprehensive the display is.



1. Vectors to Intercept a Radial

After takeoff from Kansas City, we select a heading of 060° with the heading bug to intercept the 110° course to Napoleon (ANX) VOR. Selected course pointer is set on 110° with the course knob. The KI 525A HSI conveniently and accurately displays the intercept angle.



2.

The VOR deviation bar begins to center as we approach the 110° course to Napoleon. The KI 525A HSI makes it possible to intercept the course smoothly, without overshooting or bracketing. One method of doing this is to adjust your heading so that the top of the deviation bar always touches the lubber line. As your aircraft heading approaches the new course, the deviation bar will swing towards the center and the angle of intercept will decrease.

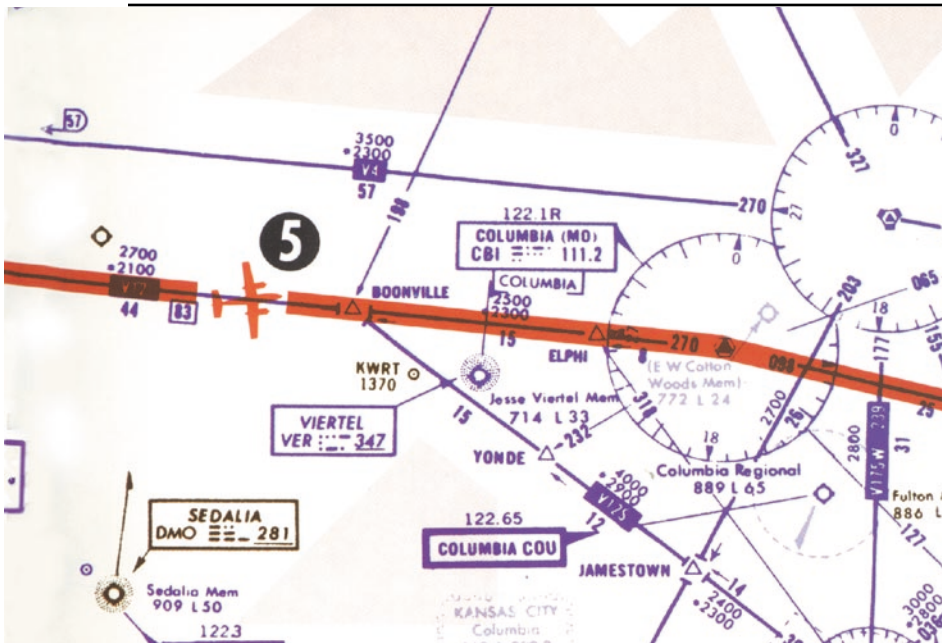

3. Turn to Intercept a Victor Airway

The "TO" indicator starts to swing to "FROM" as you fly over the Napoleon VORTAC station. At this time, set the selected course pointer on the V-12 course of 088°.

As you begin your left turn to track V-12, notice that the KI525A HSI continuously displays an accurate picture of the relationship between your aircraft and the ANX 088 radial.

Once again, you can make a precise, coordinated course interception by adjusting your heading to keep the top of the deviation bar touching the lubber line.



4.

When the deviation bar is centered and aligned with the course arrow, you are on course. Notice that correction for wind drift - in this case, a 080° heading on a 088° course - is completely automatic as long as you keep the deviation bar centered.



5.

About midway between Napoleon and Columbia (CBI), you switch to the CBI VOR and the TO/FROM indicator immediately swings to "TO". Also note the course arrow should be moved from 088° to 090° which is the V-12 inbound course to CBI.

KCS 55A Compass System

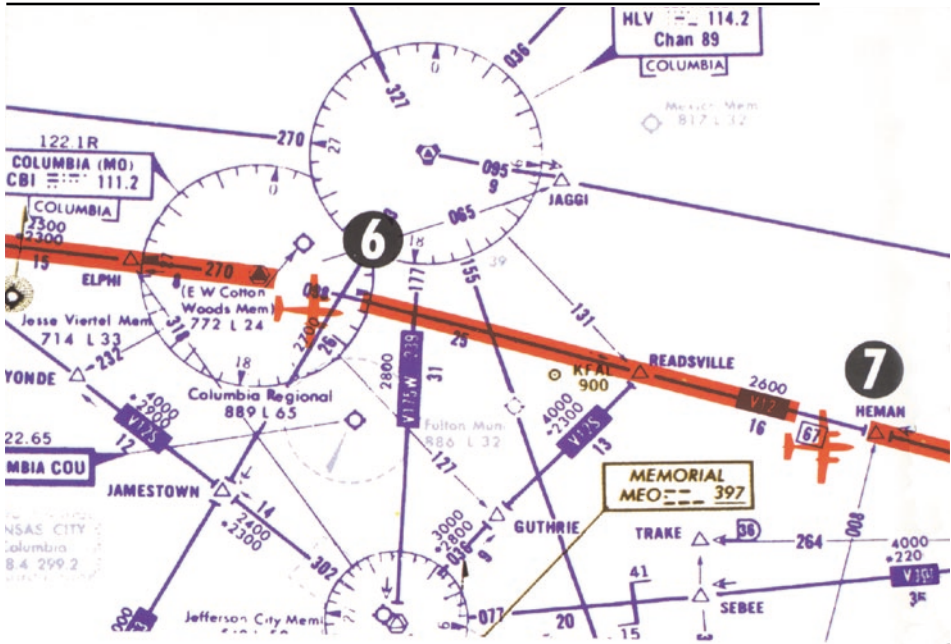

6. As you fly over the Columbia station, the TO/FROM indicator changes to "FROM". Since the outbound course for V-12 from Columbia to Foristell (FTZ) is 098°, you now set the selected course pointer on 098° and fly to keep the deviation bar centered.



7. Near the Herman intersection you switch to Foristell VOR-TAC and move the course arrow to 100°, which is the V-12 inbound course to FTZ. The TO/FROM indicator changes to "TO".

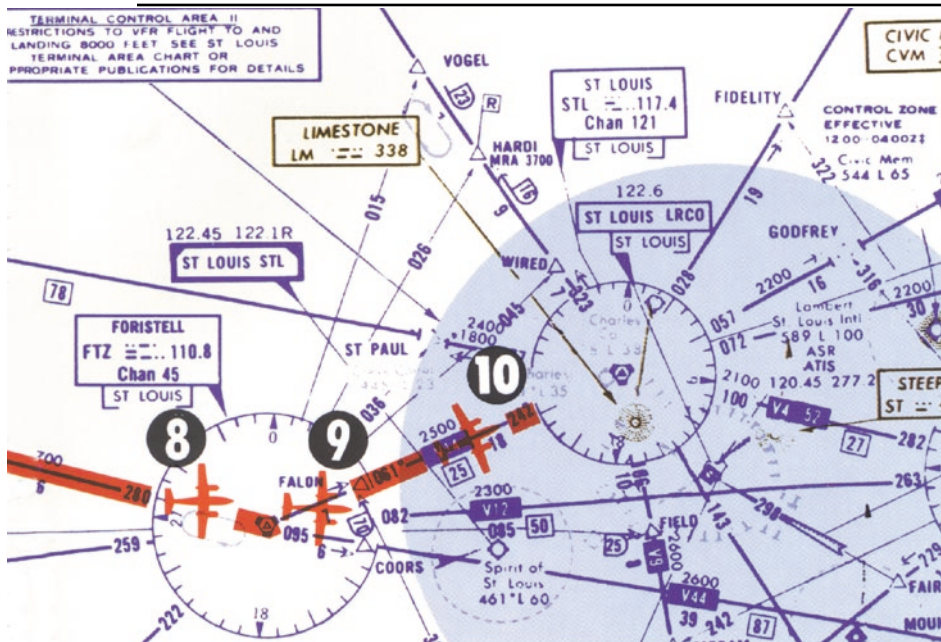

8. Airway Interception

Your clearance is V-12 to Forstell, then V-14 to the St. Louis (STL) VORTAC, direct Lambert Field. Approaching the FTZ station, the heading bug is on 100° as a reference for the V-12 course or as heading command for the autopilot, if used. Select the St. Louis VORTAC on the NAV receiver and set the course pointer on the STL 062° course.



9.

As you cross the Forstell VORTAC, the deviation bar will align with the course arrow. Now set the heading bug to 062° and turn left to follow V-14 to the STL VORTAC.



10.

You are now established on V-14, flying to the STL VORTAC. Once again, if you fly to keep the deviation bar centered, correction for wind drift will automatically be accomplished.

Note: For system limitations refer to your Flight Manual Supplement.

HOLDING PATTERN

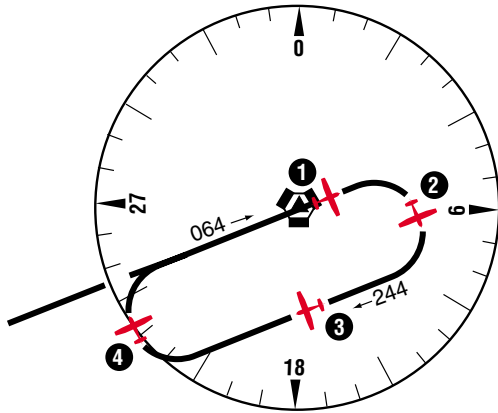

1. Approaching the STL VORTAC, the controller asks you to hold southwest of the VORTAC on the 244° radial, right turns. You are now over the station with a 064° course selected (the TO/FROM indicator has swung to "FROM"). Set your heading bug to the reciprocal or outbound heading of 244° for easy reference and begin your right turn holding pattern.



2. Halfway through the outbound turn, the KI 525A display shows the deviation bar behind the symbolic aircraft. You know, therefore, that you must eventually fly back to the radial in order to be on course during the inbound leg of the holding pattern.



3. Outbound, you are using the heading bug as reference for 244°. The 244° radial is off the right wing and parallel to your outbound course.



4. Halfway through your turn to the inbound 064° course, the KI 525A shows the symbolic aircraft approaching the deviation bar at a right angle. By keeping the top of the deviation bar on the lubber line, you can complete your turn and roll out precisely on course.

Note: For system limitations refer to your Flight Manual Supplement.

**ILS APPROACH-
FRONT COURSE**

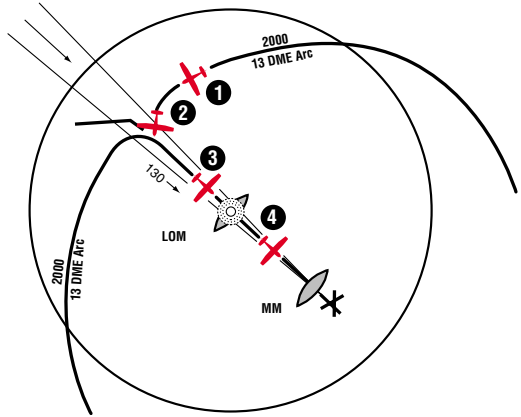

1. You are vectored from the holding pattern to the 13 DME arc. The aircraft is turning, with the heading bug set on 170° to intercept the localizer. You have already set the selected course pointer on the inbound ILS course 130° and the KI 525A shows the localizer course is directly ahead. The glideslope pointers came into view when the ILS frequency was tuned, since a usable glideslope signal is being received.



2. Capturing the ILS course can be accomplished without overshooting or bracketing with the same technique you used in intercepting an enroute course. Simply keep the top of the deviation bar on the lubber line and coordinate your turn until the bar is centered with the course arrow. Each dot on the LOC deviation scale represents 1/2 degree of deviation when tuned to an ILS frequency.



3. The KI 525A shows you that you have intercepted the localizer course. The glideslope pointers have started to center, although the display indicates your aircraft is still below the glidepath at this point.



4. You are now centered on the localizer and the glideslope. Once again, the KI 525A shows your aircraft is crabbed about 5° to the right to maintain the localizer course.

Note: For system limitations refer to your Flight Manual Supplement.

BACK COURSE APPROACH - (REV)

If a back course approach is required, it can be accomplished as easily as a front course approach. The course arrow should always be set on the front course inbound localizer course. This will result in conventional pictorial deviation sensing even on back course. The KI 525A display gives you an accurate picture of where you are at all times during the approach and procedure turn.

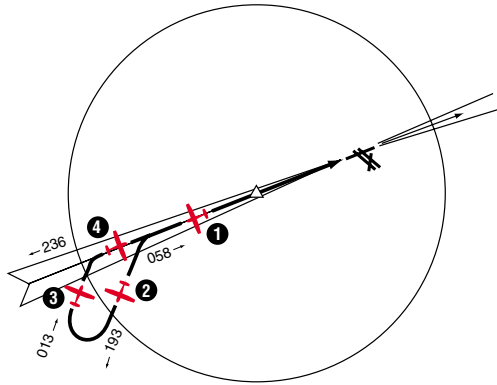

1. You are outbound on the back localizer course, having already set the course pointer to the inbound front course at 238°. The heading bug is preset at 193° for the procedure turn. (Since there is usually no glideslope signal on a back course, the glideslope pointers are out of sight.)



2. During the procedure turn outbound, the deviation bar shows pictorially that the aircraft (as represented by the symbolic aircraft in the center of the KI 525A) is flying away from the localizer centerline at a 45° angle when the heading bug is under the lubber line. Note that left-right deviations of the course bar give "fly-to" indicators, just as on the front course.



3. Now you've reset the heading bug to 013° and made a 180° turn to this heading. This 013° heading will intercept the back course. The KI 525A clearly pictures the course you are to intercept and the angle of interception.

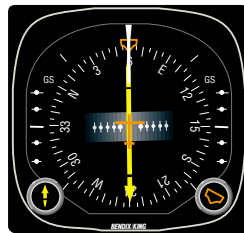

4. You have smoothly intercepted the back course. Since the course arrow is set on the front course (238°), the KI 525A shows a true picture of the situation - flying inbound on the back course. You may reset the heading bug to 058° for easy reference.

Note: For system limitations refer to your Flight Manual Supplement.

Abnormal Procedures

Autopilot Malfunction

An autopilot, autopilot trim or manual electric trim malfunction may be recognized as an uncommanded deviation in the airplane flight path or when there is abnormal control wheel or trim wheel motion. The primary concern in reacting to an autopilot or trim malfunction, or to an automatic disconnect of the autopilot, is in maintaining control of the airplane. Immediately grasp the control wheel and press and hold down the A/P DISC/TRIM INTER switch throughout the recovery. Manipulate the controls as required to safely maintain operation of the airplane within all of its operating limitations.

CAUTION: Refer to the *Airplane Flight Manual* or the *Airplane Flight Manual Supplement* for your particular aircraft for pertinent emergency procedures.

This page intentionally left blank

Honeywell International Inc.
One Technology Center
23500 West 105th Street
Olathe, Kansas 66061
FAX 913-791-1302
Telephone: (913) 782-0400

Copyright © 1998, 2002 Honeywell International Inc.
All rights reserved.

006-18034-0000
Rev. 2 5/02

Honeywell