

**TRICOM**  
RESEARCH INC.

**OPERATOR'S MANUAL  
TCR-U/L-25 - UHF/L-BAND  
RF AMPLIFIER**



**DOCUMENT # 90400-01178**

Tricom Research, Inc. • <http://www.tricomresearch.com>

17791 Sky Park Circle, Suite J, Irvine, CA 92614

Ph: (949) 250-6024 fax: (949) 250-6023

---

## TCR-U/L-25 OPERATOR'S MANUAL

Revision History - Document 90400-01178

Revision      Description      Date

Revision	Description	Date
P1	Preliminary Release	18 Oct 2013
P2	Updated size and power output specifications, updated outline figures and drawings	18 Jun 2014
P3	Updating for automatic mode detection	10 Nov 2014
P4	Reformatted Figures 3-1 and 3-6	11 Dec 2014
A	Updated for current production Release	6 Mar 2015
B	Reconcile with data sheets	2 Apr 2018

# TCR-U/L-25 OPERATOR'S MANUAL

## TABLE OF CONTENTS

<b>1.0</b>	<b>INTRODUCTION</b>	
1.1	General Information.....	1
1.2	Abbreviations and Glossary.....	2
1.3	Equipment Description.....	3-6
1.4	Features.....	6
1.5	TCR-U/L-25 System.....	6
1.5.1	Amplifier Components.....	6
1.5.2	Power Cable.....	7
1.6	Specifications.....	7-8
<b>2.0</b>	<b>OPERATION</b>	
2.1	General Information.....	9
2.2	Controls, Indicators, and Connectors.....	9-10
2.3	Operation.....	11
2.3.1	General Information.....	11
2.3.2	Equipment Set-up.....	11
2.3.3	Operating Procedures.....	11
2.3.3.1	Push Button Switch Operation.....	11-12
2.3.3.2	LNA Operation Precautions.....	12
2.3.3.3	Remote Control Operation.....	12
2.3.3.4	Out of Band Operation.....	12
2.3.3.5	Bypass Operation.....	12
2.3.3.6	Troubleshooting.....	12
<b>3.0</b>	<b>INSTALLATION</b>	
3.1	General Information.....	14
3.2	Preparation for Use.....	14
3.3	Mounting Provisions.....	14
3.4	DC Input Power.....	15
3.5	RF Interconnections.....	15
3.6	Remote Control Interface.....	19
3.7	Remote Control Command Set.....	21

# TCR-U/L-25 OPERATOR'S MANUAL

## LIST OF TABLES

Table 1-1	Nominal Performance Specifications .....	7
Table 1-2	Interconnect Characteristics.....	8
Table 2-1	Mode Indicators .....	10
Table 2-2	Front Panel Controls .....	10
Table 2-3	I/O Connectors .....	10
Table 2-4	Troubleshooting Guide .....	11
Table 3-1	DC Input Power Connector Pinout .....	17
Table 3-2	Auxiliary Connector Pinout .....	19
Table 3-3	Remote Control Command Set .....	21

## LIST OF FIGURES

Figure 1-1	TCR-U/L-25.....	1
Figure 2-1	Amplifier Controls & Indicators.....	9
Figure 2-2	Amplifier Connections.....	9
Figure 3-1	TCR-U/L-25 Outline Drawing (1 of 2).....	15
Figure 3-2	TCR-U/L-25 Outline Drawing (2 of 2).....	16
Figure 3-3	Amplifier DC Input Connector .....	17
Figure 3-4	Military Vehicle DC Power Cable.....	18
Figure 3-5	Auxiliary Connector Pinout .....	19
Figure 3-6	USB Remote Control Cable.....	20
Figure 3-7	RS-232 Remote Control Cable .....	20

Appendix A	MS Windows Serial Comm Port Reassignment .....	22
------------	--	----

Note: The information contained herein is for reference only and does not constitute a warranty of performance.

## 1.0 INTRODUCTION

### 1.1 GENERAL INFORMATION

This manual provides operating instructions for the TCR-U/L-25 Multiband Amplifiers shown in Figure 1-1. The TCR-U/L-25 amplifier is designed to provide transmit and receive gain for the following modes of operation:

- SRW and ANW2 Wideband Networking Waveforms in the 225-450 MHz band (UHF band)
- SRW and ANW2 Wideband Networking Waveforms in the 1250-1390 MHz band (L1 band)
- SRW and ANW2 Wideband Networking Waveforms in the 1750-1850 MHz band (L2 band)
- L3 is for future use and consideration

Part number: 11000-00794

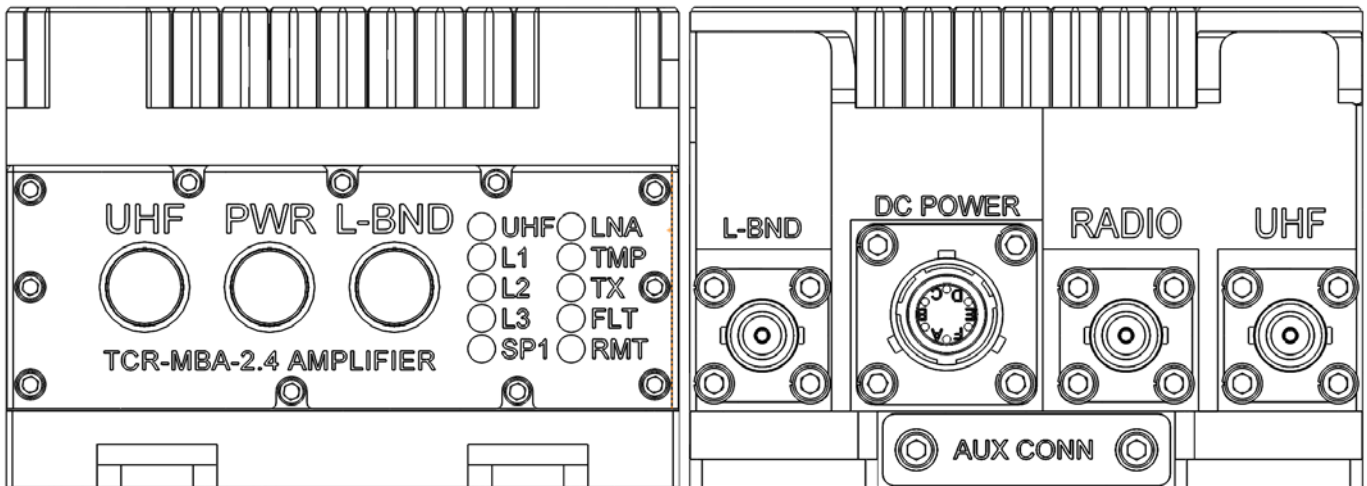

Figure 1-1 TCR-U/L-25

## 1.2 ABBREVIATIONS AND GLOSSARY

AGC	Automatic gain control
ALC	Automatic level control
AM	Amplitude modulation
ANT	Antenna
ANW2	Advanced Networking Wideband Waveform
BPS	Bits per second
CT	Cipher text
CW	Continuous wave
COMSEC	Communications security
dB	Decibel
dBm	Decibel referenced to 1 milliwatt (0 dBm = 1 mW)
FM	Frequency modulation
Hz	Hertz
IW	Integrated Waveform
JITC	Joint Interoperability Test Center (DISA)
kHz	Kilohertz
LED	Light emitting diode
LNA	Low Noise Amplifier
LOS	Line of sight
MHz	Megahertz
mW	Milliwatt
PT	Plain text
PTT	Push to Talk
RCV	Receive
SATCOM	Satellite Communications
SF	Single Frequency
SRW	Soldier Radio Waveform
UHF	Ultra-high frequency
VDC	Volts, direct current
VSWR	Voltage standing wave ratio
W	Watt
WB	Wideband
XMT	Transmit

## 1.3 EQUIPMENT DESCRIPTION

The TCR-U/L-25 is a bi-directional half duplex RF Power Amplifier that uses the same form factor as the TCR-MBA-50 WB. It provides transmit amplification for 225-450 MHz, 1250-1390 MHz and 1750-1850 MHz for ANW2 and SRW Wideband Networking operation. A low noise amplifier provides receive gain for all three bands. The TCR-U/L-25 is suitable for vehicular, airborne, man-portable or fixed-station applications and is compatible with most military radios operating in the UHF and L-Band frequency spectrum for Wideband Networking operation. The amplifier can be controlled locally via the front panel switches or from USB and RS-232 interfaces for remote control operation. The amplifier is also set up for automatic frequency and mode detection (user interface with front panel buttons is not necessary but is available). The amplifier has a DC input connection; a radio RF input port and two mode specific antenna ports. The UHF mode port is for operation from 225-450MHz. The L-BND mode port is band limited to 1250-1390 MHz and 1750-1850 MHz.

### 1.3.1 USER SET MODES.

The following modes are available to the user via the front panel push buttons or with the remote interface (and through Tx automatic mode detection):

#### **UHF MODE BUTTON**

225-450 MHz ANW2/SRW WB (Wideband Networking Waveforms) LNA ON  
LNA is always on in this system and mode

#### **L-BND MODE BUTTON**

L1 ANW2/SRW WB (Wideband Networking Waveforms) LNA ON  
L2 ANW2/SRW WB (Wideband Networking Waveforms) LNA ON  
L3 Not used  
LNA is always on in this system and in these modes

The mode button selection determines which output antenna port is active. If the UHF button is pressed while the amplifier is in an L-band mode, the amplifier will return to the last used UHF mode. The next UHF button press will sequence to the next available UHF mode. The same is true for the L-BND button when pressed while in UHF mode. This way, the user may toggle between set UHF and L-band modes by alternately pressing the two mode control buttons, without having to cycle through the entire menu structure. Also, the amplifier is set up to automatically detect what Tx mode it should be in when it receives an RF signal. If no buttons are pressed, the amplifier will detect the proper mode to transmit in, and then remain in that mode until either a button is pressed, or a frequency in a different mode is transmitted.

### 1.3.2 TRANSMIT POWER LEVELS.

The PA has only one output power level of 25 Watts average.

### **1.3.3 POWER ON, INITIALIZATION AND MODE CHANGES.**

A single pushbutton switch provides power ON/OFF control and LED intensity control. Holding the button down longer than 2 seconds will dim the LEDs in 4 steps at 1 second intervals before the PA shuts down; releasing the PWR button before the PA shuts down will set the LED intensity at one of 4 levels (high, medium, medium low, low). The UHF and L-BND mode buttons will cycle through the operational modes described in Section 1.3.1. Non-volatile memory will remember the last operational state and the PA will return to that state when power is restored. See Section 1.3.1 for automatic mode detection as well.

If PIN E (auto-start) on the DC input power connector is unconnected (open) and the DC supply is disconnected and re-connected the PA will remain in the OFF state until the PWR button is used to turn the PA back on. After turning on, the PA will return to the last operating mode. If power is shut off using the PWR button and the DC supply is then disconnected and re-connected, the PA will likewise remain in the OFF state.

If PIN E on the DC input power connector is tied to Electrical GROUND (auto start configuration) and the DC power is disconnected and re-connected, the amplifier will automatically power ON into the last operational mode. This feature is useful in installations where the front panel is not accessible and DC power is controlled remotely.

### **1.3.4 MODE OF OPERATION INDICATORS.**

There are ten front panel LED's used to indicate the different modes of operation and power amplifier operational status. Table 2-1 describes the LED indicators for the different modes of operation.

#### **1.3.4.1 UHF MODE INDICATOR (UHF).**

The UHF LED will illuminate whenever UHF mode is selected (UHF LNA ON).

#### **1.3.4.2 LOW NOISE AMPLIFIER MODE INDICATOR (LNA).**

The LNA LED will illuminate at all times. The LNA is always on when the amp is in receive mode. There is no LNA bypass in this system.

#### **1.3.4.3 L-band 1 MODE INDICATOR (L1).**

The L1 LED will illuminate whenever L1 mode is selected (L1 LNA ON).



#### **1.3.4.4 L-band 2 MODE INDICATOR (L2).**

The L2 LED will illuminate whenever L2 mode is selected (L2 LNA ON).

#### **1.3.4.5 L-band 3 MODE INDICATOR (L3).**

The L3 LED is not functional as of the writing of this manual and is reserved for future enhancements to the PA.

#### **1.3.4.6 SP1 INDICATOR (SP1).**

The SP1 LED is not functional as of the writing of this manual and is reserved for future enhancements to the PA.

#### **1.3.4.7 OVER TEMPERATURE INDICATOR (TMP).**

The TMP LED indicates an over temperature condition.

#### **1.3.4.8 TX STATUS INDICATOR (TX).**

The TX LED will illuminate during a good transmit condition. Depending on the duty cycle of some data transmission waveforms such as ANW2 and SRW, the TX LED may flicker. This is due to the fast switching time between transmit and receive and DOES NOT indicate a system malfunction.

#### **1.3.4.9 FAULT STATUS INDICATORS (FLT).**

The FLT LED will illuminate to indicate a fault condition, such as attempting to transmit at a frequency that is not valid in the selected mode or over temperature conditions.

#### **1.3.4.10 REMOTE OPERATION STATUS INDICATOR (RMT).**

The REMOTE LED will illuminate when the PA has received a **REMOTE ON** command from an external terminal and will stay on until the **REMOTE OFF** command has been received. Note that the front panel UHF and L-BND buttons are ignored during remote operation. (Page 12 and section 3 offer additional information on remote operation)

### **1.3.5 REMOTE CONTROL INTERFACE.**

USB (+5, GND, D+ and D-) and RS-232 interfaces (GND, TXD and RXD only) will provide remote control of the amplifier's modes of operation and power levels. When a terminal has been connected to the remote interface and the proper escape sequence has been sent by the terminal (refer to sections 3.5 and 3.6 for remote control operation) the PA will start communications with the terminal and will illuminate the RMT LED on the front panel. At this point the TCR-U/L-25 front panel buttons will become inactive, except to power the amplifier

off. The PA will NOT detect the removal of the remote interface connection and will remain in remote mode until the power is cycled OFF, if the remote control cable is unexpectedly removed.

## **1.4 FEATURES**

The TCR-U/L-25 has the following features:

- ANW2 and SRW Wideband Networking Waveforms compatible in the 225-450 MHz, 1250-1390 MHz and 1750-1850 MHz bands
- Connections for UHF and L-band antennas
- Pre-amplification of received RF signals from antennas connected to the UHF and L-band ports
- Power amplification of transmit signals to 25 Watts
- Transmit and receive band filtering to suppress interference from co-located radios and amplifiers in UHF and L-band modes
- Amplifier front panel indication of system status
- Automatic frequency/mode detection and selection of proper mode (UHF, L1, L2)

## **1.5 TCR-U/L-25 SYSTEM**

The TCR-U/L-25 is pictured in Figure 1-1.

### **1.5.1 Amplifier Components**

The Amplifier consists of several printed circuit board assemblies, a filtering and switching network, and RF connectors housed in a water resistant aluminum housing. With normal care and maintenance, the assembly is highly resistant to corrosion from the elements. The RF connections to the RF radio input, UHF antenna and L-BND antenna are BNC female. Power to the amplifier is applied via a cable connected to a six pin circular DC input connector.

## 1.5.2 Power Cable

A multi-conductor cable connects the amplifier with an external DC power source. A wiring diagram for the cable is shown in Section 3 of this manual. The DC power cable used with the legacy TCR-MBA-25 and TCR-MBA-50 WB power amplifiers may be used to power the TCR-U/L-25 even if they are wired for battery or commercial vehicle operation (the TCR-U/L-25 ignores the DC input power mode pins C and D and operates the PA only in military vehicle mode); however, the connection for the Auto Power ON (pin E electrically grounded on the power cable) may have to be added (refer to paragraph 2.3.3.1).

## 1.6 Specifications

The operating parameters, physical characteristics, and environmental specifications are shown in the following tables.

**Table 1-1. Nominal Performance Specifications**

### **TRANSMIT SECTION**

#### **UHF OPERATION**

Frequency Range	225-450 MHz with Automatic Frequency Detection
Band Selection	Fully automatic
RF Power Input	1-5 Watts (2W typical)
RF Power Output	25 W Avg

#### **L-BAND OPERATION**

Frequency Range	1250-1390 MHz and 1750-1850 MHz with Automatic Frequency Detection
Band Selection	Fully automatic
RF Power Input	1-5 Watts (2W typical)
RF Power Output	25 W Avg

#### **SATCOM OPERATION**

Frequency Range	292-318 MHz
Switching speed	JITC DAMA, IW, ASCM compatible
RF Power Input	1-5 Watts (2W typical)
RF Power Output	25 W Avg

### **RECEIVE SECTION**

#### **UHF WB/SATCOM OPERATION**

Frequency Range	225-450 MHz
Noise Figure	3.75 dB typical
Receive Gain	6 dB typical

**L-BAND OPERATION**

Frequency Range	1250-1390 MHz, 1750-1850 MHz
Insertion Loss	<3.5 dB
Noise Figure	3.75 dB UHF 4 dB L1 5 dB L2
Receive Gain	6 dB typical

**ADDITIONAL SPECIFICATIONS**

Radio Connector	BNC female
UHF Antenna Connector	BNC female
L-BND Antenna Connector	BNC female
DC Connector	MS3112E10-6P
Auxiliary Connector	Optional RS-232 Cable (PN 77500-00390), Optional USB Cable (PN 77500-00391)
High Temperature	High Temperature Indication/Fold back
DC Off	Routes Radio signal to UHF port
Operating Temperature	-30 to +60 C
Cooling	Natural Convection
Dimensions	2.5” H x 3.5” W x 8.15” D
Weight	5.2 lbs.

The information in section 1.6 is included for reference only and does not constitute a warranty of performance.

**Table 1-2. Interconnect Characteristics**

Connection	Signal/Pin	Connector Function
DC IN	DC power input	MS3112E10-6P (mating connector for cable use is MS3116F10-6S)
	PIN A	12-32 VDC Input
	PIN B	GND
	PIN C	Reserved
	PIN D	Reserved
	PIN E	Auto Power On Select
	PIN F	Reserved
RADIO	RF from radio	Type BNC female
UHF	To UHF Antenna	Type BNC female
L-BND	To L-Band Antenna	Type BNC female

## 2.0 OPERATION

### 2.1 General Information

This section provides information for operating the TCR-U/L-25.

#### WARNING

Electromagnetic radiation from the antenna can damage eyes and other body tissue when the system is transmitting. **DO NOT** stand directly in front of the antenna or in close proximity to the sides or back of the antenna when transmitting.

### 2.2 Controls, Indicators, and Connectors

The TCR-U/L-25 has three push button switches to control:

- Power ON/OFF and LED intensity (PWR button)
- UHF Modes of Operation (UHF button)
- L-Band Modes of Operation (L-BND button)

There are also several status indicators on the amplifier's front panel as shown in Figure 2-1. The functions of these are specified in Tables 2-1, 2-2 and 2-3

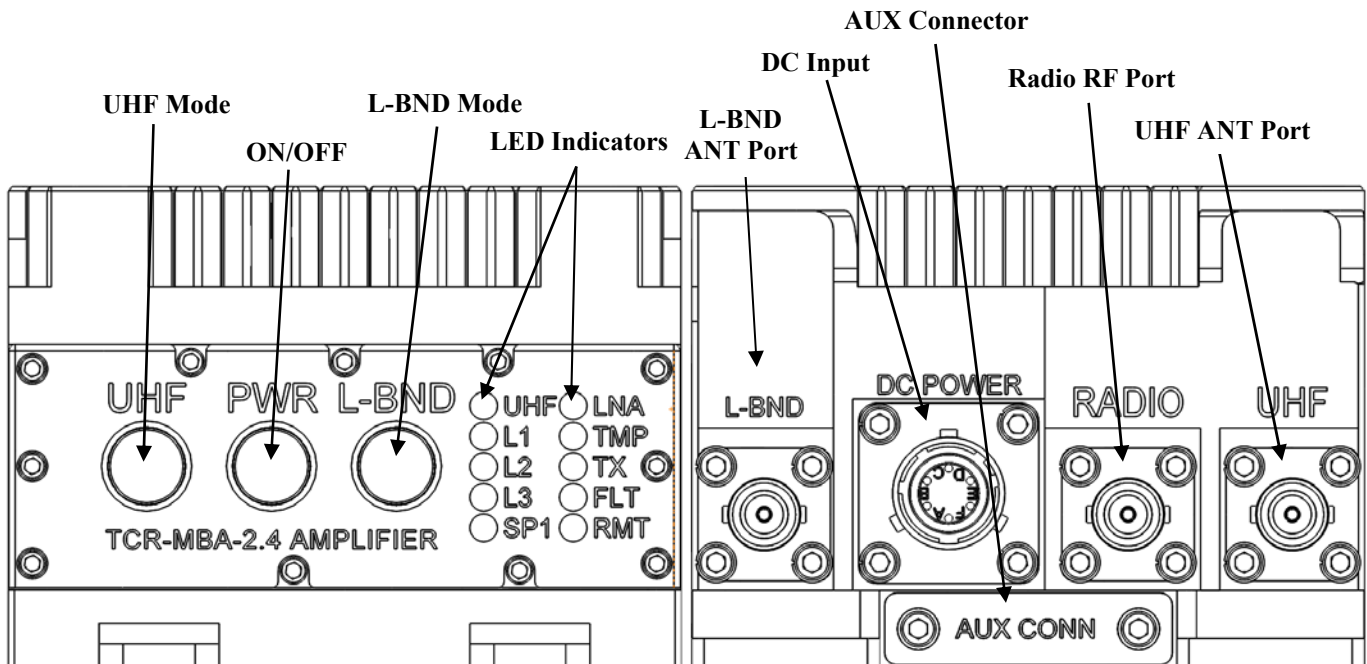

Figure 2-1. Amplifier Controls & Indicators

Figure 2-2. Amplifier Connections

**Table 2-1. Mode Indicators**

MODE OF OPERATION	LED					
	UHF	L1	L2	LNA		
<b>UHF MODES</b>						
UHF LNA ON	ON			ON		
<b>L-BAND MODES</b>						
L1 LNA ON		ON		ON		
L2 LNA ON			ON	ON		

The modes of operation will cycle in the order indicated in Table 2-1 from top to bottom. The settings will cycle through in a loop, to select a different mode; the mode switch must be pressed repeatedly until the next desired mode of operation is selected.

**Table 2-2. Front Panel Controls**

CONTROLS	TYPE	FUNCTION
ON/OFF	Push Button Switch	Selects ON or OFF (Bypass) mode of operation and LED intensity (button press >2 seconds but <6 seconds). After 6 seconds the PA shuts down. When in Bypass, the amplifier makes a connection from RADIO input to the UHF connector output.
UHF MODE	Push Button Switch	Selects the UHF modes of operation (refer to Table 2-1)
L-BND MODE	Push Button Switch	Selects the L-Band modes of operation (refer to Table 2-1)

**Table 2-3 I/O Connectors**

CONNECTIONS	TYPE	FUNCTION
UHF Antenna	BNC Type RF connector	Used to attach UHF Antenna
RADIO	BNC Type RF Connector	Used to attach to Transceiver
L-BND Antenna	BNC Type RF Connector	Used to attach L-Band Antenna
DC Power input connection	Circular Mil connector	Used to apply DC power input to amplifier
Auxiliary Port	Custom 12 pin flat contact connector	Used for remote control and other special functions

## 2.3 Operation

### 2.3.1 General Information

The TCR-U/L-25 can be used for operation once it has been installed as described in Section 3.

### 2.3.2 Equipment Set-up

Refer to Paragraph 2.2 for the locations and functional description of the controls and indicators. Make sure that the TCR-U/L-25 has been installed according to the instructions provided in Section 3.

### 2.3.3 Operating Procedures

#### 2.3.3.1 Push Button Switch Operation

In normal operation, the TCR-U/L-25 provides transmit power amplification for radios operating in the 225-450 MHz, 1250-1390 MHz and 1750-1850 MHz bands. The mode switches provide selection for either the UHF or L-Band modes. RF output to the UHF or L-BND antenna ports is automatically selected and determined by the mode selected. Push button operation is available, but it is not necessary as the amplifier is built to automatically detect the incoming RF Tx frequency and switch to the proper mode (UHF, L1, L2).

**PWR button - ON/OFF-** To turn the amplifier ON, press and hold the PWR button for more than 1-2 seconds. The PA will turn ON and display the current power level for approximately 3 seconds (the PA will only display the power level of 25 watts but it cannot be adjusted). The PWR button cycles the TCR-U/L-25 from power ON to power OFF (UHF Bypass mode). To switch the power amplifier back to the Power OFF (Bypass mode) press and hold the PWR button for more than 6 seconds (the LEDs will dim as the PWR button is pressed and held down). When in the Power OFF Bypass mode the RF is automatically routed to the UHF antenna port directly from the transceiver. The Amplifier remembers the last state it was in when powered down.

If the auto power ON mode is selected by electrically grounding pin E on the DC input power connector, the power to the PA can be turned ON or OFF by turning on or off the DC supply. If the auto power ON mode is not enabled, removing the DC power will turn the power amplifier OFF but the PWR button must be used to turn the power amplifier back ON when external DC power is restored.

**PWR button – LED Intensity Level Select-** Press and hold the PWR button for more than 2 seconds to select one of four available LED intensity levels (high, medium, medium low, low). As the button is held down for more than 2 seconds, the LED intensity will decrease to the next level; however, if the button is held down for more than 6 seconds the PA will shut down. To select an LED intensity level, simply release the PWR button when the desired brightness is displayed. If the external DC power is interrupted, the LED brightness will default to HIGH when power is restored and the PA is turned back on using the PWR button; however, shutting

down and turning the PA back on using the PWR button will remember the last LED intensity level.

**UHF Mode-** Press the UHF mode button to select the UHF. When UHF mode is selected, RF is routed to the UHF antenna port. The LNA provides an average 6dB receive gain for use in disadvantaged installations where either omni-directional UHF antennas are used or when there are long runs of RF cable loss to overcome.

**L-Band Mode-** Press the L-BND mode button to select L1 or L2 modes (refer to Table 2-1) and to toggle the LNA on and off as described in Table 2-1. The L-Band mode routes the RF to the L-BND antenna port. The LNA provides an average 6dB receive gain for use in disadvantaged installations where either Omni-directional L-Band antennas are used or when there are long runs of RF cable loss to overcome.

### **2.3.3.2 LNA Operation Precautions**

There may be an interoperability issue when operating certain radios with amplifiers that have a receive Low Noise Amplifier (LNA). Using the LNA with certain radios may cause intermittent squelch break on the radio.

### **2.3.3.3 Remote Control Operation**

The TCR-U/L-25 can be controlled remotely via a USB or asynchronous RS-232 interface (refer to section 3 for a functional description of these interfaces).

### **2.3.3.4 Out of band operation**

Operating outside the frequency band for the selected mode of operation (225 – 450 MHz for UHF mode, 1250-1390 MHz for L1 mode and 1750-1850 MHz for L2 mode) will cause the FLT light to flash. The amplifier will go into a “failsafe” UHF bypass mode. The fault will be cleared when the transmit signal is removed. The amplifier will then return to its previous operating mode.

### **2.3.3.5 Bypass Operation**

When DC power is removed or when the AMP Bypass mode is selected (pressing the PWR button for more than 6 seconds) the radio port is directly connected to the UHF antenna port.

### **2.3.3.6 Troubleshooting**

If the communications system seems to be operating improperly, check to make sure that the equipment is configured in accordance with Section 3. If the problem persists follow the instructions below.



**Table 2-4. Troubleshooting Guide**

---

<b>SYMPTOM</b>	<b>PROBABLE CAUSE</b>	<b>SUGGESTED FIX</b>
XMT light ON in conjunction with FLT light flashing when transmitting	Incorrect operating frequency for selected mode. Or RF source is sweeping (not fixed frequency)	Change mode or frequency for proper operation.  Do not use a swept source
FLT light flashes Constantly, output power is reduced.	PA has exceeded its normal operating temperature limit.	Provide additional airflow or reduce transmission time. The PA automatically reduces output power under high temperature conditions.
FLT light ON, Radio connected to UHF port.	PA has exceeded its high temperature limit and is in “failsafe” mode – the equivalent of UHF Bypass.	Operation will return to normal and the FLT light will extinguish once the PA reaches normal operating temperature.

---

## **3.0 INSTALLATION**

### **3.1 General Information**

This section contains information necessary for preparing the TCR-U/L-25 for use.

### **3.2 Preparation for Use**

After unpacking the system and inspecting for physical damage, select an appropriate location for the Amplifier. Although the Amplifier is weather-resistant, placing it in a location where it is protected from direct salt spray, rain, and sunlight will increase its service life. Make sure that adequate air flow is available to allow proper convection cooling.

### **3.3 Mounting Provisions.**

The TCR-U/L-25 can be mounted using existing mounting holes for the TCR-MBA-25 and TCR-MBA-50 WB power amplifiers (refer to Figure 3-1). These holes accommodate #10-32 screws, which screw into tapped 10-32 X 0.220 deep holes on the amplifier. Ensure the proper length screw is used to prevent damage to the threaded holes on the amplifier.

The power amplifier can also be mounted by using two mounting tabs in the front and two mounting holes on flanges in the rear. The tabs must be mounted first using 100° #8 flat head screws. To mount the power amplifier, simply slide the two front slots on the front of the power amplifier onto the two tabs and secure the rear flanges with two #4 pan head screws. Other mounting points are included on the sides of the amplifier to accommodate a variety of mounting options.

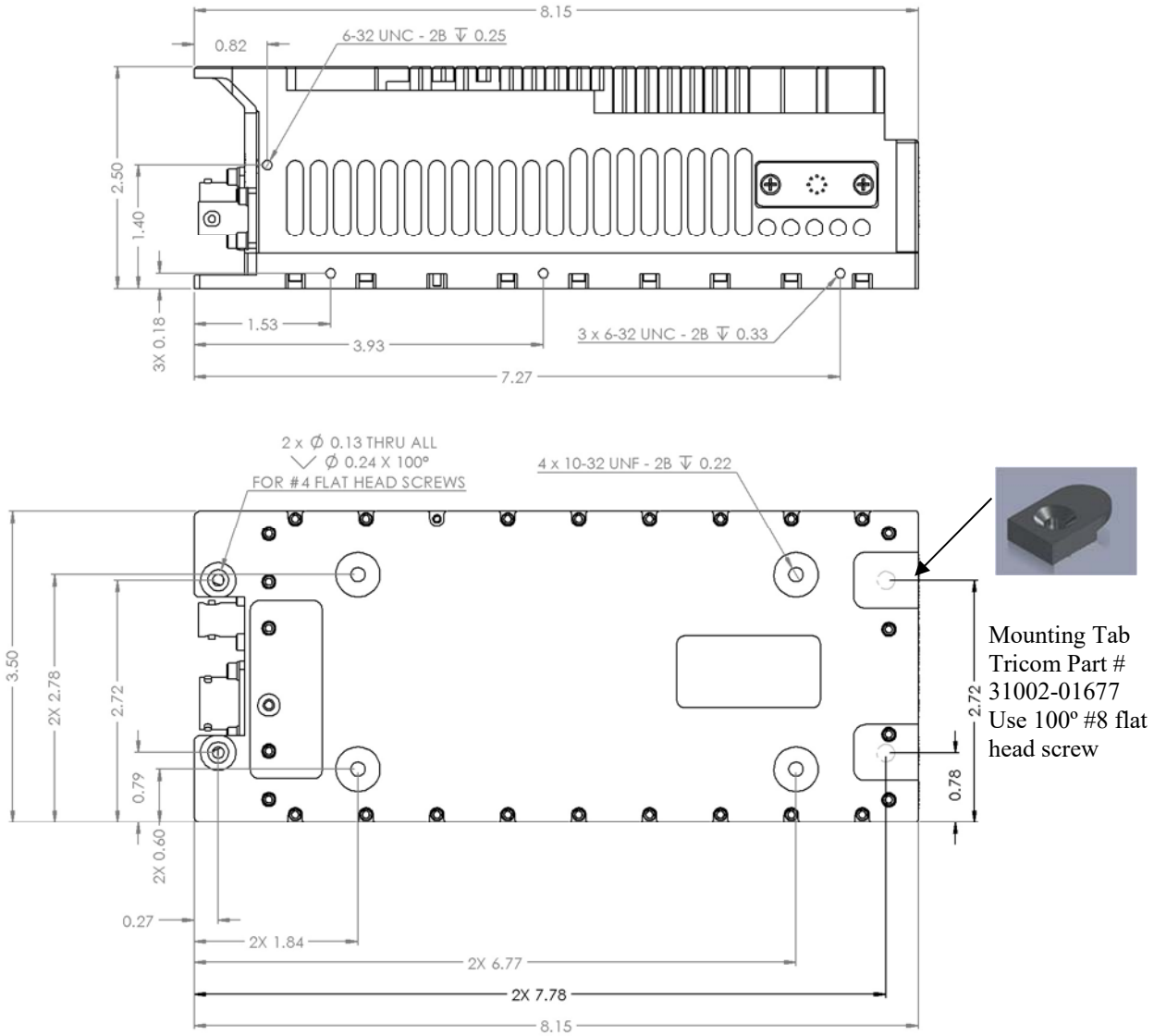

**Figure 3-1 TCR-U/L-25 Outline Drawing (1 of 2)**

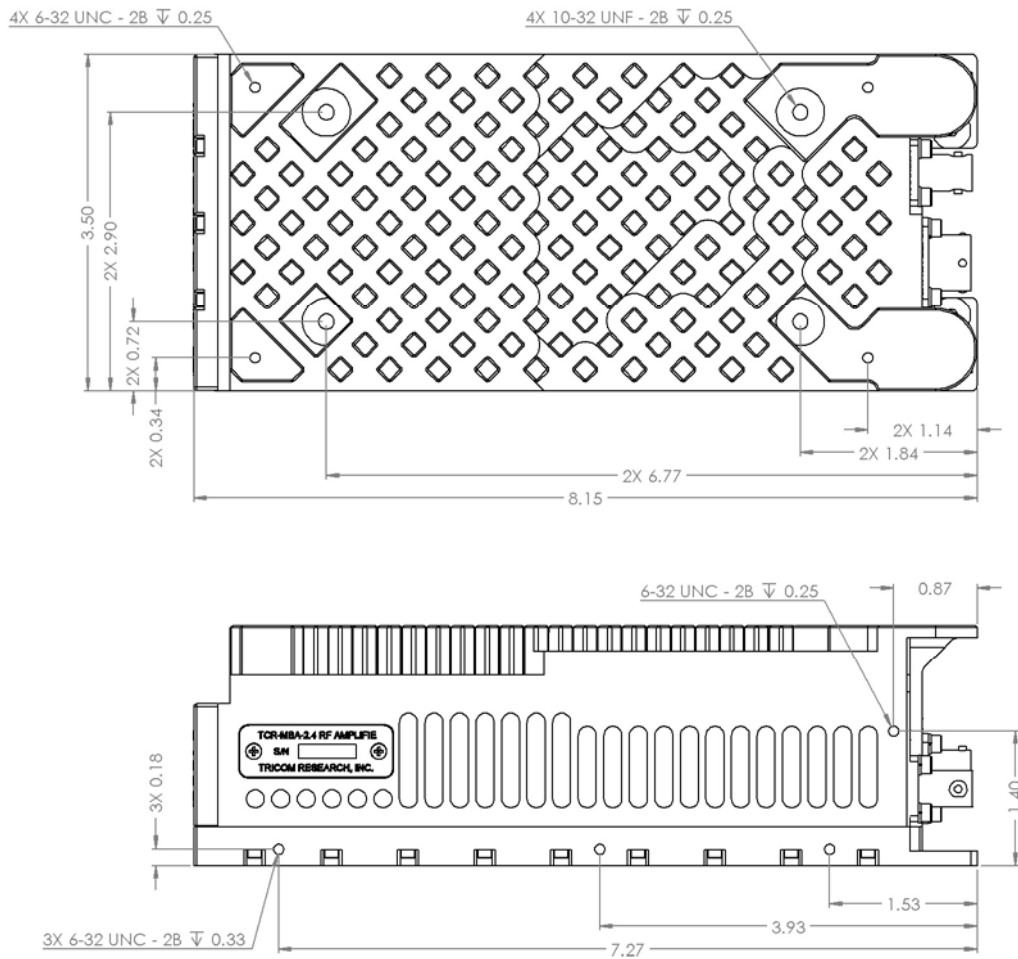

**Figure 3-2 TCR-U/L-25 Outline Drawing (2 of 2)**

### 3.4 DC Input Power.

The DC input power connector is compatible with the TCR-MBA-25 and TCR-MBA-50 WB power cables. Attach the DC power source to the DC IN connector located on the rear of the amplifier (See Fig 3-1 and Table 3-1 for connector pinout and location).

### 3.5 RF Interconnections.

Attach an RF cable from the transceiver to the Radio Input Connector. Attach RF cables/antennas to the antenna connections located on the rear of the amplifier.

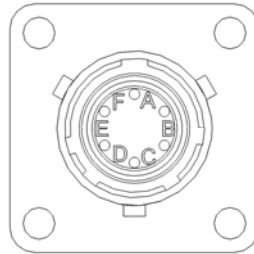

**Figure 3-3 Amplifier DC input connector (MS3112E10-6P)**

**Table 3-1. DC Input Power Connector Pinout**

Pin #	I/O	Connection
Pin A	I	12-32 VDC
Pin B	I	Electrical GND
Pin C	I/O	Reserved
Pin D	I/O	Reserved
Pin E	I	Auto Power ON Select
Pin F	I/O	Reserved

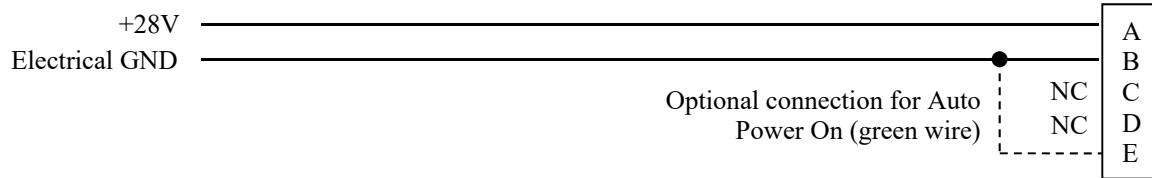
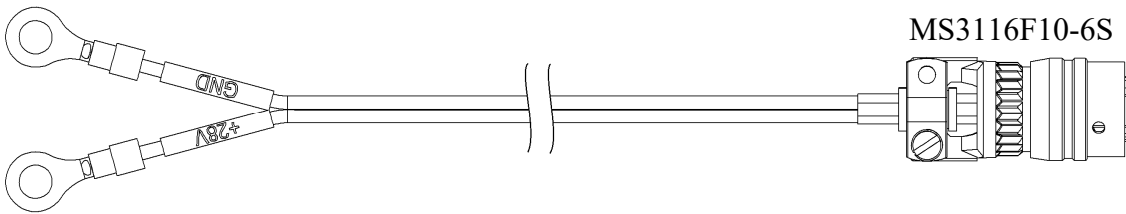

**Figure 3-4 Military Vehicle DC Power Cable (part number 77500-00412 included)**

### 3.6 Remote Control Interface.

The power amplifier can be controlled via a USB or RS-232 interface using a terminal emulator such as HyperTerminal. To connect the remote control interface cable, remove the dust cover labeled AUX CONN on the connector side of the power amplifier. The operating data parameters for RS-232 are 9600 bps, 8 bits, no parity, and 1 stop bit. To use the USB connection, follow the Windows instructions to install the appropriate USB driver for a virtual serial port. The USB driver can be downloaded from <http://www.ftdichip.com/drivers/D2XX.htm>.

#### CAUTION

The AUX CONN cover should be installed whenever the auxiliary port is not being used to maintain the environmental integrity of the PA and to prevent damage to the auxiliary connector contacts.

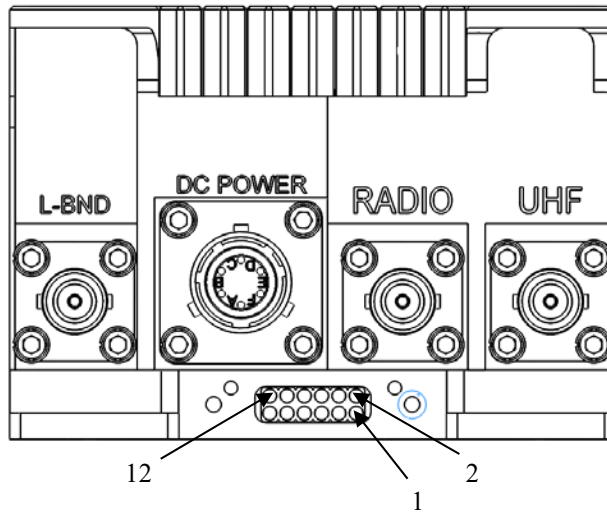

**Figure 3-5 Auxiliary connector pinout (mating connector part number 77500-00421)**

**Table 3-2 Auxiliary Connector Pinout**

Pin #	I/O	Description
1	O	RS-232 TXD
2	I	RS-232 RXD
3	I	USB +5 (used to detect connection to terminal)
4	I/O	USB D+
5	I/O	USB D-
6	I/O	Ground
7	O	+5 out @100 mA
8	I	Reserved
9	I	EXT DC on switch (parallels front panel button)
10	O	TX indication (GND= RCV, Open Circuit = TX)
11	I/O	Reserved
12	I/O	Reserved

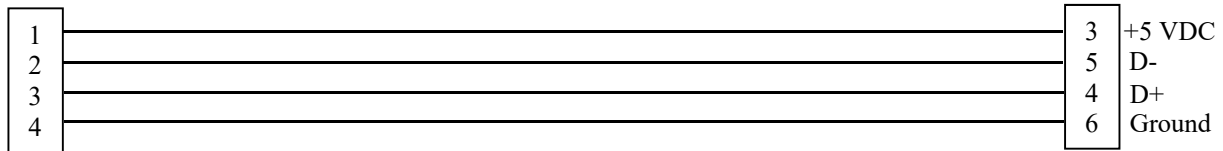
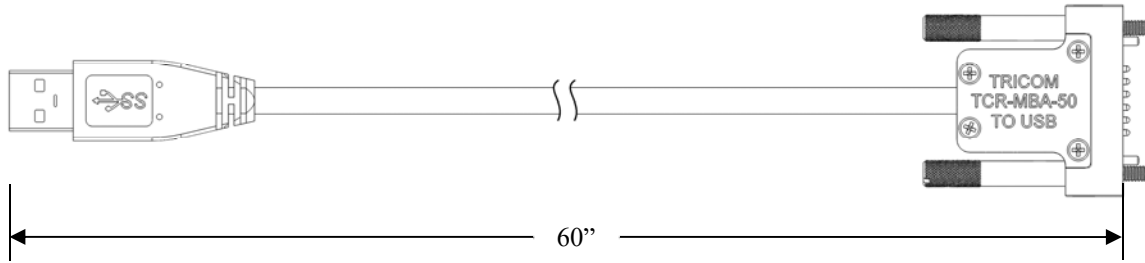

**Figure 3-6 USB Remote Control Cable (part number 77500-00391 optional)**

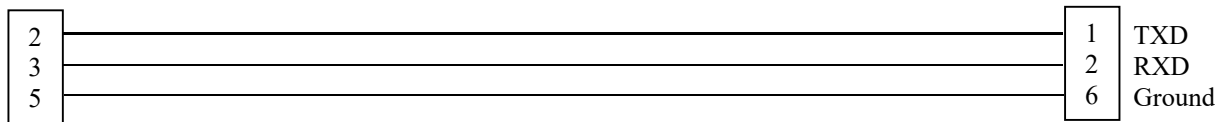
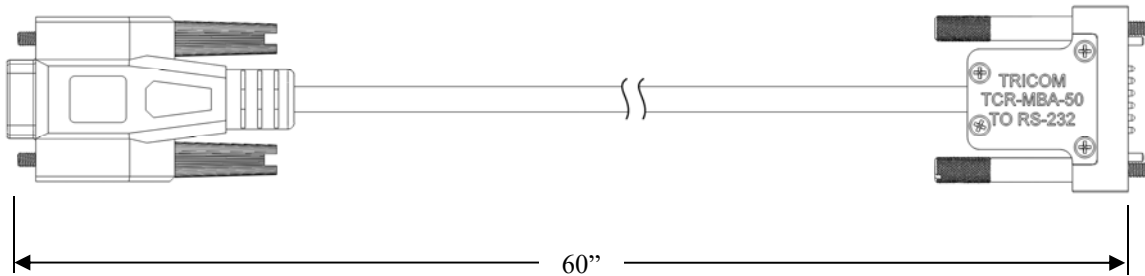

**Figure 3-7 RS-232 Remote Control Cable (part number 77500-00390 optional)**



### 3.7 Remote Control Command Set.

Table 3-4 describes the command set for controlling the TCR-U/L-25 (both versions) remotely. Each valid command is responded with an “ack” message; invalid commands due to incompatible operational parameters will be responded with a “nack” message and invalid commands due to syntax errors will be responded with an “unknown command” message.

**Table 3-3 Remote Control Command Set**

<b>COMMAND</b>	<b>FUNCTION</b>
remote on	Turns on remote control function on the PA (RMT light turns on, mode UHF and L-BND mode switches are disabled)
remote off	Turns off remote control mode on the PA (RMT light turns off)
?	Displays command list
status	Displays current status of the PA (firmware versions, mode, power, temperature), amp serial number
uhf wb hop lna on	Selects UHF mode with LNA turned ON
L band low LNA on	Selects L1 mode with LNA turned ON
L band medium LNA on	Selects L1 mode with LNA turned ON

## APPENDIX A MS Windows Serial Comm Port Reassignment

Issue: MS Windows automatically assigns comm ports to USB serial communications devices in a sequential order. This may create a problem if a remote control Graphical User Interface (GUI) for the TCR-U/L-25 (both versions) only allows the use of specific comm ports. As an example, if the GUI only allows the use of COM1, COM2 or COM3 to interface to the PA via the USB interface and MS Windows automatically assigns COM12 to the USB serial port adapter embedded in the PA then the PC and the PA will not be able to communicate.

Solution: To resolve this issue, the user may reassign the comm port to the TCR-U/L-25's USB serial adapter port (both versions) by going to the advanced comm port settings in the Device Manager's menu.

Comm port reassignment procedure:

1. Ensure that the USB driver for the USB to serial adapter in the PA is installed on the computer. The driver is loaded on the CD that ships with the PA or it can be downloaded from <http://www.ftdichip.com/drivers/D2XX.htm>.

NOTE: The driver must be installed first before the PA is connected to the PC.

2. Ensure that the PA is turned OFF.
3. Connect the USB interface cable to the AUXILARY port on the PA and to any available USB port on the computer.
4. Turn ON the PA.
5. Open the **Device Manager** on the computer and expand the **Ports (COM & LPT)** list to view all enabled comm ports on the computer

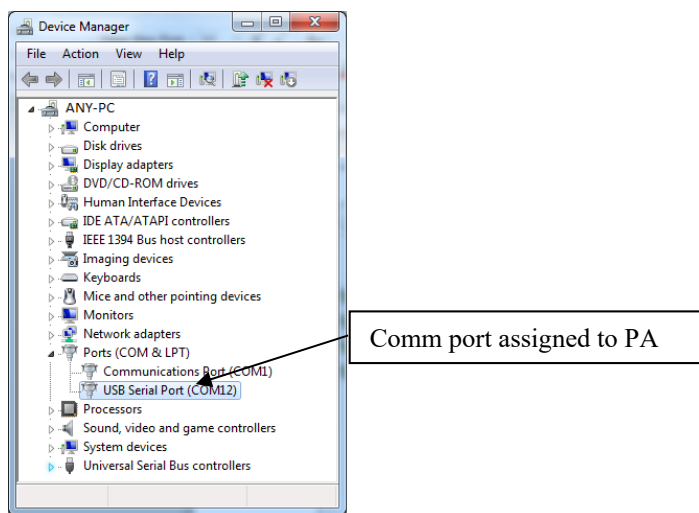

6. Double click on the **USB Serial Port** assigned to the PA (COM12 in this example) to view/change its settings.

7. Click on the **Port Settings** tab and select **Advanced...**
8. Click on the **Comm Port Number:** drop down list and select the desired comm port.

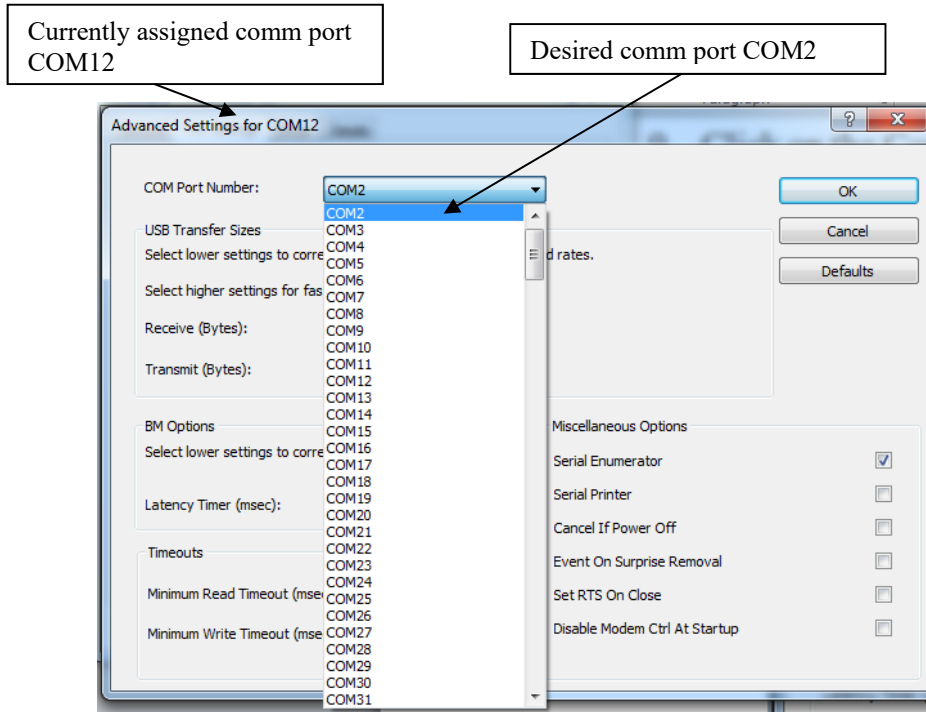

9. Click OK on the advanced settings window and verify that the reassigned comm port settings are 9600 bps, 8 bits, no parity, 1 stop bit and no flow control.

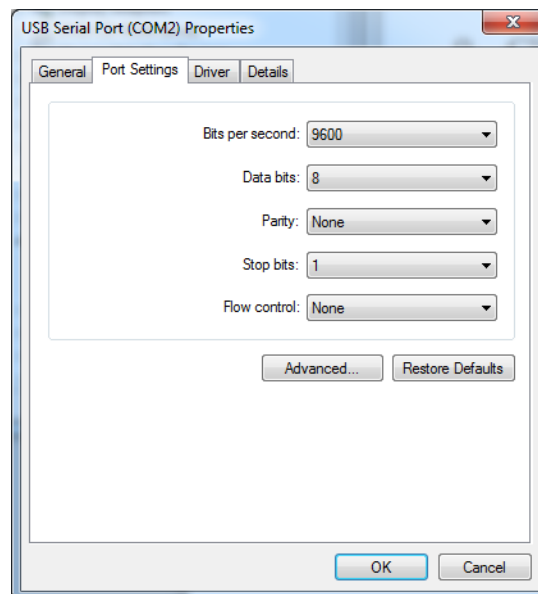

10. Click OK on the **USB Serial Port Properties** (COM2 in this example) window to return to the Device Manager main window.

11. Verify that the desired comm port (COM2 in this example) is enabled.

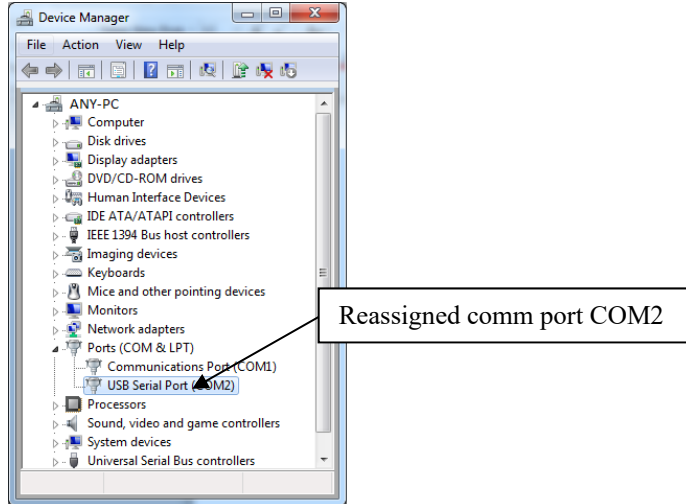

12. Exit Device Manager.

13. Run the remote control utility being used to communicate with the TCR-U/L-25 and verify that the PC is communicating with the PA.

**NOTE:** Any communications terminal software such as HyperTerminal can be used to communicate with the PA. Windows 7 does not include the popular HyperTerminal software but there are several freeware communications terminal emulation utilities available for download on the internet such as PuTTY, which can be downloaded from <http://www.putty.org/>.