

CUBE2-HC90

Project Name:	
Type:	



APPLICATION

The CUBE2-HC90 creates a design statement for contemporary and traditional architectural interiors. The angular luminaires are decorative and suitable for a multiple of applications like offices, retails, museums and galleries as well as high ceiling application such as lobbies.

FEATURE:

- Housing is formed by cold-rolled steel with a highly reflective die-formed white painted steel reflector.
- The snap-in acrylic lens has a matte finish and a diffuser (.125" thick) which is removable for lamp replacement.
- 90 degree and 135 degree luminaires are available.

MOUNTING:

- Pendant, surface, wall mount, recessed (drywall and T-bar) mount available.
- Mounting restrictions apply on some of the recessed housings, please refer to the ordering chart or dimension page to find availability.

LED:

- High quality array LEDs.
- LM80
- Color Temperature: 3000/3500/4000/5000 (K)
- Color Rendering Index: > 80 (optional > 90).
- Nominal Lamp Life: 100,000 hours.
- Reported L70 hours: +60,000 (55°C).

ELECTRICAL:

- High power factor electronic driver, operate from a 120 ~ 277 Vac input range, 50 / 60 Hz.
- Features included over voltage protection, surge, short circuit protection and over load protection.
- Power Factor: typical > 0.95, THD <20, meets Class1 or Class 2 circuit.
- 0-10V dimmable driver as standard.
- 0-10VDC dimming 1%~100%.
- Operating temperature: -4°F (-20°C) ~ 122°F (50°C).

<ELCU-200>

- Guarantees emergency lighting remains ON or is turned on when power to the control device is lost.
- Interfaces with fire alarm panel or security system.
- "Watchdog" feature allows emergency loads to be controlled in tandem with normal power loads.
- UL listed for use in emergency circuits.

FINISH:

- Standard powder-coat textured white painted finish on exposed trim, consult factory for custom colors.
- Comes with snap-in acrylic lens as standard.

LISTING:

- UL / CUL listed.
- Listed to UL 1598 and UL 8750.
- UL listed for dry & damp location.
- Assembled in USA (optional)
- 5 years limited warranty.
- 7 or 10 years limited warranty. (optional) ⁵
- Bluetooth Mesh System available, please contact factory for more information.

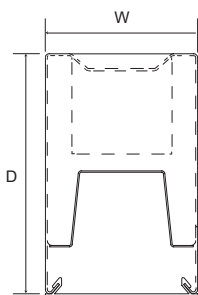

Width: 2.5 (64)
Depth: 4 (101)
All dimensions are in inches (millimeters).

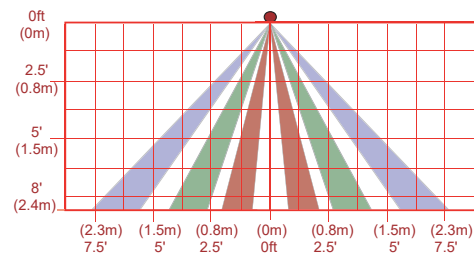

AMS coverage pattern (side view)

* The coverage shown in the diagram is maximum. AMS is designed to detect small motion when mounted within 6' occupants.

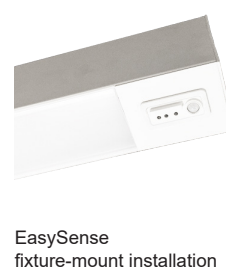
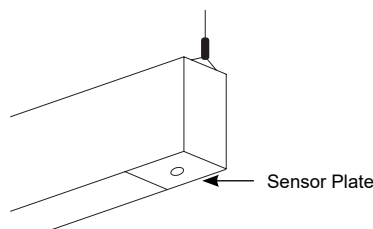

CUBE2-HC90

CONFIGURATIONS

Series	Size	Model #	AC Input	Fixture Lumen Output (4000K)		Lumen Efficiency (4000K)	
CUBE2-HC90	11	D18L	9.9W	1280.46 lm (100% Down)	1280.46 lm	129.34 lm/W	
		D27L	14.85W	1641.66 lm (100% Down)	1641.66 lm	110.55 lm/W	
		D36L	19.8W	2122.36 lm (100% Down)	2122.36 lm	107.19 lm/W	
		D48L	26.4W	2811.6 lm (100% Down)	2811.6 lm	106.5 lm/W	
		D54L	29.7W	3146.41 lm (100% Down)	3146.41 lm	105.94 lm/W	
		18L/18L	19.8W	1179.37 lm (57.6% Down) / 868.15 lm (42.4% Up)	2047.52 lm	103.41 lm/W	
		27L/18L	24.75W	1651.86 lm (63% Down) / 970.15 lm (37% Up)	2622.01 lm	105.94 lm/W	
		27L/27L	29.7W	1769.05 lm (57.6% Down) / 1302.22 lm (42.4% Up)	3071.27 lm	103.41 lm/W	
		36L/18L	29.7W	2093.38 lm (65.5% Down) / 1102.63 lm (34.5% Up)	3196.01 lm	107.61 lm/W	
		48L/18L	36.3W	2383.15 lm (64.6% Down) / 1305.95 lm (35.4% Up)	3689.1 lm	101.63 lm/W	
		48L/27L	41.25W	2485.9 lm (59.3% Down) / 1706.3 lm (40.7% Up)	4192.2 lm	101.63 lm/W	
	54L/18L	39.6W	2937.92 lm (73% Down) / 1086.63 lm (27% Up)	4024.55 lm	101.63 lm/W		
	54L/27L	44.55W	3140 lm (65.5% Down) / 1654 lm (34.5% Up)	4794 lm	107.61 lm/W		
	12 & 21	18L	14.85W	1921.29 lm (100% Down)	1921.29 lm	129.38 lm/W	
		27L	22.27W	2461.50 lm (100% Down)	2461.50 lm	110.53 lm/W	
		36L	29.7W	3182.95 lm (100% Down)	3182.95 lm	107.17 lm/W	
		48L	39.6W	4217.4 lm (100% Down)	4217.4 lm	106.5 lm/W	
		54L	44.55W	4720.51 lm (100% Down)	4720.51 lm	105.96 lm/W	
		18L/18L	29.7W	1950.73 lm (57.6% Down) / 1435.96 lm (42.4% Up)	3386.69 lm	114.03 lm/W	
		27L/18L	37.12W	2477.46 lm (63% Down) / 1455.03 lm (37% Up)	3932.49 lm	105.94 lm/W	
		27L/27L	44.55W	2653.58 lm (57.6% Down) / 1953.32 lm (42.4% Up)	4606.91 lm	103.41 lm/W	
		36L/18L	44.55W	3140.08 lm (65.5% Down) / 1653.94 lm (34.5% Up)	4794.02 lm	107.61 lm/W	
		48L/18L	54.45W	3574.8 lm (64.6% Down) / 1958.95 lm (35.4% Up)	5533.75 lm	101.63 lm/W	
		48L/27L	61.8W	3724.45 lm (59.3% Down) / 2556.25 lm (40.7% Up)	6280.7 lm	101.63 lm/W	
	54L/18L	59.4W	4406 lm (73% Down) / 1629.63 lm (27% Up)	6035.63 lm	101.61 lm/W		
	54L/27L	66.82W	4709.77 lm (65.5% Down) / 2480.73 lm (34.5% Up)	7190.5 lm	107.61 lm/W		
	22	18L	19.8W	2562.12 lm (100% Down)	2562.12 lm	129.40 lm/W	
		27L	29.7W	3283.33 lm (100% Down)	3283.33 lm	110.55 lm/W	
		36L	39.6W	4244.72 lm (100% Down)	4244.72 lm	107.19 lm/W	
		48L	52.8W	5623.2 lm (100% Down)	5623.2 lm	106.5 lm/W	
		54L	59.4W	6294.02 lm (100% Down)	6294.02 lm	105.96 lm/W	
		18L/18L	39.6W	2358.73 lm (57.6% Down) / 1736.30 lm (42.4% Up)	4095.03 lm	103.41 lm/W	
		27L/18L	49.5W	3303.73 lm (63% Down) / 1940.30 lm (37% Up)	5244.03 lm	105.94 lm/W	
		27L/27L	59.4W	3538.10 lm (57.6% Down) / 2604.45 lm (42.4% Up)	6142.55 lm	103.41 lm/W	
		36L/18L	59.4W	3954.11 lm (65.5% Down) / 2082.71 lm (34.5% Up)	6036.82 lm	101.63 lm/W	
		48L/18L	72.6W	4766.3 lm (64.6% Down) / 2612 lm (35.4% Up)	7378.3 lm	101.63 lm/W	
		48L/27L	82.5W	4971.9 lm (59.3% Down) / 3412.5 lm (40.7% Up)	8384.4 lm	101.63 lm/W	
		54L/18L	79.2W	5875.83 lm (73% Down) / 2173.26 lm (27% Up)	8049.09 lm	101.63 lm/W	
		54L/27L	89.1W	6280.14 lm (65.5% Down) / 3307.86 lm (34.5% Up)	9588 lm	107.61 lm/W	
	CUBE2-HC135	22	18L	19.8W	2562.12 lm (100% Down)	2562.12 lm	129.40 lm/W
			27L	29.7W	3283.33 lm (100% Down)	3283.33 lm	110.55 lm/W
			36L	39.6W	4244.72 lm (100% Down)	4244.72 lm	107.19 lm/W
			48L	52.8W	5623.2 lm (100% Down)	5623.2 lm	106.5 lm/W
			54L	59.4W	6294.02 lm (100% Down)	6294.02 lm	105.96 lm/W
			18L/18L	39.6W	2358.73 lm (57.6% Down) / 1736.30 lm (42.4% Up)	4095.03 lm	103.41 lm/W
27L/18L			49.5W	3303.73 lm (63% Down) / 1940.30 lm (37% Up)	5244.03 lm	105.94 lm/W	
27L/27L			59.4W	3538.10 lm (57.6% Down) / 2604.45 lm (42.4% Up)	6142.55 lm	103.41 lm/W	
36L/18L			59.4W	3954.11 lm (65.5% Down) / 2082.71 lm (34.5% Up)	6036.82 lm	101.63 lm/W	
48L/18L			72.6W	4766.3 lm (64.6% Down) / 2612 lm (35.4% Up)	7378.3 lm	101.63 lm/W	
48L/27L			82.5W	4971.9 lm (59.3% Down) / 3412.5 lm (40.7% Up)	8384.4 lm	101.63 lm/W	
54L/18L			79.2W	5875.83 lm (73% Down) / 2173.26 lm (27% Up)	8049.09 lm	101.63 lm/W	
54L/27L			89.1W	6280.14 lm (65.5% Down) / 3307.86 lm (34.5% Up)	9588 lm	107.61 lm/W	

CCT	Multiplier		
	3000K	3500K	5000K
Down only	0.9642	0.9822	1.0357
Up&Down	0.971	0.9856	1.029

OUTPUT CURRENT

		Bi-Level		Tri-Level (Default)	
SW1	SW2	Config Range	Default	Config Range	Default
Close	Open	10% - 70%	40%	10% - 70%	30%
Open	Close	10% - 70%	40%	10% - 70%	70%
Close	Close	100%	100%	100%	100%
Open	Open	0%	0%	0%	0%

WEIGHT

Item	lbs	kg
CUBE2-HC90	15.19	6.89
CUBE2-HC90-FT	17.37	7.88

CUBE2-HC90

ORDERING INFORMATION

EXAMPLE: CUBE2-HC90-12-D27L-30K-UNV-X1-AC48

MODEL	Shape		Size		LED Downlight (per/each section)		LED Uplight ¹ (per/each section)		COLOR TEMP.	
CUBE2	HC90	90 Degree	11	1' x 1'	D18L	18W LED	/U18L	18W LED	(Blank)	Leave blank if you wish to have different CCT for up and down, and fill out next section. 3000K 3500K 4000K 5000K
			12	1' x 2'	D27L	27W LED	/U27L	27W LED		
			21	2' x 1'	D36L	36W LED				
			22	2' x 2'	D54L	54W LED				
	HC135	135 Degree	22	2' x 2'	<small>*Maximum wattage per each section - pendant : 75W(up & down light) - recessed mount : 54W(down light) * Contact factory for custom wattage or lumen requirement.</small>					

SEPARATE COLOR TEMP. ¹		CRI	MOUNTING		VOLTAGE			
(Blank)	Leave blank if you wish to have different CCT for up and down, and fill out next section	(Blank)	80+ CRI	(Blank)	Pendant	UNV	120-277V	
DXXYUY	Indicate 27,30,35,40 or 50 for XX and YY (D represents Downlight, U represents Uplight)	C9	90+ CRI ¹⁰	FT	Standard 1/2" Flange (drywall) ²	120	120V	
				G1	9/16", 15/16", 1" T-bar Ceiling Grid ^{16,21}	277	277V	
				SF	Spackle Flange (Trimless) ^{17,18,21}	347	347V ¹⁹	
				S	Ceiling Surface			
				W	Wall			
				<small>* Limited mounting option(s) depending on the shape & size. Please see dimensions page to find availability.</small>				

EM SECTION		FIXTURE FINISH ¹¹		CORD FINISH (for pendant)		CANOPY FINISH (for pendant)		CEILING TYPE (for pendant)	
(Blank)	None EM	(Blank)	Matte White RAL #9003 (Std.)	(Blank)	White (Std.)	(Blank)	White (Std.)	X1	15/16" grid T-bar ceiling
1SE	1 Section	*BK	Black RAL #9011	*BKC	Black	*BC	Black Canopy	X2	Hard ceiling
		*SV	Silver (RAL #9022)			*SC	Silver Canopy	X3	Sloped Hard ceiling
		**CC	Custom Color ⁹			**CSS	Custom Canopy Color (White is Std.)	X4	9/16" T-bar ceiling
		*AMB	Anti-Microbial Coating (Matte Skye White)						
		<small>* Non-standard finish with extra charge. ** Additional charge & set up fee.</small>							

SUSPENSION LENGTH (for pendant)		LED DRIVER	
AC48	Adjustable Aircraft Cable Canopy 48"L	(Blank)	0-10V dim to 1% (Std.) (dim both uplight and downlight simultaneously)
AC96	Adjustable Aircraft Cable Canopy 96"L	UDSD	Separate Dimming Control of Uplight and Downlight (0-10V dim to 1%) ^{8,15}
ST24	Stem Canopy 24"L	SP	Separate Power Control for Uplight and Downlight
ST48	Stem Canopy 48"L	ES566	eldoLED SOLOdrive Natural Dimming to dark, 0-10V, 100% ~ 0.1% dim
	<small>* Contact factory for custom length.</small>	SD40	40% / 100% Bi-Level Step dim
		SDXX	XX% / 100% Bi-Level Step dim (Specify XX: 10% ~ 70%)
		PHSR	Philips Xitanium Sensor-Ready, Dali 5%~100% dim.
		PHDL	Philips Xitanium DALI driver, Dim to 5%
		ED560	eldoLED LightShape DALI dim to dark, 0.1% ~ 100%
		TDM	Triac Dim. (120V only)
		TD30/70	30% / 70% / 100% Tri-Level Step dim
		TDXX/YY	XX% / YY% / 100% Tri-Level Step dim (Specify XX, YY: 10% ~ 70%)
		LDE1	Hi-lume 1% EcoSystem LED driver with Soft-on, Fade-to-Black dimming technology, 100% ~ 1% dim
		ELV	ELV compatible (reverse-phase or trailing-edge)
		TRIOT	Tridonic IoT ready, 1-100% dim via Smart Module Interface (SMI), automated dimming/lighting controls via Enlighted Sensor Interface
		DTO	0-10V DIM-TO-OFF
		DIMT	Tri-mode dimming (Triac, ELV, 0-10V)
		DMX	DMX512 control system (Only available with RGB+W option)
		DLM	Wattstopper's DLM interface (Only available with RGB+W option)
		LTEA2W	Hi-lume 1% 2-wire LED driver (120V forward phase only)
		BLT	Bluetooth Mesh System (contact factory for more information)

OPTIONS		LIGHTING CONTROL SYSTEM		
STB	Slip Through Bracket ³	LUTRON VIVE  Click Here!	<Lutron Vive System Enabled>	
EM5MC	810 LUMEN Emergency Ballast (32°F (0°C) ~ 131°F (55°C))		<EasySense>	
EM7MC	1134 LUMEN Emergency Ballast (32°F (0°C) ~ 122°F (50°C))		SNS200	EasySense Fixture-mount occupancy sensing, daylight harvesting and task tuning in one device (Must be ordered with PHSR driver) ^{12, 13}
EM10MC	1620 LUMEN Emergency Ballast (32°F (0°C) ~ 131°F (55°C))		RS-IR	IR dongle v2.0 for EasySense control
EMC	CEC compliant EM ⁴		SU-5E	<Enlighted> Enlighted IoT ready 0-10V Indoor Micro sensor with occupancy/vacancy detection, daylight harvesting, thermal sensing, task tuning, and room and zone control, Bluetooth enabled (Must be ordered with TRIOT) ¹⁴
GTD	Bodine Generator Transfer Device		RS-WS	Enlighted Room controller providing basic control functions of a standard wall switch with preset dimming capability
GTD10DIM	Bodine Generator Transfer Device (0-10VDC Dimmer Override)			
GLR	Fast Blow Fuse ²⁰			
GMF	Slow Blow Fuse ²⁰			
ARRA	Assembled in USA for Buy American Act			
O7W	Optional 7 Years Limited Warranty ⁵			
O10W	Optional 10 Years Limited Warranty ⁵			
AMS	Occupancy Sensor w/ Daylight Harvesting ⁶			
DPMS	Daylight Dimming Photo Sensor (0-10 VDC Control), (LSR-301-S required) ²³			
SO	Dimming Wires connected to Sensor Only ⁷			
LSR-301-S	Setup Remote Control for DPMS (Required for DPMS)			
LSR-301-P	Occupant Remote Control for DPMS			
COC	Separated EM feed for City of Chicago code compliance ²⁴			
UPC	Indirect Light Cover ²²			
E1F	End feed on one end (Pre-drilled hole for 1/2" fitting)			
E2F	End feed on both ends (Pre-drilled holes for 1/2" fitting)			

NOTES:

- Pendant only.
- Requires # STB as standard.
- Standard with "FT" mounting.
- Check with factory for more details.
- This limited warranty covers electrical parts only and does not apply to labor, equipment lease, or defect from improper installation or operation.
- The standard will be ON/OFF sensor with dimming wires provided for dimmer switch. For sensor dimming control, please select additional "SO" option.
- Dimming wires provided and connected to sensor only, not for dimmer switch. (available with AMS and DPMS option)
- For separate dimming control, please be advised it may not be available when EM battery backup is added due to limited space. Please contact us for more information.
- Refer to color charts (RAL and/or Cardinal) in the separate attachment.
- Lumen per watt is around 15% less than standard CRI (80+).
- Cord is available in white or black. (Black is not available for the EM option)
- See NFC and IR manual in the separate attachment. If your phone is not compatible, please order "RS-IR" and follow the manual.
- Refer to Advanced Grouping Datasheet for its default setting and compatible wireless switches.
- "RS-WS" option can be added if wish to have a wall switch, please see Enlighted Room Controller in the separate attachment.
- Can have up to 2 power feeds depending on the configuration.
- Compatible with X1 ceiling type.
- Requires # STB as standard.
- Compatible with X2 ceiling type.
- 347V cannot work with Emergency Battery Backup.
- Must specify voltage, not available with 347V.
- Only available with HC90-22.
- Only available with pendant/surface mount.
- Automatic on/off is not available. For automatic on/off, additional occupancy sensor is required or a manual on/off switch can be done.

Surface

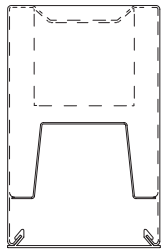

Drywall

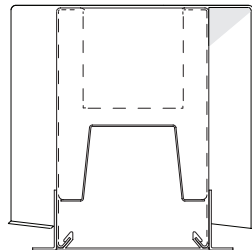

Cable

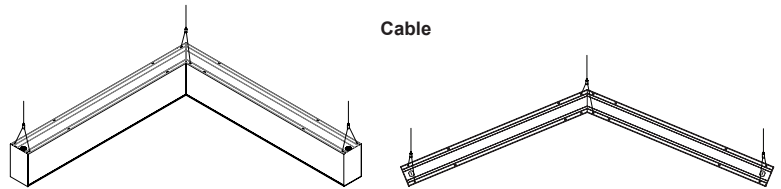

- INACCESSIBLE CEILING MOUNTING

Flange Detail

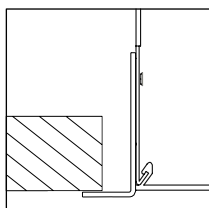

Exposed Flange Detail:
Specify FT in part #

- SPECIALTY MOUNTS

Rotating Crossbar

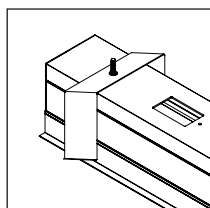

Unavailable Structure Support:
Specify STB in part #

Stem

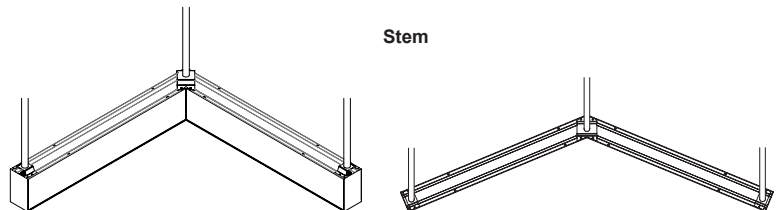

CUBE2-HC90

Pendant & Surface & Wall

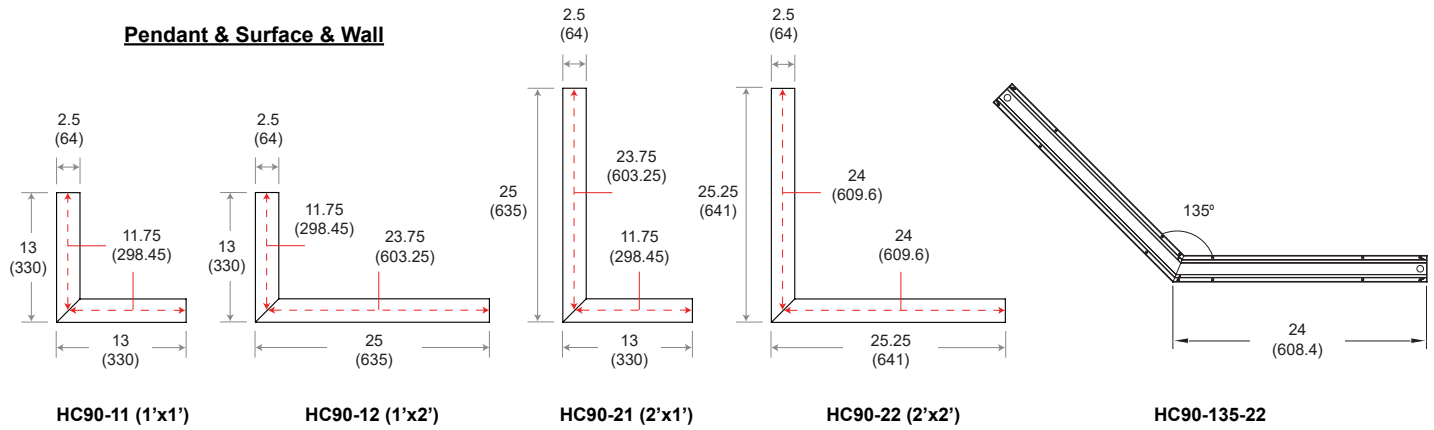

Recessed

* Measurements shown below are without flange.

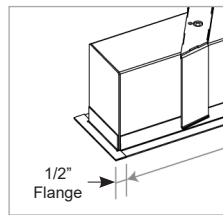
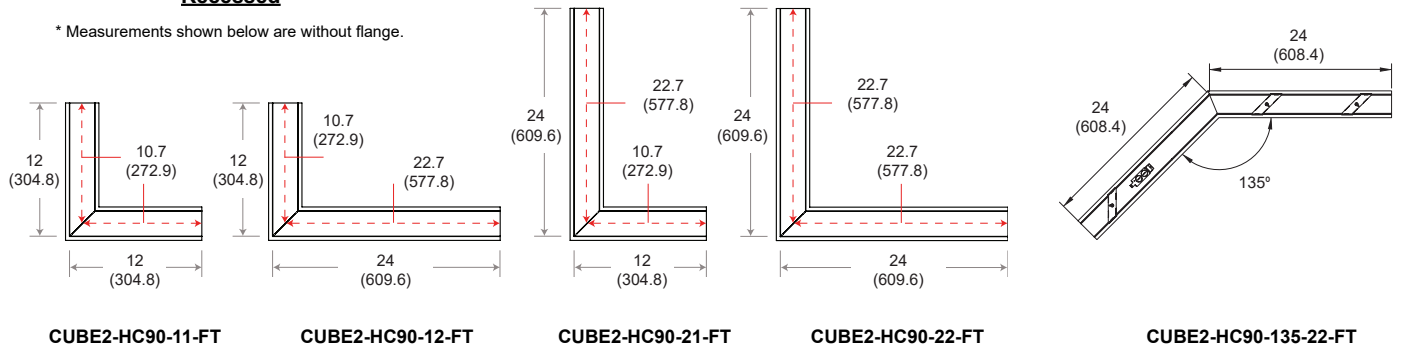

Flange is 0.078 (2) elevated.

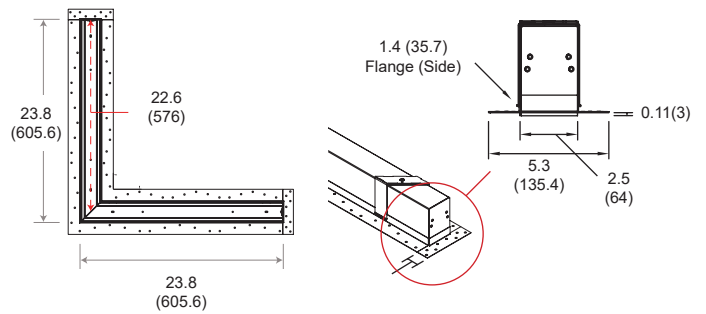
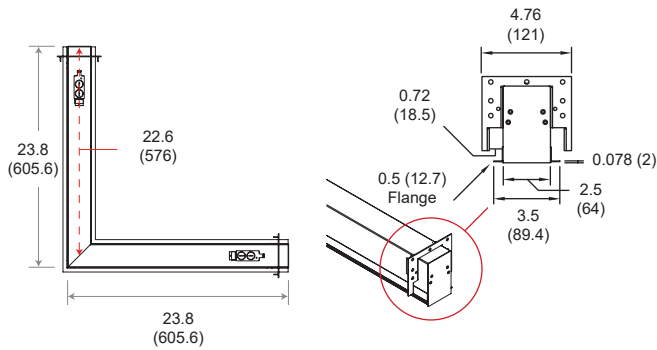
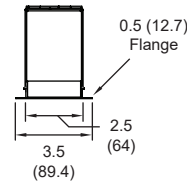

CUBE2-HC90

COMPATIBLE DIMMER SWITCH (TABLE 1)

Model #	Brand	Compatible Dimmer Switch	
(Blank)	-	<Leviton>	IP710-LFZ
		<Lutron>	Nova: NFTV-dimmer plus PP-DV relay pack(s) Nova T: NTSTV-DV-dimmer Diva: DVTV-dimmer, DVSCTV-dimmer, plus PP-DV, relay pack(s), DVSTV-dimmer, DVSCSTV-dimmer GRAFIK Eye QS: QSGRJ-XP, plus GRX-TVI 0-10V interface GRAFIK Eye QS w/EcoSystem: QSGRJ-XE, QSGR-XE, plus GRX-TVI 0-10V interface PowPak: RMJ-5T
ES566	eldoLED SOLOdrive	<Busch-Jaeger>	2112U-101
		<Jung>	240-10
		<Leviton>	IlumaTech - IP710-DLX
		<Lightoller Controls>	ZP600FAM120
		<Merten>	5729
		<Pass & Seymour>	CD4FB-W
		<Wattstopper>	DCLV1
		<Sensor Switch>	nIO EZ
		<Synergy>	ISD BC
		<ABB>	SD/S 2.16.1
		<Lutron>	Nova T: NTFTV Diva - DVTV-xx, NFTV GRAFIK Eye: GRX-TVI w GRX3503 Energy Savr Node: QSN-4T16-S TVM2 Module
<Crestron>	GLX-DIMFLV8, GLXP-DIMFLV8, GLPAC-DIMFLV4-*, GLPAC-DIMFLV8-*, GLPP-DIMFLVEX-PM, GLPP-1DIMFLV2EX-PM, GLPP-1DIMFLV3EX-PM, DIN-AO8, DIN-4DIMFLV4, CLS-EXP-DIMFLV, CLCI-1DIMFLV2EX		
ED560	eldoLED DUALdrive	<Lunatone>	SS-LUNAT PS2 30mA SS-LUNAT Touch or BT SS-LUNAT Comm
LDE1	Lutron 5-Series EcoSystem	<Lutron>	PowPak Dimming Modules: RMJ-ECO32-DV-B, FCJ/FCJS-ECO ^{1,2} Energi Savr Node (120V only): QSN-1ECO-S, QSN-2ECO-S GRAFIK Eye QS/Homeworks QS control unit (120V only): QSGRJ- _E(wireless) QSGR- _E Quantum Hub (120V only): QP2- _2C/4C/6C/8C Homeworks QS/myRoom Plus power module (120V only): LQSE-2ECO-D
PHSR ³	Philips Xitanium Sensor-Ready	<Ilumra>	<u>Single Rocker Self-Powered Light Switch (on/off, dim-up/down)</u> Ilumra# ZBT-S1AWH Digi-Key# 1082-1033-ND <u>Dual Rocker Self-Powered Light Switch (on/off, dim-up/down, scene1,2)</u> Ilumra# ZBT-S2AWH Digi-Key# 1082-1034-ND
DTO	Philips Xitanium Gen.2 Philips Xitanium Sensor-Ready	<Lutron>	Nova T: #NTSTV-DV http://www.lutron.com/TechnicalDocumentLibrary/NovaTB.pdf See page13.
LTEA2W	Lutron Hi-lume 2-wire (120V forward voltage only)	<Lutron>	Visit http://www.lutron.com/TechnicalDocumentLibrary/369543_ENG.pdf for a list of compatible dimmer switches.

NOTES:

1. All devices connected to one FCJ/FCJS-ECO will be controlled together. Devices will dim to the same level as the result of a control command. For more detail on adjusting low-end light level refer to Application Note#556 at www.lutron.com.
2. For the Line/Hot (L/H) terminal on the driver, it is preferred not to use the switched hot (red) wire from the control but rather the hot wire directly from the power source.
3. Recommended for EasySense System.