

4

3

2

1

[244.70]  
9 <sup>41</sup>/<sub>64</sub>"

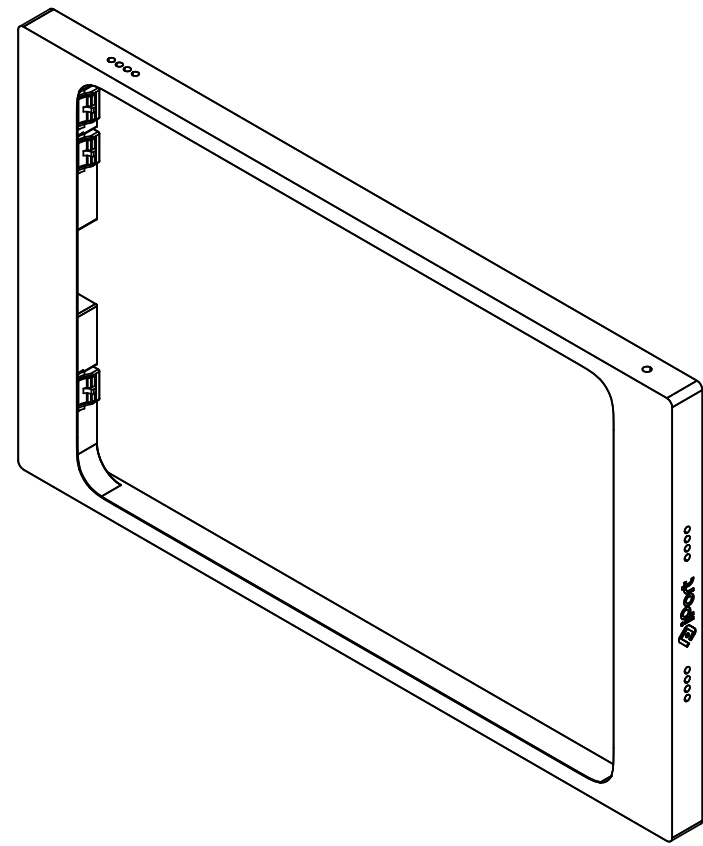
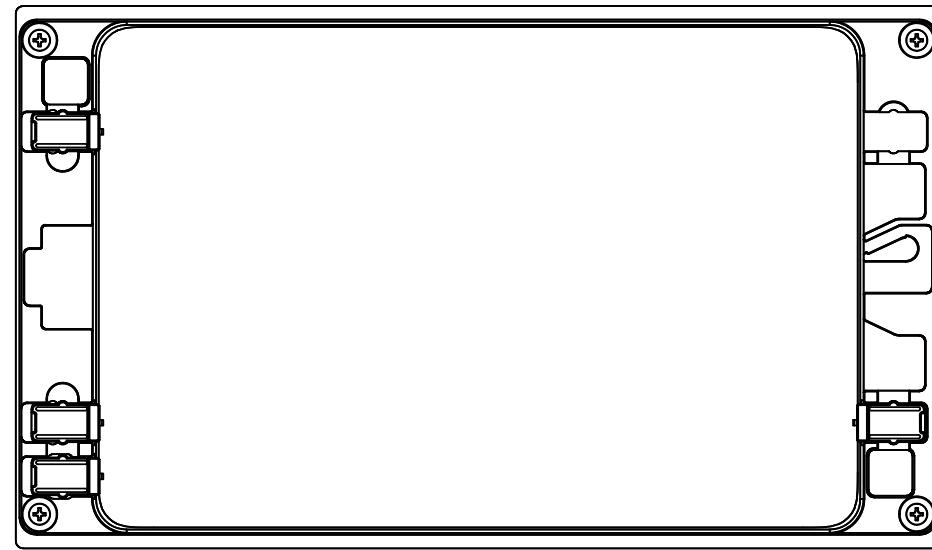
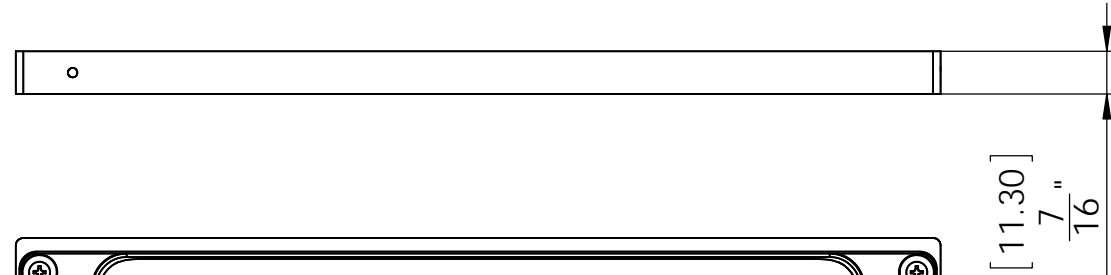
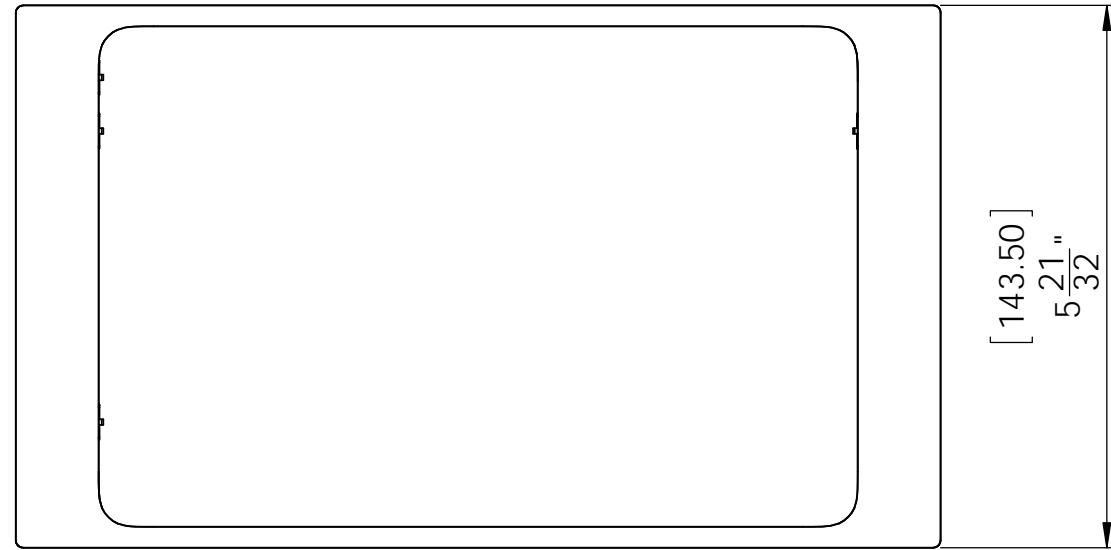
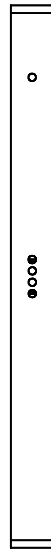
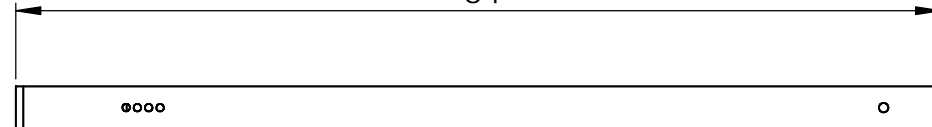

B

B

A

A

4

3

2

1

METRIC/INCHES	 a DANA INNOVATIONS COMPANY		
DESIGNED IN SAN CLEMENTE, CALIFORNIA BY iPORT	NAME <b>SURFACE MOUNT MINI 4 BEZEL</b>		
<small>NOTICE OF PROPRIETARY INFORMATION: THE INFORMATION CONTAINED HEREIN IS THE PROPRIETARY PROPERTY OF DANA INNOVATIONS. THE POSSESSOR AGREES TO THE FOLLOWING: 1. TO MAINTAIN THIS DOCUMENT IN CONFIDENCE 2. NOT TO REPRODUCE OR COPY IT 3. NOT TO REVEAL OR PUBLISH IT IN WHOLE OR IN PART 4. ALL RIGHTS RESERVED</small>	SIZE	SKU	REV
	<b>B</b>	70722, 70723, 70724	<b>A</b>
SCALE: 1:2   WEIGHT: .69lbs (.31kg)   SHEET 1 OF 1			