

The Environmental Impact of Digital Preservation



Linda Tadic

December 2018

© 2018 Linda Tadic

This presentation will address

1. Overview of environmental concerns directly interfacing with the AV archival community.
 - a. Global environment: AV archives are contributing to greenhouse gas emissions
 - b. Direct toxic endangerment to people: Hardware and video/datatape e-waste disposal methods
2. Choices archives can make to both lower their environmental impact **and** improve their long-term sustainability.

An underwater photograph of a coral reef. The scene is illuminated by sunlight filtering through the water from the top center, creating a bright, shimmering effect. The water is a deep, clear blue. In the foreground and middle ground, there are various types of coral, including branching and table corals. Several small, dark-colored fish are swimming around the coral. The overall atmosphere is serene and natural.

Protecting the environment is a global concern. Our actions can impact regions thousands of miles away.

First, some relevant estimates

How much magnetic media (sound and video) is there in the world that will be migrated to digital files? **What's the extent of our impact?**

- Focus on magnetic media rather than film, since magnetic media must be digitized within the next few decades.

Eventually, there will only be
“media carcasses” on vault shelves.



Impossible to estimate total number of hours

Audiovisual collections are held by:

- Libraries, archives, museums (cultural heritage organizations)
- Media and Entertainment (studios, broadcasters, independent producers)
- Corporate
- Consumer

Some attempts at estimates

These estimates are **only** for cultural heritage organizations:

- **UNESCO (2000 report):** 200,000,000 hours globally (video and audio)
- **LC National Recording Preservation Plan (2012):** 46,000,000 hours (audio only; US libraries and archives only)
- **NEDCC report (2015):** 570,000,000 hours (250,800,000 hours migration-worthy) (audio only; US libraries, archives, and museums only)

Library of Congress: September 2018: 16 PB AV content (x2 locations) (120TB/month). In 5 years: 1.3 PB per month (both digitized and acquired born-digital).

Let's say 400,000,000 hours total from
all sectors (global)

250,000,000 hours audio

150,000,000 hours video

Physical media digitized at a recommended high resolution open file
format:

Audio: WAV 96/24 (2 GB per hour)

Video: uncompressed 10-bit (SD) (94 GB per hour)

400,000,000 hours legacy magnetic media = 14,600 PB

AUDIO

250,000,000 x 2 GB = 500 PB

VIDEO

150,000,000 x 94 GB = 14,100 PB

TOTAL: 14,600 PB (14.6 Exabytes)

... and that's only one set of files. **2 sets for redundancy: 29.2 Exabytes**

Hard numbers:

2018: 92 Exabytes Seagate HDDs shipped Q2 2018

2017: 108,457 PB LTO media sold (March 2018 LTO consortium statistics)

2012: 430,000 PB of storage media sold (HDD, tape, NAND)*

HDD: 577M units shipped

LTO: 27.7M units shipped [note this doesn't include other manufacturers]

NAND: 14,000M 2GB units shipped

Global IP traffic is expected to reach 3.3 zettabytes by 2021. **

1 zettabyte = 1,000 exabytes = 1 billion PB

*Fontana, Decad, and Hetzler. "The impact of areal density and millions of square inches (MSI) of produced memory on petabyte shipments of TAPE, NAND flash, and HDD storage class memories." *IEEE 29th Symposium on Mass Storage Systems and Technologies (MSST), 2013.*

** Cisco Visual Networking Index: Forecast and Methodology, 2016–2021

<https://www.cisco.com/c/en/us/solutions/collateral/service-provider/visual-networking-index-vni/complete-white-paper-c11-481360.html>

Preserving this content and making it accessible will impact the environment:

Legacy media destruction: 400,000,000 magnetic media items will ultimately be **destroyed** (“media carcasses”).

Electricity use: 29 Exabytes of data must be preserved through storage and management, using **energy resources** that can be dirty or clean.

Hardware/media destruction: Media and hardware used to store and manage the data will be changed every 5-10 years, with the old media/hardware either **recycled, incinerated, or dumped in a landfill.**

Archives can make choices to mitigate their environmental impact AND improve institutional sustainability

Broad areas where choices can be made:

- Staff actions
- Technology choices
 - hardware and media
 - energy use

Overview of environmental concerns directly interfacing with the AV archival community

1. Greenhouse gas emissions
2. Direct toxic endangerment to people:
Hardware and video/datatape e-waste disposal

Environmental concerns: Greenhouse gases

Global Greenhouse Gas Emissions by Gas

CO₂ (carbon dioxide, the majority of GHG) stays in the atmosphere for over a century. To survive, we need to cap GHG emissions by 2020, and drastically lower them.

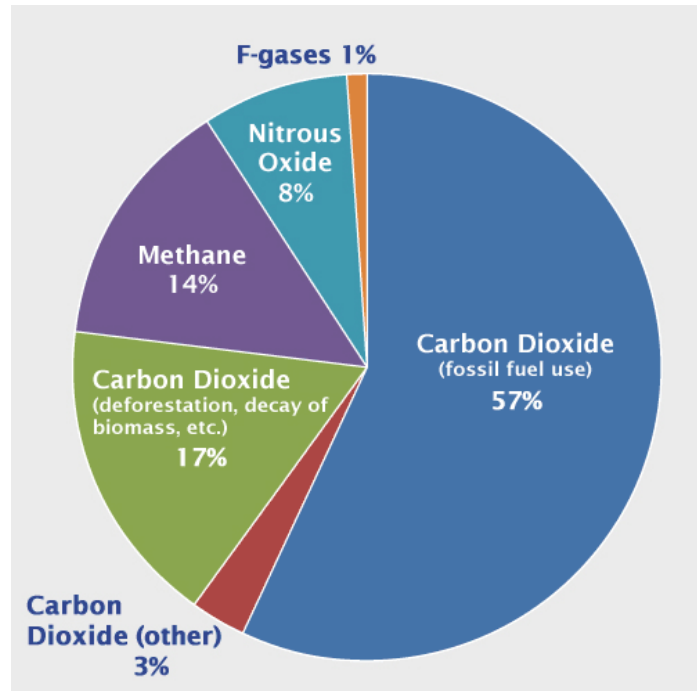

2007: IPCC Climate Change 2007 Report

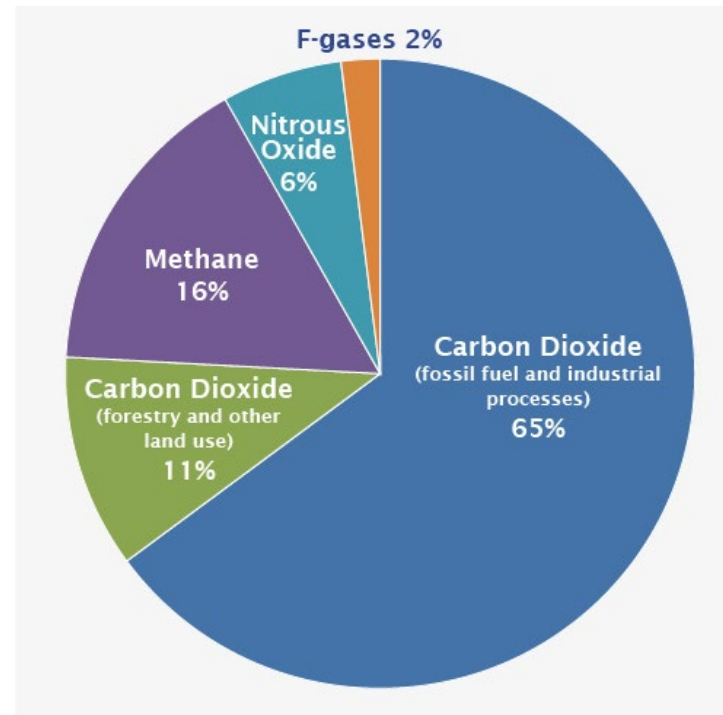

2014: IPCC Climate Change 2014 Report

<https://www.ipcc.ch/report/ar5/wg3/>

Anthropocene epoch

Anthropogenic climate change: Human activity is the main driver impacting climate change by contributing to the increase in Greenhouse Gases (GHG).

Global consensus: An increase of 2° C (3.6° F) will result in extremely dangerous climate change:

- warmer ocean = dead sealife = no food
- melting ice = flooded coastal areas, **methane gas (25x more GHG than CO2)** released from permafrost
- severe weather (hurricanes, cyclones, drought)
- less potable water, less food
- starvation and suffocation

“Rising temperatures are recognized as a national security issue, destructive force, and threat to national economies. The window of opportunity to address the predicted devastation associated with our warming planet continues to close. Accepted is that **ICT [information and communication technology] is key to achieving a low carbon economy.”**

-- *GeSI SMARTer 2020 report (2012 revision)*

<http://gesi.org/SMARTer2020>

“A review of existing studies ... lead us to conclude that it is likely that greenhouse warming will cause hurricanes in the coming century to be **more intense** globally and **have higher rainfall rates** than present-day hurricanes.”

-- <https://www.gfdl.noaa.gov/global-warming-and-hurricanes/>

Global Warming and Hurricanes: An Overview of Current Research Results.

Last Revised: Aug. 30, 2017. Geophysical Fluid Dynamics Laboratory report for NOAA

Moody's Analytics on recent hurricane damage:

Harvey and Irma: \$200B
Maria: \$ 95B

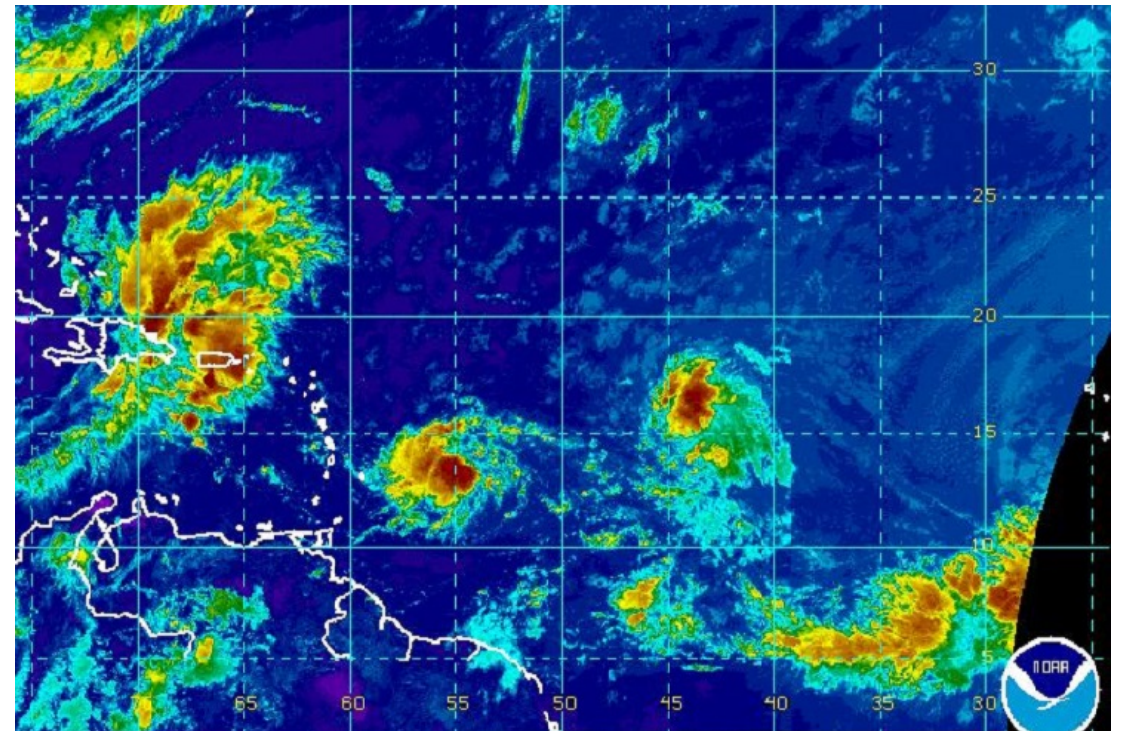

Our archives intersect with ICT through energy consumption and hardware use that are required to keep our digital files alive.

**ICT emissions will be 2.3% by 2020 (same as global aviation).
But lowered to 1.97% by 2030.**

Global Greenhouse Gas Emissions by Source

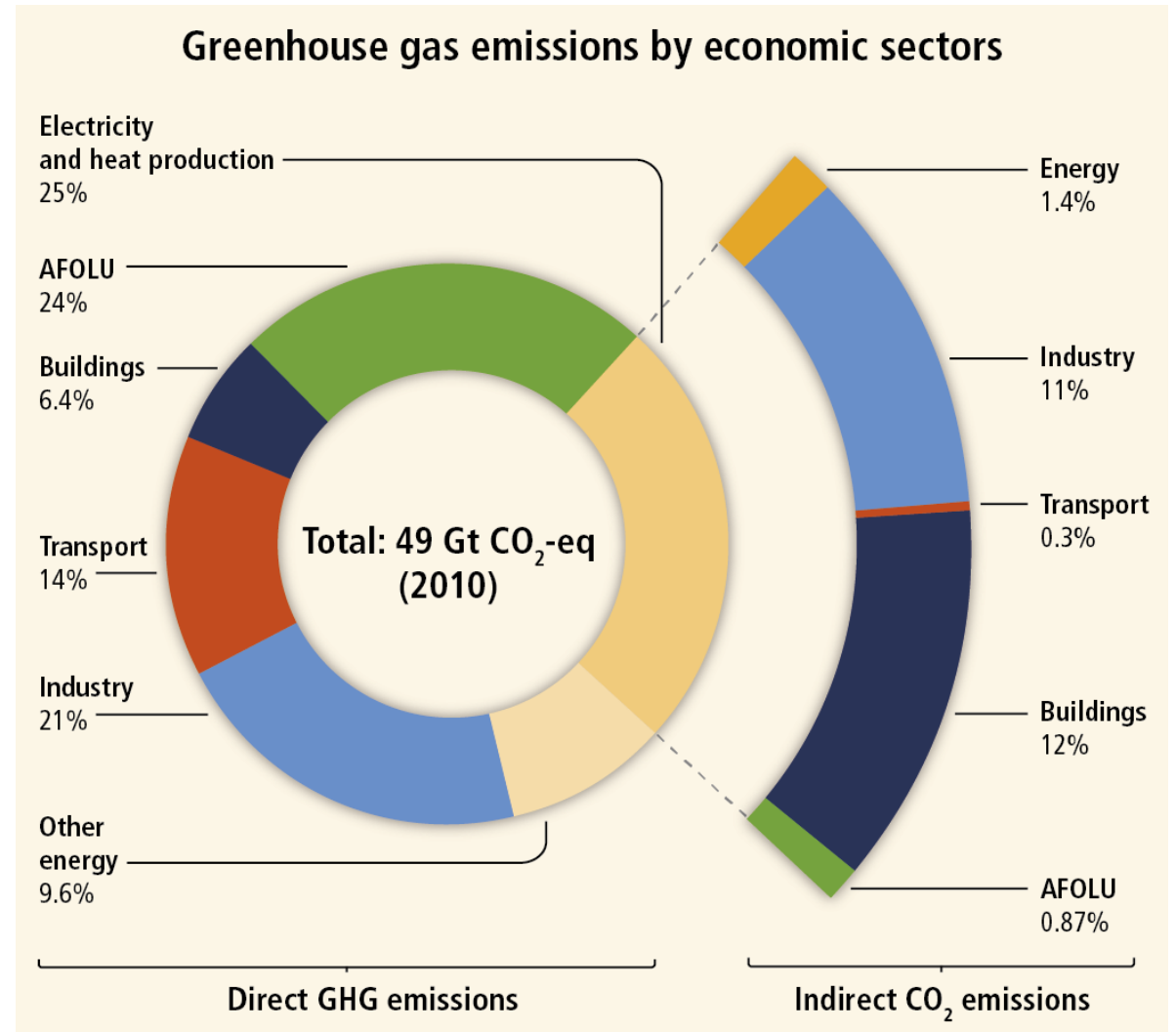

IPCC Climate Change 2014: Mitigation of Climate Change. Fig. 1.7.

http://ipcc.ch/pdf/assessment-report/ar5/syr/SYR_AR5_FINAL_full_wcover.pdf

Percent of ICT emissions

1. end-user devices	(2011: 60%	2030: 47.2%)
2. telecommunication networks	(2011: 22%	2030: 24%)
3. data centers	(2011: 17%	2030: 28.8%)

It's expected that:

1. end-user devices emissions will **decrease** due to devices' reduced direct and indirect emission rates
2. Data centers will **increase** even with mitigations in efficiency and cooling

#SMARTer2030: ICT Solutions for 21st Century Challenges. GeSI. 2015.

http://smarter2030.gesi.org/downloads/Full_report.pdf

Bitcoin / Blockchain energy use

Bitcoin (blockchain) mining and transactions use immense amounts of computing power.

“...each Bitcoin transaction currently require[s] 80,000 times more electricity to process than each Visa credit card transaction.”

<https://www.nytimes.com/2018/01/21/technology/bitcoin-mining-energy-consumption.html>

2018 to date: between 45-52 tWh per year (tera watts per hour)

<https://digiconomist.net/bitcoin-energy-consumption>

(compare to countries' annual usage)

Burning coal for electricity

Burning coal creates:



- Air pollution (toxic particulate matter, especially PM2.5 (particles 2.5 micrometers and smaller))
- Water pollution (mercury and selenium are by-products of coal burning; in a study of a Pittsburgh, PA-area plant, fish caught in waters nearby had 19x more mercury than “store-bought” fish)

In 2016: China power plants burned 50.6% of the world’s coal; India: 11%, USA 9.6%.

Coal-burning power plant, Datong, China. Photo: Jason Lee/Reuters

Annual deaths from air pollution: 6.5 million people

World Health Organization (Sept 27, 2016):

Deaths caused from PM2.5 excesses.

- Nearly two-thirds of those deaths are in Southeast Asia and the Western Pacific region, compared with 333,000 in Europe and the Americas. <http://www.nytimes.com/2016/09/28/world/air-pollution-smog-who.html>
- 600,000 deaths are children under 5. <http://www.nytimes.com/2016/10/31/world/asia/unicef-children-toxic-air.html?emc=eta1>

PM2.5-reduced movie theaters

- 20-seat “clean air” theater in Beijing.
- \$20/seat (4x the cost of regular ticket)
- PM2.5 kept below 20 $\mu\text{g}/\text{m}^3$
- Outdoors: usually over 100 $\mu\text{g}/\text{m}^3$ (sometimes over 500)



<http://www.latimes.com/world/asia/la-et-ct-china-movie-theaters-smog-pollution-air-20160122-story.html>

PM2.5 ranges set by EPA

EPA's table of breakpoints is:^{[33][34][35]} $\mu\text{g}/\text{m}^3$ = microgram per meter

O ₃ (ppb)	O ₃ (ppb)	PM _{2.5} (μg/m ³)	PM ₁₀ (μg/m ³)	CO (ppm)	SO ₂ (ppb)	NO ₂ (ppb)	AQI	AQI
$C_{low} - C_{high}$ (avg)	$C_{low} - C_{high}$ (avg)	$C_{low} - C_{high}$ (avg)	$C_{low} - C_{high}$ (avg)	$C_{low} - C_{high}$ (avg)	$C_{low} - C_{high}$ (avg)	$C_{low} - C_{high}$ (avg)	$I_{low} - I_{high}$	Category
0-54 (8-hr)	-	0.0-12.0 (24-hr)	0-54 (24-hr)	0.0-4.4 (8-hr)	0-35 (1-hr)	0-53 (1-hr)	0-50	Good
55-70 (8-hr)	-	12.1-35.4 (24-hr)	55-154 (24-hr)	4.5-9.4 (8-hr)	36-75 (1-hr)	54-100 (1-hr)	51-100	Moderate
71-85 (8-hr)	125-164 (1-hr)	35.5-55.4 (24-hr)	155-254 (24-hr)	9.5-12.4 (8-hr)	76-185 (1-hr)	101-360 (1-hr)	101-150	Unhealthy for Sensitive Groups
86-105 (8-hr)	165-204 (1-hr)	55.5-150.4 (24-hr)	255-354 (24-hr)	12.5-15.4 (8-hr)	186-304 (1-hr)	361-649 (1-hr)	151-200	Unhealthy
106-200 (8-hr)	205-404 (1-hr)	150.5-250.4 (24-hr)	355-424 (24-hr)	15.5-30.4 (8-hr)	305-604 (24-hr)	650-1249 (1-hr)	201-300	Very Unhealthy
-	405-504 (1-hr)	250.5-350.4 (24-hr)	425-504 (24-hr)	30.5-40.4 (8-hr)	605-804 (24-hr)	1250-1649 (1-hr)	301-400	Hazardous
-	505-604 (1-hr)	350.5-500.4 (24-hr)	505-604 (24-hr)	40.5-50.4 (8-hr)	805-1004 (24-hr)	1650-2049 (1-hr)	401-500	

https://en.wikipedia.org/wiki/Air_quality_index#Computing_the_AQI

Current AQI Forecast AQI Loop More Maps

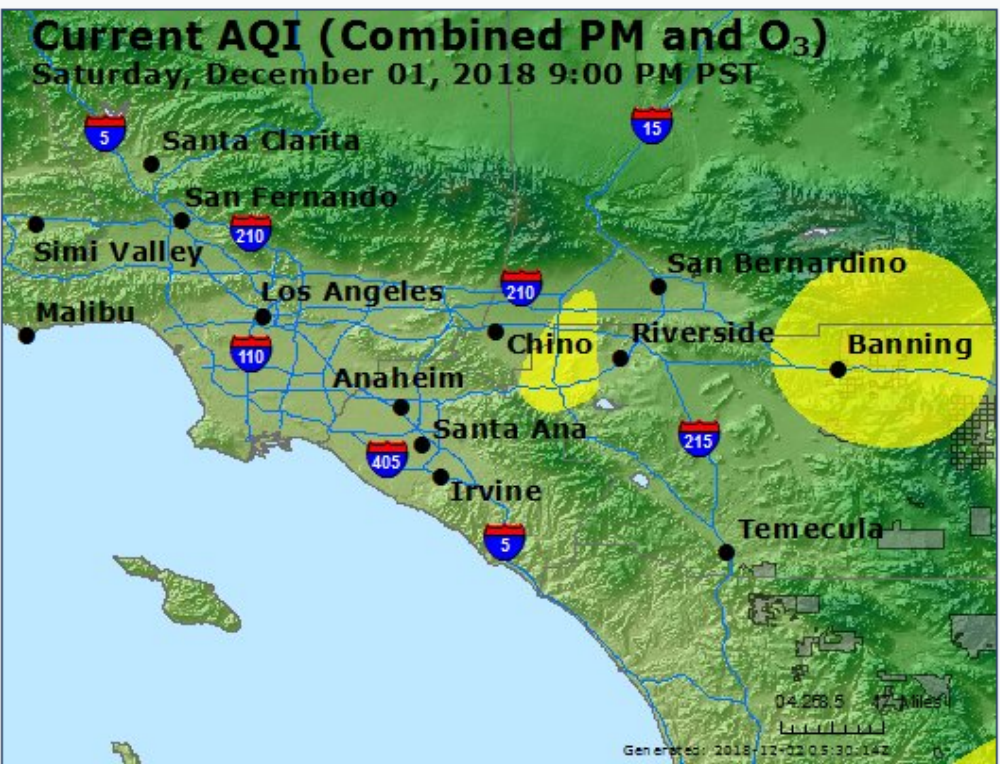

Tribal Boundaries
 The tribal boundaries shown here are provided by the Bureau of Indian Affairs and are intended to be used as a general spatial reference only. They are not a formal determination of tribal boundaries by the EPA.

Good
Moderate
USG
Unhealthy
Very Unhealthy
Hazardous
! Action Day

Local Air Quality Resources

Current Conditions
 Data Not Available

Air Quality Forecast

Today	Tomorrow
Air Quality Index (AQI) 42 Good Health Message: None	Air Quality Index (AQI) 46 Good Health Message: None

AQI - Pollutant Details

Today		Tomorrow	
Carbon Monoxide	6 Good	Carbon Monoxide	10 Good
Nitrogen Dioxide	11 Good	Nitrogen Dioxide	11 Good
Ozone	40 Good	Ozone	36 Good
Particles (PM10)	19 Good	Particles (PM10)	23 Good
Particles (PM2.5)	42 Good	Particles (PM2.5)	46 Good

Past Air Quality Maps and Data

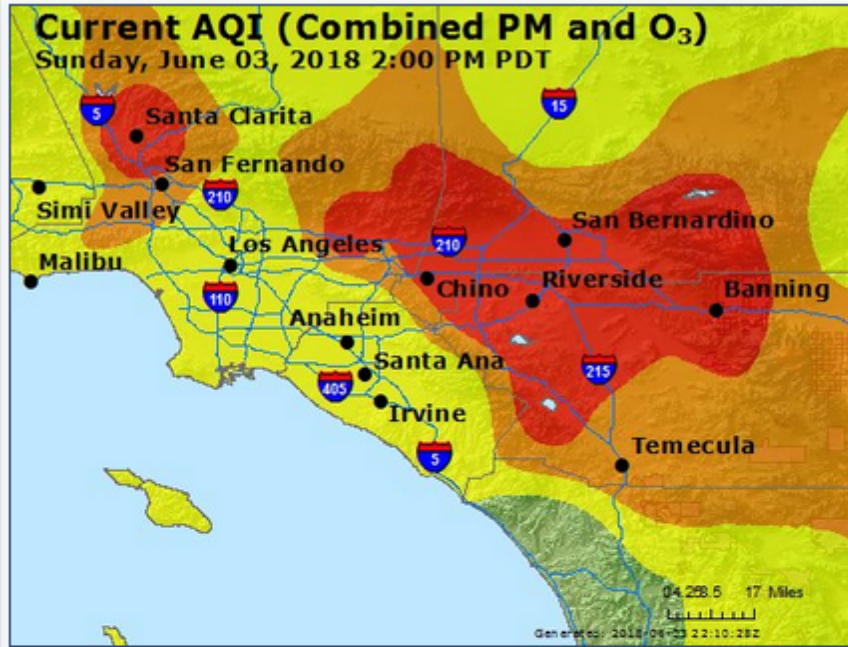

Tribal Boundaries
 The tribal boundaries shown here are provided by the Bureau of Indian Affairs and are intended to be used as a general spatial reference only. They are not a formal determination of tribal boundaries by the EPA.

Good
Moderate
USG
Unhealthy
Very Unhealthy
Hazardous
! Action Day

[Local Air Quality Resources](#)

South Coast Air Quality Management District,

[State Air Quality Resources](#)

Amador County Air Pollution Control District
 American Lung Association (ALA) of California
 Antelope Valley Air Quality Management District

Current Conditions

Air Quality Index (AQI)
 observed at 14:00 PDT

63 **Moderate**

Health Message: Unusually sensitive people should consider reducing prolonged or heavy exertion.

Note: Values above 500 are considered Beyond the AQI. Follow recommendations for the Hazardous category. Additional information on reducing exposure to extremely high levels of particle pollution is available [here](#).

AQI - Pollutant Details

Ozone	40	Good
Particles (PM2.5)	63	Moderate

Air Quality Forecast

Today	Tomorrow
Air Quality Index (AQI) 46 Good Health Message: None	Air Quality Index (AQI) 50 Good Health Message: None

AQI - Pollutant Details

Today		Tomorrow			
Carbon Monoxide	15	Good	Carbon Monoxide	15	Good
Nitrogen Dioxide	20	Good	Nitrogen Dioxide	20	Good
Ozone	46	Good	Ozone	46	Good
Particles (PM10)	17	Good	Particles (PM10)	25	Good
Particles (PM2.5)	38	Good	Particles (PM2.5)	50	Good

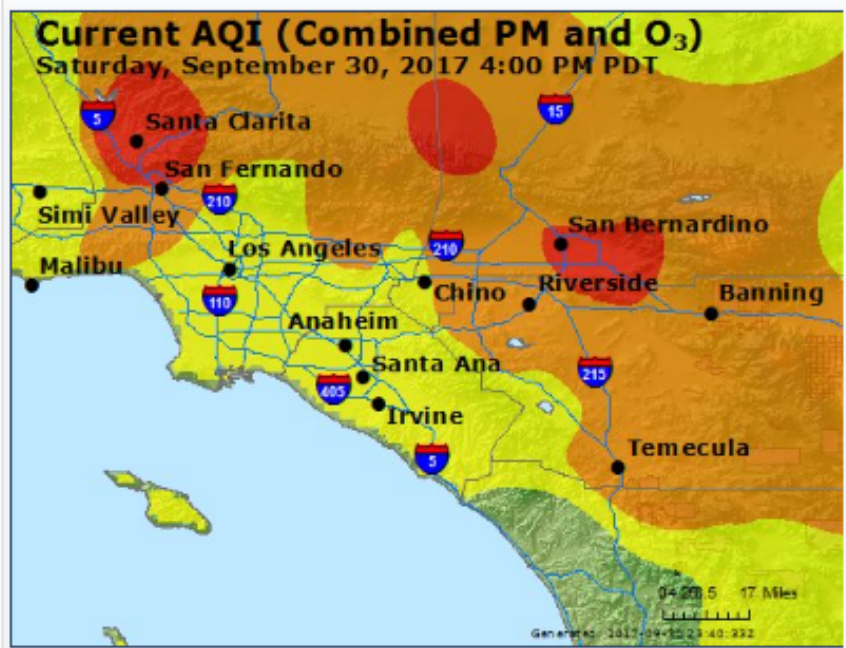

Tribal Boundaries
 The tribal boundaries shown here are provided by the Bureau of Indian Affairs and are intended to be used as a general spatial reference only. They are not a formal determination of tribal boundaries by the EPA.

Good
Moderate
USG
Unhealthy
Very Unhealthy
Hazardous
! Action Day

Local Air Quality Resources	
South Coast Air Quality Management District	

State Air Quality Resources	
Amador County Air Pollution Control District	
American Lung Association (ALA) of California	
Antelope Valley Air Quality Management District	
BAAQMD Spare the Air 2002	
Bay Area Air Quality Management District (BAAQMD)	
Butte County Air Pollution Control District	
California Air Resources Board (CARB)	
California Environmental Protection Agency	
California Environmental Protection Agency - Contact Us	

Current Conditions

Air Quality Index (AQI)
 observed at 18:00 PDT

136 Unhealthy for Sensitive Groups

Health Message: Active children and adults, and people with lung disease, such as asthma, should reduce prolonged or heavy exertion outdoors.

Note: Values above 500 are considered Beyond the AQI. Follow recommendations for the Hazardous category. Additional information on reducing exposure to extremely high levels of particle pollution is available [here](#).

AQI - Pollutant Details		
Ozone	136	Unhealthy for Sensitive Groups
Particles (PM10)	51	Moderate
Particles (PM2.5)	93	Moderate

Air Quality Forecast

Today	Tomorrow
<p>Air Quality Index (AQI)</p> <p>100 Moderate</p> <p>Health Message: Unusually sensitive people should consider reducing prolonged or heavy exertion outdoors.</p>	<p>Air Quality Index (AQI)</p> <p>67 Moderate</p> <p>Health Message: Unusually sensitive people should consider reducing prolonged or heavy exertion outdoors.</p>

AQI - Pollutant Details					
Carbon Monoxide	20	Good	Carbon Monoxide	25	Good
Nitrogen Dioxide	40	Good	Nitrogen Dioxide	40	Good
Ozone	100	Moderate	Ozone	67	Moderate
Particles (PM10)	41	Good	Particles (PM10)	48	Good
Particles (PM2.5)	63	Moderate	Particles (PM2.5)	66	Moderate

Emissions from coal-burning power plants kill people

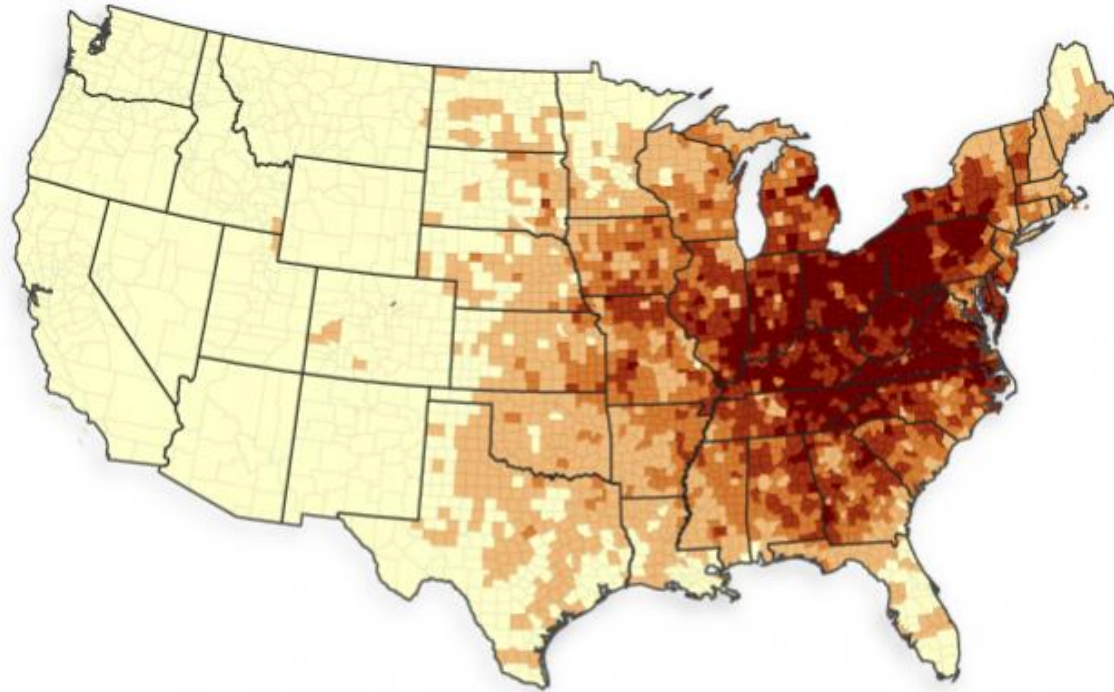

**National Mortality Effects
from Existing Powerplants**
(Annual Persons, per 100,000)

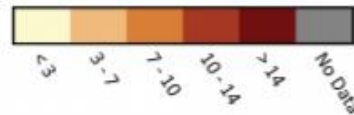

**Annual Mortality Due to
Individual Power Plants**
(Persons)



Data is estimated 2010 impacts. All monetary values are expressed in thousands of dollars.

County level data is health impacts/100,000 persons.

Direct toxic endangerment to people

200 million people are at risk to toxic exposure

- The World Health Organization, in conjunction with the World Bank, estimates that 23% of deaths in the developing world are attributable to environmental factors.

Types of toxin-producing entities (“usual suspects”):

- Coal and oil refineries
- Tanneries
- Chemical manufacturing
- Heavy metals mining and smelting
- Nuclear accidents

And now:

- **E-waste incineration**
- Battery recycling plants

Sign at Cottonwood Springs, Joshua Tree National Park, California (March 2015) [mine closed in 1910]



Electronics products lifespans:

- Initial service life (original owner use): 2-8 years
 - Manufacturers also build-in “end of life” as new models are released
- Second service life (after original owner to end of life): (5-20 years)

End-of-life options:

- Landfill
- Incineration
- Recycling
- Exportation

E-waste: cables, monitors, computers, servers, circuit boards, telephones, data storage devices, batteries, etc.

E-waste recycling: Consumer electronics

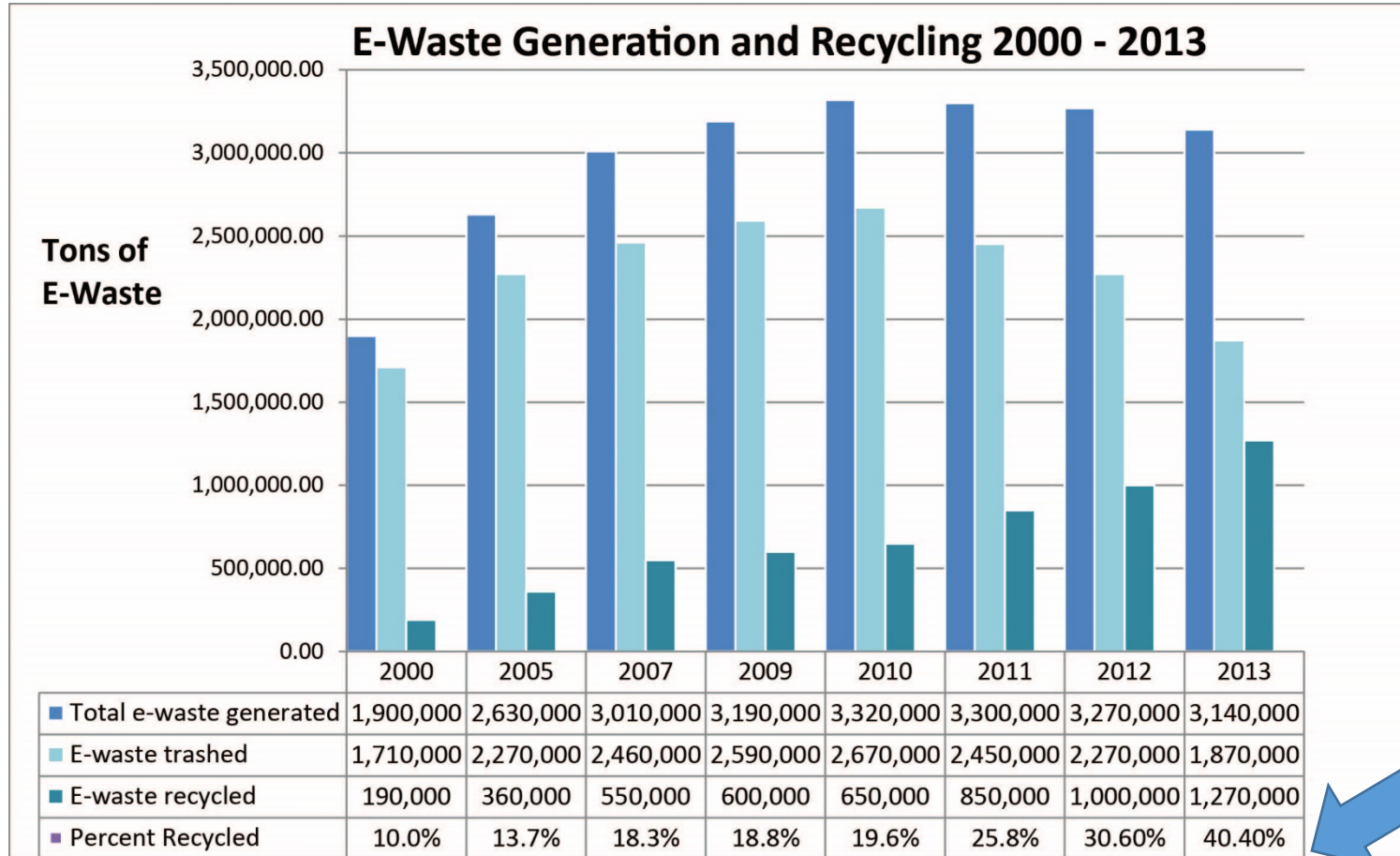

<http://www.electronicstakeback.com/designed-for-the-dump/e-waste-in-landfills/>

E-waste exportation

Countries export electronics to Asian and under-developed countries for re-use and/or recycling (often calling shipments “second-hand goods” or “metal scrap” to avoid **Basel Convention** ban).

Often the hardware isn't used but stripped of copper and other metals.



<http://www.china-underground.com/magazine/inside-china-e-waste-hell>

Cellphones

- Contain heavy and rare earth metals: mercury, arsenic, beryllium, cadmium, lead
- Recyclable components: steel, copper, aluminum, glass
- BUT difficult to recycle due to small parts that are glued together.
- Consumers view them as eminently disposable.



How recyclable is your phone?

Brand	Rating out of 20
Fairphone smartphone	15
Doro PhoneEasy	10
Amplicomms mobile	9.5
Alcatel mobile phones	9
Huawei smartphone	8.5
Acer smartphones	8
ZTE mobile phone	7.5
HTC smartphones	7
iPhone smartphone	7
Sony Xperia smartphone	7
Blackberry smartphones	6
Motorola smartphones	5.5
Google Nexus smartphone	4.5
LG mobile phone handsets	4
Nokia mobile phones	4
Samsung mobile phones	3.5
Amazon Fire	2

Some manufacturers are developing phones that are recycle-friendly:

- Easily extracted screws, no adhesives, simple to dismantle.
- Using recycled or biodegradable plastic

<http://www.mobileindustryreview.com/2014/12/mobile-environment-impact.html> ;

<http://www.ethicalconsumer.org/buyersguides/phonebroadband/mobilephones.aspx>

Heavy and Rare earth metals

Heavy and rare earth metals: used in making phones, computers, TVs, servers, external hard drives, solid state drives, batteries – anything electronic. Rare earth metals are used in solar energy technology.

Less than one percent of rare earth elements are currently recycled.

Heavy metals are toxic by their nature. They include: mercury, arsenic, copper, aluminum, lead, cadmium, chromium, cobalt, nickel, zinc, selenium, silver, antimony, and thallium.

Coltan (columbite–tantalite)



- Tantalite used in tantalum capacitors (cellphones, laptops, most electronic devices).
- “Conflict mineral:” Uncontrolled mining in Democratic Republic of Congo: deforestation, eastern mountain gorilla population decreased (habitat destroyed, eaten by miners (“bush meat”)); smuggling to support civil conflict

Open burning of e-waste in some countries

E-waste is incinerated to extract copper, aluminum and other metals.

Toxins go into the air and soil.

From the soil, the toxins migrate into groundwater.



Plastic e-waste (e-plastic)



Recycling plastic is an established industry, with methods for recycling plastic bottles the best-established.

Plastics in computers, servers, phones, monitors, video and data tape shells have different formulations so the plastic parts must be separated for recycling and processing.

Videotape as e-waste

Three components for recycling:

1. plastic shell
2. metal screws & parts
3. tape itself

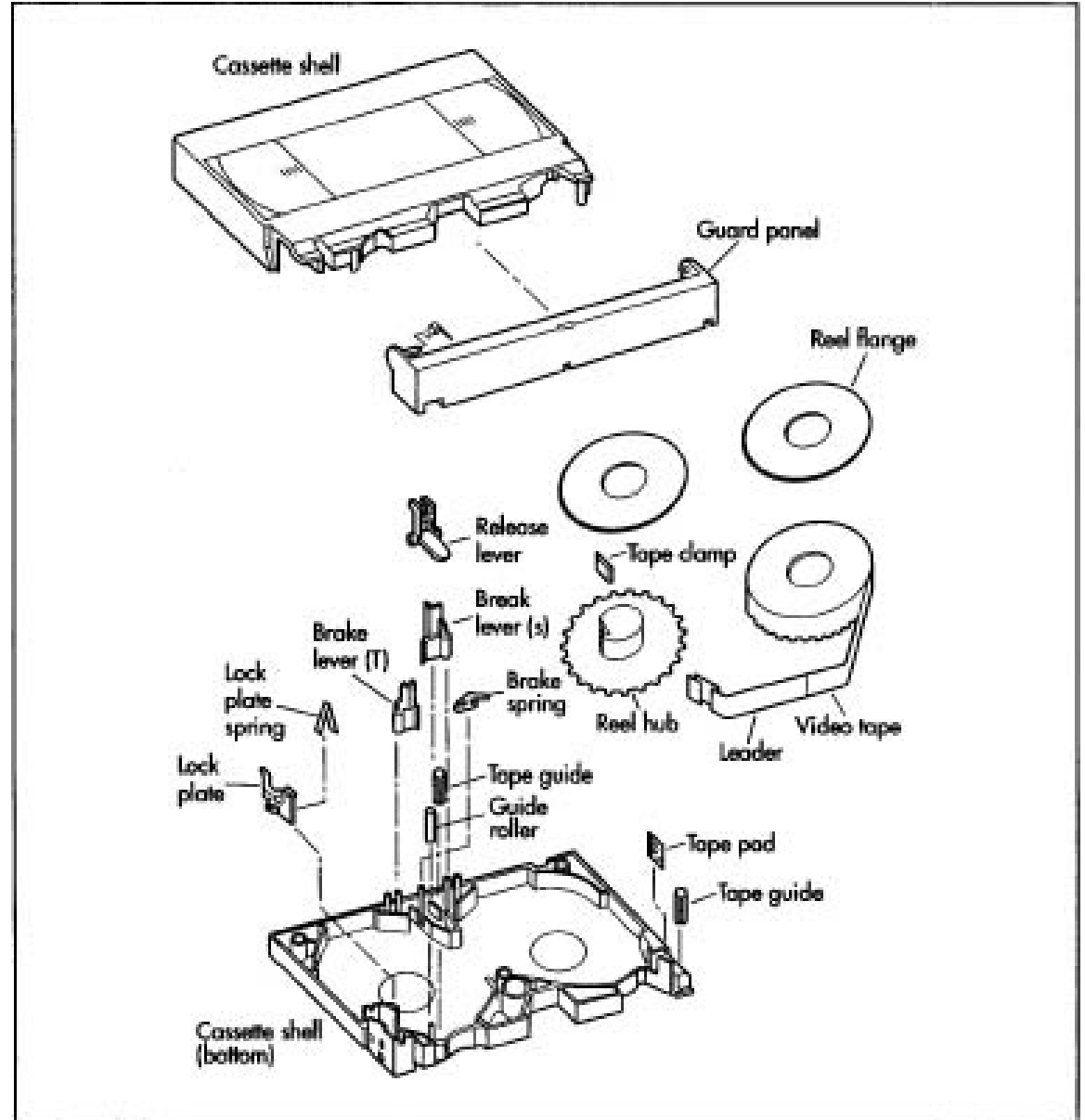

Videotape as e-waste

Videotape ribbon itself is made of (simplified):

- **Base film:** mylar (PET)
- **Binder:** lubricants, adhesives, polymers (no binder in Metal Evaporated tapes)
- **Magnetic particles:** iron oxide, chromium oxide (CrO₂), cobalt, barium ferrite (BaFe)

Mylar base (PET) can be recycled, but currently there is no process to separate the magnetic particles and binder from the mylar.

The raw magnetic materials are toxic; unknown how they will break down in their tape formulations if dumped in landfills.

Creative re-use of tape



Audiocassette tape mixed with yarn to make a purse and Barbie Doll outfit.
<http://www.myrecycledbags.com/category/cassette-tape-crafts/>



Philip Ob Rey's "*V*" *HS Project*. <http://www.humantropy.com/v-hs-1/>



Videotape as e-waste

Recyclers have these options:

1. Shred the full item and incinerate or dump the pieces into a landfill.
2. Disassemble the tape: melt the plastic cassette and screws. Shred the videotape itself, and dump into landfill or incinerate.

Videotape as e-waste: Recycling vendors examples

Sims Recycling Solutions (California facility):

- Will separate video parts for higher fee since more labor-intensive.
- Videotape is incinerated, following California incinerator regulations.
- Standard procedure is to shred the full case with tape and incinerate.

GreenDisk (Washington State):

- Separates videotape parts.
- Videotape is shredded, but not disposed. 100,000 lbs (45 metric tons) currently stored in a warehouse until a recycling solution is developed.

Data storage

Once the audio/videotape is digitized, the digital files must be stored and managed.



New Facebook data center (Altoona, Iowa) powered by a wind farm.

Data storage options

Physical carriers:

- Spinning disk (servers, hard drives)
- Digital tape
- NAND (Solid state/flash)

Often storage is a mix (Hierarchical Storage Management, or HSM):

- online (spinning disk)
- nearline (tape in a robotic system)
- offline (tape or other media not using power)

Data storage options: Spinning disk

Servers (single or networked)

Electricity use: High

- Internal fans; power to operate/process
- Environment must be maintained at constant temperature
- Helium-filled drives reduce energy use by 23%

Life expectancy: Replaced every 3-5 years (initial service life)

Potential recyclable parts: plastics, rare earth metals, heavy metals (copper, aluminum, steel). Re-use potential (2nd life), but servers will eventually likely end up in landfills after stripping some metals.



Recycling spinning disks

Three HDD manufacturers remaining:

- Seagate (40%)
- Western Digital (WD owns HGST/Hitachi) (40%)
- Toshiba (20%)

They publish lifecycle data (LCA) that includes “Bill of Substances” and environmental impact.

Seagate example: <http://www.seagate.com/global-citizenship/life-cycle-assessment/>

International Electronics Manufacturing Initiative (iNEMI). Project Report: Value Recovery from Used Electronics. February 2017. <http://www.inemi.org/value-recovery-report>

Recycling spinning disks: manufacturer's perspective

Material recovery if components harvested:

- Aluminum substrate (largest raw material)
- Magnetic coating (rare earth material; China controls 90%)

But difficult for recyclers to disassemble (“death by screws”). Calculate cost to disassemble and recycled raw materials value vs. simple shredding.

They recommend recycle through re-use, but only lower capacity HDDs.

Wasted energy

“Typical servers in the U.S. only use 5 to 15 percent of their maximum capability on average, while consuming 60 to 90 percent of their peak power This wasted energy represents the equivalent output of 13 power plants.”

“.... **small** server rooms and closets account for over 50 percent of data center energy use in the U.S. ... **30 to 70 percent of electricity** use comes from powering and cooling servers running 24 hours a day.”

-- *Are There Ghosts in Your Closet? Saving Wasted Energy in Computer Server Rooms*. National Resources Defense Council (2012). <http://www.nrdc.org/energy/files/Saving-Energy-Server-Rooms-FS.pdf>

Air conditioning and HFCs

Air conditioners emit hydrofluorocarbons (HFCs), 1000 times more potent a GHG than carbon dioxide.

Kigali Accord (10/15/2016) will globally phase out HFCs by 2047. More specific than Paris accords. *“Will lead to the reduction of the equivalent of 70 billion tons of carbon dioxide from the atmosphere — about two times the carbon pollution produced annually by the entire world.”* Could decrease global temperature 1° F.

-- <http://www.nytimes.com/2016/10/15/world/africa/kigali-deal-hfc-air-conditioners.html?emc=eta1>

Chemical industry already developing replacement technologies.

Microsoft data center in the ocean? Project Natick

- Ocean water cools the servers, which must last 5 years
- Uses electricity from the moving seawater
- Heat doesn't expand beyond a few inches
- Cables attached to land

<http://natick.research.microsoft.com/>

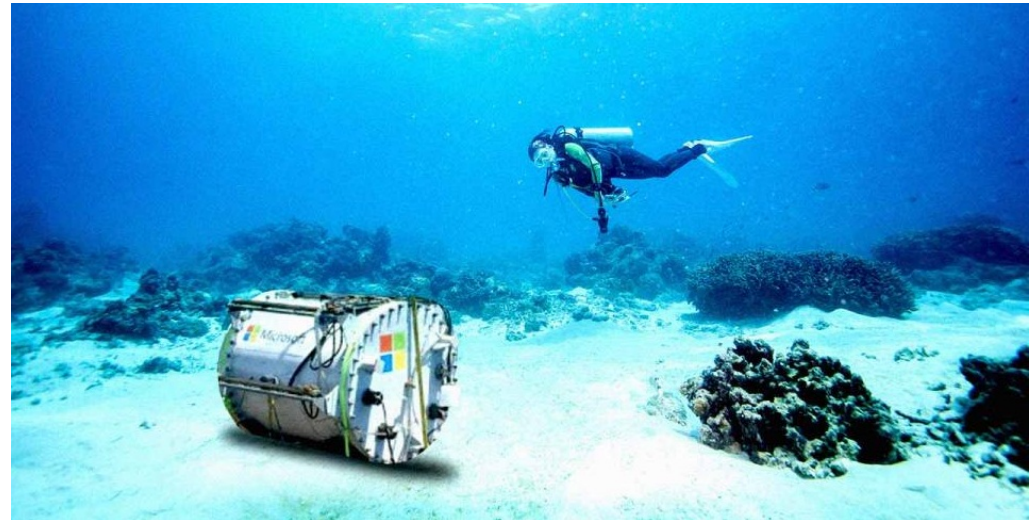

http://www.nytimes.com/2016/02/01/technology/microsoft-plumbs-oceans-depths-to-test-underwater-data-center.html?_r=0

Data storage options: Spinning disk

External hard drives (single or networked)

Electricity use: Low-medium

- Internal fans; power to operate
- Can be used as offline storage (powered up only when needed)
- Environment must be maintained at constant temperature

Life expectancy: Replaced every 3-5 years

Potential recyclable parts: plastics, rare earth metals, heavy metals, magnets. Failure rates make this medium not as re-usable as servers. Likely candidate for landfills.



Data storage options: Data storage tape

LTO, Oracle (Sun/StorageTek) T10000 series, IBM 3592

Electricity use: Low-Medium

- On shelf: no power. In drive or robotic system: low-medium
- Can be used as offline storage (used only when needed)
- Environment must be maintained at constant temperature (but higher than electronics)

Life expectancy: LTO: Replaced every 2 generations (LTO7 released Dec. 2015, LTO8 Oct 2017). Oracle is discontinuing the T10k series (announced 2017)

Potential recyclable parts: plastics, screws (metal). No process yet to separate mylar ribbon (recyclable) from barium ferrite (BaFe), metal particle, or other components. Generational obsolescence, finite number of “reads,” and WORM technology limits this medium’s re-usability.



Spinning disk and tape: Total Cost of Ownership (TCO)

TCO includes: cost of hardware, maintenance, media, energy, floor space. **TCO for disk-based storage is 26 times that of tape-based.**

- Cost of **energy**: disk-based storage uses **105 times** more energy than tape-based
- Floor space: disk needs **4 times** the space as tape
- Cost of media is 25% the TCO for tape-based solution

Mixed storage:

- With 50% on tape, the TCO is reduced by 48%
- With 90% on tape, the TCO is reduced by 87%

This doesn't include staff costs.

-- *Revisiting the Search for Long-Term Storage: a TCO Analysis of Tape and Disk*. The Clipper Group Calculator. (2013)
<http://www.clipper.com/research/TCG2013009.pdf>

Data storage options: NAND Flash Memory on Solid State Drives (SSD)

- No moving parts (power down when not in use)
- Runs cooler than spinning disk
- Finite number of writes; infinite number of reads



Electricity use: Low-medium

- Powered up only when used, but uses a lot of power when starting up
- Works in extreme environments (up to 70°C / 158° F)

Life expectancy: Depends on number of writes.

Potential recyclable parts: silicon, copper; no rare earth metals.

Data storage options: “Cloud” (e.g., storing your files on other people’s servers)



















“Cloud” **storage (not preservation)**: online or nearline (tape). You pay for what you use, and don’t need to purchase hardware.

Consider your vendor’s power source. Is it **dirty**?

- The 6 major “cloud” service providers are moving towards using 100% renewable energy: Apple, Box, Facebook, Google, Salesforce and Rackspace.

Facebook, Google, and Apple are investing in building wind and solar farms to power their data centers and to supply neighbors.

Company Scorecard

	Final Grade	 Clean Energy Index	 Natural Gas	 Coal	 Nuclear	Energy Transparency	Renewable Energy Commitment & Siting Policy	Energy Efficiency & Mitigation	Renewable Procurement	Advocacy
	B	23%	37%	23%	11%	B	A	B	B	A
	D	24%	3%	67%	3%	F	F	C	F	D
	C	17%	24%	30%	26%	F	D	C	C	B
	A	83%	4%	5%	5%	A	A	A	A	B
	F	24%	3%	67%	3%	F	F	D	F	F
	A	67%	7%	15%	9%	A	A	A	A	B
	A	56%	14%	15%	10%	B	A	A	A	A
	C	50%	17%	27%	5%	D	B	C	B	C
	C	29%	29%	27%	15%	C	B	C	C	F
	B	32%	23%	31%	10%	B	B	C	B	B
	C	2%	19%	39%	31%	B	B	B	D	D
	D	8%	26%	36%	25%	D	D	F	D	F
	B	43%	12%	16%	15%	B	A	C	B	B
	D	11%	19%	29%	31%	C	D	C	D	C
	F	24%	3%	67%	3%	F	F	D	F	F

From:





Clicking Clean: Who is Winning the Race to Build a Green Internet?

Greenpeace, January 2017.





<http://www.clickclean.org/usa/en/>

Internet Company Scorecard

Video Streaming

	Final Grade	 Clean Energy Index	 Natural Gas	 Coal	 Nuclear	Energy Transparency	Renewable Energy Commitment & Siting Policy	Energy Efficiency & Mitigation	Renewable Procurement	Advocacy
Afreeca.com	F	2%	19%	39%	31%	F	F	F	F	F
Amazon Prime	C	17%	24%	30%	26%	F	D	C	C	B
HBO	D	22%	20%	25%	25%	D	F	F	F	F
Hulu	F	20%	30%	29%	20%	F	F	F	F	F
Netflix	D	17%	24%	30%	26%	F	F	C	D	F
Pooq.co.kr	F	2%	19%	39%	31%	F	F	F	F	F
Vevo	F	27%	15%	32%	26%	F	F	F	F	F
Vimeo	D	47%	13%	20%	19%	D	F	F	C	F
YouTube	A	56%	15%	14%	10%	B	A	A	A	A

Music/Audio Streaming

	Final Grade	 Clean Energy Index	 Natural Gas	 Coal	 Nuclear	Energy Transparency	Renewable Energy Commitment & Siting Policy	Energy Efficiency & Mitigation	Renewable Procurement	Advocacy
iTunes	A	83%	4%	5%	5%	A	A	A	A	B
NPR	F	17%	24%	30%	26%	F	F	F	F	F
Pandora	F	13%	32%	20%	27%	F	F	F	F	F
SoundCloud	F	17%	24%	30%	26%	F	F	F	F	F
Spotify	D	56%	15%	14%	10%	F	F	F	C	F
Podbbang	F	2%	19%	39%	31%	F	F	F	F	F





From:

Clicking Clean: Who is Winning the Race to Build a Green Internet?





Greenpeace, January 2017.

<http://www.clickclean.org/usa/en/>

Messaging

	Final Grade	 Clean Energy Index	 Natural Gas	 Coal	 Nuclear	Energy Transparency	Renewable Energy Commitment & Siting Policy	Energy Efficiency & Mitigation	Renewable Procurement	Advocacy
iMessage	A	83%	4%	5%	5%	A	A	A	A	B
Kakao Talk	C	2%	19%	39%	31%	C	D	D	F	C
QQ	F	24%	3%	67%	3%	F	F	D	F	F
Skype	B	32%	23%	31%	10%	B	B	C	B	B
WeChat	F	24%	3%	67%	3%	F	F	D	F	F
WhatsApp	A	67%	7%	15%	9%	A	A	A	A	B

Search

	Final Grade	 Clean Energy Index	 Natural Gas	 Coal	 Nuclear	Energy Transparency	Renewable Energy Commitment & Siting Policy	Energy Efficiency & Mitigation	Renewable Procurement	Advocacy
Baidu	F	24%	3%	67%	3%	F	F	D	F	F
Bing	B	32%	23%	31%	10%	B	B	C	B	B
Daum.net	C	2%	19%	39%	31%	C	D	D	F	C
Google.com	A	56%	15%	14%	10%	B	A	A	A	A
Nate	F	2%	19%	39%	31%	F	F	F	F	F
Naver	D	2%	19%	39%	31%	B	D	B	D	D
Yahoo	B	74%	5%	12%	6%	C	B	B	B	D
Zum	F	2%	19%	39%	31%	F	F	F	F	F

From:

Clicking Clean: Who is Winning the Race to Build a Green Internet?

Greenpeace, January 2017.

<http://www.clickclean.org/usa/en/>

Social Media

	Final Grade	 Clean Energy Index	 Natural Gas	 Coal	 Nuclear	Energy Transparency	Renewable Energy Commitment & Siting Policy	Energy Efficiency & Mitigation	Renewable Procurement	Advocacy
82cook.com	F	2%	19%	39%	31%	F	F	F	F	F
Band.us	F	2%	19%	39%	31%	F	F	F	F	F
Clien.net	F	2%	19%	39%	31%	F	F	F	F	F
Coolenjoy.net	F	2%	19%	39%	31%	F	F	F	F	F
DCinside.com	F	2%	19%	39%	31%	F	F	F	F	F
Facebook.com	A	67%	7%	15%	9%	A	A	A	A	B
Gasengi.com	F	2%	19%	39%	31%	F	F	F	F	F
llbe.com	F	2%	19%	39%	31%	F	F	F	F	F
Instiz.net	F	2%	19%	39%	31%	F	F	F	F	F
Instagram	A	67%	7%	15%	9%	A	A	A	A	B
Inven.co.kr	F	2%	19%	39%	31%	F	F	F	F	F
JjangOu.com	F	2%	19%	39%	31%	F	F	F	F	F
Lezhin.com	D	56%	15%	14%	10%	F	F	F	C	F
LinkedIn.com	B	10%	31%	23%	20%	A	A	B	B	A
Nexon.com	F	2%	19%	39%	31%	F	F	F	F	F
Pinterest	F	17%	24%	30%	26%	F	F	F	F	F
Ppomppu	F	2%	19%	39%	31%	F	F	F	F	F
Reddit.com	F	17%	24%	30%	26%	F	F	F	F	F
Twitter	F	10%	43%	21%	14%	F	F	F	F	F





From:

Clicking Clean: Who is Winning the Race to Build a Green Internet?





Greenpeace, January 2017.

<http://www.clickclean.org/usa/en/>

Blogs

	Final Grade	 Clean Energy Index	 Natural Gas	 Coal	 Nuclear	Energy Transparency	Renewable Energy Commitment & Siting Policy	Energy Efficiency & Mitigation	Renewable Procurement	Advocacy
Blog.me	C	2%	19%	39%	31%	B	B	B	D	D
Blogger.com	A	56%	15%	14%	10%	B	A	A	A	A
Egloos.com	F	2%	19%	39%	31%	F	F	F	F	F
Tistory.com	F	2%	19%	39%	31%	F	F	F	F	F
Tumblr	B	74%	5%	12%	6%	C	B	B	B	D
WordPress	D	13%	34%	29%	15%	B	F	F	F	F

E-Commerce

	Final Grade	 Clean Energy Index	 Natural Gas	 Coal	 Nuclear	Energy Transparency	Renewable Energy Commitment & Siting Policy	Energy Efficiency & Mitigation	Renewable Procurement	Advocacy
11st.co.kr	F	2%	19%	39%	31%	F	F	F	F	F
Aladin.co.kr	F	2%	19%	39%	31%	F	F	F	F	F
Amazon.com	C	17%	24%	30%	26%	F	D	C	C	B
Auction.co.kr	F	2%	19%	39%	31%	F	F	F	F	F
Bobaedream	F	2%	19%	39%	31%	D	F	F	F	F
Coupang.com	F	2%	19%	39%	31%	F	F	F	F	F
Danawa.com	F	2%	19%	39%	31%	F	F	F	F	F
eBay.com	B	38%	38%	13%	10%	B	D	C	C	A
Etsy.com	B	14%	19%	36%	31%	A	A	B	B	B
Gmarket.co.kr	F	2%	19%	39%	31%	F	F	F	F	F
Interpark	F	2%	19%	39%	31%	F	F	F	F	F
Wemakeprice	F	2%	19%	39%	31%	F	F	F	F	F
Yes24.com	F	2%	19%	39%	31%	F	F	F	F	F

From:

Clicking Clean: Who is Winning the Race to Build a Green Internet?

Greenpeace, January 2017.

<http://www.clickclean.org/usa/en/>

It's not too late to effect change



Los Angeles smoggy day, 1970s.

Cleaner air, healthier lungs

A study of more than 2,000 children in five Southern California cities found that their lung function improved as air pollution dropped.

As air pollution* declined...

...the percentage of children with abnormally low lung function dropped.



Group 1

'94-'98

7.9%

Group 2

'97-'01

6.3%

Group 3

'07-'11

3.6%

*Scale measures fine particle pollution/PM2.5 (annual average) in micrograms per cubic meter

Sources: Gauderman et al. 2015, New England Journal of Medicine; USC Children's Health Study

@latimesgraphics

Report released March 4, 2015

It's not too late to effect change



Beijing smoggy day, 2013.

Photograph: HAP/Quirky China News / Rex Feat



CREDIT: YOUTUBE.COM/SCREENSHOT

Over the weekend in China, 175 million people — more than the entire population of Bangladesh — watched a newly released in-depth and well-produced documentary about the country's debilitating smog problem. Produced by former Chinese news anchor and environmental reporter, Chai Jing, the 104-minute "Under the Dome" has caught the Chinese public at a moment of intense focus on the wide-ranging impacts of air pollution from coal-fired power plants and vehicle emissions.

Chai Jing's review: Under the Dome – Investigating China's Smog
柴静雾霾调查：穹顶之下 [March 1, 2015]

<https://www.youtube.com/watch?v=T6X2uwIQGQM#t=207>

<http://thinkprogress.org/climate/2015/03/02/3628458/chinese-air-pollution-documentary-clears-the-haze/>

UN Climate Change Conference (Paris December 2015) (COP21)

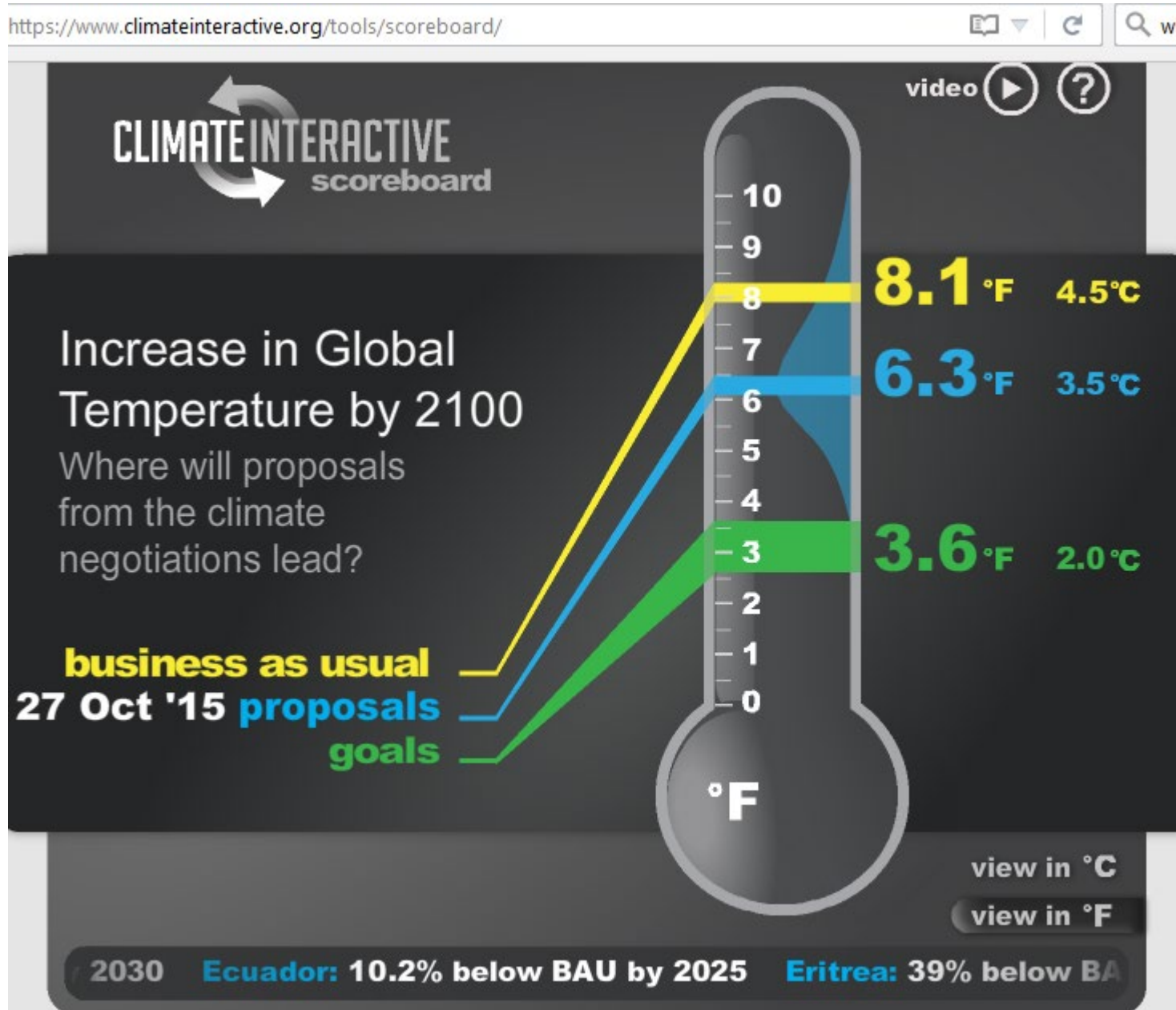

Countries proposed the percentage they'll lower GHG by 2030.

It's not enough.

More must be done.

Climate Interactive.

<https://www.climateinteractive.org/> [chart: 2016]

UN Climate Change Conference (Paris December 2015) (COP21)



Increase in Global Temperature by 2100

Where will proposals from the climate negotiations lead?

business as usual
national proposals
goals

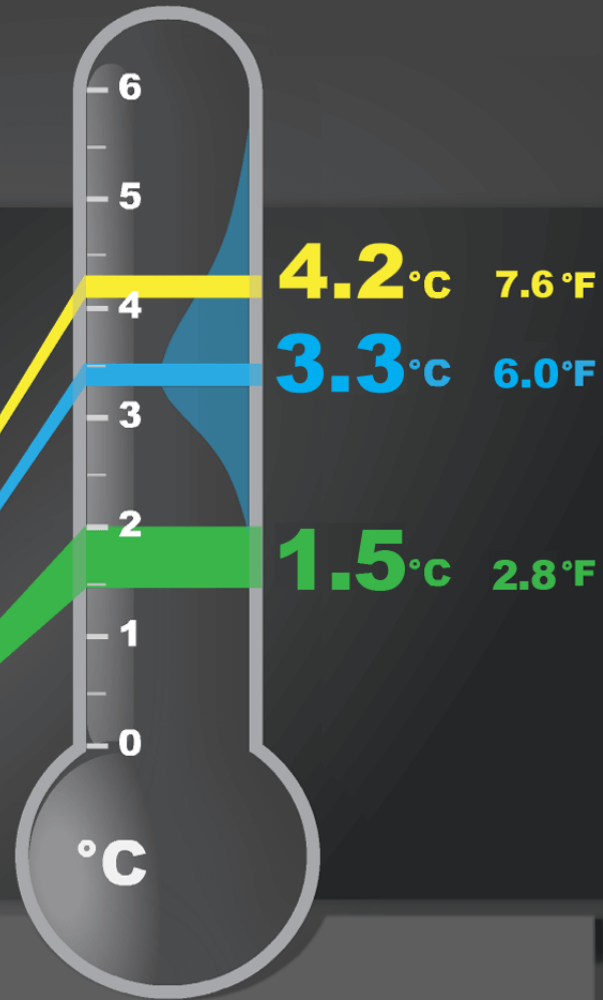

Countries proposed the percentage they'll lower GHG by 2030.

It's not enough.

More must be done.

Climate Interactive.

<https://www.climateinteractive.org/>

[chart: Dec 2018]

Paris Accord today

- Only one country hasn't signed: Syria
- Only one country has withdrawn:
USA (6/1/2017)

13 states, Puerto Rico, and mayors of 50 cities pledge they will continue with commitments.

Under the terms of the Paris Accord, countries can't effectively withdraw for 3 years after it takes effect. For the US, that's 11/4/2019.

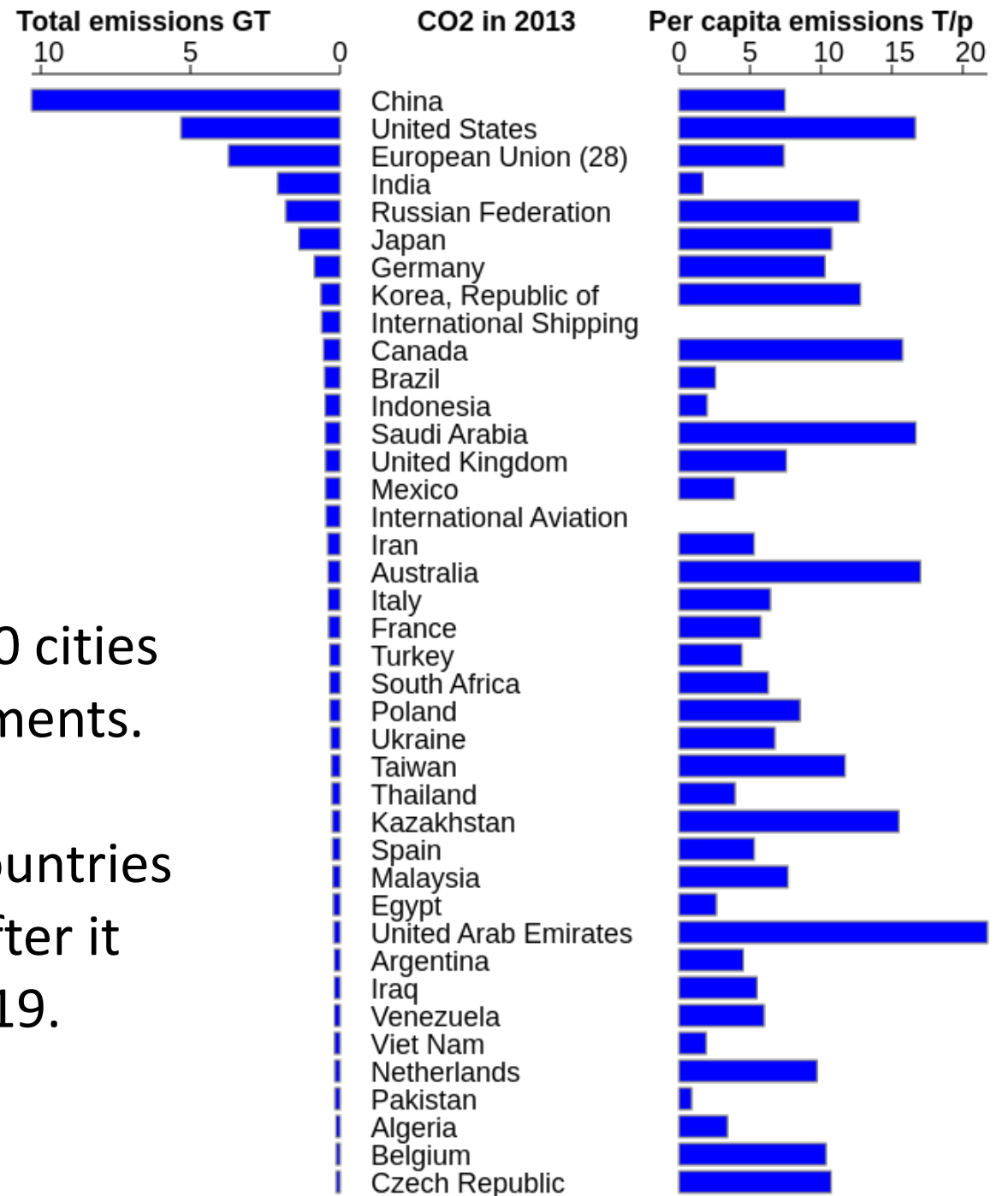

Change through lawsuits

June 2015:

The Hague District Court ordered the Dutch government to cut GHG emissions 25% by 2020 (currently planned at 14-17%.)

<http://www.theguardian.com/environment/2015/jun/24/dutch-government-ordered-cut-carbon-emissions>

http://www.huffingtonpost.com/2015/06/24/dutch-climate-change-case_n_7653050.html

Photo: Uberprutser



https://commons.wikimedia.org/wiki/File:Goliath_Poldermolen.jpg

Sued under tort law: a government has a duty to take care of its citizens.

900 people sued that they were being wrongfully harmed by their government's inaction.

Change through lawsuits: US

Juliana v. U.S (Our Children's Trust). Youth assert that “through the government's affirmative actions that cause climate change, it has violated the youngest generation’s constitutional rights to life, liberty, and property, as well as failed to protect essential public trust resources.” Filed 2015 in US District Court in Oregon. Survived motion to dismiss; Trump admin claimed the trial would be onerous to the government. March 2018: 9th Circuit Court of Appeal ruled in favor of plaintiffs. November 2018: various motions to stay; Trump admin won a temporary stay on trial, but trial prep continues in the meantime.

<https://www.ourchildrenstrust.org/us/federal-lawsuit>

California cities and counties suing fossil fuel companies for damages relating to rising sea levels: San Francisco, Oakland, Imperial Beach; San Mateo and Marin Counties. Relying on “public nuisance” claims similar to those brought against tobacco industry. Lost first round; under appeal.

<https://thinkprogress.org/california-local-climate-change-lawsuit-fc399a6e6895/>

Change through choices

- Individual
- ICT and related industries
- Archives

In 2014, **“for the first time since the invention of the steam engine, global emissions remained flat even as the global economy grew by about 3%.”**

-- Elizabeth Kolbert. “The Weight of the world.” *The New Yorker*, 24 Aug 2015

*But the UN 2018 Gap report released November 2018: “**Global CO2 emissions from energy and industry increased in 2017, following a three-year period of stabilization.**”* Emissions in 2017 were 1.1% higher than 2016. -- <https://www.unenvironment.org/resources/emissions-gap-report-2018>

It's working

In 2016, global greenhouse gas levels increased by about 0.5%, the slowest since the early 1990s (except for global recession years). US: decreased 2%

Why? Lower coal consumption due to the global switch to natural gas and renewable energy sources (wind and solar power.)

Methane CO2 emissions has increased.

Trends in global CO2 and total greenhouse gas emissions - Summary of the 2017 report. Published 28 September 2017. PBL Netherlands Environmental Assessment Agency

<http://www.pbl.nl/en/publications/trends-in-global-co2-and-total-greenhouse-gas-emissions>

We know what we can do as individuals to lower our carbon "footprint"



Please Turn Lights Off When You Leave The Room

Protect the Environment for our Children

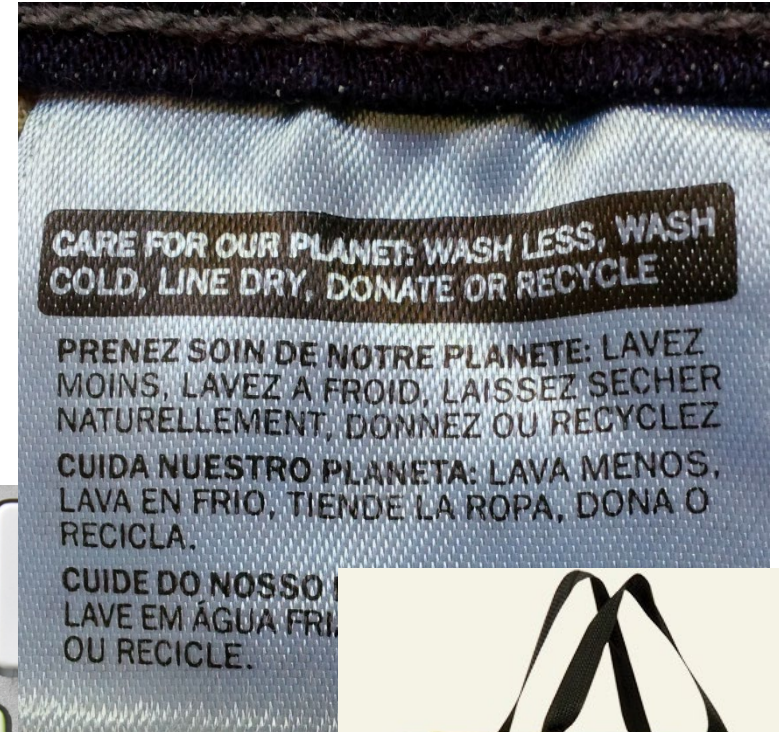

ICT and related industries

- **Device** manufacturers developing products using less energy and more recyclable parts (ex.: Fairphone)
- **Power sources:** trend to **renewables** (solar, air, hydro, biothermal): By 2030, 25% of global power sources will be renewables (Deutsche Bank). Germany is now 33%.

Goals by 2030:

50% in California (25% by 2020; it's 32% in 2017)

28% in US

40% in France (law passed July 2015)

20% in China

- **Recycling materials:** plastic bottles already turned into carpet threads, fabrics, flooring, benches; increased R&D for recycling other plastics and heavy/rare earth metals.



The Environmental Impact of Archives

Climate change impacts archives...

[email excerpt from Puerto Rican General Archive, 9/30/2017] The Institute of Puerto Rican Culture -(General Archives of Puerto Rico and the National Library of Puerto Rico) is seeking out to establish first contact with peer institutions that could offer any help after the catastrophic effects of hurricanes IRMA and MARIA in Puerto Rico.

On September 19, 2017 Hurricane Maria made landfall on Puerto Rico's east coast as a strong Category 4 hurricane. Maria charted a course directly over Puerto Rico, passing around 25 miles away from San Juan, the capital, which is home to around 400,000 people, bringing "catastrophic" 155 mph winds and knocking out power to the island's entire population of 3.5 million. No nation or territory could suffer such a direct hit without some damage. Rainfall from Hurricane Maria exceeded 38 inches during the two-day period of the storm.

Hurricane Maria caused extensive damage in all of the 78 municipalities of the Island of Puerto Rico. Severe flood damage to housing and other building was caused by the hurricane. In addition, coastal flooding was noted statewide. Damage in these areas occurred to buildings including housing, public facilities and infrastructure. Flooding damage fell into two categories: buildings inundated by floodwaters that caused much of the building and contents to be wet, but no structural damage; and buildings with severe structural damage, where the foundations were undermined by floodwaters.

Following a preliminary inspection of the Puerto Rico General Archive and National Library building and annex structures, disclose the following damages:

- Windows building wide were completely destroyed allowing wind and water to enter the structure;
- Water entered the building at both levels of the main structure of the Archive;
- **Lack of electricity throughout the island has left the Archive without A/C and the necessary controls of temperature and humidity**, creating an immediate adverse environment for all our record collections: including paper, film, video, audio recording and photographic mediums. Our collections date from the XVIII to the XXI centuries (Government documents from the executive, legislative and judiciary branches from three centuries, and private collections from the arts and cultural personalities and institutions of Puerto Rico and the greater Caribbean. **The estimate for power restoration is no less than 6 months.**
- This situation is going now into its second week under extreme conditions of tropical heat and humidity, **the presence of mold and mildew has already been detected.**
- The structural damage to our building, including the parking area, has **rendered useless our emergency (diesel) power plant.**

We are in need of technical assistance and/or resource that will help to mitigate the current and future damage to the documents that we store. We would rite any recommendations, expertise and help offered, but some of our more pressing and immediate needs include:

1. Lab preservation and restoration expertise and advise for all mediums mentioned;
2. Acid free materials for cleaning, protecting and restoring water-related damage;
3. Expertise for architectural Inspection of archival structures, including storage, vaults and main areas;
4. Masks and gloves
5. Advise and expertise for preparing a new and better set of guidelines and recommendations for dealing with future environmental threats. [more]

... and archives impact climate change.

An initial step:

National Digital Stewardship Alliance (NDSA) (USA)

- NDSA is a consortium of academic, cultural heritage, and affiliated organizations involved with digital preservation in the USA.
 - 2013 annual meeting: “Green Bytes: Sustainable Approaches to Digital Stewardship” plenary. (Josh Sternfeld, chair)
<http://www.digitalpreservation.gov/meetings/ndiipp13.html>
 - *2015 National Agenda for Digital Stewardship*: Section 5.3.2. Environmental Sustainability and Sustainability of Digital Collections
<http://www.digitalpreservation.gov/ndsadocuments/2015NationalAgenda.pdf>
 - Focuses on data centers and power use.
- >>> We need to think further.

What can archives do to mitigate their environmental impact AND improve their sustainability?

Staff actions

- Appraisal and retention policies
- Digitize at lower resolution formats
- Scheduling digital preservation processes

Technology choices

- Storage medium (spinning disks, digital tape)
- Decrease electricity use
- Consider storage medium recycling potential
- Power supply choices
- “Green” cloud and colocation vendors

Staff actions

- **Appraisal:** Preserve (digitize) fewer items
 - Not everything need be saved (impacts large archives more than small)
 - Apply appraisal and retention policies to born-digital content even before content is created.
 - Set policy for when to (responsibly) recycle dead media.
- **Digitize selected content at lower than optimal resolutions** to save storage space (and ongoing maintenance/energy use)
 - It's more important to save content at whatever format/resolution is feasible than wait to digitize at the highest level – and risk losing content in the meantime.

Staff actions

- **Digital preservation actions**

- Schedule fixity checks annually (depending on storage medium). This will use less power. There's no need for "constant" checks.
- Perform media-level fixity checks, verifying files only when the media check has an error. This will take less time (energy).
- Store redundant copies on data tape offline (not attached to a power source)
- Migrate to new media every two generations LTO (~ every 5-6 years) or more.
More files will be stored on the new generation tape (fewer media items).
- Recycle the old data tape through destruction (not re-use) for security, but also since the tape format will be obsolete and overly-used. Data tape has a maximum number of "reads." – Recycle the plastic cartridge and metal screws if possible.

Technology: Use less energy

Using less electricity helps the environment plus saves money.

1. Store large and infrequently accessed files offline on data tape.

Spinning disk takes 26x more energy than storing and infrequently accessing data tapes.

Technology: Use less energy

If you have a server room on-site:

2. Set the room temperature higher: no more than 27° C / 81° F.

Rooms with data tape:

15 – 32° C / 59 - 89° F (rate of change less than 5° C per hour)

20 – 80% RH (rate of change less than 5% per hour)

Thermal Guidelines for Data Processing Environments. 3rd ed. (2012)

Technology: Use less energy

3. Turn off unused servers.
4. Set servers to go to inactive mode when not in use.
5. Consolidate and virtualize several applications on one server.
 - This also results in fewer servers to replace/recycle.
6. Use the cloud for some applications (but verify the provider's "green" record).
7. Question your data/colocation center on its power source and "green" record.

Technology: Environmental planning

1. Purchase clean energy where possible, not coal-generated.
2. Purchase hardware that is energy efficient.
3. If recycle by re-use, use vendors who don't ship overseas.
4. Recycle data tape and hard drives with vendors who strip out parts and recycle components where possible. If media is shredded and incinerated, verify the incineration process.

Outreach and communication

Project ARCC <http://projectarcc.org/>

Founded by group of archivists on Earth Day 2015. A site to find resources, and learn about events and meetings.

Conclusion

Reports show there is already a decrease in carbon emissions in the last few years due to governments, corporations, companies, and individuals changing behaviors and taking positive actions.

In being mindful of its impact on the environment, an archive improves its own sustainability as well as the planet's.



Photo: NASA

Thank you.

Linda Tadic ltadic@digitalbedrock.com