



MOTHER
CYBORG



*CONTENTS~**

HEY DJ!! Let's Dance	7
HEY DJ!! The Record is Queen, RESPECT	13
HEY DJ!! Sometimes We Get High & Sometimes We Get Low	17
HEY DJ!! Get to Know Your Gear	23
HEY DJ!! Practice Can Be Fun	29

♥ This zine is a series of skills and knowledge designed for women identified humans to learn how to DJ. Each section combines personal reflection, technical knowledge, and creativity to guide one on the path of becoming their DJ self. Whether you are a pro and wanna teach someone or a beginner just getting starting, this little book has something for you. DJing as a creative medium is nearly 50 years old and women have been traditionally left out of the narrative.

This Zine was created in efforts to build community amongst women who have dreams and ambitions of being DJs and Producers. We come together over brunch because learning together with food and drinks makes for a fun, low pressure learning environment where we can both exchange knowledge while building relationships. We teach towards building relationships so we can support each other as we build our talents and skills. We travel in packs to deflect the doubt the world may have about our skills and talents. Together we are a learning network.



Use the *#HeyDJ* to start to shift that narrative. Along the way when you see a *#HeyDJ* question, give a shout out to *@seraphinecollective* and *@mothercyborg* to let us know what you're up to.

Seraphine Collective is an inclusive, supportive and active community of feminists fostering creative expression and camaraderie among marginalized musicians and artists in Detroit.



More info at seraphinecollective.org

Writer Diana J Nucera (aka Mother Cyborg)
Editor Rachel Thompson
Copy Editors Nandi Comer & Sophia Softky
Book Design Nikki Roach

Commissioned by the Seraphine Collective for Beatmatch Brunch Program 2017.

As a recipient of the 2016 Knight Arts Challenge, Seraphine plans to build feminist community and combat the underrepresentation of women in the Detroit electronic music scene. We provide affordable and accessible means for women-identified aspiring DJs to learn the foundations of record mixing on top-quality gear, in a supportive, low-pressure and collaborative environment.

This program was made possible by
The John S. and James L. Knight Foundation
The Awesome Foundation Detroit
The Open Meadows Foundation
Black Catalogue



JBoggie

Stacye J

DJ Heather

Lady D

Stacey

Juliana
Huxtable

Hotwaxx Hale

The Black
Madonna

J Lin

Jenny
La Femme

Erika

Mel Wonder

DJ LaJedi

DJ
Minx

Terri
WhoDat

IN HONOR OF ALL THE
WOMEN THAT PAVED THE
WAY. WE SALUTE YOU.

Magda

HEY DJ!!

tINI

Heidi

Josey Rebelle

Spinderella

Cassy

DJ Cent

DJ
Sprinkles

Ellen Alien

Tokimonsta

JJ FAB

Nettie Campbell

Jayda G

Anthology of
Booty Crew

Salomé

Super Jane
Crew

Nastia

Sylvester

Nina Kraviz

PreColumbian

Dinky

WRITE IN THE NAMES
OF WOMEN DJs THAT
INSPIRE YOU!

Hey DJ!!

Let's Dance

Have you ever thought about what moves people on the dance floor? How can a DJ save a life? Music is a fun mix of sciences, and in this session we want to learn how to identify sounds and think about how they correlate with the body. This will help the DJ with listening and creativity in creating smooth transitions. Remember Cyborgs: there are more than mechanics at work on a dance floor. There is life and all of the complicated things that come with it. If we understand how music makes people move we can respectfully craft a dance floor that is meaningful and unique, adding to the life that is at play on the dance floor. First we begin by listening, moving our body with the beats, and thinking about how we are moving as well as what is making us move.

Skills you'll hopefully walk away with 😊

- Articulate what a BPM is in one sentence.
- Identify the BPM of a song
- Beat match two records together using BPMs as your guide

Knowledge gained along the way 😊

- Identifying highs, lows, mids and the different instruments that live in each range
- The 4/4 musical space/time structure
- Understanding that genres have their own BPM range
- Understanding how BPMs can be divisible
- Understanding that DJ's shape a *flow* or sequence of music that takes listeners and dancers on a journey

But before we begin, let's get to know each other!

#HeyDJ What is a memory of music you have that had a major impact on who you are today?

If you're up for it use the **#HeyDJ** to share your story with the internet.

Ok first things first... let's get to know BPMs, Downbeats, and Upbeats. The BPM is the tempo or speed of a piece of music. Tempo is usually measured in by beats per minute (BPM).

DOWN BEAT

is the first beat of the bar

UP BEAT

is the last beat in the previous bar which immediately precedes, and hence anticipates, the downbeat

BPM = BEATS PER MINUTE

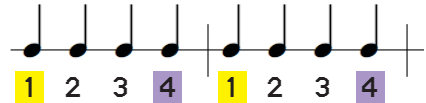

Take a moment to listen to some music and see if you can identify when different sounds hit the down beat (1 and 3's) or the upbeat (2's and 4's). While you're listening ask yourself a few questions:

WHAT ABOUT THE TRACK IS MAKING YOU MOVE?

WHAT PART OF YOUR BODY IS MOVING?

SOME CYBORG KNOWLEDGE ❤️🧑🏻❤️

I've noticed that with music that hits on the down beat (like hip hop or house music) my head bobs down, and with music that hits on the upbeat (like reggaeton and cumbia) my chest and hips pop up. When you are DJing you will want to think about this when choosing your tracks so you don't jerk people around. Also when mixing records together you can beat match with different sounds as long as they hit on the same beat. This is helpful for DJs that play more melodic records. You can get really creative once you get the hang of identifying sounds and their patterns.

BPM's and Genres Each genre lives in a BPM or tempo range. The genre is also shaped by how the musical instruments are arranged. Below is a list of western and european musical genres that mostly make up popular music in the @mother-cyborg world. There are many many more music styles that are not included in this list. Keep in though, that whatever the musical genre, it will have a BPM range! The best way to understand it is to begin by listening.

Cumbia	60–80	Trap	140
Hip Hop	80–115	Jit/Juke/Footwork	160
Triphop / Downtempo	90–110	Drum and Bass	160–180
Salsa	120–140	Merengue	180–200
House	118–135		
Techno	120–160		
Dubstep	70–75*		

*70-75 BPM is equivalent to 140-150 BPM

Here is where things get fun. When a BPM gets in the 120s you can divide in half and still match a song that carries half the beat. Essentially, they are the same time, but one has more notes or instruments filling the song space. So 120 is also 60, or 60 is also 120. And 140 is 70, or 70 is 140! It is music space-time continuum madness!

What is so cool about this is you can really play with time when creating a flow. If you want to move from techno to cumbia, you can! You can get really creative with remixing old songs with new songs or doing mashups that blow minds. You just gotta do the math. Once you know the BPM you are not confined to genre. As long as you can match the beat... you can move some feet.

Why do we start at 60 and end at 200? Well... there is a point in which the human brain can not catch the beat. If its too slow or to fast, the brain won't register what is going on and it sounds like chaos. I'm not saying it is not possible, but you gotta have a good ear to make it work.

#HeyDJ What kind of music do you listen to?
What BPM range does it fit in?



HOW TO IDENTIFY BPM

Feel it Out Listen to the song and pay close attention to the beat. The easiest way to do this is to close your eyes, relax, and feel the pulse of the song.

Tap your foot or your fingers or nod your head to this pulse. If you have trouble with this, try to isolate the sound that is making you bob your head or tap your feet. Try first with the instrumental version of the song if it's available.

Do Some Math Use a stop watch or look at a clock with a second hand. When you're sure you've got the rhythm of the song happening, count those beats—your head nods, foot taps, or fingers snaps—for 15 seconds. Take the number of beats you counted, and multiply by 4 to get the number of beats in a whole minute.

For example, if you counted 24 beats in 15 seconds, multiply 24 by 4 = 96. The song's tempo is 96 BPM.

You multiply by four, because 60 seconds divided by 15 seconds = 4. To increase accuracy, count beats for longer periods of time and calculate the rate accordingly.

Using the same song as in the previous example, if you counted for 30 seconds instead, you might have counted 50 beats instead of 48, which means the tempo is just a little faster: $50 \times 2 = 100$. (Multiply by two because 60 seconds divided by 30 seconds = 2.)

HOW TO ADJUST BPM

Once you know the BPM of your record, you have the option of speeding it up or slowing it down by 8 Beats per minute.

You'll see on the right hand side of the record player, and most other devices, there is a bar that you can move up and down. You use that to adjust the speed of your song. You can match records that are up to 8 BPMS apart up or down.

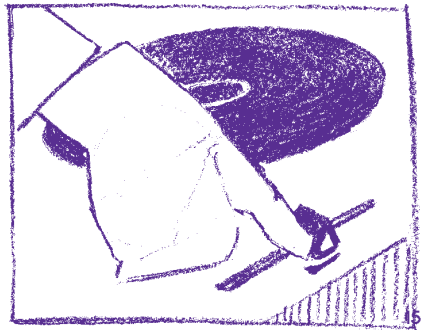

Now Let's Dance Go to <https://tinyurl.com/y98mpp9d> to listen through Mother Cyborg's BPM mix tape. Here you'll find a lot of Detroit Centric music that climbs the BPM ladder. Some start on the downbeat, some start on the upbeat. Listen with friends and see if you can feel how each BPM moves your body, as well as identify how BPMs influence genres.

	SONG TITLE	BPM
1		
2		
3		
4		
5		
6		
7		
8		
9		
10		
11		
12		
13		
14		
15		

When you're listening to the music, don't forget to ask yourself:

WHAT SOUNDS
ARE MOVING YOU?



WHAT DO YOU NOTICE
YOUR BODY DOING?



WHERE DO THOSE
SOUNDS HIT?
ON THE UPBEAT OR
DOWNBEAT?



Hey DJ!!

the Record is Queen, Respect

DJ, the world is yours and you can DJ with any equipment you'd like. There is no right or wrong method to rock a dance floor, just as long as you rock it is what counts. To get there let us start with records. Once you get the hang of a beat matching records you can beat match just about anything anywhere on any device. You see with records you have to use all your senses. Sometimes computer programs can do the work for us and we miss the opportunity to enhance our human parts. Getting to know beat matching with records will help you exercise your ear and find the rhythm inside of you. Plus you'll get hella street cred and appease the DJ goddesses.

In this section, we are going to learn the anatomy of a record. How to read it, hold it, and isolate sounds so you can manipulate the music. The combination of isolating sounds and identifying BPMs will have you on your way to #DJlife in no time.

Skills you'll hopefully walk away with 😊

- Isolate the bass drum of a song on a record player
- Isolate the high hats of a song on a record player
- Handle a record safely without scratching it
- Identify individual songs and their structures on records
- Your DJ name!

Knowledge gained along the way 😊

- Identifying highs, lows, mids and how to isolate them using a record mixer
- How to read record grooves
- How to properly handle a record and why that is important
- Understanding how isolating sounds and identifying BPM's lead to Beat matching
- Understanding why a DJ name you love is important

But before we begin, let's get to know each other!

#HeyDJ What is the first record you ever bought that had you screaming YESSSS when you found it?

GETTING TO KNOW YOUR RECORD

First find your favorite record in the pile. We're gonna pull it out and take a good look at the grooves to see if we can identify what is happening in a song. When you are pulling out your record remember to not touch the grooves. Your fingers are greasy and you will plug up those grooves if you touch it too much. If the grooves are clogged, the record will skip.

HERE IS HOW
YOU SHOULD
(AND SHOULD NOT)
HANDLE THE
RECORD

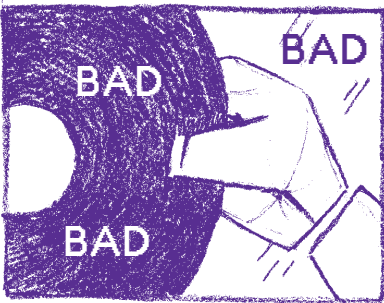

Now take good look at your record. Notice the grooves and the spacing in between them. Do you see it changing throughout the record? Somehow, humans figured out how to store sound in vinyl! You can tell how much they love music because it's quite brilliant.

See if you can visually identify where the vocals of the track or the chorus comes in.

#HeyDJ Which record did you choose for this part?



Now We're Groovin! The closer together grooves mean there are more complex sounds happening. That could mean there are multiple instruments at once for a chorus or an instrumental breakdown.

The farther apart the grooves are the less happening in them. These are “breaks” in a song, or gaps between songs. You can see where a song starts by the size of the gaps.

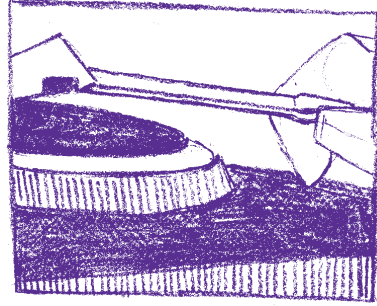
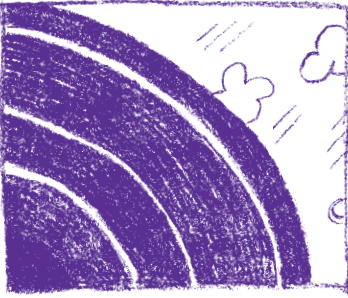

This knowledge will help you tell time, let you know where the song you want is, and give you cues on the best place in the song to mix in another record.

Now Let's Rock! Grab your record and put it on the player. Let's test our theory and see if we were able to read the record grooves. Carefully handle the record and place it on your record player. Make sure it is not spinning just yet!

Once you've got your record on the player, carefully grab the little handle near the needle.

Make sure your arm is away from the record.

Carefully set the needle on the grooves of the record and let her spinn.

See if you can place the needle at the start of a song.

#HeyDJ What song did you choose?



CUEING AND REWINDING

Now let's talk about handling the record while it is spinning on the record player, cueing and rewinding. Use your middle finger on your dominant hand and place it on the record label. Your finger can control the record from there. You can stop, speed up, or rewind your record. You can also use the side of the turntable or record to move it around.

Feel it out so to get a sense of how much pressure you need to apply. Play around with this for a little bit, it can be a little awkward at first.

Once you get the hang of moving the record around while it is spinning let's plug in the headphones and see if we can cue this record up. Use your new found skills to cue up your song.

HERE IS WHERE YOUR MIDDLE FINGER IS YOUR BEST FRIEND :)

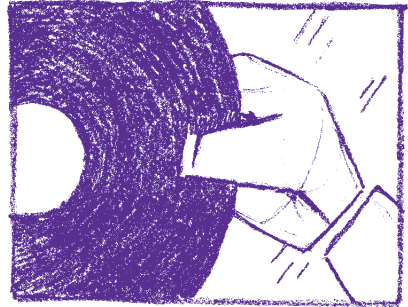

- 1 Put the needle as close as you can to the beginning of the song.
- 2 Use your middle finger to guide the record to the exact beginning of the song.
- 3 Listen deep, move the record along until you hear the very first sound of the record.
- 4 Move the record back and forth once you find that sound.

Slightly passing, then rewinding it ... like you are scratching!

- 5 Once you feel like you have control over the record cue it up and let it go.
- 6 Happily dance to your song. You are almost there DJ!

Try it out! See if you can get a clean start exactly when the music starts. If you get a funny windy sound, you need to back it up a little. If you let go and there is a pause before the song starts, move a little closer to the first sound. Keep cueing up the same song over and over until you get the hang of it. It seems simple, but quickly cueing up your track is a fundamental part of DJing.

Hey DJ!! Sometimes we Get High and Sometimes we Get Low

You can use all kinds of sounds to beatmatch. The kick drum or a bass line are commonly used. There are also high hats, claps, snare drums and shakers you can sync up. Playing with the high and low sound frequency, or EQ knobs on your mixer, you will be able to isolate sounds and make smooth transitions. In this section we are going to learn how to isolate vocals, bass drums, and symbols using all the knobs on your mixer to manipulate songs and start beatmatching records.

Skills you'll hopefully walk away with 😊

- Articulating what EQ means in a few sentences.
- EQing a song on a DJ mixer
- Matching two records with bass sounds.
- Isolating vocals on a record

Knowledge gained along the way 😊

- Mixing techniques
- What various instruments live with in high, mid, and low ranges.
- Understand what all the knobs on the mixer do

Now put the timer on for 5 mins.

Your task is to read through your notes and underline all of the descriptive sentences that really get to the heart of what you are thinking. Look for the poetic and descriptive sentences. This will be our inspiration for a poem in the future.

Now the fun begins. Set the Timer for 20 mins.

Your task is to write a HAIKU about your name. Start by writing the name that feels like the one at the top. Then let the poetry flow. Use your free write to guide you. Have fun with it! Don't worry you don't have to make a final decision now, but hopefully this will help you think through who you are and how you want to rock in this world.

A Haiku is a three-line poem with a total of seventeen syllables, written in a 5/7/5 syllable count. Often focusing on images from nature, haiku emphasizes simplicity, intensity, and directness of expression.

HEY DJ!! GURRL
YOU INSPIRE ME TONS!
HOUSE OF CYBORG WHAAAT!



MOTHER CYBORG HERE
TEACHING THE WAYS OF THE WAX
ROCK THAT PARTY, GURRL!



DJING GIVES LIFE
LET THEM DANCE THEIR PAIN AWAY
MAKE ROOM FOR MORE LIFE



#HeyDJ Don't be shy, share your new self with the internet!

Your Chosen Name

5 syllables

7 syllables

5 syllables

Got another one in you? Go for IT!
This time try to describe the dance floor you want to create.

My Dance Floor is (choose one descriptive word)

5 syllables

7 syllables

5 syllables

Nice work Cyborg! It is good to keep the creative juices flowing.
They help bring meaning to your craft.

Now let's get back on the tables and start working your ear by isolating sounds. First here is some body science for you.

CHECK IT OUT, HERE IS HOW SOUND TRAVELS THROUGH THE EAR

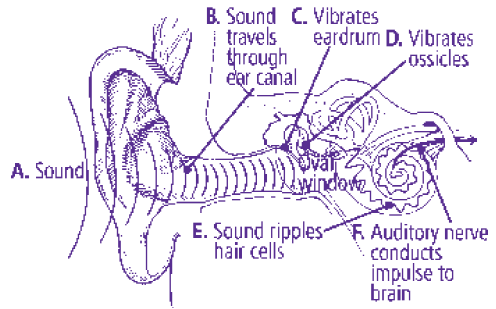

Learning how to isolate sounds will give you more control over your transitions. You can also use this skill to make remixes on the spot. You do this by using the EQ functions of the mixer.

EQ is short for equalization which is the process of altering the frequency of an audio system using linear filters. Most hi-fi equipment uses relatively simple filters, labeled Highs, Mids, or Lows to make the audio adjustable.

Highs Higher sounds like high hats, symbols, and claps. Isolate by turning the lows and mids down and turning up the highs.

Mids Instruments like vocals, pianos, snares and horns live in the mid-range. If we want to isolate them we simply turn the mids up and the highs and bass down.

Lows Instruments like the kick drum and bass lines live in the lows and we can isolate them by turning the lows up and the highs and mids down.

Playing with the frequencies or sound ranges can offer a arsenal of mixing tricks. Lots of DJs take out the bass of the track they are playing and introduce the track they want to mix in by using its bass line or kick drum to take over the track. Others might mix in vocals or a piano adding to the track they are already playing. Playing with the highs, mids, and lows are more tools to be creative with.

EQing also helps with making old records or bad recordings sound much better. Mixing is a key element of DJing, but you also want to make sure everything sounds good! You can totally do too much here. So play around and listen deep, feel your ear out and go rock out. Now you try it!

- 1 Cue up another song
- 2 Move the knob that says highs all the way to 0
- 3 Move the knob that says mids all the way to 0
- 4 Can you hear the bass?
- 5 See if you can match the bass on two records

Keep playing around with the knobs and listen to how the music changes. See if you can isolate these sounds:

- Vocals
- High hats
- Piano
- Bass line
- A guitar or stringed instrument

The more you mess with the knobs the more you will know what they do. Take a whole hour to do this. Seriously. Reach towards the goal of putting one record's vocals on another record's instrumentals. Remember count the BPMs and adjust the record accordingly. **You got this DJ!**

#HeyDJ What two songs did you mashup?



Vocals _____

Instrumentals _____

Hey DJ!!

Get to Know Your Gear

There is a lot of gear out there and it can be intimidating at times. The good thing is they all have a similar design and basic parts. Once you get to know one mixer you can figure out others fairly quickly. Just like everything else in DJing, the more you play around the more you will know. In this section we are going to break down the different components of the mixer, how to set it up and how to troubleshoot things if they are not working. Expect technical difficulties when you are first starting out. Just don't let them slow you down. Each problem leads to a set of skills you can use in the future.

Generally the idea is that you plug each turntable into a channel of the mixer. Then the mixer will either go straight into speakers or go into an amplifier that is connected to speakers. **Powered speakers do not need an amplifier but others do.**

THE SETUP

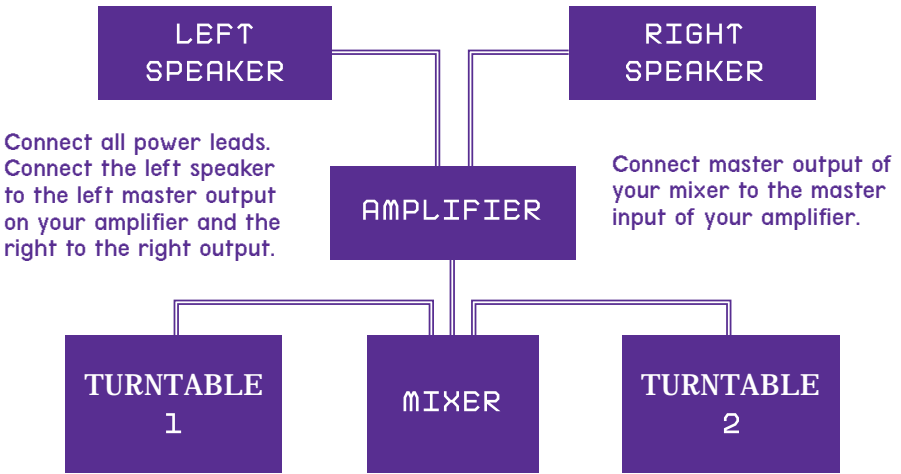

Connect the RCA wires from your turntables to the dedicated RCA points on your mixer. Plug Turntable 1 into the phono input of channel 1 of your mixer. Plug Turntable 2 into the phono input of channel 2 of your mixer.

THE GEAR

We will be using a Pioneer DJM800 mixer and a set of two Technique turntables as examples throughout this section. If you have different gear, don't worry the concepts are still the same.

Let's start with the inputs of the mixer. Move to the back of the mixer and see if you can identify the different inputs.



On this mixer there are 4 channels. Each channel has two inputs. One for PHONO and one for CD or line. **ALWAYS** plug your record players into the phono and your CD's or MP3 players in Line. If you forget and plug your CDJs into the PHONO input, you can blow out the line.



The Red and the white plugs are called **RCA inputs**.



The ones with the three prongs are **XLR inputs**



The big holes are **1/4 inch inputs**.

Your DJ gear will generally be RCA, while the speakers or AMP will go through the XLR input. You may notice there is a funny looking prong hanging out of your record player.



SIGNAL GND

That is the **ground**.

The ground keeps the record player from buzzing. You see it has a different input because it uses a different amount of electricity. When you plug it into something that uses more electricity it will start humming. When you hear that sound you are hearing electricity buzzing around your gear.

Make sure to connect the ground to the knob in the back of your mixer then twist it tight to keep the grounds in place.

Use the diagram below to help you get your system set up.

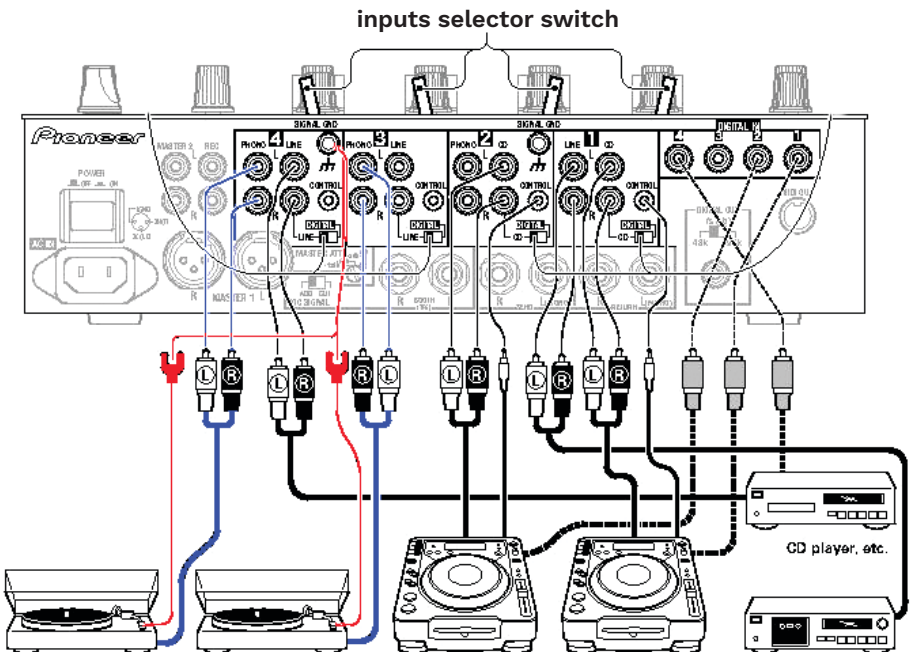

THE MIXER

Each channel has a set of knobs and a fader. When you move them you only manipulate the sound that is connected to that channel. **the Fader *E** up brings up the volume for that track. When it is down you will not be able to hear it.

There is also a **Master *A** out that has its own volume controls. Those are the controls for the loudness of the speakers. You may also have a separate volume control for **the Booth *D**. The booth is your monitors, or personal speakers. These speakers will help you hear what you sound like.

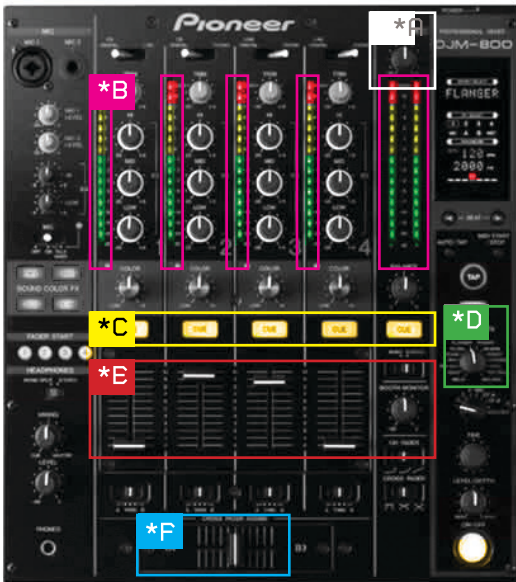

Notice there is a larger fader on the bottom, **the Crossfader *F**, and it moves between channels. If you have channel one connected to your left turntable, the left side of the cross fader will play only channel one. It is the same for the other side. If the fader is in the middle, it will play both tracks at once.

Notice **the Cue Button *C** too. You use that button to hear the channels in your headphones.

There should be a separate volume for that as well. You will use the cue to help hear music that is in a track that is muted to the audience. Only you can hear what is in the cue.

The VU Meters *B are those colored lights that move up and down. VU meters were originally designed for the analog world to visualize the average volume of a signal. So basically it tells you how loud you are. You DO NOT want to be in the red. Stay in the Yellow if you can. Red means you are TOO LOUD and may hurt your speakers.

Time to Mix It Up. Ok DJ now it is time to use your gear. Lets try to mix some records!

- 1 Start with what you know about BPMs and find two records that have songs that are no more than 8 BPMs apart. Make sure you know where each song is on the record so you have more time play with mixing than searching for your song. Once you get your song going, you want to keep an eye on your individual track levels as well as the master level. Not all tracks were created equal, so you might have to adjust your gain, volume or EQ controls for each new track to keep it at a similar level as the currently playing track.
- 2 Make sure the volume is up on the channel that has your first track playing and the crossfader is all the way to the side where your track is playing.
- 3 Now go to the channel where your other turntable is and push the cue button. Get your headphones on and start looking for the track you want to mix into the song playing.
- 4 Use your middle finger to help move the record and look for the kick drum of the track. Isolate that sound to where you are able to rock back and forth, manually playing the sound by moving the record back and forth. Like you are scratching
- 5 Now push the cue button on the 1st track and make sure your cue volume is where you can hear both tracks at once. Keep rocking back and forth trying to beatmatch the kick drum of each record. Once you have it match. On the beat count 1... 2... 3... 4 and then let go!
- 6 Listen! Do you need to adjust the BPM? If one track sounds faster or registers as a higher BPM, use the bar on the side of your record player to adjust speeds. Once you have your speeds synced, listen to hear if your records are beatmatched. You can always manually rewind your record, isolate the sound you newed and try again.
- 7 When you feel confident that they are matched. Remove your headphones and move the crossfader to the middle of the track. Keep it there for a sec, to check your work... then slowly move it to the opposite side.
- 8 BOOM you just mixed your first record. Its ok if sounded like crap! The point is you tried. So keep trying till you get it.

MIXING TECHNIQUES

The easiest mixer action to take is a simple slow transition with the crossfader. Assuming that your tracks are at balanced levels, slowly moving the crossfader from one side to the other should fade out the old song while simultaneously fading in the new song at a constant rate. You can accomplish this same transition with the volume faders by having the crossfader in the center and then slowly bringing the volume fader of the current track down at the same rate that you bring the volume fader of the new track up.

Another way to use the crossfader is by doing a ***Hard Cut.*** Start with both volume faders up and the crossfader to one side, but instead of slowly moving it to the other side you very quickly push it across. This will instantly cause the songs to switch, so be sure that they are beatmatched and are at a point in the song that makes sense to do this.

One of the most effective ways to transition between songs is by using your EQ controls. This takes a bit more practice than simply moving the crossfader, but if done properly will result in extremely smooth mixes. The basic idea behind this type of mixing is to keep the overall levels the same by swapping out different instruments. For example, instead of bringing the volumes up and down to transition, you might want to bring the low EQ up on the track you want to mix in and down on the track you are mixing out of. This will gradually swap out parts of the song but keeps other parts still audible. You could continue this with the mid and high EQ controls until the full transition has been achieved. What EQ to use and how much of it depends completely on the tracks that you are using and they type of vibe you are going for.

Know When to Hold Them ~ Know When to Fold Them Most dance music is broken into fairly distinct phrases of 8, 16, or 32 bars. A good place to start when learning to mix is by matching up these sections in both songs. For example, if you have a 32-bar verse in the middle of each song, try to get them to start at the same time. You can then transition however you want and the song structures will still line up. This can be applied to any part of the songs such as the intro/outro, chorus, build, bridge, etc.

These techniques take practice and you'll want to use your ears as much as possible. The crowd can't see what you're doing, so if it sounds good to you it probably sounds good to them. The best way to get good is to practice a bit of everything until it sounds the way you want it to.

Hey DJ!!

Practicing Can Be Fun

DJ, you now have the knowledge and skills to rock thy party! The only thing left to do is build your collection and practice with your DJ learning community. In this section you'll find a series of practice exercises that you can do by yourself or with others. The key to a successful practice is leaving room for error. Try not to get frustrated or too nervous when you're practicing with others. When the doubt kicks in all your senses go down and the worst happens. Try not to doubt yourself DJ! Hold your head up high and know that every time you get on those decks you are giving another music goddess her wings.

It takes time so be patient with yourself, but most importantly have fun and enjoy the music!

Skills you'll hopefully walk away with 😊

- Cataloging record BPMs
- Fine tune beat matching
- Building a 60min DJ set
- Round Robin and tag-team DJing

Knowledge gained along the way 😊

- Facilitation strategies to practice with individuals or groups
- How to build a learning community
- Techniques for keeping the faith when things get rough

Knowing the BPMs of your records are going to save you a ton of time being frustrated because something is just not working. Set yourself up for success and choose 15 records to practice with. Be sure you like these songs because you are going to hear them a bunch! What you want to look for are songs that kinda sound similar or have similar instruments. Make sure the songs are within a 20 BPM range.

A 20 BPM range would be something like 120–140 or 100–120.* Remember you can divide fast songs in half and mix them with lower bpm songs.*

Take a moment to listen deep and find those records. Use the BPM chart to help you keep track of what you have. This will be a little tedious, but grab some friends, and start listening to records. Practice can be fun.

SONG TITLE	BPM
1	
2	
3	
4	
5	
6	
7	
8	
9	
10	
11	
12	
13	
14	
15	

Find 15 songs that you can put in your practice catalogue. Use the chart to keep track of Song BPMs and various instruments that you can use in transitions or creative elements of your set.

PRACTICING ALONE

Your first step in preparing for a practice is grabbing two records that have a similar BPM and lead instruments. Use these two records to try to master the basics. You may get sick of these records from listening to them over and over, but one of the key elements to mixing is knowing your music well. Below are a list of thing you can try to master. Once you get through this list you can move on from your two records.

*Remember try not to get down if it takes you a minute to get the hang of it. Keep working on your ear!

Beat match records and have them play for one minute together.



Notes to self:

Swap bass when transitioning between records.

Notes to self:

#HeyDJ What was your first mix?



Swap high hats when transitioning between records.

Notes to self:



Seamlessly go back and forth between your two records three times in a row.

Notes to self:



Grab Two More Records For A Total of 4!

Mix the four records seamlessly.

Notes to self:



Switch up your records and see if you can still seamlessly mix them.



Notes to self:





Now you are ready for the ultimate challenge! Start by making a playlist of 10 songs.

	SONG TITLE	BPM
1		
2		
3		
4		
5		
6		
7		
8		
9		
10		

Your task is to mix all of these records together to make your first set! Shoot for composing a 20-30min set. If you are able to, record it. Listening to your mixes will help you identify what needs improvement and techniques that are working.

Notes to self:

#HeyDJ What song did you start your set with?

PRACTICING WITH OTHERS

Practicing with friends can sometimes speed up the process. Exchanging tricks is the best part of practicing with friends. People learn at different paces and in lots of different ways. A learning community is also a great way to lose your stage fright. Playing in front of a crowd can feel real stressful! So gather your DJ friends and try some of these practicing techniques below.

ROUND ROBIN

- 1 **First thing you want to do is have everyone grab a record.**
- 2 **Identify the BPM of your record then lineup in numerical order. This is an important step to take for newbies. If you line yourself up you won't struggle as much in the next part.**
- 3 **The first person plays the first two records so they have a chance to mix.**
- 4 **Everyone after the first person will then try to mix their record in to the person before them's record.**
- 5 **Once you have gone through everyone, try going in reverse order.**

This works great for larger groups of 4-8. The purpose of this practice strategy is to build your mixing skills with unknown records.

This method of collaborative mixing will help you develop a range for mixing. It is easy to get stuck in the same music genre when starting out. Some genres are easier to beatmatch than others. Because you don't know the record before you, you will need to use many of your new learned skills to make it work. The fun part of this practice strategy is that there are so many unique mixes that can happen.

Your ear may be surprised by what you hear!