

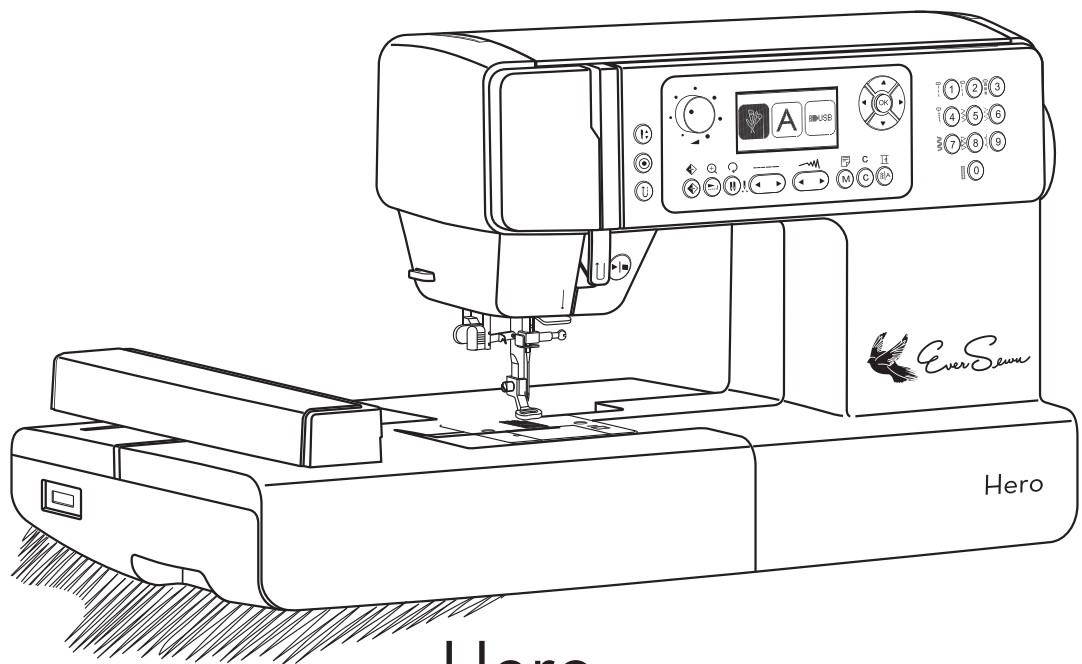

## Instructional Manual



Hero  
sewing/embroidery machine





## Important safety instructions

### IMPORTANT

When using an electrical machine, basic safety precautions should always be followed, including the following:

Please read the instruction manual carefully before using this machine.

Keep the instruction manual at a suitable place with the machine and hand it over if you give the machine to a third party.

**When the machine is not in use or left unattended, always disconnect the machine from the power supply system. Unplug it from the outlet.**

### DANGER!

To reduce the risk of electric shock:

1. Never leave the machine unattended when it is plugged in.
2. Always unplug this machine from the electric outlet immediately after using and before cleaning.
3. LED RADIATION: Do not view directly with optical instruments Class.

### WARNING!

To reduce the risk of burns, fire, electric shock or injury to persons:

1. The machine mustn't be used by children under 8 or by people with reduced physical, sensory or mental capabilities or if there is a lack of experience and knowledge how to operate the machine. Unless they have been given instruction concerning the use of the machine and the involved risks by a person who is responsible for their safety.
2. Do not use this machine as a toy. Close attention is necessary when this machine is used by children, near children or people with reduced sensation.
3. Use this machine only for its intended use as described in this manual. Use only accessories recommended by the manufacturer.
4. Children should be supervised to ensure that they do not play with the machine.
5. Never operate this machine if it has a damaged cord or plug, if it is not working properly, if it has been dropped or damaged, or dropped into water. Return the machine to the nearest authorized dealer or service centre for examination, repair, electrical or mechanical adjustment.
6. Never operate the machine with any air openings blocked. Keep ventilation openings of the machine and the foot control free from accumulation of lint, dust, and loose cloth.
7. Keep fingers away from all moving parts. Special care is required around the machine needle.
8. Always use the proper stitch plate. The wrong plate can cause needle breakage.
9. Do not use bent needles.

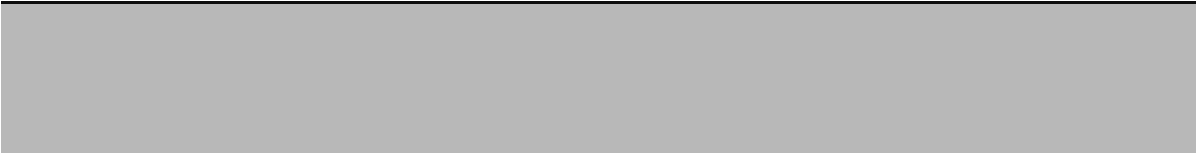
- 
10. Do not pull or push the fabric while sewing. This can result in needle breakage.
  11. Switch the machine off ("O") when making any adjustments in the needle area, such as threading or changing the needle, threading the bobbin, or changing the presser foot, and the like.
  12. Always unplug the machine when performing cleaning or maintenance work such as replacing the sewing light or when making any other user maintenance adjustments mentioned in the instruction manual (disconnect the power plug). Cleaning and maintenance work must not be carried out by children without supervision.
  13. Never drop or insert any object into any openings.
  14. Use this machine only in dry and protected areas. Never operate the machine in a damp or wet environment.
  15. Do not operate the machine where aerosol spray products are being used or where oxygen is being administered.
  16. To disconnect, turn the power switch to ("O")(off), then remove the plug from the outlet. Do not unplug by pulling the cord, instead grasp the plug to pull it from the outlet.
  17. If the supply cord of the foot control is damaged, it must be replaced by the manufacturer or an appropriate service agent or a similar qualified person in order to avoid endangerment.
  18. Never place anything on the foot control.
  19. When replacing the light bulb, always use the same type.
  20. The machine may only be used in combination with a foot control of the type C-9000.
  21. The sound pressure level during normal operation is lower than 75dB(A).
  22. This machine is provided with double insulation (except U.S.A/Canada). Use only identical replacement parts. See instructions for Servicing of double-insulated products.

## SERVICING OF DOUBLEINSULATED PRODUCTS

In a double-insulated product, two systems of insulation are provided instead of grounding. No grounding means is provided on a double-insulated product nor should a means for grounding be added to the product. Servicing a doubleinsulated product requires extreme care and knowledge of the system and should only be done by qualified service personnel. Replacement parts for a double-insulated product must be identical to those parts in the product. A double insulated product is marked with the words "DOUBLE INSULATION" or "DOUBLE INSULATED".

The symbol  may also be marked on the product.

# SAVE THESE INSTRUCTIONS!

## **Attention!**

- This machine is intended for household use only. If used intensively or commercially, regular cleaning and especially attentive care is required.
  - Signs of wear and tear owing to intensive or commercial use are not covered automatically, even if they occur within the warranty period. The decision on how to deal with any such cases rests with the local authorised servicing staff.
- 

## **Note:**

If the machine is stored in a cold room, it should be brought to a warm room about one hour before use.

---

## **All rights reserved**

For technical and product improvement reasons, the machine's features, parts and accessory are subject to unannounced changes and alterations at any time. The accessory included can differ from country to country.



## **Environmental protection**

Ever Sewn is committed to the protection of the environment. We strive to minimize the environmental impact of our products by continuously improving product Design and our technology of manufacturing. Do not dispose of electrical machines as unsorted municipal waste, use separate collection facilities. Contact your local government for information regarding the collection systems available.

If electrical machines are disposed of in landfills or dumps, hazardous substances can leak into the groundwater and get into the food chain, damaging your health and well-being.

When replacing old machines with new ones, the retailer is legally obligated to take back your old machine for professional disposal free of charge.



# Contents

## GETTING READY TO SEW

Principal parts of the machine .....	6
Accessories .....	7
Connecting the machine .....	8
Winding the bobbin .....	9-10
Inserting the bobbin .....	11
Threading the upper thread .....	12-13
Using the needle threader .....	14
Using the net .....	15
Adjusting presser foot pressure .....	16
Replacing the needle .....	16
Matching needle/ fabric/ thread .....	17
Changing the presser foot .....	18
Type of presser foot chart .....	19
Two-step presser foot lifter .....	20
To raise or drop the feed dogs .....	20
Information on the LCD Display .....	21-24
Normal mode .....	21
Memory mode .....	22
Embroidery mode .....	23
Buttons of the machine .....	25
Operation buttons .....	26-27
Function buttons .....	28-31

## SEWING BASICS

Pattern chart .....	32-33
Thread tension .....	34
Useful skills .....	35-36
Reverse .....	35
Free arm .....	35
Sewing corners .....	35
Cutting the thread .....	36
Sewing on the heavy fabric .....	36
Selecting stitch .....	37-38
Straight stitches and needle position .....	39
Zigzag stitches .....	39
Stretch stitch .....	40
Overcasting stitches .....	41
Using the overcasting foot .....	41
Using the all purpose foot .....	41

## ORDINARY SEWING

Blind hem/ lingerie stitch.....	42
Buttonhole stitch.....	43-46
Making a buttonhole on stretch fabrics.....	46
Bar tack stitch.....	47
Eyelet Stitch.....	48
Button sewing.....	49
Darning stitch.....	50-51
Zipper insertion.....	52-53
inserting a centered zipper.....	52
Inserting a side zipper.....	53
Narrow hemming.....	54
Cording.....	55
Single cording.....	55
Triple cording.....	55
Satin stitch sewing.....	56
Gathering.....	57
Smocking.....	58
Free motion darning, embroidery and monogramming.....	59-60
Darning.....	59
Embroidery.....	60
Monogramming.....	60
Quilting.....	61-62
Attaching the edge/ quilting guide.....	61
Joining the pieces of the fabric.....	61
Patchwork stitching.....	62
Fagoting.....	62
Patchwork stich.....	62
Scallop stitch.....	63
Scallop hem.....	63
Scallop edging.....	63
Walking foot.....	64
Mirror.....	65
Elongation.....	66
Using the twin needle.....	67-68
Memory.....	69-73
Combining patterns.....	69
Editing patterns.....	71
Clearing patterns.....	72
Adding patterns.....	72
Recalling and sewing the memorized pattern.....	73



## EMBROIDERY

Important Embroidery information .....	74
Embroidery threads .....	74
Lower threads .....	74
Stabilizer .....	75
Adhesive Spray.....	75
Iron-on interfacing.....	76
Attaching the embroidery foot.....	77
Embroidery unit overview .....	78-80
Connecting the embroidery unit.....	79
Removing the embroidery unit.....	80
Embroidery hoop overview .....	81-84
Attaching a stabilizer to the fabric.....	81
Hopping the fabric.....	82
Using embroidery sheet.....	83
Attaching the embroidery hoop.....	84
Removing the embroidery hoop.....	84
Embroidery design types .....	85
Built-in embroidery pattern .....	86
Built-in embroidery letter .....	87-88
Designs from USB .....	89-91
Starting to sew embroidery.....	92-93
Editing the embroidery design .....	94-98
Basic setting .....	94
Advanced setting .....	97
Load a Design after interruption .....	99-100

## APPENDIX

Warning functions.....	101-105
Warning message.....	101
Warning sound.....	105
Buzzer sound.....	106
Maintenance.....	107-108
Cleaning the screen.....	107
Cleaning the sewing machine surface .....	107
Cleaning the hook.....	107
Trouble shooting guide.....	109-111



# Principal parts of the machine

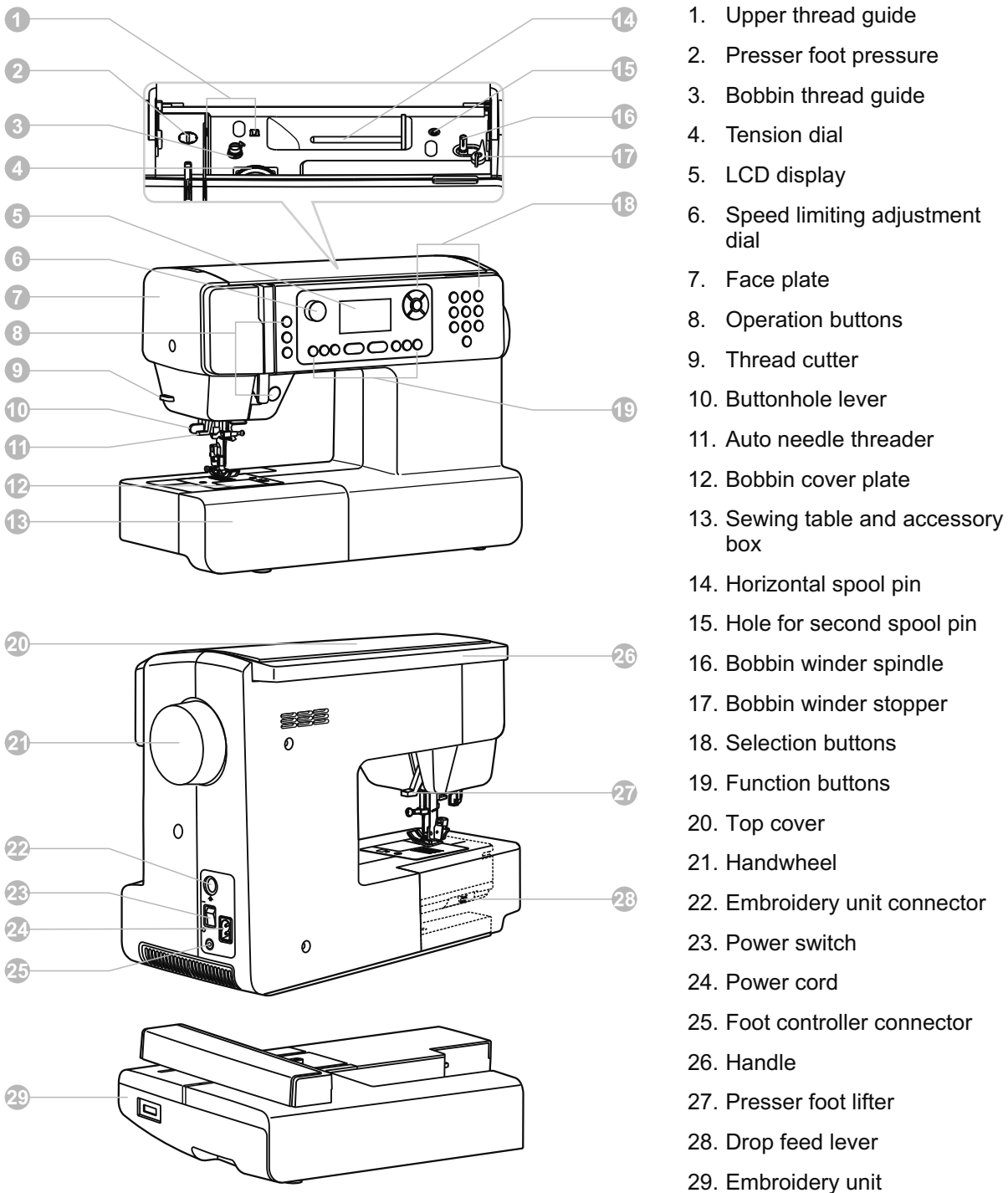

1. Upper thread guide
2. Presser foot pressure
3. Bobbin thread guide
4. Tension dial
5. LCD display
6. Speed limiting adjustment dial
7. Face plate
8. Operation buttons
9. Thread cutter
10. Buttonhole lever
11. Auto needle threader
12. Bobbin cover plate
13. Sewing table and accessory box
14. Horizontal spool pin
15. Hole for second spool pin
16. Bobbin winder spindle
17. Bobbin winder stopper
18. Selection buttons
19. Function buttons
20. Top cover
21. Handwheel
22. Embroidery unit connector
23. Power switch
24. Power cord
25. Foot controller connector
26. Handle
27. Presser foot lifter
28. Drop feed lever
29. Embroidery unit



# Accessories

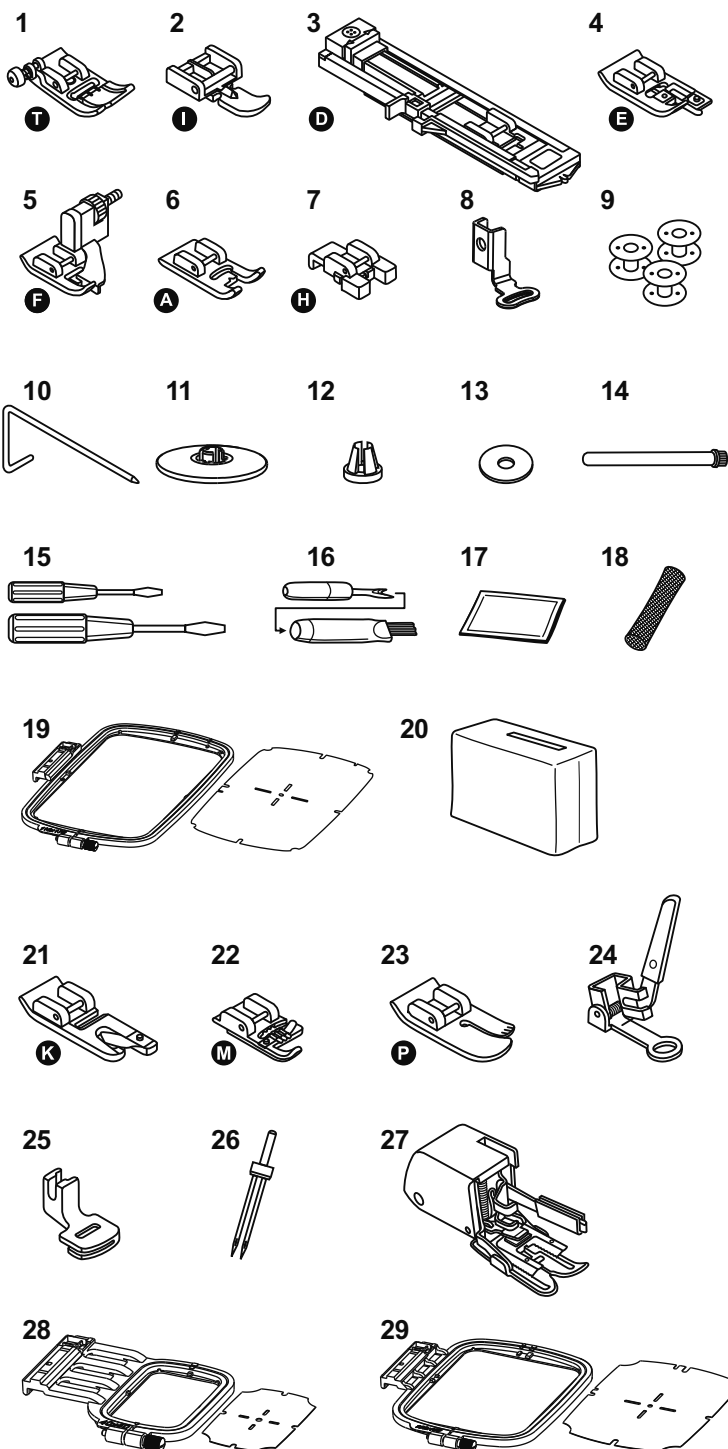

## Standard

1. All purpose foot (T)
2. Zipper foot (I)
3. Buttonhole foot (D)
4. Overcasting foot (E)
5. Blind hem foot (F)
6. Satin stitch foot (A)
7. Button sewing foot (H)
8. Simple embroidery foot
9. Bobbin (3x)
10. Edge/quilting guide
11. Spool holder (Large)
12. Spool holder (Small)
13. Spool pin felt
14. Second spool pin
15. Screwdriver (L & S)
16. Brush/ Seam ripper
17. Needle (3x)
18. Net
19. Embroidery set (L-110\*170mm)
20. Soft cover

## Optional

21. Hemmer foot (K)
22. Cording foot (M)
23. Quilting foot (P)
24. Darning/ Embroidery foot
25. Gathering foot
26. Twin needle
27. Walking foot
28. Embroidery set (S-40\*40mm)
29. Embroidery set (M-100\*100mm)



## Connecting the machine

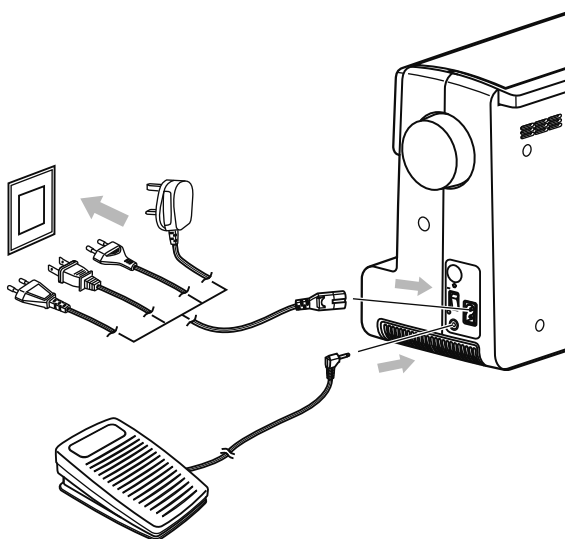

Before connecting the power supply, make sure that the voltage and frequency shown on the rating plate is conforming with your mains power.

Place the machine on a stable table.

1. Connect the power line cord to the machine by inserting the 2-hole plug into the mains plug socket.
2. Connect the power line plug to the wall outlet.
3. Turn on the power switch.
4. The sewing lamp will light up when the switch is turned on.



### Caution:

Always make sure that the machine is unplugged from power source and the main switch is on ("O"). when the machine is not in use and before inserting or removing parts.

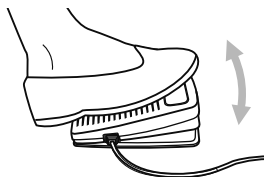

### Foot Control

With the sewing machine turned off, insert the foot control plug into its connector on the sewing machine.

Turn on the sewing machine, and then slowly depress the foot control to start sewing. Release the foot control to stop the sewing machine.



### Attention:

Consult a qualified electrician if in doubt as how to connect the machine to the power source.



## Winding the bobbin

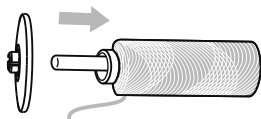
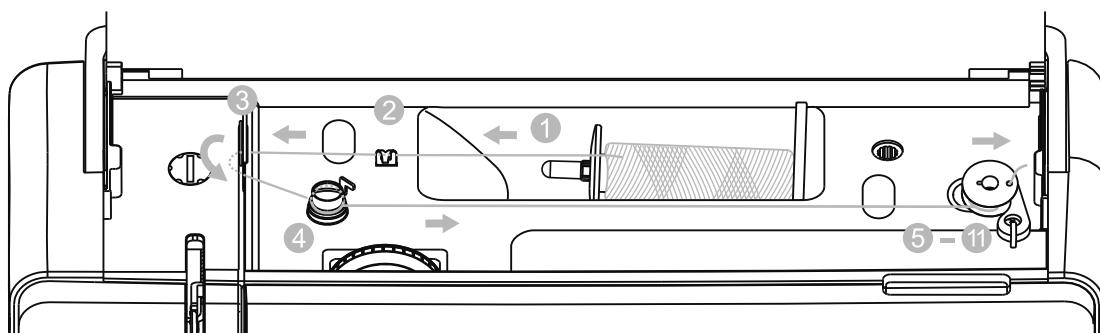

1. Place the thread and spool holder onto the spool pin.  
For smaller spools of thread, place spool holder with the small side next to the spool or use the small spool holder.

**Note:**

If using special thread which winds quickly off the spool attach a net to the spool before using and use the larger spool holder. Reduce the thread tension if necessary.

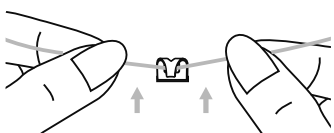

2. Draw the thread from the spool through the upper thread guide.

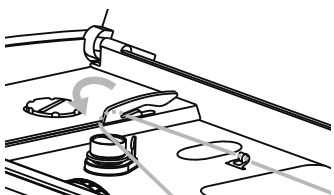

3. Guide the thread around the thread guide pulling the thread through the pre-tension spring as illustrated.

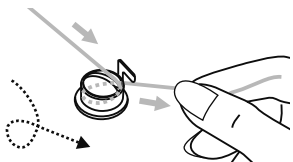

4. Wind the thread clockwise around the bobbin winder tension discs.

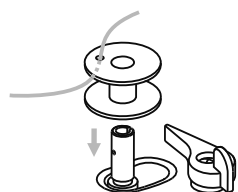

5. Place the thread end through one of the inner holes in the bobbin as illustrated and place empty bobbin on the spindle.

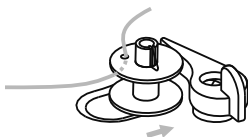

6. Push the bobbin to right.

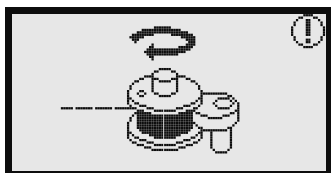

7. When the bobbin winder spindle is pushed to the right, bobbin winding position, the message is shown on the LCD display. It will disappear from the LCD display when the bobbin winder spindle is pushed back to the left into the sewing position

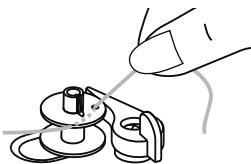

8. Hold the thread tail securely in one hand.

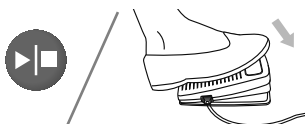

9. Press on the foot control or the Start/Stop button to start winding the bobbin.

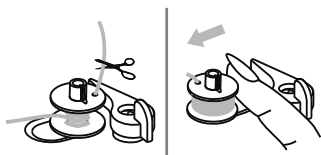

10. After the bobbin has wound a few turns stop the machine and cut the thread near the hole of the bobbin. Continue filling the bobbin until it is full. Once the spool is full, it rotates slowly. Release the pedal or stop the machine. Push the bobbin winder spindle to left.

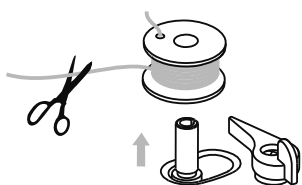

11. Cut the thread and then remove the bobbin.

**Note:**  
When the bobbin winder spindle is placed on the right, "bobbin winding position", the machine will not sew and the handwheel will not turn. To start sewing, push the bobbin winder spindle to the left "sewing position".



## Inserting the bobbin

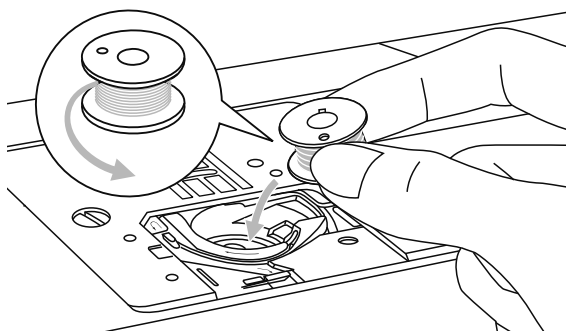

### ! Attention:

Turn power switch to off ("O") before inserting or removing the bobbin.

**When inserting or removing the bobbin, the needle must be fully raised.**

Remove the bobbin cover plate.

Insert the bobbin in the bobbin case with the thread running in a counterclockwise direction (arrow).

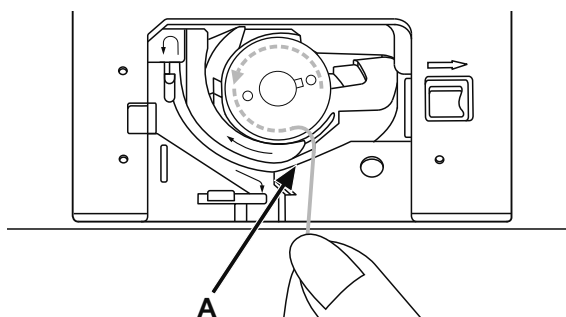

Pull the thread through the slit (A).

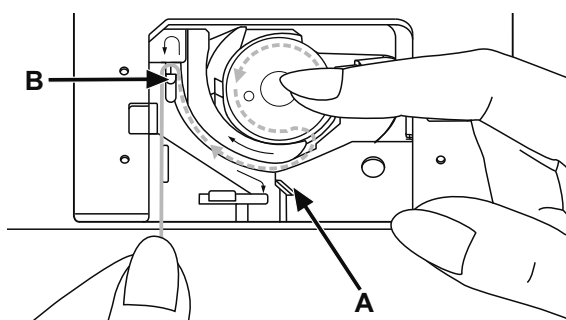

With a finger held gently on top of the bobbin. Draw the thread at the arrow markings into the stitch plate thread guide from (A) to (B).

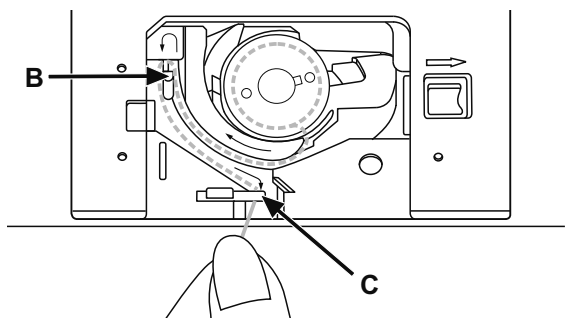

Pull the thread at the arrow markings into the stitch plate thread guide from (B) to (C). To cut off excess thread pull thread back over the cutting off blade at point (C). Close the bobbin cover plate.



# Threading the upper thread

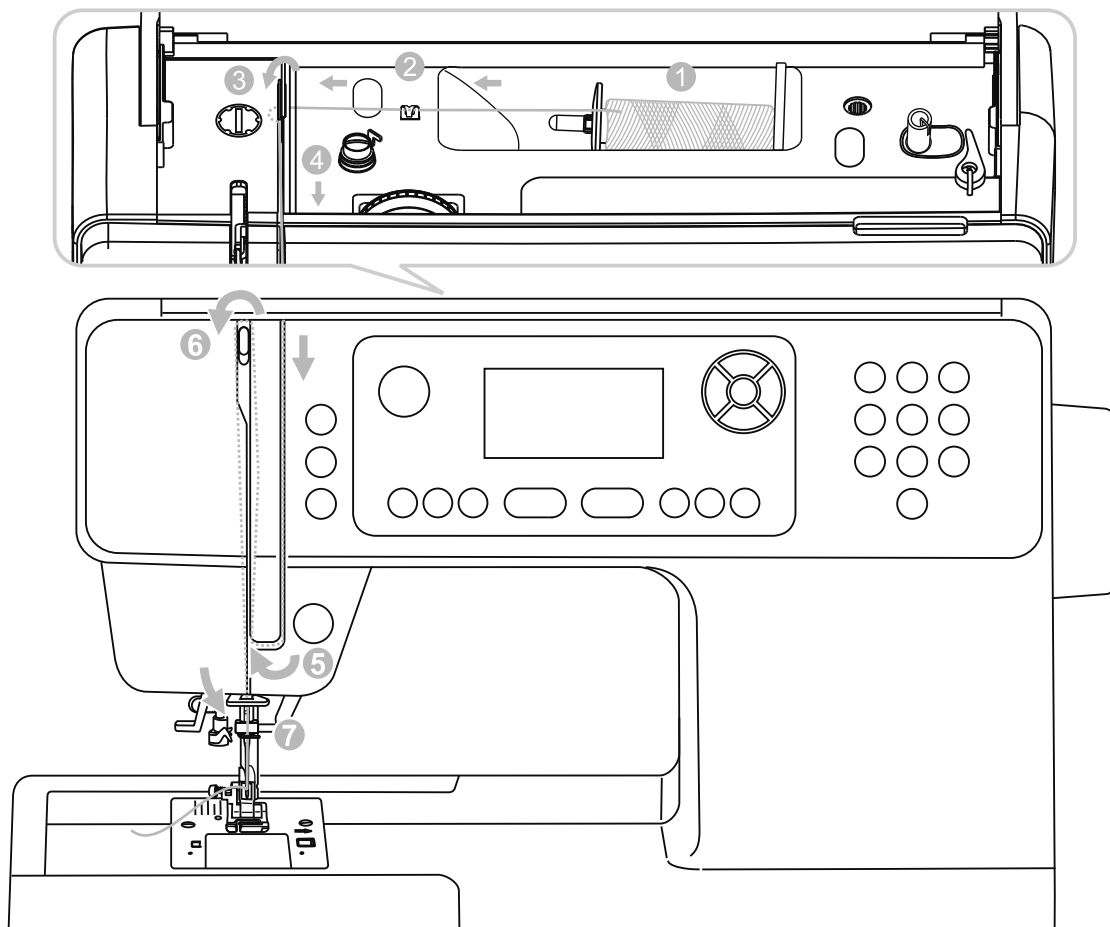

➔ **Please Note:**

It is important to carry out the threading correctly as by not doing so several sewing problems could result.

**Start by raising the needle to its highest point, and also raise the presser foot to release the tension discs.**

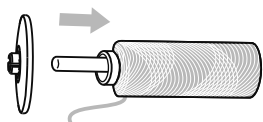

1. Lift up the spool pin. Place the spool of thread on the spool pin so that the thread comes from the front of the spool, then place the spool cap at the end of the spool pin.



➔ **Note:**

In order to prevent tangling of the thread, please use a spool net. The net is especially usefull to work from large or loose wound spools.



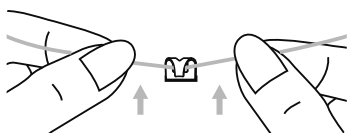

2. Draw the thread from the spool through the upper thread guide.

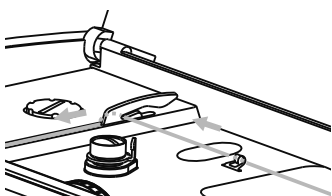

3. Guide the thread around the thread guide pulling the thread through the pre-tension spring as illustrated.

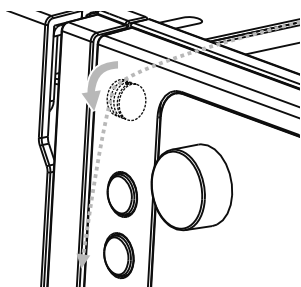

4. Thread the tension module by passing the thread between the silver discs.

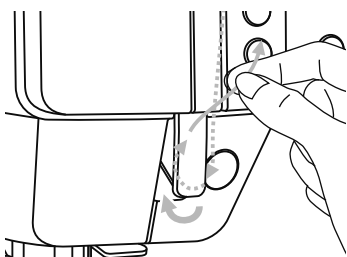

5. Then, down and around the check spring holder.

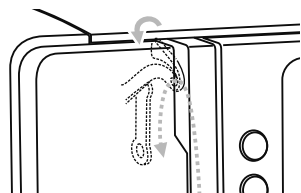

6. At the top of this movement, pass the thread from right to the left through the slotted eye of the take-up lever and then downwards again.

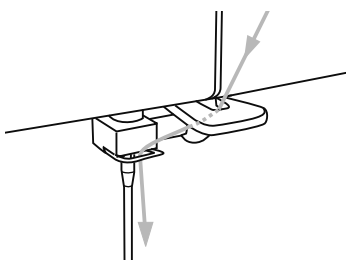

7. Pass the thread behind the flat, horizontal thread guide. Guide the thread through the wire loop. Pull the end of the thread through the needle from front to rear, and pull out about 10 cm of thread. Use the needle threader to thread the needle. (On the next page.)



## Using the needle threader

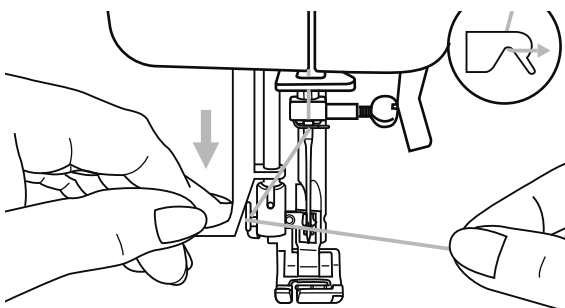

Raise the needle to its highest position and lower the presser foot.

**! Attention:**  
Turn power switch to the off position ("O").

Lower the needle threader lever slowly and draw the thread through the thread guide as illustrated and then to the right.

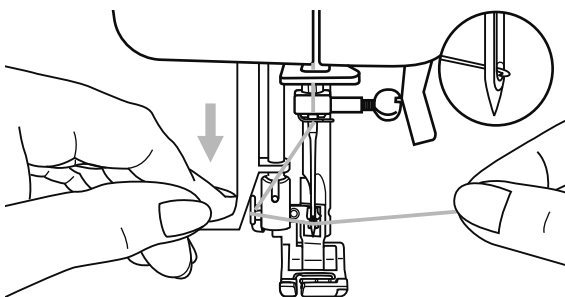

The needle threader automatically turns to the threading position and the hook pin passes through the needle eye.

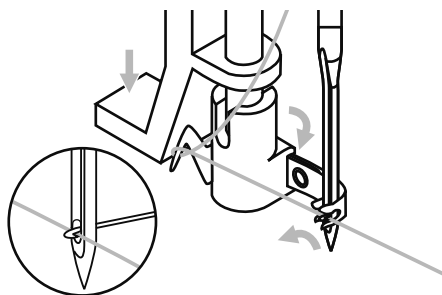

Take the thread in front of the needle.

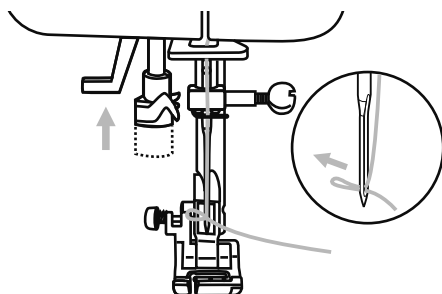

Hold the thread loosely and release the lever slowly. The hook will turn and pass the thread through the needle eye forming a loop. Pull the thread through the needle eye.



## Using the net

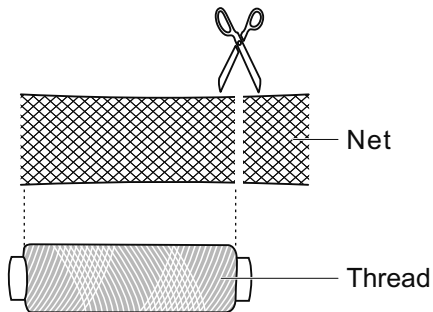

When using special threads which wind quickly off the thread spool, attach a net to the spool before using.

\* If the net is too long, cut the net to match the size of the spool.

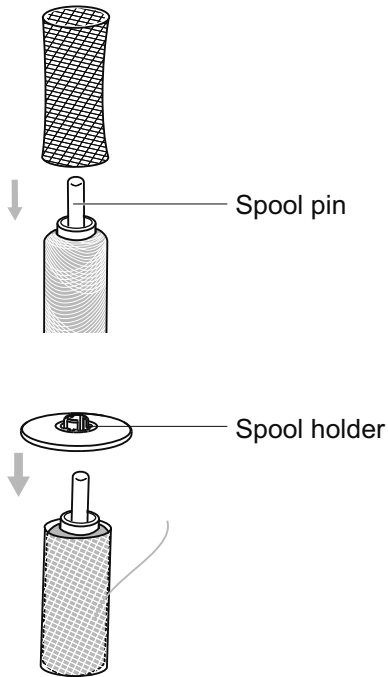



## Adjusting presser foot pressure

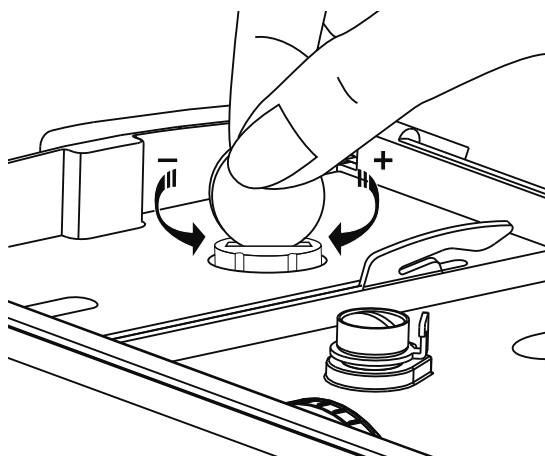

The presser foot pressure of the machine has been pre-set and requires no particular readjustment according to the type of fabric (light-or-heavy weight).

However, if you need to adjust the presser foot pressure, turn the presser adjusting screw with a coin.

For sewing very heavy fabric, loosen the pressure by turning the screw counter clockwise, and for thin fabric, tighten by turning it clockwise.

To return to initial pressure foot setting turn the presser foot pressure adjusting screw to become flush with the face cover.

## Replacing the needle

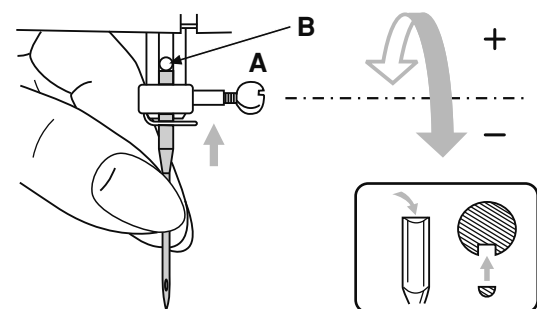

### ! Attention:

Turn power switch to off ("O") when carrying out the below operation!

Change the needle regularly, especially if it is showing signs of wear and causing problems.

Insert the needle following the illustrated instructions.

- A. Loosen the needle clamp screw and tighten again after inserting the new needle. The flat side of the shaft should be towards the back.
- B. Insert the needle as far up as it will go.

Needles must be in perfect condition.

Problems can occur with:

- Bent needles
- Blunt needles
- Damaged points

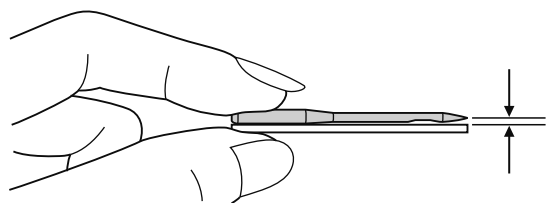



## Matching needle/ fabric/ thread

### NEEDLE, FABRIC, THREAD SELECTION GUIDE

NEEDLE SIZE	FABRICS	THREAD
9-11 (70-80)	Lightweight fabrics-thin cottons, voile, serge, silk, muslin, Qiana, interlocks, cotton knits, tricot, jerseys, crepes, woven polyester, shirt & blouse fabrics.	Light-duty thread in cotton, nylon, polyester or cotton wrapped polyester.
11-14 (80-90)	Medium weight fabrics-cotton, satin, kettlecloth, sailcloth, double knits, lightweight woollens.	Most threads sold are medium size and suitable for these fabrics and needle sizes.
14 (90)	Medium weight fabrics-cotton duck, woolen, heavier knits, terrycloth, denims.	Use polyester threads on synthetic materials and cotton on natural woven fabrics for best results.
16 (100)	Heavyweight fabrics-canvas, woollens, outdoor tent and quilted fabrics, denims, upholstery material (light to medium).	Always use the same thread on top and bottom.
18 (110)	Heavy woollens, overcoat fabrics, upholstery fabrics, some leathers and vinyls.	Heavy duty thread, carpet thread.

#### → Please Note:

- In general, fine threads and needles are used for sewing fine fabrics, and thicker threads are used for sewing heavy fabrics.
- Always test thread and needle size on a small piece of fabric which will be used for actual sewing.
- Use the same thread for needle and bobbin.
- Use a backing for fine or stretchy fabrics.



# Changing the presser foot

## ⚠ Attention:

Turn power switch to off ("O") when carrying out any of the below operations!

### Attaching the presser foot holder

Raise the presser foot bar (a).  
Attach the presser foot holder (b) as illustrated.

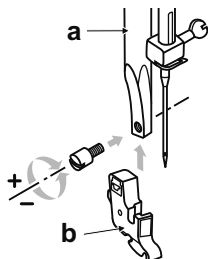

### Attaching the presser foot

Lower the presser foot holder (b) until the cut-out (c) is directly above the pin (d).  
Press the black lever (e).  
Lower the presser foot holder (b) and the presser foot (f) will engage automatically.

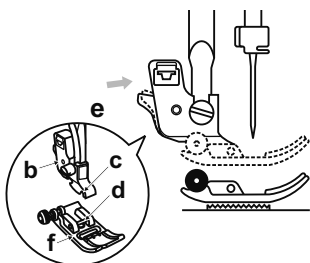

### Removing the presser foot

Raise the presser foot.  
Press the black lever (e) and the foot will disengage.

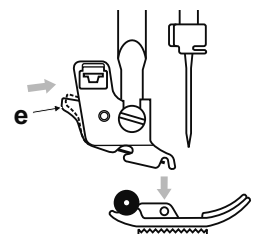

### Attaching the edge/quilting guide

Attach the edge/quilting guide (g) in the slot as illustrated. Adjust according to need for hems, pleats, etc.

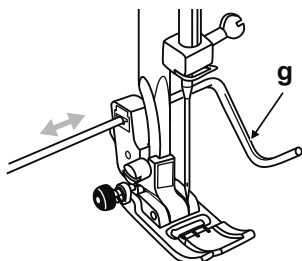



# Type of presser foot chart

PRESSER FOOT	APPLICATION	NEEDLE	PRESSER FOOT	APPLICATION	NEEDLE
<p>All purpose foot (T)</p>	General sewing, Patchwork stitches, Decorative stitching, Smocking, Fagoting, etc.		<p>Cording foot (M) (Optional)</p>	Cording 	
<p>Zipper foot (I)</p>	Inserting zippers 		<p>Hemmer foot (K) (Optional)</p>	Narrow hemming 	
<p>Buttonhole foot (D)</p>	Buttonhole sewing, Bar tack stitches, Darning stitches. 		<p>Simple embroidery foot</p>	Darning Free embroidery Monogramming 	
<p>Button sewing foot</p>	Button sewing 		<p>Quilting foot (P) (Optional)</p>	Quilting 	
<p>Blind hem foot (F)</p>	Blind hem stitching 		<p>Gathering foot (Optional)</p>	Gathering 	
<p>Overcasting foot (E)</p>	Overcasting 		<p>Walking foot (Optional)</p>	This foot helps to prevent uneven feeding of very difficult fabrics	
<p>Satin stitch foot (A)</p>	Satin stitch sewing 		<p>Walking foot (Optional)</p>		



## Two-step presser foot lifter

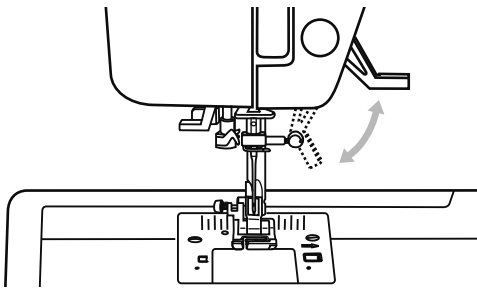

The presser foot lifter raises and lowers your presser foot.

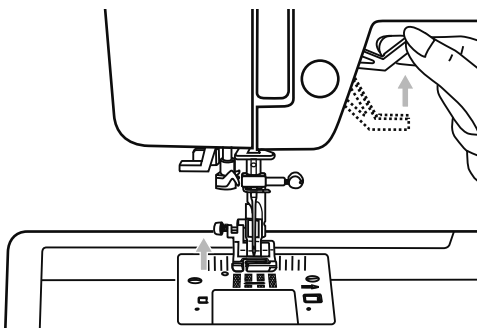

The second level is only used in embroidery mode to remove the hoop easily.

 **Note:**

The needle must always be at the highest position.

## To raise or drop the feed dogs

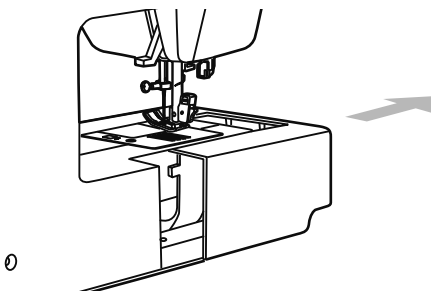

With the sewing table off the machine, the feed dog adjustment lever can be seen on the base in back of the sewing machine.

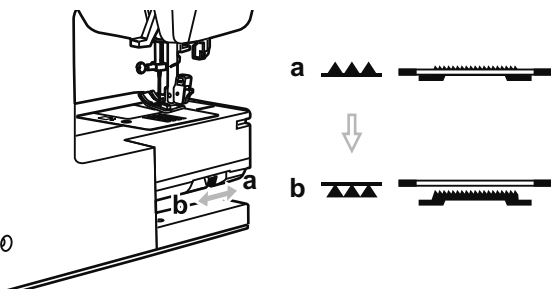

Sliding the lever to the "▲▲▲" (b) will lower the feed dog, for example during button sewing. If you wish to continue sewing normally, slide the lever to the "▲▲▲" (a) in order to raise the feed dogs.

The feed dog will not rise up if you do not turn the handwheel, even if the lever is slid to the right. Make a complete turn to raise the feed dogs.





# Information on the LCD Display

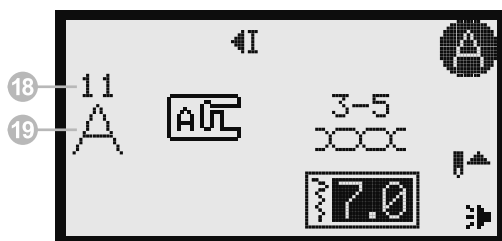
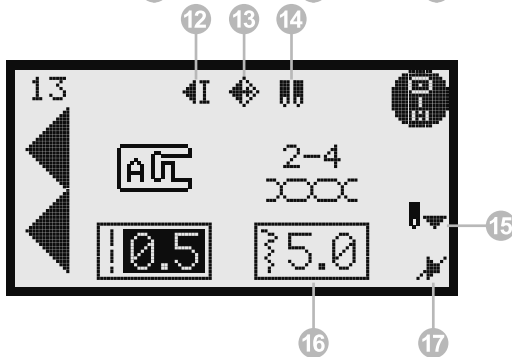
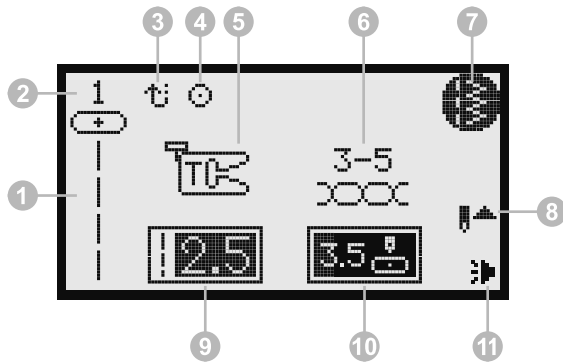

## ☒ Normal mode

### Normal mode display

1. Pattern
2. Pattern number
3. Reverse
4. Auto-lock
5. Suggested presser foot
6. Tension
7. Pattern group
8. Needle up position
9. Stitch length
10. Needle position
11. Sound on
12. Auto-stop
13. Mirror
14. Twin needle
15. Needle down position
16. Stitch width
17. Sound off
18. Alphabet number
19. Alphabet

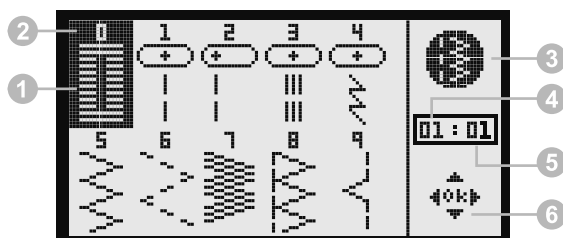

### Normal mode display - pattern browser display

1. Pattern
2. Pattern number
3. Pattern group
4. Current page
5. Total page
6. Operation indication

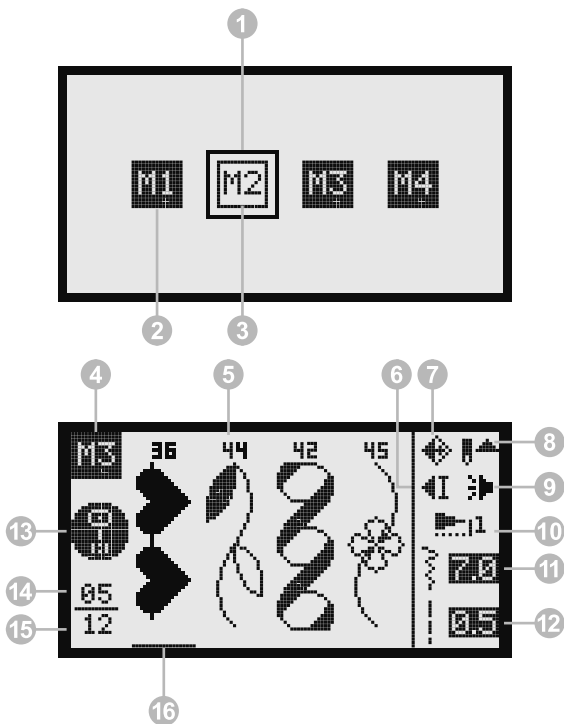

## ☒ Memory mode

### Memory mode display

1. Selection frame
2. Memory module with unit
3. Empty memory module
4. Current memory module
5. Pattern number and pattern
6. Auto-stop
7. Mirror
8. Needle up position
9. Sound on
10. Elongation
11. Stitch width
12. Stitch length
13. Current pattern group
14. Current memory unit
15. Total of memory units
16. Memory cursor

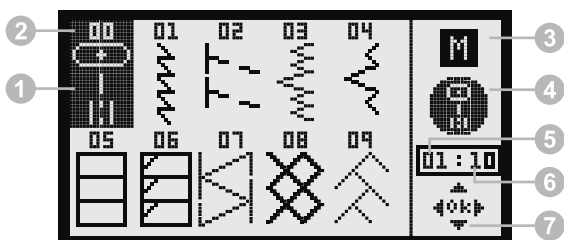

### Memory mode display - pattern browser display

1. Pattern
2. Pattern number
3. Memory model
4. Pattern group
5. Current page
6. Total page
7. Operation indication

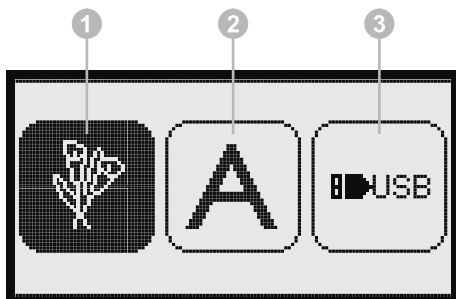

## ✘ Embroidery mode

### Embroidery mode display - type selection display

1. Built-in Embroidery pattern
2. Built-in Embroidery letter
3. Designs from USB

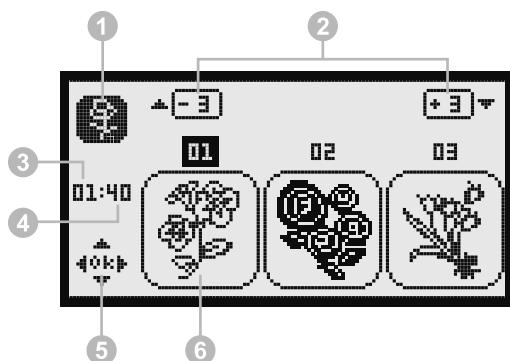

### Embroidery mode display - Built-in Embroidery pattern

1. Type mode
2. Indication - select page up/down
3. Current pattern
4. Total pattern
5. Operation indication
6. Embroidery pattern number and pattern



### Embroidery mode display - Built-in Embroidery letter

1. Embroidery hoop size L-110\*170mm
2. Embroidery hoop size M-100\*100mm
3. Embroidery hoop size S-40\*40mm

\* When the hoop icon is flickering means the layout is doing size adjustment or the current size will change.

4. Editing area
5. Cursor
6. Type model
7. Current page
8. Total page
9. Operation indication
10. Embroidery letter
11. Letter type

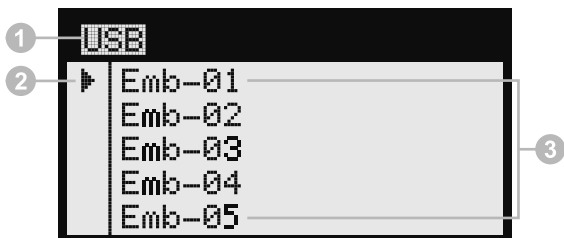

**Embroidery mode display -  
Designs from USB**

1. Type mode
2. Cursor
3. Loading pattern

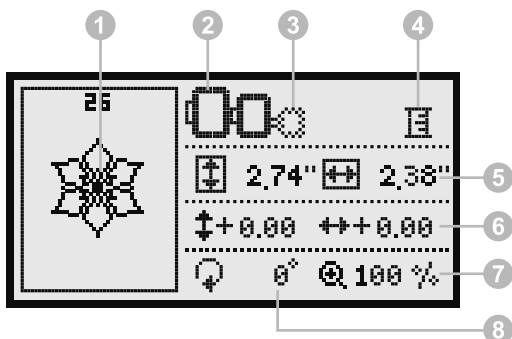

**Embroidery mode display -  
editing display**

1. Embroidery field
2. Available embroidery hoop
3. Unavailable embroidery hoop (appear in gray)
4. Multi color
5. Embroidery size (inch)
6. Embroidery distance from the center
7. Degrees
8. Percentage

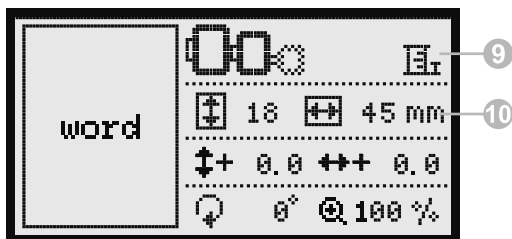

**Embroidery mode display -  
embroidery display**

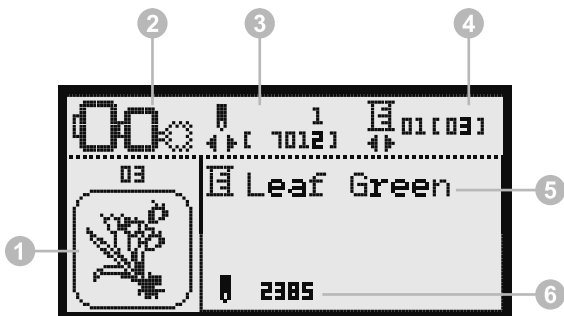

1. Embroidery pattern number and pattern
2. Available embroidery hoops
3. Current stitch counts and total stitch counter of the pattern
4. Current color step and Number of colors in the pattern
5. Current name of color
6. Stitch counts of current color



## Buttons of the machine

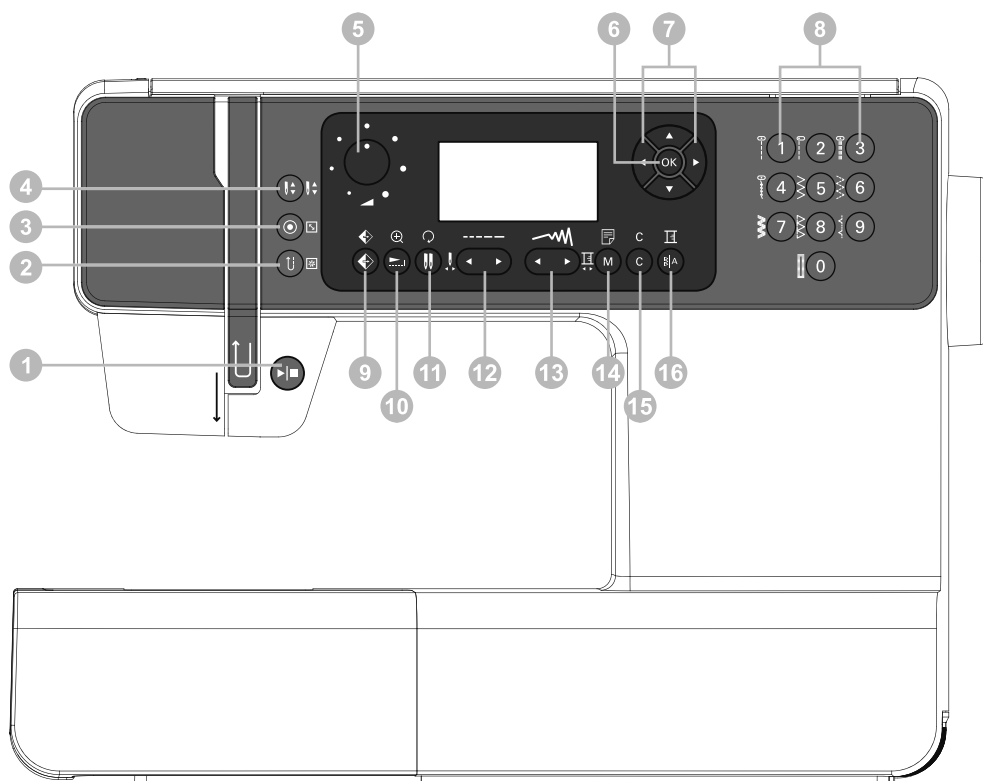

1. Start/stop button
2. Reverse/ Exit button
3. Auto-lock/ Trace button
4. Needle up/down position button
5. Speed limiting adjustment dial
6. OK button
7. Arrow buttons
8. Direct pattern selection and number buttons
9. Mirror button
10. Elongation/ Resize button
11. Twin needle/ Rotate button
12. Stitch length adjustment/ Stitch forward/back button
13. Stitch width adjustment/ Color forward/back button
14. Memory/ Setup button
15. Clear/ Return button
16. Pattern group selection/ Color step button

### ➔ Please Note:

The icon on the button is for sewing model, and the icon in the side of button is for embroidery model. If you want to get more detailed information, please refer the user's manual.



## Operation buttons



### Start/stop button

The machine will start running when Start/stop button is pressed and will stop when pressed the second time.

The machine will rotate slowly at the beginning of the sewing.



### Reverse/ Exit button

Reverse is pressed to sew in reverse.

The icon "↶" on the LCD indicates reverse sewing.

The machine will permanently sew in reverse, release the button to sew forward.

Only the Direct Patterns 1-5 and A Group Pattern 00 can be sewn in reverse.

If you press the reverse button before starting to sew, the machine will permanently sew in reverse and press the button again to sew forward.



In embroidery mode, press this button to return the type selection display, the selected pattern is cancelled.



### Auto-lock/ Trace button

When the Direct Patterns 1-4 and A Group Pattern 00 selected, the machine will immediately sew 3 locking stitches when the Auto-lock button is pressed, then automatically stop.

The LCD display will display the figure "⊙" until the machine is stopped.

Select the pattern (except Direct Patterns 0-4 and A Group Pattern 00, 86-98), press the Auto-lock button, the machine will sew 3 locking stitches at the end of the current pattern and automatically stop.

The LCD display will display the figure "◀I" until the machine is stopped.

The function will be cancelled if you press the button once again or select another pattern.

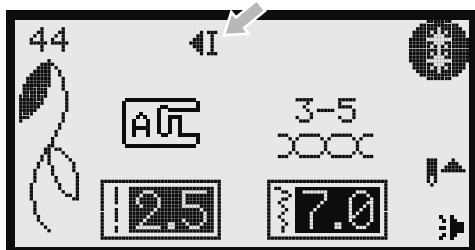
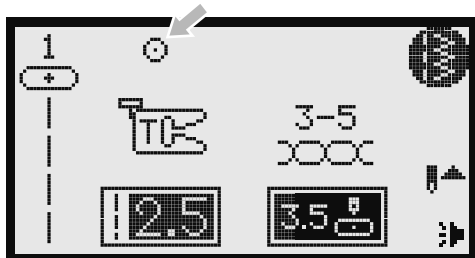

In embroidery mode, press this button to check the size of the embroidering area in the editing display.

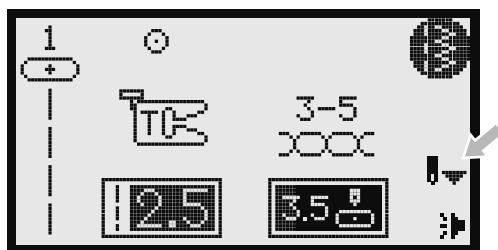
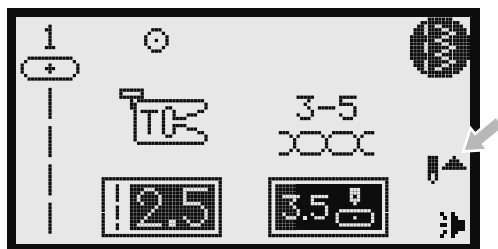

## Needle up/ down position button

With the Needle up/ down position button, you decide whether the needle shall stop in the up position or in the material when you stop sewing.

Press the button so the arrow on the LCD points upward "↑" the needle moves to the highest position and will stop there after sewing.

Press the button so the arrow on the LCD points downwards "↓" the needle moves to the lowest position and will stop there after sewing.

### ⤵ Please Note:

During sewing, press the needle up/down button, the machine will stop automatically.

In the memory mode, the Needle up/ down position button use only in the embroidery display.

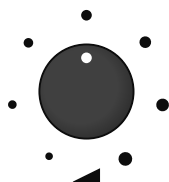

## Speed limiting adjustment dial

Speed limiting adjustment dial can control the sewing speed.

Turn the dial clockwise to make sewing speed faster. Turn the dial counterclockwise to make sewing speed slower.

### ⤵ Note:

Speed setting is applied exclusively in sewing mode.



## Arrow buttons

Use the buttons to select desired pattern, function... etc.

## OK button

Press this button to confirm the selection.

In the normal mode press the button to into pattern browser.

In the memory mode press the button to into pattern browser.

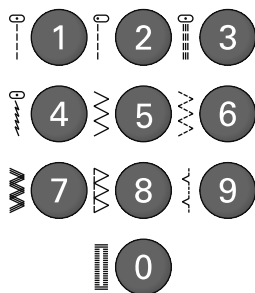

### Direct pattern selection and number buttons

#### Direct pattern selection

Press the buttons to select the utility patterns shown beside the number button when the mode button is set at the Direct mode.

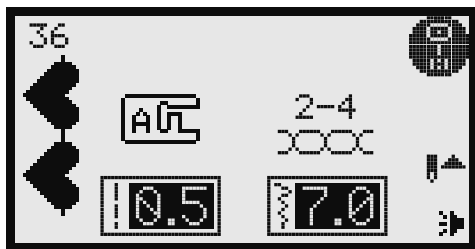
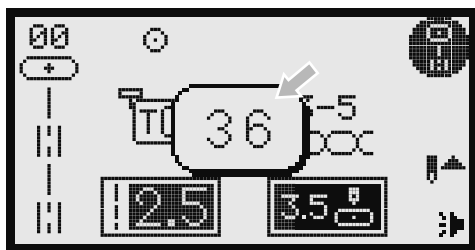

#### Number buttons

Except the Direct pattern mode, the other mode can be selected by pressing the desired numbers.

Press the number buttons for selecting the pattern needed.

For example: pattern 36





## Function buttons



### Mirror button

Except the Direct Patterns 0 and the patterns 86-98 from the Group Patterns "A", the other patterns can be mirror imaged by pressing the mirror button.

The machine will continue to sew the reflected pattern until the mirror button is pressed again. The mirror function also will be cancel if the pattern changed.

A. Normal pattern

B. Mirror image pattern

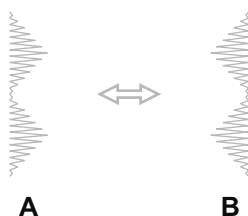

### Elongation/ Resize button

A Group Patterns 13-36 can be elongated up to five times its normal length by pressing the elongation button.

When the width or length or stitch is changed, a greater variety of patterns are available.

In embroidery mode, press this button to open the resize window.



### Twin needle/ Rotate button

Except the Direct Patterns 0 and the patterns 86-98 from Group Patterns "A", the other patterns can be sewn in two parallel line of the same stitch with the twin needle.

Press the twin needle button, and the machine automatically reduces the maximum width for the twin needle sewing.

Press the button again to return to single needle sewing.

In embroidery mode, press this button to rotate the embroidery pattern.

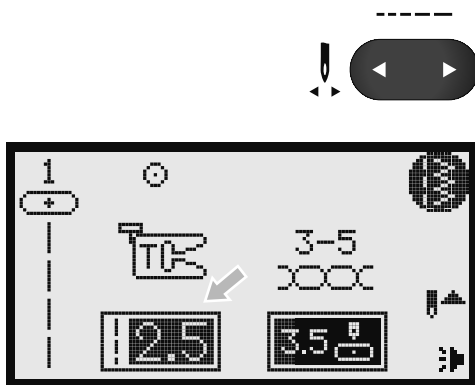

### Stitch length adjustment/ Stitch forward/back button

When you select a stitch the machine will automatically set the recommended stitch length which will be indicated by numbers on the LCD display.

The stitch length can be adjusted by pressing the stitch length adjustment buttons. To shorten the stitch length, press the "-" button (left). For a longer stitch length, press the "+" button (right). The stitch length can be adjusted between "0.0-4.5". Certain stitches have a limited stitch length.

In embroidery mode, press this button to forward or back the current stitch counts.

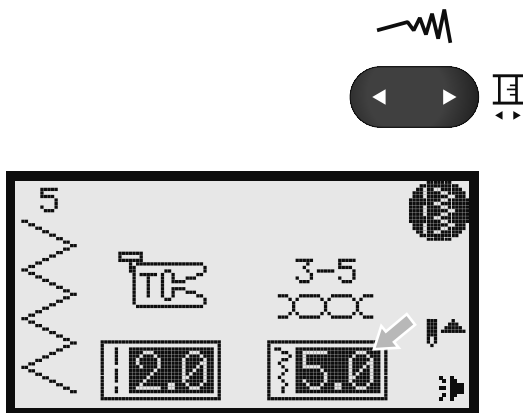

### Stitch width adjustment/ Color forward/back button

When you select a stitch, the machine will automatically set the recommended stitch width, which will be indicated by numbers on the LCD display.

The stitch width can be regulated by pressing the stitch width adjustment button. For a narrower stitch, press the button left. For a wider stitch, press the button right. The stitch width can be adjusted between "0.0-7.0". Certain stitches have a limited stitch width

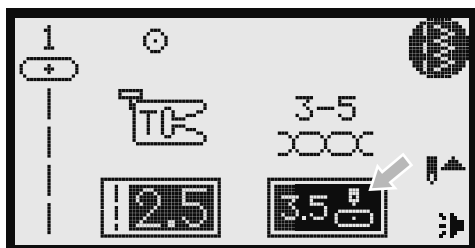

When Direct Patterns 1-4 and A Group Pattern 00 are selected, the needle position is regulated by the stitch width adjustment buttons. Press the button left will move the needle to the left. Press the button right, will move the needle to the right. The numbers will be changed from left position "0.0" to extreme right position "7.0". The preset center needle position will be indicated as "3.5".

In embroidery mode, press this button to forward or back the color part.



### Memory/ Setup button

Press the memory button to enter the memory mode, and store the combinations of characters or decorative stitches.

The Direct mode patterns and the patterns 86-98 from Group Patterns "A" cannot be memorized.

In embroidery mode, press this button to enter the setting program.

C



### Clear/ Return button

If an incorrect pattern or memory module is selected, press this button to clear it or return to the previous display.



### Pattern group selection/ Color step button

The LCD display will be set at direct patterns mode when you turn on the machine.

Press the pattern group selection button, LCD display enters the pattern group selection display automatically. Use the arrow buttons to select the desired group of stitch.

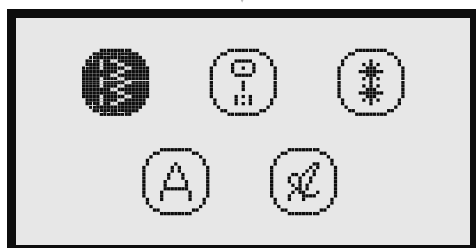
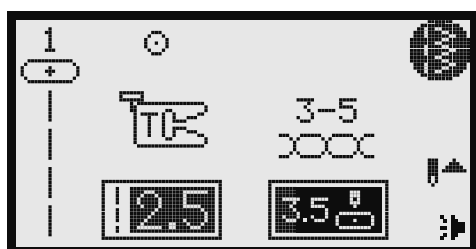

Direct patterns mode.



A Group Patterns mode.



B Group Patterns mode.



Block style alphabet mode.



Script style alphabet mode.

In embroidery mode, press this button to set the single or multi color for embroidery pattern.

# Pattern chart

## ☒ Direct patterns

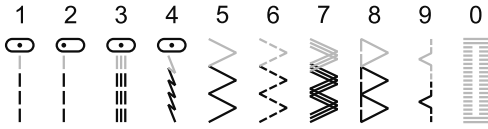

## ☒ A Group Patterns

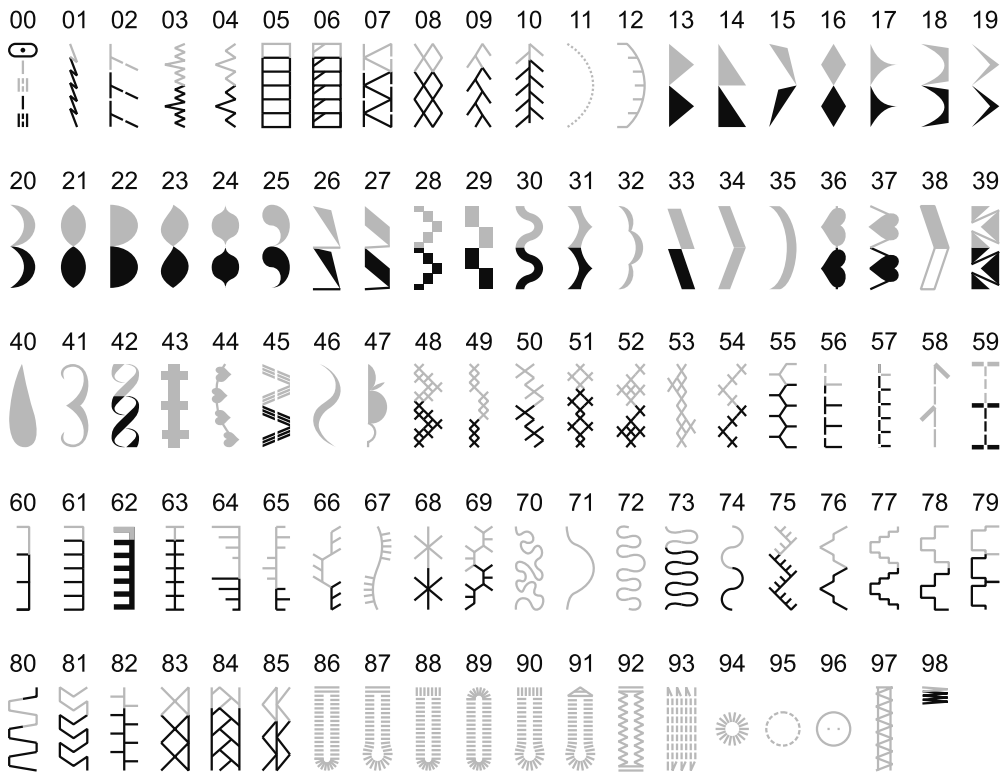

## ☒ B Group Patterns

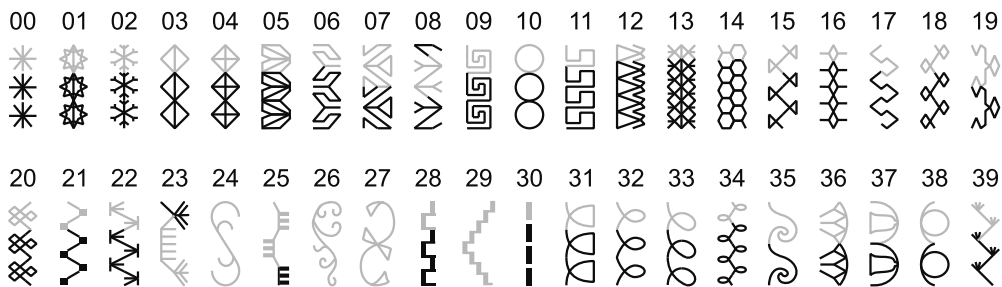

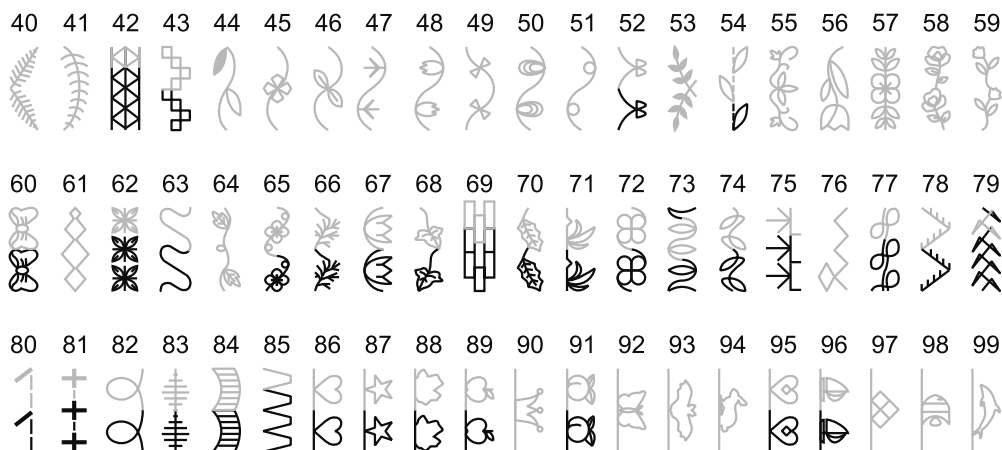

☒ **Alphabet - Block style**

01 02 03 04 05 06 07 08 09 10  
**1 2 3 4 5 6 7 8 9 0**

11 12 13 14 15 16 17 18 19 20 21 22 23 24 25 26 27 28 29 30 31 32 33 34 35 36  
**A B C D E F G H I J K L M N O P Q R S T U V W X Y Z**

37 38 39 40 41 42 43 44 45 46 47 48 49 50 51 52 53 54 55 56 57 58 59 60 61 62  
**a b c d e f g h i j k l m n o p q r s t u v w x y z**

63 64 65 66 67 68 69 70 71 72 73 74 75 76 77 78 79 80 81 82 83 84 85 86 87 88  
**Ä Å Æ Ñ Ö Ø Ç Ü ä å æ ë è é ê ñ ö õ ø ì ç ü ù ß &**

89 90 91 92 93 94 95 96 97  
**? ! \_ ' , . - ( )**

☒ **Alphabet - Script style alphabet**

01 02 03 04 05 06 07 08 09 10  
*1 2 3 4 5 6 7 8 9 0*

11 12 13 14 15 16 17 18 19 20 21 22 23 24 25 26 27 28 29 30 31 32 33 34 35 36  
*A B C D E F G H I J K L M N O P Q R S T U V W X Y Z*

37 38 39 40 41 42 43 44 45 46 47 48 49 50 51 52 53 54 55 56 57 58 59 60 61 62  
*a b c d e f g h i j k l m n o p q r s t u v w x y z*

63 64 65 66 67 68 69 70 71 72 73 74 75 76 77 78 79 80 81 82 83 84 85 86 87 88  
*Ä Å Æ Ñ Ö Ø Ç Ü ä å æ ë è é ê ñ ö õ ø ì ç ü ù ß &*

89 90 91 92 93 94 95 96 97  
*? ! \_ ' , . - ( )*



# Thread tension

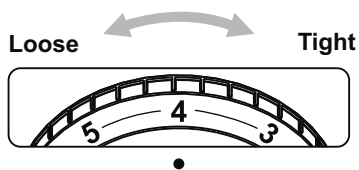

- Basic thread tension setting: "4"
- The recommend thread tension for embroidering is "2" - "6".
- To increase the tension, turn the dial to the next number up. To reduce the tension, turn the dial to the next number down.
- Proper setting of tension is important to good sewing.
- For all decorative sewing you will always obtain a nicer stitch and less fabric puckering when the upper thread appears on the bottom side of your fabric.
- There is no single tension setting appropriate for all the stitch functions and fabrics.

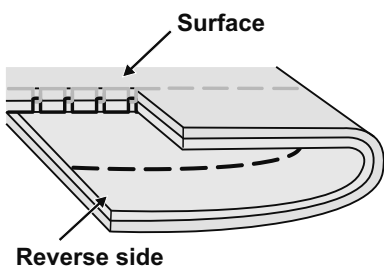

Normal thread tension for straight stitch sewing.

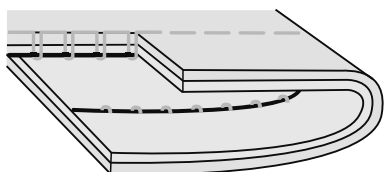
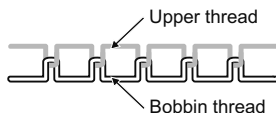

Thread tension is too loose for straight stitch sewing. Turn dial to higher number.

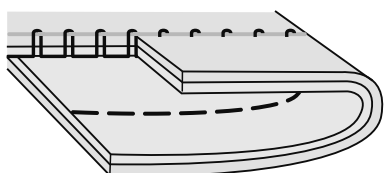

Thread tension is too tight for straight stitch sewing. Turn dial to lower number.

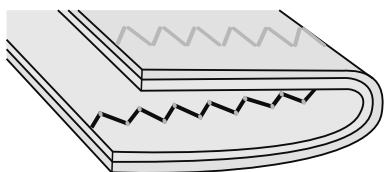

Normal thread tension for zig zag and decorative sewing.





## Useful skills

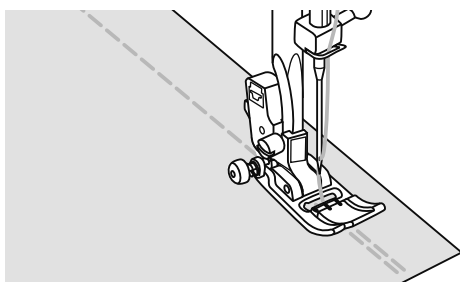

### ☒ Reverse

Reverse stitching is used to secure the threads at the beginning and at the end of a seam.

Press the reverse button and sew 4-5 stitches. The machine will sew forward when the button is released.

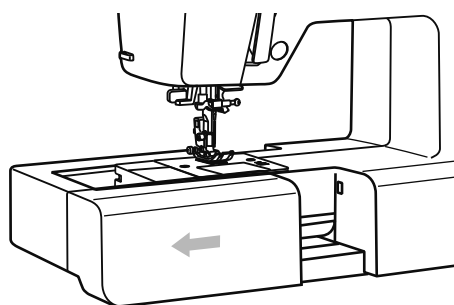

### ☒ Free arm

Free-arm sewing is convenient for sewing tubular areas such as pant hems and cuffs.

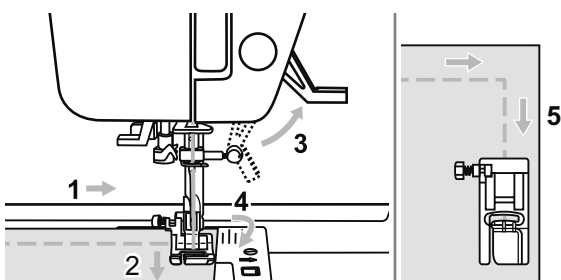
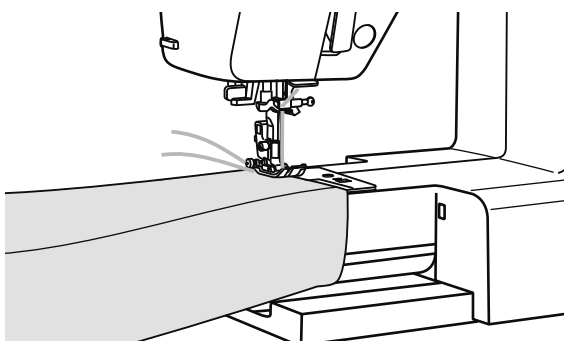

### ☒ Sewing corners

1. Stop the sewing machine when you reach a corner.
2. Lower the needle into the fabric manually or by pressing the needle up/ down button once.
3. Raise the presser foot.
4. Use the needle as a pivot and turn the fabric.
5. Lower the presser foot and resume sewing.

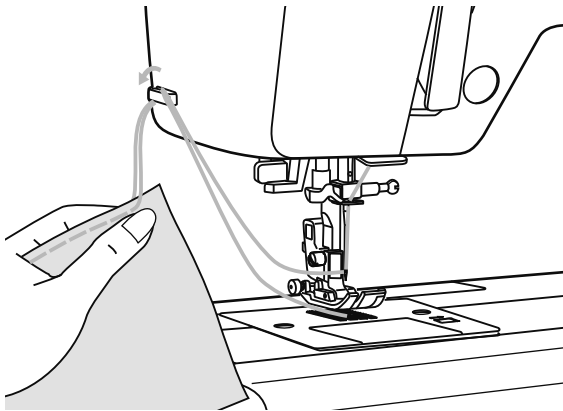

### ✘ Cutting the thread

The thread cutter serves two purposes.

1. Cut the thread after threading the needle
2. Cut the thread after finishing a seam.

To cut the thread after completing your work raise the presser foot.

Remove the fabric, draw the threads to the left side of the face cover and cut using the thread cutter.

The threads are cut at the proper length to start the next seam.

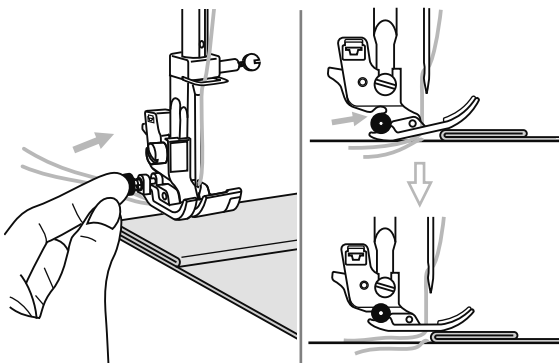

### ✘ Sewing on the heavy fabric

The black button on the left side of the presser foot will lock the presser foot in a horizontal position if you push it in before lowering the presser foot. This ensures even feeding at the beginning of a seam and helps when sewing multiple layers of fabric such as sewing over seams when hemming jeans.

When you reach the point of an increased thickness, lower the needle and raise the presser foot. Press the toe of the foot and push in the black button, then lower the foot and continue sewing.

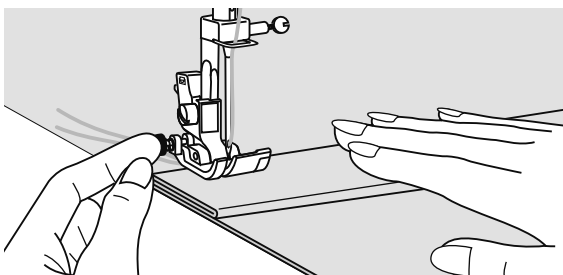

The black button releases automatically after sewing few stitches.

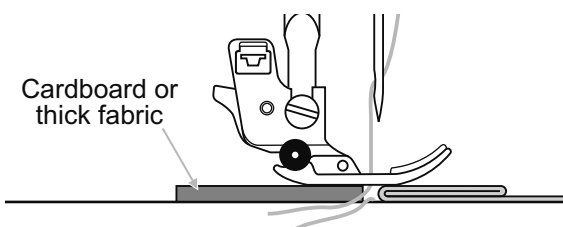

You also can place another piece of fabric with the same thickness at the back of the seam.

Or support the presser foot while feeding by hand and sewing toward the folded side.



# Selecting stitch

Ten of the most frequently used utility stitches can quickly be selected with the direct pattern selection and number buttons. Select the desired stitch from those shown on the top cover.

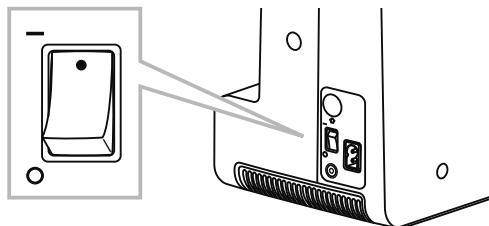

1. Turn on the sewing machine.

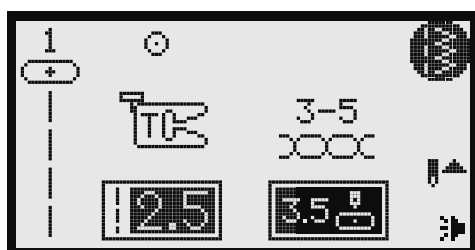

2. When the sewing machine is turned on, the straight stitch (center needle position) is automatically selected.

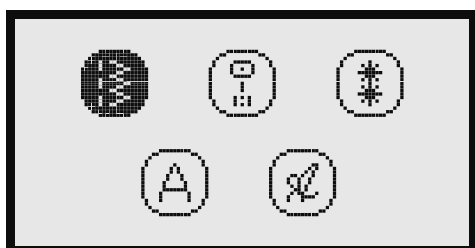

3. Press the pattern group selection button  to enter the pattern group selection display.

The following 5 category icons show on.

4. Use the arrow buttons  to select the desired group of stitch that you wish. (E.g.  For pattern group "A")

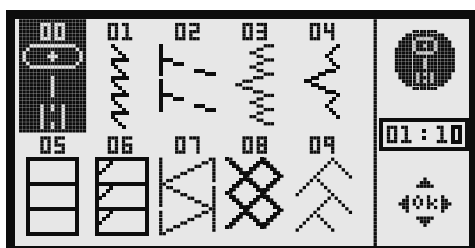

5. Press ok button  to into pattern browser, the display containing the various stitches in the selected pattern group appears.

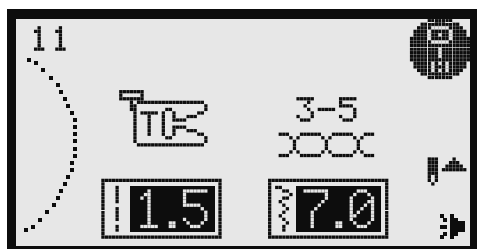
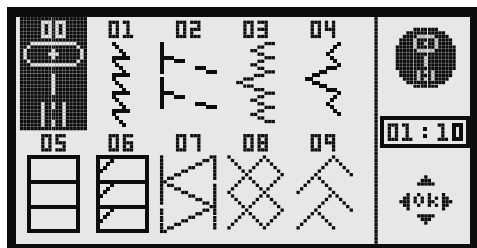
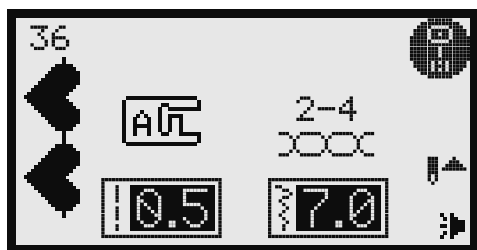
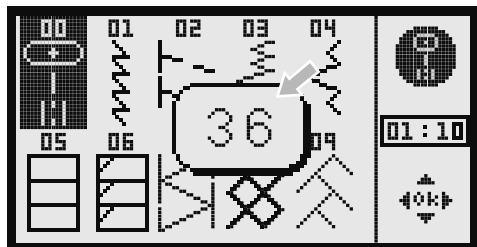

6. Select the desired pattern that you sew.

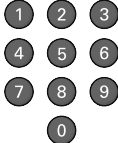
- ✘ **Use the number buttons**

Press the number buttons for selecting the pattern needed.

For example: pattern 36

 **Please Note:**



Press the OK button  can return to the pattern browser display.

- ✘ **Use the arrow buttons** 

Press the arrow buttons until the stitch that you wish to use is selected.

 To the previous/ next stitch pattern.

 To the previous/ next stitch pattern row.

For example: Direct pattern 11, press the arrow button  twice, and then press the arrow button  once.

Press the OK button , the stitch pattern is selected.

 **Please Note:**

Press the OK button  can return to the pattern browser display.



## Straight stitches and needle position

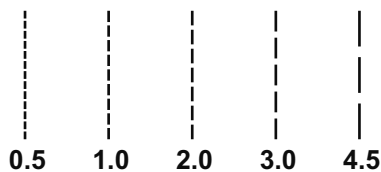
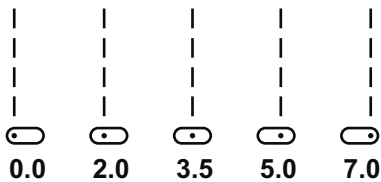
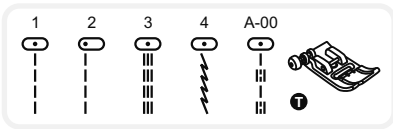

### Changing the needle position

These settings apply only to Direct Patterns 1-4 and A Group Pattern 00.

The pre-set position is "3.5", center position. Press the stitch width adjustment button left "◀", the needle position will move to the left.

Press the stitch width adjustment button right "▶", the needle position will move to the right.

### Changing the stitch length

To shorten the stitch length, press the stitch length adjustment button left "◀". For a longer stitch length, press the stitch length adjustment button right "▶".

Generally speaking, the thicker the fabric, thread and needle, the longer the stitch should be.

## Zigzag stitches

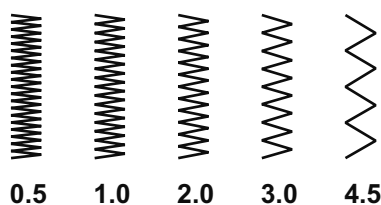
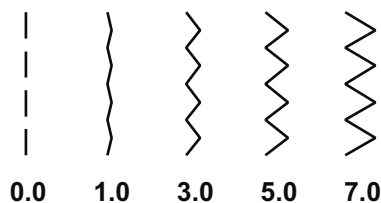
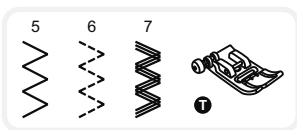

### Adjusting the stitch width

The width increases as you press the stitch width adjustment button from "0.0-7.0".

The width can be reduced on any patterns.

### Adjusting the stitch length

The density of zigzag stitches increase as the setting of stitch length approaches "0.3".

Neat zigzag stitches are usually achieved at "1.0-2.5".

Closed up zigzag stitches (close together) are referred to as a satin stitch.



# Stretch stitch

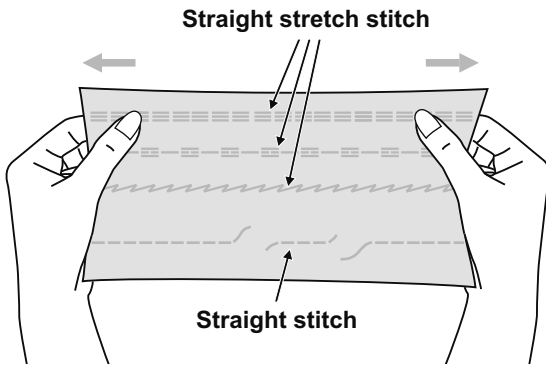
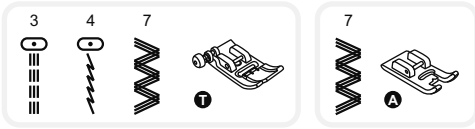

It assures you of a stitch that is strong and flexible and will give with the fabric without breaking. Good for easy to ravel and knit fabrics. It is good for joining durable fabric such as denims.

These stitches can also be used as a decorative top stitch.

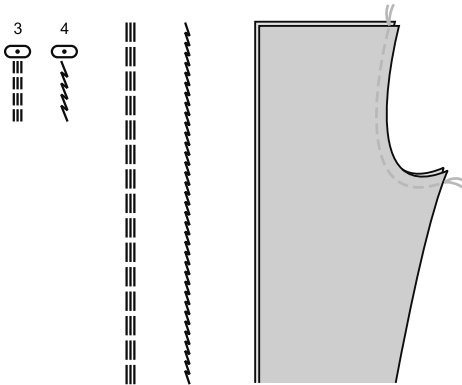

Straight stretch stitch is used to add triple reinforcement to stretch and hardwearing seams.

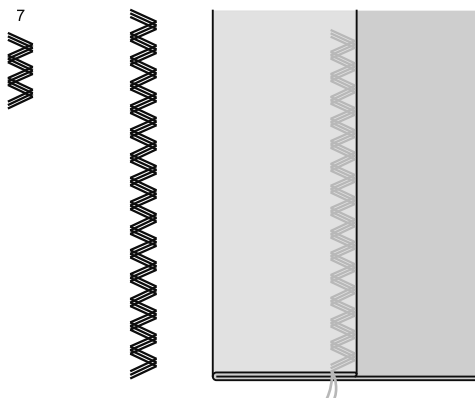

Triple zigzag stretch stitch is suitable for firm fabrics like denim, poplin, duck, etc.



## Overcasting stitches

Sewing overcasting stitches along the edges of fabric to prevent them from fraying.

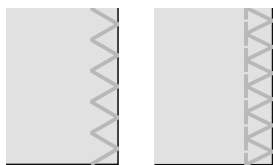
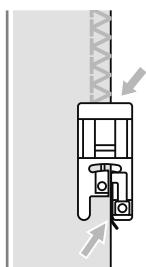
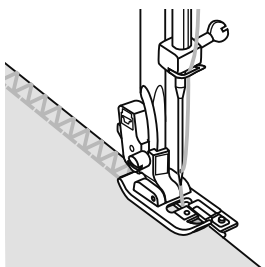
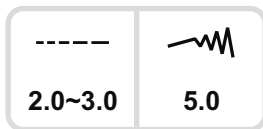
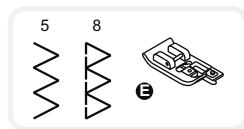

### ☒ Using the overcasting foot

Change the presser foot to the overcasting foot (E).

Sew the fabric with the fabric edge against the guide of the overcasting foot.

#### ⚠ Attention:

The overcasting foot should be used to sew with Direct Patterns 5 and 8 only and do not set the stitch width narrower than "5.0".

It is possible that needle could hit the presser foot and break when sewing other patterns and width.

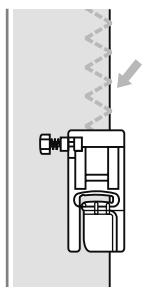
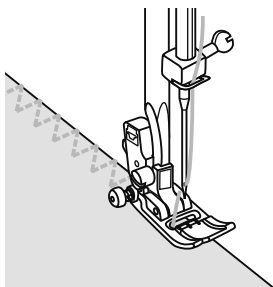
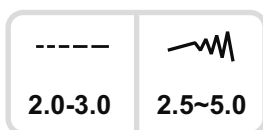
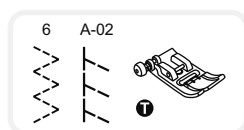

### ☒ Using the all purpose foot

Change the presser foot to the all purpose foot (T).

Sewing the overcasting along the edge of the fabric so that the needle drops over the edge of the fabric on the right side.

# Blind Hem

Secure the bottoms of skirts and pants with a blind hem, this stitch will sew without stitches showing on right side of fabric.

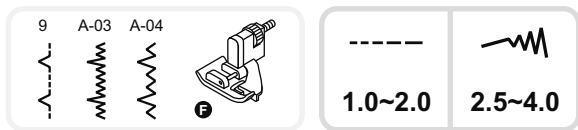

- 9 : Blind hem/ lingerie for firm fabrics
- A-03 : Blind hem for stretch fabrics
- A-04 : Blind hem for stretch fabrics

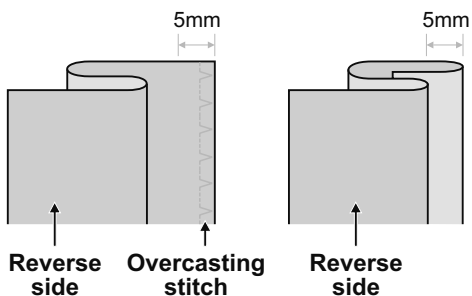

Fold the fabric as illustrated with the reverse side uppermost.

First carry out an overcasting stitch as shown in left picture.

**➡ Please Note:**

It takes practice to sew blind hem. Always make a sewing test first.

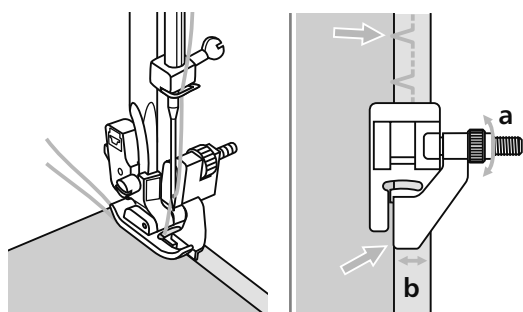

Place the fabric under the foot. Turn the handwheel forwards by hand until the needle swings fully to the left. It should just pierce the fold of the fabric. If it does not, adjust the stitch width accordingly.

Adjust the guide (b) by turning the knob (a) so that the guide just rests against the fold.

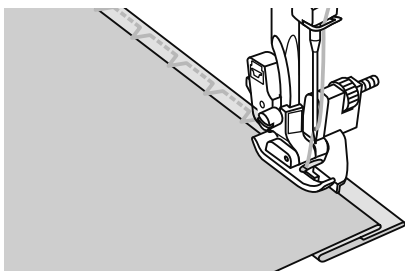

Sew slowly, guiding the fabric carefully along the edge of the guide.

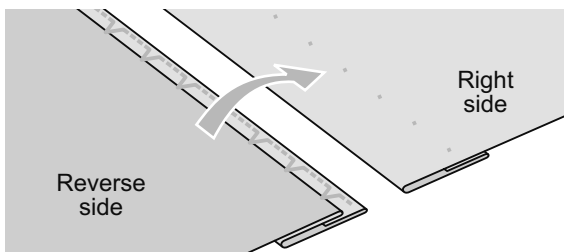

Turn over the fabric.



## Buttonhole stitch

Buttonhole sewing to match the size of the button is possible.

For stretch fabric or thin fabric, it is recommended to use a stabilizer for a better buttonhole finish.

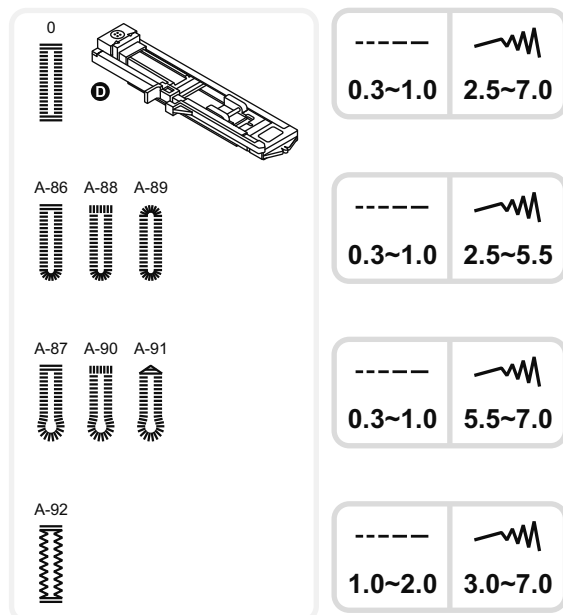

0 : For thin or medium fabric

A-86: For thin or medium fabric

A-88: For horizontal buttonholes on thick fabrics

A-89: For thin or medium fabric

A-87: For suits or overcoats.

A-90: For thick coats

A-91: For jeans or trousers

A-92: For jeans or stretch fabric with a coarse weave

### ➤ Please Note:

Before sewing a buttonhole on your project, practice on a scrap piece of the same type of fabrics.

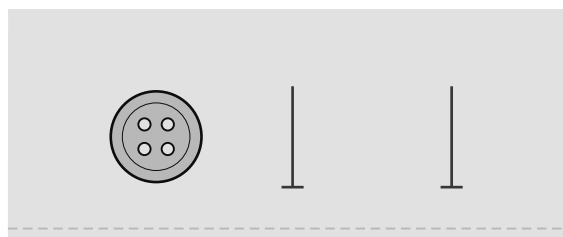

Mark the positions of the buttonhole on the fabric. The maximum buttonhole length is 3cm (1 3/16 inch). (Total of diameter + thickness of button.)

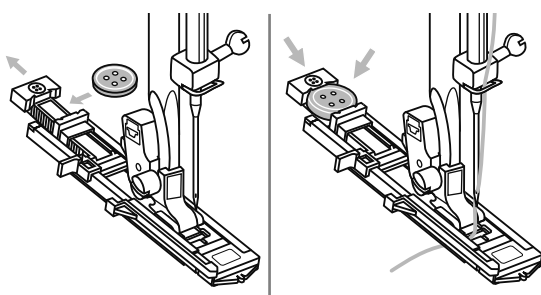

Attach the buttonhole foot, then pull out the button holder plate and insert the button.

The size of the buttonhole is determined by the button inserted in the button plate.

The thread should be passed through the hole in the presser foot, then be placed under the foot.

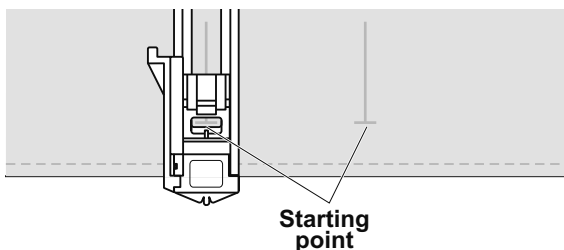

Select the buttonhole stitch.  
Adjust the stitch width and the stitch length to the desired width and density.  
Position the fabric under the presser foot with the front end of the buttonhole mark aligned with the center line on the buttonhole foot.

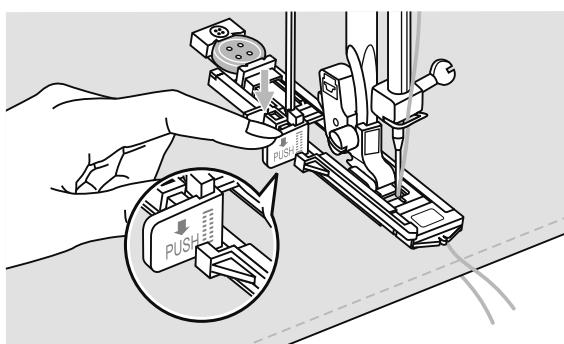

Pull the buttonhole lever all the way down and position it behind the bracket on the buttonhole foot.

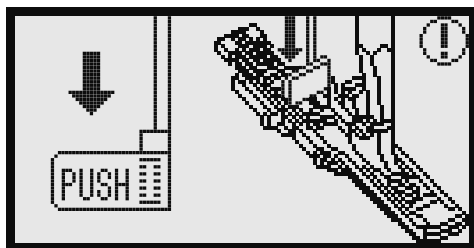

**Please Note:**  
The buttonhole stitch was selected and the start/stop button was pressed while the buttonhole lever is raised, the LCD will display the warning message to remind you to lower the buttonhole lever.

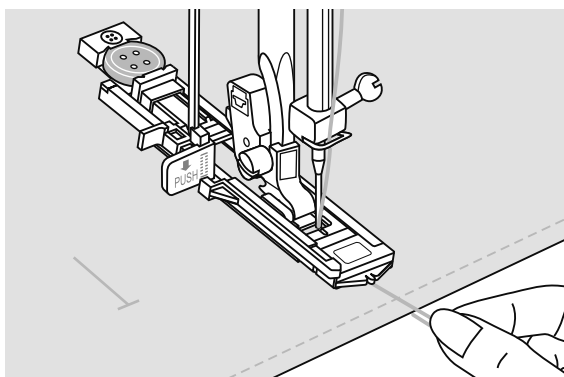

Before sewing, please hold the thread by hand.

**Please Note:**  
Gently feed the fabric by hand.  
Before stopping, the machine will automatically sew a reinforcement stitch after the buttonhole is sewn.



\* Buttonholes are sewn from the front of the presser foot to the back, as shown.

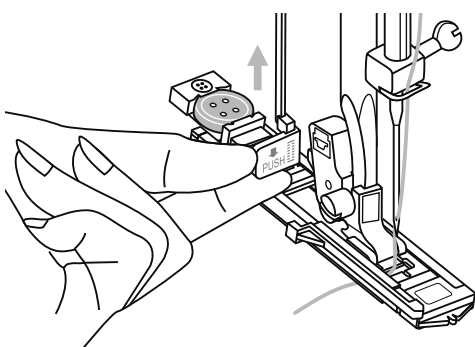
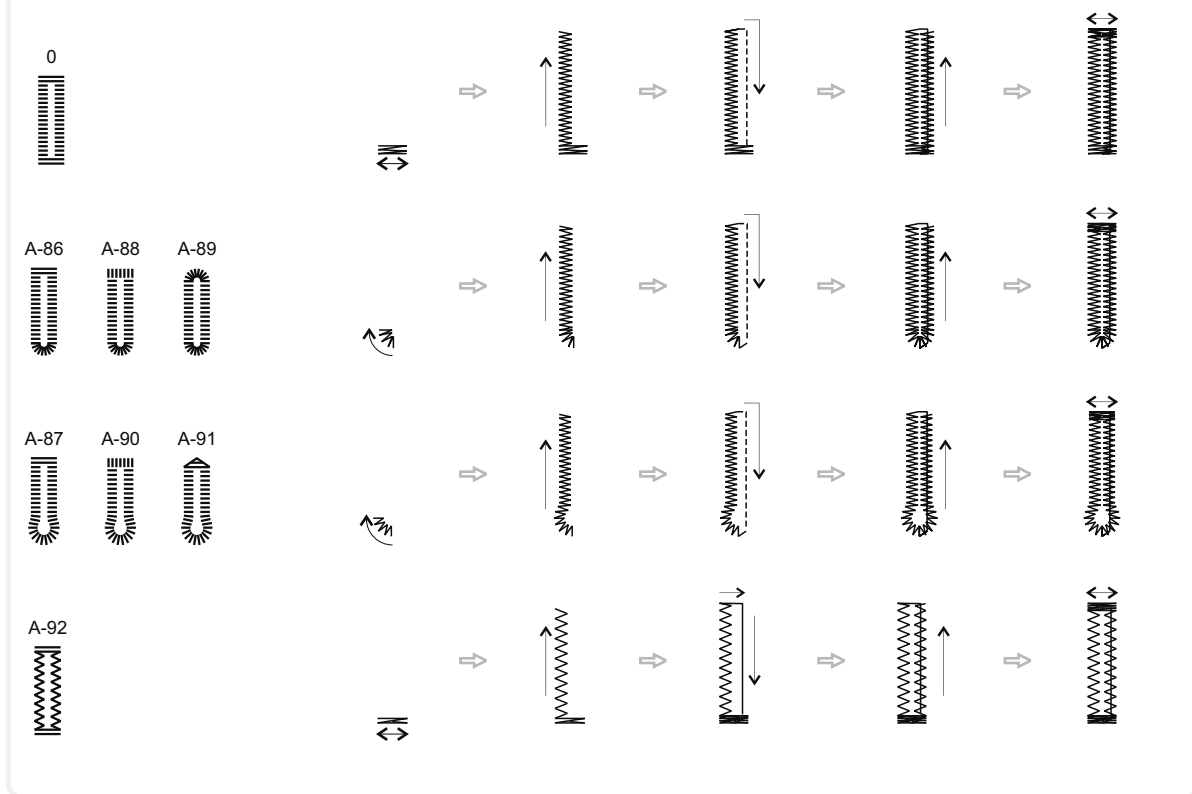

Raise the presser foot and cut thread.

To sew over same buttonhole, raise the presser foot (will return to original position).

After sewing the buttonhole stitch, raise the buttonhole lever until it stops.

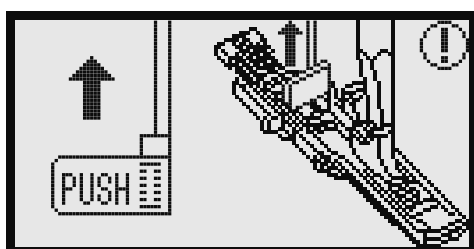

**Please Note:**

After finishing, the stitch other than the buttonhole, bar tack or darning stitch was selected and the start/stop button was pressed while the buttonhole lever is lowered, the LCD will display the warning message to remind you to raise the buttonhole lever.

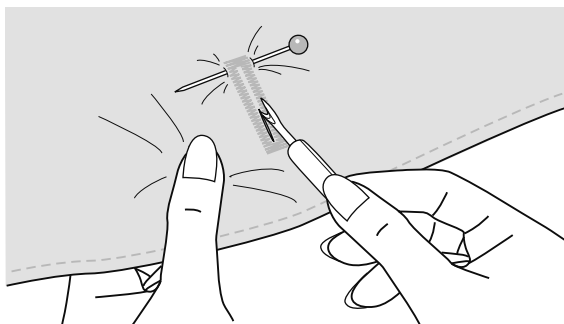

Cut the center of the buttonhole being careful not to cut any stitches on either side. Use a pin as a stopper at the bar tack so you do not cut too much.

**➔ Please Note:**

When cutting the buttonhole with the seam ripper, do not place your hands in the cutting direction, otherwise injuries may result.

**✘ Making a buttonhole on stretch fabrics**

When sewing buttonholes on stretch fabric, hook heavy thread or cord under the buttonhole foot.

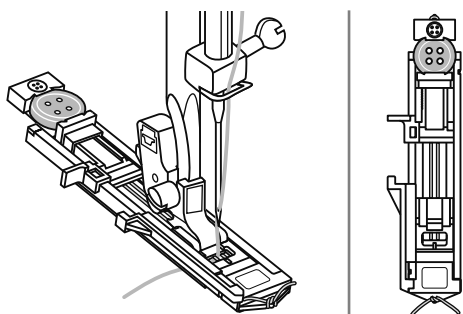

Attach the buttonhole foot and hook the gimp thread onto the back of the presser foot.

Bring the two gimp thread ends to the front of the foot and insert them into the grooves, then temporarily tie them there. Lower the presser foot and start sewing.

Set the stitch width to match the diameter of the gimp thread.

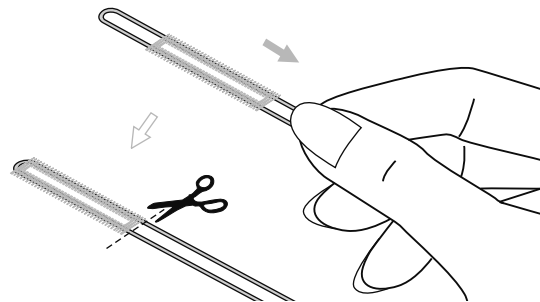

Once sewing is completed, pull the gimp thread gently to remove any slack, then trim off any excess.

**➔ Please Note:**

It is suggested that you use interfacing on the backside of the fabric.



# Bar tack stitch

Bar tack stitch is used to reinforce points subject to strain, such as pocket corners and openings.

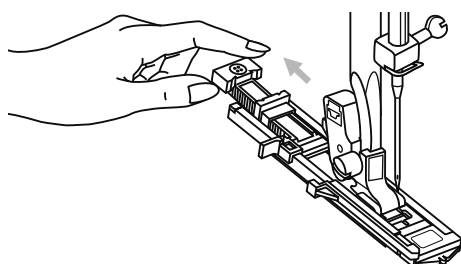
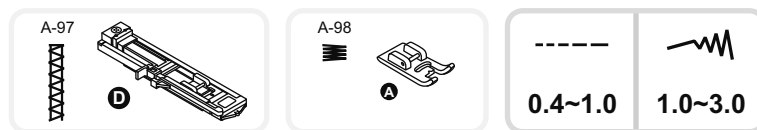

Extend the button holder plate and set to the desired bar tack length.

Adjust the stitch width and stitch length to personalize the stitches.

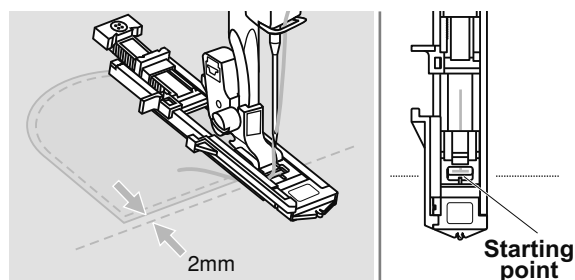

Position the fabric so that the needle is 2mm (1/16 inch) in front of the pocket opening, and then lower the presser foot lever.

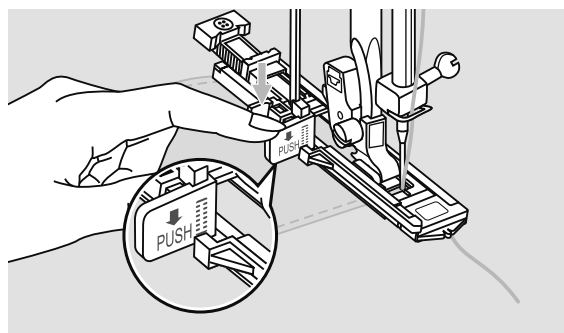

Pass the upper thread down through the hole in the presser foot. Pull down the buttonhole lever and position behind the bracket on the buttonhole foot. Gently hold the end of the upper thread in your left hand, and start sewing.

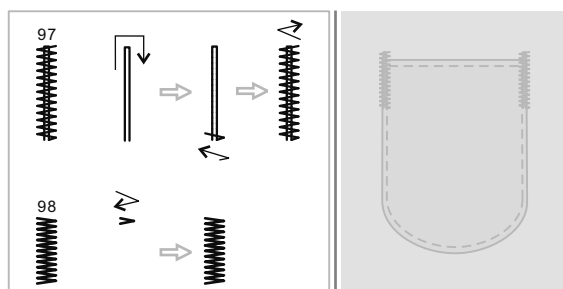

Sewing procedure for bar tack is illustrated. This is an example of sewn bar tacks at pocket corners.

 **Please Note:**

It is suggested that you use interfacing on the backside of the fabric.



## Eyelet stitch

Eyelet stitches are used for making belt holes and other similar applications.

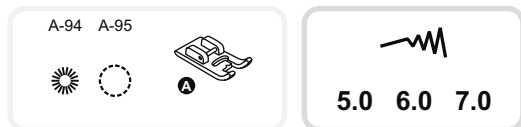

**A**



**B**



**C**



A-94 : Select for sewing eyelets on belts , etc

A-95 : Select for sewing eyelets on belts , etc

Press the "-" or "+" stitch width adjustment to button select the eyelet size.

Size of eyelet.

A. Small: 5.0mm (3/16 inch).

B. Medium: 6.0mm (15/64 inch).

C. Large: 7.0mm (1/4 inch).

Lower the needle into the fabric at the beginning of the stitching, and then lower the presser foot lever.

Once sewing is completed, the machine automatically sews reinforcement stitches, then stops.

Make a hole at the center using an eyelet punch.

\* Eyelet punch is not included with the machine.

### ➔ Please Note:

- When using the eyelet punch, place thick paper or some other protective sheet under the fabric before punching the hole in the fabric.
- If thin thread is used, the stitching may be coarse. If this occurs, sew the eyelet twice one on top of the other.

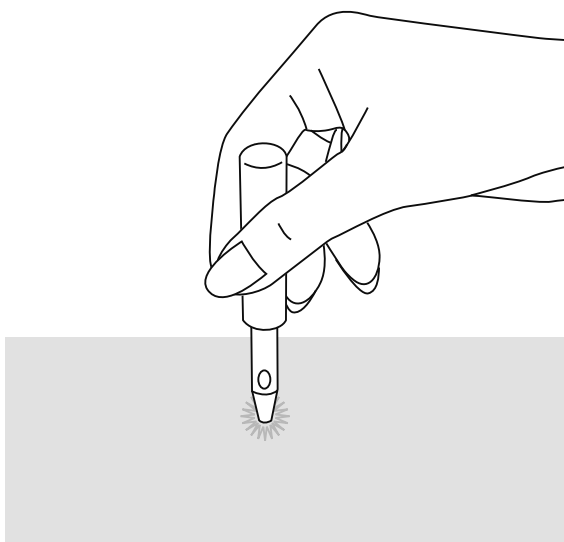



# Button sewing

A-96

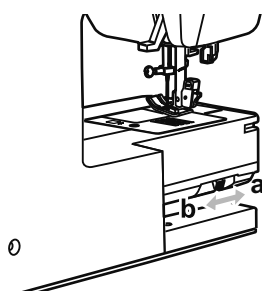

2.4~4.5

a b 

Change the presser foot to the button sewing foot.

Move the drop feed control to "  " to lower the feed dogs.

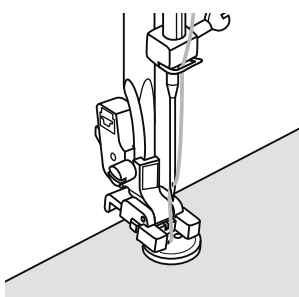

2.4~4.5

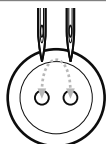

Position the work under the foot. Place the button in the desired position, lower the foot.

Select zig zag pattern. Adjust the stitch width to "2.5-4.5" according to the distance between the two holes of the button.

Turn the handwheel to check that the needle goes cleanly into the left and right holes of the button.

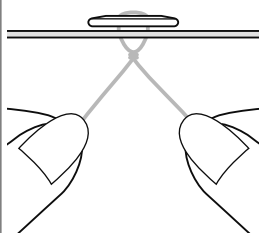
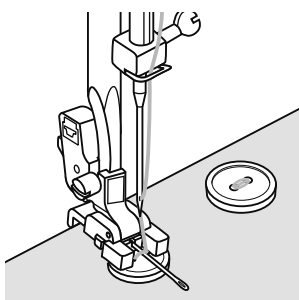

Before sewing, press the Auto-lock button to sew reinforcement stitches automatically at the beginning and at the end of the stitch.

If a shank is required (ex. sew on coats or jackets), place a darning needle on top of the button and sew.

Pull end of the upper thread to the wrong side of the fabric, then tie it with the bobbin thread.

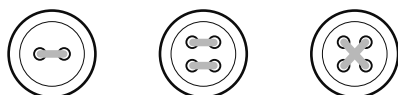

For buttons with 4 holes, sew through the front two holes first, push work forward and then sew through the back two holes.

### Please Note:

When you finish the work, move the drop feed control to "  " to raise the feed dogs.

# Darning stitch

Darning a small hole or a tear before it becomes larger can save a garment. Choose a fine thread in a color as close to your garment possible.

<p>A-93</p>  	<table border="1"> <tr> <td>---</td> <td>~~~~~</td> </tr> <tr> <td>1.0~2.0</td> <td>3.5~7.0</td> </tr> </table>	---	~~~~~	1.0~2.0	3.5~7.0
---	~~~~~				
1.0~2.0	3.5~7.0				

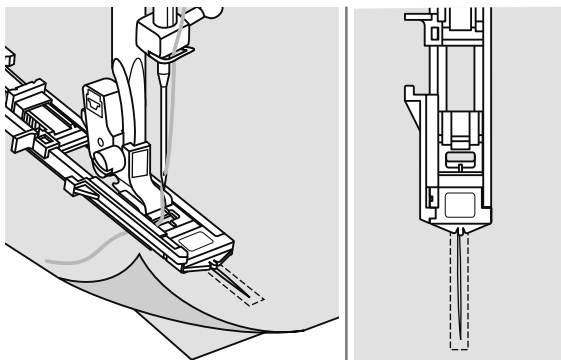

Baste the upper fabric and the under fabric together.  
 Select the needle position. Lower the presser foot over the center of the tear.

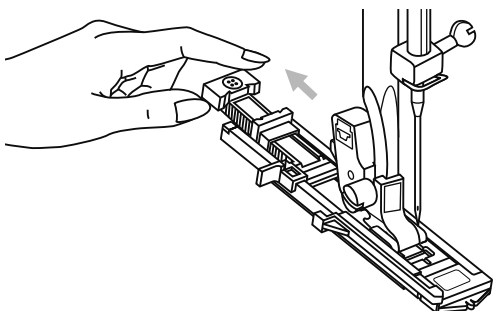

Pull the button holder to rear.  
 Set the button guide plate on buttonhole foot to the desired length.

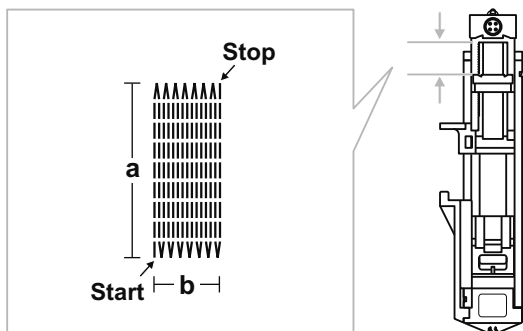

The size of one darn cycle is variable.  
 However, the maximum stitch length is 2.6cm (1 inch) and the maximum stitch width is 7mm (9/32 inch).

- a. The length of sewing.
- b. The width of sewing.

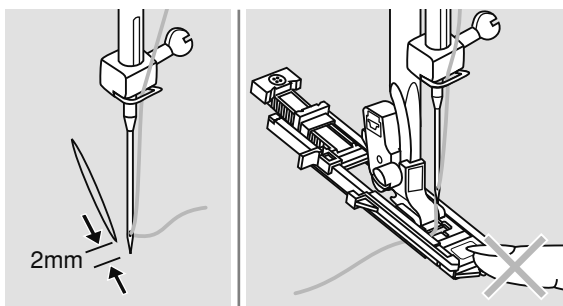

Position the fabric so that the needle is 2mm (1/16 inch) in front of the area to be darned, and then lower the presser foot lever.

➔ **Please Note:**

When lowering the presser foot, do not push in the front of the presser foot, otherwise the darning will not be sewn with the correct size.

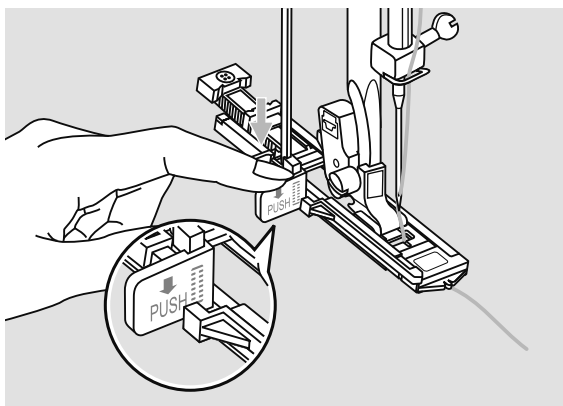

Pass the upper thread down through the hole in the presser foot.

Pull down the buttonhole lever.

The buttonhole lever is positioned behind the bracket on the buttonhole foot.

Gently hold the end of the upper thread in your left hand, and then start sewing.

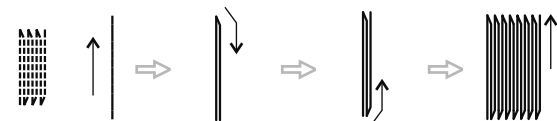

Darning stitches are sewn from the front of the presser foot to the back, as shown.

➔ **Please Note:**

If the fabric does not feed, for example, because it is too thick, increase the stitch length.

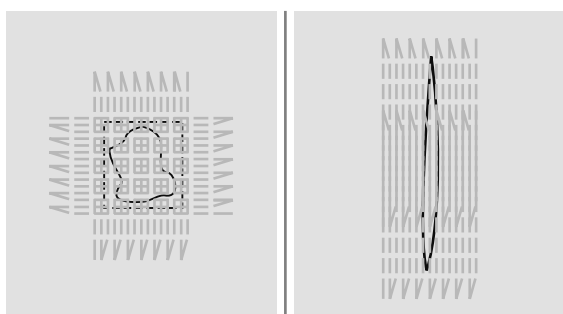

If the sewing range is too big to sew, then we suggest you can sew several times (or cross sew) to get better sewing result.

# Zipper Insertion

This foot can be set to sew on each side of the zipper, the The edge of the foot guides the zipper to ensure straight placement.



## ! Attention:

Zipper foot should be used for sewing width center needle position straight stitch only. It is possible that needle could hit the presser foot and break when sewing other patterns.

## ✘ Inserting a centered zipper

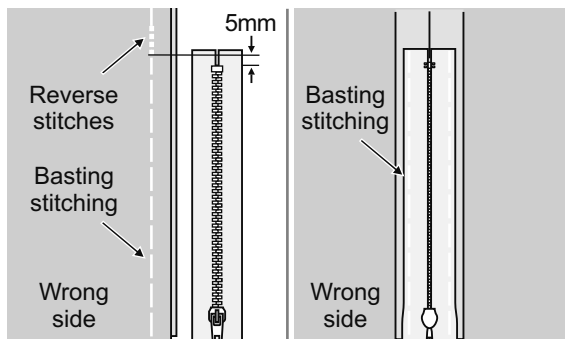

- Baste the zipper opening on the garment.

- Press open the seam allowance.

Place the zipper face down on the seam allowance with the teeth against the seam line. Baste the zipper tape.

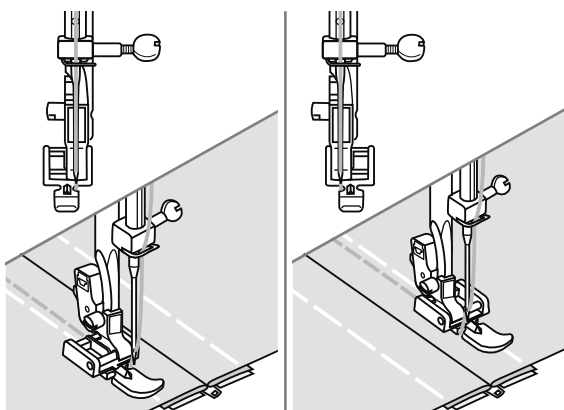

- Attach the zipper foot. Attach the right side of the presser foot pin to the holder when sewing the left side of the zipper.

- Attach the left side of the presser foot pin to the presser foot holder when sewing the right side of the zipper.

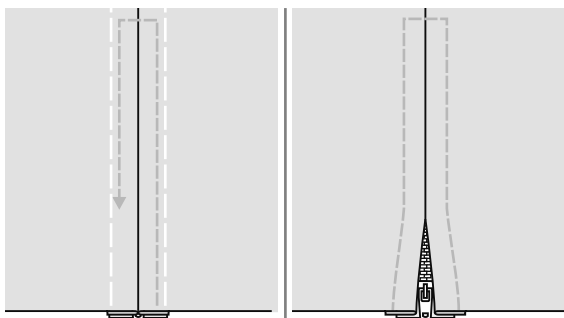

- Stitching around the zipper.

## ➡ Please Note:

When sewing, be sure that the needle does not touch the zipper, otherwise the needle may bend or break.

- Remove the basting and press.



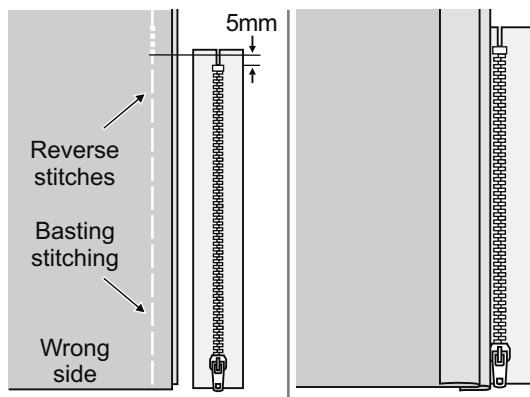

### ✘ Inserting a side zipper

- Baste the zipper opening on the garment.
- Fold back to the left seam allowance. Turn under the right seam allowance to form 3mm fold.

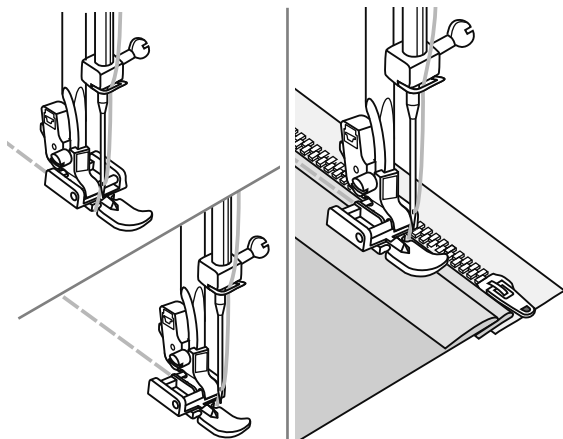

- Attach the zipper foot. Attach the right side of the presser foot pin to the holder when sewing the left side of the zipper. Attach the left side of the presser foot pin to the presser foot holder when sewing the right side of the zipper.

- Stitch the left side of zipper from bottom to top.

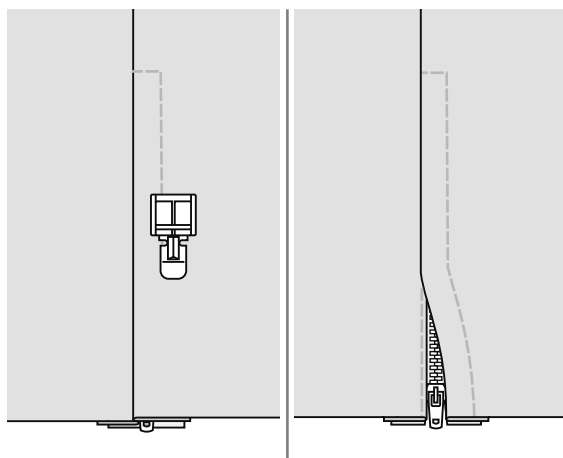

- Turn the fabric right side out, stitch across the lower end and right side of zipper.

- Stop about 5cm (2 inches) from the top of zipper. Remove the basting and open the zipper. Stitch the remainder of the seam.



## Narrow hemming

The hemmer foot is used to stitch the narrow rolled hems usually found on shirt tails, table linens and along the edge of frills.



\* The hemmer foot accessory is optional. It is not included with this machine.

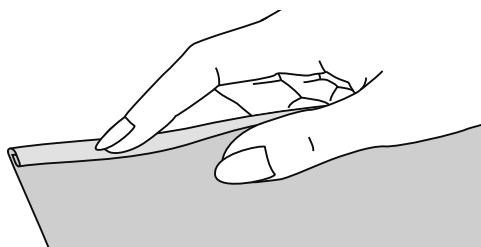

Fold edge of fabric over about 3mm, then fold it over again 3mm for about 5cm along the edge of the fabric.

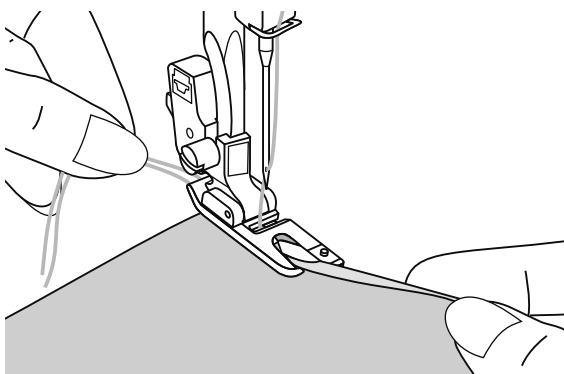

Insert the needle into the fold by rotating the handwheel toward you, and lower the presser foot. Sew several stitches and raise the presser foot.

Insert the fabric fold into the spiral opening of hemmer foot. Move fabric back and forth until the fold forms a scroll shape.

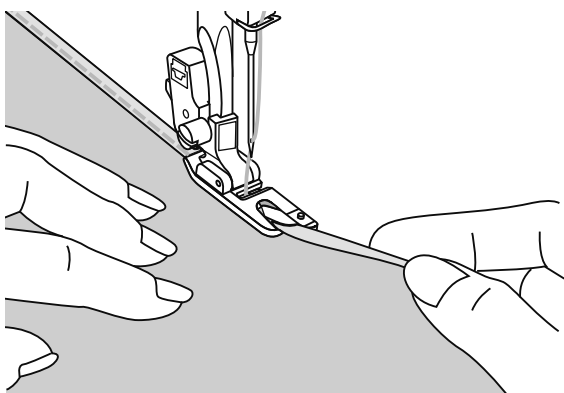

Lower the presser foot and start sewing slowly guiding the raw edge of the fabric in front of the hemmer foot evenly into the scroll of the foot.

# Cording

Used for embellishing 1 to 3 cords or decorative threads.

Sew over one strand of cording to create a pretty swirled design on a jacket or vest or sew over three strands of cording for border trims. Pearl cotton, knitting yarn, embroidery floss, lace thread, fine wool or lily yarn can be used for cording.

\* The cording foot accessory is optional. It is not included with this machine.

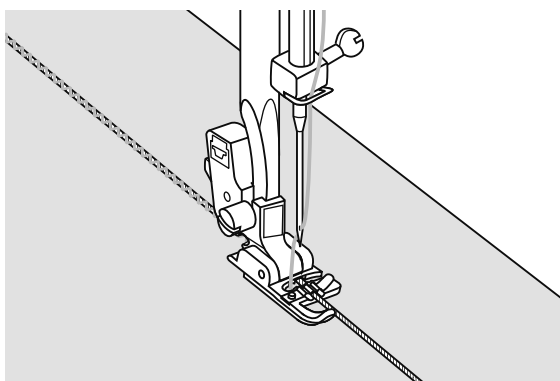
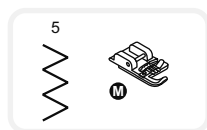

## ☒ Single cording

Mark the design on the fabric. Insert the cord in the center groove of the cording foot from the right side opening. Pull the cord about 5cm (2 inches) behind the foot.

The grooves under the foot will hold the length of the cord in place while the stitches are being formed over the cord.

Select the stitch and adjust the stitch width so that the stitches are just covering the cord. Lower the foot and sew slowly, guiding the cord over the design.

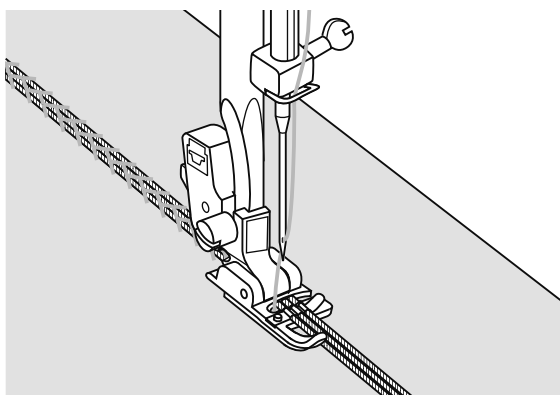
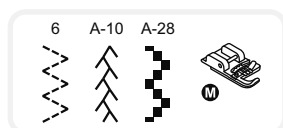



## ☒ Triple cording

Push the sewing thread to the left and insert three cords into the grooves of the foot and pull about 5cm (2 inches) of the cords behind the foot.

Select the desired pattern and adjust the stitch width so that the stitches are just covering the cords. Lower the foot and sew slowly guiding the cords.

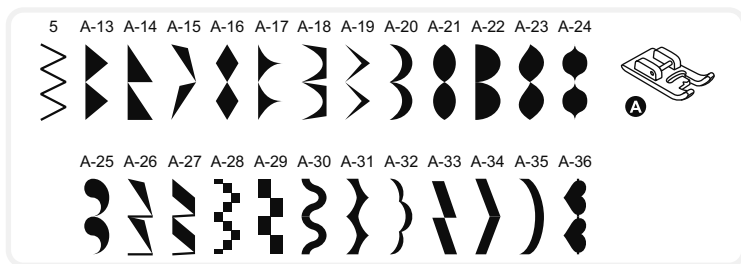
# Satin stitch sewing



-----	
0.3~2.0	2.5~7.0

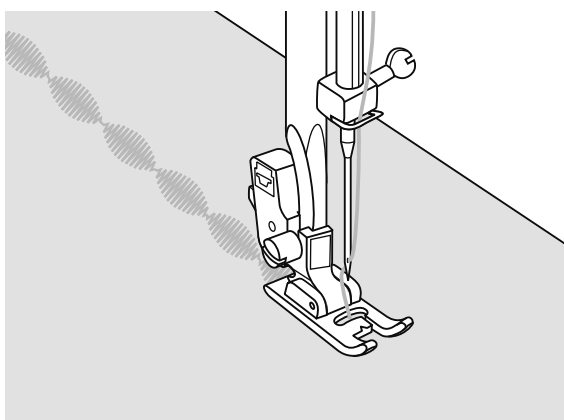

Use the satin stitch foot for satin stitching and sewing decorative stitches. This foot has a full indentation on the underside to allowed easy sewing over the thickness of the stitches form by closely spaced zigzag stitches, and even feeding of the fabric.

To tailor the satin or decorative stitch pattern, you may adjust the length and width of the pattern by pressing the stitch length and width adjustment buttons. Experiment with fabric scraps until you get the desired length and width.

**➔ Please Note:**

When sewing very thin fabrics, it is suggested that you use interfacing on the backside of the fabric.



# Gathering

The Gathering Foot is used for gathering fabrics. Ideal for clothing as well as home decor, works best on thin to medium weight fabrics.



\* The Gathering foot accessory is optional. It is not included with this machine.

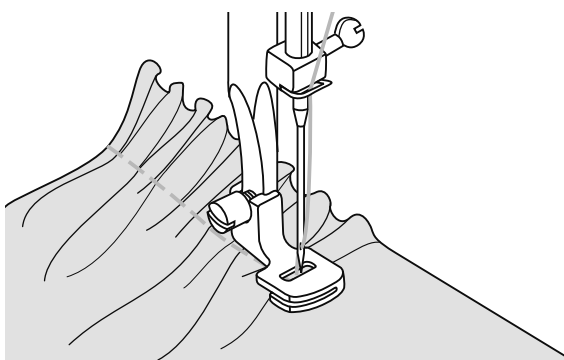

## Gathered fabric

Remove the presser foot holder and attach the gathering foot, lowering the tension setting to below 2.

Place fabric to be gathered under presser foot to the right of the presser foot.

Sew a row of stitching, keeping the raw edge of fabric aligned with the right edge of foot.

The stitches automatically cause the fabric to gather. Suitable for light to medium weight fabrics.

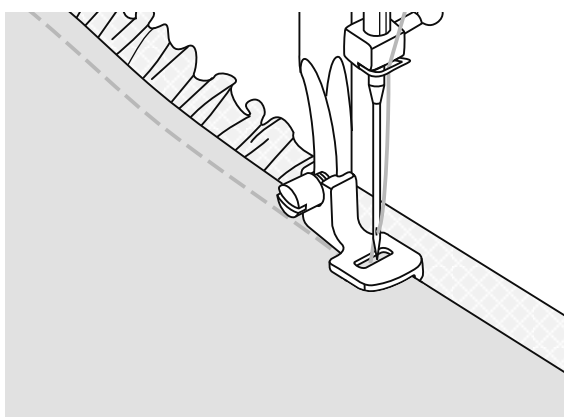

## To gather and attach gathered fabric in one step

Look closely at the gathering foot to see a slot on the bottom.

When using the slot, you can gather the bottom layer of the fabric while attaching it to a flat top layer, such as the waistband on a dress bodice.

- Remove the presser foot holder and attach gathering foot.
- Place the fabric to be gathered with right side up under the foot.
- Place top layer of the fabric right side down in the slot.
- Guide the two layers as illustrated.

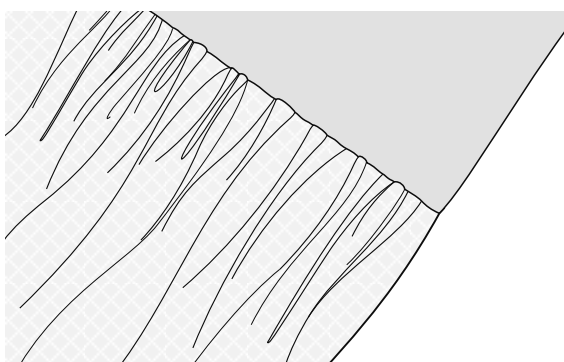

## Note:

- When testing machine for adjustments to achieve desired fullness, work with 10" increments of the fabric, trims or elastic. This makes it easier to determine the adjustments and how much change is needed for your project. Always test on your project fabric and on the same grainline as will be used in your finished project.
- Sew slow to medium speed for better fabric control.



## Smocking

The decorative stitch created by stitching or embroidering over gathers is called "smocking". It is used to decorate the front of blouses or cuffs. The smocking stitch adds texture and elasticity to fabric.

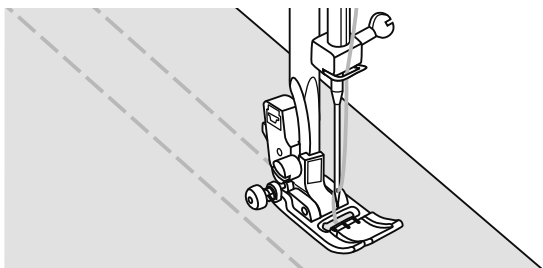
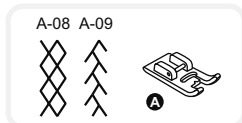

Use the all purpose foot to sew straight lines 1cm (3/8 inch) apart, across the area to be smocked.

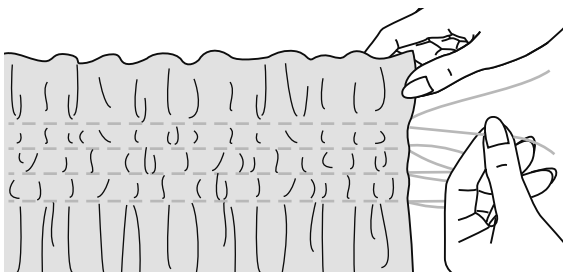

Knot the threads along one edge.  
Pull the bobbin threads and distribute the gathers evenly. Secure the threads at the other end.

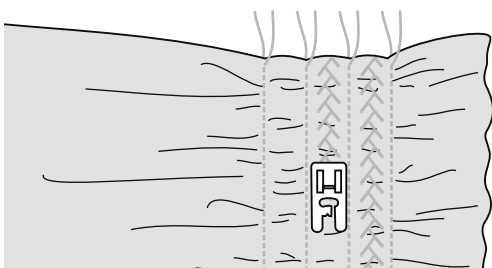

Reduce the tension, if necessary and sew decorative pattern stitches between the straight seams.

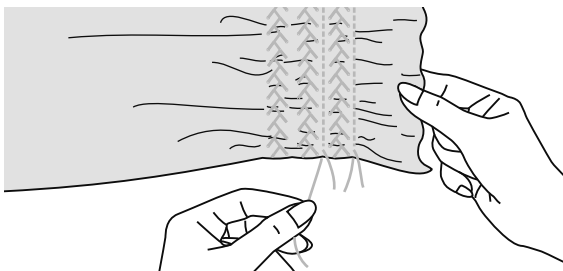

Pull out the gathering stitches.

# Free motion darning, embroidery and monogramming

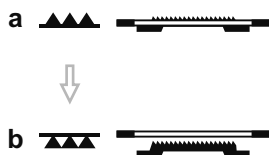
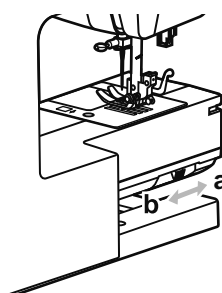
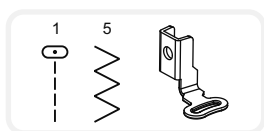

Move the drop feed control to "▲▲▲" to lower the feed dogs.

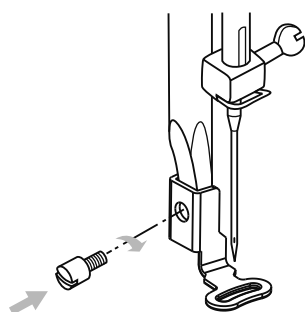

Remove the presser foot holder, and attach the embroidery foot to the presser foot holder bar. Press the embroidery foot on firmly from behind with your index finger and tighten the screw.

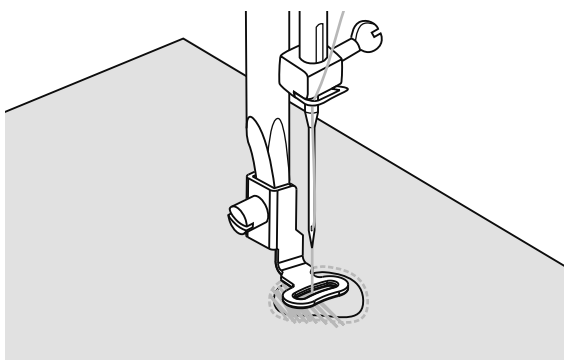

## ☒ Darning

First sew around the edges of the hole (to secure the threads). Working from left to right, sew over the hole in a constant and continuous movement.

Turn the work by 1/4 and sew over the first stitching moving the work slower over the hole to separate the threads and not form big gaps between the threads.

## ➔ Please Note:

Free motion darning is accomplished without the sewing machine internal feed system. Movement of the fabric is controlled by the operator. It is necessary to coordinate sewing speed and movement of fabric.

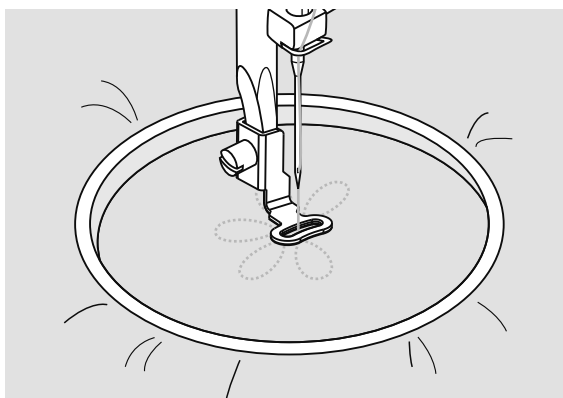

### ✘ Embroidery

Select zigzag stitch pattern and adjust the stitch width as desired.

Stitch along the outline of the design by moving the embroidery hoop. Make sure to maintain a constant speed.

Fill in the design working from the outline towards the inside. Keep the stitches close together.

You will get longer stitches by moving the hoop faster and shorter stitches by moving the hoop more slowly.

Secure with a reinforcement stitches at the end by press Auto-lock button.

### ✘ Monogramming

Select the zigzag stitch pattern and adjust the stitch width as desired. Sew at a constant speed, moving the hoop slowly along the lettering.

When the letter is finished. Secure with a reinforcement stitches at the end by press Auto-lock button.

\* Embroider hoop is not included with the machine.

➔ Please Note:

When you finish the work, move the drop feed control to "▲▲▲" to raise the feed dogs.





# Quilting

Sandwiching batting between the top and bottom layers of fabric is call "Quilting". The top layer is usually formed by multiple geometrically shaped pieces of materials joined together.

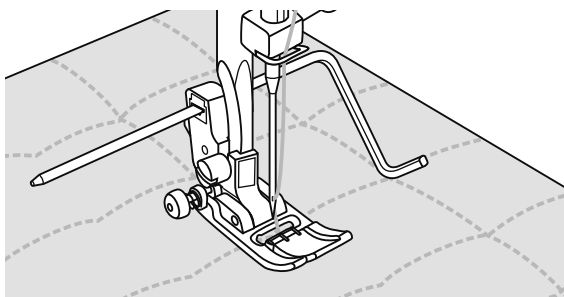
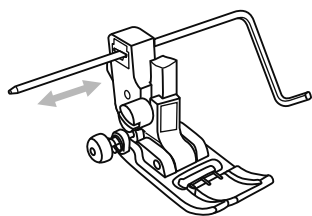
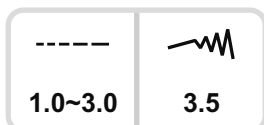

## ☒ Attaching the edge/ quilting guide

\* The Quilting foot accessory is optional. It is not included with this machine.

Insert the edge/quilting guide in the presser foot holder as illustrated and set the space as you desire.

Sew the first row and move over the fabric to sew successive rows with the guide riding along the previous row of stitching.

## ➡ Note:

When using the quilting foot, only use center needle position stitches to prevent machine damage.

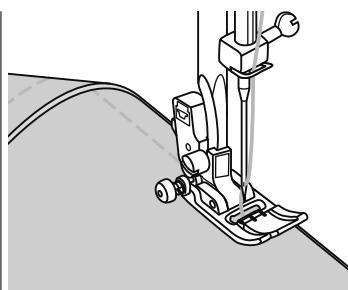
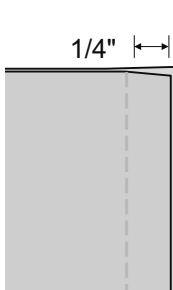
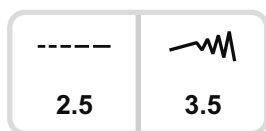
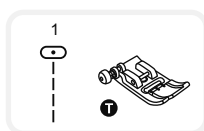

## ☒ Joining the pieces of the fabric

Place the two pieces of fabric with the right side together and sew with the straight stitch. Join the pieces of fabric with a seam allowance of 1/4".

Sew with the side of the presser foot aligned with the edge of the fabric.

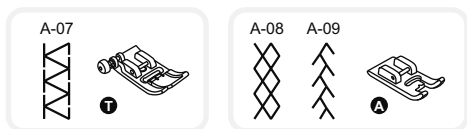

### ✦ Patchwork stitching

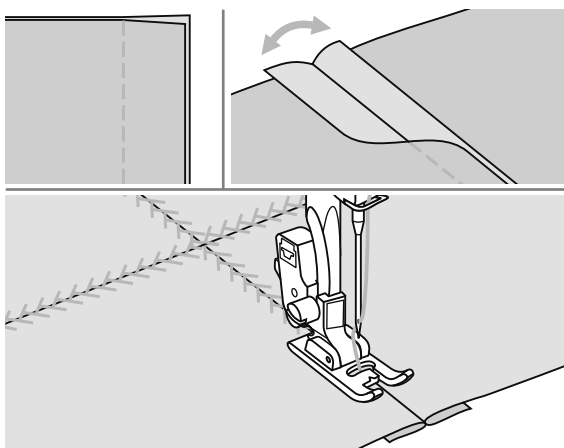

Open the seam allowances and presses it flat.

Place the center of the presser foot on the seam line of the joined pieces of fabric and sew over the seam.

## Fagoting

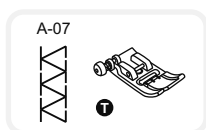

Stitching across an open seam is called "fagoting". It is used on blouses and children's clothing. This stitch is more decorative when thicker thread is used.

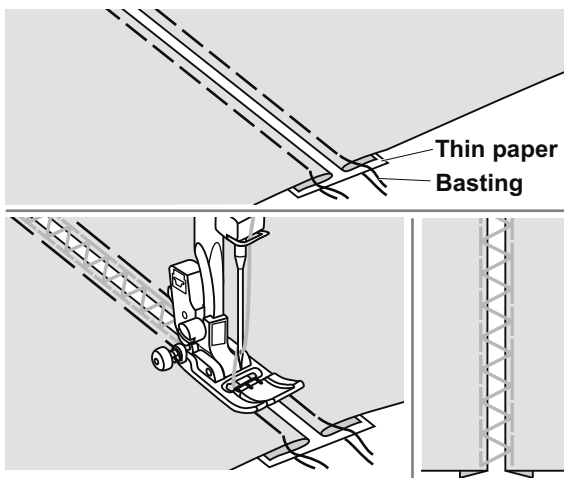

- Separate the folded edges of the fabric pieces with a gap of 4mm (1/8 inch) and baste them onto a piece of thin paper or water-soluble stabilizer sheet.

- Align the center of the presser foot with the center of the two pieces of fabric and begin sewing.

- After sewing, remove the paper.



# Scalping

The wave-shaped repeating pattern that looks like shells is called "scalping". It is used on the collars of blouses and to decorate the edges of projects.

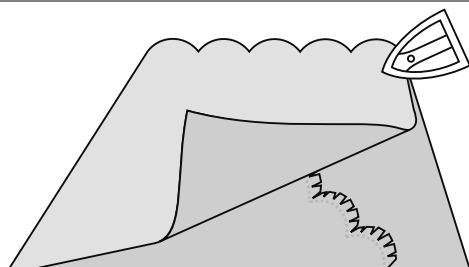
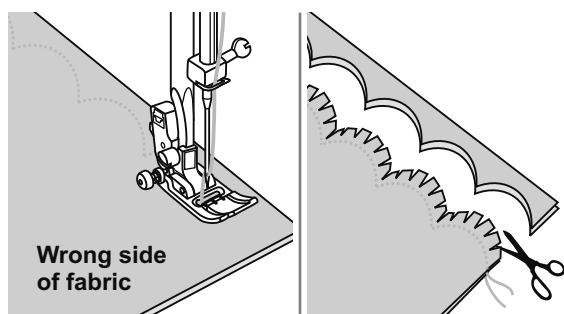
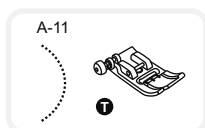

## ☒ Scallop hem

- Fold the fabric right side together in and sew along the edge.
- Cut the fabric along the seam leaving an allowance of 3mm (1/8 inch) for seaming. Notch the allowance.
- Turn the fabric over and push out the curved seam to the surface and iron it.

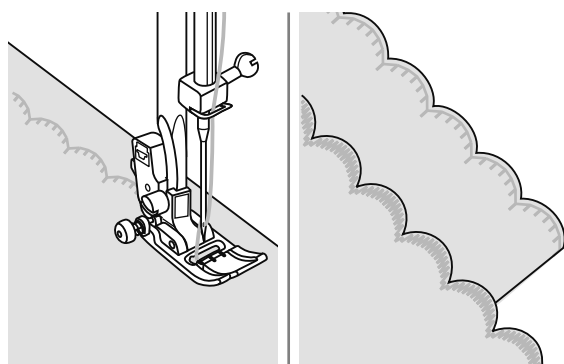
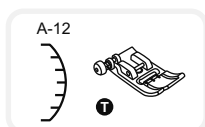

## ☒ Scallop edging

- Stitch along the edge of the fabric, marking sure not to sew directly on the edge of the fabric.
  - \* For better results, apply spray starch onto the fabric and press with a hot iron before it is sewn.
- Trim along the stitches.
  - \* Be careful not to cut the stitches.



## Walking foot

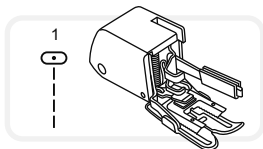

\* The walking foot accessory is optional. It is not included with this machine.

**Always try to sew first without the walking foot accessory which should be used only when necessary.**

It is easier to guide the fabric and you have a better view of the seam when using the standard, regular foot on your machine. Your sewing machine offers excellent stitch quality on a wide range of fabrics from delicate chiffons to multiple layers of denim.

The Walking Foot accessory equalizes the feeding of the upper and lower layers of fabric and improves the matching of plaids, stripes and patterns. It also helps to prevent uneven feeding of very difficult fabrics.

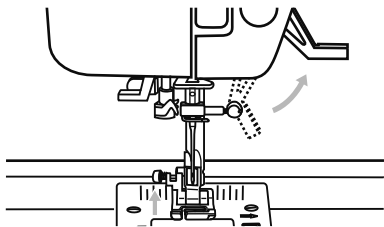

Lift the presser foot lifter to raise the presser foot bar.

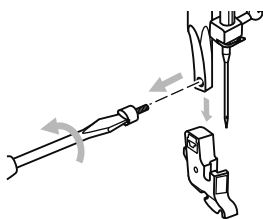

Remove the presser foot holder by unscrewing (counterclockwise) the presser bar attaching screw.

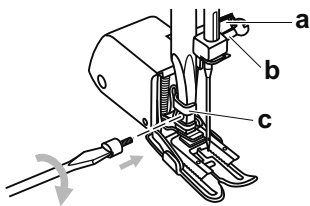

Attach the Walking Foot to the machine as follows:

- The arm (a) should fit into above the needle screw and clamp (b).
- Slide the plastic attaching head (c) from your left to right so that it is fitted into the presser foot bar.
- Lower the presser foot bar.
- Replace and tighten (clockwise) the presser bar attaching screw.
- Make sure both the needle screw and the presser bar attaching screw are tightly secured.

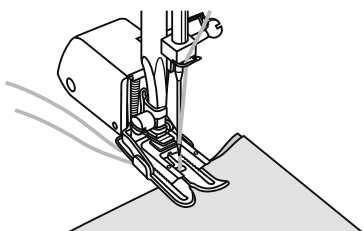

Draw the bobbin thread up and place both the bobbin thread and the needle thread behind the walking foot attachment.



# Mirror

➔ **Please Note:**

- Direct Patterns 0 and Patterns 86-98 from Group Pattern "A" cannot be mirror imaged.
- Mirror imaged patterns can also be combined with other patterns.

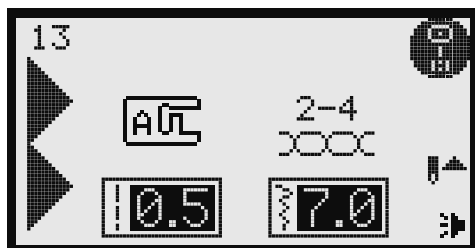

Select the stitch.

Pressing the mirror button .

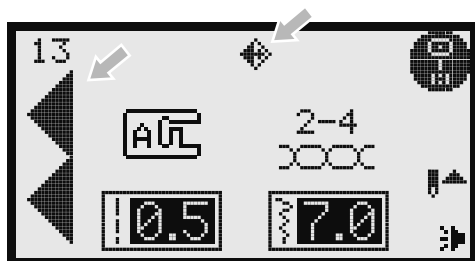

The LCD display icon for mirror imaging of the pattern appears.

The machine will continue to sew the reflected pattern until the mirror button is pressed again or the pattern is changed.



**A**





**B**

A. Normal pattern sewing.

B. Mirror pattern sewing.

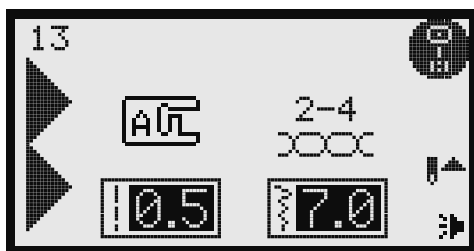
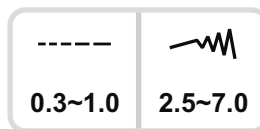
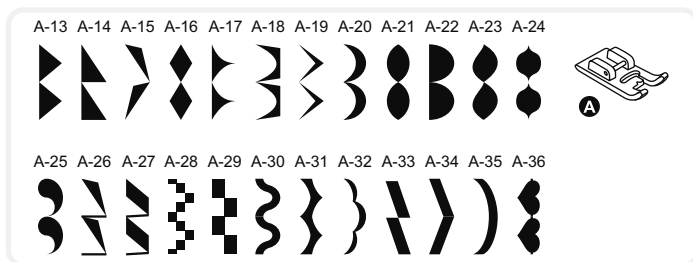
# Elongation



The stitch can be elongated up to five times its normal length by pressing the elongation button .

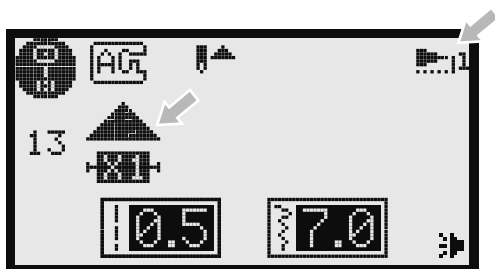

Press the elongation button.  
The symbol for elongation appears on the LCD display.  
Press the elongation button several times to adjust the elongation as desired.  
The machine will continue to sew the displayed pattern until the elongation button is pressed again or the pattern is changed.

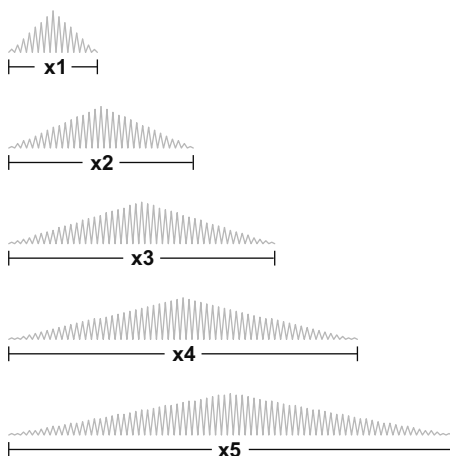

When the width or length or stitch is changed, a greater variety of patterns are available.

**➔ Please Note:**  
A Group Patterns 13-36 can be elongated and mirrored simultaneously.

# Using the twin needle

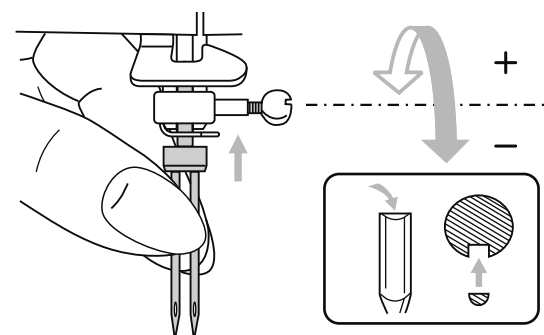

\* The twin needle is optional. It is not include with the accessories.

Insert the twin needle.

### ⚠ Attention:

When using twin needles, use the all purpose foot (T) regardless of what kind of sewing foot will be carried out.

Use only twin needle assemblies with max. 2mm needle distance.

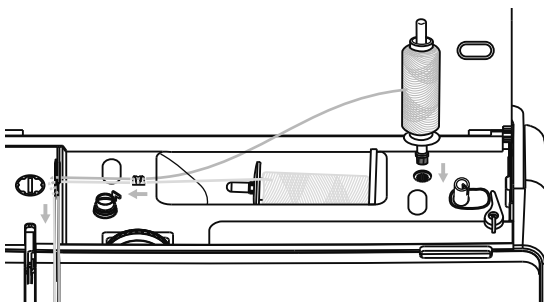

Follow the instructions for single-needle threading using the horizontal spool pin. Thread through the left needle.

Set the second spool pin into the hole on the top of the machine. Thread through remaining points, making certain to omit the thread guide above the needle and pass thread through the right needle.

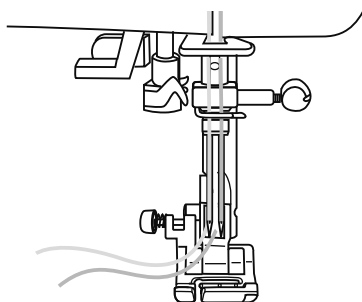

Thread each needle separately.

### ➡ Please Note:

Make sure that the two threads used to thread the twin needle are of the same weight. You can use one or two colors

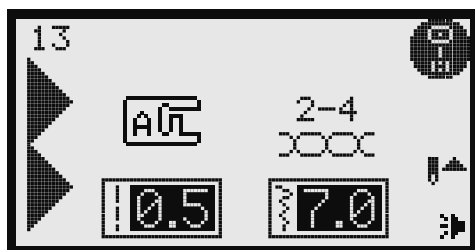

Select a stitch pattern. (e.g. A group patter 27) Except the Direct Pattern 0 and Patterns 86-98 from Group Pattern "A", the other patterns can be used.

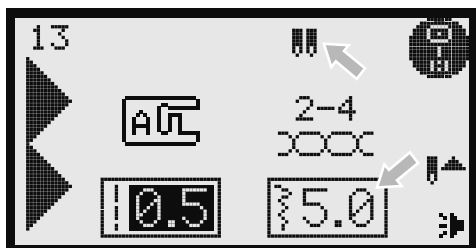

Press the twin needle button "  ".

The LCD display will display the twin needle icon "  " and the machine automatically reduces the maximum width for twin needle sewing by 2mm.



Two lines of stitching are sewn parallel to each other.

 **Please Note:**

- When sewing with twin needle, always proceed slowly, and make sure to maintain a low speed to insure quality stitching.
- When double needle sewing has been selected, it will remain active even the stitch pattern is changed. To deactivate double needle sewing press the double needle button again.









# Memory

Combined patterns can be stored for later use. Since stored patterns are not lost after the sewing machine is turned off, they can be recalled at any time. This is convenient for patterns, such as names, that will be used often.

## ➔ Please Note:

- Multiple patterns selecting from pattern groups , , ,  can be combined together.
- Direct Patterns 0 and Patterns 86-98 from Group Pattern "A" cannot be entered into memory.
- This machine has 4 modules of program memory and each module can retain 20 units of stitches.
- All the units in the memory can be edited to set its function such as Stitch length, Stitch width, Elongation, Mirror, and Auto-lock.

## ☒ Combining patterns

To store the combination of characters or decorative stitches.

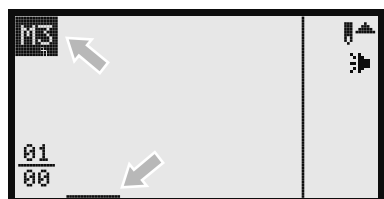
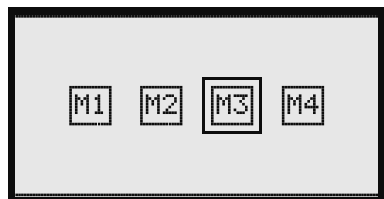
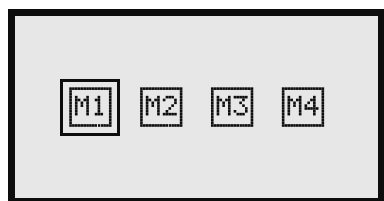
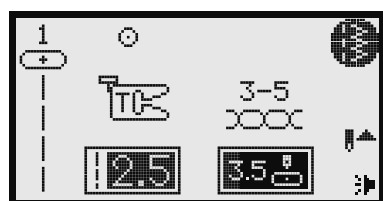

1. Press the memory button to enter the memory mode.

If you want to leave the memory module display, press the clear/ return button to return the normal display.

2. Use the arrow buttons to select the number of the memory module. (For example: M3)

3. Press the OK button, The memory display is entered automatically and the flashing cursor is in position for the first pattern to be entered.

Upper left corner of LCD display shows the number of the memory module.

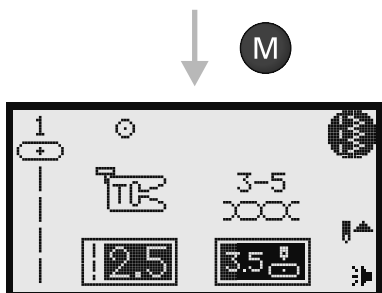
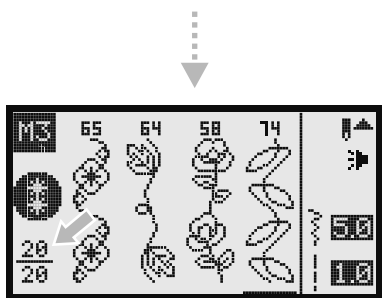
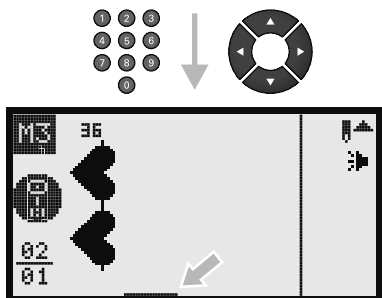
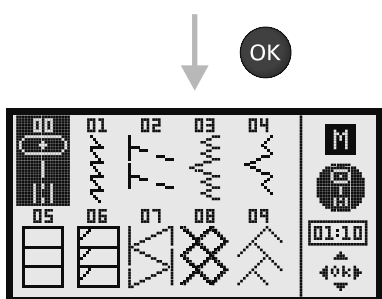
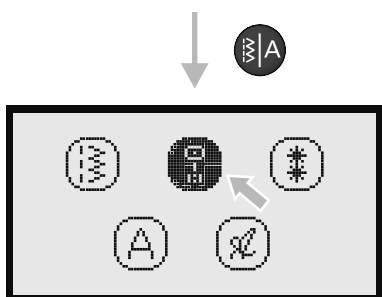

4. Press the pattern group selection button to enter the pattern group selection display.

Select the desired pattern group.

(E.g.  For pattern group "A")

5. Press the OK button to enter pattern browser, the display containing the various stitches in the selected pattern group appears.

6. Press the desired pattern number or the arrow buttons to select desired pattern. (For example: A group pattern 36)

The selected pattern displays on the LCD display and the cursor moves to the next position.

7. Repeat step 4~6 for more patterns to be stored in the memory.

When 20 patterns have been selected, the memory will be full. If another pattern is selected after the memory is full the machine will beep to prompt it.

8. Press the memory button to leave the memory mode and return to the normal mode.

**⚠ Attention:**

The selected pattern will be cleared from the memory module after closing the machine if you do not press the memory button again when you have completed your selection.

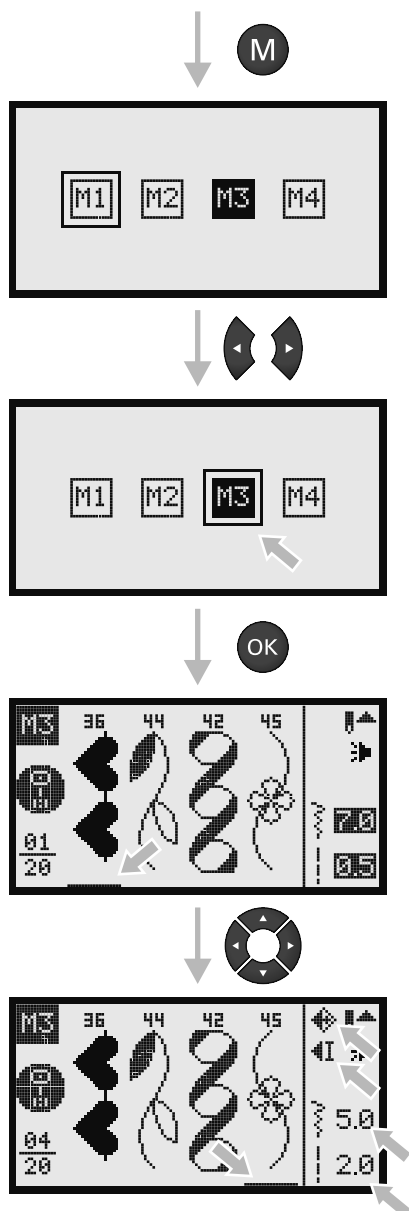

### ✘ Editing patterns

1. Press the memory button to enter the memory mode.

2. Use the arrow buttons to select the number of the memory module. (For example: M3)

3. Press the OK Button, the LCD display containing the various types of stitches will open and the cursor stay in 1st position.

4. Use the arrow buttons to select the pattern that you wish to edit while in the memory mode.  
The stitch length, stitch width, Elongation, Mirror imaging and Auto-lock of the patterns can be adjusted.

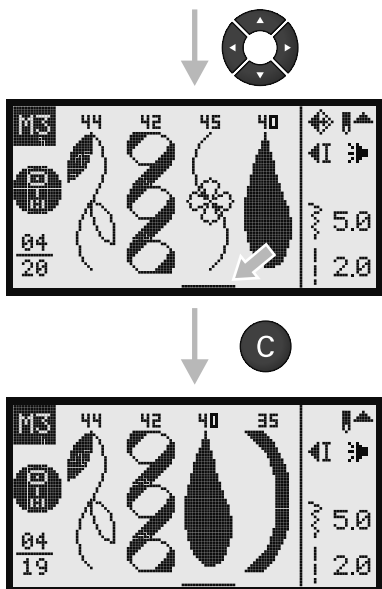

### ☒ Clearing patterns

1. Use the arrow buttons to move the cursor to the pattern that you want to delete.
2. Press the clear/ return button to delete the selected pattern and all patterns in the back will be moved one memory position forward.

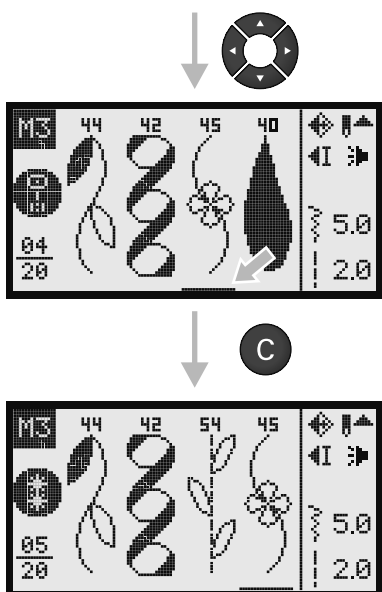

### ☒ Adding patterns

1. Use the arrow buttons to move the cursor to the pattern that you want to delete.
2. Press the desired pattern number or the arrow buttons to select desired pattern. (For example: B group pattern 54) All patterns in the back will be moved one memory position backward.

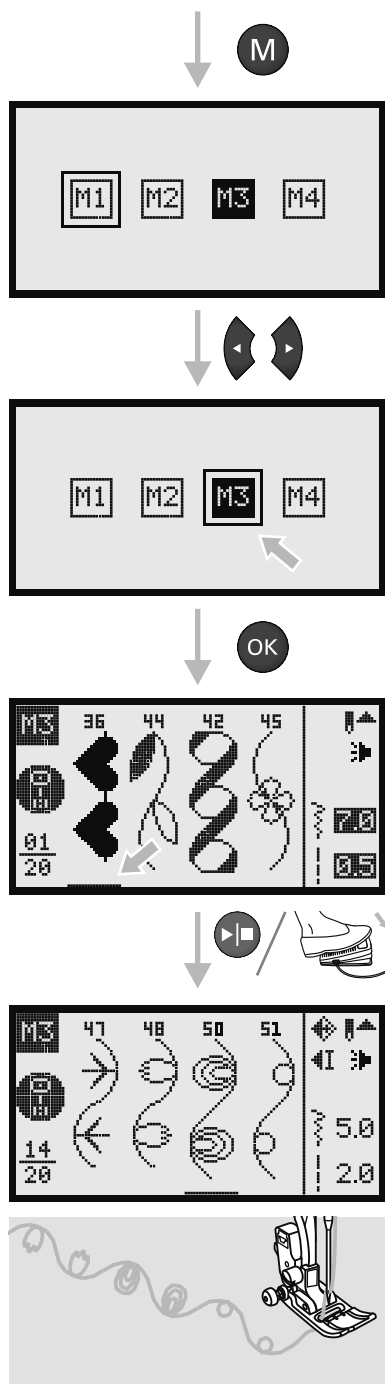

## ☒ Recalling and sewing the memorized pattern

1. Press the memory button to enter the memory mode.

2. Use the arrow buttons to select the number of the memory module. (For example: M3)

3. Press the OK Button, the LCD display containing the various types of stitches will open.

4. Press the start/stop button or step on the foot controller to start the sewing.

The cursor on the LCD display will move along with the sequential pattern while sewing.

### 🔄 Please Note:

- If the cursor stays in a vacant position in the end, the machine will start sewing from the first pattern.
- If the cursor stays under a specific pattern, the machine will start sewing from that pattern.



5. Press the memory button to leave the memory mode and return to the normal mode.



## Important Embroidery information

### ✘ Embroidery threads

A good quality thread is essential for embroidery to avoid poor stitch formation, thread breakage, etc.

Embroider threads A good thread is essential for embroidery to avoid poor stitch formation, thread breakage, etc. EverSewn is recommending using Isacord® thread for your embroidery.

### **Polyester threads**

Polyester with a brilliant sheen is a hard wearing colorfast thread and has a high tensile strength which is suitable for all types of embroidery.

### **Rayon threads**

Rayon is a soft viscose fiber with a brilliant sheen and suitable for fine, delicate embroidery, or items that will not receive excessive wear and tear.

### **Metallic threads**

Metallic thread is a light- to medium weight thread suitable for special effects in embroidery. Reduce the speed and the upper thread tension when embroidering with metallic threads.

### **Embroidery needle**

- Correct size thread must correspond with correct size needle.
- Replace the needle regularly.

### ➔ **Note:**

Use the second spool pin when using metallic or specialty threads.

---

### ✘ Lower threads

#### **Bobbin Fill (special bobbin thread)**

Bobbin Fill is an especially soft and light polyester thread suitable for bobbin thread. This special bobbin thread ensures a steady thread tension and an optimal intertwining of the upper and bobbin thread.

#### **Darning and embroidery thread**

Fine mercerized cotton thread which is suitable for embroidering on cotton.

### ➔ **Note:**

In most cases, bobbin thread for embroidery is either white or black. Some special cases require the same thread in top and bobbin.

---

☒ **Stabilizer:** EverSewn is recommending using OESD® stabilizer for your embroidery.

#### **Tear-away stabilizers**

- Excess is easily torn away.
- One or more layers can be used.
- Available in different weights.
- For more stability, apply to the wrong side of the material with temporary adhesive spray before hooping.
- Carefully tear away excess stabilizer from the back of the embroidery after stitching.
- Designs are not skewed.
- Stabilizer will remain under larger embroidered areas.

Application: For all woven materials and materials without stretch.

#### **Cut-away stabilizers**

- One or more layers can be used.
- Available in different weights.
- For more stability, apply to the wrong side of the material with temporary adhesive spray before hooping.
- Carefully cut away from the back of the embroidery after stitching.
- Designs are not skewed.
- Stabilizer will remain under larger embroidered areas.

Application: For all elastic materials.

#### ☒ **Adhesive Spray**

Avoid using spray adhesive next to your embroidery system.

- At a distance of 25-30 cm use adhesive spray carefully.
- Spray the stabilizer and adhere to the wrong side of the material carefully smoothing material so that there are no puckers.

Application:

- Stretch and knitted material: to retain shape.
- Smooth material: to avoid slipping of material layers.
- Appliqués can be exactly positioned.
- Material pieces: position material pieces on stabilizer, e.g.pocket flaps.
- Napped materials (i.e. velvet) that should not be clamped in the hoop to avoid getting hoop marks.
- To fix the parts to be embroidered.

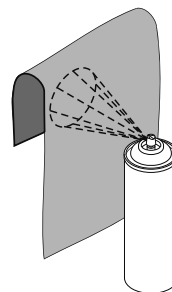

#### **Spray starch for additional stiffening**

Spray starch is ideal for additional stiffening of fine, soft or loosely woven materials.

- Spray the area to be embroidered
- Let dry; or press gently with a warm iron if necessary
- Always use an additional stabilizer such as water soluble stabilizer on the wrong side of the material.

Application: Ideal for fine, loosely woven materials, e.g. batiste, fine linen, etc.

## ✘ Iron-on interfacing

Iron-on interfacings are available in a variety of weights. Iron-on interfacings should be selected to suit the material being used. Use an iron-on interfacing which is easily removable from the material.

Iron-on interfacings are pressed (fused) to the wrong side of the material

Application: To provide body and shape for the materials onto which designs will be placed, use the appropriate stabilizer.

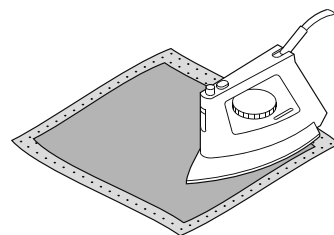

## Paper-backed adhesive stabilizer

Place stabilizer in hoop, paper side up.

- Use a pointed object (e.g. scissors) to score the paper.
- Remove paper to reveal the self-adhesive surface.
- The self-adhesive surface reveals.
- Position the material to be embroidered on the stabilizer and smoothen the area.

Application:

- Intended for delicate materials such as jersey or silk etc.
- For hard-to-hoop parts and materials.

## ➔ Note:

Make sure that the adhesive residue on needle, stitch plate and hook area is removed.

---

## Water soluble stabilizer

Water soluble stabilizers look like plastic wrap. Dissolve stabilizer in warm water when the embroidery is complete. Water soluble stabilizers are ideal protection for materials with a thick or looped pile such as toweling. This prevents the threads from sinking into the material and prevents the material from showing through the embroidery stitches.

- Place on top of the material.
- Place all the layers together into the embroidery hoop.
- Use adhesive spray to fix stabilizer if necessary.
- For material with a pile, reinforce with additional, suitable stabilizer on the wrong side.
- After dissolving lay the design down flat and let dry.

Application:

- Ideal for toweling, velvet, bouclé etc.
- Ideal for fine, sheer materials such as organdy, batiste, etc.
- For lace embroidery.





## Attaching the embroidery foot

### ⚠ Attention:

Turn power switch to off ("O") when carrying out any of the below operations!

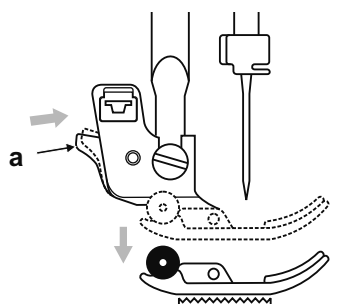

Raise the presser foot to the second stage.  
Press the lever (a) and the foot will disengage.

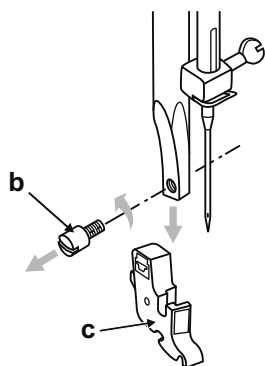

Loosen the screw (b) counterclockwise to remove the presser foot holder (c).

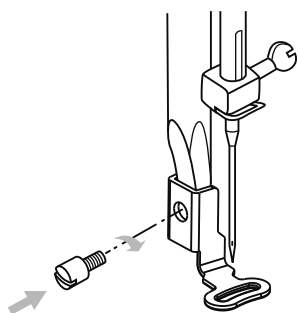

Attach the embroidery foot to the presser foot holder bar.  
Press the embroidery foot on firmly from behind with your index finger and tighten the screw.



# Embroidery unit overview

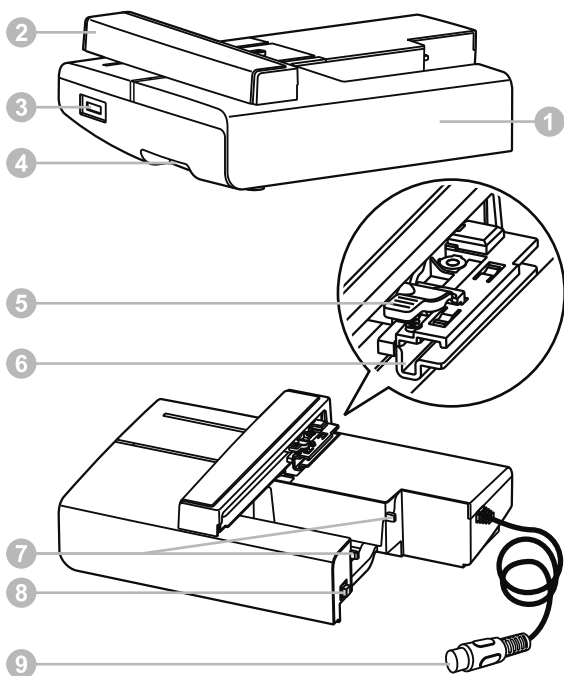

1. Embroidery surface
2. Embroidery carriage
3. USB port
4. Embroidery unit release button
5. Hoop-securing lever
6. Embroidery hoop holder
7. Embroidery unit connection
8. Embroidery unit detection device
9. Embroidery unit connector plug

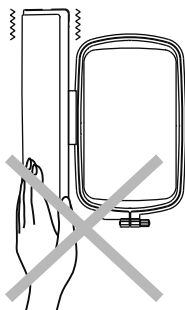

**Note:**

- Do not touch the embroidery unit detection device. The connector could be damaged, and it may cause malfunctions.
- Do not lift up on the embroidery carriage, and do not forcefully move it. It may cause malfunctions.

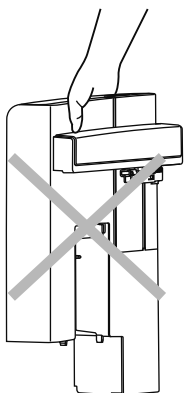

**Note:**

Do not carry the embroidery unit by holding the release button compartment.

## ✦ Connecting the embroidery unit

### ⚠ Attention:

- Turn power switch to off ("O") when carrying out any of the below operations!
- The foot control is disabled as long as the embroidery unit is connected.

Remove the sewing table to the left side.

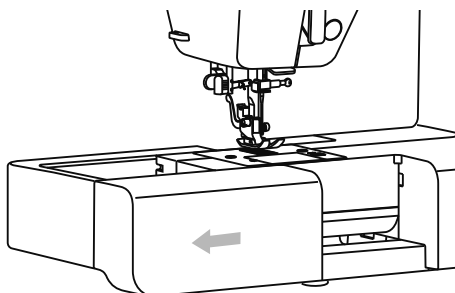

Slide the embroidery unit onto the machine arm.

Push lightly until the unit clicks into place.

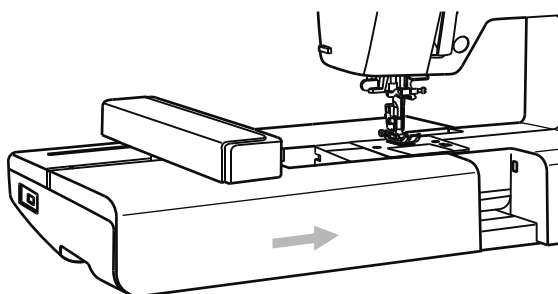

Insert the plug into connector on the right hand side of the machine.

### ➔ Note:

Align the arrow on the plug (a) with the arrow on the machine (b).

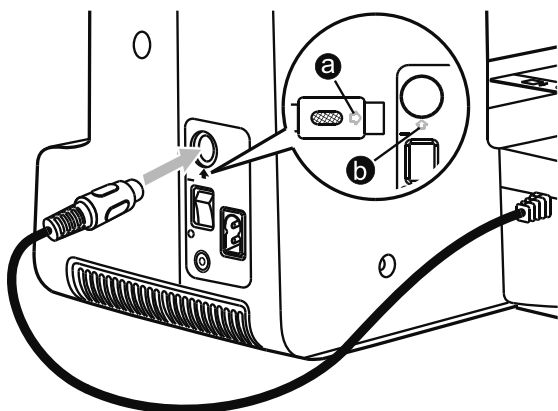

✘ **Removing the embroidery unit**

Remove the embroidery hoop, and make sure the embroidery carriage return to the home position.

⚠ **Attention:**

- To remove the embroidery hoop, please refer page 84.
- To return the embroidery carriage, please refer page 98.

Turn power switch to off ("O")!  
Remove the embroidery unit connector plug.

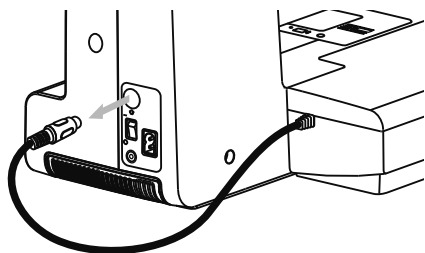

Press the embroidery unit release button on the lower left side, pull it to left side out smoothly and carefully.

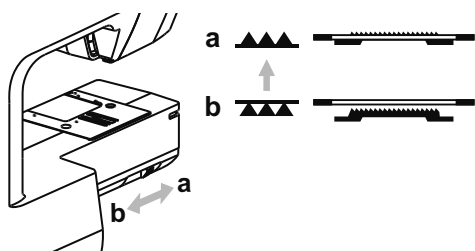
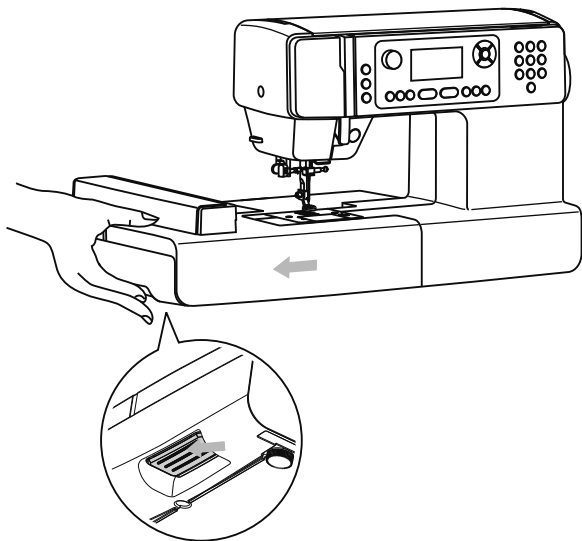

➡ **Please Note:**

When you finish the work, move the drop feed control to "▲▲▲" to raise the feed dogs.



## Embroidery hoop overview

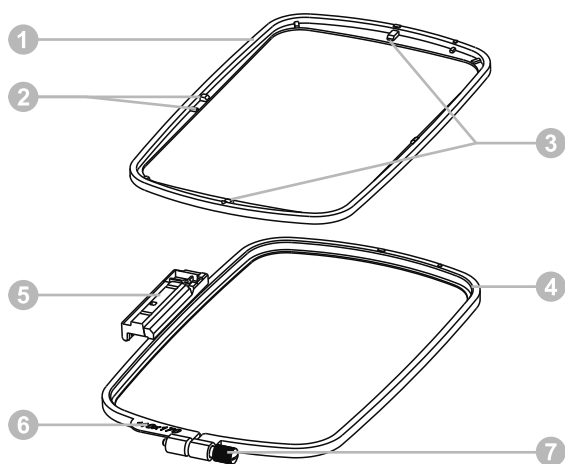

1. Inner hoop
2. Ribs for fitting the embroidery sheet
3. Center mark
4. Outer hoop
5. Embroidery hoop connector
6. Hoop size
7. Adjustment screw

### ✘ Attaching a stabilizer to the fabric



#### Attention:

Always use stabilizer material when sewing embroidery projects. The needle may break or bend if you embroider without using a stabilizer material for thin fabrics or stretch fabrics. Furthermore, the pattern may be sewn incorrectly.

**To obtain the best quality embroidery, it is important to use stabilizers.**

1. Prepare stabilizer material that is larger than the embroidery hoop being used.

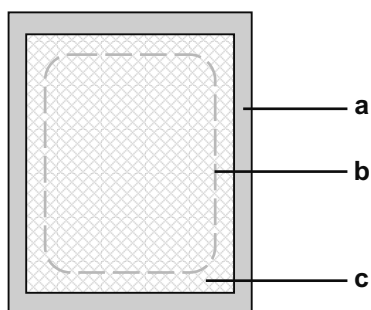

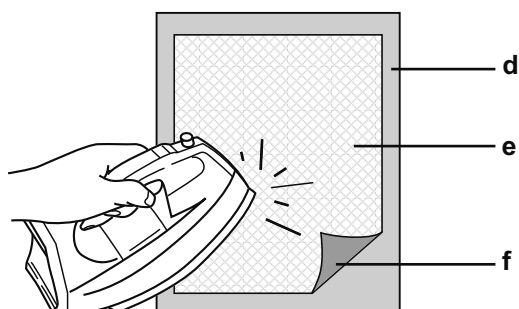

- a. Fabric (wrong side)
- b. Size of embroidery hoop
- c. Stabilizer

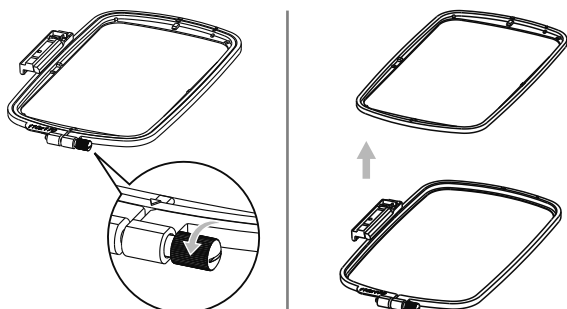

2. If you are using stabilizers with adhesive, place the adhesive surface of the stabilizer material against the wrong side of the fabric, and iron it with a steam iron.
- d. Fabric (wrong side)
  - e. Stabilizer
  - f. Adhesive surface



### ✘ Hopping the fabric

1. Loosen the embroidery hoop adjustment screw on the outer hoop.  
Separate the inner and outer hoop by removing inner hoop upward.
2. Make the fabric with right side upward.  
Place the fabric with the stabilizer material on top of the outer hoop.
3. Press the inner hoop down of the fabric.  
Push down firmly until the inner hoop is securely pressed against the outer hoop.  
Line up  (a) on the inner hoop and  (b) on outer hoop.
4. Tighten the adjustment screw to secure the fabric.  
Removing any slack in the fabric by hand.  
After stretching the fabric, make sure that the fabric is stretched drum-tight in the hoop.

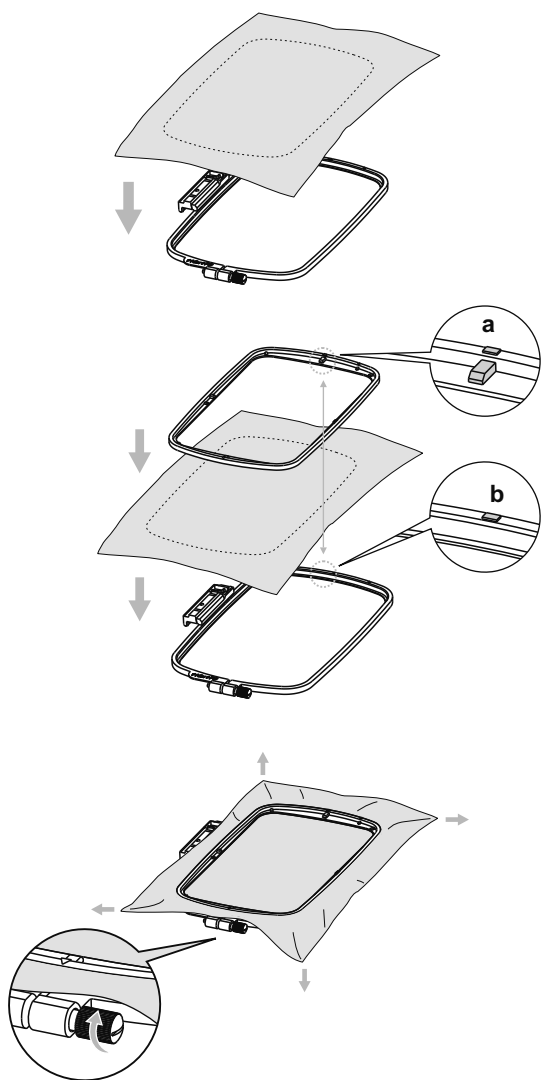

**⚠ Attention:**  
Thick layers of fabric and stabilizer may cause skipped stitches, or broken threads, needles and the embroidery hoops.

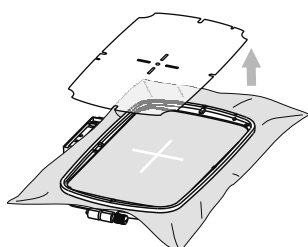
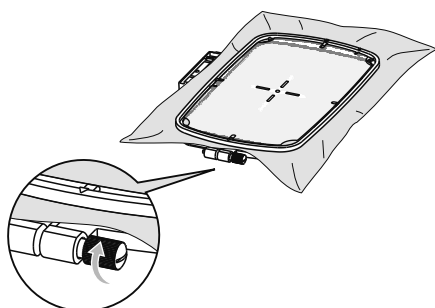
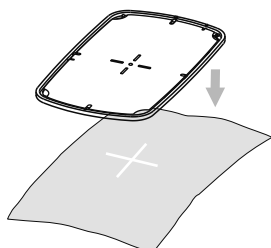
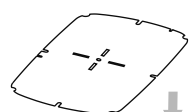

### ✦ Using embroidery sheet

1. Make a mark with a chalk pen at the center of the position for the pattern to be embroidered.
  
2. Place the embroidery sheet on the inner hoop.
  
3. Line the mark on the fabric up with the base line on the embroidery sheet.
  
4. Place the inner hoop with the fabric on the outer hoop and stretch the fabric.
  
5. Remove the embroidery sheet.

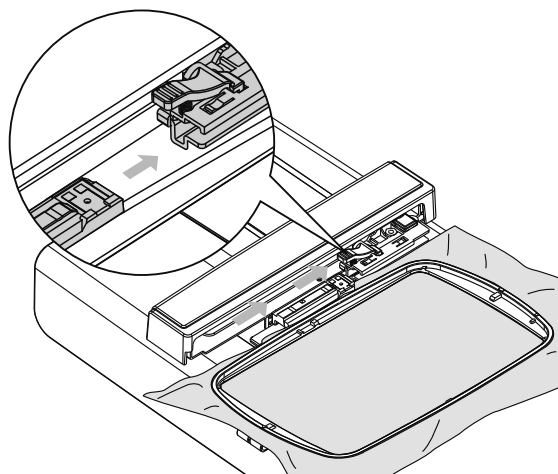

### ✘ Attaching the embroidery hoop

Raise the needle .

Raise the presser foot to the second stage.

Place the embroidery hoop under the presser foot.

Attaching the embroidery hoop, make the embroidery hoop connector into the embroidery hoop holder from front to back until it clicks.

### ⚠ Attention:

Do not embroider fabrics that are too thick. When attach the embroidery hoop to the embroidery unit, to check the fabric thickness. If there is space between the presser foot and the fabric, the fabric can be embroidered. If there is not space, do not embroider the fabric. Otherwise, the needle may break, resulting in injury.

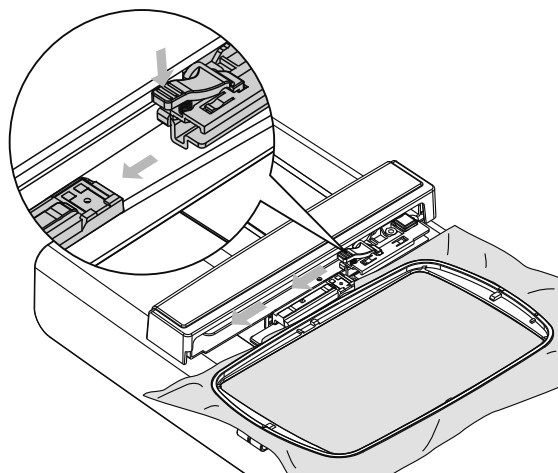

### ✘ Removing the embroidery hoop

Raise the presser foot to the second stage.

Press down the hoop-securing lever, pull the hoop towards you smoothly and carefully.





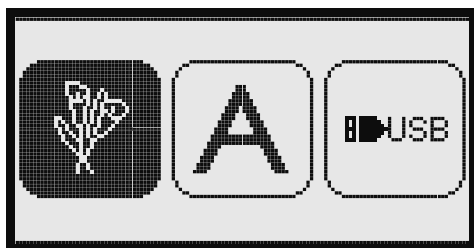

## Embroidery design types



An embroidery pattern can be selected from the following types available.

Use the right/ left arrow buttons   for selecting and press the OK button  to into.

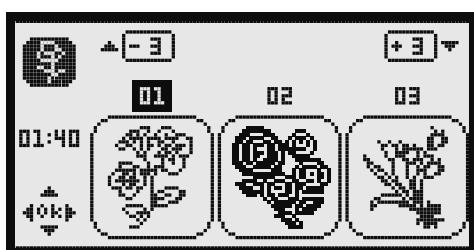

### Built-in Embroidery pattern

There are total 40 patterns.

The patterns are completed by changing the upper thread according to the instructions displayed on the display.



### Built-in Embroidery letter

There are upper case/ lower case/ special character/ number & symbol.

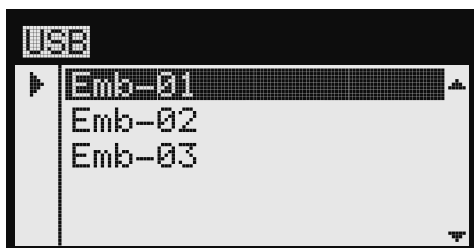

### Designs from USB

To sew the designs from the USB.

\* The USB storage device accessory is optional. It is not included with this



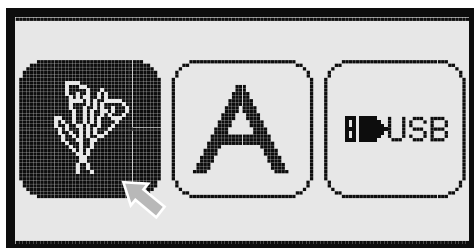

## Built-in embroidery pattern



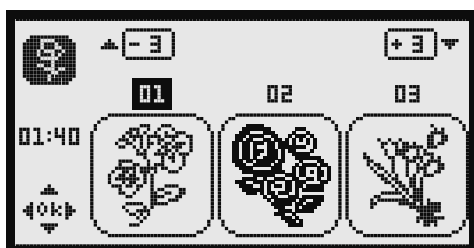

Into the built-in embroidery pattern chose the first icon and press the OK button  .

The pattern selection display is displayed.



There will be 3 patterns on the display and using the right/left arrow buttons   for switching.

To move forward or back by 3 patterns, press the up/down arrow buttons   .

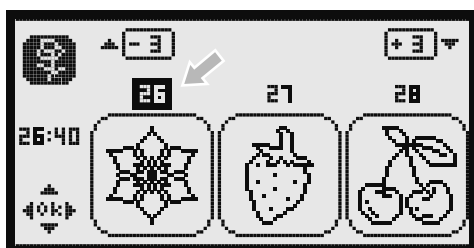

Or just press the number buttons for selection directly. (Ex. No.26)

Press the OK button  to enter the editing display.

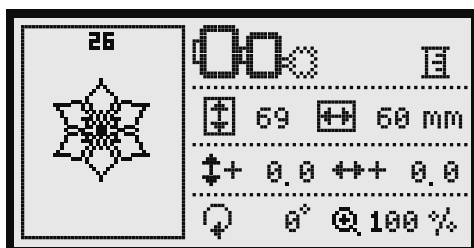

On the editing display the embroidery design may be moved forward/backward & right/left, resized from 80% - 120% or rotate, for detailed description see page 94.

After editing, press the Auto-lock/ Trace button to check the size of the embroidering area.

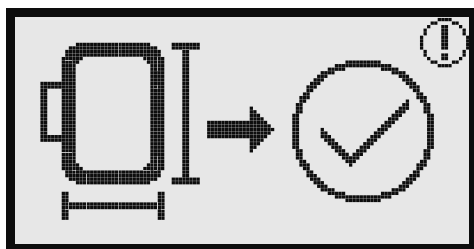



Press the OK button  to prepare embroidery. Then a warning message is displayed, It's reminding you to check the embroidery hoop size.

Press the OK button  to confirm and enter the embroidery display, then you can start to embroider.



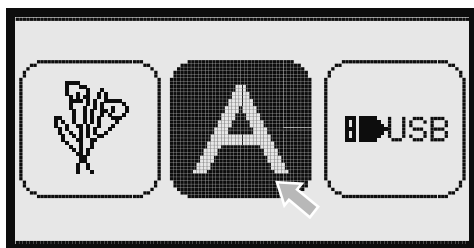

## Built-in embroidery letter



Into the built-in embroidery letter chose the second icon and press the OK button .

The letter selection display is displayed.







Press the arrow buttons  for letter selecting.  
Press the OK button  for enter.  
Press the C button  for deleting.



To change the letter type, move the cursor to icon at lower right corner.

Switch between the uppercase/ lowercase / special character/ number & symbol by pressing the OK button .

-  Uppercase
-  Lowercase
-  Special character
-  Number & symbol



Enter some letters, e.g. Abc

After editing, move the cursor to icon at upper front side.

Press the OK button  to enter the editing display.

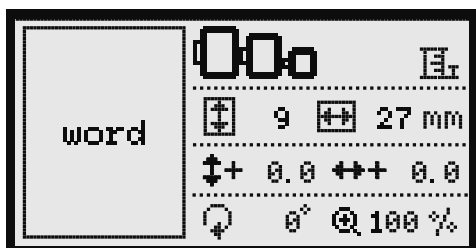



When selecting letters or writing a word for embroidering, the display is not showing the written word but it is showing "word" only.

On the editing display the embroidery design may be moved forward/backward & right/left, resized from 80% - 120% or rotate, for detailed description see page 94.

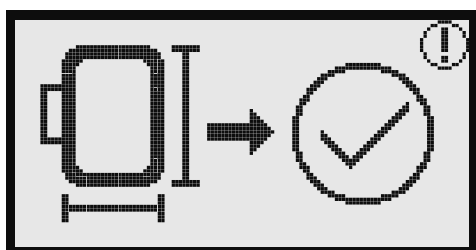
After editing, press the Auto-lock/ Trace button to check the size of the embroidering area.



Press the OK button  to prepare embroidery. Then a warning message is displayed, It's reminding you to check the embroidery hoop size.

Press the OK button  to confirm and enter the embroidery display, then you can start to embroider.



## Designs from USB

The Embroidery unit has a USB port for connecting a storage device such as a USB Stick and therefore allows the machine to import new embroidery designs.

### → Note:

- The USB storage device such as RAM disk is not included with the machine, but such kind of devices are easily available in computer shops and camera shops.
- The USB storage device must be of either FAT16 or FAT32 formats only. The USB storage device max allowed capacity is 32GB.

### Please be aware of the following:

- The machine can only read and use files generated from EZ Converter application Software with .zhs format. You can download this Software for free from our EverSewn website.
- New Embroidery Designs can be purchased for example on [www.embroideryonline.com](http://www.embroideryonline.com)
- Embroidery data must be stored in root directory in USB storage device.
- The sizes of the embroidery pattern cannot exceed 110x170mm (WxH).
- The color mixes of the embroidery pattern cannot exceed 30.
- The file length of each individual file should not exceed 17 characters.
- The valid file names need to be made of any of the 26 English letters or the numbers 0 through 9.

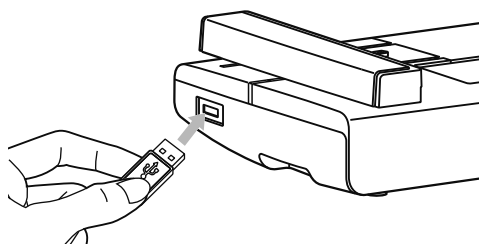

### Connect to and remove from USB port

Insert the USB storage device into the USB port on the left side of the embroidery unit. To remove, carefully pull the USB storage device out straight.

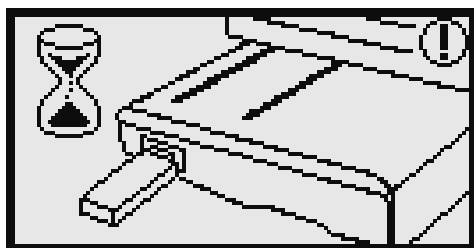

### To download the new design patterns via USB port

A funnel-shaped icon will pop up on the screen as shown which indicates that data transfer is in progress.

Do not turn off the power or remove the USB storage device while the access lamp on the storage device is still blinking, because this may result in errors or damages.

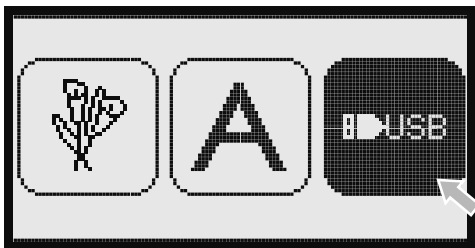

To download from the USB storage device, use the up/down arrow button  to choose the USB icon and press the OK Button .

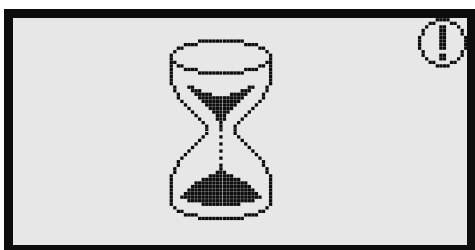

 **Attention:**

If the funnel-shaped icon pops on, it indicates that data transfer is in progress, be sure to wait and not to interrupt until this icon disappears. After this icon disappears, the new patterns can be downloaded from the USB storage device.

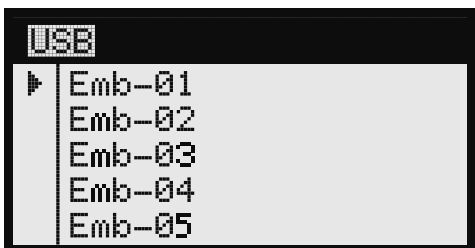

It will be able to upload your embroidery designs and the file list is displayed in the screen.

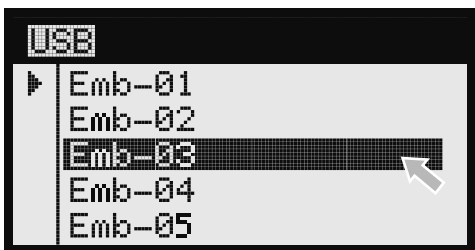

Select the desired pattern by pressing the up/down arrow button .

Press the OK button  to enter the editing display.

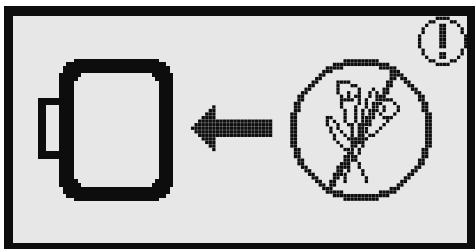

 **Attention:**

A warning message will pop up when the selected pattern has exceeded the max allowed size of 110\*170 mm, or the color mix has exceeded 30 colors.

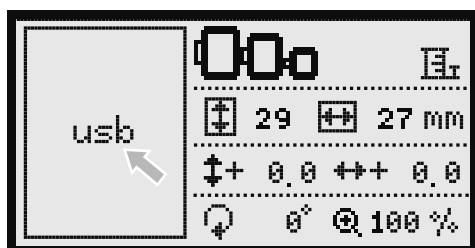

When uploading Designs from USB storage device, the display is not showing the design but it is showing "usb" only.

On the editing display the embroidery design may be moved forward/backward & right/left, resized from 80% - 120% or rotate.

After editing, press the Auto-lock/ Trace button to check the position of embroidering pattern on the embroidery hoop.

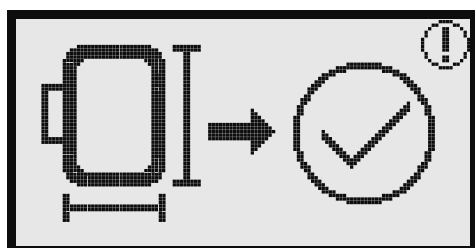

Press the OK button **OK** to prepare embroidery. A warning message appears reminding you to check the embroidery hoop size.

Press the OK button **OK** to confirm and enter the embroidery display, then you can start to embroider.



## Starting to sew embroidery

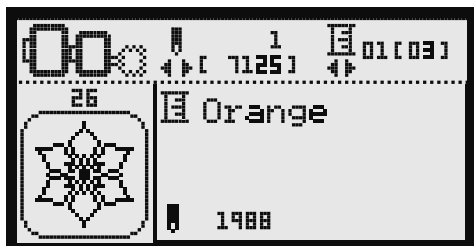

After the preparations are done, you can try embroidering.

Prepare embroidery thread of the color shown on the display.

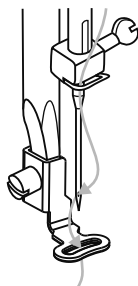

Set the embroidery thread, thread the needle and embroidery foot.

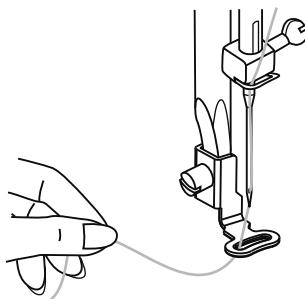

Pass the thread through the embroidery foot hole, and hold it lightly in your left hand.

**! Attention:**

- If the thread is pulled too tight, the needle may break or bend.
- Do not let hands or objects hit the carriage while sewing. The pattern may misalign.

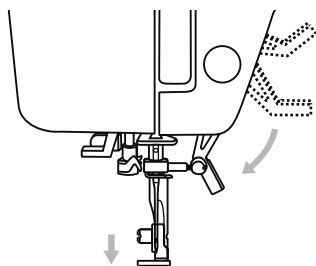

Lower the presser foot.



Press start/stop button to start embroidering. After sewing 5 to 6 stitches, press the start/stop button again to stop the machine.



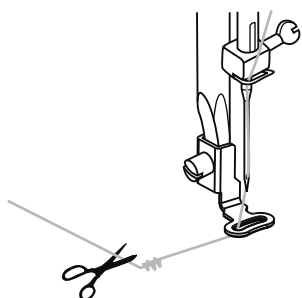

Raise the presser foot.  
Cut the thread at the beginning of the stitching.  
Lower the presser foot.

Press the start/stop button  to continue embroidering.

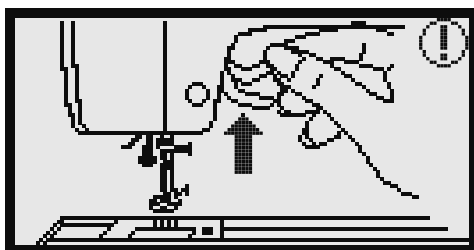

When the first color is completed, the machine stops automatically.

The raise presser foot message is displayed, raise the presser foot to the second stage.

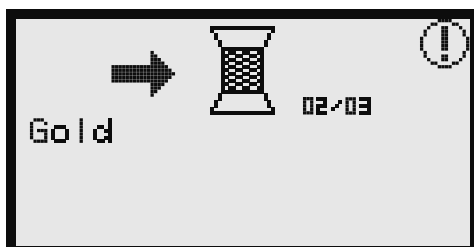

After raising, change the thread color message is displayed.

Re-thread with the next color and press OK button  to confirm.

And repeat the same actions for embroidering.

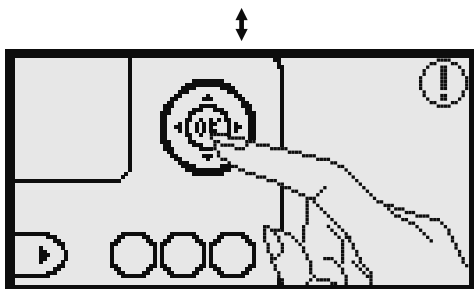

 **Note:**

To simply threading of the new thread color and for easier trim of the jumping stitches the embroidery hoop can be moved forwards by pressing the Auto-lock/ Trace button button.

By pressing the Auto-lock/ Trace button again, the embroidery hoop goes back to the correct position.

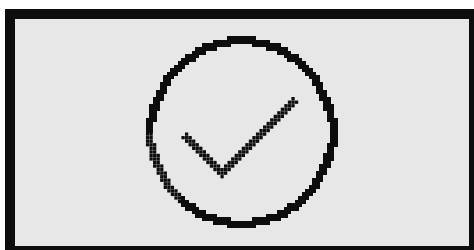

When the embroidery is completed, the machine stops automatically and the message is displayed.

Press OK button  to return to the pattern selection display.



# Editing the embroidery design

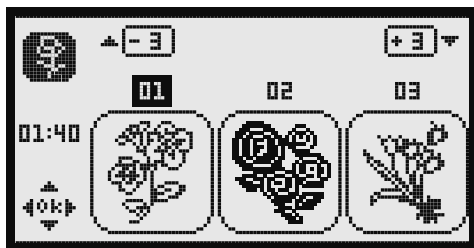

## Basic setting

You can edit and combine designs to create original embroidery.  
After selecting the embroidery pattern, press OK button  the editing display will display.

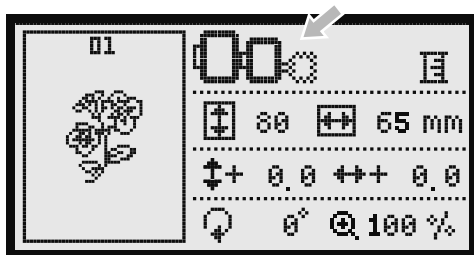

## Embroidery hoop

These flash if the pattern was resized, the layout was adjusted, or the recommended embroidery hoop size was changed. Embroidery hoop icons that appear in gray cannot be used.



## Mirror the design

Press this button to horizontally mirror the embroidery design.

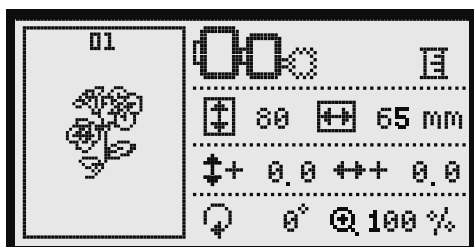

The LCD display icon for mirror imaging of the pattern appears.

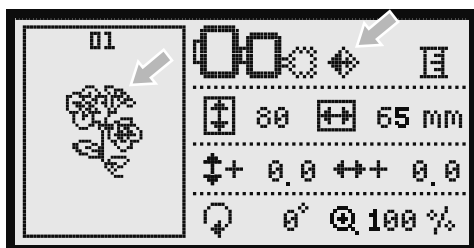

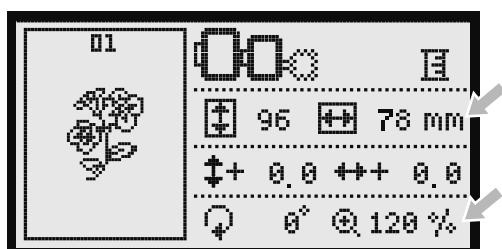
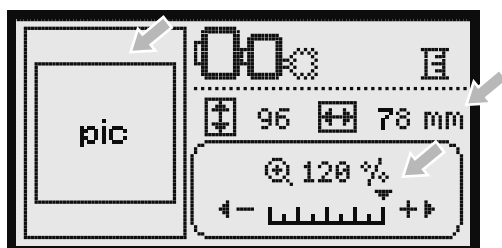
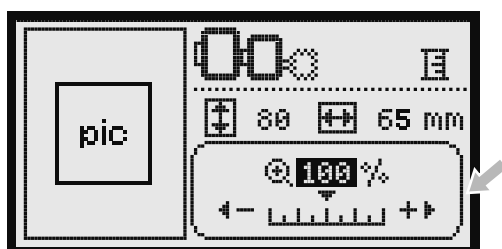
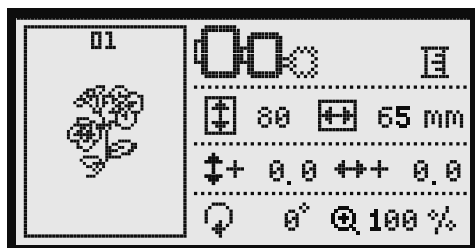

### Resize the design

Press the button  to resize the embroidery design.

You can change the size of embroidery design from 80% to 120% of the original size.

When you press, the resize window will open.

Use the arrow buttons to change size, the size will change 5% each time you press the arrow button.

Press  to enlarge the size of the pattern.

Press  to reduce the size of the pattern.

Press the OK button  to save the new size and return the editing display.

### Note:

Not all designs are suitable to be scaled to 80%.

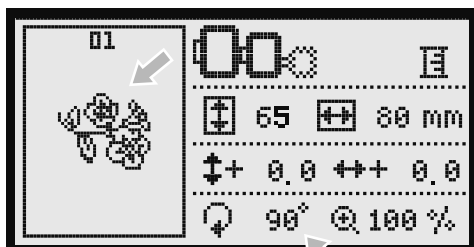
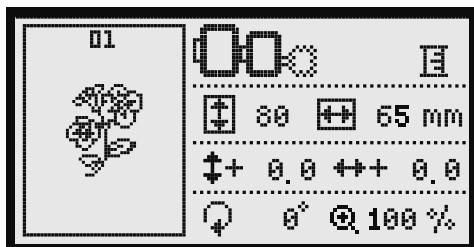

### Rotate the design

Press the button  to rotate the embroidery design.

It will rotate 90 degrees clockwise each time when you press the button.

The icon for rotate of the pattern appears.

It will rotate 90 degrees clockwise each time when you press the button, the angle of design will be shown.

The icon for rotate of the design appears.

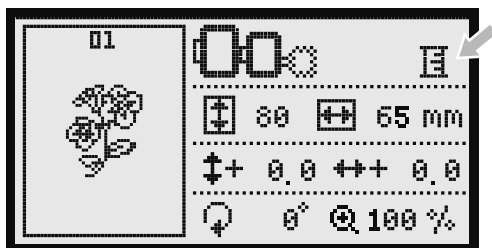

### Single/ Multi color

Press the button  to set the single or multi color for embroidery pattern.

 Multi color

 Single color



### ⊠ **Advanced setting**

Press the button **M** to open setup program and change the embroidery mode setting, press the again to save the set and leave setup program.

In the setup program, the machine settings or function for embroidery can be customized or executed.

There are five functions in the program, use the arrow buttons  to select the function.

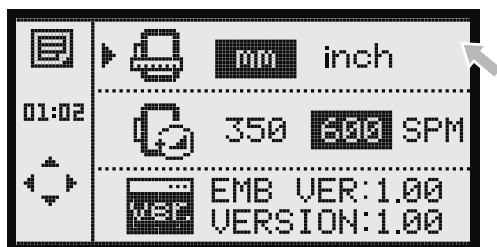

#### **mm/inch options**

The default unit setting is millimeter.

You can set your machine's measuring unit to either inch or millimeter by pressing the arrow buttons .

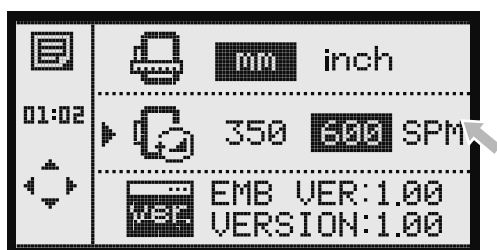

#### **Embroidery maximum speed**

The default speed setting is 600 spm.

The maximum sewing speed can be changed 350 or 600 spm for embroidery sewing by pressing the arrow buttons .

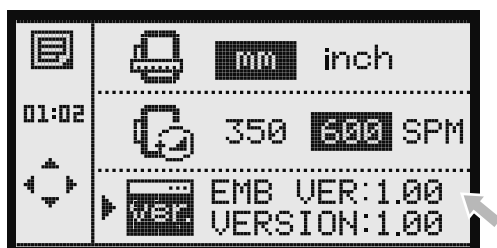

#### **Software version information.**

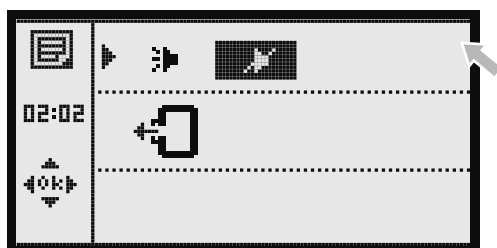

#### **Buzzer sound**

The buzzer sound can be set on/ off by pressing the arrow buttons .

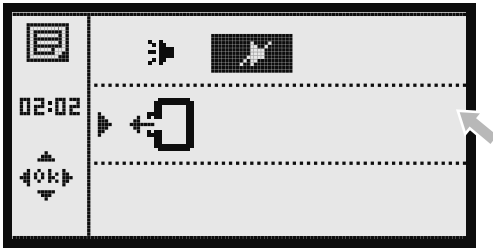

### Embroidery carriage return

Select this function, press the OK button  and the carriage will move to the home position.

#### **Attention:**

- The needle must be in the highest position.
  - Do not return the carriage with the embroidery hoop attached.
-



## Load a Design after interruption

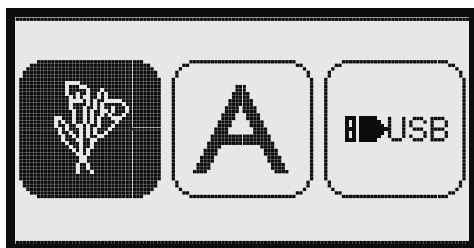

Press the button to open the type selection display.

Use the right/ left arrow buttons to choose the design from Built-in Embroidery designs or from USB storage device.

Press the OK button to confirm the selection.

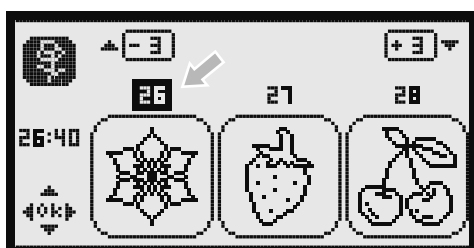

Use the arrow buttons or just press the number buttons to select the desired design.  
(Ex. No.26)

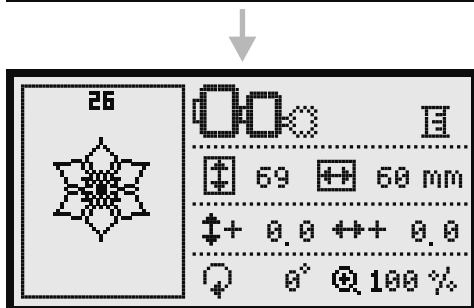

Make all necessary editings, i.e mirroring, resizing, rotating.

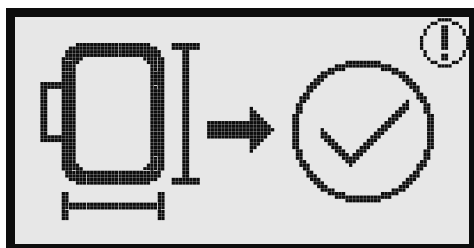

Press the OK button to prepare embroidery.

A warning message appears reminding you to check the embroidery hoop size.

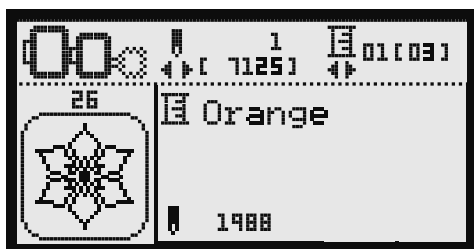

Press the OK Button to confirm and enter the embroidery display.



Press the button to move the design to the last embroidered color.



Press the button to move the design to the last embroidered stitch position.

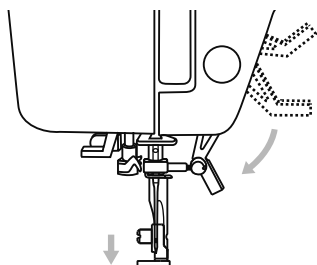

Lower the presser foot and press start/stop button to start to embroider.

 **Note:**

Always remember all made design editings in case of any interruption to be able to continue embroidering the design.

---





## Warning functions

### ⊠ Warning message

#### **Presser foot is not ready for sewing**

This message is displayed when the Start/stop button or the needle up/down position button is pressed while the presser foot is raised.

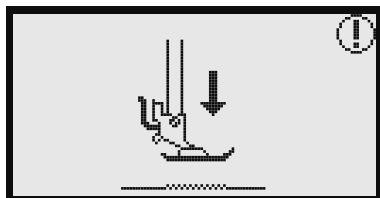

#### **Presser foot is not raised**

This message is displayed when the embroidery unit will initialize while the embroidery foot is lowered.

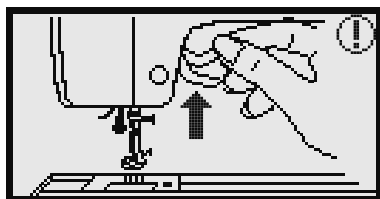

#### **Bobbin winding**

This message is displayed when the bobbin winder is winding the bobbin.

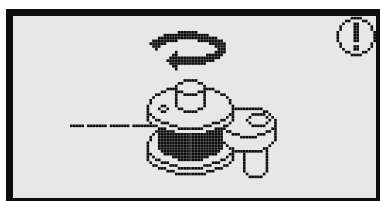

#### **Push the bobbin winder spindle to the left**

This message is displayed when the bobbin winder spindle is in the right in the embroidery model.

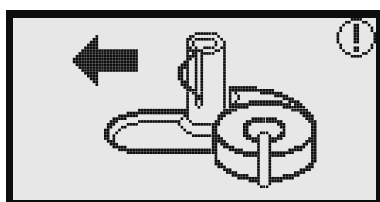

#### **The upper thread is broken**

This message is displayed when the upper thread is broken. Please check and rethread the upper thread.

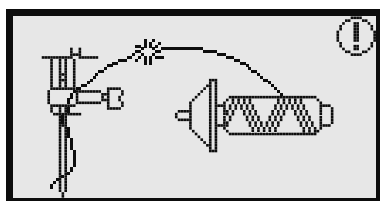

#### **Bobbin thread is low**

This message is displayed when the bobbin thread is running out.

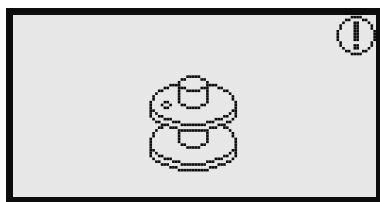

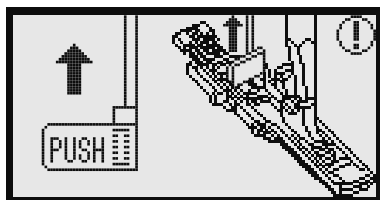

**BH lever is not lifted**

This message is displayed when the stitch other than the buttonhole or darning stitch was selected and the start/stop button was pressed while the buttonhole lever is down.

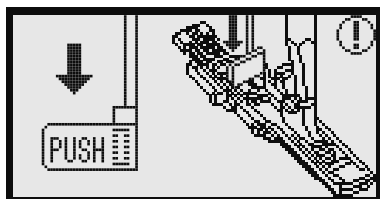

**BH lever is not lowered**

This message is displayed when the buttonhole or darning stitch was selected and the start/stop button was pressed while the buttonhole lever is raised.

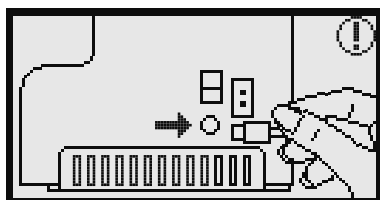

**Turn off the machine, the plug is not attached correctly.**

The messages are displayed when the embroidery unit plug is not attached correctly.

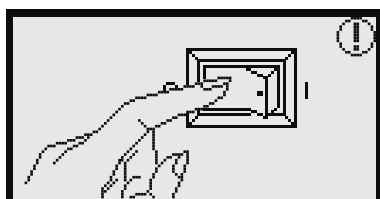

**Embroidery unit is not attached correctly.**

This message is displayed when the embroidery unit is not attached correctly.

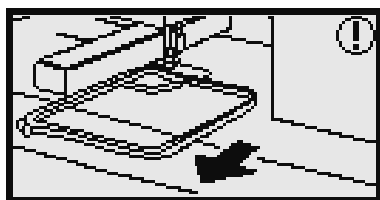
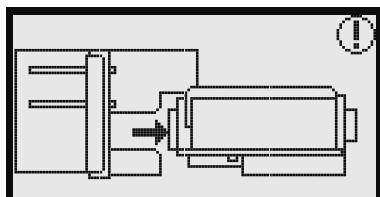

**Remove the embroidery hoop.**

This message is displayed when the embroidery unit will initialize, it is reminding you to remove the embroidery hoop.



**Press the OK button to confirm**

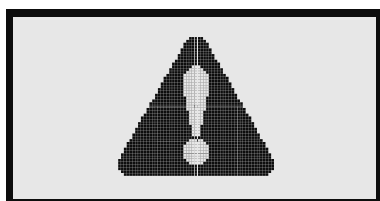

**The carriage of the embroidery unit will move**

This message is displayed when the embroidery unit is initializing.

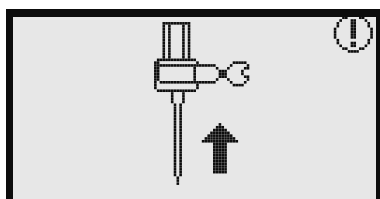

**To raise the needle.**

This message is displayed when the embroidery unit is attached and the power is turned on with the needle in the down position.

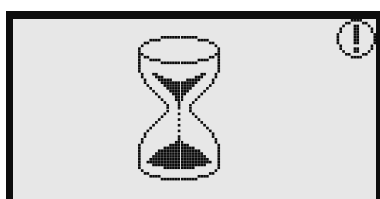

**Loading.**

A embroidery pattern is loading.



**Check the embroidery hoop size.**

This message is reminding you to check the embroidery hoop size.

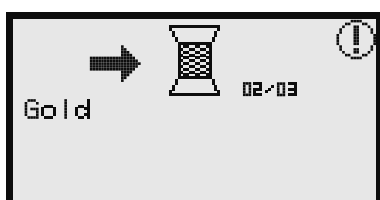

**Change the thread color.**

This message is reminding you to change to the next color part thread.

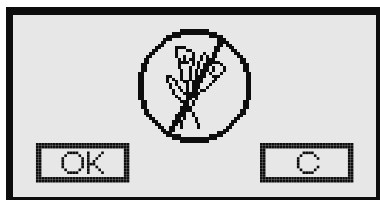

### Delete pattern?

This message is displayed when the machine is in embroidery mode and you pressed the button .

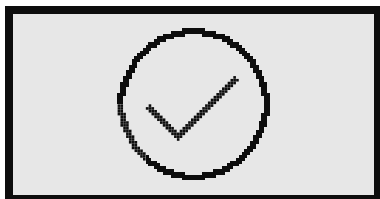

### The embroidery pattern is completed.

This message is displayed when the embroidery is completed.

Press ok button  to return to the pattern selection display.

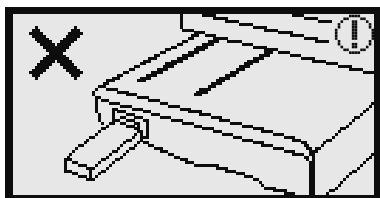

### Can not recognize the data.

This message is displayed when there is a possibility that the data for the selected pattern is not completeness.

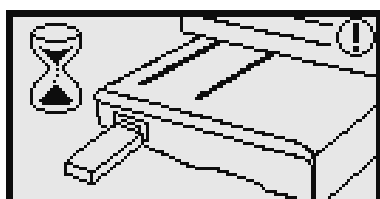

### Connecting the USB storage device.

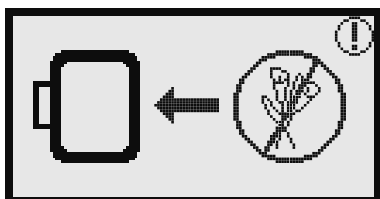

### The embroidery pattern can't be imported.

This message is displayed when the machine is in USB mode, the embroidery pattern you selected is too large to fit in the embroidery hoop (110\*170 mm) or it is over then 30 colors.

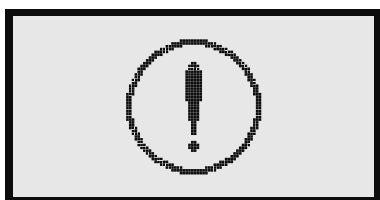

### The sewing machine is in trouble

The animation message means that the thread is twisted or jammed and the hand wheel axle cannot move.

Please look through the "Trouble shooting guide" to find the solution.



### ⊠ **Warning sound**

- When operating correctly: 1 beep
- When the memory is full with 20 units of pattern: 3-short beeps
- When operating incorrectly: 3-short beeps
- When the sewing machine is in trouble and can't sew: 3-short beeps

It means that the thread is twisted or jammed and the hand wheel axle can't move. Please look through the "Trouble shooting guide" to find the solution. After the problem has been solved, the machine will continue to sew.

### ➔ **Please Note:**

If the problem is still not solved, please contact your local dealer.

---

### ⚠ **Attention:**

During the sewing, if the thread get jammed inside the hook stopping the needle from moving and you continue pressing the foot control, the security switch will stop the machine completely. In order to restart the sewing machine, you will have to turn the on/off switch to the OFF position and then ON again.

---



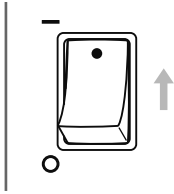

# Buzzer sound

C

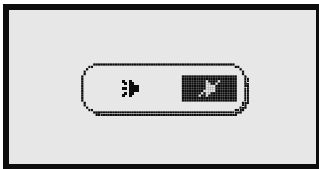
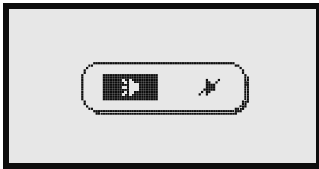

Hold on the **C** button and turn on the power switch.



The buzzer sound can be set on/ off by pressing the arrow buttons .

 Sound on

 Sound off

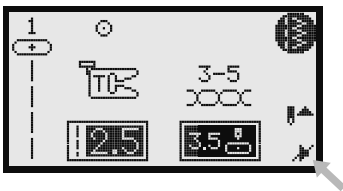

Pressing the OK button **OK**.

The Buzzer sound setting mark will appear on the LCD display when you have set it.



## Maintenance

### ⚠ Attention:

Disconnect the power cord from the wall socket before cleaning the display and sewing machine surface, otherwise injury or electrical shock may result.

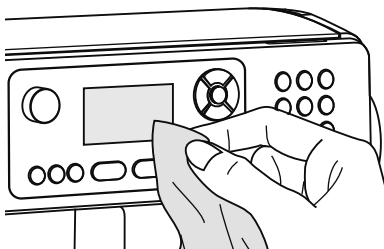

### ☒ Cleaning the screen

If the front panel is dirty, wipe it gently with a soft, dry cloth. Do not use any organic solvents or detergents.

### ☒ Cleaning the sewing machine surface

If the surface of the sewing machine is dirty, lightly soak a cloth in mild detergent, squeeze it out firmly and then wipe the surface. After cleaning it once in this way, wipe the surface again with a dry cloth.

### ⚠ Attention:

This machine is equipped with a 100mW LED lamp. If lamp replacement is needed, please contact nearest authorized retailer.

### ☒ Cleaning the hook

If lint and bits of thread accumulate in the hook, this will interfere with the smooth operation of the machine. Check regularly and clean the stitching mechanism when necessary.

### ⚠ Attention:

Disconnect the machine from the wall outlet before carrying out any maintenance.

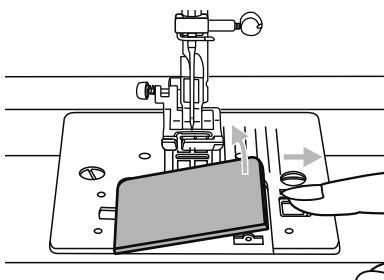

Remove the bobbin cover plate and bobbin.

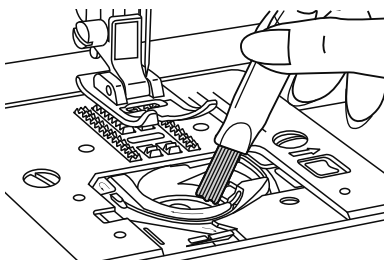

Clean the bobbin holder with a brush.

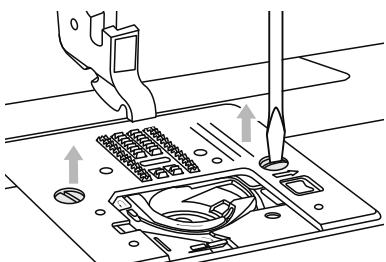

Remove the needle, presser foot and presser foot holder.  
Remove the screw holding the needle plate and remove the needle plate.

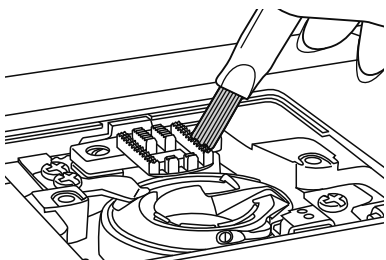

Clean the feed dog and bobbin case with a brush. Also clean them, using a soft, dry cloth.





## Trouble shooting guide

Before calling for Service, check the following items. If the problem still persists, contact the EverSewn customer support at: [service@eversewn.com](mailto:service@eversewn.com) or call 1-844-EVERSEW (1-844-383-7739)

Problem	Cause	Correction	Reference
Upper thread breaks	1. The machine is not threaded correctly.	1. Rethread the machine.	12
	2. The thread tension is too tight.	2. Reduce the thread tension (lower number).	34
	3. The thread is too thick for the needle.	3. Select a larger needle.	17
	4. The needle is not inserted correctly.	4. Remove and reinsert the needle (flat side towards the back).	16
	5. The thread is wound around the spool holder pin.	5. Remove the reel and wind thread onto reel.	12
	6. The needle is damaged.	6. Replace the needle.	16
Lower thread breaks	1. The bobbin case is not inserted correctly.	1. Remove and reinsert the bobbin case and pull on the thread. The thread should pull easily.	11
	2. The bobbin case is threaded wrong.	2. Check both bobbin and bobbin case.	11
	3. The lower thread tension is too tight	3. Loosen lower thread tension as described.	-
Skipped stitches	1. The needle is not inserted correctly.	1. Remove and reinsert needle (flat side towards the back).	16
	2. The needle is damaged.	2. Insert a new needle.	16
	3. The wrong size needle has been used.	3. Choose a needle to suit the thread.	17
	4. The foot is not attached correctly.	4. Check and attach correctly.	-
	5. The machine is not threaded correctly.	5. Rethread the machine.	12
Needle breaks	1. The needle is damaged.	1. Insert a new needle.	16
	2. The needle is not correctly inserted.	2. Insert the needle correctly (flat side towards the back).	16
	3. Wrong needle size for the fabric.	3. Choose a needle to suit the thread and fabric.	17
	4. The wrong foot is attached.	4. Select the correct foot.	-
	5. The needle clamp screw is loose.	5. Use the screwdriver to firmly tighten the screw.	16
	6. The presser foot that is used is not appropriate for the type of stitch that you wish to sew.	6. Attach the presser foot that is appropriate for the type of stitch that you wish to sew.	-
	7. The upper thread tension is too tight.	7. Loosen the upper thread tension.	34
Loose stitches	1. The machine is not correctly threaded.	1. Check the threading.	12
	2. The bobbin case is not correctly	2. Thread the bobbin case as illustrated.	11
	3. Needle/ fabric/ thread combination is wrong.	3. The needle size must suit the fabric and thread.	17
	4. Thread tension is wrong.	4. Correct the thread tension.	34

Problem	Cause	Correction	Reference
Seam gather or pucker	1. The needle is too thick for the fabric.	1. Select a finer needle.	17
	2. The stitch length is adjusted wrong.	2. Readjust the stitch length.	30
	3. The thread tension is too tight.	3. Loosen the thread tension.	34
Seam puckering	1. The needle thread tension is too tight.	1. Loosen the thread tension.	34
	2. The needle thread is not threaded correctly.	2. Rethread the machine.	12
	3. The needle is too heavy for the fabric being sewn.	3. Choose a needle to suit the thread and fabric.	17
	4. The stitch length is too long for the fabric.	4. Make stitch dense.	30
	5. If you are sewing thin fabric.	5. Sew with stabiliser material under the fabric.	17
Patterns are distorted	1. The correct presser foot is not used.	1. Select the correct foot.	-
	2. The needle thread tension is too tight.	2. Loosen the thread tension .	34
The machine jams	1. Thread is caught in the hook.	Remove the upper thread and bobbin case, turn the handwheel backwards and forwards by hand and remove the thread remnants.	107
	2. The feed dogs are packed with lint.		
The machine is noisy	1. Fluff or oil have collected on the hook or needle bar.	1. Clean the hook and feed dog as described.	107
	3. The needle is damaged.	3. Replace the needle.	16
	4. Slight humming sound coming from internal motor.	4. Normal.	-
	5. Thread is caught in the hook.	Remove the upper thread and bobbin case, turn the handwheel backwards and forwards by hand and remove the thread remnants.	107
	6. The feed dogs are packed with lint.		
Uneven stitches, uneven feed	1. Poor quality thread.	1. Select a better quality thread.	17
	2. The bobbin case is threaded wrong.	2. Remove the bobbin case, the thread and reinsert correctly.	11
	3. Fabric has been pulled.	3. Do not pull on the fabric while sewing, let it be taken up by the machine.	9
The sewing machine doesn't operate	1. The machine is not turned on.	1. Turn on the machine.	8
	2. The presser foot lifter is raised.	2. Lower the presser foot lifter.	20
	3. The machine is not plugged in.	3. Connect the power line plug to the electric outlet.	8
Embroidery unit does not move	1. The embroidery unit is not set up correctly.	1. Set the embroidery unit up correctly.	79
	2. No pattern selected.	2. Select a pattern.	85

Problem	Cause	Correction	Reference
Embroidery not neatly done	1. The thread is tangled and the bobbin case, etc., is plugged up.	1. Remove the tangled thread. When the bobbin case is plugged up, clean the race.	107
	2. The thread tension is incorrect.	2. Adjust the tension of the upper thread.	34
	3. The fabric is not fully stretched on the embroidery hoop. The fabric is loose.	3. Stretch the fabric properly on the embroidery hoop.	82
	4. No stabilizer material is attached.	4. Always use stabilizer material for embroidery with stretch fabrics, thin fabrics, fabrics with a loose weave and fabrics where stitches easily contract.	81
	5. Objects are placed near the carriage or embroidery hoop.	5. If the embroidery unit carriage or embroidery hoop bumps into objects, the pattern will be misaligned. Do not place objects within the range of embroidery hoop motion.	-
	6. Material coming out of the embroidery hoop is causing problems.	6. Stretch the fabric on the hoop once again so that the material coming out of the embroidery hoop does not cause problems, rotate the pattern and embroider.	-
	7. A heavy fabric is being embroidered, and the fabric is hanging off the table.	7. If embroidery is done with the fabric hanging off the table, the embroidery unit movement will be impaired. Support the fabric while embroidering.	-
	8. The fabric is catching. It is pinched.	8. Stop the sewing machine and set the fabric up correctly.	-
	9. The carriage was moved while the embroidery hoop was being removed or attached during embroidery.	9. If the carriage is moved during the process, the pattern may be misaligned. Be careful when removing or attaching the embroidery hoop.	-



[www.eversewn.com](http://www.eversewn.com)

