

## The Impact of a Fault Monitoring and Phasor Based Wide Area Measurement System in Assessing Performance of the GCC Interconnected System

### **Mohamed Al-Shaikh**

Director Maintenance and Asset Management  
GCCIA

### **Naser Al-Shahrani**

Director Operations and Control  
GCCIA

### **Dr Douglas Wilson**

Chief Technical Officer  
Psymetrix

### **David Cole**

Senior Technical Application Specialist  
Qualitrol

### **Peter Glover**

Senior Application Engineer  
Qualitrol

The GCC Interconnection Project has connected the electricity grids of six Arab Gulf countries along the Gulf to share power, reduce overall spinning reserve, reduce need for installed generation capacity for reserve, provide support during emergency and black out situations, and offer opportunities to trade energy with other regions. The GCC Interconnection Authority (GCCIA) operates the Interconnection grid from its control center at Ghunan (ICC) and is mandated to ensure high availability of the assets, manage power flows between the participating countries and maintain system stability under different operating scenarios. To assist in this GCCIA has commissioned a Fault Monitoring System (FMS) and phasor based Wide Area Monitoring System (WAMS) to evaluate performance via 'post mortem' analysis of transient events, for example line trips, switching, oscillations, power swings and frequency disturbances, as well as 'real time' display of operational data such as voltage magnitude, load, phase angle, frequency and system oscillations. The FMS was commissioned in 2012 and early results have already produced interesting data on system performance.

### The GCC Interconnected System

The project to interconnect the grids of six Gulf Countries has been implemented in three phases as shown in Figure 1.



**Phase 1** - the interconnection of Kuwait, Saudi Arabia, Bahrain and Qatar forming the GCC North Grid

**Phase II** - the interconnection of the independent systems in the United Arab Emirates (UAE) and Oman forming the GCC South Grid

**Phase III** - the interconnection of the GCC North and South Grids

Figure 1 - The GCC Interconnected System

**Phase 1** is the responsibility of the GCC Interconnection Authority (GCCIA) and consists of:

- A double-circuit 400 kV, 50Hz line from Al Zour (Kuwait) to Ghunan (Saudi Arabia) with an intermediate connection at Al Fadhili (Saudi Arabia) and associated substations.
- A back-to-back HVDC interconnection to the Saudi Arabia 380 kV, 60Hz system at Fadhili. Saudi Arabia is the only country in the Gulf with a system frequency of 60 Hz.
- A double circuit 400 kV comprising overhead lines and submarine link from Ghunan to Al-Jasra (Bahrain) and associated substations.

**Phase II** has been the responsibility of the UAE and Oman and consists of:

- A double circuit 220 KV from Al Oha (UAE) to M’hadah (Wasit Oman) and associated substations

**Phase III** completed the interconnection of the six (6) Gulf States and includes:

- A double circuit 400 kV line from Salwa to Shuwaihat (UAE) and associated substations.

The anticipated power exchange between the six participating States is shown in Figure 2.

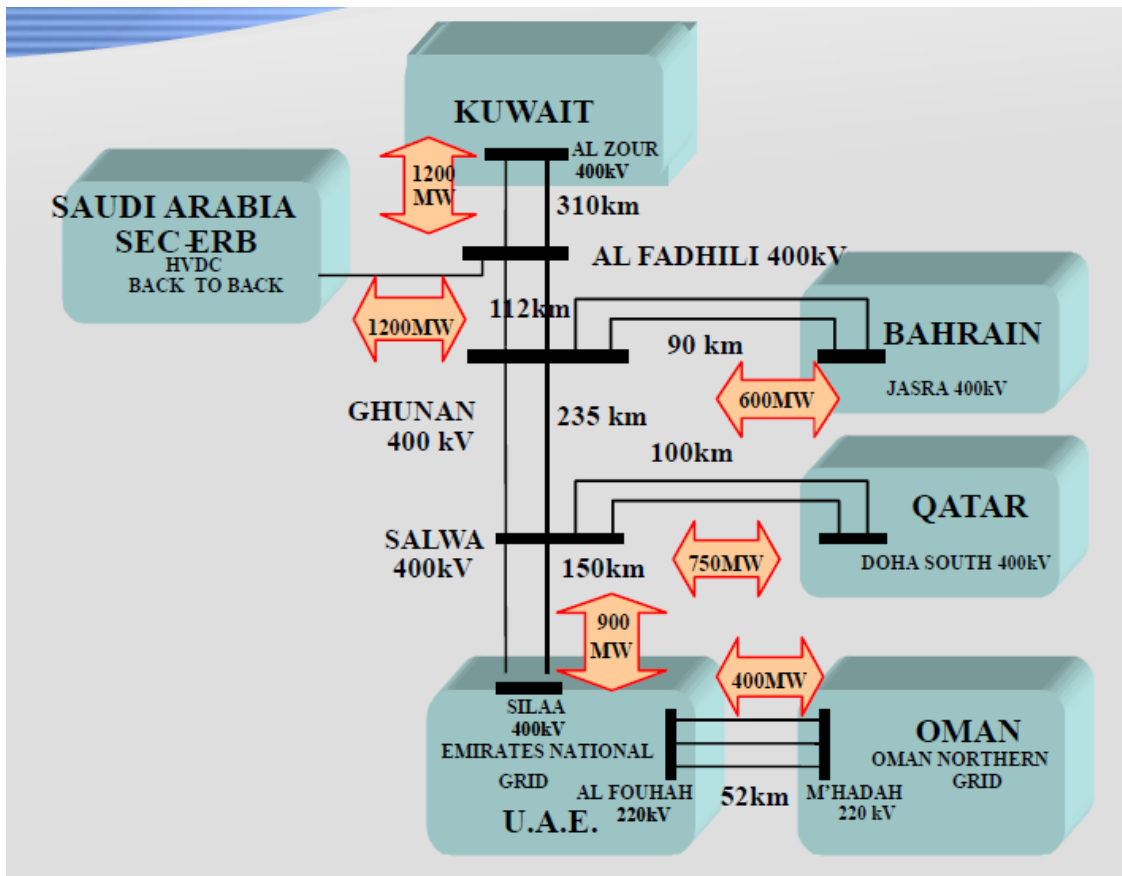

Figure 2 – Anticipated Exchange of Power between States

GCCIA is responsible for the Operation of the Interconnector from its Control Center at Ghunan with links to each member country's national control centers. The ICC mandate is:

- Assure the security of the interconnection and the member systems.
- Control the access to the interconnection
- Perform frequency and interchange regulation.
- Coordinate the operation of the interconnection
- Perform transaction recording and billing.

Interconnection of previously separate grids introduces new dynamic interactions. In particular, new inter-area modes oscillations occur because of interaction between groups of generators. It is important for system security that the stability of these oscillations is monitored and emerging threats are identified and addressed.

To assist in ensuring efficient operation of the Interconnector and maintain system stability under different operating scenarios, GCCIA have installed a Fault Monitoring System (FMS) and Wide Area Monitoring System (WAMS) at seven substations to monitor transient and system disturbances for post mortem analyses and real time display of system performance.

### The Fault Monitoring System (FMS)

An FMS has been installed at six substations on the North Grid and at Silaa, the link to the South Grid. The North Grid substations are Al Zour, Al Fadhili, Ghunan, Jasra, Salwa and RAQ (the transition point between the overhead line and submarine cable on the circuits to Bahrain).

The signals monitored at each site are as follows:

- 3 phase voltage and 3 phase currents for all 400KV AC feeders, reactors and transformers including the 50Hz side of the back to back DC link at Al Fadhili.
- Line voltages are used where available, otherwise busbar volts are connected.
- Two analogue channels are assigned to each phase current, one connected to the protection CT to for high level fault current and the other connected to the measurement CT for accurate measurement of load current.
- Circuit breaker trip coil currents via Hall Effect probes.
- Substation DC supplies
- Contacts from protection relays, trip relays and circuit breaker auxiliaries.

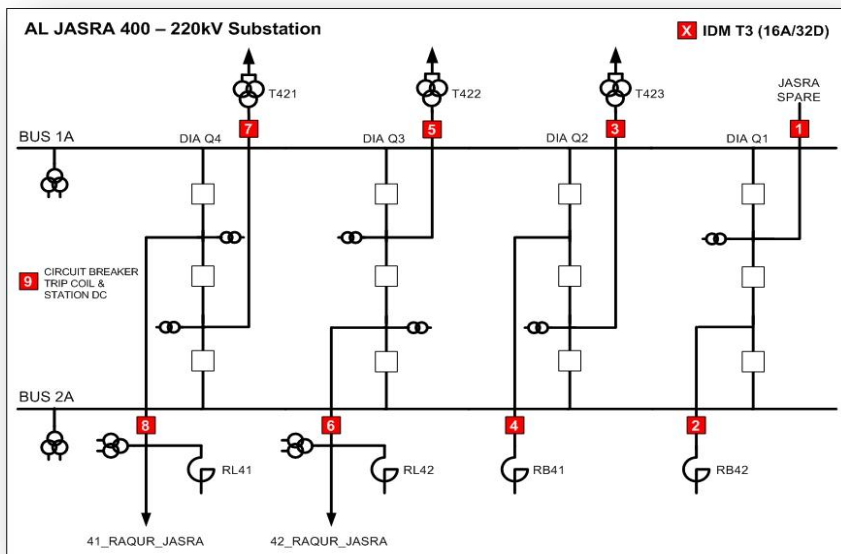

An example of fault recorder deployment is shown in Figure 3

Figure 3 – Recorder Deployment at Jasra using 9 devices

The FMS system offers the following functionality:

- Fault Recording – a triggered ‘transient’ record sampled at 6.4KHz with a typical duration of 1 second that can be longer depending on trigger conditions. This type of record shows the sinusoidal waveforms and relay operations with sufficient resolution to measure operate times and check for mal operation.
- Distance to Fault Calculations – derived from an impedance calculation and available on the device display in the substation or at the Master Station in the control room.
- Slow Scan recording – calculated values of rms magnitude, phase angle, power, frequency and sequence components are logged once per cycle in a continuous rolling buffer for up to 10 days. A segment of this data can be stored separately as a triggered record of duration up to 30 minutes depending on settings.
- Harmonic logging – selected harmonics up to the 50<sup>th</sup> and total harmonic distortion can be logged at one minute or 10 minute intervals for over a year. Measurements are to IEC 61000-4-7 class B.
- Phasor Measurements – phasors (magnitude and phase angle) of single phase quantities or sequence components are formatted in to data packets as defined by the IEEE C37.118 (2005) standard and streamed out on the ethernet port at rates up to 50 frames per second

Note that all recorders in the FMS system are time synchronized to a GPS source to an accuracy of 5  $\mu$ s. All recorders are accessible over an ethernet connection for configuration and download of data. An example of the communication architecture is shown in Figures 4 and 5.

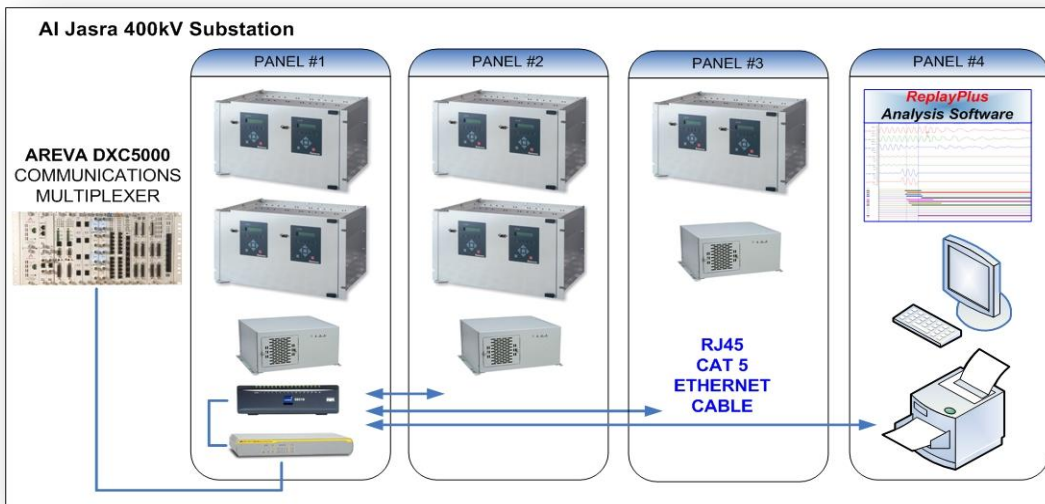

Figure 4 – Typical Communications within a Substation

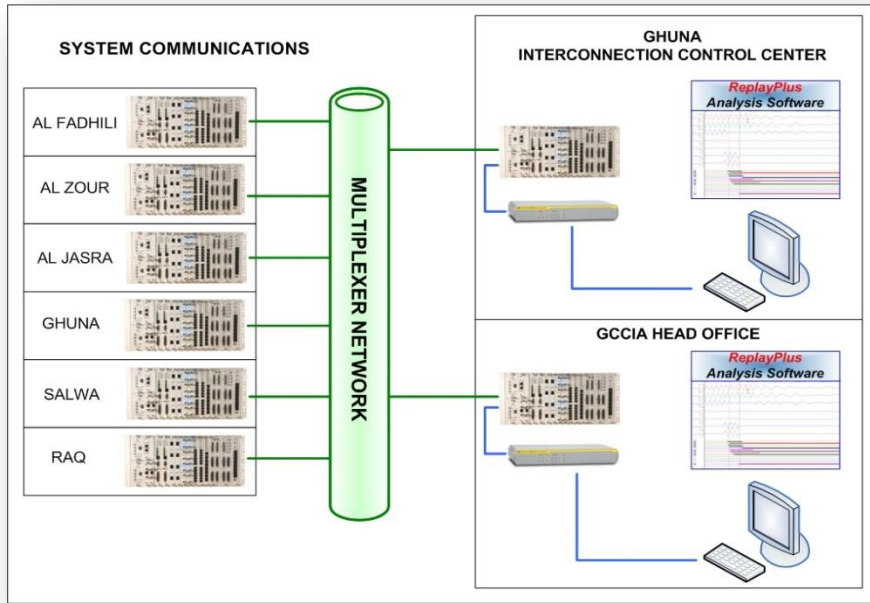
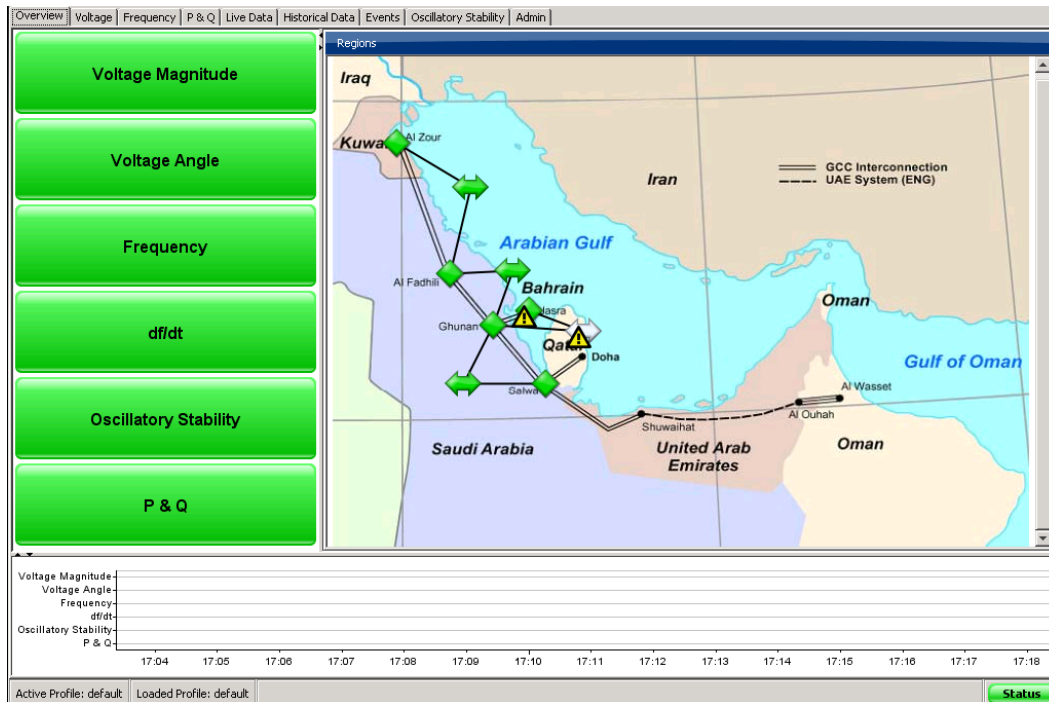

Figure 5 – Communications to the Control Room and GCCIA Head Office

### Wide Area Monitoring System

The phasors streamed from recorders at five sites are collected in a Phasor Data Concentrator (PDC), time aligned and stored in a database. Specialist software is then used to process the phasors and drive a real time display alerting operators to any abnormal conditions with load flows, angular separation, disturbances, or system oscillations. An example of the display in the control room is shown in figure 6.



The green buttons on the left indicate normal operating conditions. The arrows on the map indicate phase angle and magnitude. Arrows aligned indicate consistent phase angle difference between the measurement nodes

Figure 6 – Typical Real Time Display in the Control Room

Alarm points can be set based on load, frequency, voltage magnitude, oscillations and phase angle difference. Stability of oscillations in the system is assessed in real time allowing Operators to take remedial action when necessary before reaching instability and potentially dangerous oscillation amplitude causing lines to trip.

### Initial Results from Recorders

The FMS system has only been commissioned for a few months at the time of writing this paper but the following different types of events have already been captured.

#### Phase to Earth Fault on the Salwa – Ghunan Line

The fault record from Salwa is shown in figure 7. It shows a red phase to neutral fault with a clearance time of about 2.5 cycles. The time axis has been compressed to show the voltage resonance on the line after the circuit breaker was tripped. It is assumed the line reactors that remain connected are responsible for this. Note that the yellow and blue phase currents have a higher gain setting and are showing load currents.

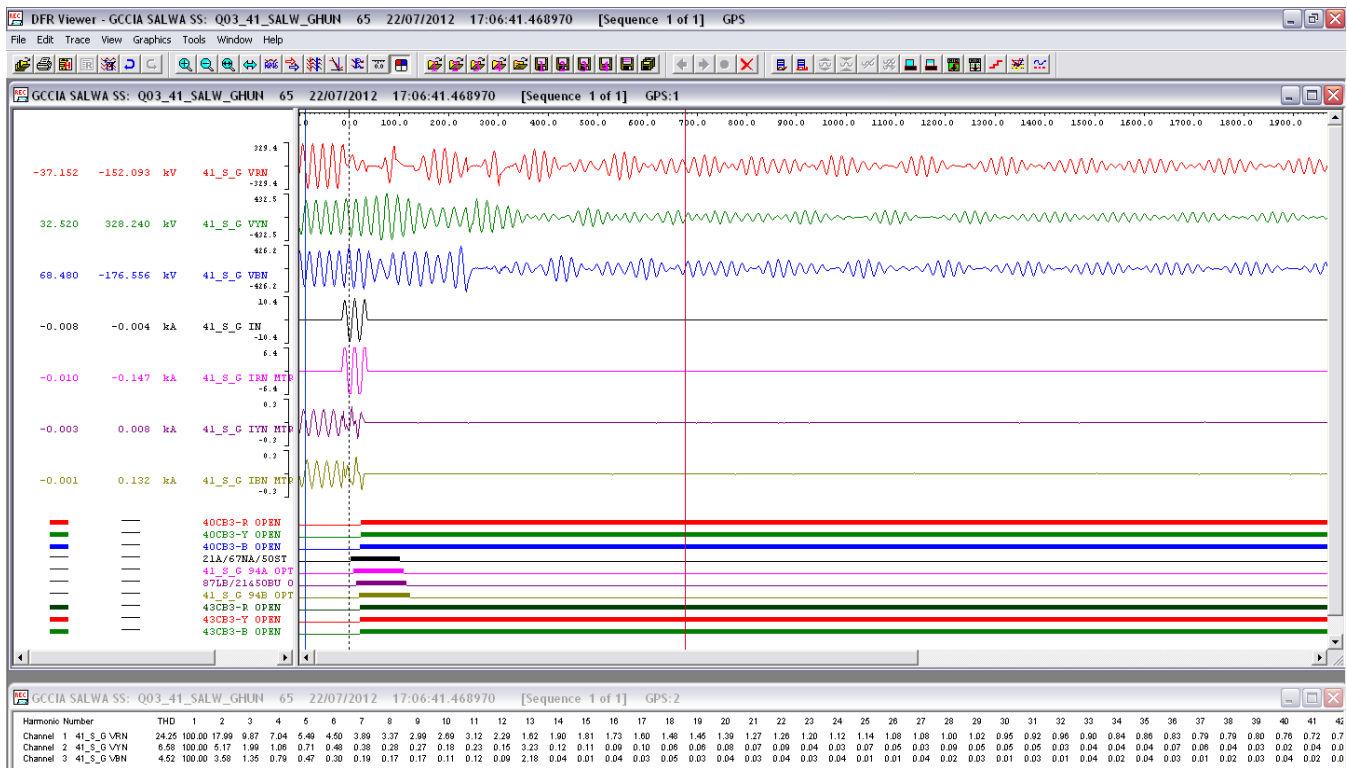

Figure 7 – Compressed View of Phase to Earth Fault Showing Resonance After the Trip



A more expanded view showing the waveforms in more detail is shown in figure 8. The fault current was 6.99KA. It is also possible to see in more detail a higher frequency voltage oscillation just after the fault inception that is repeated after the trip when the line is resonating.

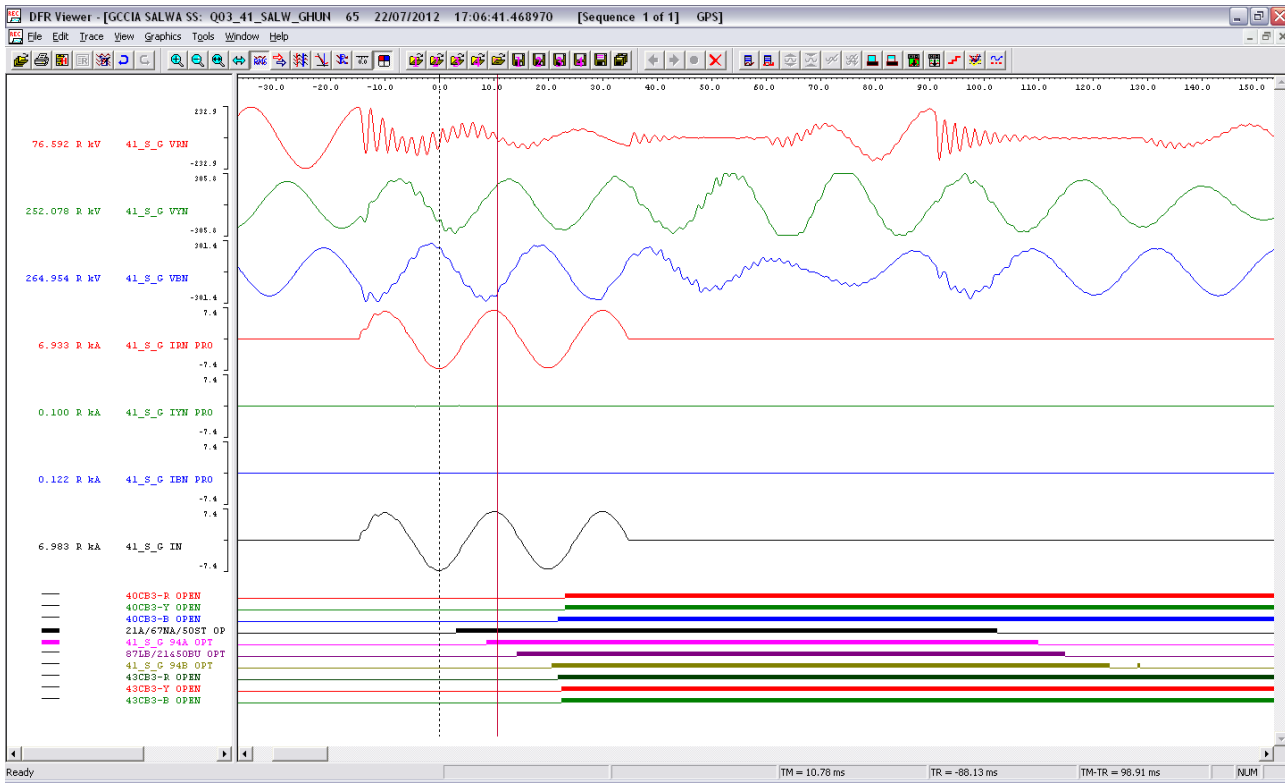
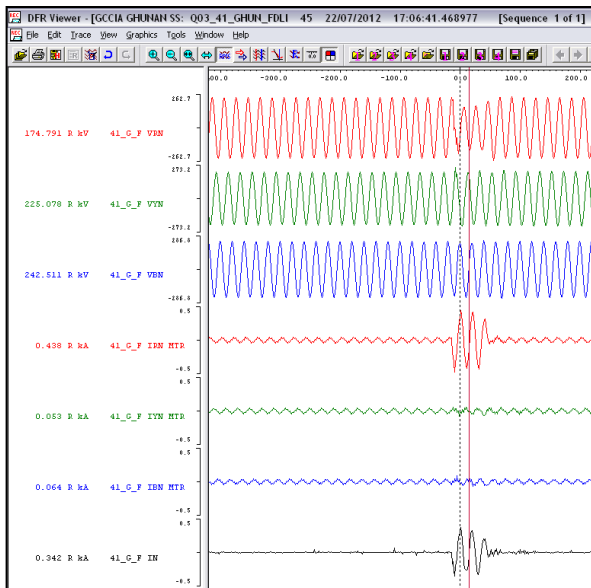

Figure 8 – Expanded View of Phase to Earth Fault



The fault above caused a trigger on a recorder at Ghunan monitoring the Al Fadhili line. Fault current was recorded (438A) and a voltage dip observed but, as expected, the line did not trip. The record is shown in figure 9.

Figure 9 – Contribution to Fault Current Detected on Adjacent Line

## Instance of Harmonics

Fault records have been produced showing periods of harmonic content. Figure 10 shows the three phase voltage waveforms at Al Zour with a high level of predominantly 11<sup>th</sup> harmonic for about 5 cycles.

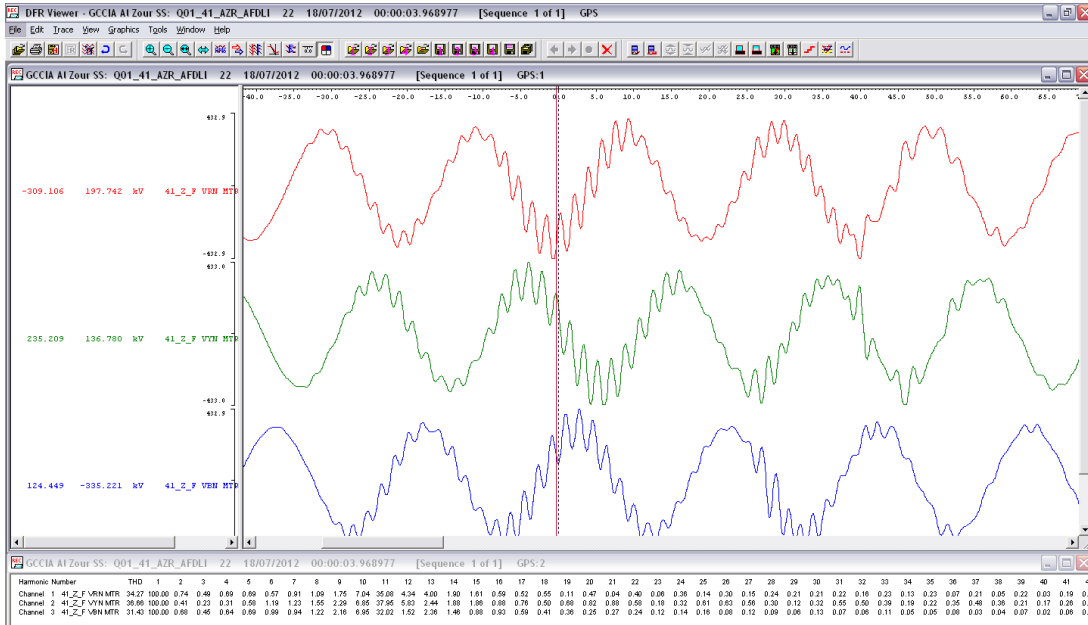

Figure 10 – Detection of 11<sup>th</sup> Harmonic

Figure 11 shows another instance of harmonic activity on a slow scan record. Two days worth of 10 minute average harmonic data on the Ghunan-Al-Fadhili line shows a THD of 2.99% that is predominantly 13<sup>th</sup> harmonic. The harmonic abruptly stops when the converter is blocked.

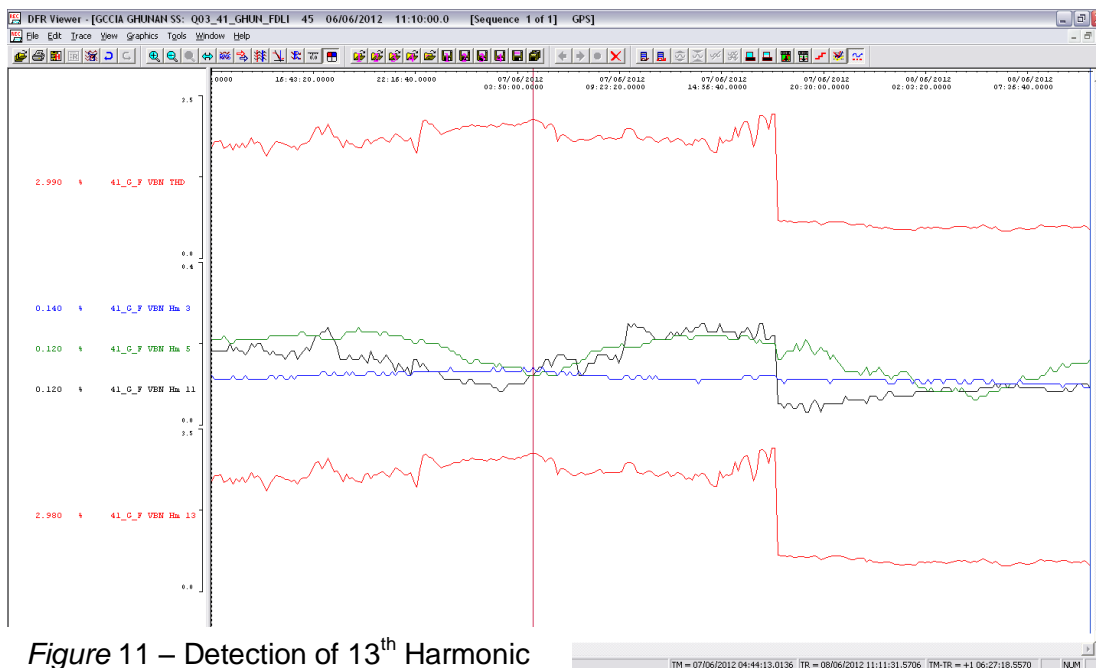

Figure 11 – Detection of 13<sup>th</sup> Harmonic



## Detection of Power Swing

Figure 12 shows an example of a damped power swing detected at AL Zour which confirm results of operational studies performed. The top traces are the 3 phase rms voltages showing slight differences. The traces below are the 3 phase rms currents that are virtually identical followed by the MW and MVar traces. The maximum peak to peak swing was 218MW but heavily damped within 10 seconds with a decaying tail lasting another 10 seconds.

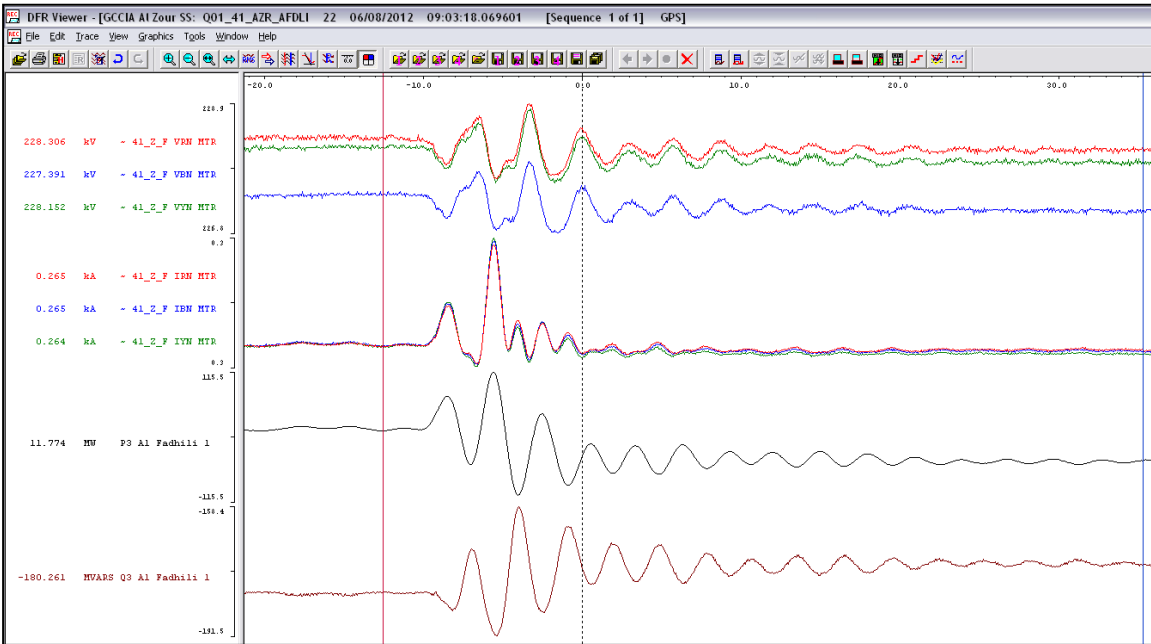

Figure 12 – Detection of Power Swing at Al Zour

## Detection of Voltage Dip Followed by Change in Power Transfer

This example is a slow scan record showing a voltage dip of about 100mS followed by a gradual decline in MW and an increase in MVars. The record, figure 13, was from Al Zour.

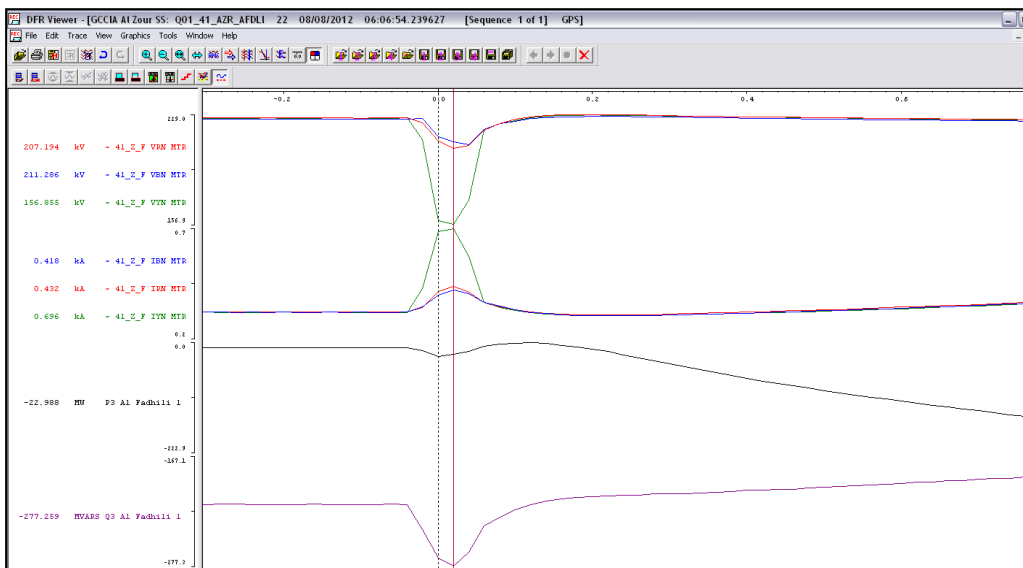

Figure 13 – Detection of Voltage Dip

The top traces are 3 phase volts with the yellow phase dropping to 156.8KV. The next traces are 3 phase currents with the yellow current rising to 696A. The next trace is MW followed by MVars

## Detection of Circuit Breaker Pole Spread

The last example of a DFR record captured an instance at Al Fadhili of significant pole spread (35mS) between the red phase and yellow and blue phases for a close operation. Figure 14 shows the result. The difference can be seen in the analogue voltage channels and the operation of the auxiliary contacts.

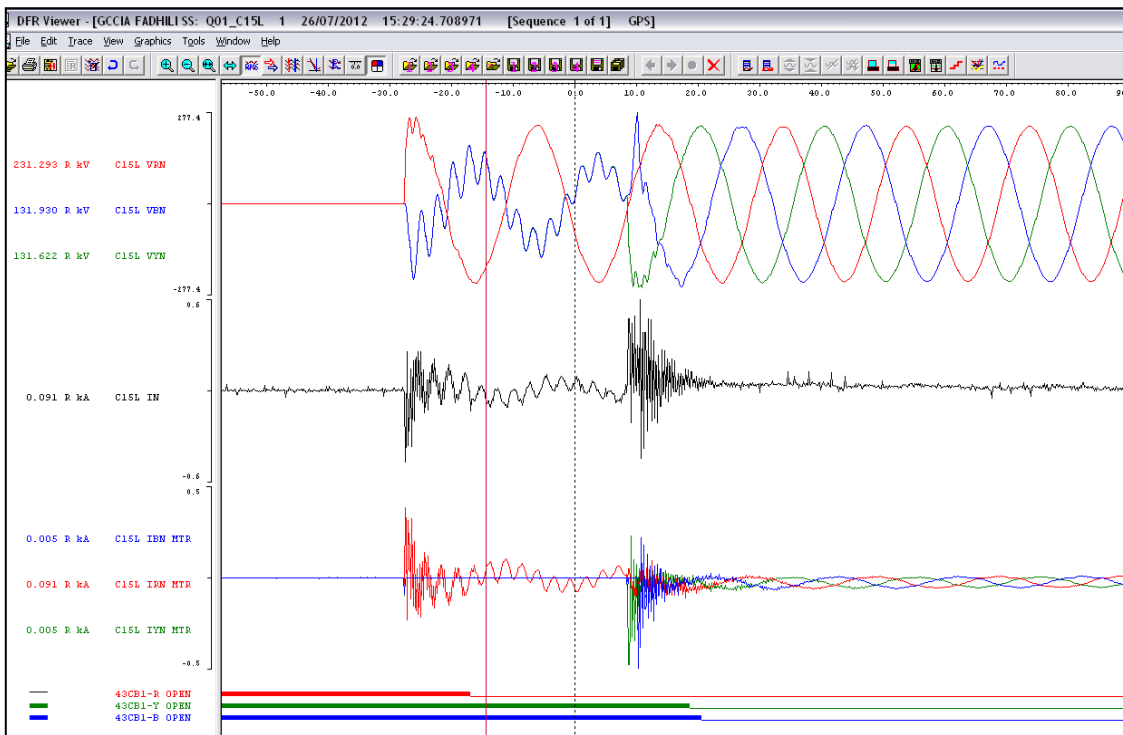

Figure 14 – Detection of Pole Spread on a Breaker Close Operation

## Initial Results from the WAMS

The WAMS software has detected several disturbances and oscillations. These events have been flagged in real time by appropriate use of alarm settings with information being made available to operators for immediate analysis.

## Response to a Loss of Generation

Figure 15 and 16 show 2 examples of system response to a loss of generation. The resultant drop in frequency causes other generators to increase output. The refresh rate of the data is sufficiently high to represent the dynamic response of the system to the event. The information provided by the measurement system is:

- The events in the examples are generation loss, as the frequency drops; load loss and line loss can also be identified

- The frequency and angle information indicates the closest monitored location where the generation loss has occurred. Records show earliest movement close to generation loss. In Figure 15, the measurement points the loss of generation nearer to the north of the system with a fastest response at Al Zour.
- The angle and frequency information allows an assessment of the impact of the event on the system
- The system shows a damped transient response, with a dominant mode frequency of 0.26Hz in Figure 16.



Figure 15 – System Frequency Information for a Generator Trip

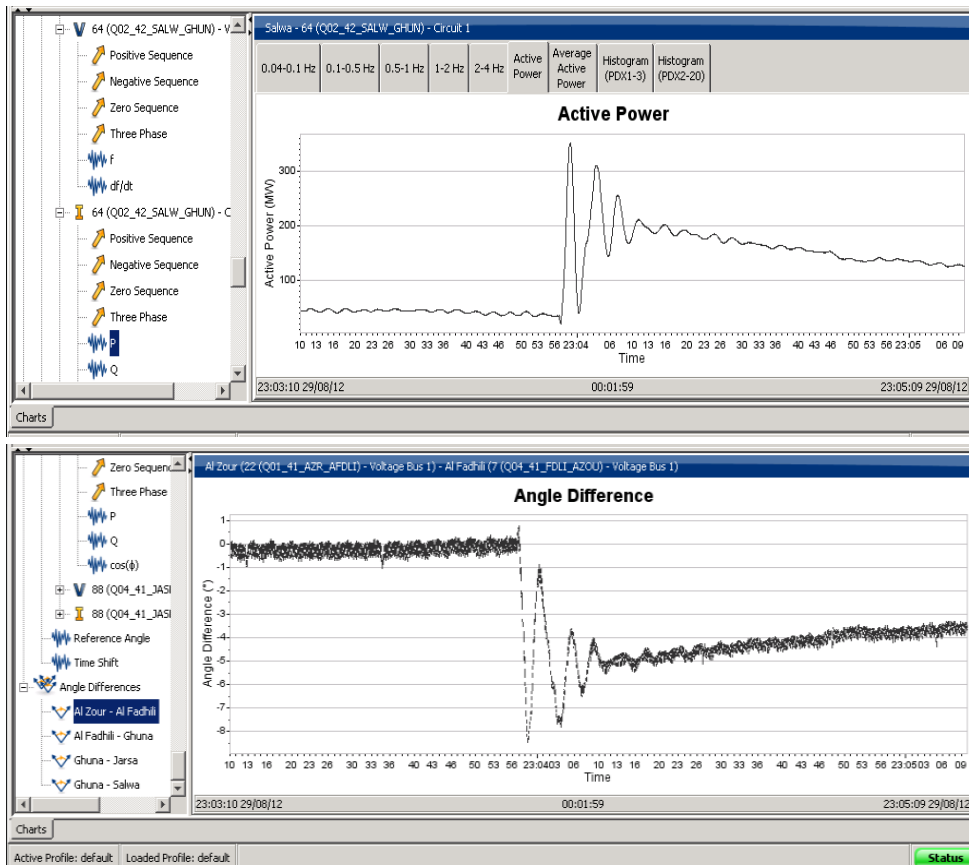

Figure 16 – Power and Angle Disturbance Information for a Generator Trip

### Detection of System Oscillations

,Since the interconnection spans around 1000km from north to south , as shown by the early Operational Studies of Phase I and Phase III, there is a tendency for the system to experience low frequency inter-area oscillations. It is important that the dynamic performance of the whole interconnection is managed in such a way that all oscillations including the inter-area modes remain damped.

From observations so far, it is noted that there is an inter-area mode at 0.26Hz that is observed at all of the monitored locations, and the measurements suggest that it is likely to extend to the south-eastern end of the interconnection. In the observed part of the system, the oscillations are in phase, indicating a coherent group of generators from Kuwait through to Qatar, as illustrated in the real time display in Figure 17. There are also oscillations in power from the most southerly monitoring point at Salwa towards the south east, suggesting that there is likely to be a group of generators oscillating in the south east end of the overall power system

At times, the 0.26Hz inter-area mode oscillations are quite lightly damped, as illustrated in Figure 18. The Phasor software enables long-term monitoring of the performance of the mode, and indicates periods of time when damping is degraded. Operational measures can be taken through oscillation alerts and alarms and operator guidance to reduce the risk of instability. Generally, alerts are used as early warnings to allow operators to prepare a course of action, while alarms are triggered by more serious poor damping and raised amplitude events, or undamped or growing oscillations. An alarm indicates to the operator that action is justified. Specific actions can be defined through study of the

observed behavior, but generally involve reducing generation at the periphery of the system and dispatching more power at the centre. In the longer term, the damping of the system can be improved by control system design in accordance with operational studies performed which recommended installation of the PSS in specific locations within the Member States and by strengthening the interconnection with new or upgraded transmission line connections.



Figure 17 - Mode Shape of 0.26Hz mode in Observed Part of the Network

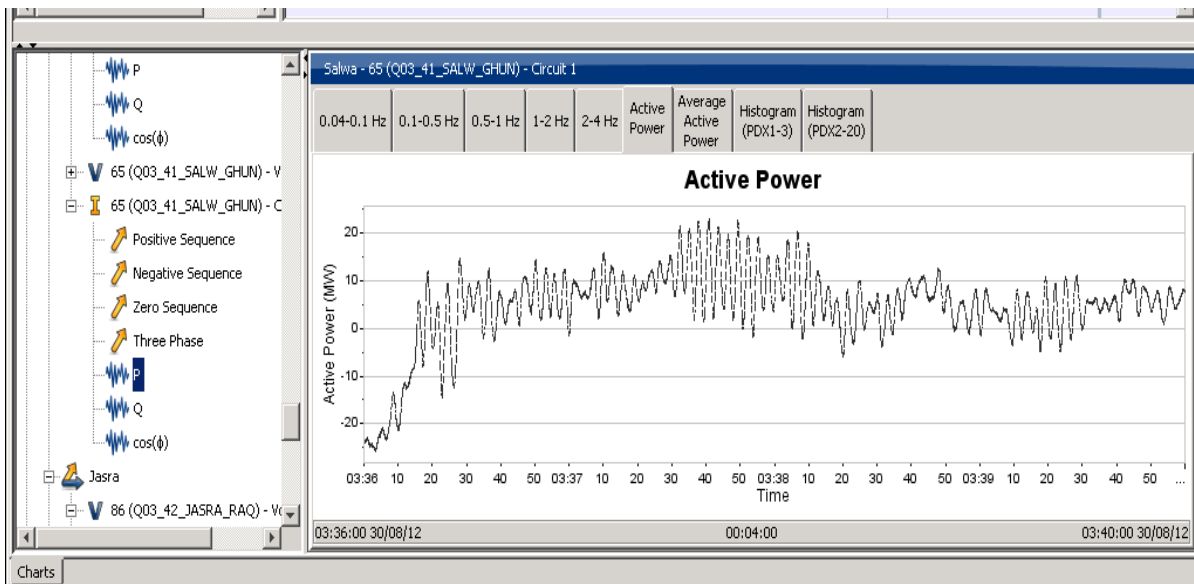

Figure 18 - Example of a period of lightly damped 0.26Hz mode oscillations

Another observation of nearly undamped oscillation (Figure 19) has been monitored in the low frequency range around 0.05Hz. During the event, the oscillations reached 10MW peak-to-peak. In that case, detecting and correcting the problem could be investigated using WAMS by analysing the relative phase of oscillations in power and frequency measurements.

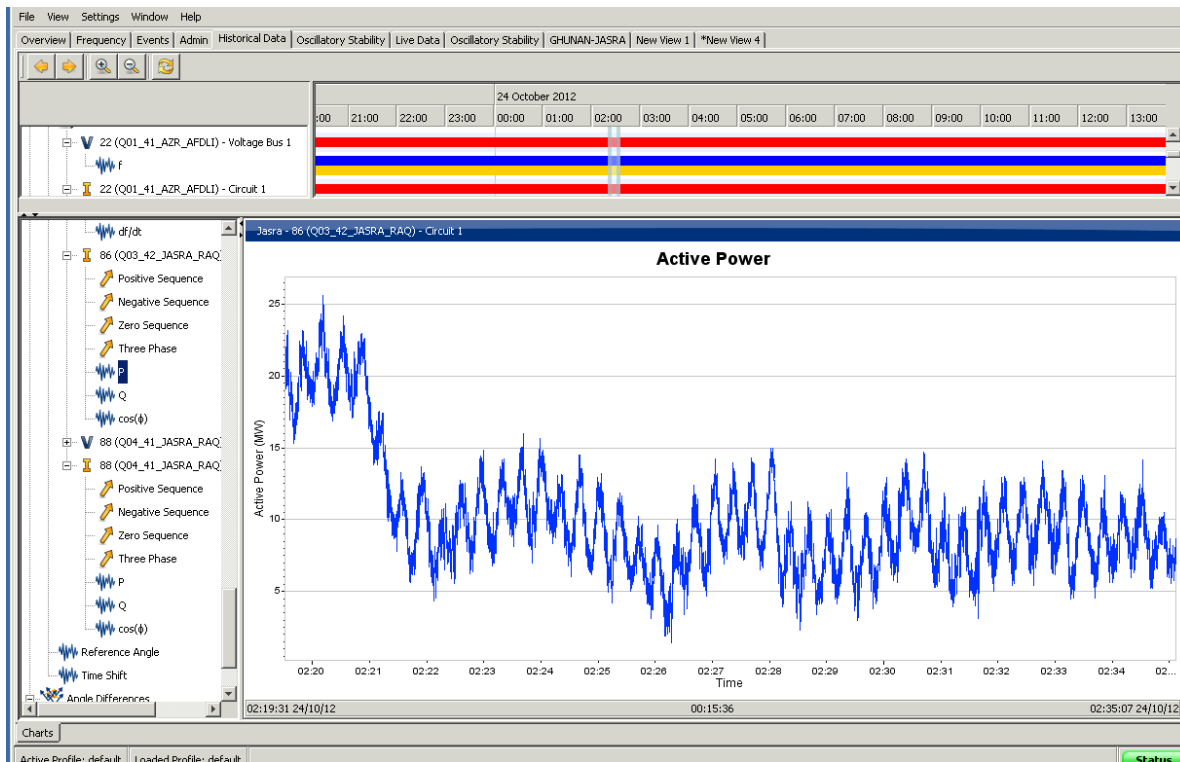

Figure 19 - Example of a period of nearly undamped 0.05Hz mode oscillations

## Conclusions

The FMS and WAMS have only been in operation for a short time but have already produced results that have enhanced the understanding of the transient and dynamic response of the GCC Interconnection and confirm the results of operational studies performed prior to the commissioning of the interconnection. The FMS has shown a resonance effect after a line trip, harmonic activity linked to the DC converter, a breaker with an excessive pole spread and voltage dip and power swing events. The WAMS has measured the system response to a loss of generation and determined the dominant oscillation modes of the network with an indication of how the generation in each part of the system relates to the other.

Wide Area Monitoring of system performance is particularly important in the GCCIA interconnected network, because of the long distances involved and potential economic benefit for increasing the co-operation between Gulf states. In this context, it is important to identify and manage the dynamic performance and security of the power system and maximize the power flows through the network. Further analyses of FMS transient and disturbance data will improve the understanding of the transient response, highlight potential weaknesses in the assets that can be corrected and thereby enhance the system security.