



Owner's Manual and Assembly Instructions

Model #: 22-PS311

Model Name: Westport 8-Leg Swing Set
Manual Issued: April, 2009



Important: Keep this owner's manual; do not discard in case you need to contact Pacific Cycle, Inc. in the future. Should there be a change of ownership, please transfer this manual to the new owner to ensure proper assembly and safety.

90 DAY LIMITED WARRANTY

Pacific Cycle, Inc. warrants this product to be free of defective materials and workmanship for 90 days from the date of original purchase.

THIS LIMITED WARRANTY IS THE ONLY WARRANTY APPLICABLE TO THIS PRODUCT, AND IS EXPRESSLY IN LIEU OF ANY OTHER WARRANTY. ANY IMPLIED WARRANTIES, INCLUDING ANY WARRANTY OF MERCHANTABILITY AND WARRANTY OF FITNESS FOR A PARTICULAR PURPOSE, IS LIMITED IN DURATION TO THE DURATION OF THIS EXPRESS WARRANTY. This limited warranty gives you specific legal rights and you may also have other rights which may vary from state to state. This warranty is extended only to the original consumer purchaser for non-commercial use.

PACIFIC CYCLE, INC. IS NOT RESPONSIBLE FOR INCIDENTAL OR CONSEQUENTIAL DAMAGES. THIS LIMITED WARRANTY DOES NOT COVER ANY PERSONAL INJURIES, DAMAGE TO, OR FAILURE OF THE PRODUCT OR ANY OTHER LOSSES DUE TO ACCIDENT, ABUSE, MISUSE, ALTERATION, NEGLIGENCE, NORMAL WEAR AND TEAR, RUST, IMPROPER ASSEMBLY, IMPROPER FIT, IMPROPER MAINTENANCE OR USE OF UNAUTHORIZED REPLACEMENT PARTS NOT DESIGNED FOR THE PRODUCT.



To make claim under warranty, notification of such defect must be given to Pacific Cycle, Inc. By calling the phone number below, you will be instructed on how the product or part needing replacement should be shipped postpaid to Pacific Cycle, Inc.

Customer Service and Assistance

1-800-242-6110

Monday – Friday 8am-5pm CST

Please contact the Playsafe™ customer service team if you have any questions about our product, need assembly assistance or need replacement parts for the swing set. You may also contact us by mail:

Playsafe™ Customer Service

Pacific Cycle, Inc

4730 East Radio Tower Lane

Olney, IL 62450

Or by email: info@Playsafeoutdoors.com



WARNINGS AND SAFETY INFORMATION

OBSERVE ALL WARNINGS AND STATEMENTS IN ORDER TO REDUCE THE RISK OF INJURY OR DEATH.

- **BEFORE YOU ASSEMBLE THE SWING SET, FIND LEVEL GROUND NOT LESS THAN 6 FEET FROM ANY STRUCTURE OR OBSTRUCTION TO THE SWING SET. YOUR SWING SET MUST HAVE CLEARANCE ON ALL SIDES.**
- **TO PREVENT SERIOUS INJURY, DO NOT ALLOW CHILDREN TO PLAY ON THE SWING SET UNTIL IT IS COMPLETELY INSTALLED.**
- **DO NOT INSTALL THE SWING SET OVER CONCRETE, PACKED DIRT, OR ANY OTHER HARD SURFACE. A FALL ONTO A HARD SURFACE CAN RESULT IN SERIOUS INJURY OR DEATH TO THE USER.**
- **ONLY ADULTS SHOULD ASSEMBLE OR DISASSEMBLE THIS SWING SET.**
- **THIS PRODUCT MUST BE ANCHORED. ANCHORS ARE SOLD SEPARATELY. CALL 1-800-242-6110 OR EMAIL INFO@PLAYSAFEOUTDOORS.COM**
- **ADULT SUPERVISION OF CHILDREN IS REQUIRED AT ALL TIMES WHEN ON OR AROUND THIS SWING SET. NEVER LEAVE CHILDREN UNATTENDED.**
- **DO NOT SWING TOO HIGH OR AT AN ANGLE.**
- **DO NOT HANG ON OR CLIMB FROM STRUCTURAL MEMBERS OF THE SWING SET.**
- **DO NOT EXCEED THE INTENDED WEIGHT LIMIT OR MAXIMUM NUMBER OF USERS FOR THE SWING SET.**
- **THE INTENDED AGE FOR USE OF THIS PRODUCT IS 2 YEARS TO 10 YEARS OLD, UNDER ADULT SUPERVISION. CHILDREN UNDER 2 YEARS HAVE A HIGHER RISK OF ENTRAPMENT AND INJURY.**
- **BE SURE TO OBSERVE YOUR CHILDREN AND INSURE THAT THEY HAVE THE STRENGTH AND SKILLS TO ENJOY ALL THE RIDES SAFELY BEFORE USE ON THEIR OWN.**
- **DO NOT ALLOW CHILDREN TO WALK CLOSE TO, BEHIND, OR IN FRONT OF MOVING ITEMS.**
- **DO NOT ALLOW CHILDREN TO TWIST SWING CHAINS OR LOOP THEM OVER THE TOP BAR. THIS MAY REDUCE THE STRENGTH OF THE CHAIN.**
- **TEACH AND INSTRUCT CHILDREN NOT TO SWING EMPTY SEATS.**
- **INSTRUCT CHILDREN HOW TO SIT IN THE CENTER OF THE SEATS AND SWING WITH THEIR FULL WEIGHT ON THE SEAT.**
- **WARN CHILDREN NOT TO USE THE EQUIPMENT IN ANY MANNER OTHER THAN INTENDED.**
- **WARN CHILDREN NOT TO GET OFF THE RIDES WHILE IN MOTION.**
- **WARN CHILDREN TO DRESS APPROPRIATELY. LOOSE FITTING CLOTHING IS POTENTIALLY HAZARDOUS WHEN USING THE SWING SET.**
- **EQUIPMENT MAY BE SLIPPERY WHEN WET. DO NOT ALLOW CHILDREN TO USE THE EQUIPMENT WHEN WET.**
- **PARENTS SHOULD REGULARLY CHECK OPENINGS AND SURFACES, SUCH AS SLIDES, FOR ITEMS THAT MAY BE HAZARDOUS.**
- **PARENTS SHOULD CHECK SWING CHAINS TO INSURE THEY ARE SECURE AND CAN NOT BE LOOPED BACK ON THEMSELVES.**
- **DO NOT PLACE ANY PART OF THE BODY NEAR MOVING PARTS ON GLIDE RIDES OR TOP BRACKETS.**
- **NEVER SLIDE HEAD FIRST DOWN THE SLIDE.**
- **VERIFY THAT ALL SWINGS AND CHAINS ARE SECURED AT BOTH ENDS.**
- **NEVER ATTACH ANY MATERIALS THAT ARE NOT SPECIFICALLY DESIGNED FOR USE WITH THIS SWING SET, SUCH AS JUMP ROPES, PET LEASHES, ROPE OR CORDS AND OTHER CHAINS AS THESE POSE A POTENTIAL STRANGULATION HAZARD.**
- **WHEN DISPOSAL OF THE SWING SET BECOMES NECESSARY, FULLY DISASSEMBLE AND KEEP PARTS OUT OF REACH FROM CHILDREN UNTIL THEY CAN BE SAFELY HAULED AWAY.**



PROPER USE

This swing set is designed for use by children ages 2 to 10 under adult supervision. The maximum number of users this unit is intended for is 9 children with a maximum weight of 105 lbs each. The maximum fall height for this swing set is 74” and the maximum fall height for the see saw is 48”.

Single Ride (i.e. Swing) 105 lbs
Double Ride (i.e. Glider) 210 lbs

This product is designed for normal residential use only. This product is not designed for use in day care, nurseries, or other public places. This product is to be assembled by adults only in the manner described within this owner’s manual. The swing set must be anchored. **Anchors are not included in this carton.** For more information on anchoring, please see the section below.

ANCHORING

ANCHORING is necessary to prevent tipping, lifting, and overturning. Playsafe™ recommends anchoring the swing set in concrete, especially in soft or sandy soil. When this is not possible, anchors can be purchased by calling 1-800-242-6110.

To anchor the swing set in concrete, dig a hole at least 5” deep and 10” to 12” in diameter. Place the swing set leg in the hole, preferably on a brick or stone to keep it from sinking. Be sure the swing leg is set 3” below the ground. Also make sure the swing set is level. Pour concrete around the legs and fill the hole. Cover concrete adequately using the recommended surfacing instruction in this manual. Allow the concrete to cure according to the concrete manufacturer’s instruction before use.

CONSUMER INFORMATION FOR PLAYGROUND SURFACING MATERIALS

The U.S. Consumer Product Safety Commission estimates that 100,000 playground related injuries are treated annually in U.S. hospital emergency rooms. Injuries involving this hazard pattern tend to be among the most serious of all playground injuries, and have the potential to be fatal, particularly when the injury is to the head. The surface under and around the playground equipment can be a major factor in determining the injury-causing potential of a fall. It is self-evident that a fall on a shock-absorbing surface is less likely to cause a serious injury than a fall onto a hard surface. Playground equipment should never be placed on a hard surface such as concrete or asphalt and while grass may appear to be acceptable it may quickly turn to hard, packed earth in areas of high traffic. Shredded bark mulch, wood chips, fine sand or fine gravel are considered to be acceptable shock absorbing surfaces when installed and maintained at a sufficient depth under and around playground equipment.

The following table lists the maximum height from which a child would not be expected to sustain a life-threatening injury in a fall onto four different loose-fill surfacing materials if they are installed and maintained at depths of 6, 9, and 12 in. However, all injuries due to a fall can not be prevented no matter what surfacing materials are used.

FALL HEIGHT IN FEET FROM WHICH A LIFE THREATENING INJURY WOULD NOT BE EXPECTED			
Material Type	6 in. depth	9 in.	12 in.
Double Shredded Bark Mulch	6’	10’	11’
Wood Chips	6’	7’	12’
Fine Sand	5’	5’	9’
Fine Gravel	6’	7’	10’

It is recommended that a shock absorbing material should extend a minimum of 6’ in all directions from the perimeter of the stationary equipment such as climbers and slides. However, because children may deliberately jump from a moving swing, the shock absorbing material should extend in front and rear of the swing a minimum distance of 2 times the height of the pivot point measured from a point directly beneath the pivot on the supporting structure.

The information is intended to assist in comparing the relative shock-absorbing properties of various material. No particular method is recommended over another. However, every material is only effective when properly maintained. Materials should be



checked periodically and replenished to maintain correct depth as determined necessary for your equipment. The choice of a material depends on the type and height of the playground equipment, the availability of material in your area and its cost.

(The information above has been extracted from CPSC documents ‘Playground Surfacing – technical Information guide’ and ‘Handbook for public Playground Safety.’ Copies of these documents can be obtained by sending a postcard to the: Office of Public Affairs, USCPSC, Washington D.C., 20207 or by calling 1-800-638-2772.

CARE AND MAINTENANCE

- Check all nuts and bolts twice monthly during the usage season for tightness and tighten as required. It is particularly important that all nuts and bolts are checked prior to the first use each season.
- For extended use, remove plastic swing seats and take indoors when the temperature drops below 32° F.
- Oil all metallic moving parts monthly during the usage season.
- Check all coverings for bolts and sharp edges weekly during usage season to be certain they are in place. Replace as needed. It is particularly important that all coverings are checked prior to the first use each season.
- Sand any rusted areas of the tubing and repaint with a non-lead based paint meeting the requirements of Title 16 CFR Part 1303.

LOCATION AND PLACEMENT OF YOUR SWING SET

- Place your swing set a **MINIMUM of six (6) feet from any other hard or fixed object.**
- **Do not place your swing set underneath electrical lines. If you must, ensure that there is a minimum overhead clearance of six (6) feet.**
- **Please note the CPSC surfacing materials recommendations on page 3.**

TOOLS REQUIRED FOR ASSEMBLY

Your swing set comes with two 5mm Allen wrenches for the assembly of most of this product. You may also need to have the following tools available:

- Adjustable wrench
- Phillips screwdriver
- Needle-nose pliers (recommended)

Although we take pride in the quality of our swing sets, on occasion there may be a burr or rough part which will require a metal file to remove before use.

PARTS LIST FOR SWING SET

Main Frame

<u>Name</u>	<u>Each</u>
Top Bar Sections	3
Leg Sections	8
Leg Fittings	4
Support Bars	4

Glider

<u>Name</u>	<u>Each</u>
Glider Poles (vertical) with Foot Rests	2
Glider Poles (horizontal) with Seats	2
Glider Frame Attachment	1

Swings and Trapeze

<u>Name</u>	<u>Each</u>
Swing Seats with Chains	2
Rope Disc with Rope	1
Trapeze with Chains	1

See-Saw

<u>Name</u>	<u>Each</u>
Seats	2
See Saw Bar	1
Support Bar	1
Ground Extension	1



Slide Name	Each
Rail/Ladder Leg	2
Front Leg	2
Slide	1
Ladder Step	2
Leg Support Bar	1

PRE-ASSEMBLED HARDWARE

For easier assembly, Playsafe™ has pre-assembled some of the parts for you. Most of the screws and bolts should already be in place. If removal of this hardware is required for certain assembly steps, it should be replaced in its original position. Hardware shown in the assembly steps are actual size.

MAIN FRAME ASSEMBLY



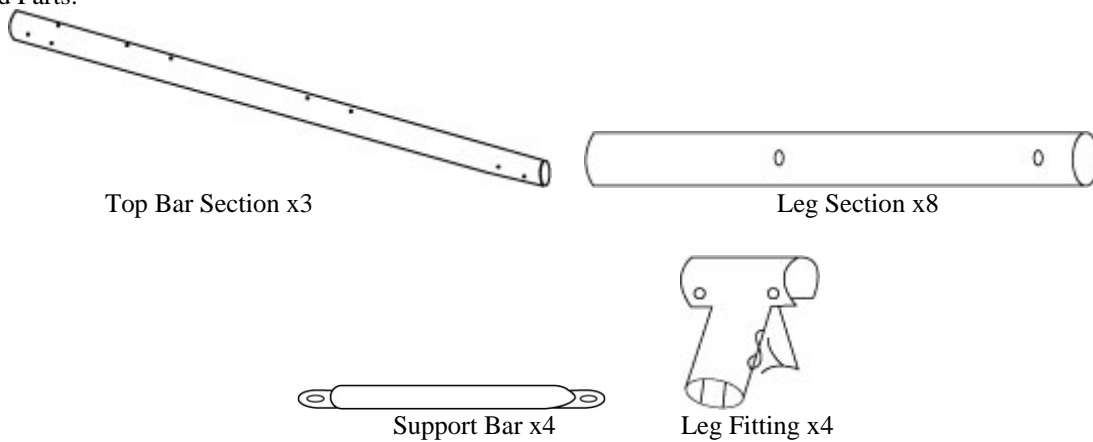





Required Parts:

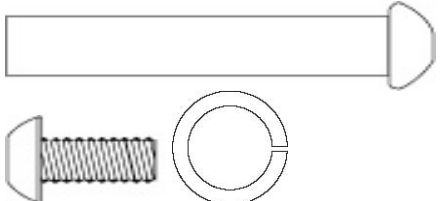

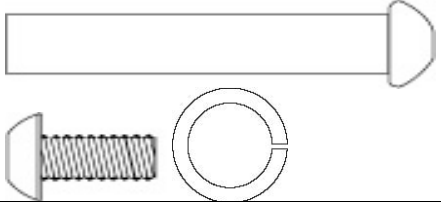
Pre-Assembled Parts:

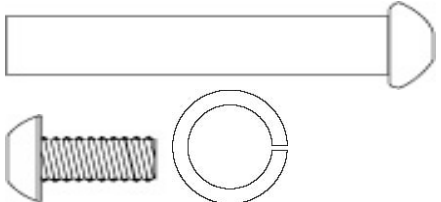
- Corner leg fittings should be attached to two of the top bar sections.
- Swing, trapeze, and rope disc hooks should be in place on the top bar sections.
- Hardware for connecting the legs to the leg fittings should be in place in the leg fittings.
- Hardware for the support bars should be in place on the leg sections.

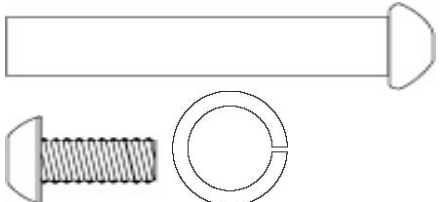
Step	Illustration	Instructions	Hardware Reference
1		Join the three sections of the top bar together by connecting through the center leg fittings. Remove the hardware, connect the top bar sections through the leg fitting, align the holes, and reinsert the hardware. NOTE: The top bar section which has only one hook attached should be placed in the middle.	Part Ref. #: PSHW10

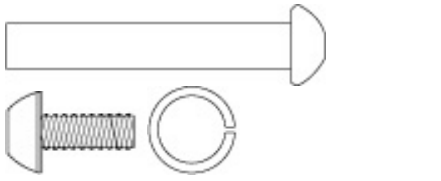
2		<p>Remove the hardware from the arm of a corner leg fitting in order to insert one of the legs.</p> <p>NOTE: Four leg sections are shorter than the others. These are the center legs. Also, one leg has two holes near the base. The see-saw attaches to this leg and needs to be placed on the opposite side of the slide.</p>	<p>Part Ref. #: PSHW10</p> 
4		<p>Align the two sets of holes and replace the hardware through the corner leg fitting and leg to secure.</p>	<p>Part Ref. #: PSHW10</p> 
5		<p>Repeat the process for the other side of the corner leg fitting.</p>	<p>Part Ref. #: PSHW10</p> 
6		<p>Assemble the center legs and the remaining outside legs in the same manner as above and then stand the swing set frame upright.</p>	<p>Part Ref. #: PSHW10</p> 
7		<p>Remove the hardware for the support bars from the leg sections. Match up the holes of the mid-leg and support bar and re-insert the hardware through both. Repeat the process for the opposite side and 2 sets of center legs. It may be necessary to pull both legs towards each other in order for the holes to align properly.</p> <p>NOTE: One support bar has holes for the slide attachment. The holes should be positioned toward the front of the swing set.</p>	<p>Part Ref. #: PSHW12</p> 

GLIDER ASSEMBLY

Required Parts:

Vertical Poles x2 (Footrests attached)



Glider attachment x1

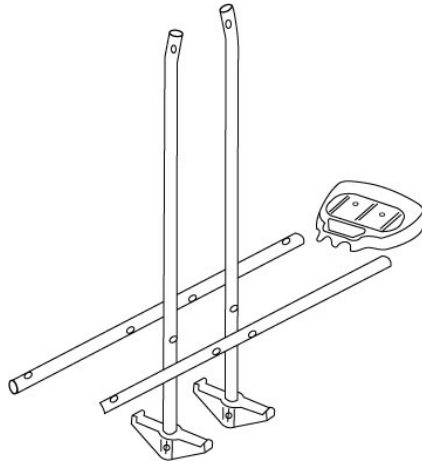





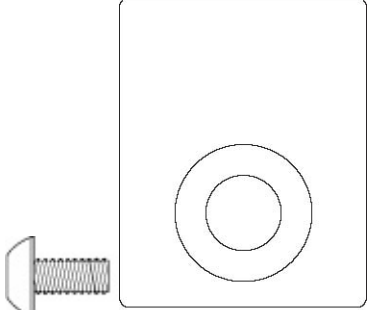

Horizontal Poles x2 (Seats attached)

Pre-Assembled Parts:

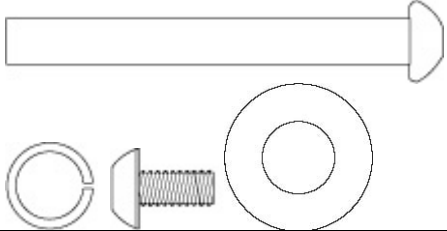
- The seats should be attached to the horizontal poles. These must be disassembled to complete the steps below.
- The foot rests should be attached to the vertical poles.

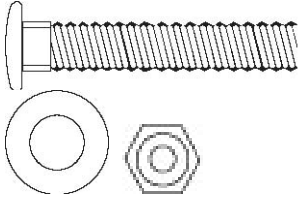

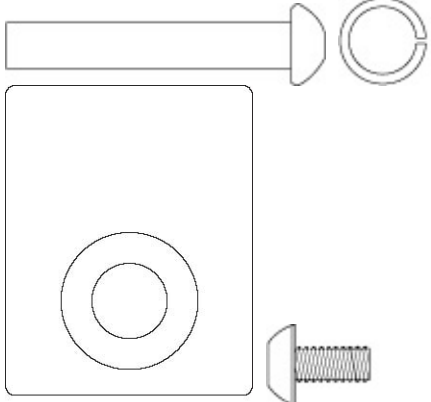
Step	Illustration	Instructions	Hardware Reference
1		<p>Secure the glider attachment with the V-screw and the bolts at the squared portion of the top bar.</p>	<p>Part Ref. #: PSHW35, PSHW22</p>
2		<p>Attach the two vertical poles to the glider attachment. Start by removing the hardware from the lower section of the glider attachment. Align the vertical bar with the glider attachment and re-insert the hardware. Repeat the process for the other side.</p> <p>NOTE: The curved portion of the pole is the top and it should face the inside of the swing frame.</p>	<p>Part Ref. #: PSHW21, PSHW36</p>

			
3		<p>Connect the two horizontal poles (must first be disassembled from the seats) to the two vertical poles using the hardware provided. Be sure that the plastic bushings are between the vertical poles and horizontal poles.</p>	<p>Part Ref. #: PSHW15, PSHW11</p> 
4		<p>Reattach the seats onto the horizontal poles using the flat headed screw, washer, and locking cap nut.</p>	<p>Part Ref. #: PSHW1</p> 
5		<p>Once fully assembled, check that the glider swings freely. If it does not, make sure that the bolts holding the vertical poles to the top bar attachment are not overly tightened.</p>	<p>Part Ref. #: PSHW21, PSHW36</p> 

SWING, ROPE DISC, AND TRAPEZE ASSEMBLY

Pre-Assembled Parts

- Swing seats should be attached to the chains.
- Trapeze should be attached to the chains.
- Rope disc should be attached to the rope.

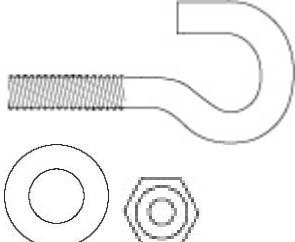
Step	Illustration	Instructions	Hardware Reference
1		Hang the swings, rope disc, and trapeze in place from the swing hooks.	
2		Check the locking cap nut and bolt on the swing seat and trapeze to make sure that they are secure.	Part Ref. #: PSSH11, PSHW13 

SLIDE ASSEMBLY

Required Parts:

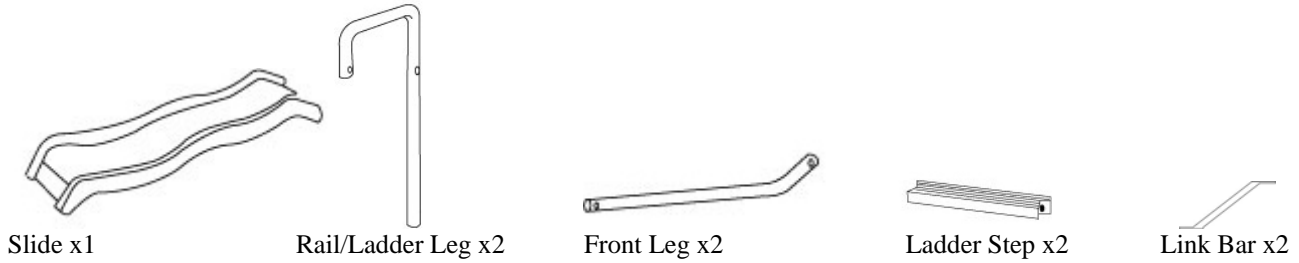



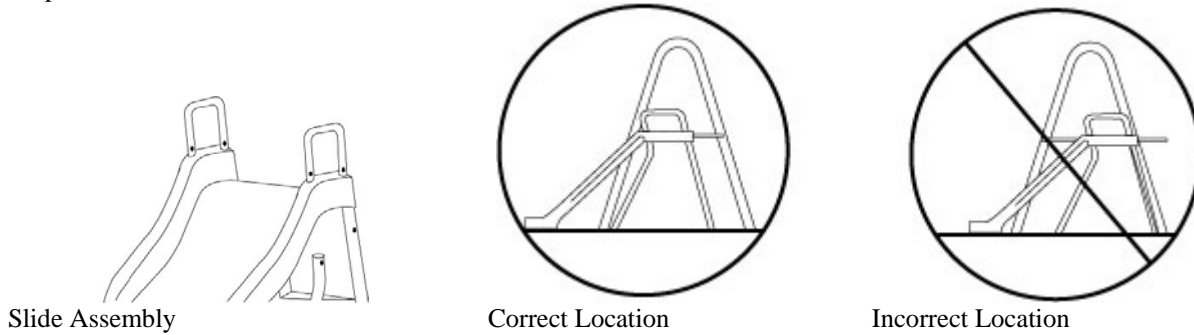





Proper Placement:

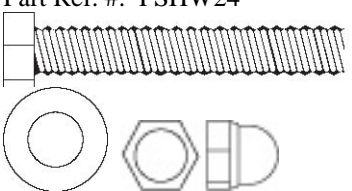

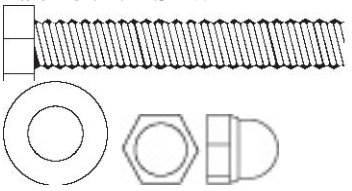
Pre-Assembled Parts:

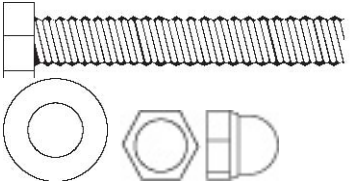

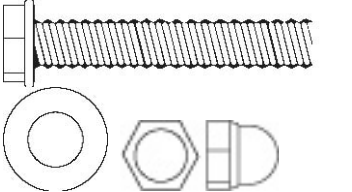
- The screws and bolts for the slide rail/ladder legs are inserted on the slide. They will need to be removed prior to inserting the legs into the slide.
- The ladder steps should have screws and nuts installed. These will need to be removed prior to inserting the legs and then reassembled with the head of the screw facing out.

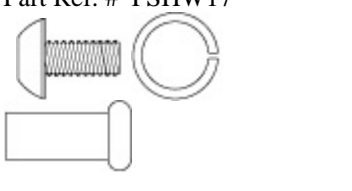
Step	Illustration	Instructions	Hardware Reference
1		Remove the screws, washers, and lock nuts from the holes in the slide.	Part Ref. #: PSHW24 
2		Insert the rail/ladder legs through the holes in the top of the slide. Align the ladder holes with the slide holes.	
3		Insert the screws through the holes in the back of the slide and secure them to the hand rails with the screws and locking nuts provided.	Part Ref. #: PSHW24 
4		Locate the slide front legs and insert them into the front hand rail tubes, on the underside of the slide. Align the holes and secure with the screws, washers and lock nuts.	Part Ref. #: PSHW24 
5		Slide the two ladder steps onto the legs of the slide. Align the holes and secure the steps with the screws and locking nuts. The screw head should be facing the outside. NOTE: Once assembled and the slide is standing upright, the steps should be flat and parallel with the ground. If they are at an angle, they will need to be removed, turned around, and reassembled.	Part Ref. #: PSHW5 
6		To attach the slide to the frame, locate the two link bars, remove the hardware, and re-attach to the side support bar with the holes.	Part Ref. # PSHW17 

TIP: In order to keep the slide legs from sinking into the ground, place a flat rock or a brick under the legs. You should dig out a place for the brick so the slide remains even.

SEE-SAW ASSEMBLY

Required Parts:

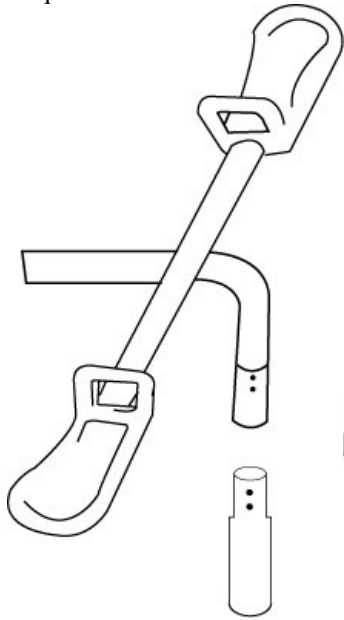

See-Saw Bar and Extension

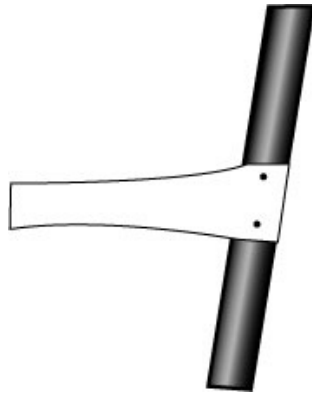



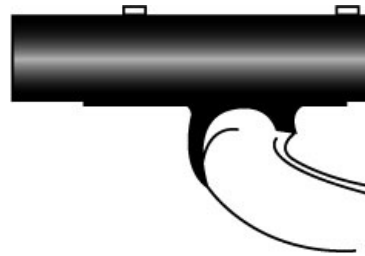

Frame Attachment





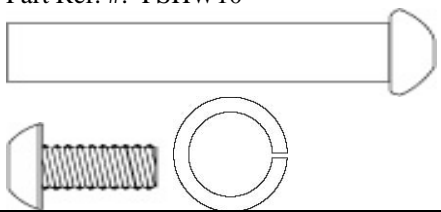

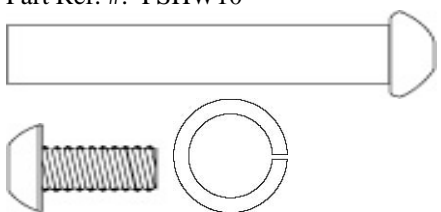
Support Attachment

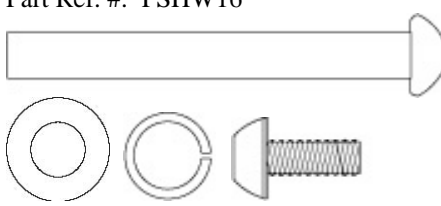

Seat x2

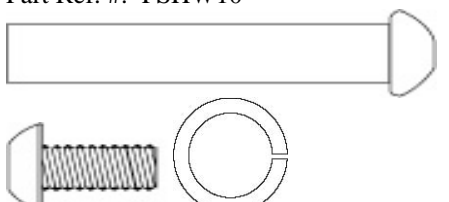
Step	Illustration	Instructions	Hardware Reference
1		Remove the hardware from the frame attachment and connect the extension. Reinsert the hardware and tighten. NOTE: Be sure that the lower part of the see-saw extension is buried and anchored per the anchoring instructions on page 3.	Part Ref. #: PSHW10 
2		Secure the frame attachment to the leg of the frame with the hardware provided on the leg. NOTE: Be sure that the see-saw frame attaches to the leg on the opposite side of the slide. If the leg with the holes is near the support bar with the slide attachments, it should be moved to the other end.	Part Ref. #: PSHW10 
3		Install the seats on the see-saw bar. Check the nuts and bolts on the seat so that they are secure.	Part Ref. #: PSHW16 

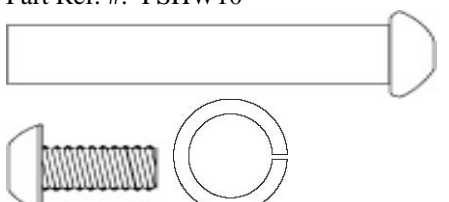
4		<p>Mount the pivot onto the frame attachment. The pivot should be between the two screw heads, starting with the plastic bushing and then the metal bracket.</p>	
5		<p>Attach the see-saw bar to the pivot using the hardware found on the see-saw bar.</p>	<p>Part Ref. #: PSHW10</p> 
6		<p>Once fully assembled, check that the see-saw hinges freely. If it does not, make sure that the bolts on the see-saw bar are not overly tightened.</p>	<p>Part Ref. #: PSHW10</p> 

IMPORTANT LAST STEPS!

TIGHTEN ALL HARDWARE. Do not allow children to play on the swing set until it is fully assembled, all items are tightened, and the unit is properly anchored.

- Do not over tighten nuts and bolts. Once they are tight, turn them ½ rotation more to be sure they are secure.
- Check all parts on all rides before allowing a child on the swing set.
- Be sure to check and tighten the hardware on a regular basis to ensure the safety of the users.

Your Playsafe™ Westport Swing Set should now be fully assembled!