

neolight global

london / dubai / colombo / kl

ABOUT

Award-winning Lighting Design

neolight brings a wealth of experience and understanding to each and every project and provides a personal service to each client to ensure satisfaction at every stage.

Operating from four offices around the world, and with a further joint venture in Edinburgh, we are able to work on projects large and small anywhere around the globe.

Using technical expertise to create lighting schemes we pride ourselves in providing creative and innovative solutions balanced with the most up to date and energy efficient technology.

We bring life to internal and external spaces, injecting passion and a sense of creative design into luxury hotels, resorts, bars, restaurants, public venues, commercial offices, and private residences.

We transform these areas into exquisite and uplifting places, enhancing the architecture and interior design to help create spaces that people want to meet in, enjoy, and experience.



Alan Mitchell
Creative Director



Alessandro Ayanian
Design Director

GLOBAL Office Locations



neolight

The Studio
19 Blackthorne Road
Great Bookham, Leatherhead
Surrey
KT23 4BN

t: +44 (0) 1372 750990
e: london@neolightdesign.com

dubai

Office 302
Deyaar Building
Al Barsha 1
Dubai
P.O. Box 215423

t: +971 (0) 4 3792897
e: dubai@neolightdesign.com

colombo

No. 38/12B
Flower Road
Subadrarama Lane
Nugegoda
Sri Lanka

t: +94 112055436
e: sri@neolightdesign.com

kl

B9-2 Jalan Selaman 1
Dataran Palma
68000 Ampang
Selangor Darul Ehsan
Malaysia

t: +603 4270 4069
e: kl@neolightdesign.com

DUBAI OPERA

Dubai, UAE



Dubai Opera is the definitive destination for performing arts in Dubai, embracing the role as the creative heart of the city with the iconic dhow-shaped building.

It gives the exceptional ability to transform into three modes; from a theatre into a concert hall, and into a 'flat floor' mode becoming a banquet or event hall, all of which offers bespoke lighting seamlessly integrated into each function.

Specialist lighting design from concept to completion was provided for all front of house and landscape areas, plus from detail design to completion for the auditorium space.

Architect: WS Atkins
Interiors: WA International



DUBAI OPERA

Dubai, UAE



DUBAI OPERA

Dubai, UAE

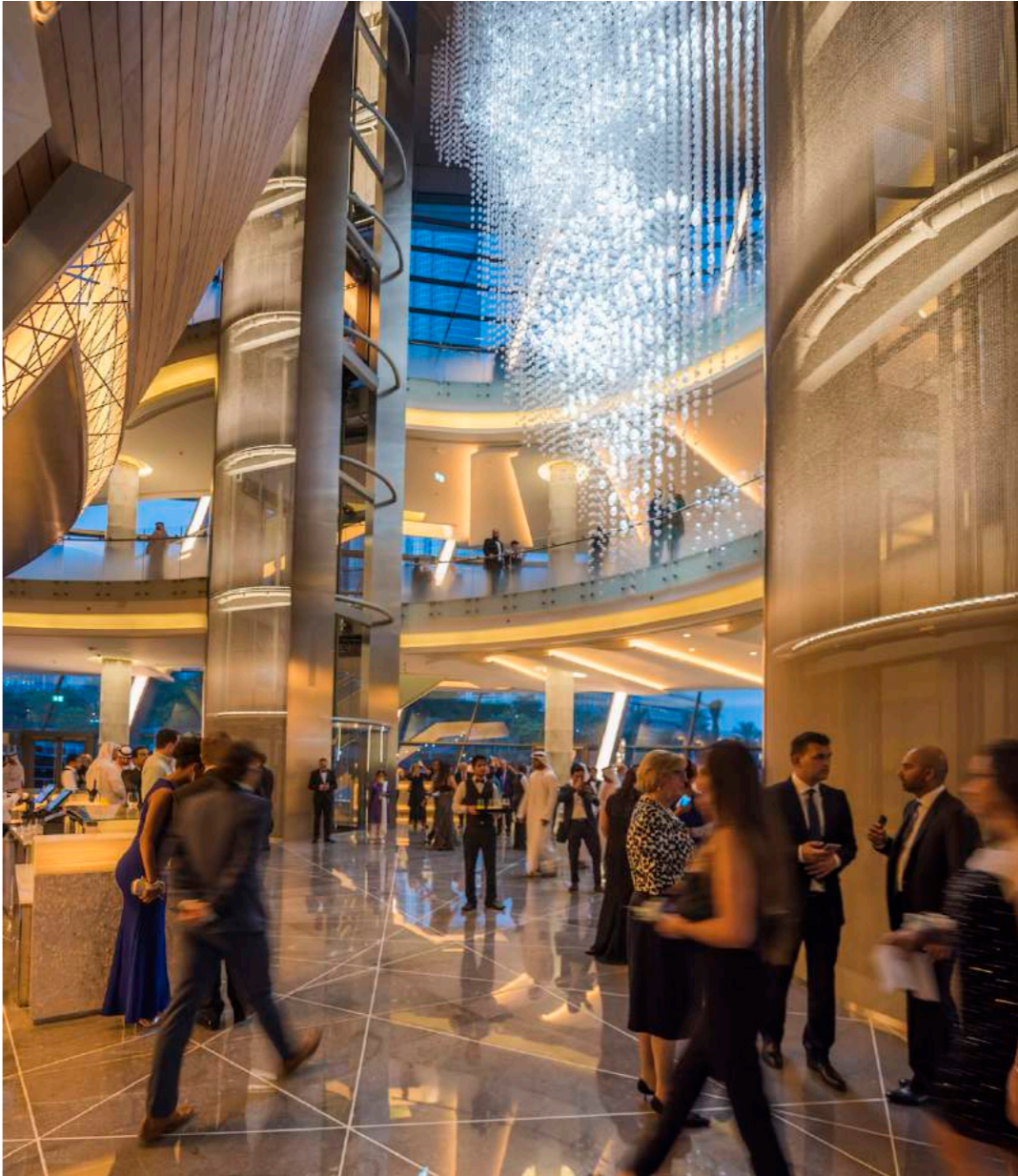
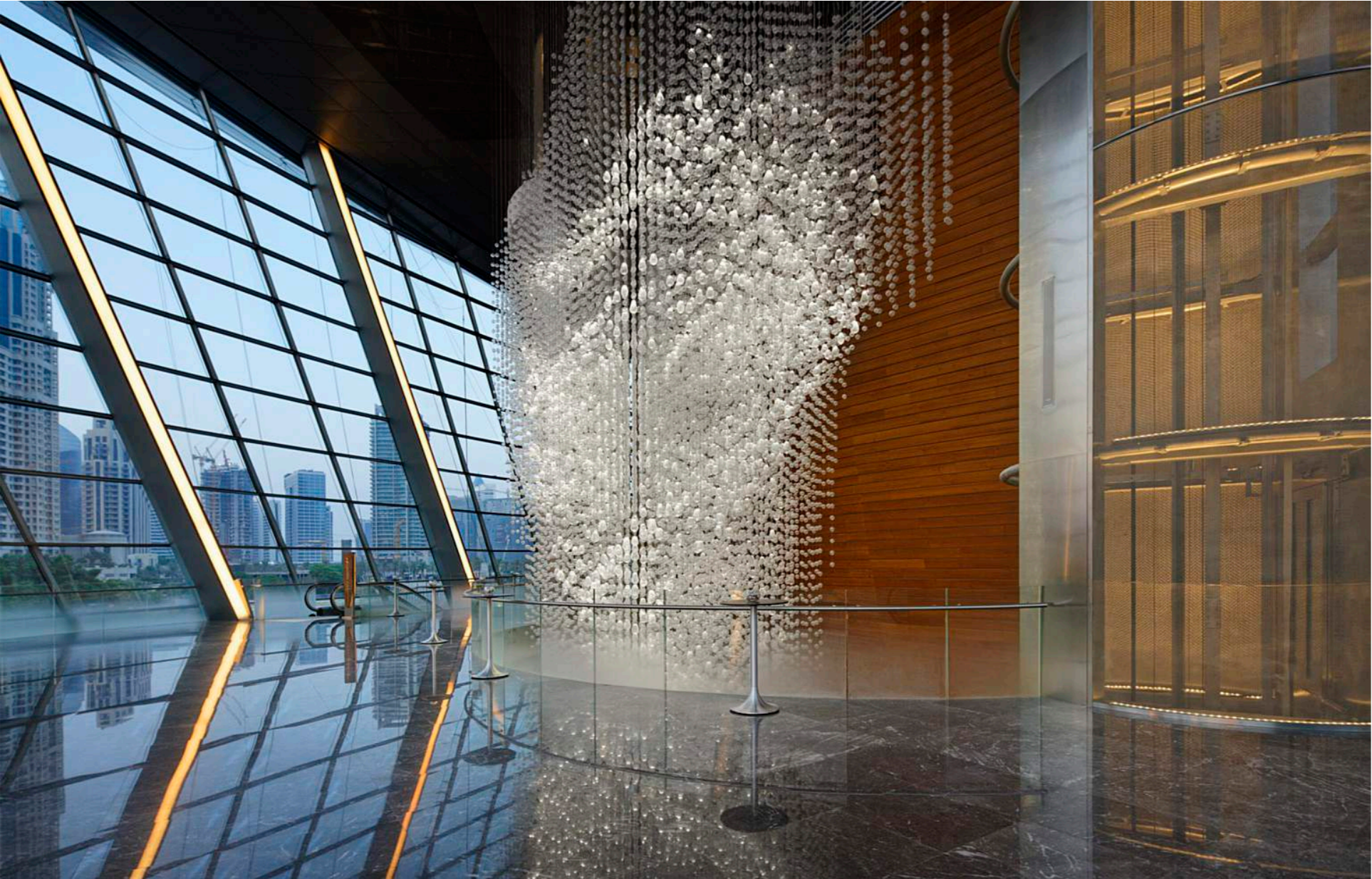

DUBAI OPERA

Dubai, UAE



DUBAI OPERA

Dubai, UAE



DUBAI OPERA

Dubai, UAE



ST REGIS SAADIYAT

Abu Dhabi, UAE



St Regis Saadiyat Island Resort offers a new benchmark of luxury hospitality for Abu Dhabi. Comprising 380 hotel rooms, 33 villas, 259 apartments, retail, restaurants, spa and a vast ballroom overlooking a seafront location.

Specialist lighting design for the entire site-wide project, including landscape masterplan, façade, water features, apartment villas, all front of house public areas, bars, restaurants, guest rooms and suites.

Architect: Woods Bagot
Interiors: Hirsch Bedner Associates
Landscape: LMS International



ST REGIS SAADIYAT

Abu Dhabi, UAE

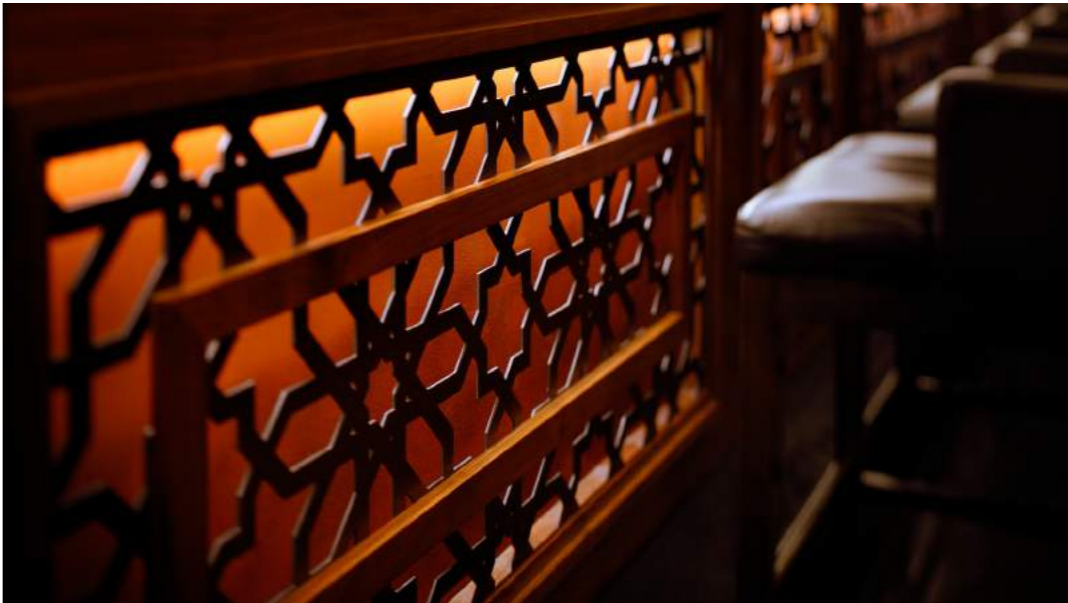

ST REGIS SAADIYAT

Abu Dhabi, UAE



FOUR SEASONS HOTEL

Toronto, Canada



The Four Seasons Flagship property is a mixed-use development featuring a five-star hotel and luxury condominiums in the heart of Yorkville in downtown Toronto.

Specialist lighting design services were provided for all interior spaces, including public areas, bars and restaurants, swimming pool, spa, and all guest rooms and suites.

Architect: Architects Alliance
Interiors: Yabu Pushelberg



FOUR SEASONS HOTEL

Toronto, Canada

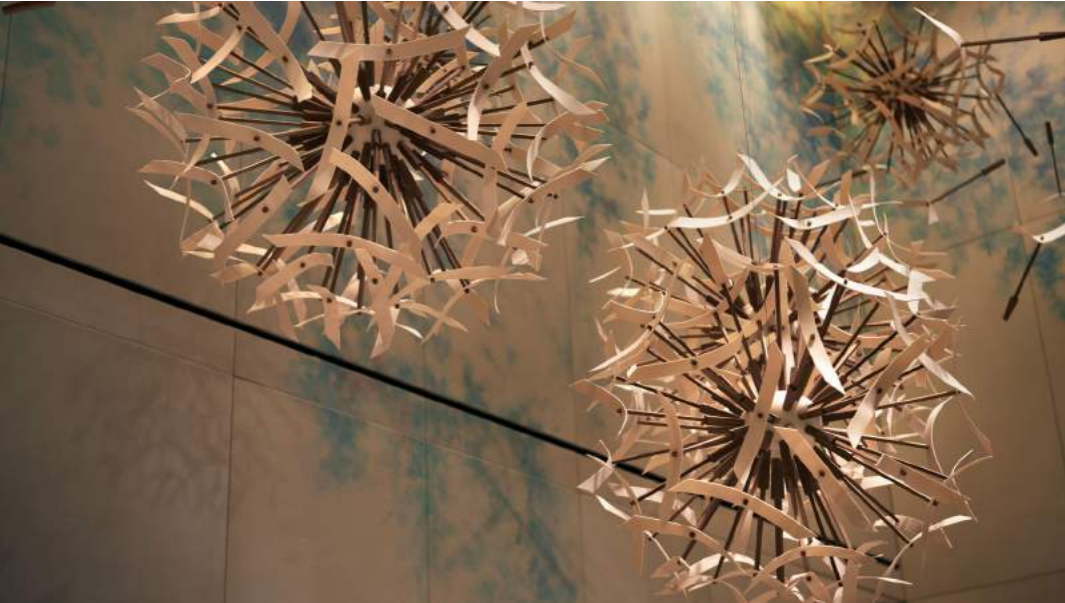

FOUR SEASONS HOTEL

Toronto, Canada



WESTIN GOLF CLUB AND RESORT

Abu Dhabi, UAE



The Westin Abu Dhabi is the hospitality heart of Abu Dhabi Golf Club. Boasting 172 guestrooms, with bars, restaurants, a spa, and leisure area it is a luxury destination.

Specialist lighting design for this project included the leisure area and outdoor swimming pools, the “Shades” pool bar, “Agadir” Moroccan restaurant, and the “Heavenly” spa.

Architect: GREC Architects
Interiors: The Gettys Group
Landscape: Mesa Design Group



WESTIN GOLF CLUB AND RESORT

Abu Dhabi, UAE



WESTIN GOLF CLUB AND RESORT

Abu Dhabi, UAE



WESTIN GOLF CLUB AND RESORT

Abu Dhabi, UAE



WESTIN GOLF CLUB AND RESORT

Abu Dhabi, UAE



ST REGIS NATION TOWERS

Abu Dhabi, UAE



St Regis Abu Dhabi is located in the heart of vibrant Abu Dhabi and each of the hotel's 283 rooms provide a view of the Corniche with the world's highest sky bridge suite located at the top.

Specialist lighting design for the project included the landscape and Nation Riviera beach club, all front of house public areas, bars, restaurants, guest rooms and suites, shopping mall, and Lamborghini showroom.

Architect: WZMH / KEO International Consultants
Interiors: Hirsch Bedner Associates
Landscape: Belt Collins



ST REGIS NATION TOWERS

Abu Dhabi, UAE



ST REGIS NATION TOWERS

Abu Dhabi, UAE



PIK PALACE HOTEL

Shahdag, Azerbaijan



Set amid majestic mountains the Pik Palace Shahdag hotel offers 167 oversized bedrooms and suites that provide maximum comfort with a discerning level of luxury in a unique setting.

Specialist lighting design services were provided for all interior spaces, including the Chocolat Café, Alpina Brasserie, and Fujisan Asian Restaurant, as well as all guest rooms and suites.

Architect: ReardonSmith Architects
Interiors: WA International



PIK PALACE HOTEL

Shahdag, Azerbaijan



PIK PALACE HOTEL

Shahdag, Azerbaijan



PIK PALACE HOTEL

Shahdag, Azerbaijan



BAB AL QASR MILLENIUM HOTEL

Abu Dhabi, UAE



Bab Al Qasr is a modern Arabian fairy tale, a place of legend, tradition and timeless spirit. With iconic architecture and an exclusive address on Abu Dhabi's Corniche, the property impresses on all levels.

With 677 luxurious guest rooms, suites and residences, to one of Abu Dhabi's largest private beaches, a sumptuous Moroccan Spa, eight restaurants and a stunning ballroom.

Specialist lighting design services were provided for all the guest rooms and suites, as well as all front of house spaces and public areas.

Client: Emroc
Architect: Surbana Jurong

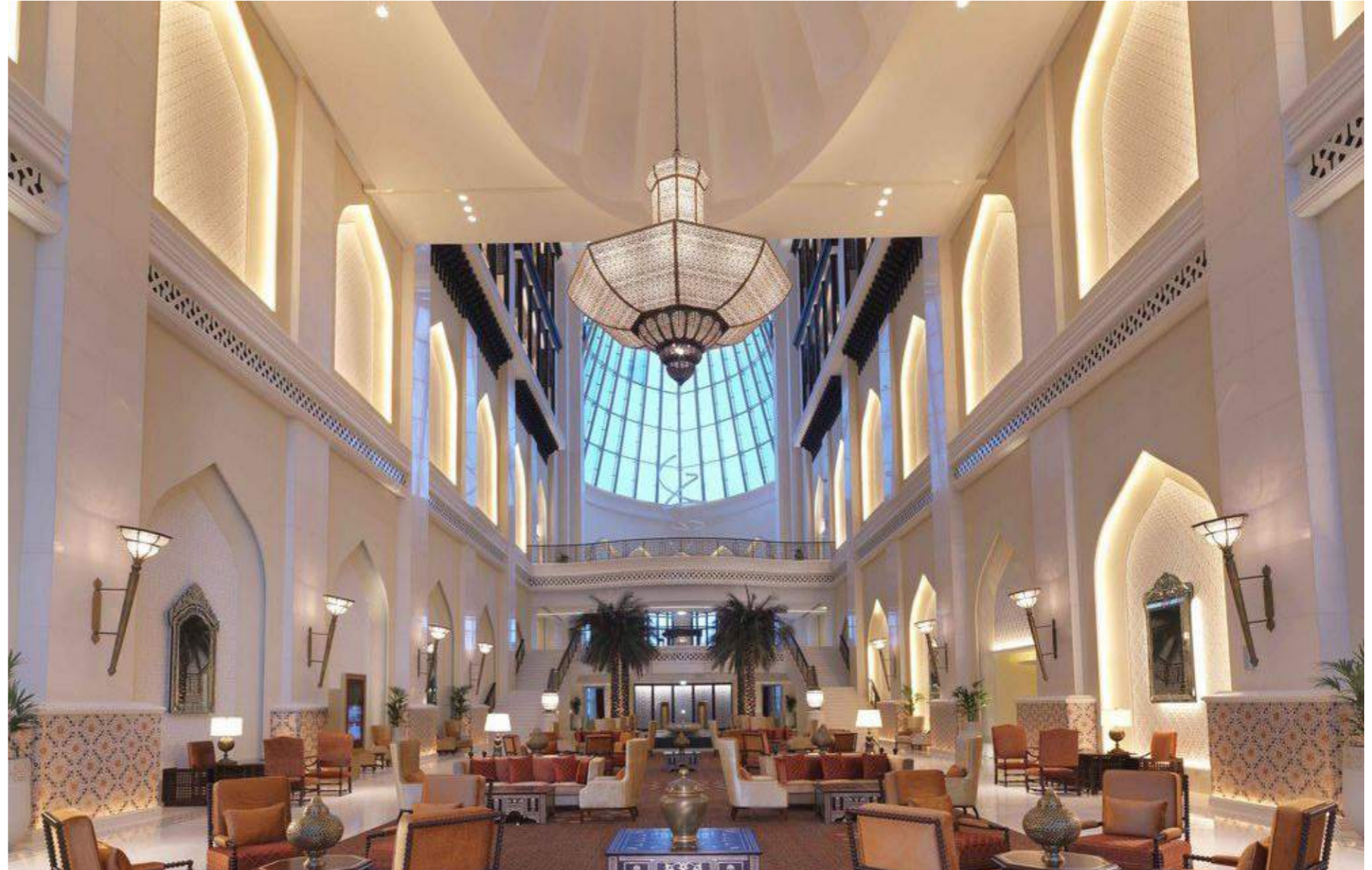

BAB AL QASR MILLENIUM HOTEL

Abu Dhabi, UAE



BAB AL QASR MILLENIUM HOTEL

Abu Dhabi, UAE

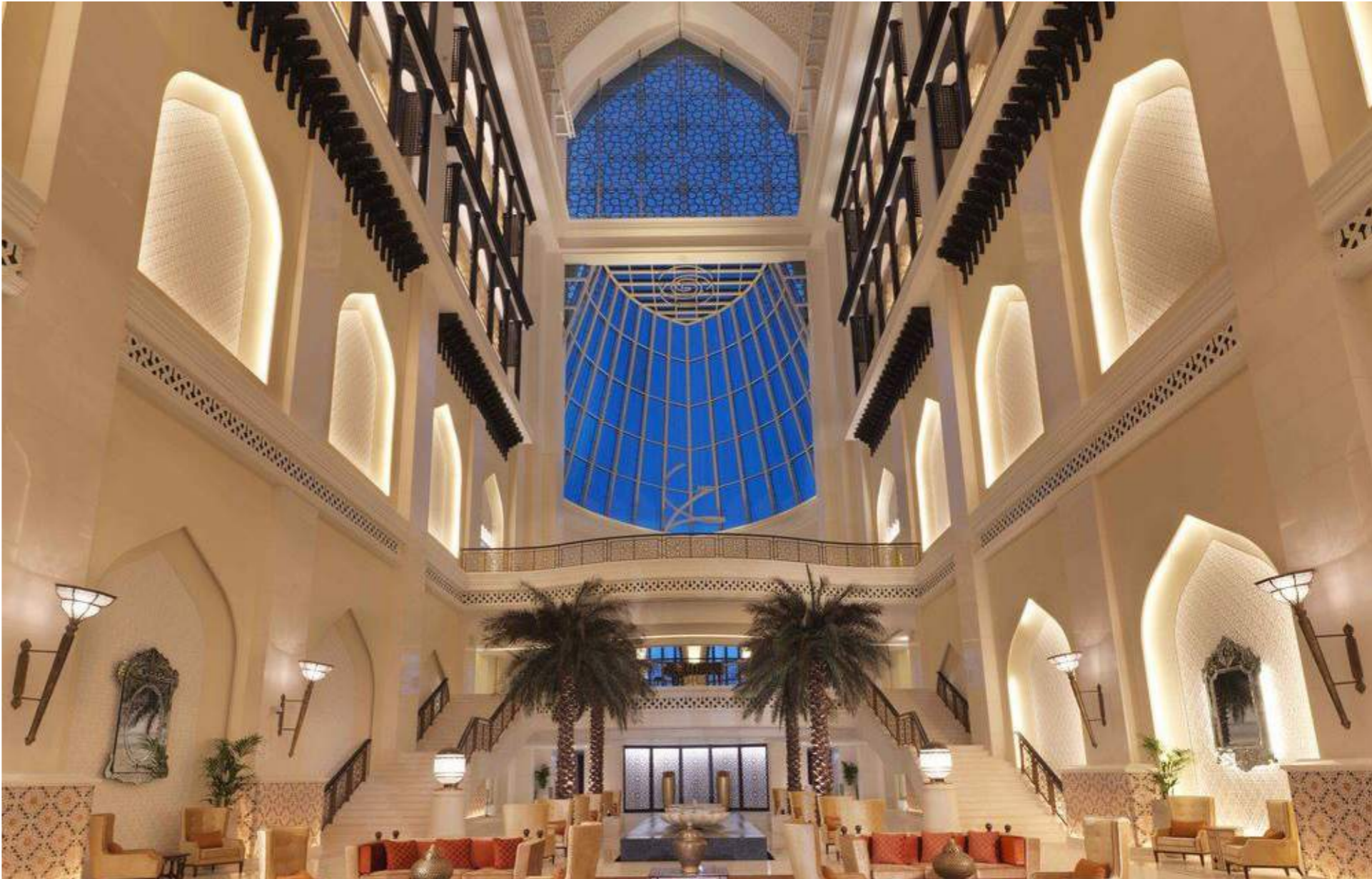

TRE RESTAURANT

Radisson Royal Hotel, Dubai



Tre offers Italian cuisine and hospitality, with Mediterranean influences that are executed with a progressive and innovative touch. Located on the 49th floor the restaurant offers views of the city that few can rival.

Specialist lighting design services were provided as part of a complete refurbishment to all front of house spaces within the restaurant.

Client: Acico Group
Interiors: Modo Milano



TRE RESTAURANT

Radisson Royal Hotel, Dubai



THE ADDRESS

Downtown Dubai



The Address Downtown Dubai is a 63-storey tower comprising of 196 luxury guest rooms and suites with exceptional dining experiences, a relaxation Spa, and private residences.

Specialist lighting design services were provided for the facade and landscape lighting, the interior public areas, and all guest rooms and suites.

Architect: Atkins

Interiors: WA International



THE ADDRESS

Downtown Dubai



THE ADDRESS

Downtown Dubai



THE ADDRESS

Downtown Dubai



THE ADDRESS

Downtown Dubai



THE ADDRESS

Downtown Dubai



DESIGN PROCESS

Concept Renders



Typical renders showing lighting concepts and design intent.

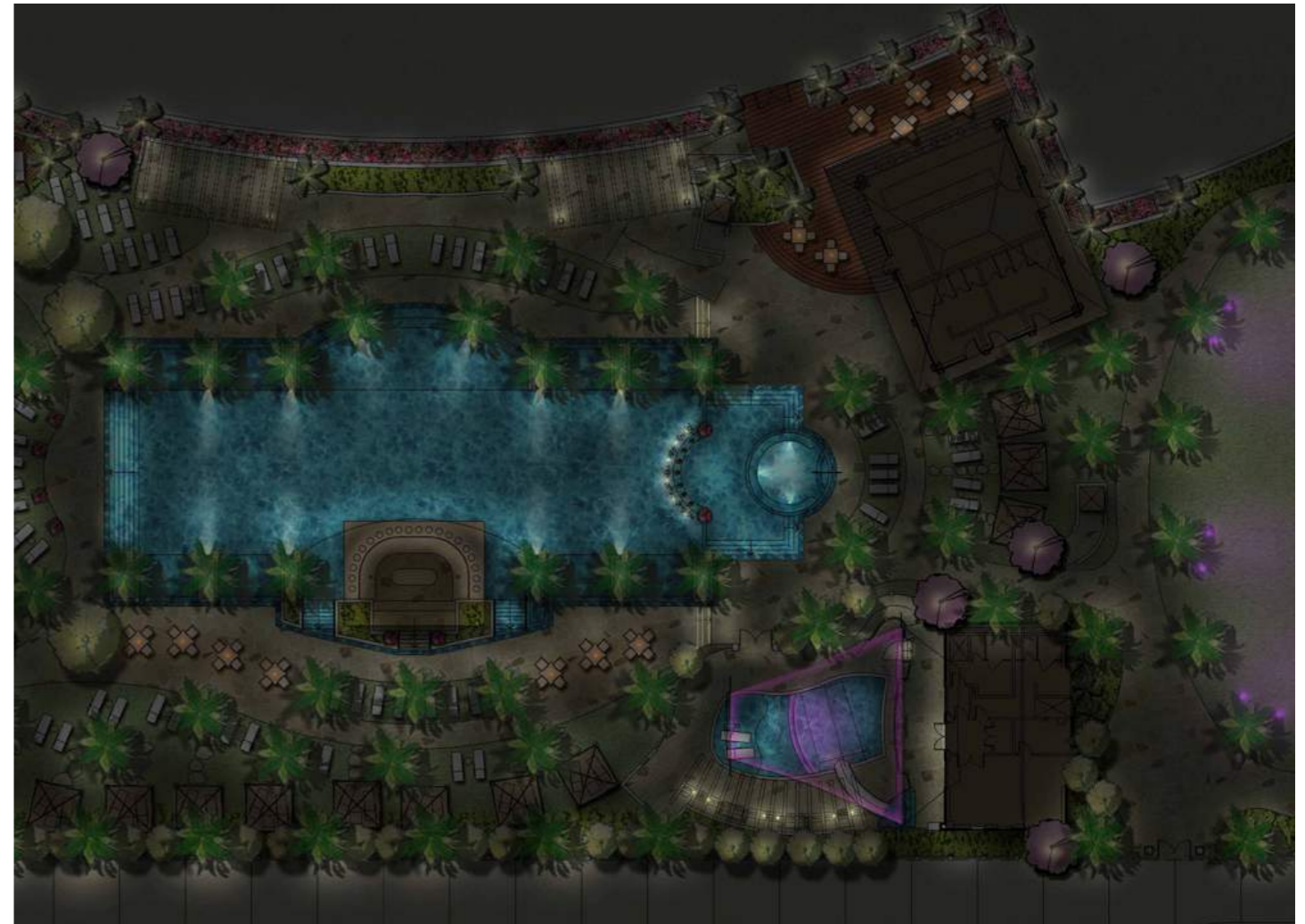

DESIGN PROCESS

Concept Renders



Typical renders showing lighting concepts and design intent.



DESIGN PROCESS

Concept Renders



Part of our design process showing concept renders to demonstrate lighting scenes for a hotel guestroom.



DESIGN PROCESS

Concept Animations



Screenshots from animations produced to demonstrate dynamic and colour change lighting effects.



DESIGN PROCESS

Initial Ideas



Sketching, drawing, model making, prototypes and simulations are all part of our design process.

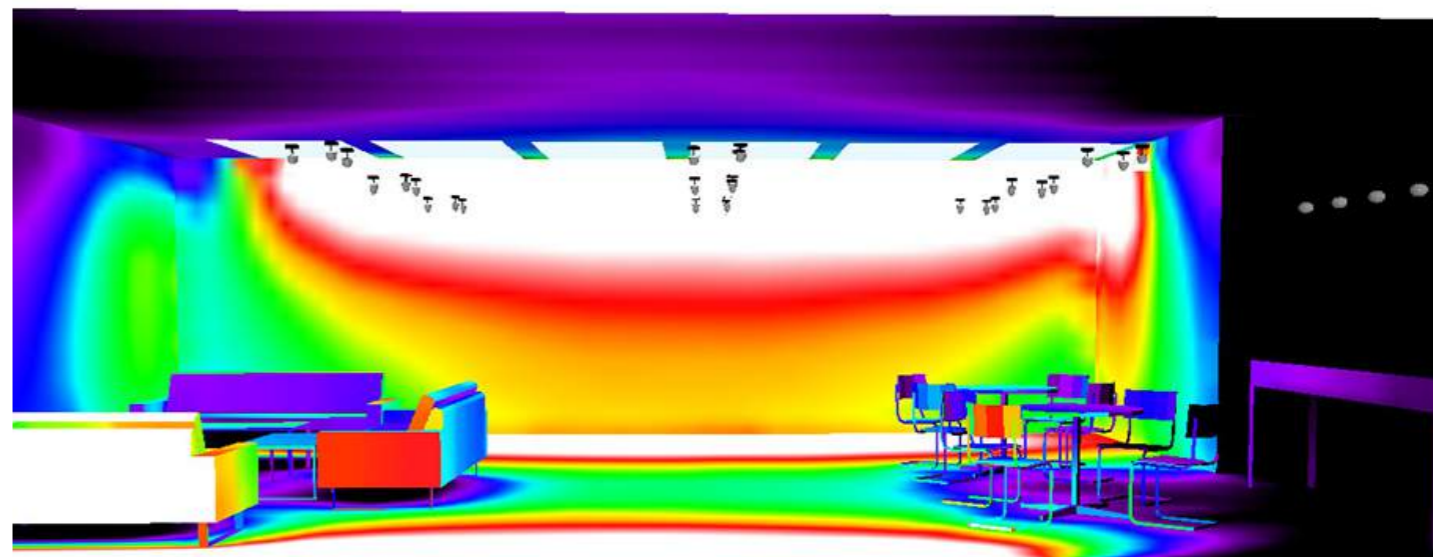
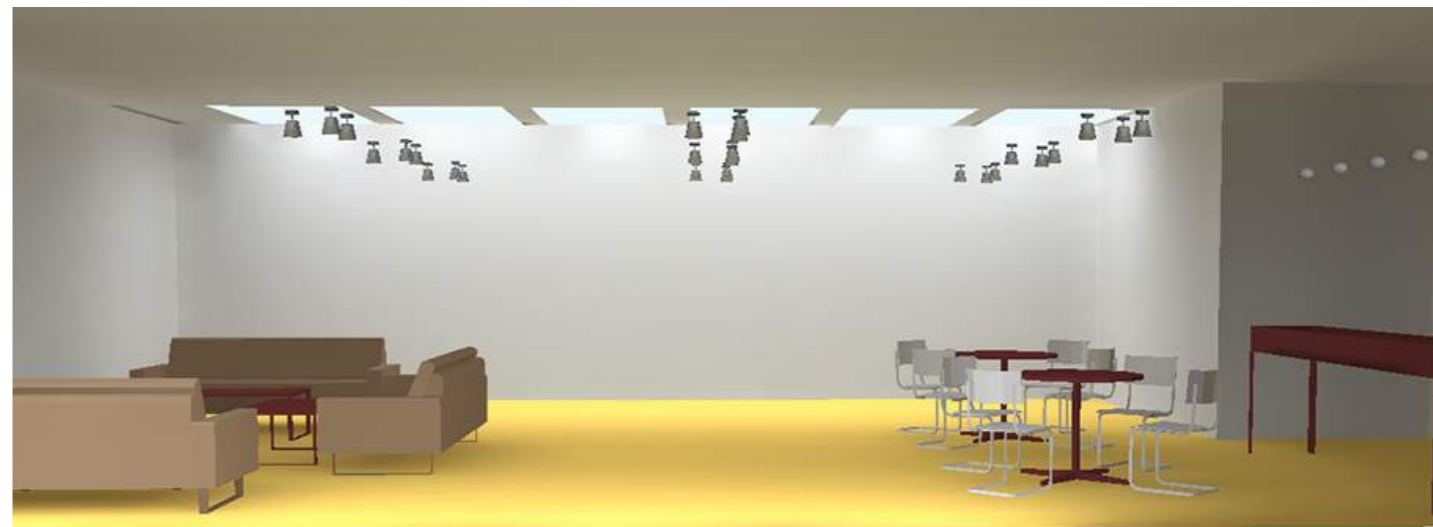

DESIGN PROCESS

Initial Ideas



Sketching, drawing, model making, prototypes and simulations are all part of our design process.

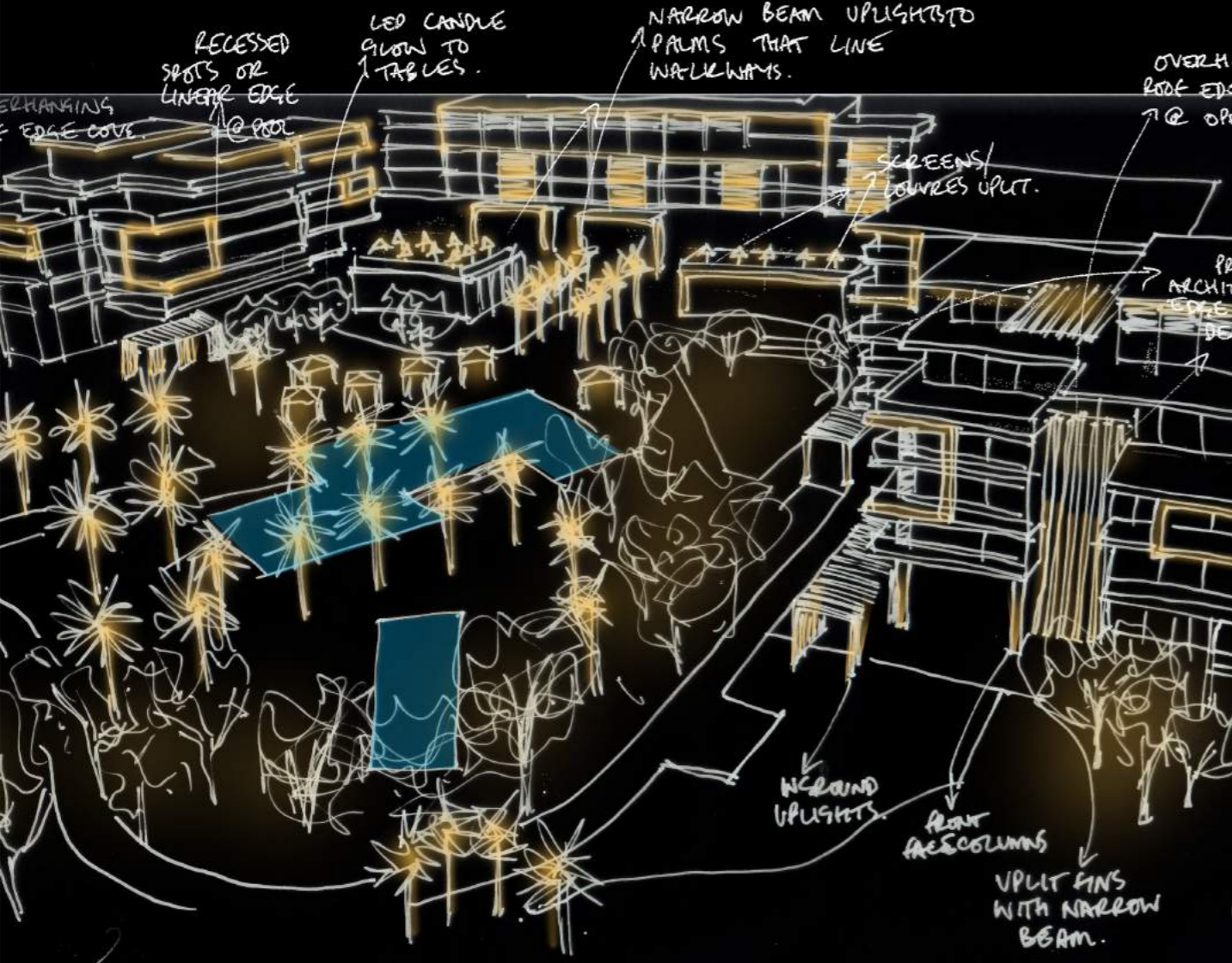

DESIGN PROCESS

Initial Ideas



Sketching, drawing, model making, prototypes and simulations are all part of our design process.

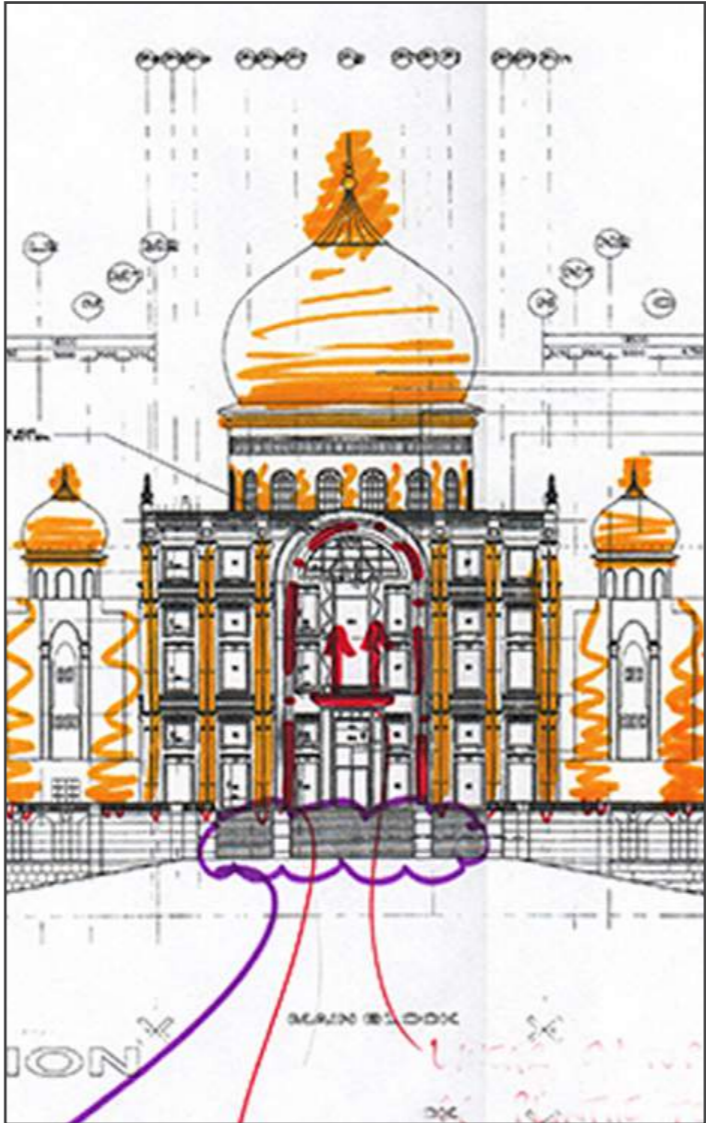
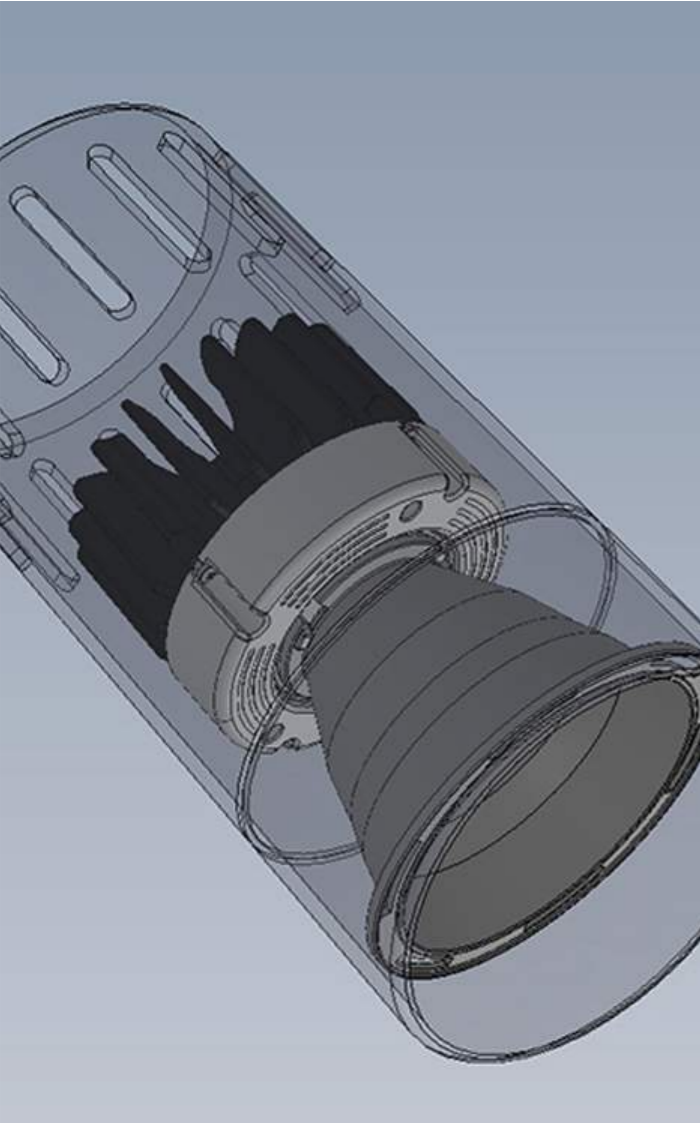

CURRENT PROJECTS

Bluewaters, Dubai



Located off the coast of the Jumeirah Beach Residence coastline, the Bluewaters island features retail, residential, hospitality and entertainment zones.

Our scope for specialist lighting design includes two luxury hotels, residential apartments, landscape and facades, road and highways lighting, souk and retail walkways and the main plaza and entertainment zone adjacent to the 210m ferris wheel.



CURRENT PROJECTS

Cityland Mall



Located beside Global Village in Dubai and due to launch in 2018 the Cityland Mall is a 2.2million sq.ft. mall which will not just be home to over 300 stores, but also set to contain a “botanical wonder” 200,000 sq.ft. open air garden.

Our scope for specialist lighting design includes the facade and vast car parking areas, as well as all internal spaces of the mall and the central open air landscape garden.



CURRENT PROJECTS

Dubai Frame



The Dubai Frame is a 150m structure located in Zabeel Park. It resembles a rectangular frame and has been conceived to give visitors the best views of both old and new Dubai.

Our scope for specialist lighting design includes the exterior lighting, interior lighting to the lobby, lift cabins, and top level walkway, as well as conceptual options for show and celebration lighting.

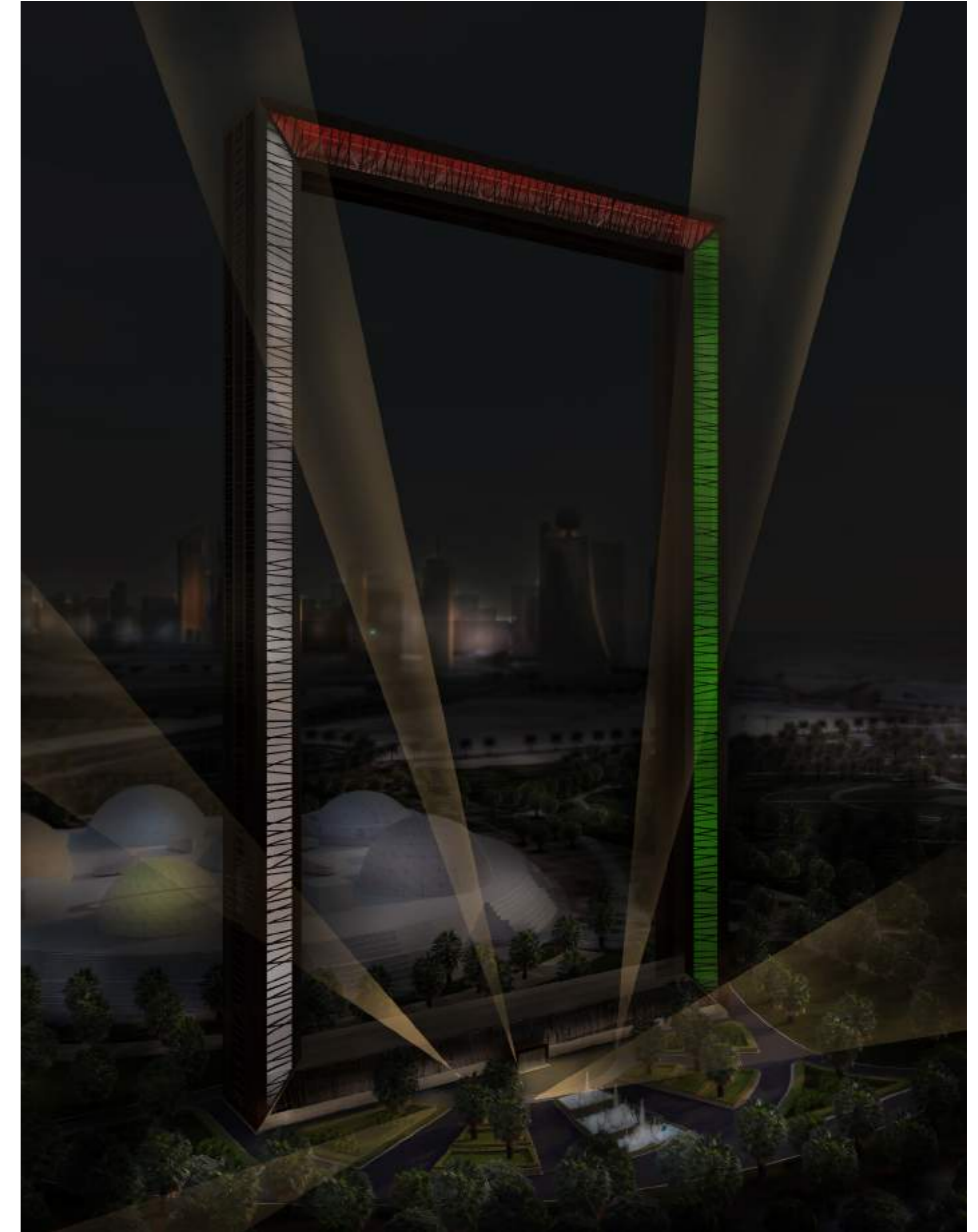
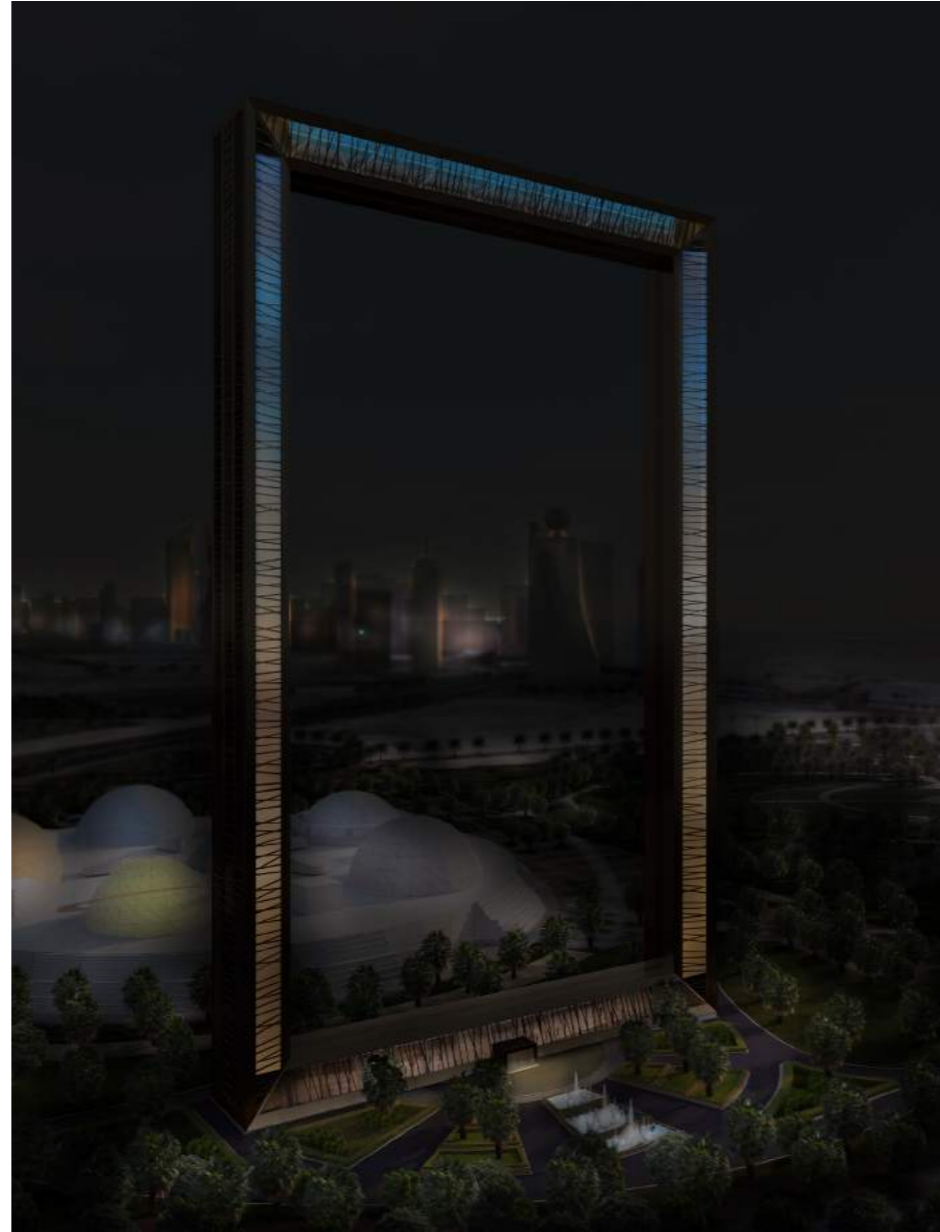

CURRENT PROJECTS

Vida Residence

Vida Residence is a 57-storey building located in Downtown Dubai featuring 320 serviced apartment units.

We are providing specialist lighting design for the podium levels and exterior of the tower.



CURRENT PROJECTS

Marsa Al Seef



Marsa Al Seef is a culturally rich retail, hospitality and entertainment destination along Dubai Creek embracing the Emirates' proud maritime traditions.

We are providing specialist lighting design for the two hotels and all landscape areas for Phase 1 and Phase 4 developments.



CURRENT PROJECTS

The Address Boulevard



The Address Residences Boulevard is a five star premium hotel and serviced residences and will be the second tallest building in Downtown Dubai.

Our scope for specialist lighting design includes the facade, surrounding landscape and pool decks, and tower podium.



PROJECTS AND CLIENTS

Select List



Select Project List

Al Badia Four Seasons Resort , Dubai
Anantara Resort, Sir Bani Yas Island
Bab Al Qasr Millennium Hotel, Abu Dhabi
Barr Al Jissah, Shangri-La Resort, Oman
Gate Village, Dubai
Dubai Opera, Dubai
Dubai World Trade Centre C1 (concept)
Four Seasons Flagship Hotel, Toronto
Hilton Hotel, Colombo
Khalifa Stadium, Qatar
KL Sentral, Kuala Lumpur
Marriott Renaissance Hotel, Dubai
National Palace, Malaysia
Ozo Hotel, Colombo
Pik Palace Marriott Hotel, Azerbaijan
Prime Minister's Office Malaysia
Private Residences, Various
St Regis Hotel, Nation Towers, Abu Dhabi
St Regis Hotel, Saadiyat Island, Abu Dhabi
The Address Boulevard Hotel, Dubai
The Address Downtown Hotel, Dubai
Tre Restaurant, Dubai
Westin Abu Dhabi Golf Club



Select Client List

Anantara Resorts
Arif&Bintoak
Cracknell
Emaar Hospitality ("The Address" Hotels)
Four Seasons Hotels and Resorts
Hilton Hotels
Hirsch Bedner Associates
Holiday Inn
Marriott Hotels
Mirage Leisure & Development
Mövenpick Hotels & Resorts
Norr
RDK Dubai
ReardonSmith
St Regis Hotels
TDIC Abu Dhabi
Telekom Malaysia
W Hotels
WA International
Woods Bagot
WS Atkins & Partners Overseas
Yabu Pushelburg



www.neolightdesign.com