



CANADIAN
FIREARMS
PROGRAM

CANADIAN RESTRICTED FIREARMS SAFETY COURSE



2014



Library and Archives Canada Cataloguing in Publication

Canadian Restricted Firearms Safety Course Modules: Student Handbook, 5th edition

Also available in French under the title: Cours canadien de sécurité dans le maniement des armes à feu à autorisation restreinte : Manuel de l'étudiant.

(Également disponible en français sous le titre, Cours canadien de sécurité dans le maniement des armes à feu à autorisation restreinte : Manuel de l'étudiant.)

ISBN 978-0-660-19945-0

Catalogue number: PS99-2/1-1-2014E

Firearms—Canada—Safety measures.

Firearms ownership—Canada.

Firearms—Safety measures.

Gun control—Canada.

Royal Canadian Mounted Police (RCMP) / Canadian Firearms Program (CFP)

TS532.2.C36 2010 363.330971 C2008-980104-0

© (2014) HER MAJESTY THE QUEEN IN RIGHT OF CANADA as represented by the Royal Canadian Mounted Police (RCMP).

The RCMP/CFP will allow reproduction in whole or in part, with appropriate credit, provided no changes have been made to the content and it is intended for non-profit use. **A formal request for permission must be sent to the RCMP/CFP.**

This edition of the Canadian Restricted Firearms Safety Course is produced by:

RCMP Headquarters
Ottawa ON K1A 0R2
Canada

Fax: 613-825-0297

PREFACE

Acknowledgements

Many organizations with an ongoing interest in firearms safety volunteered their time to review and comment on this Handbook during its review stages. The efforts and assistance of the many people involved (see below) are acknowledged and appreciated. Without their help and that of the following persons, this Handbook would not have been correctly reviewed:

- CFOs and their Staff
- Baldwin, Chris; Manager Conservation Services, Stewardship and Education Section Wildlife Division, Newfoundland & Labrador
- Batten, Shelly; Operations Manager, Firearms Safety Education Service of Ontario (FSESO), Ontario
- Cooper, A.C. (Tony); Firearms Safety Education Service of Ontario (FSESO), Ontario
- Halvorson, Tony; CFSC & CRFSC Master Instructor, Prince Edward Island
- Jones, Don; Chief Instructor, Retired, Firearms Safety Education Service of Ontario (FSESO), Ontario
- Martin, Allan; President, Instructors of Firearms Safety Association (IOFSA) of British Columbia, CFSC & CRFSC Master Instructor, British Columbia
- Sadauskas, Sherrie (McAdam); Firearms Officer, Halton Regional Police Service, Chief Instructor, Firearms Safety Education Service of Ontario (FSESO)
- Tousignant, Gerald; President, Fédération québécoise de Tir, Québec and all his team.
- Valiquette, Jean; Master Instructor (CFSC) for the Fédération québécoise des chasseurs et pêcheurs, Sécurité nature, for the province of Québec

Most importantly, the RCMP/CFP wishes to acknowledge the talent and expertise of the certified Instructors of the CRFSC from across Canada, many of whom took the time and effort to provide written recommendations and suggestions in the development of this material.

Disclaimer

The improper use of firearms may result in serious injury. The material presented in this Handbook is intended to demonstrate the operation of firearms in accordance with safe handling techniques and an awareness of manufacturers' specifications and safety features.

The RCMP/CFP makes no warranties whatsoever, either express or implied, oral or written, in fact or by operation of law or otherwise, regarding the safety of any firearm or the use of any safety mechanism shown in the Handbook.

Individuals should use firearms in accordance with manufacturers' specifications and contact individual manufacturers as each model features different safety mechanisms and some of the techniques demonstrated might not be appropriate for certain firearms.

Ultimately, responsibility for firearm safety rests with the individual.

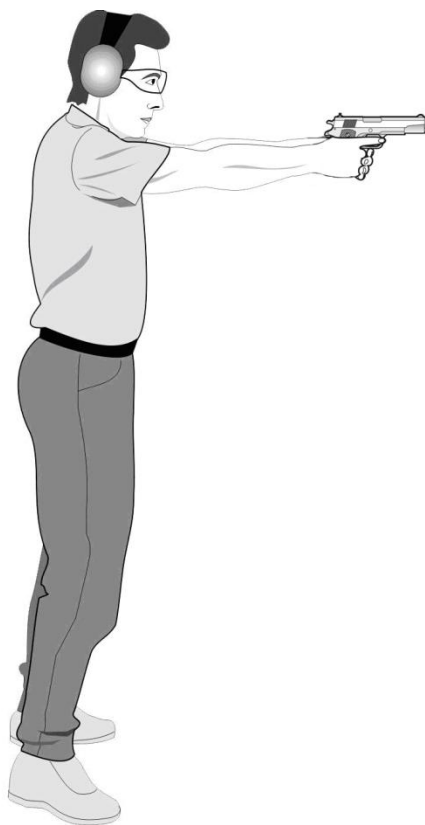

INTRODUCTION TO THE RESTRICTED FIREARMS SAFETY COURSE

INTRODUCTION TO THE CANADIAN RESTRICTED FIREARMS SAFETY COURSE

Overview

The Canadian Restricted Firearms Safety Course (CRFSC) is designed to apply to novice restricted firearm users. Existing firearms safety courses across Canada have a proven track record in the reduction of firearm-related incidents. However, these courses have been designed and delivered for firearms use in a specific activity. The CRFSC is an introductory firearms safety course intended for all new restricted firearm users and those individuals who wish to acquire restricted firearms.

The Canadian Firearms Program

The Canadian Firearms Program (CFP) is administered by the RCMP/CFP, which works with provincial CFOs and many community partners across the country in implementing the *Firearms Act* and its Regulations, and other related legislation regarding firearms.

The goal of the CFP is the safe and responsible use of firearms, and it includes a range of activities directed toward achieving that goal such as the following:

- the licensing of all firearm owners and businesses;
- the delivery of the CFSCs;
- public education regarding safe storage, transport and use of firearms; and
- import and export controls.

Licensing, registration and other Program information are recorded in the Canadian Firearms Information System, a national database that is managed by the RCMP/CFP. Certain information is available to law enforcement agencies to help them prevent and investigate firearms incidents and crime, consistent with the public safety objectives of the *Firearms Act*.

Your personal information is carefully protected by the CFP, consistent with the *Firearms Act* and its Regulations, federal and provincial privacy laws and other applicable statutes.

If you have any questions about the CFP, please contact us at the following location:

Canadian Firearms Program	
Telephone:	1-800-731-4000
Fax:	613-825-0297
E-mail:	cfp-pcaf@rcmp-grc.gc.ca
Address:	Royal Canadian Mounted Police / Canadian Firearms Program Ottawa ON K1A OR2

You can also consult the *Firearms Act* and its Regulations directly via the RCMP/CFP website.

The RCMP/CFP wishes you the best in following the CRFSC for the class(es) of firearms you wish to acquire and/or possess. Please note that all CRFSC instructors and examiners must be designated by the CFO for the province or territory in which you are taking the course.

Course Objectives

Firearm owners have social responsibilities. By completing this course, you will be instructed on what these responsibilities are. You will learn how to do the following:

- handle restricted firearms and ammunition safely;
- use restricted firearms and ammunition safely;
- comply with firearms laws;
- store restricted firearms and ammunition safely;
- display restricted firearms safely; and
- transport restricted firearms and ammunition safely.

The CRFSC consists of two parts. One is classroom instruction. The other is learning the material in this Handbook. There will be both written and practical examinations. Successfully passing them will demonstrate the knowledge and skills you have gained in the course. Live firing exercises, however, are not offered as part of this course.

During the course, some topics are discussed and explored several times. This will help you learn and retain the content. Leaving anything out of the course will reduce the amount you learn. This applies to all assignments, exercises or examinations given by your instructor.

The course emphasizes safe storage, display, transportation, handling and use of restricted firearms but safety depends on more than just safe physical actions.

Safe handling must include greater knowledge of the firearms themselves, ammunition, and the laws and regulations related to them.

Course Handbook

Safety also relies on your attitude about responsible handling and use of firearms. Pay close attention to the section on legal, ethical and social responsibilities. Your safety and that of the people around you depends on it.

This book is an essential part of the course. The other parts are the classroom lessons and practical exercises given by the instructor. Together, they will help you learn how to safely handle firearms.

This book contains the following elements:

- the **Vital Four ACTS** of firearm safety;
- a brief history of restricted firearms;
- information on restricted firearms and ammunition and how they work;
- instructions on how to pick up, handle and carry restricted firearms safely;
- descriptions of how to unload, load and fire restricted firearms safely;
- descriptions of firing positions;
- instructions on range safety;
- instructions on the care and cleaning of restricted firearms;
- examples of factors leading to firearm incidents and the misuse of firearms;
- a summary of ethics and laws affecting firearm owners and users;
- information on how to store, display, transport and handle restricted firearms safely;
- a glossary of firearm terms; and
- appendices





This is an introductory course. More information and training are available on the various shooting sports from their own qualified instructors, associations and local clubs. We recommend you contact them directly for further details.





Do not hesitate to contact provincial/territorial or local authorities for more detailed information on firearms laws and regulations in your area.

The Vital Four ACTS of Firearm Safety

Your instructor will refer to many different safety rules and guidelines. Time and again, the instructor will return to four basic rules. Any time you hear of an incident occurring, you can be sure at least one of these rules has been broken. These rules are known as the **Vital Four ACTS**.

The first letter of each rule becomes a letter in the acronym **ACTS**. You may want to think of these rules as acts you must carry out.

The Vital Four ACTS of Firearm Safety	
	<p>Assume every firearm is loaded.</p> <ul style="list-style-type: none"> • Regard any firearm as a potential danger.
	<p>Control the muzzle direction at all times.</p> <ul style="list-style-type: none"> • Identify the safest available muzzle direction. • Keep the firearm pointed in the safest available direction. • The muzzle of a firearm should not be pointed towards yourself or any other person.
	<p>Trigger finger must be kept off the trigger and out of the trigger guard.</p> <ul style="list-style-type: none"> • Do NOT put your finger on the trigger or inside the trigger guard when you pick up a firearm.
	<p>See that the firearm is unloaded—PROVE it safe.</p> <ul style="list-style-type: none"> • Do not handle the firearm unless you can properly PROVE it safe. • Check to see that both chamber and magazine are empty. Do this every time you handle a firearm, for any reason. • Pass or accept only open and unloaded firearms. It is an essential rule to adopt.

PROVE it safe	
	P oint the firearm in the safest available direction.
	R emove all ammunition.
	O bserve the chamber(s).
	V erify the feeding path.
	E xamine the bore for obstructions.

Legal Responsibilities

As a firearm owner and user, you have legal as well as social responsibilities. These responsibilities are laid out in federal, provincial/territorial and municipal laws and regulations. The table below describes a few of the regulations that come from each level of government.

Table 9. Some Legal Responsibilities of Restricted Firearm Owners/Users

Government Level	Example of Law or Regulation
<p>Federal (e.g., <i>Firearms Act</i> and its Regulations, <i>Criminal Code</i>)</p>	<ul style="list-style-type: none"> • All firearm owners need a valid firearms licence. • If you are the holder of a valid firearms licence and you own restricted firearms, you must inform the RCMP/CFP before you change your address and request an Authorization to Transport your restricted firearms. • Persons holding a valid PAL may borrow, buy, inherit or otherwise acquire the same class of firearm that he/she is licensed to own.
<p>Provincial/Territorial (e.g., <i>Game, Fish and Wildlife Acts</i>)</p>	<ul style="list-style-type: none"> • It is forbidden to hunt with a restricted firearm in Canada.
<p>Municipal/County/Local (e.g., Noise, Nuisance, Zoning, By-laws)</p>	<ul style="list-style-type: none"> • Some municipalities or counties may not allow the discharge of a firearm under any circumstances within their boundaries.

Other Duties of Firearm Owners/Users

- a. A firearm owner/user must also keep informed about the laws and regulations affecting the use of firearms and ammunition.
- b. Going beyond what the regulations require will increase your safety. Some suggestions are listed below:
 - Keep an inventory of your firearms. Also keep any supporting documents such as photographs and owner's manuals. Store these documents in a safe place. This will help you describe any firearms that may be stolen or lost. It will also be easier for you to find your owner's manual and records of service or repair.
 - Keep informed. Changes may occur in laws and regulations from time to time. This can happen whether at the federal, provincial/territorial or municipal level.
 - Avoid advertising about the firearms in your home. You may be inviting theft.



Every person commits an offence who, without lawful excuse, points a firearm at another person, whether the firearm is loaded or unloaded, and is:

1. **guilty of an indictable offence and liable to imprisonment for a term not exceeding five years; or**
2. **guilty of an offence punishable on summary conviction (a fine of \$5,000 and/or six months imprisonment).**

Reference: Subsections 87(1) and (2) of Part III of the *Criminal Code*

They may also lose their firearm, lose their licence, receive a fine, receive jail time and/or be prohibited from possessing a firearm for a period of time.

Not all firearms laws are included in this Handbook. If you have any doubts about the regulations, or if you need more information, contact the following:

- The RCMP website: www.rcmp-grc.gc.ca/cfp
- CFP at 1-800-731-4000

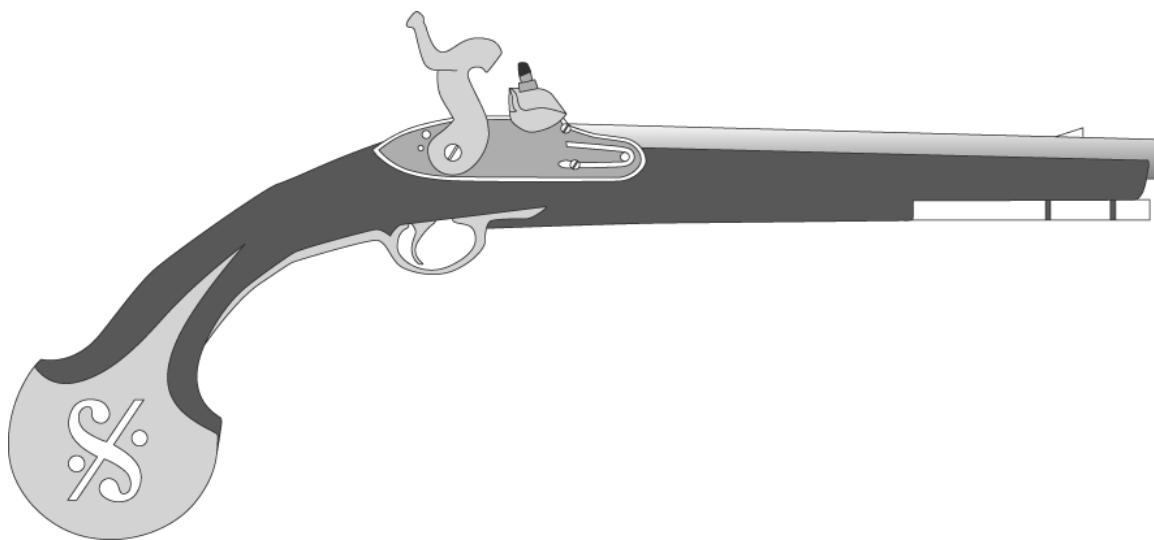

MODULE 12:
RESTRICTED FIREARMS MUZZLELOADER

MODULE 12: RESTRICTED FIREARMS MUZZLELOADER

12.1. Black powder and projectiles

12.1.1. Black powder

- a. Muzzleloading firearms use black powder and lead balls as ammunition. There are also black powder substitutes.
- b. Black powder is available in four different types.

Table 10. Types of Black Powder

Fg	Very coarse granules of powder. Used in larger bore muskets.
FFg	Finer granules than the Fg. Used in muzzleloading shotguns, big-bore rifles and single-shot pistols of .45 calibre and up.
FFFg	Finer granules than the FFg and the most common type. Used in nearly all cap and ball revolvers.
FFFFg	The finest granules. Used only in priming pans. Never use this powder as powder charge.

- c. Remember, the finer the granules of powder, the more pressure it creates when fired.
- d. Black powder ignites very easily. A glowing coal, a spark, even static electricity or a sharp blow may ignite it. Handle black powder with great care, especially when transporting it. Black powder should be stored in a secure, cool dry place and always in its original container.
- e. As black powder ages, it becomes more unstable. When stored for long periods, the granules will begin to cake together and white crystals will form. When this happens, the black powder has become very unstable. It should be soaked immediately in water.



Never use FFFFg powder as anything other than a priming powder. Black powder ignites easily. Always handle with extreme care and wear eye protection. Never have a source of ignition around powder. Never smoke near black powder. Glowing embers may be present in the bore after firing a black-powder firearm. An explosion hazard could be created if you proceed immediately to reload. Never interchange smokeless powder and black powder. Use them only in firearms intended for their use.

12.1.2 Black powder projectiles

Modern black powder or muzzleloading firearms shoot several different types of projectiles as follows:

- Spherical/round ball, usually loaded along with a lubricated patch, which seals the barrel around the ball.
- Conical/cylindrical-shaped projectiles known as Mini-Balls, they have a hollow base that expands to seal the gases when the firearm fires.
- Shot/pellets of assorted sizes and materials.
- Sabot/plastic or synthetic carrier that encases a projectile.

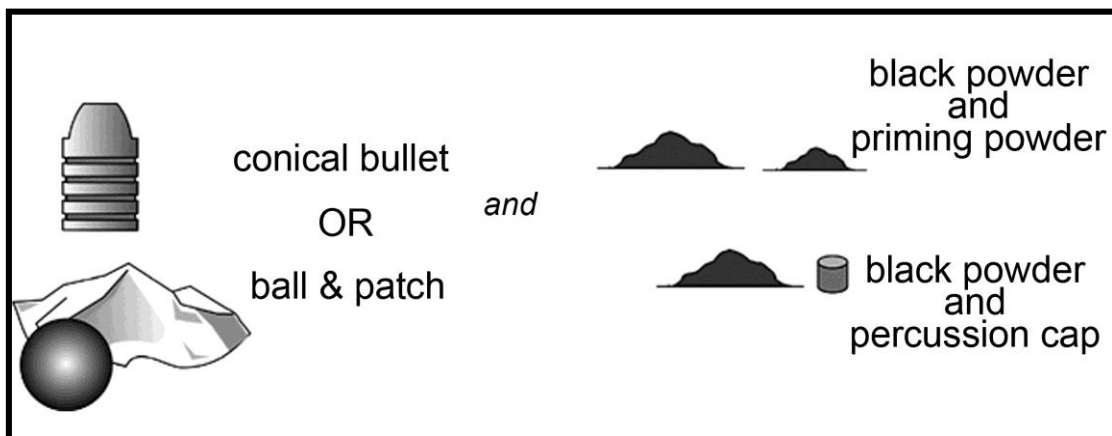

Figure 86. Ammunition Components for a Muzzleloader

12.2. Muzzleloading firearms

12.2.0. Overview

- a. Muzzleloading handguns are still in use today. However, most modern muzzleloaders are reproductions of older designs.
- b. This type of firearm is loaded through the muzzle. A measured amount of powder with a volumetric measure is poured through the muzzle into the barrel, followed by a patch, and finally a lead ball or shot. A hole located at the rear of the barrel just above the trigger allows a flash or spark to enter the barrel through the priming port and ignite the powder, firing the charge.
- c. With flintlock muzzleloaders, the igniting spark is the result of the flint, held by the cock, hitting the frizzen. On percussion muzzleloaders, the flash is produced by the hammer striking a percussion cap. On percussion muzzleloaders, the flash is produced by the hammer striking a percussion cap.
- d. Muzzleloading firearms use black powder or black powder substitutes. Black powder is classified as an explosive and is easily ignited by heat, friction, static electricity or a sharp blow and must be handled with extreme care. It is strongly recommended that individuals interested in muzzleloading seek additional training from qualified specialists in the field.

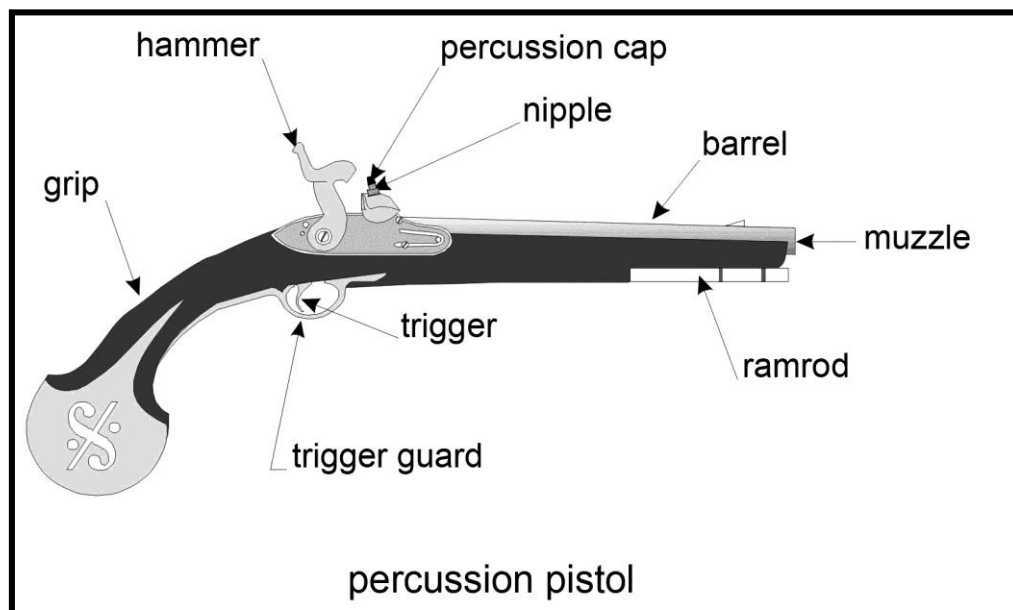

Figure 87. Muzzleloader



Older firearms should be inspected by a qualified gunsmith to be sure they can be fired safely.

12.2.1. Loading muzzleloaders

- a. Today most firearms for black powder use are reproductions of muzzleloaders. Older firearms may not be safe to fire and should be checked by a gunsmith before use.
- b. If a muzzleloader is not primed to fire, it is safer to handle. To ensure that a muzzleloader is not primed to fire, do the following:
 1. Point the muzzle in the safest available direction and keep your finger off the trigger and out of the trigger guard.
 2. Check that the hammer is not in full-cock position.
 3. Check for the presence of priming powder in the percussion cap or in the priming pan.
 4. If the firearm is primed, remove cap or priming powder.
- c. In addition, it is difficult to tell if there is already a charge loaded into the barrel of a muzzleloader. Shooters should mark the firearm's ramrod at a level that shows the bore depth when the bore is empty (Figure 88). When the marked ramrod is inserted into the barrel, it shows whether or not the firearm is loaded.



For other models of muzzleloading firearms, check with the manufacturer for specific safety features and information regarding the loading and unloading process.

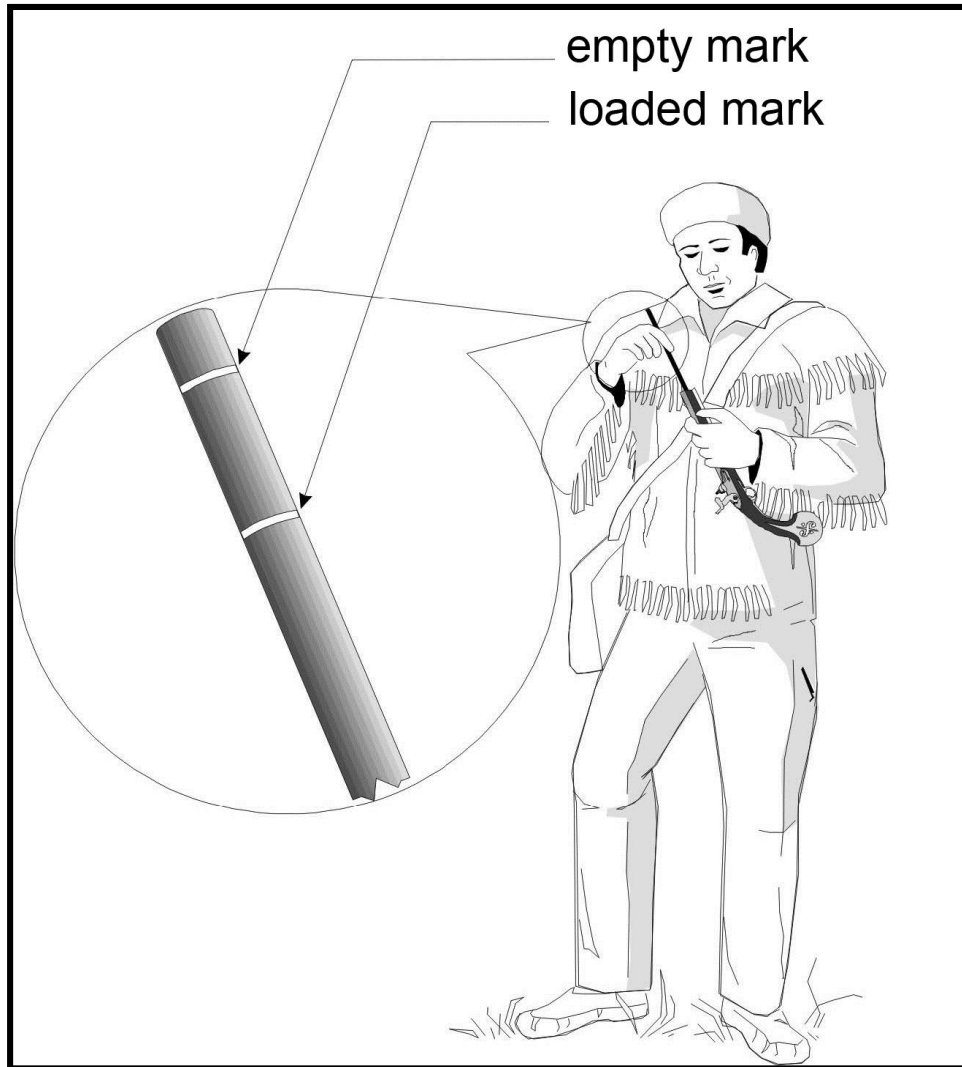

Figure 88. Correctly Marked Ramrod



It is very important that exact loading and unloading procedures are followed when handling muzzleloaders (Figure 89). Before attempting it, get the assistance of a qualified individual and carefully follow the instructions in your owner's manual. Ensure that the firing mechanism (lock) is rendered safe before proceeding to load the firearm. Before loading the firearm, use a rod with a tight fitting patch to clean the bore, and fire a cap to remove oil from the bore and flash port.

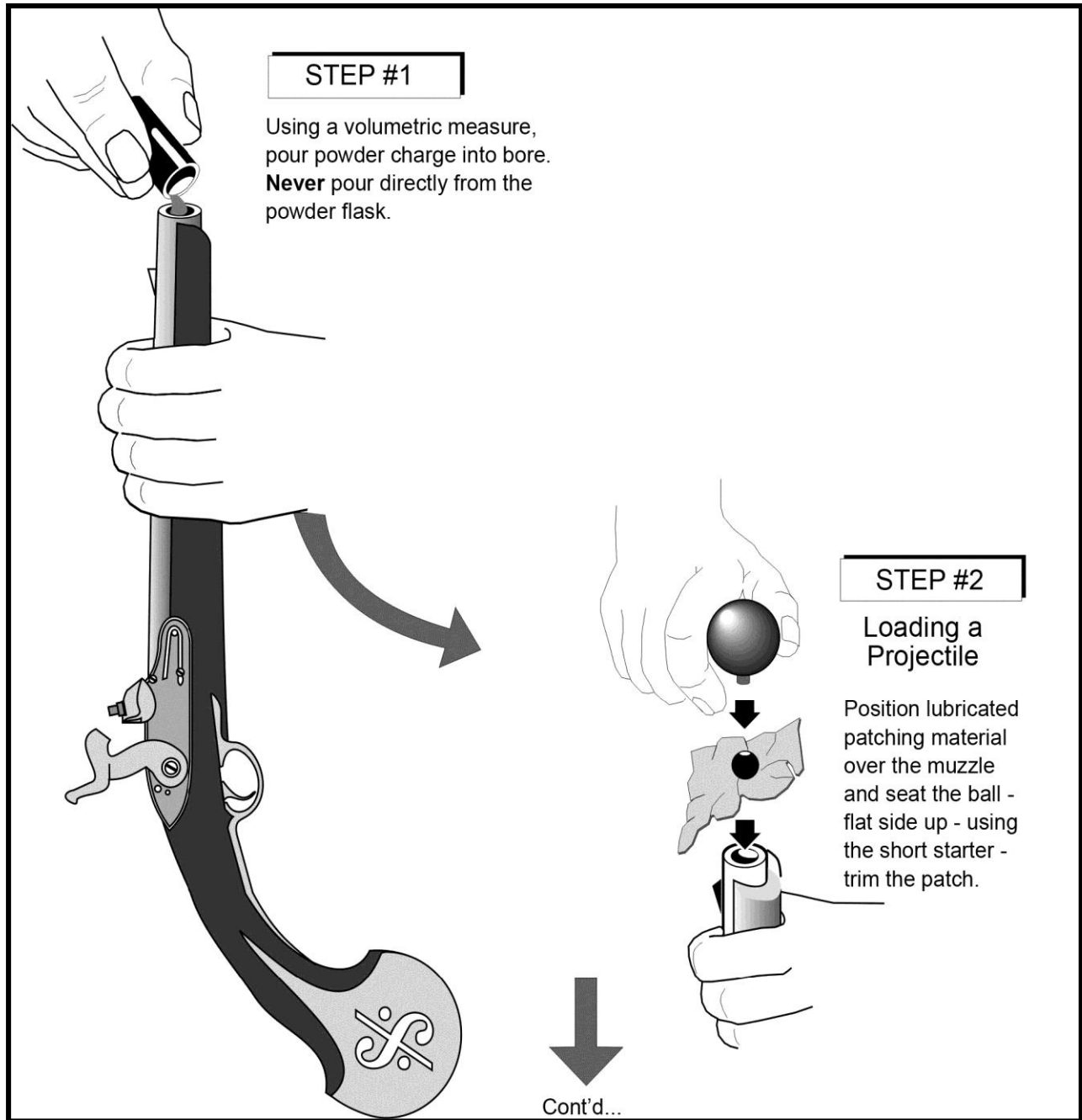

Figure 89. Loading a Muzzleloader

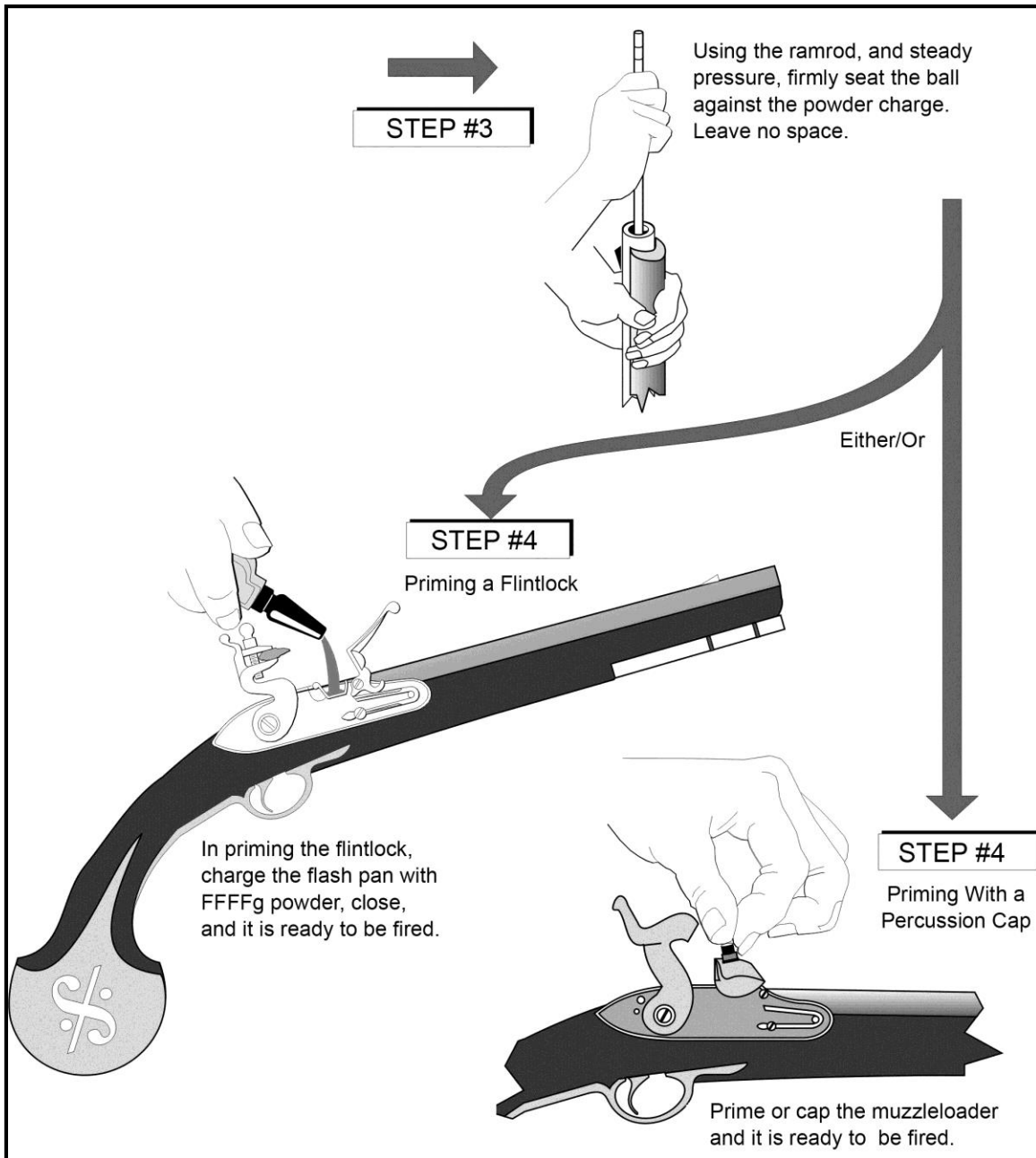

Figure 90. Loading a Muzzleloader (cont'd)

- d. In black-powder revolvers, a measured amount of powder is poured into each chamber. A ball is firmly seated on each charge. Grease or lubricant is placed on top of each ball to lubricate its travel down the barrel and prevent “chain-firing” of all chambers. A percussion cap is put on the nipple of each chamber that produces the flash.



Never use smokeless powder in a muzzleloader. Never use black powder in a modern cartridge firearm not designed for it. Always use a volumetric measure to put powder into the muzzle. Never pour directly from the main powder container. In compliance with firearms safe storage regulations, a muzzleloader with powder in the barrel is considered loaded.

12.2.2. Cleaning a muzzleloader

- a. A black-powder firearm must be properly cleaned after every firing session. Black powder is very corrosive. It attracts moisture, which causes rust.
- b. Cleaning black-powder firearms improperly can result in carbon build-up in the barrel, which may cause coking. This condition may cause a glowing ember to remain after firing, resulting in a dangerous situation if the firearm is reloaded.
- c. Use either commercial black powder cleaning solvent or hot, soapy water.
- d. You will also need a ramrod with a cleaning patch attached. Use a rod as close to the bore diameter as possible. Refer to the owner's manual.
- e. Use wet patches to soften the dried powder.
 1. Detach the barrel and place the lock end in a container of soapy water.
 2. Attach a patch to the ramrod. Insert the ramrod into the barrel. Pump the ramrod up and down until water flows from the top end of the barrel.
 3. Repeat step 2. Change the water as it becomes dirty. Repeat until the water stays clean.
 4. Dry the barrel out with several dry patches. Oil thoroughly with good gun oil.
 5. Remove the lock for cleaning, if possible, and oil after every use.
- f. If cleaning a black-powder revolver, follow the manufacturer's instructions for the proper cleaning methods.



It is strongly recommended that persons interested in muzzleloading seek additional training from experienced individuals.

12.2.3. DOs and DON'Ts of muzzleloading

- Do have old muzzleloading firearms dismantled, examined and declared safe by a qualified gunsmith before using them.
- Do handle the muzzleloader with the same respect due all firearms.
- Do use ONLY black powder or black powder substitutes (e.g., Pyrodex) in your muzzleloader, never use smokeless powder.
- Do keep black powder far away from all cigarettes, matches/wicks or anything with an open flame, embers or anything that may cause sparks or heat.
- Do always use a volumetric measure to pour powder directly into the muzzle. Never use the powder horn or flask.
- Do carefully follow the manufacturer's recommendations for maximum powder charge.
- Do mark your ramrod to indicate when the barrel is empty and when it is loaded.
- Do wipe the bore clean of oil and excess grease before you load.
- Do make sure the ball or bullet is seated firmly on the powder charge.
- Do place grease in front of each projectile in a black-powder revolver to prevent chain-firing.
- Do treat a misfire as a hangfire that could fire at any second. Wait at least 60 seconds with the firearm pointed in a safe direction.
- Do wear safety glasses and hearing protection.
- Do reseal your second charge after firing and reloading a single barrel on a multiple-barrel black-powder firearm. Recoil can move the charge forward.
- Don't carry or handle a muzzleloading firearm with the hammer at full cock and primed unless you are ready to fire.
- Don't lean over or stand in front of the muzzle at any time.
- Don't load one chamber of a muzzleloading multiple barrel or revolving handgun unless the percussion caps on the nipples of the other barrels or chambers have been removed.
- Don't store a muzzleloader with powder in it.



Black powder is also used in some metallic cartridges for firearms specifically designed for their use. Care should be taken. Although they have the same name as a modern smokeless cartridge, they may not be interchangeable. Never interchange smokeless powder and black powder. Use them only in firearms intended for their use.

12.3. Review questions

1. Name two types of ammunition used in muzzleloading pistols.
2. List four sources that could cause black powder to ignite.
3. Before attempting to load a muzzleloading pistol, what safety consideration is given to the firing mechanism?
4. Use a cleaning agent on your firearm after every firing session of a black-powder muzzleloader. What are two possible choices of cleaning agents?

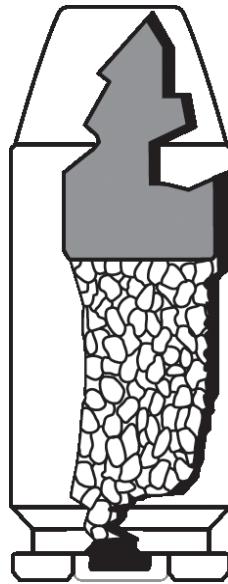

**MODULE 13:
RESTRICTED FIREARMS AMMUNITION**

MODULE 13: RESTRICTED FIREARMS AMMUNITION

13.0. Overview

This module discusses handgun cartridges.



For more detailed information, consult a firearms dealer or a gunsmith. You can also consult the owner's manual.

13.1. Rifling

- a. Most hand guns have a rifled barrel. Rifled barrels have a series of spiral grooves inside the barrel. The ridges of metal between the grooves are called lands. The lands and grooves together make up the rifling (Figure 91).
- b. Rifling makes the bullet spin as it leaves the barrel so that it will be stable in flight.

13.2. Calibre

- a. Rifled firearms are sized by calibre. A calibre is a measurement of bore diameter in either thousands of an inch (Imperial) or in millimetres (Metric). Inch dimensions are usually measured from land to land, while metric dimensions are measured from groove to groove.



Always consult the data stamp on the barrel of your firearm to find out the exact name of the ammunition that fits it.

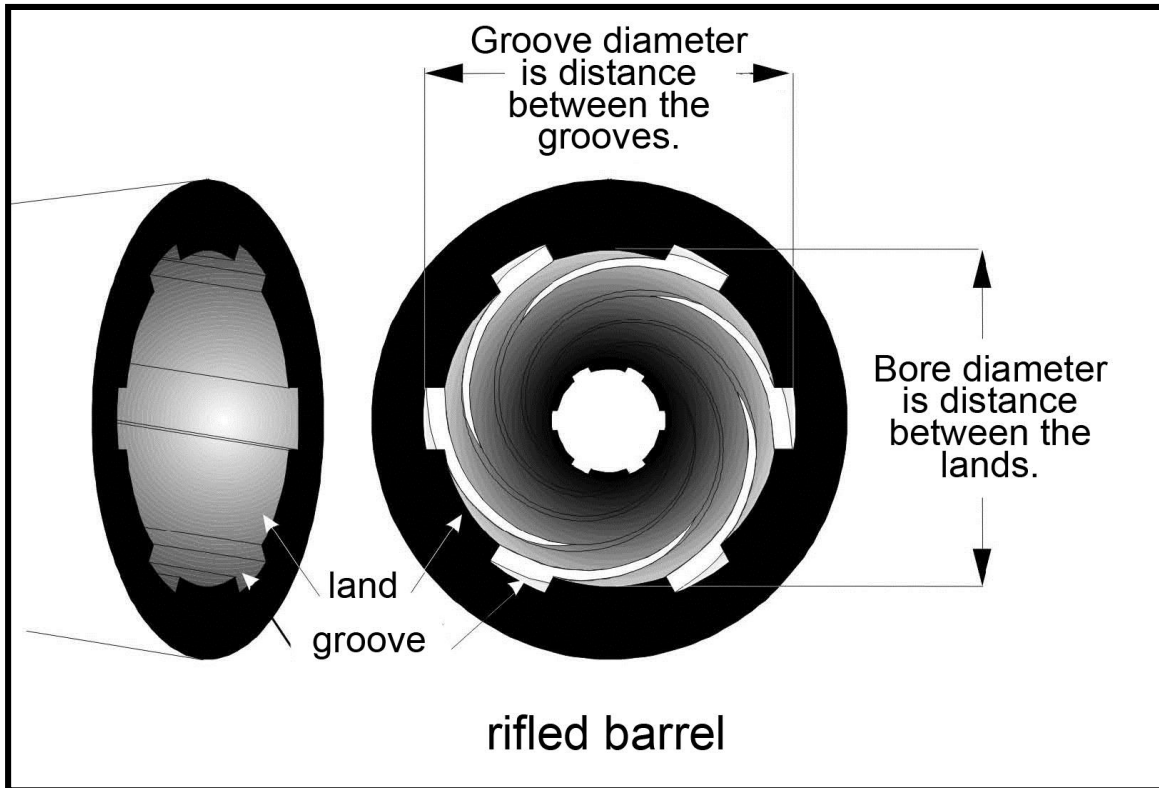

Figure 91. Rifled Barrel

13.3. Cartridges

13.3.0. Overview

- A cartridge is the ammunition used in a firearm. Two kinds of cartridges commonly available are: rim-fire and centre-fire. These terms describe where the primer is located at the base of the cartridge casing. They also describe where the firing pin strikes.
- Manufacturers produce firearms of many calibres. Always make sure that the cartridge name on the head stamp (Figure 92) matches the information on the data stamp, if available, on the barrel or slide of the firearm (Figure 93). This is the most important point to remember when selecting ammunition. Then choose the right type of ammunition for your firearm and target. The right shape or weight of the bullet is an example. If in doubt, consult a firearms or ammunition dealer.
- If there is no data stamp, take the firearm to a qualified individual. They can measure the chamber and advise on proper ammunition. Additional information is available from manufacturer's catalogues and brochures.
- Many firearm owners load their own centre-fire ammunition. This allows them to save money and create a high-quality product made specifically for their firearm and shooting conditions.
- Incorrectly loaded ammunition may cause the firearm to malfunction or jam. Malfunctions could lead to an incident. The firearm could blow up and injure the shooter. Do not accept or use reloaded cartridges unless you know that they were made and reloaded correctly.

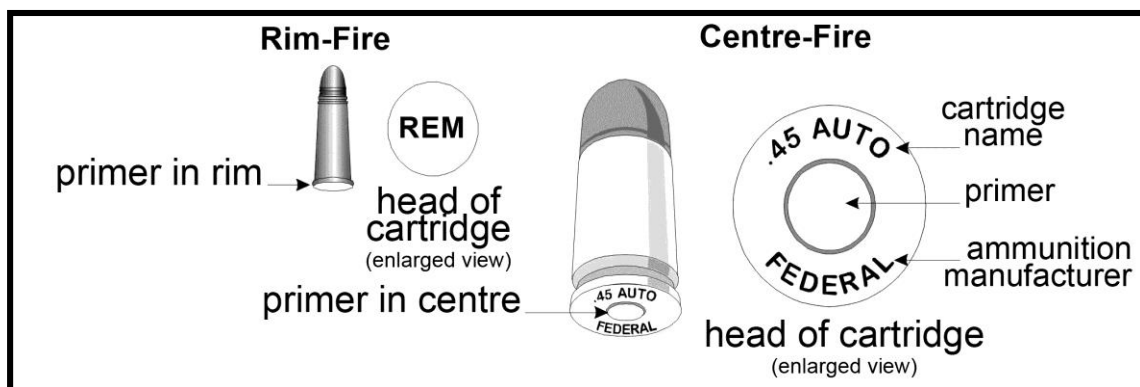

Figure 92. Example of a Rim-fire and Centre-fire Cartridge with Head Stamp

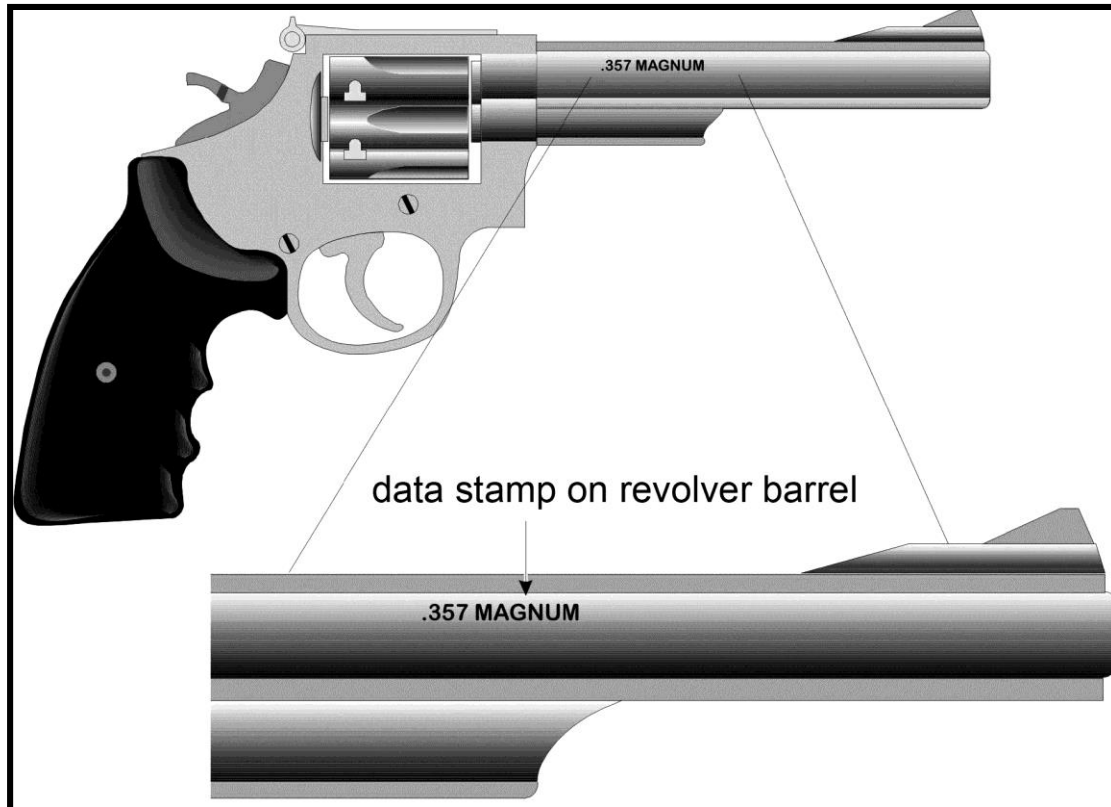

Figure 93. Example of a Barrel Data Stamp



Some firearms may not have a data stamp, or they may have an incorrect stamp. Some firearms may have been altered and the existing data stamp may be incorrect. They should be checked by a qualified individual before use. If you are reloading your own ammunition, you must strictly follow the instructions and procedures outlined in the manuals provided for this process. Visually inspect all cartridge components for defects before loading.

13.3.1. Types of cartridges

There are two basic types of modern cartridges: rim-fire and centre-fire.

- a. Rim-fire ammunition's priming chemical fills the space inside the bottom rim of a thin brass or copper cartridge casing. The soft rim dents when struck by the firing pin. This crushes the priming compound. It explodes, and this ignites the powder (Figure 94).
 - The .17hrm is also a rim-fire ammunition but the popular modern rim-fire cartridges are .22 calibre. They commonly come in short, long and long rifle. A .22-magnum cartridge is also available; however, it is not interchangeable with the other .22 cartridges. Be sure to use the correct ammunition for your specific firearm.
 - Rim-fire cartridge bullets generally are made of lead. They can be jacketed or lubricated with grease or special waxes that reduce the build-up of lead in the handgun barrel except for the .17hrm that is jacketed.



Dry firing a rim-fire firearm can damage the firearm. Dry firing means to initiate a firing sequence without a cartridge in the chamber.

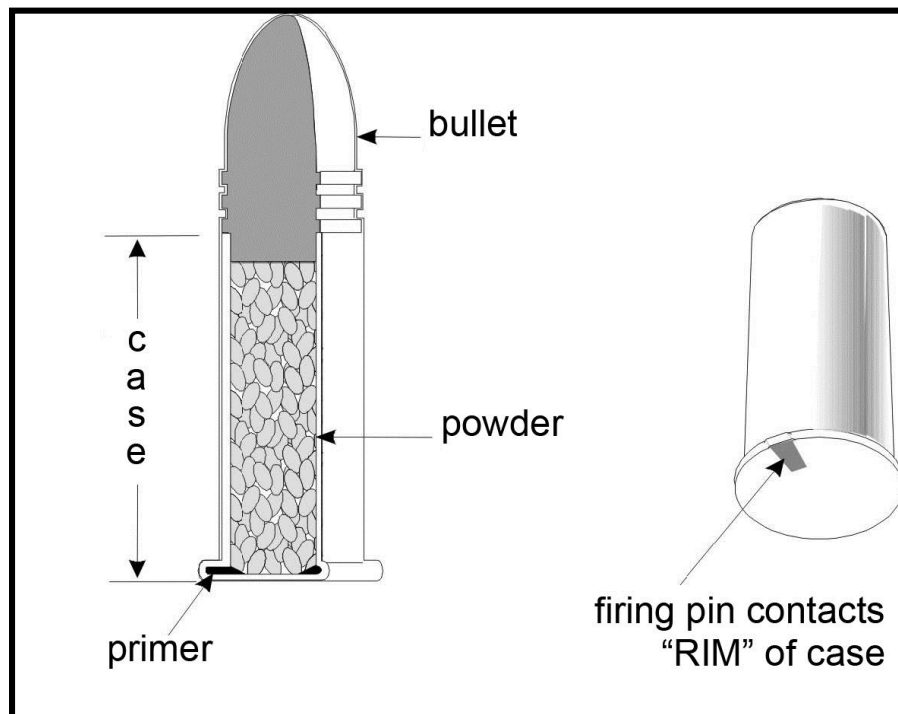

Figure 94. Rim-fire Cartridge

- b. Centre-fire ammunition is generally used for larger more powerful calibre firearms. The primer is located at the centre of the base of the cartridge case. The firing pin strikes the primer. This explodes the priming compound. This in turn ignites the powder charge.

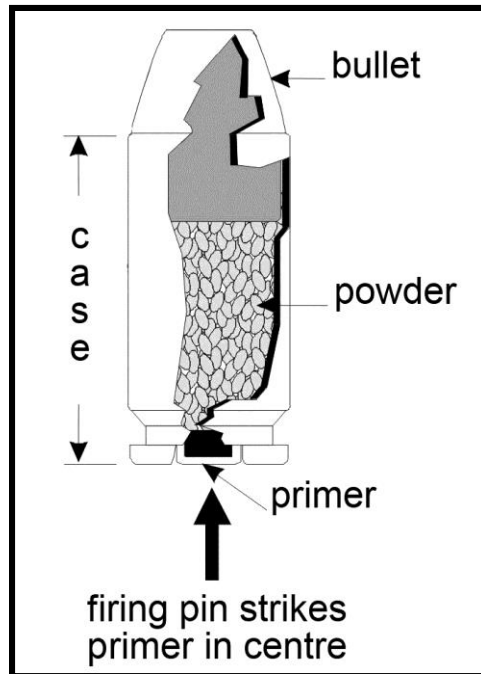

Figure 95. Centre-fire Cartridge

Table 11. Sizes and Types of Handgun Ammunition

TYPE	COMPONENTS	PURPOSE
<p>Sizes: calibre e.g., .22 or .45 or 9 mm</p> <p>Figure 96. Rim-fire and Centre-fire</p>	BULLET	Strikes target
	POWDER	Burns and expands to propel bullet
	CASE	Contains components
	PRIMER	Fires powder charge when struck by firing pin

13.3.2. Cartridge names

- a. There are various ways of identifying or “naming” cartridges. Some cartridges have several names. The cartridge name, or an abbreviation of it, is stamped on the head of the case. It is also found printed on the ammunition manufacturer’s box.



Cartridges with different names are not interchangeable (such as .38 S&W/.38 Special/.38 Super Auto)

- b. A manufacturer may choose to make a firearm or ammunition in a cartridge originally made by another manufacturer, and as a result, confusion can occur. For example, you can use a Remington rifle to fire a .300 Winchester Magnum cartridge made by the Federal Cartridge Company.
- c. The head stamp includes very valuable information, such as the cartridge name. It may also tell you the following:
 - the caliber;
 - the manufacturer; and
 - whether the ammunition is regular or magnum and any other relevant details.
- d. Always read the cartridge name. It is the only way to be sure that the cartridge matches the firearm. If in doubt, check with a gunsmith or gun shop.
- e. The term magnum comes from the description of a large bottle of wine. It was first applied to large bottleneck cartridges that produced greater power than was the normal standard for that calibre. Today, it is more a marketing term than a technical term, but it is an important part of the name.
- f. To choose the right ammunition for the type of target and firearm, follow the manufacturer’s recommendations. For handgun ammunition, the manufacturer’s recommendations are included in the catalogues distributed through sporting goods stores and gun shops.

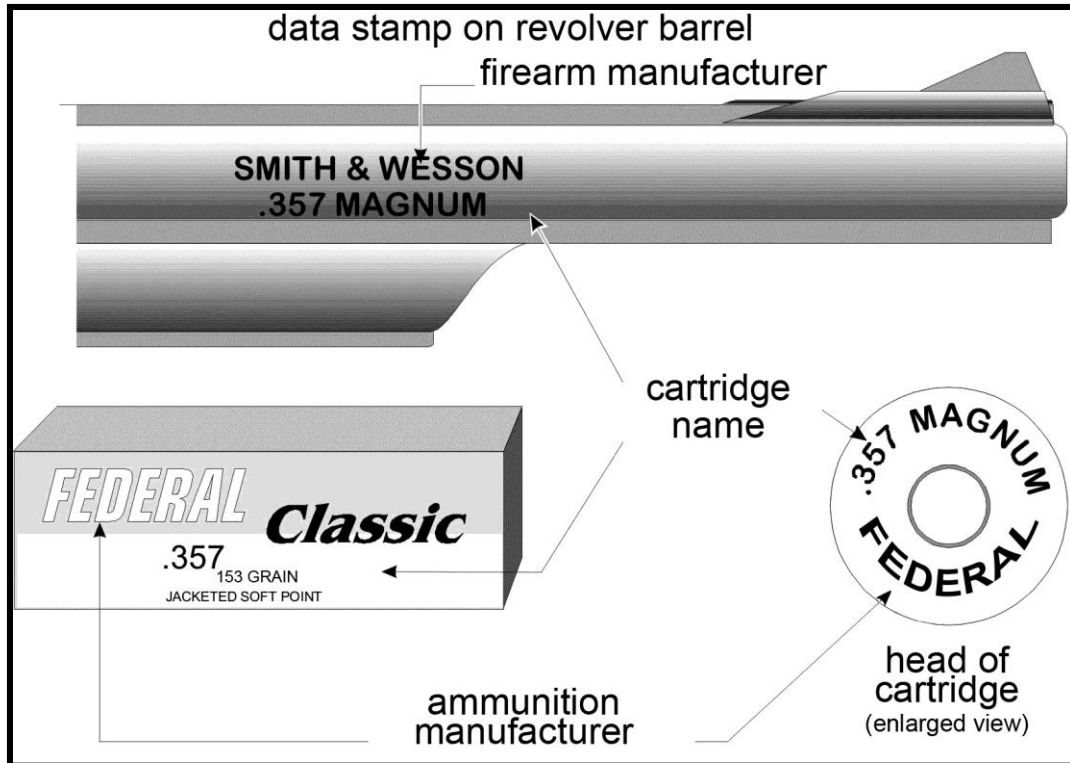

Figure 97. Cartridge Head Stamp, Data Stamp and Ammunition Box Label



Some ammunition may not have a cartridge name stamp, such as rim-fire cartridges. Refer to the information on the ammunition box. If in doubt, have any such ammunition checked by a qualified individual before you use it.

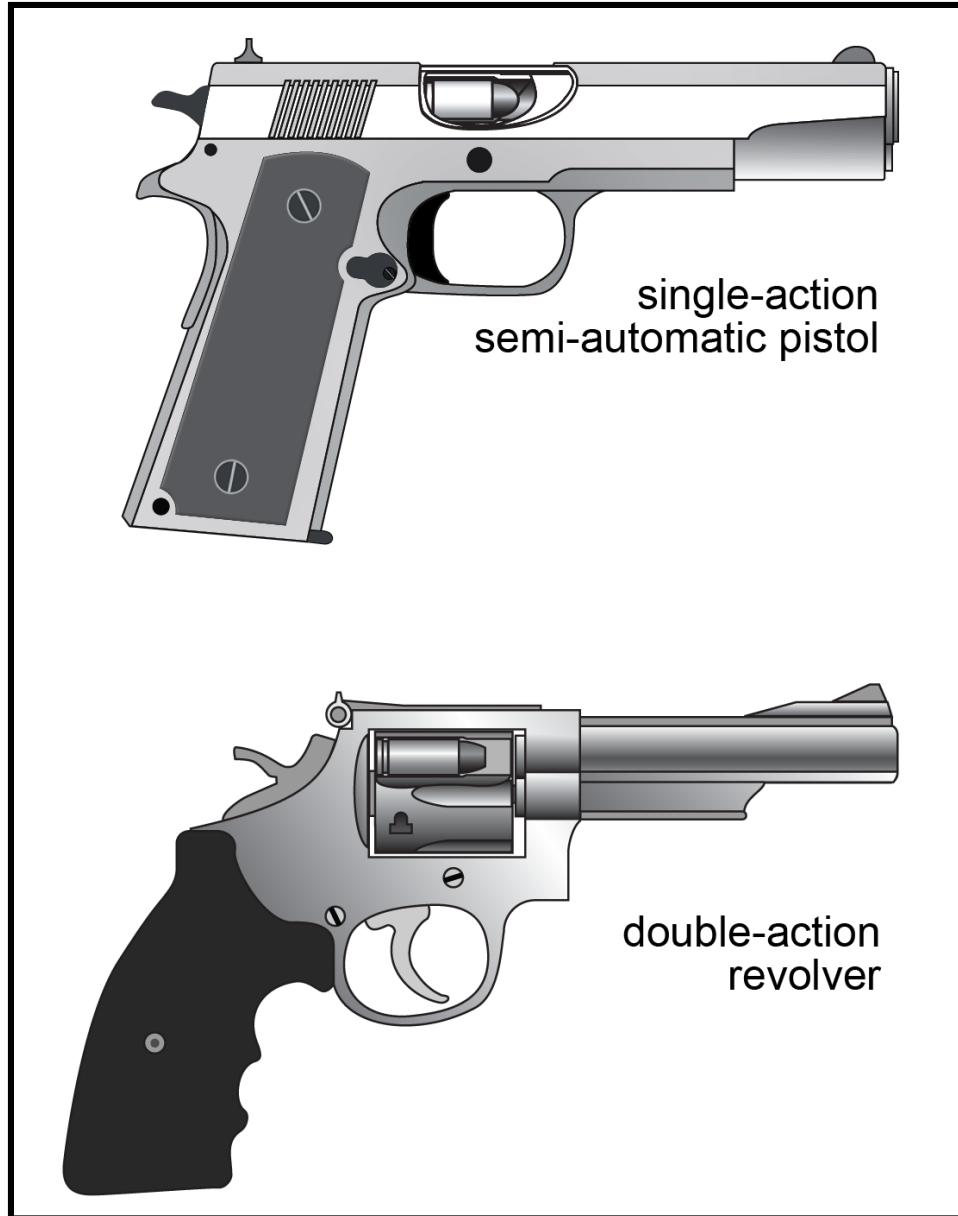

Figure 98. Chambered Ammunition Cut-away

13.3.3. Cartridge components and materials

Ammunition varies in size, appearance and materials. Ammunition cartridges for handguns are made up of the four basic components described below (Figures 99 and 100):

1. The bullet is the projectile at the front end of the cartridge. It is propelled from the firearm by the expansion or explosion of gas from the burning powder. Usually, the bullet is made of lead, lead alloy or other dense material. It may also be covered by a jacket of a harder metal. When the nose of the bullet is covered in this manner, it may be referred to as a full-metal jacket, hard point or ball ammunition. If the lead is exposed at the front of the bullet, it is referred to as a jacketed soft point. Copper or gilding metal is commonly used as jacket materials. Bullets come in a variety of sizes, shapes and weights. You must select the right combination for the target that you plan to shoot. Target bullets are often made from lead alloy. Lead handgun target bullets are commonly of a design known as a wadcutter or semi-wadcutter. Their sharp edges produce precise holes in paper targets.
2. The powder charge is a chemical compound inside the case. It is ignited to propel the bullet through the barrel.
3. The case holds all the other ammunition parts. It is usually made of brass. It could also be made of steel, copper or aluminum.
4. The primer contains a chemical mixture that explodes when the firing pin strikes it. This explosion ignites the powder charge.

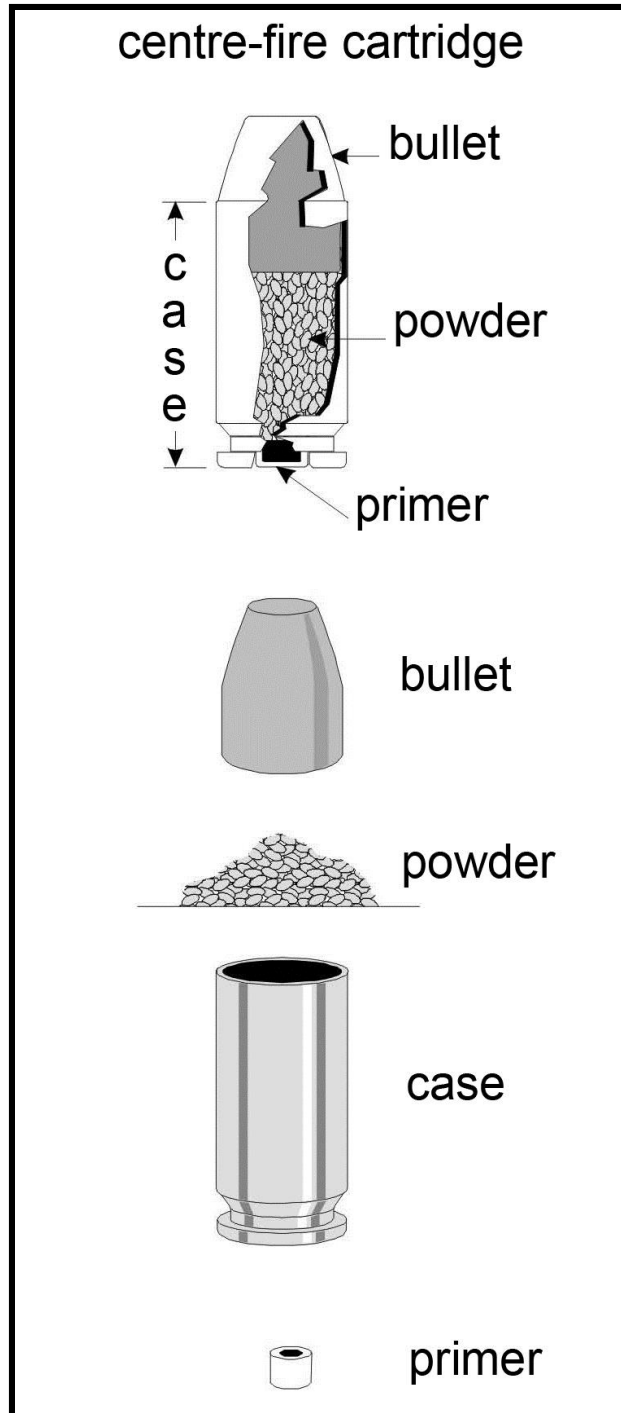

Figure 99. Centre-fire Bullet, Powder Charge, Case and Primer

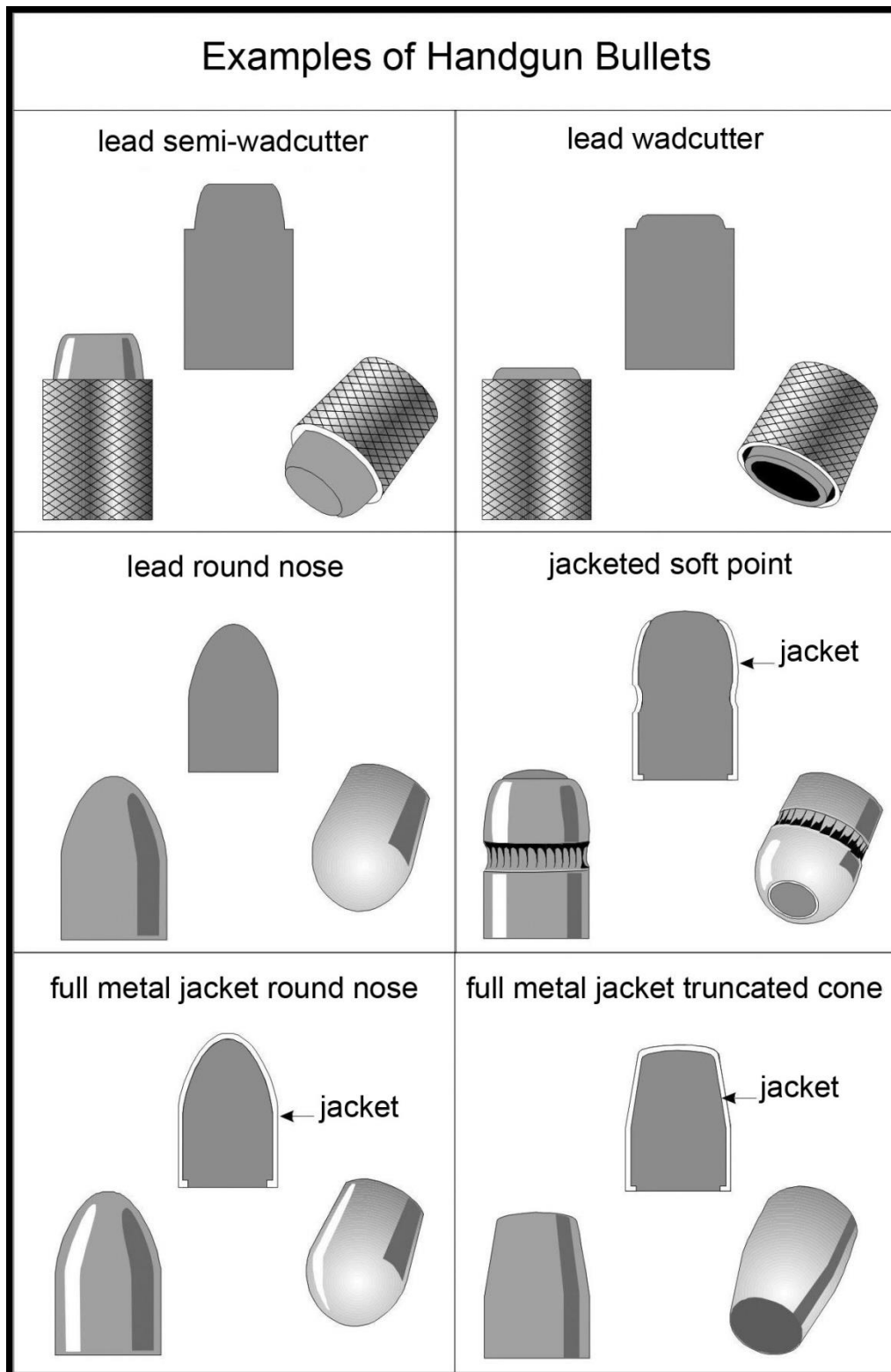

Figure 100. Examples of Handgun Bullets

13.4. Ballistics

- a. Ballistics is the study of projectiles in flight and what affects them.
- b. Modern firearms can shoot a long distance. For this reason, every shooter should understand ballistics. Handguns can shoot a bullet more than two kilometres.
- c. Ballistics tables for ammunition supply the information to calculate the flight path and performance of cartridges.
- d. You want to shoot safely. Therefore, you need to know how far your projectile will travel. That means that you need to know the dangerous range.



Be sure of your target and beyond. If there is any reason your shot may be unsafe, do not fire.

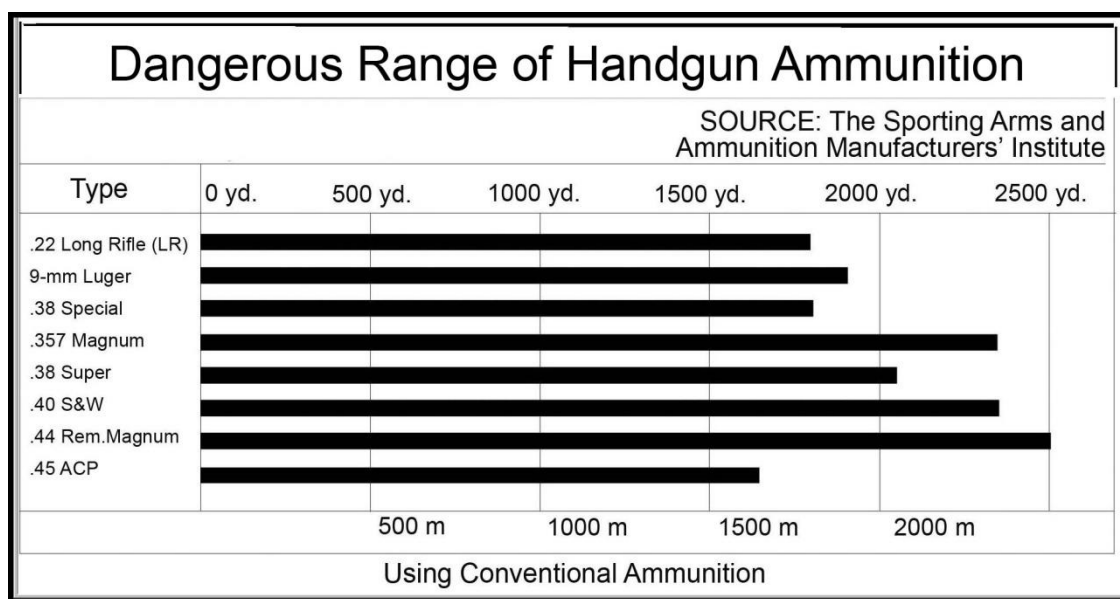

Figure 101. Dangerous Range of Handgun Ammunition

13.5. Trajectory

- a. The trajectory is the path a discharged shot or bullet takes during flight. Several factors affect this path; examples include, but are not limited to, the following:
 - Gravity pulls the bullet down toward the ground as it is travelling forward. This results in a downward curved path.
 - Air resistance slows down the flight of the bullet.
 - Velocity is the speed at which a bullet travels in a given time and direction.
 - Mass is the weight of the bullet.
- b. The firearm muzzle must be raised from the horizontal position to make up for gravity. The trajectory of a projectile is curved. It crosses the line of sight twice on the way to a target.

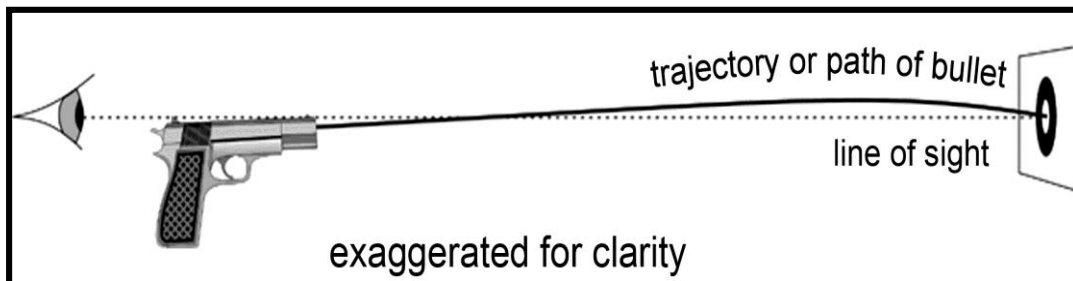

Figure 102. Trajectory of a Bullet



Responsible shooters will follow the recommendations below:

- **Shoot only at targets within effective range.**
- **Consider the maximum distance the shot or bullet may travel beyond the target.**
- **You are responsible for where the bullet stops.**

13.6. Hazards

The selection of the correct ammunition for the firearm is critical to safe operation but sometimes even the correct cartridge can fail to fire properly. Modern commercial ammunition is normally very reliable but there are several ways the cartridge may not fire.

- A misfire is a cartridge that does not fire. Misfired cartridges should not be reused in the firearm and must be disposed of properly. Muzzleloading firearms may also misfire.
- A hangfire is a delayed fire in which the firing pin strikes the primer but it does not create enough flame to ignite the powder instantly. If the muzzle is not pointed in a safe direction when the cartridge eventually fires, it may result in an injury. If the cartridge is removed from the chamber and then discharges, the explosive rupture of the case may also cause injury. Muzzleloading firearms may also have a hangfire.
- A primer pop (squib load) happens when the cartridge does not contain any gunpowder or when the gunpowder is no longer effective. The firearm will discharge the primer without the usual noise or recoil. This may have enough force to push the bullet out of the case, but the bullet may lodge in the barrel. If another bullet is fired, the barrel may rupture and cause possible injury.



If the trigger is pulled and there is no noticeable discharge, wait 60 seconds while pointing the muzzle in a safe direction. If there is no hangfire within 60 seconds, open the action and unload the firearm. PROVE the firearm safe to ensure that there are no bullets lodged in the barrel.

13.7. Firearm malfunctions



Generally, using commercially made ammunition and a properly maintained firearm, malfunctions will not occur. Firearms jammed with a cartridge in the chamber(s) can be hazardous. This hazard, if not dealt with properly, may result in a serious injury. Consult a qualified person or gunsmith for information on how to perform this function in the safest possible manner with your particular firearm.

13.8. Ammunition precautions and legislation

Explosives information is issued by Natural Resources Canada. It indicates that you may keep reasonable quantities of sporting ammunition on your property. “Reasonable” means quantities typically required for a rifle, handgun, shotgun or for part of a collection. This ammunition must be for your private use, not resale. Contact Natural Resources Canada for details. You must take every necessary precaution against incidents by adhering to the instructions below:

- Ammunition must be stored out of children’s reach. It must be kept away from flammables.
- Ammunition for a restricted firearm may only be stored in a place where it is not within easy access to the firearm, unless the ammunition is stored, together with or separately from the firearm in:
 - a securely locked container or receptacle that cannot be easily broken open or into; or
 - a securely locked vault, safe or room specifically built or adapted for the secure storage of restricted firearms.
- In a dwelling house, ammunition for a restricted firearm must not be displayed with the firearm and it cannot be within easy access to the firearm from which it can be discharged.
- In a place other than a dwelling house, ammunition for a restricted firearm must not be displayed with the firearm and it cannot be within easy access to the firearm from which it can be discharged, unless the ammunition is displayed in a securely locked container or receptacle that cannot be easily broken open or into.
- All ammunition should be stored in a cool, dry place, preferably in a vented container. This will reduce the chance of corrosion or breakdown of ammunition components that could cause the firearm to jam or misfire.



Keep in mind that storing ammunition in an unvented container may create an explosive hazard during a fire.

Ammunition Safety Points to Remember

- Carry ammunition only for the firearm you are using.
- Never experiment with unfamiliar ammunition.
- Using modern ammunition in old firearms may be hazardous.
- When a misfire occurs, slowly count to 60 while pointing the muzzle in a safe direction. Remove the cartridge following safe procedures. Then, carefully inspect the bore for obstructions.
- Never use old or corroded ammunition or reloading components.
- Never use cartridges if you are uncertain about their safe use.
- Never interchange smokeless powder and black powder. Use them only in firearms intended for their use.
- Store all ammunition so that unauthorized persons do not have access to it.
- Ammunition should never be displayed with a firearm.
- Ammunition is most safely carried in its original container.
- When hand loading your own ammunition, be certain to strictly follow the procedures in the manuals about reloading ammunition. Treat primers with extra caution—they are explosive devices.

13.9. Review questions

1. What are the spiral grooves cut inside the barrel called?
2. Name the two basic types of modern ammunition.
3. How do you identify the calibre of ammunition cartridges?
4. How long should you wait after a misfire, before you ACTS/PROVE your firearm?
5. Is it safe to use a .357 cartridge in a firearm chambered for a .38 special?



**MODULE 14:
OPERATING HANDGUN ACTIONS**

MODULE 14: OPERATING HANDGUN ACTIONS

14.0. Overview

- a. To understand the safe use of firearms, you must become familiar with action types, how they work, and how to safely load and unload them.
- b. This module first defines the different types of firearms, various safeties and action releases and shows how to do the following:
 - identify each type of action;
 - locate safeties (some actions will not open unless the safety is **OFF**);
 - open actions and unload—**ACTS and PROVE it safe**; and
 - safely load each type of action, with the safety **ON**, whenever possible.



Always wear safety glasses and hearing protection when loading and discharging firearms.

14.1. Common types of handgun actions

Handguns are generally classified by their type of action. There are two basic types as follows:

- a. A revolving action is used for some handguns. It has several chambers in a rotating cylinder and can contain one cartridge in each chamber. Revolvers are manufactured as a non-swing cylinder, a swing-out cylinder or a top break.

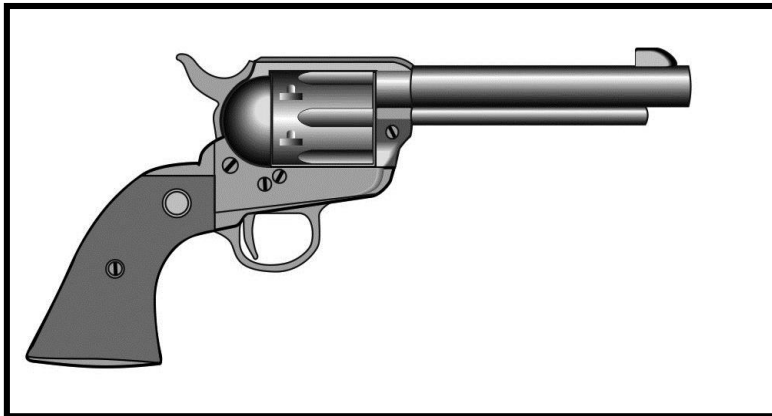

Figure 103. Revolver

- b. A semi-automatic action extracts and ejects empty casings and inserts another cartridge in the chamber automatically after each pull of the trigger.

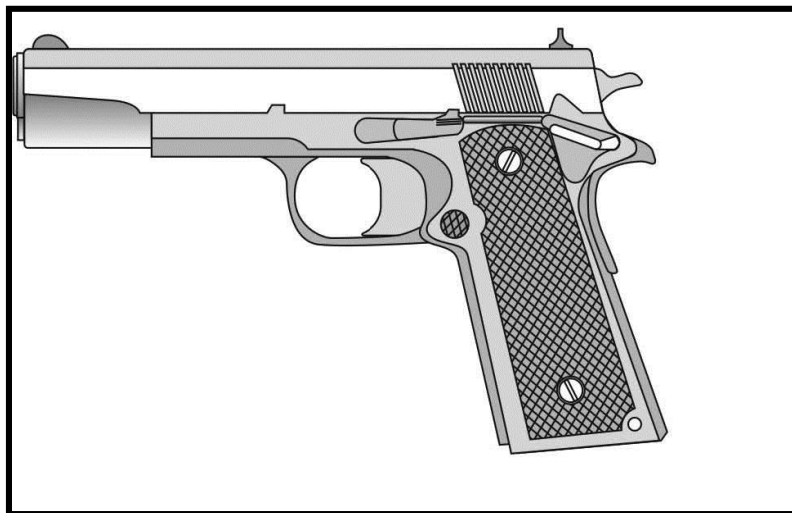

Figure 104. Semi-automatic

14.2. Other types of handgun actions

- a. A hinge (or break) action opens near the breech and is usually single barrel.

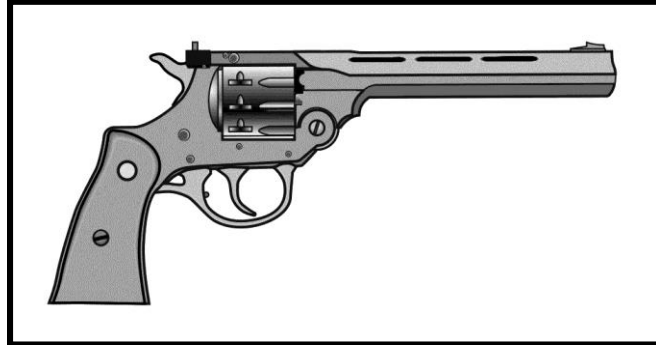

Figure 105. Break-action Revolver

- b. A bolt action is similar to those found on long guns and can be either single shot or multiple shot.

14.3. Trigger functions

There are three primary functions. They are single action only, single and double action and double action only.

- a. A single action is an action that releases the hammer from a cocked position when the trigger is pulled.

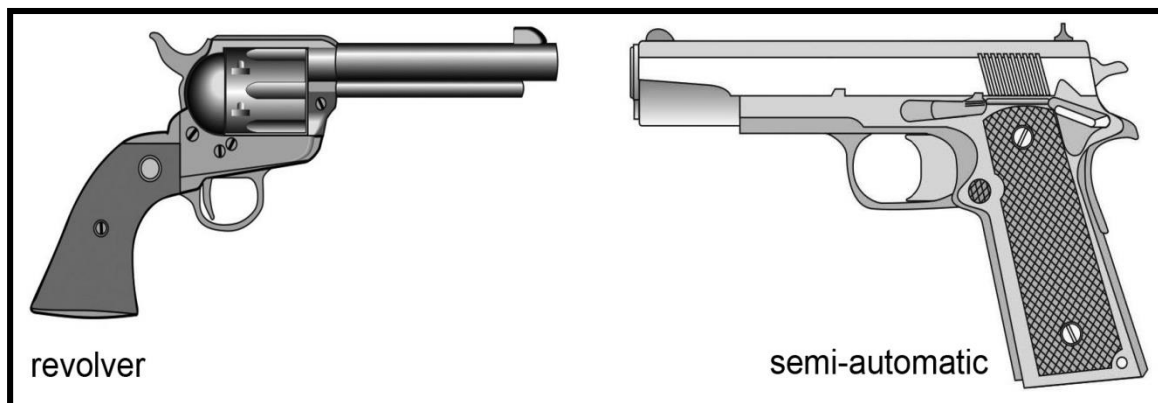

Figure 106. Single-action Handguns

- b. A single and double action is an action that cocks and fires with a complete pull of the trigger. Double actions may also fire in single action mode.

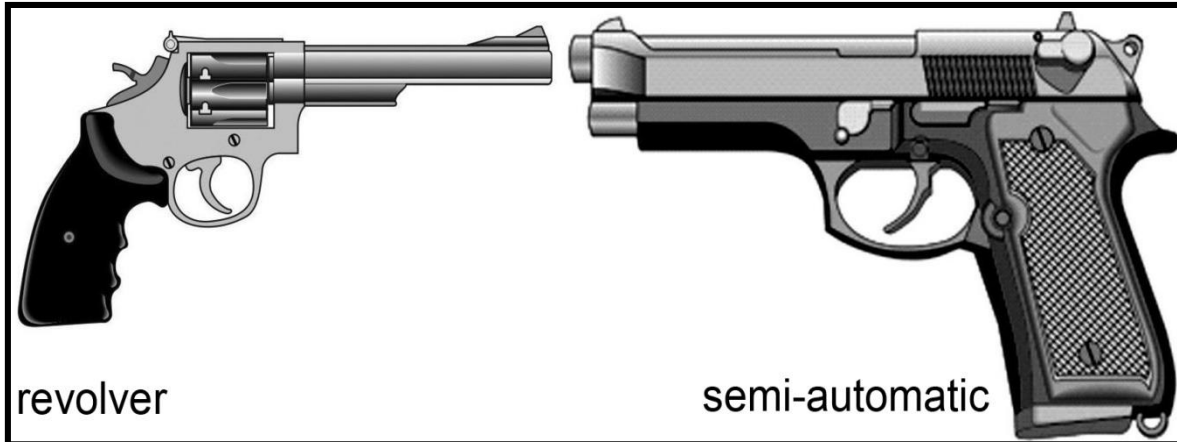

Figure 107. Double-action Handguns

- c. A double action only is an action that cannot fire in the single action mode.



Double action / single action requires a different trigger pull between the first and subsequent shots.

14.4. Safeties

14.4.0. Overview

- a. A mechanical device known as a safety is included on most firearms to reduce the chances of unintentional firing. However, mechanical devices can fail. A hard blow may cause some firearms to fire even with the safety ON. Therefore, safe handling of a firearm by the person holding it will always be the most important firearm safety device. Always use the safety, but never rely on it to prevent firing.
- b. The safety is designed to prevent the firearm from firing by interrupting the firing sequence. The safety blocks one or more of the trigger, sear, hammer or firing pin.
- c. There are two types of safeties: manual safeties and built-in safety devices. Manual safeties can be placed on or off. They include slide safeties, like the lever safety, and frame safeties, like the safety lock. Built-in safety devices may prevent unintentional discharge. They include decocking levers, trigger safeties, magazine disconnects and grip safeties.



Never rely on a safety to prevent unintentional firing. A safety can fail. All safeties are slightly different. Consult the owner's manual. Different manufacturers may use different terminology to describe their safeties.

14.4.1. Manual safeties

- a. The lever safety is found on either the right or left side of the receiver. It is operated by pushing forward and back to either the ON or OFF position.
- b. The safety lock is normally operated by pushing it up into a notch on the slide. These safeties are commonly found on the left side of the receiver, near the hammer on single-action semi-automatics.
- c. With semi-automatic handguns, the hammer is automatically placed into the full-cock position each time the slide is pulled to the rear. In single and double-action semi-automatic handguns, the hammer remains in this position. In double action only, the hammer returns forward to the rest position. Whenever possible, when operating the action of any firearm, always have the safety on.

14.4.2. Built-in safeties



These safety devices may or may not be present on your firearm. Always consult your owner's manual.

- a. With a double-action semi-automatic handgun, there may be a decocking device or decocking lever. These are common on modern models. Instead of carefully manually decocking the hammer as you would with single-action revolvers and semi-automatics, you need only depress the decocking lever. The decocking lever safely lowers the hammer. To accomplish this task, hold the firearm firmly in the strong hand and depress the decocking lever with the weak hand thumb. On some handguns, the decocking lever also engages the safety. Double-action-only handguns do not have a decocking lever.
- b. The trigger safety is found on some models of handguns. This is a pivoting device found as a part of the trigger. As the trigger is pulled, the safety moves to the OFF position and the handgun can be fired.
- c. The magazine disconnect safety prevents the firearm from being discharged when the magazine is removed.
- d. The grip safety is usually found on semi-automatic handguns. It disengages when the firearm is held in and ready to fire.

- e. The hammer block / transfer bar will prevent the firing pin from touching the primer. On many older revolvers, the firing pin may rest on the primer of any cartridges directly below it when the hammer is in the forward position. If the hammer is struck, the cartridge will fire. Most modern revolvers include a safety device to prevent this from happening. This is normally accomplished by preventing the firing pin from touching the primer unless the trigger is held all the way to the rear. The most common safety devices used to accomplish this are the hammer block and transfer bar. Consult your owner's manual or a gunsmith to find out if your revolver has one of these devices.



Be very careful when moving the hammer. It could slip from beneath your weak hand thumb and fire the cartridge. Persons who are right handed would consider their left hand as their weak hand. The presence of a half cock on a firearm does not guarantee it is a safety. Some firearms do not use it as a safety. Consult the owner's manual.

- f. Safely lowering the hammer from the full-cock position on a single-action revolver requires caution. The following method can be used when a "cease-fire" is called and the hammer is at full cock:
 - 1. While maintaining a solid grip with the strong hand, place the weak-hand thumb fully on the hammer.
 - 2. Pull the trigger with the strong-hand finger and begin to slowly lower the hammer fully forward. When the hammer is disengaged, release the trigger. If a semi-cocked position exists on the firearm, the hammer will immediately stop.
- g. There are some differences between various models of single-action handguns. If possible with the model you are using, move the trigger finger off the trigger and out of the trigger guard immediately after the hammer begins to move forward. Slowly and carefully lower the hammer. If there is no half-cock position, lower the hammer all the way forward and down.
- h. Double-action handguns also rely on a heavy double-action trigger pull as a further safety barrier to unintentional firing.



Before loading any firearm, determine the position of the safety. Although all the illustrations of revolvers and pistols in this manual depict firearms with exposed hammers, many manufacturers produce them with internal hammers. Although some of these internal hammers function identically to the external hammers on comparable pistols, most function more like the mechanism on a bolt action. The hammer does not pivot on an axis; it moves back and forth in a straight line. It is called a striker. Some striker mechanisms use a built-in firing pin; others hit the firing pin and drive it forward. All the safety procedures for exposed hammers apply to internal hammers, but because the hammer is not visible, it is difficult to see if the hammer is cocked. Great care should be taken.

14.5. Action releases





Most handguns, other than semi-automatics, have some type of mechanism that must be moved to allow an action to be opened or closed. The location of the action release mechanism depends on the make and model of the firearm.



Do not touch any firearm unless you know how to handle it safely. If you do not know, consult the owner's manual or consult a gunsmith who knows that firearm well.

14.6. General loading and unloading procedures

Before attempting to unload a firearm, first follow the **Vital Four ACTS of Firearm Safety** and **PROVE it safe**.

The Vital Four ACTS of Firearm Safety	
	<p>Assume every firearm is loaded.</p> <ul style="list-style-type: none"> • Regard any firearm as a potential danger.
	<p>Control the muzzle direction at all times.</p> <ul style="list-style-type: none"> • Identify the safest available muzzle direction. • Keep the firearm pointed in the safest available direction. • The muzzle of a firearm should not be pointed towards yourself or any other person.
	<p>Trigger finger must be kept off the trigger and out of the trigger guard.</p> <ul style="list-style-type: none"> • Do NOT put your finger on the trigger or inside the trigger guard when you pick up a firearm.
	<p>See that the firearm is unloaded—PROVE it safe.</p> <ul style="list-style-type: none"> • Do not handle the firearm unless you can properly PROVE it safe. • Check to see that both chamber and magazine are empty. Do this every time you handle a firearm, for any reason. • Pass or accept only open and unloaded firearms. It is an essential rule to adopt.

14.6.1. Unloading procedure: ACTS and PROVE it safe

PROVE is an acronym, or memory aid, that stands for the five steps required to ensure that a firearm is unloaded and is safe. The five steps are: Point, Remove, Observe, Verify and Examine. These procedures must be followed to safely unload any firearm.

1. **P**oint the firearm in the safest available direction throughout the unloading procedure.
 - Make sure that nothing touches the trigger throughout this procedure.
 - Put the safety **ON**, if it can be left on during the unloading process.
2. **R**emove all ammunition as follows:
 - If the firearm has a detachable magazine, remove the magazine from the firearm first (this prevents a semi-automatic from chambering another cartridge if the action closes).
 - Open the action to remove any cartridges from the chamber(s).
 - Leave the action open.
3. **O**bserve the chamber(s) to confirm that there is no cartridge(s) or empty casing(s).
4. **V**erify that the feeding path is clear of ammunition, casings or foreign objects.
5. **E**xamine the bore for lubricant, rust or other obstructions.

The firearm is now unloaded and safe until it leaves the direct control of the person who unloaded and **ACTS—PROVEd it safe**.

14.6.2. Checking the barrel for obstructions

Always check the barrel and chamber for obstructions before loading.



Only load a firearm when you intend to use it, and only in an area where it can be safely and legally discharged.

14.6.3. Loading procedure

1. Prepare the firearm for loading by going through the complete unloading procedure **ACTS—PROVE it safe**.
2. Clear any obstructions from the chamber(s) and bore(s). Clean if required.
3. Put the safety **ON**, if it can be left on during the loading process.
4. Point the firearm in the safest available direction throughout the loading and chambering procedure.
5. Make sure that nothing touches the trigger throughout this process.
6. Where possible, with the action open, select and load the correct ammunition by matching the data stamp on the firearm to the head stamp on the cartridge.
7. Point down range, extend arm, locking wrist and elbow, and close the action.
8. Leave any safety on (if applicable) until ready to fire.

The firearm is now loaded and ready for use. It requires continuous care and attention until it is unloaded.



Always be sure of your target and beyond.

14.6.4. Loading and unloading the most common action types



Do not attempt to handle any firearm that you are uncomfortable handling. To ensure safe handling of any firearm, seek the assistance of a qualified individual.

14.7. Operating repeating firearms: revolver actions

14.7.0. Overview

- a. All firearms have their own unique aspects. One of the best ways to discover the specific methods for unloading and loading your particular firearm is to study the owner's manual. The steps outlined in this module are not meant to replace a full understanding of a given firearm owner's manual. The following information is an introduction to the most common actions. The general procedure does not change, but the details can vary significantly.
- b. Many firearms are repeaters. Revolvers, for example, are repeaters because they hold more than one cartridge and can be fired several times in a row. The most common repeating handguns are the revolvers described in this module.
- c. The extra cartridges in a manually repeating revolver are contained in the cylinder (Figure 108).
- d. The revolving action takes its name from a revolving cylinder containing a number of cartridge chambers. One chamber at a time lines up with the barrel and hammer. Revolver cylinders may rotate either clockwise or counter-clockwise, depending on the manufacturer.
- e. Most single-action revolvers have cylinders that are incapable of swinging out. Cartridges are inserted and removed one at a time through a loading port, usually located on the right side. When firing the single-action revolver, the hammer must be manually placed in the full-cock position for each shot. Pulling the trigger completes one function. It releases the hammer.

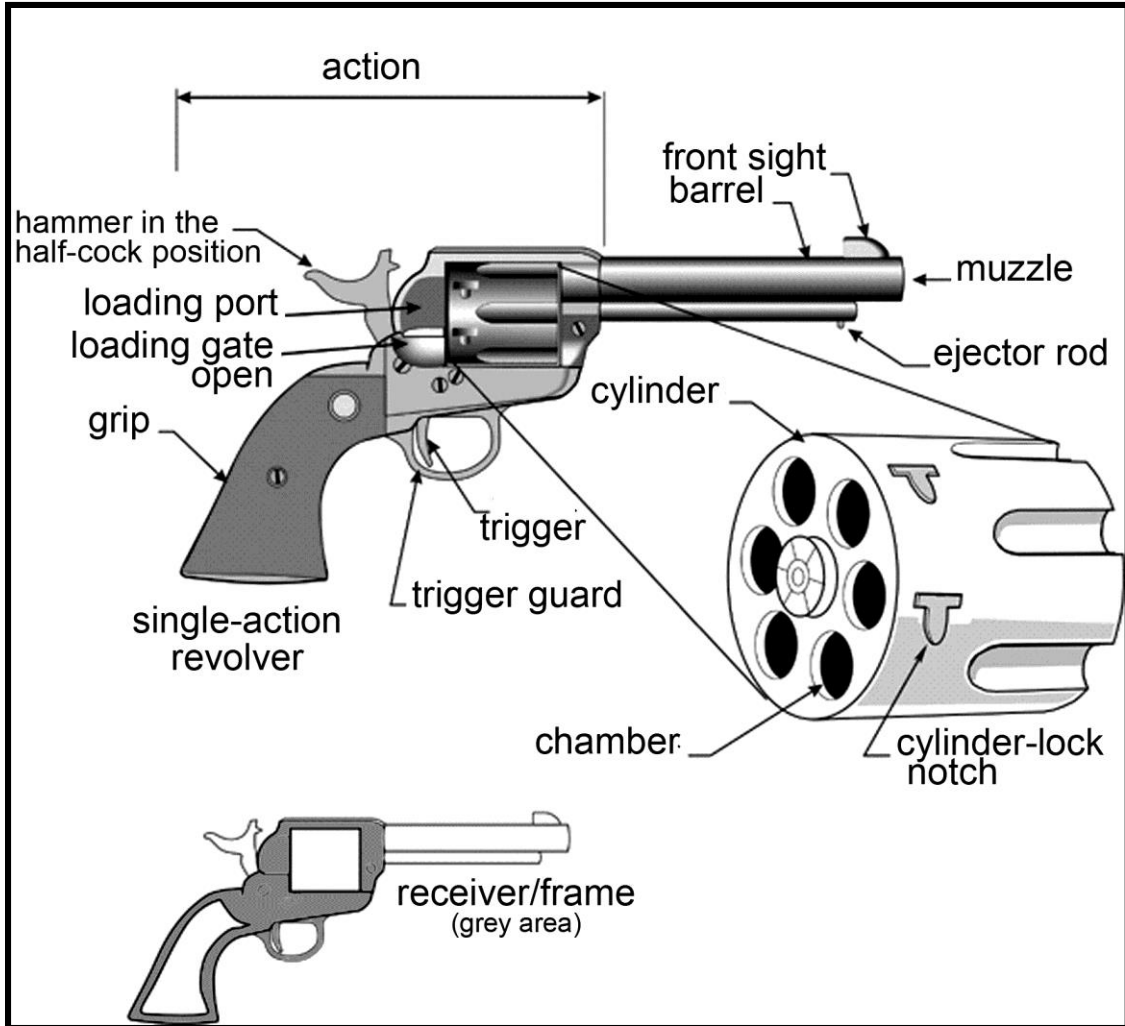

Figure 108. Single-action Revolver

14.7.1. Revolver: single-action non-swing-out cylinder (loading gate) / unloading procedure—ACTS and PROVE it safe



Before attempting to unload a firearm, first follow the Vital Four ACTS of Firearm Safety—PROVE it safe.

1. **P**oint the firearm in the safest available direction throughout the unloading procedure.
 - Make sure that nothing touches the trigger throughout this procedure.
 - Open the loading gate and check if the cylinder will rotate. If the cylinder does NOT rotate, put the safety **ON**, hammer in half-cock/loading notch during the unloading procedure.
2. **R**emove all ammunition as follows:

When the cylinder rotates, observe each chamber through the loading port, as you turn the cylinder, to ensure that there are no cartridges in the cylinder. If any cartridges or casings are present, use the ejector rod under the barrel to remove them. The chamber must be aligned with the loading port. Push the ejector rod from the front to the back. Let any cartridge or casing fall on the shooting bench or range floor and leave it there until you have completed all the steps.

3. **O**bserve every chamber(s) to confirm that there is no cartridge(s) or empty casing(s).
4. **V**erify by inspecting to ensure that the feeding path is clear of ammunition, casings or foreign objects.
5. **E**xamine the bore for lubricant, rust or other obstructions.

The firearm is now unloaded and safe until it leaves the direct control of the person who unloaded and ACTS—PROVEd it safe.

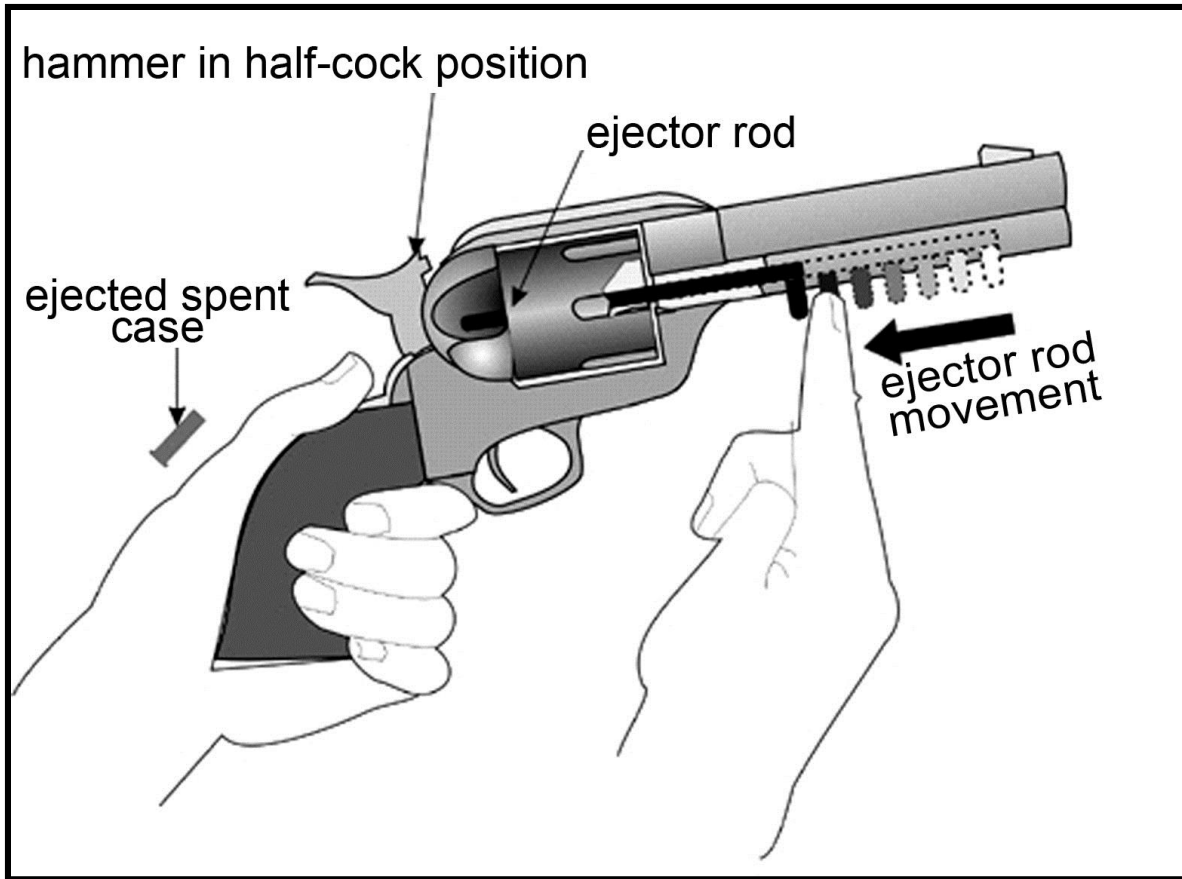

Figure 109. Removing a Cartridge from a Single-action Revolver

14.7.2. Revolver: single-action non-swing-out cylinder (loading gate) / loading procedure



Only load a firearm when you intend to use it, and only in an area where it can be safely and legally discharged.

1. Prepare the firearm for loading by going through the complete unloading procedure—**ACTS** and **PROVE it safe**.
2. Clear any obstructions from the chamber(s) and barrel. Clean if required.
3. Point the firearm in the safest available direction throughout the loading procedure.
4. Make sure that nothing touches the trigger throughout this process.
5. Put the safety **ON**, if applicable. While most revolvers do not have safeties, some do. Consult your owner's manual or ask a qualified gunsmith.
6. With the loading gate open, select the correct ammunition by matching the data stamp on the firearm with the head stamp on the cartridge. Insert the cartridge(s) into the chamber(s).
7. Close the loading gate covering the port.
8. Leave any safety on (if applicable) until ready to fire.

The firearm is now loaded and ready for use. It requires continuous attention until it is unloaded.



Always be sure of your target and beyond.

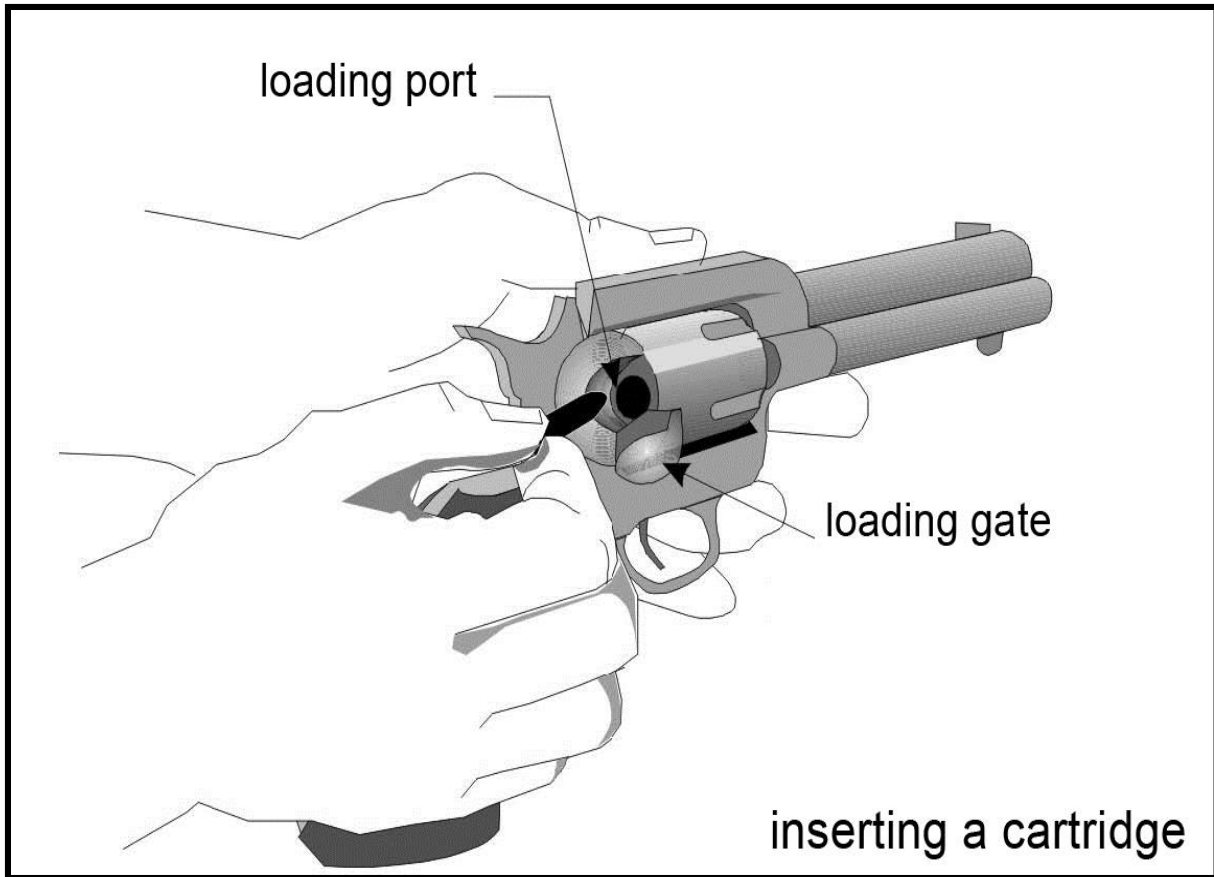

Figure 110. Loading a Single-action (loading gate revolver)

14.7.3. Revolver: double-action swing-out cylinder and break open / unloading procedure—ACTS and PROVE it safe



Before attempting to unload a firearm, first follow the Vital Four ACTS of Firearm Safety—PROVE it safe.

1. **P**oint the firearm in the safest available direction throughout the unloading procedure:
 - Make sure that nothing touches the trigger throughout this procedure.
 - Put the safety **ON**, if applicable. While most revolvers do not have safeties, some do. Consult your owner's manual or ask a qualified gunsmith.
2. **R**emove all ammunition as follows:
 - Operate the cylinder release and expose the chambers by swinging the cylinder to the side or top.
 - Tip the muzzle slightly upward in a safe direction and operate the ejector rod to allow the cartridges or empty casings to fall out. If not ejected, remove them by hand. Let any cartridge or casing fall on the shooting bench or range floor and leave it there until you have completed all the steps.
 - Leave the action open.
3. **O**bserve the chambers to confirm that there are no cartridges or empty casings.
4. **V**erify by inspecting to ensure that the feeding path is clear of ammunition, casings or foreign objects.
5. **E**xamine the bore for lubricant, rust or other obstructions.

The firearm is now unloaded and safe until it leaves the direct control of the person who unloaded and PROVED it safe.

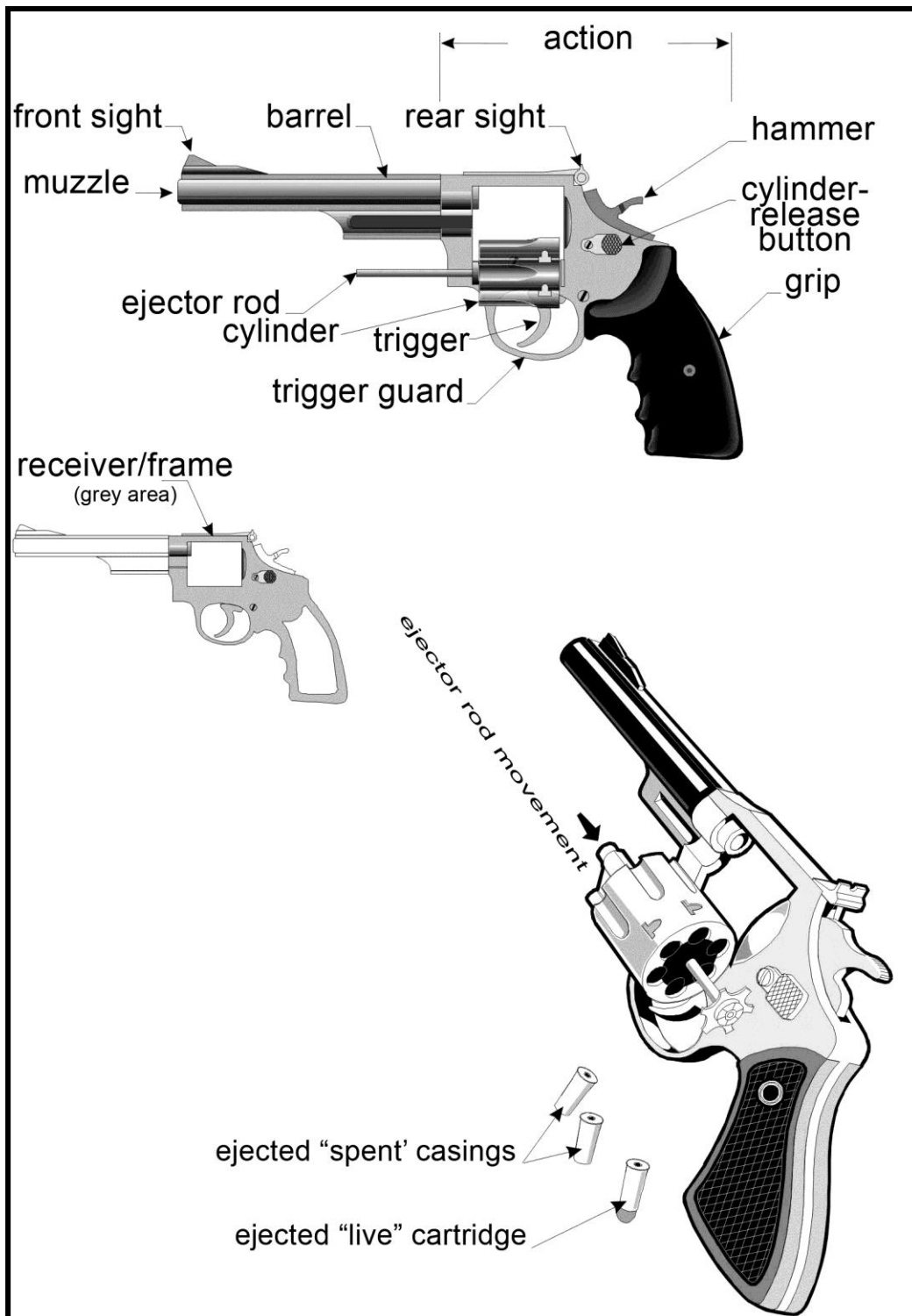

Figure 111. Double-action Revolver Swing-out Cylinder



In a double-action revolver, pulling the trigger all the way to the rear completes two functions:

1. turns the cylinder so a cartridge lines up with the barrel under the hammer; and
2. cocks and releases the hammer.

The cylinder normally has a release that enables it to swing out. This allows more than one cartridge at a time to be inserted, or ejected from, the cylinder.

14.7.4. Revolver: double-action break open / loading procedure—ACTS and PROVE it safe



Only load a firearm when you intend to use it and only in an area where it can be safely and legally discharged.

1. Prepare the firearm for loading by going through the complete unloading procedure—**ACTS and PROVE it safe**.
2. Clear any obstructions from the chamber(s) and bore. Clean if required.
3. Point the firearm in the safest available direction throughout the loading procedure.
4. Make sure that nothing touches the trigger throughout this process.
5. Leave the hammer fully down (if possible) during the loading process.
6. With the action open, select the correct ammunition by verifying that the data stamp on the firearm matches the head stamp on the cartridge.
7. Place the cartridge(s) into the chamber(s).
8. Close the cylinder firmly, locking the action closed.
9. Leave any safety **ON** and the hammer down, if applicable, until ready to fire.

The firearm is now loaded and ready for use. It requires continuous care and attention until it is unloaded.



Always be sure of your target and beyond.

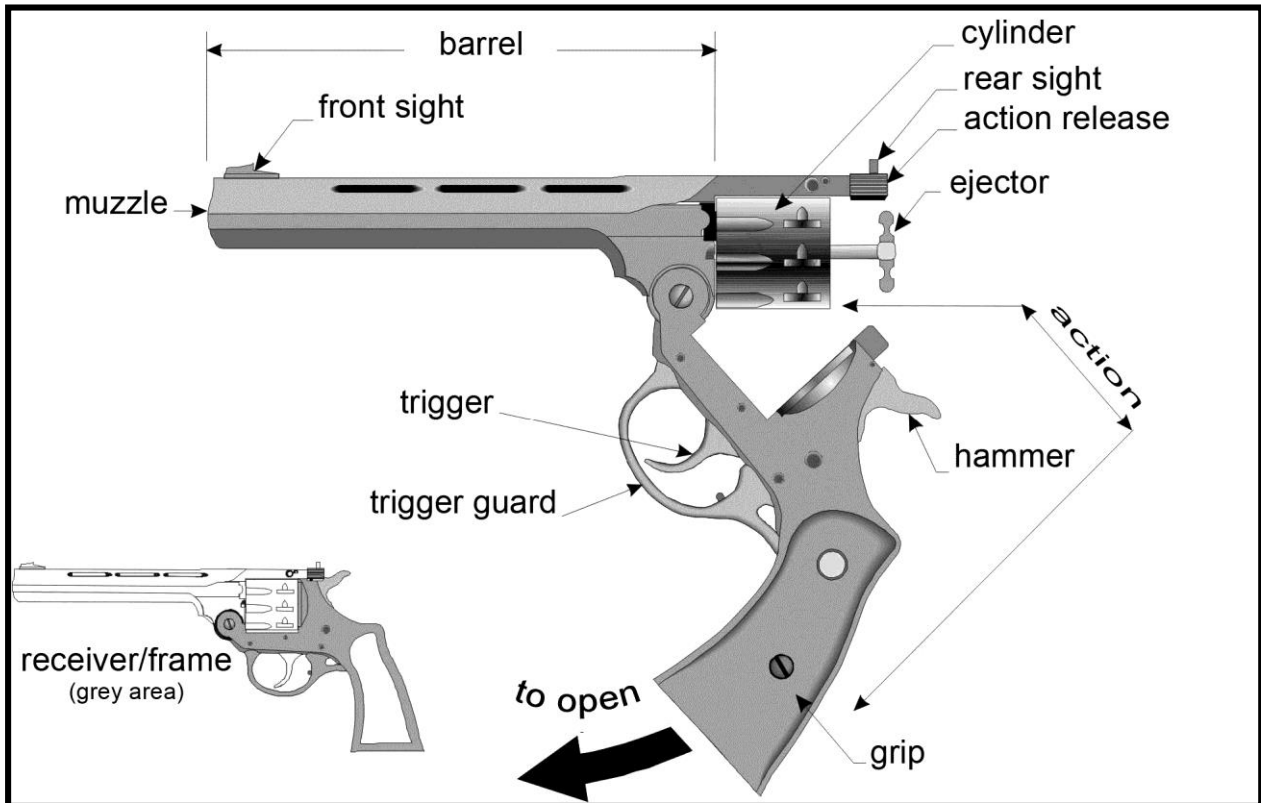

Figure 112. Top-break Revolver



Break-open revolvers operate in a similar manner to other double-action revolvers. Instead of the cylinder typically swinging out, the action hinges open, normally to the top or bottom.

14.8. Semi-automatic actions: pistols

14.8.0. Overview

- a. With each pull of the trigger, the semi-automatic action uses part of the energy of the expanding gas from the burning powder to extract the empty cartridge case and to chamber the next cartridge. There is no need to load another cartridge into the firing position. Each time a cartridge is fired, the empty case is ejected and another cartridge is placed into the chamber from the magazine.
- b. Semi-automatic handguns are further divided into single action, double action and double action only. In double action (D/A) and single action (S/A), the hammer stays cocked after each shot is fired, though the trigger pull is shorter and may need less pressure once the first shot is discharged. In D/A only, the hammer returns to the forward position after each shot is fired.
- c. Semi-automatic safeties vary considerably. Most are located near the hammer. Consult your owner's manual or a qualified gunsmith.

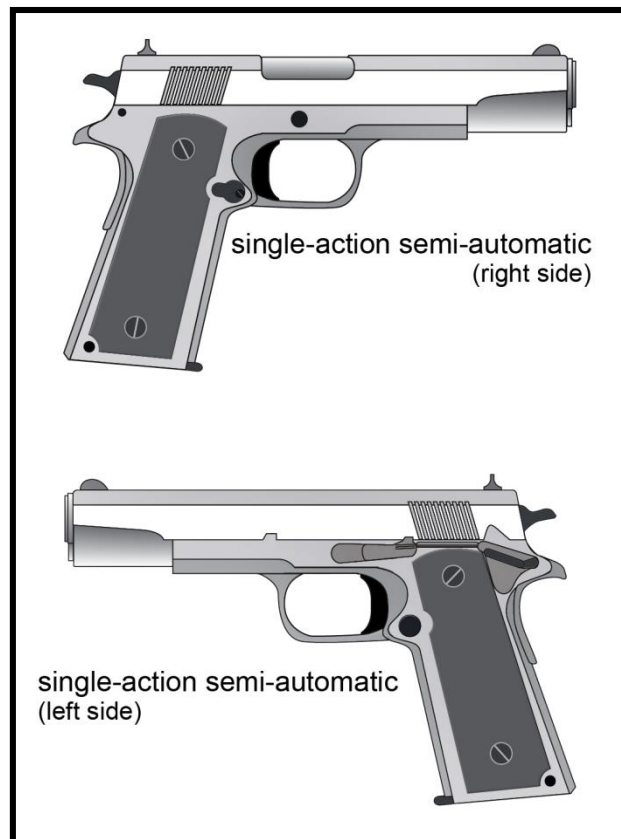

Figure 113. Single-action Semi-automatic

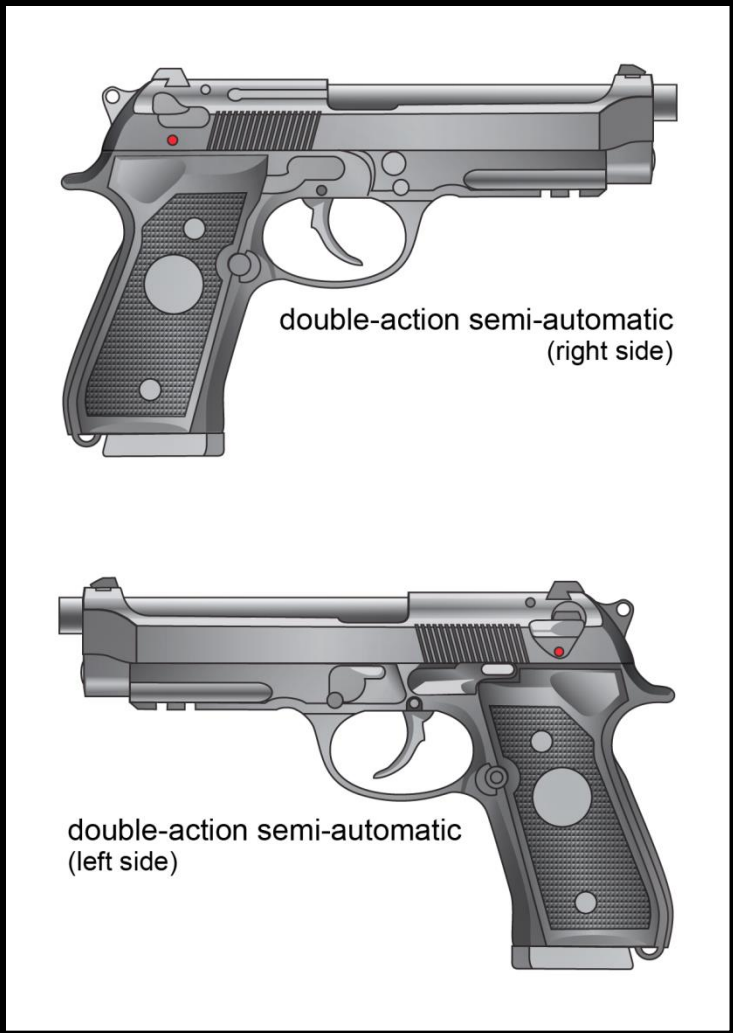

Figure 114. Single/double-action Semi-automatic



Figure 115. Double-action-only Semi-automatic

14.8.1. Semi-automatic: single action, single/double action, and double action only unloading procedure—ACTS and PROVE it safe



Before attempting to unload a firearm, first follow the Vital Four ACTS—PROVE it safe.

1. **P**oint the firearm in the safest available direction throughout the unloading procedure:
 - Make sure that nothing touches the trigger throughout this procedure.
 - Put the safety ON, if applicable, if it can be left on during the unloading process.
2. **R**emove all ammunition as follows:
 - Push the magazine-release button (Figure 116) to remove the magazine (the source of all the ammunition except for possibly one chambered cartridge).
 - Pull the slide to the rear by doing the following:
 - Hold the handgun in the strong hand and point in a safe direction. Extend arm, locking wrist and elbow.
 - Grip the rear of the slide with the weak hand. Ensure your hand does not cover the ejection port.
 - Pull the slide quickly and completely to the rear. This will extract and eject any cartridge or casing from the chamber.
 - Let any cartridge or casing fall on the shooting bench or range floor and leave it there until you have completed all the steps.
 - Lock the slide to the rear, normally by inserting the slide lock into the slide stop notch, where possible (Figure 117).
3. **O**bserve the chamber to confirm that there is no cartridge or empty casing.
4. **V**erify that the feeding path is clear of ammunition casings or foreign objects. Make certain that the magazine has been removed.
5. **E**xamine the bore for lubricant, rust or other obstructions.

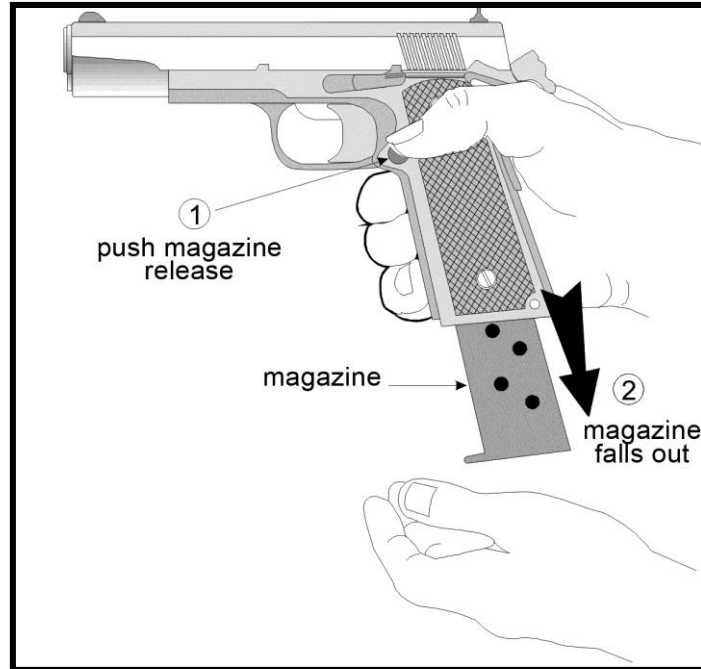

Figure 116. Removing the Magazine from a Semi-automatic

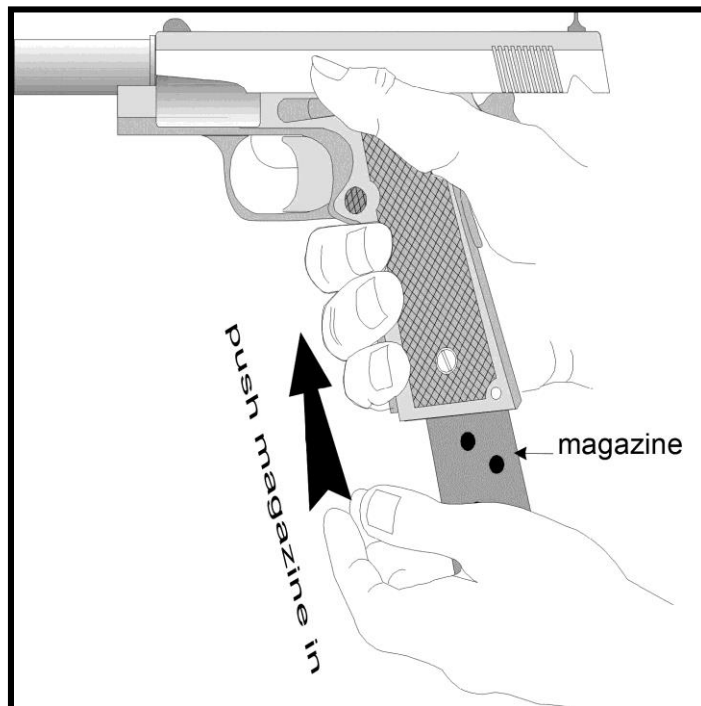

Figure 117. Inserting a Magazine to Load a Semi-automatic

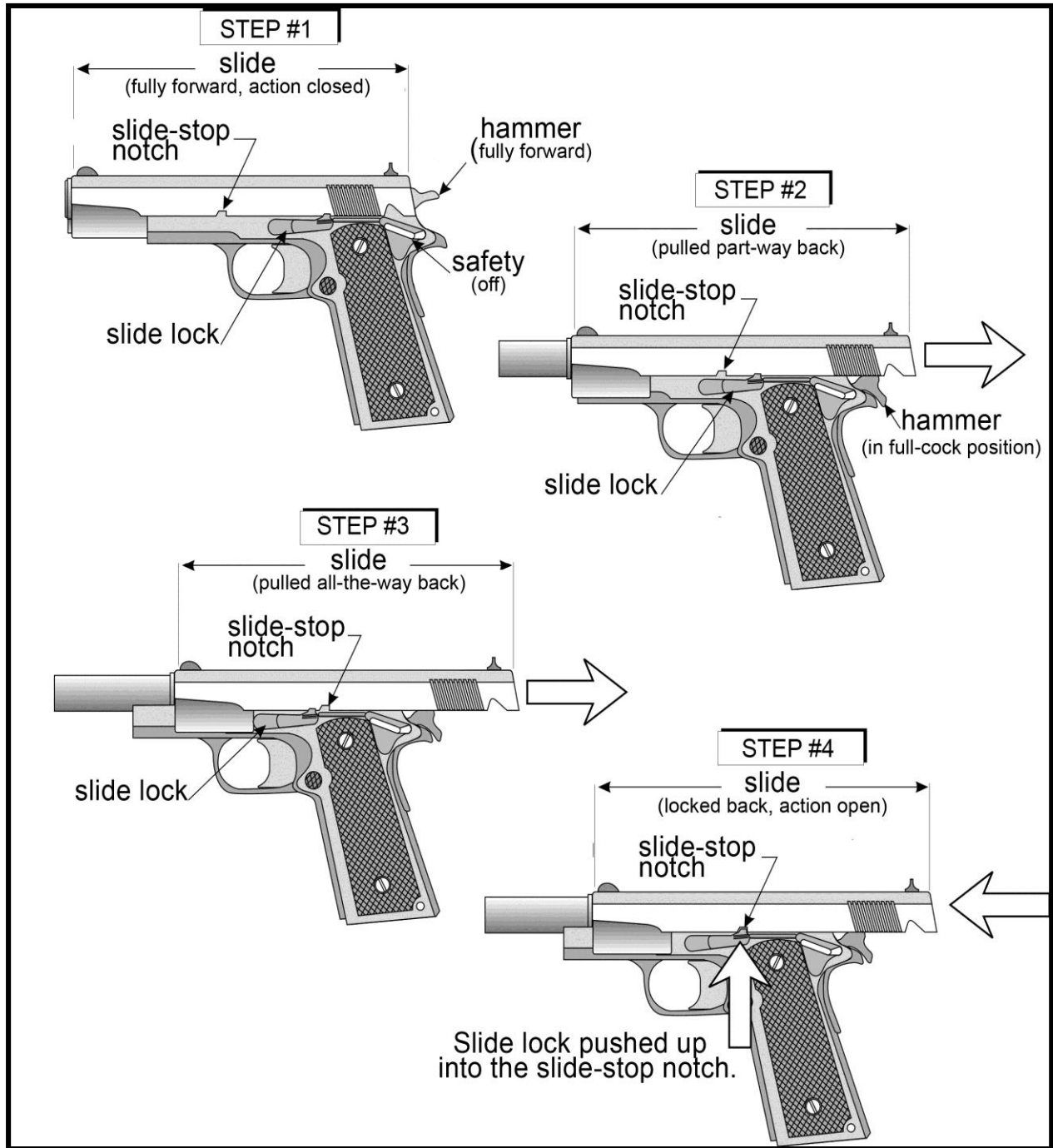

Figure 118. Locking the Slide to the Rear

- a. The firearm is now unloaded and safe until it leaves the direct control of the person who unloaded and completed **ACTS** and **PROVED it safe**.
- b. Depending on the make and model of the firearm, magazine releases are located in different places such as the following:
 - on the grip behind the trigger; or
 - at the bottom of the grip (front or rear).

Consult the owner's manual.



Direct control is defined as having the firearm within eyesight and/or arm's reach of the shooter.

14.8.2. Semi-automatic: single action, double action and double action only loading procedure



Only load a firearm when you intend to use it, and only in an area where it can be safely and legally discharged.

1. Prepare the firearm for loading by going through the complete unloading procedure—**ACTS and PROVE it safe**.
2. Clear any obstructions from the chamber or barrel. Clean if required.
3. Put the safety **ON**, if applicable, if it can be left on during the loading process.
4. Point the firearm in the safest available direction throughout the loading and chambering process.
5. Make sure that nothing touches the trigger throughout this process.
6. Select the correct ammunition by verifying that the data stamp on the firearm matches the head stamp on the cartridge.
7. Put the firearm down with the muzzle pointed in a safe direction and the action open. Charge the magazine by inserting cartridges into it.
8. Load the firearm by inserting the charged magazine into the magazine well with a firm push until it locks into the firearm.
9. To chamber a cartridge:
 - Hold the handgun in the strong hand and point down range. Extend arm, locking wrist and elbow.

- Grip the rear of the slide with the weak hand. Ensure your hand does not cover the ejection port.
 - Pull the slide quickly and completely to the rear and allow the slide to slip through your grip at the end of the stroke. The slide will be pushed forward by the recoil spring, chambering a cartridge.
10. Leave the safety on, if applicable, until ready to fire. In the case of certain double-action semi-automatics, activate the decocking lever.

The firearm is now loaded with a charged magazine and a chambered round, ready for use. It requires continuous attention until it is unloaded.



Always be sure of your target and beyond.

Magazine Capacity Limits

Part 4 of the *Regulations Prescribing Certain Firearms and other Weapons, Components, and Parts of Weapons, Accessories, Cartridge Magazines, Ammunition and Projectiles as Prohibited or Restricted* sets out the limits for the number of cartridges permitted for different types of magazines.

For example, for semi-automatic handguns, the legal magazine capacity maximum is 10 cartridges.
For further information, refer to the Regulations.

Prior to July 1993, owners of large-capacity cartridge magazines that were affected by the limit were able to retain them if they had been properly modified to comply with the law.

14.9. Firearm malfunctions



Generally, when using commercially made ammunition and a properly maintained firearm, malfunctions will not occur. Firearms jammed with a cartridge in the chamber(s) can be hazardous. This hazard, if not dealt with properly, may result in a serious injury. Consult a qualified person or gunsmith for information on how to perform this function in the safest possible manner with your particular firearm.

14.10. Review questions

1. What process is automatic in the semi-automatic handgun?
2. Name the action type of a handgun that only releases the hammer from a cocked position to fire.
3. Name the handgun action that cocks and fires with a single pull of the trigger.
4. Name the safety that requires a magazine in the handgun before it will fire.
5. Name two types of manual safeties used on handguns.



**MODULE 15:
FIRING TECHNIQUES AND PROCEDURES
FOR HANDGUNS**

MODULE 15: FIRING TECHNIQUES AND PROCEDURES FOR HANDGUNS

15.1. Personal safety protection

15.1.0. Overview

Like many active sports, shooting has the potential to cause personal injury. The careful shooter takes steps to avoid these injuries by wearing personal safety protection.

15.1.1. Sight protection

- a. There is a risk of eye injury in shooting without eye protection. This can come from ejected cartridge casings. It can also come from fragments and other debris ejected during firing.
- b. To avoid these hazards, shooters should wear safety glasses made of impact-resistant glass or polycarbonate plastic with side shields (Figure 119). They also guard against firearm malfunctions or bullet fragments.



Figure 119. Sight and Hearing Protection

15.1.2. Hearing protection

- a. Continued unprotected exposure to shooting noise will cause hearing loss. The noise level of a gunshot is similar to that of a jet engine taking off at close range. The need for hearing protection is obvious.
- b. Several types of hearing protection are available. On the firing range, shooters should always wear headphone-type hearing protectors. These protectors provide reasonable sound protection. Earplugs are available in several types. Disposable earplugs are made of foam or wax, but they can only be used once.

- c. There are also reusable earplugs made of rubber available in several sizes. They require care and cleaning after use.
- d. For maximum hearing protection, it is highly recommended that both earplugs and headphone-type hearing protectors be worn.

15.1.3. Slips and falls

- a. Slips and falls may occur when handling firearms. This can best be avoided by using common sense.
- b. If you do fall, remember your first action should be to control the muzzle of the firearm. This will prevent injury from a discharge. The damage from a fall is probably less than the possible damage from an unintentional discharge.
- c. Beware of cumbersome clothing. It can interfere with the safe handling of your firearm.



Occasionally, a hot, ejected cartridge casing may come in contact with unprotected skin. This can cause a shooter to flinch. The sudden movement could result in unsafe muzzle control or discharge. Therefore, button up the collar and sleeves of your shirt or blouse. This way, a hot cartridge casing cannot get inside.

15.2. Introduction to marksmanship

- a. Marksmanship is the ability to hit your mark or target. Good marksmanship is important for safe shooting.
- b. Marksmanship depends on many factors including grip, shooting position, aim, trigger control, controlled breathing and follow-through. These points are discussed in the following pages.

15.3. Shooting positions

15.3.0. Overview

- a. A firm grip gives you complete control of your handgun when it fires. Changing your grip will affect sight alignment and bullet placement on the target.
- b. You can fire handguns either one-handed or two-handed and from several positions. Only the basic standing positions are described below.

15.3.1. The two-handed grip

A similar two-handed grip is used for both revolvers and semi-automatics. Point the muzzle down range with your finger off the trigger and out of the trigger guard, until the sights are on the target. Grip the firearm using about the same pressure as you would to hold a carpenter's hammer.

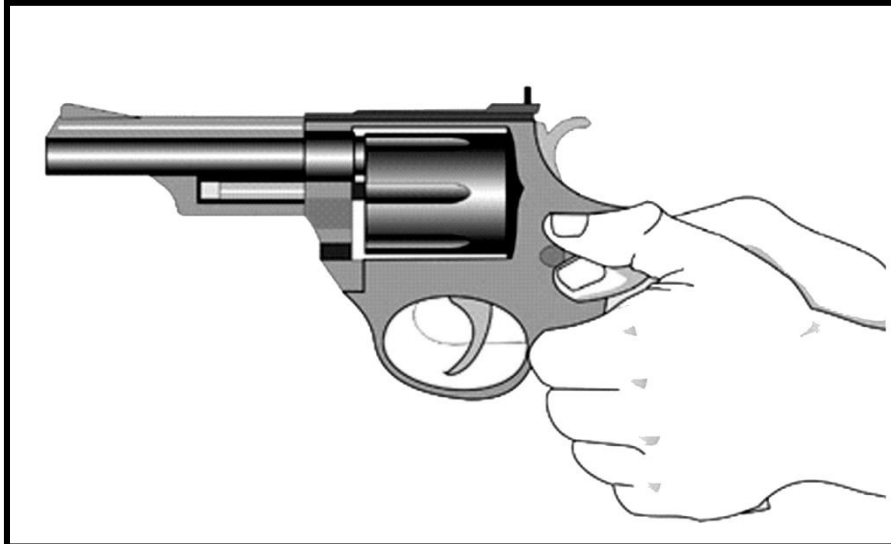

Figure 120. Two-handed Grip for a Revolver



Using an incorrect two-handed grip, the thumb of the weak hand may be behind the slide. While firing a semi-automatic handgun in this manner, your weak hand can be injured by the recoiling slide. When using the two-handed grip, be certain that your thumbs do not contact the slide and are positioned on the weak-hand side of the handgun.

15.3.2. The two-handed stance

- a. Stand with your body facing the target squarely. Spread your feet about shoulder width apart with weight distributed evenly on both feet to give you solid balance. Keep your knees straight but not locked.
- b. Stretch out both arms towards the target and lock your elbows. Keep your head up. Control your breathing.

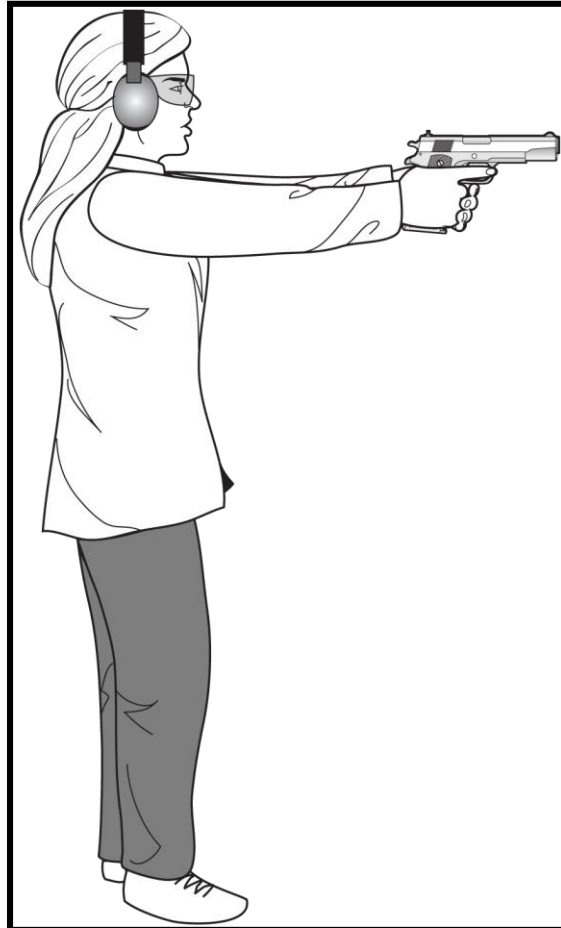

Figure 121. Two-handed Stance

15.3.3. The one-handed grip



Hold the firearm firmly when firing with one hand to avoid losing control.

Point the muzzle in a safe direction with your finger off the trigger. Wrap your fingers around the grip of the firearm with your thumb resting above the tips of your fingers as shown in the diagram. Hold firmly but not too tightly, using about the same pressure as you would to hold a carpenter's hammer.

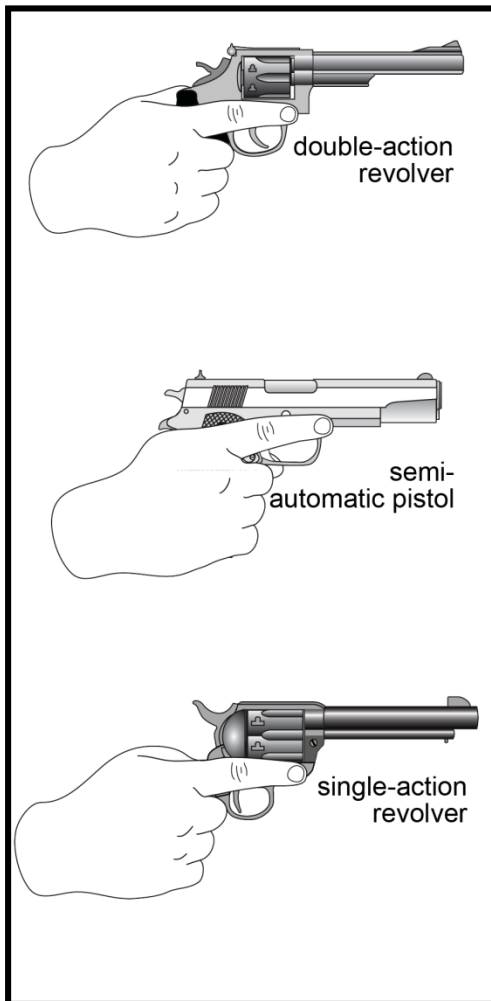

**Figure 122. One-handed Grip
(right side)**

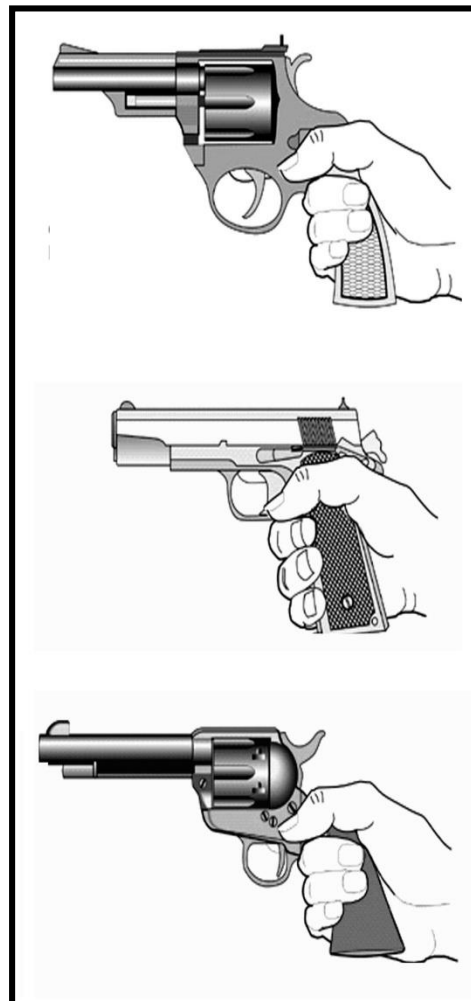

**Figure 123. One-handed Grip
(left side)**

15.3.4. The one-handed stance

- a. Stand with your body turned approximately 45 degrees from the target. Spread your feet about shoulder-width apart with weight distributed evenly on both feet to give you solid balance. Keep your knees straight but not locked.
- b. Keep the muzzle pointed down range and the barrel parallel to the ground. Stretch out your firing arm towards the target. Lock your elbow and wrist. Keep your head up. Control your breathing.
- c. Assume a comfortable position for shooting.

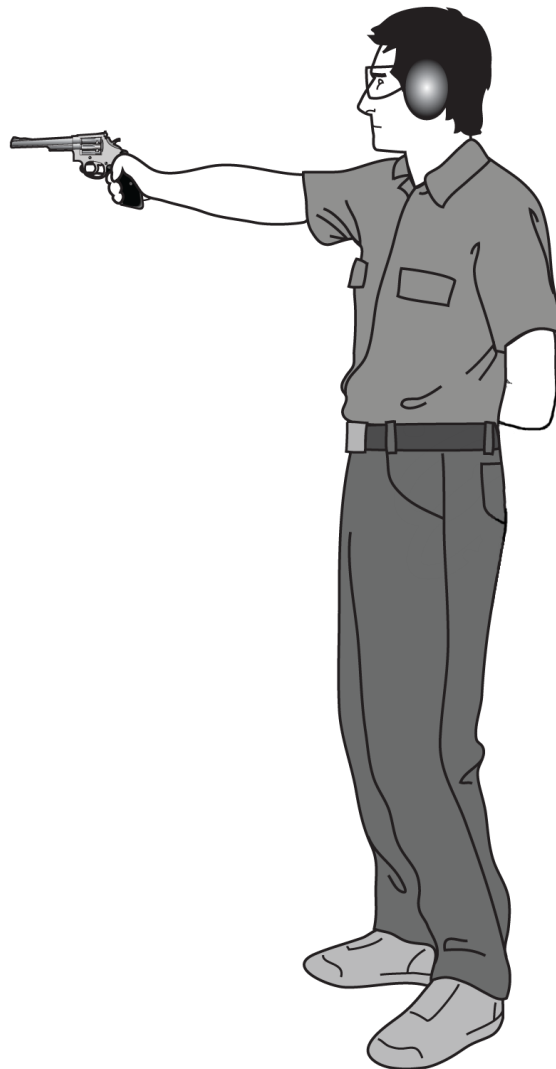

Figure 124. One-handed Stance

15.4. Aiming handguns

A simple technique to use to determine your master eye:



Figure 125. Determining your Master Eye

- a. Use your master eye for sighting. It is the stronger of your two eyes and will focus more accurately.
- b. To find out which is your master eye, create a triangle using both hands as illustrated in the figure above. With both eyes open, view an object in the distance from the centre of the triangle. With both eyes remaining open, and keeping the object within the triangle, close the left eye and then open the left eye. Then, close the right eye and then open the right eye. The master eye will keep the object in the centre of the triangle. Always try to aim with both eyes open as this gives a better view of the area surrounding the target.
- c. You must also learn to correctly use your firearm's sight if your aim is to be accurate. Open sights require you to physically line up both rear and front sights with the target. This process is called sight alignment. When you aim any sight at a target, a sight picture is created (Figure 126).
- d. Scope and electronic sights do not require alignment (Figure 127). Scope sights also might have the advantage of magnifying your view of the target.
- e. When preparing to aim through a scope or electronic red dot sight, do not look away from the target and then try to find the target again by looking through the scope. Instead, while steadily watching the target, raise the handgun correctly to the two-handed stance with arms fully extended. Point the firearm toward the target area until the sight comes up naturally between your eye and the target.

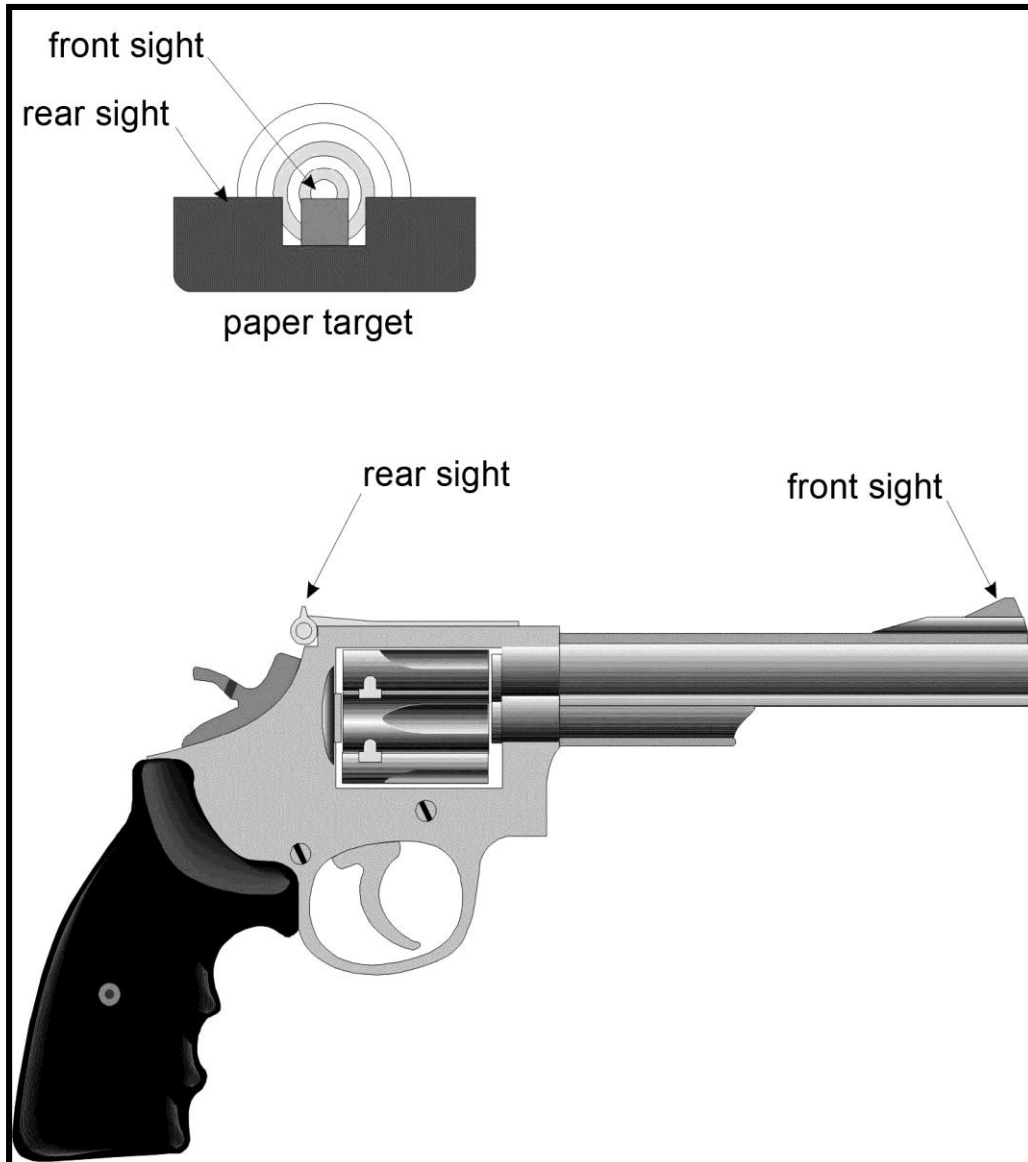

Figure 126. Open Sights Aligned on a Target

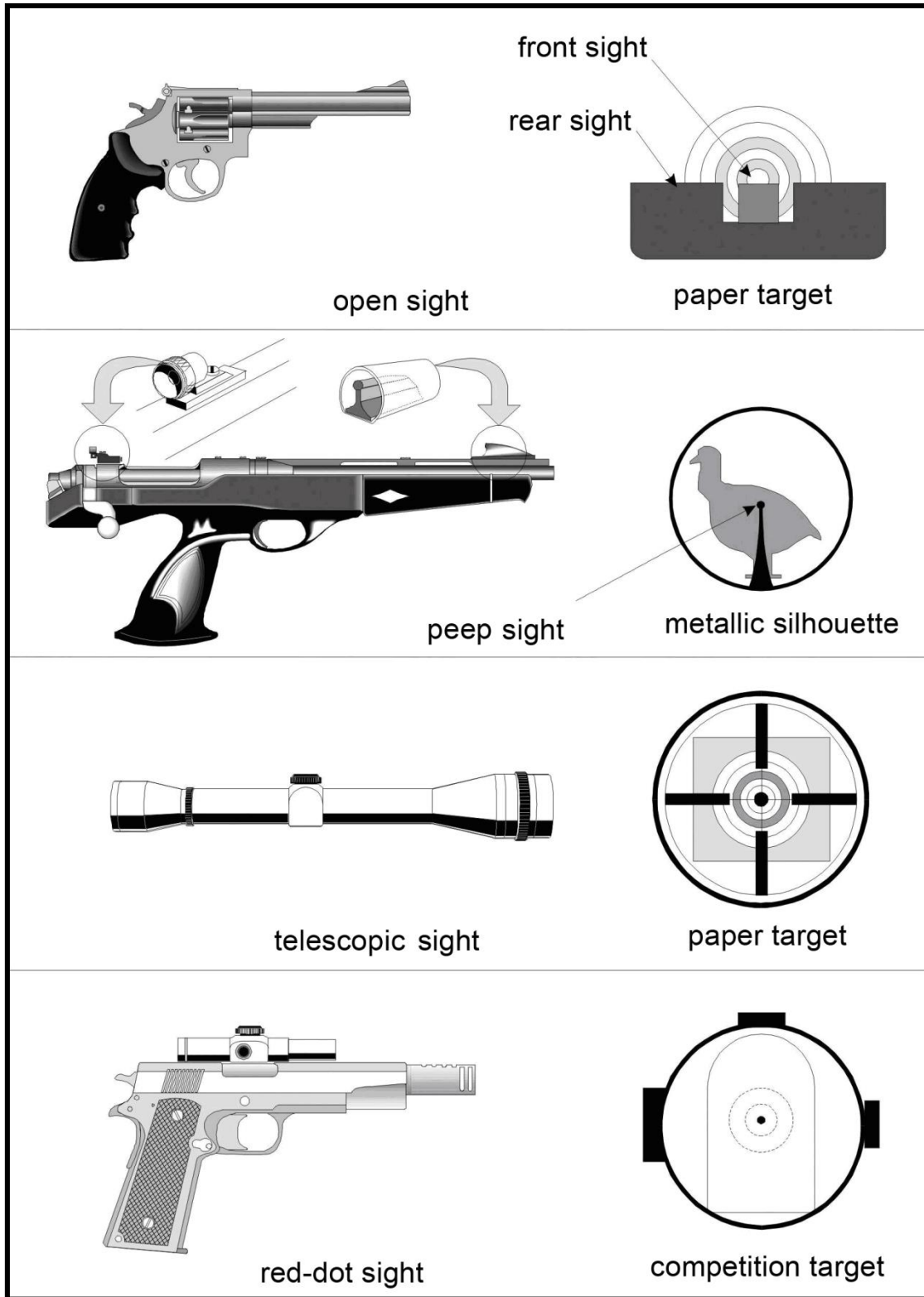
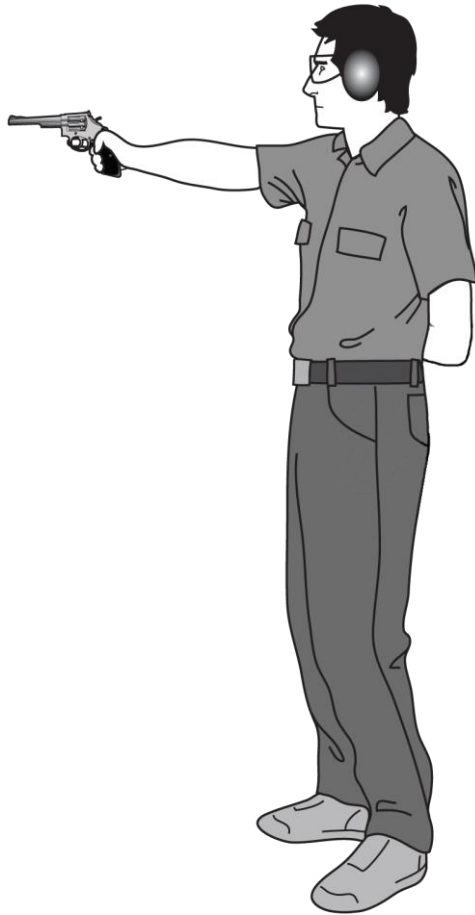

Figure 127. Types of Sights Aligned on Targets

15.5. Review questions

1. When using a revolver with a two-handed grip, is it acceptable to hold your thumbs across each other?
2. When using a semi-automatic handgun with a two-handed grip, why do we hold the thumbs parallel; one over the other and low on the receiver?
3. What is the important consideration to remember regarding your position, when using a one-handed shooting stance?
4. Name two items of personal protective gear you must wear while shooting a handgun.
5. Why should we stand feet shoulder width apart and knees straight but not locked when using the two-handed stance?



MODULE 16:
FUNDAMENTALS OF SHOOTING WITH
RESTRICTED FIREARMS

MODULE 16: FUNDAMENTALS OF SHOOTING WITH RESTRICTED FIREARMS

16.1. Sight alignment / Sight picture

You must learn to correctly use your firearm's sights if your aim is to be accurate. Open sights require you to physically line up both rear and front sights with the target. This process is called sight alignment. When you aim any sight at a target a sight picture is created.

16.2. Breathing as it relates to shot release

- a. Holding one's breath is not natural. It's not possible to judge how much air is held for each shot release, since there is no gauge on the lungs. The shot must be released in the natural pause of the breathing cycle.
- b. We breathe in, we breathe out. There is a natural pause at the bottom of each exhale. It is this natural pause (2.5 seconds) that the shot must be released in. In order to lengthen this natural pause, the shooter has to breathe in deep, force the breath out deeper than normal, breathe in deep again, this time let the breath out normally. The natural pause in the breathing cycle has just been increased to approximately 8.5 seconds. That is plenty of time to confirm sight picture and release the shot, if not, just repeat the process. Breathe in deep, force it out, breathe in deep again, let it out NATURALLY and squeeze the shot off.
- c. Figure 128 has been in circulation for over forty years. Unfortunately, some people will sometimes misinterpret it and wrongfully revert to holding their breath.

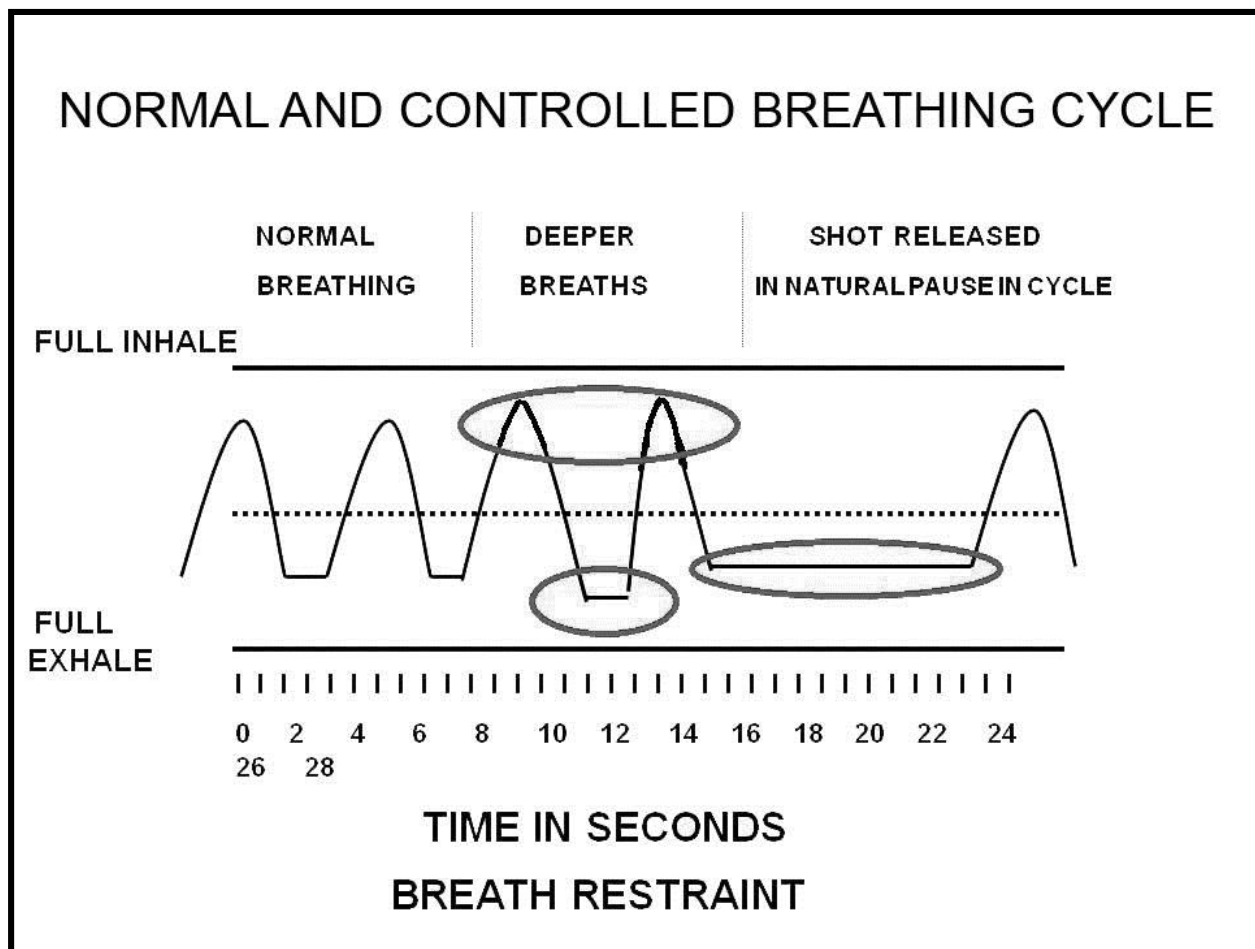

Figure 128. Normal and Controlled Breathing Cycle

16.3. Trigger control

- a. Trigger control is essential for accurate shooting. When the sights are aligned on the target, squeeze the trigger slowly and steadily. Avoid yanking or pulling. Anything other than a smooth squeeze will cause the firearm to move and send the shot off target.
- b. Don't anticipate the shot.

16.4. Follow-through

This means maintaining your sight picture and/or shooting position after discharging the firearm. If you do not follow-through, it is more likely that your shot will be off target.

16.5. Safety procedures at the range

16.5.1. Range commands

The following are examples of typical range commands:

- “The range is active”.
- “Cease-fire”.
- “The range is no longer active”.



Range commands and signals vary between shooting sports, ranges and jurisdictions. Be sure you are aware of and clearly understand the commands and signals used in your area. If you are unsure, ask the Range Officer (RO) or a local official before you go to the range (Appendix G: Visual Range Signals and Devices).

16.5.2. Range safety rules



The Range Officer (RO) is ultimately responsible for the safety of all persons using the range. Commands of the RO must be followed by all shooters at all times.

Every range has rules on safe behavior. These may vary but will normally include the standard ones shown below:

- Use hearing and sight protection.
- The muzzle must always be pointed down range.
- The action of any firearm must be open at all times except when actually shooting.
- Firearms must be handled, loaded and discharged **ONLY** at the firing line.
- No firearm is loaded until the command to load is given by the RO.

- Fingers must be kept out of the trigger guard and off the trigger until the firearm is pointed down range.
- Upon the command “cease-fire,” all firing stops at once. Firearms are unloaded. Actions are opened. Firearms are laid on the mat or on the table. Their muzzles point in a safe direction down range. The shooter steps back from the firing line, behind the cease-fire line.
- The RO will inspect each firearm before allowing anyone to go forward of the firing line. He will verify that all the actions are open and there is no ammunition in the chambers or chargers.
- During a cease-fire, no one will handle firearms or ammunition or return to the firing line. At this point, wait for further range commands before any further activity. Persons not engaged in changing targets down range should stand well behind the cease-fire line (Figure 129).



In an emergency, anyone can call a cease-fire.

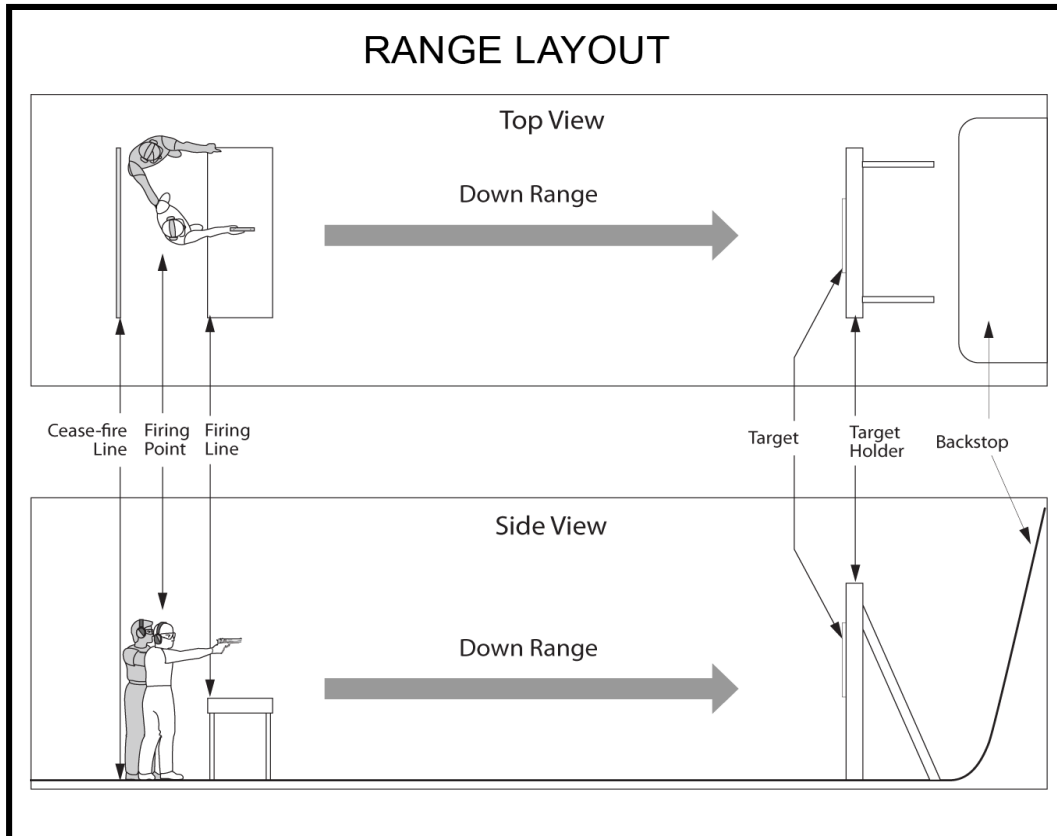

Figure 129. Range Layout with Direct Supervision



Direct control is defined as having the firearm within eyesight and/or arm's reach of the shooter.

There are other rules we recommend you follow:

- Minors and guests who do not have a valid firearms licence must be under direct and immediate supervision while shooting. Consult with your range for any further restrictions.
- Firearms should be checked by the RO on the cease-fire. This is to be sure that all actions are open and no cartridges are in the breech.
- Unloaded firearms not in use are to be placed on the bench or table with the action open or kept in a case. They must be moved with muzzle pointed in the safest available direction or cased at the firing line.
- Horseplay, careless handling of firearms or any other distraction is not allowed while shooting is in progress.

- Make sure you are using the correct ammunition for your firearm and as approved by the range.
- Never shoot at target holders or other range equipment.
- Do not discharge firearms outside of the approved range property or outside range use times.

16.5.3. Range courtesy

There are certain standards of range courtesy and shooters must follow them. Some of these standards are listed below:

- Rules and procedures vary between ranges. Check and obey local rules. There should be a safety briefing before starting.
- Sign in to the firing range upon arrival.
- Avoid interrupting or distracting others when they are shooting.
- Do not smoke on the firing line.
- Ask the owner's or shooter's permission before handling that person's firearm or equipment.
- Leave enough space between you and others to ensure safety.
- If firing particularly smoky firearms, shoot from downwind of other shooters on the firing line. Black-powder firearms are especially smoky.
- Do not fire on other people's targets, targets not directly down range from yourself, or any target that may disturb others.
- Those firing semi-automatic firearms should take a firing point where other people will not be disturbed by ejected casings.
- Rapid firing may disturb those sighting-in or doing deliberate target work.



With the approval of the RO:

- 1. Pick up cartridge casings. Take down targets.**
- 2. Put away any range-owned equipment you have used. For example, sandbags or bench rests.**
- 3. Sign out when you leave the range.**

16.6. Targets

16.6.1. Acceptable targets

Before firing at any target, verify the target by asking yourself the following questions:

- Is the range active?
- Am I sure I am shooting at my target?
- Are the targets approved by the RO?

16.6.2. Unacceptable targets

Below are examples of unacceptable targets:

- any target which, when fired upon, may damage the range. These include signs and main target holder supports;
- someone else's target on the range;
- any target which is not directly in front of your firing point at the firing line;
- any target which, when fired upon, may disturb others. For example, discharging firearms outside of posted range use times;
- any target or a material or shape that can cause ricochets such as target holder frames or concrete walkways; and
- any target made of glass or other material that causes fragment hazards.



The handgun may only be discharged in a place where it is lawful to do so. One such place is a shooting range approved by a CFO. Hunting with a handgun is not permitted.

16.7. Firearm servicing



Ensure that all firearms are unloaded and PROVED safe before attempting to clean. Refer to Module 14 on unloading procedures—ACTS and PROVE it safe.

- a. Always be sure your firearm is functioning properly. A firearm that does not work properly is an unsafe firearm.
- b. This module on minor maintenance and servicing procedures for your firearm is included for general information only. Specific information on cleaning and servicing your firearm is available in your firearm owner's manual, at a gun shop or from a gunsmith. Incidents can occur if these procedures are not performed correctly.
- c. Firearms are precision instruments. Even minor repairs should be made by qualified individuals. Unqualified persons should never try to repair or modify any firearm.
- d. The average user should do basic cleaning and lubrication only.

16.8. Firearm cleaning

16.8.0. Overview

- a. Information on cleaning firearms safely may be obtained from your firearm owner's manual. If you do not have one, contact the manufacturer. Accidents can happen if the cleaning procedure is not performed correctly.
- b. Two major threats to firearm safety are as follows:
 - rust caused by moisture and condensation; and
 - excessive build-up of residue or rust in the firearm.
- c. Either may cause excessive pressure, damaging the barrel. This is why regular cleaning is recommended.
- d. The barrel of a firearm should be cleaned after every use. This will protect its finish. It will also help keep it in good working order. For instructions on cleaning the rest of the firearm, consult your owner's manual.

- e. Modern smokeless primers and powders are non-corrosive. However, some older military surplus ammunition still contains corrosive chemicals. If you use corrosive ammunition, you should clean your firearm immediately after you use it.
- f. Any firearm that has been stored for a long time must be cleaned thoroughly before use. Cleaning before using is required when the firearm has been exposed to moisture or dirt.



If cleaning your firearm requires disassembly, consult your owner's manual. If disassembly is required to clean a firearm, always wear safety glasses. Residue or rust in the chamber or barrel may cause serious pressure build-up. Also, oil may mix with unburned powder and other residue may cause the firearm to jam.

16.8.1. Cleaning materials

- a. To clean a firearm properly, you need the following materials:
 - a cleaning rod and attachments (be sure to use the right size for the firearm), such as a bore brush;
 - tips to hold cloth patches;
 - patches;
 - solvent (also called "bore cleaner");
 - gun oil; and
 - a soft cloth.
- b. If possible, clean your firearm from the breech toward the muzzle. Avoid cleaning from the muzzle toward the breech.
- c. However, you may have to clean some types from the muzzle end. In this case, lock the breech open. This permits the passage of the cleaning rod completely through the barrel. You will find a pull-through cleaning device helpful. Avoid rubbing the cleaning rod on the muzzle. Damage to the crown at the muzzle may occur. It is beneficial to insert a cloth into the open action to collect residue, to prevent dirt from entering the action, and to prevent damage to the firearm.
- d. When cleaning a bolt action, remove the bolt, if possible. Clean the firearm from the breech end. Some firearms are easier to clean if you remove the barrel first.



While cleaning a firearm, remember and follow the Vital Four ACTS. These additional recommended practices for home safety with firearms might prevent accidents:

- **Make sure no ammunition is nearby during cleaning.**
- **Never allow a loaded firearm in any building or living area.**
- **Always give cleaning your firearm your full attention. Never clean a firearm while doing something else, like watching television.**

16.8.2. General cleaning procedures

1. Attach the bore brush to the cleaning rod. Apply bore cleaner to the brush.
2. Run the brush through the bore of the barrel/chamber(s) several times. Be sure that the brush sticks out completely. Then draw it back through the barrel (Figure 130).

NOTE: When cleaning a revolver, always support the cylinder to avoid potential damage.

3. Remove the bore brush from the cleaning rod. Attach a patch-holder tip and a proper size cloth patch. Pour solvent on the cloth patch. Run through the bore of the barrel/chamber(s) several times. Remove the cloth patch from the rod tip.
4. Next, run a clean, dry patch through the bore/chamber(s) several times.
5. If the patch comes out dirty, repeat the first four steps. Do this until a patch finally comes through clean.
6. Next, run a lightly oiled patch through the bore/chamber(s). Use only light gun oil.
7. Wipe the outside of the firearm with a clean cloth and apply a light coat of gun oil or rust preventative to the metal surfaces. You should also maintain the condition of the stock by applying the appropriate wood treatment (consult the owner's manual).
8. Always store your firearm lawfully in accordance with regulations.
9. Remember, before the next firing of the firearm, run a dry patch through the bore and the chamber(s) to remove any oil.
10. Don't forget to clean your magazine.

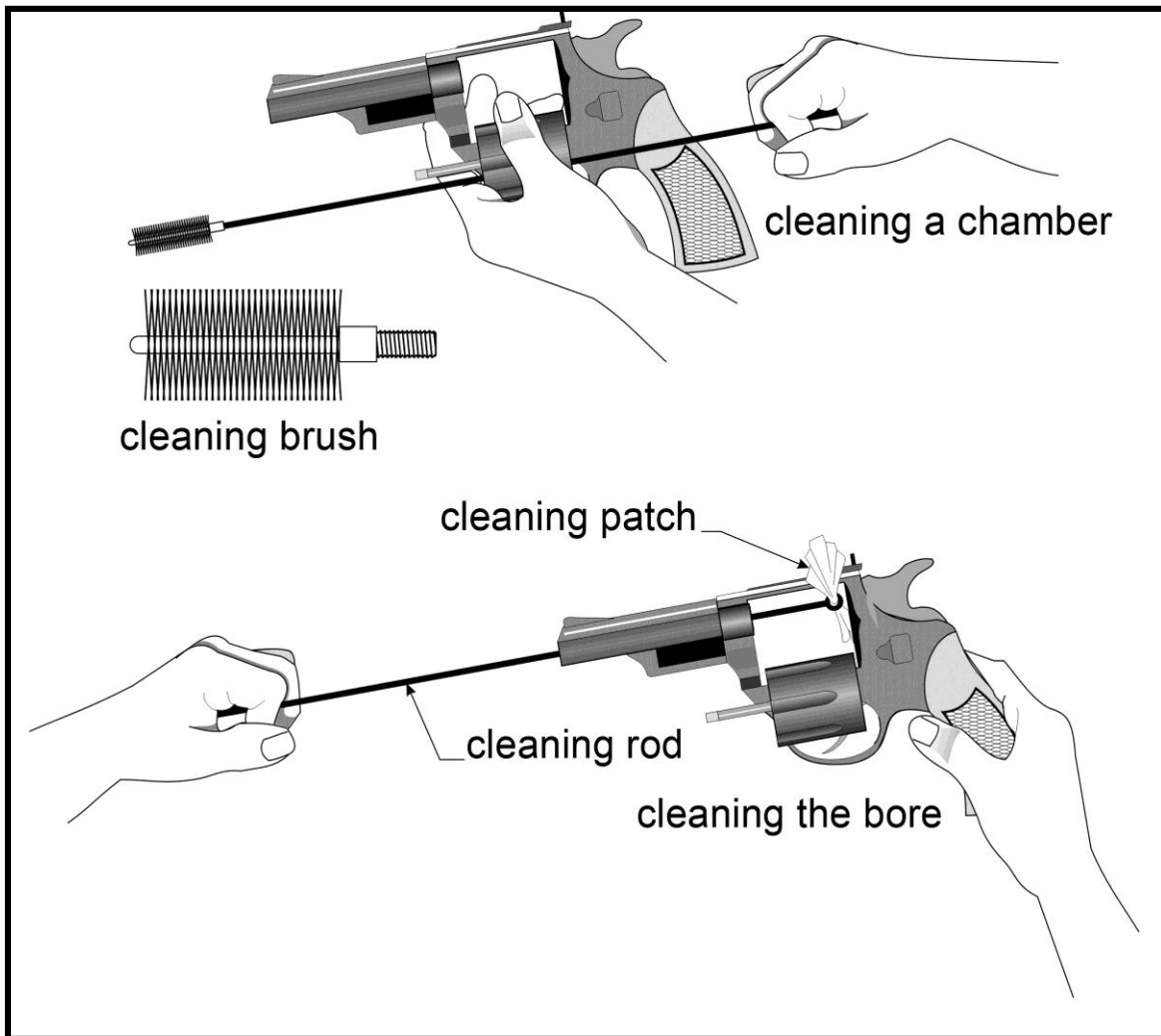

Figure 130. Cleaning a Double-action Revolver Cylinder



After cleaning a firearm for storage, avoid skin contact with metal parts. Acids in perspiration can cause rust.

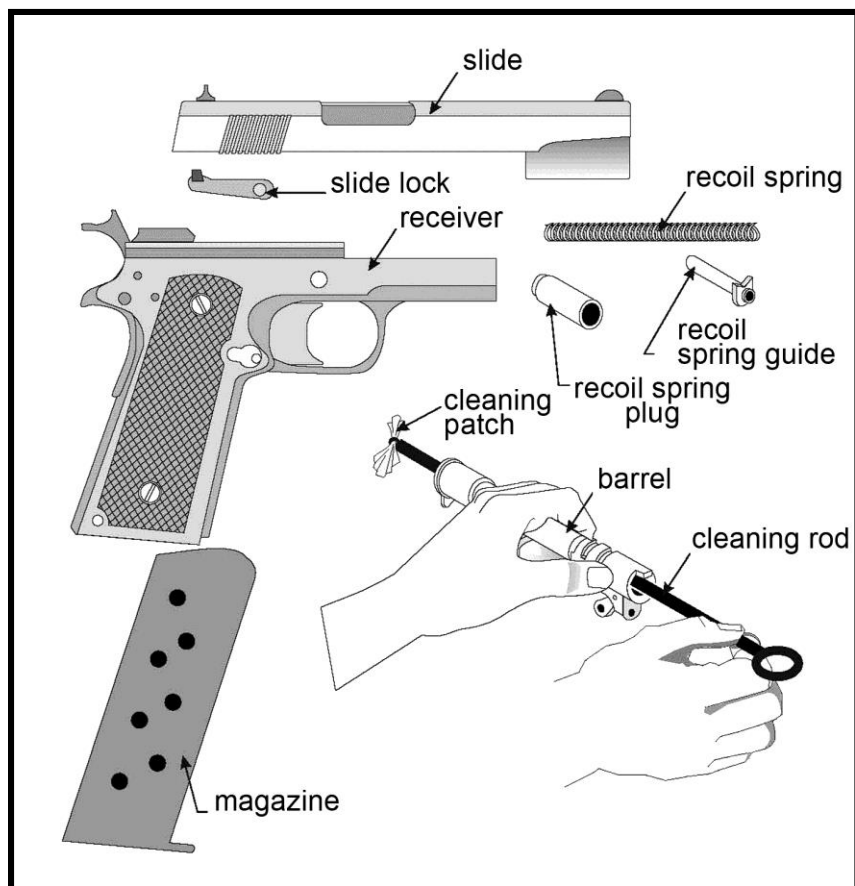

Figure 131. Cleaning a Semi-automatic Handgun

16.8.3. Cleaning ammunition

- a. Ammunition should also be kept clean and dry. Oil, sand or dirt on the cartridge can damage the firearm. It could also cause jamming of the action.
- b. Avoid exposing your ammunition to heat and vibration. Powder can decay and become unpredictable if exposed to excessive heat and long-term vibration.



Primers are adversely affected by exposure to penetrating oils. Do not clean your ammunition with an oily rag. Before using any firearm, remove oil or grease from inside the barrel. Increased pressure caused by dirt or oil may cause the barrel to burst. This comes from the pressure generated in a dirty barrel when a bullet is fired through it. After storage and before you use the firearm again, run a clean patch through the bore. Remove all grease and oil. Always ensure your firearm is in good working order. Ensure that you have followed the Vital Four ACTS in order to PROVE the firearm safe before attempting to clean and throughout the entire cleaning procedure.

16.9. Review questions

1. Name the process of maintaining your sight picture after firing.
2. Should you step to the firing line and reload your handgun after a “cease-fire” is called?
3. Having the firearm within eyesight and/or arm’s reach of the shooter is described as...
4. Is a shooter permitted to shoot cross range at a target not in use by another shooter?
5. Describe the supervision of minors at the range.

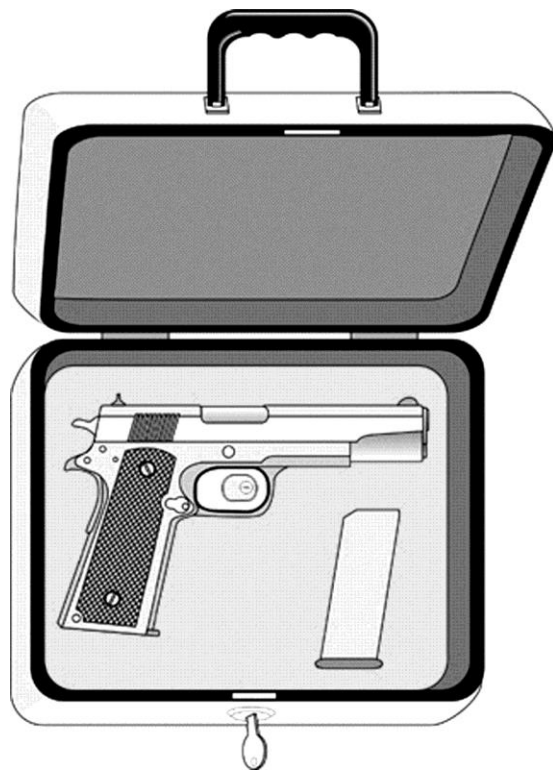

MODULE 17:
SAFE STORAGE, DISPLAY,
TRANSPORTATION AND HANDLING OF
RESTRICTED FIREARMS

MODULE 17: SAFE STORAGE, DISPLAY, TRANSPORTATION AND HANDLING OF RESTRICTED FIREARMS

17.1. Classes of firearms

17.1.0. Overview

Below you will find brief descriptions of each class of firearms. For legal references, however, please refer to the *Firearms Act* and its Regulations, and Part III of the *Criminal Code*.



It must be noted that some rifles and shotguns are considered restricted or prohibited. Persons wishing to acquire such firearms should contact the Provincial or Territorial authorities or call the CFP at 1-800-731-4000.

Restricted Firearms

In general, individuals may possess restricted firearms for one or more of the following reasons: lawful profession or occupation, target practice or competition or as part of a gun collection. The following are examples of restricted firearms:

- A handgun that is not a prohibited firearm;
- A firearm that is not a prohibited firearm, has a barrel less than 470 mm (18½ inches) in length, and discharges centre-fire ammunition in a semi-automatic manner;
- A firearm that is designed or adapted to be fired when reduced to a length of less than 660 mm (26 inches) by folding, telescoping or otherwise; and
- A firearm of any kind that is prescribed by regulation to be a restricted firearm.

Prohibited Firearms

In general, individuals cannot acquire the types of firearms that fall into the prohibited class. Depending on the nature of their duties, employees of business and carriers, and public officers (police or peace officer, firearms officer, prescribed employee of a federal, provincial or municipal government) may possess prohibited firearms. The following are examples of prohibited firearms:

- Handguns with a barrel length equal to or less than 105 mm (4 $\frac{1}{8}$ inches);
- Handguns designed or adapted to discharge a 25 or 32 calibre cartridge (any of the above-noted handguns are not prohibited firearms if they are used in competitions governed by the rules of the *International Shooting Sport Federation* and prescribed by regulation);
- “Sawed-off” rifles or “sawed-off” shotguns less than 660 mm (26 inches) in length;
- “Sawed-off” rifles or “sawed-off” shotguns 660 mm (26 inches) or greater in length and have barrel lengths of less than 457 mm (18 inches);
- An automatic firearm; and
- Any firearm that is prescribed by regulation to be a prohibited firearm.

17.2. Ammunition, prohibited ammunition and prohibited devices

17.2.0. Overview

Ammunition, prohibited ammunition and prohibited devices are defined in the Part III of the *Criminal Code*. The table below provides a brief description of prohibited devices. For a complete description of all of the aforementioned, consult the *Criminal Code* of Canada.

17.2.1. Prohibited devices

Prohibited Devices	
	<ul style="list-style-type: none">• A handgun barrel that is equal to or less than 105 mm (4¹/₈ inches) in length (does not include any handgun barrel that is used in competitions governed by the rules of the <i>International Shooting Sport Federation</i> and prescribed by regulation).• A device designed to muffle or stop the sound of a firearm (silencers).• A cartridge magazine prescribed by regulation to be a prohibited device.



Refer to the appropriate sections of *the Firearms Acts and Regulations* for detailed requirements relating to the storage, display, transportation and handling of restricted firearms.

- a. **Remember, you are responsible for your firearms 24 hours a day.** Anyone who owns or uses a firearm must meet safe storage, display, transportation and handling requirements. These requirements are set out in the *Storage, Display, Transportation and Handling of Firearms by Individuals Regulations*. All of these are described in this module.
- b. Firearm owners and users should always assume that anyone untrained in the safe handling and use of firearms does not know how to handle firearms safely. Incidents could occur from unauthorized access, especially where children are concerned. To prevent a tragedy, always store, display, transport and handle firearms and ammunition in accordance with the Regulations.
- c. Remember the law requires that all restricted firearms can only be loaded and discharged in an approved or legal area.

17.3. Storage

A restricted firearm may be stored, only if it meets the following conditions:

- It is unloaded, and
 - rendered inoperable by using a secure locking device (Figure 132) and stored in a securely locked container (Figure 133), receptacle or room that cannot be easily broken open or into, or
 - stored in a securely locked vault (Figure 134), safe or room (Figure 135) specifically built or adapted for the secure storage of restricted firearms; and
- Not within easy access to ammunition, unless the ammunition is stored, together with or separately from the firearm in:
 - a securely locked container or receptacle that cannot be easily broken open or into, or
 - a securely locked vault, safe or room specifically built or adapted for the secure storage of restricted firearms.

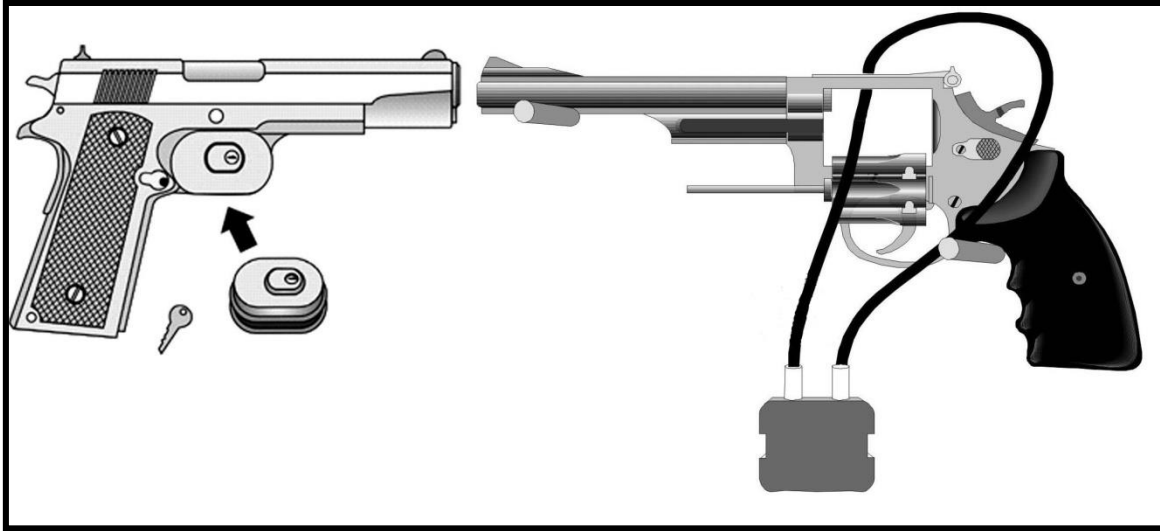

Figure 132. Cable and Trigger Locks



A restricted firearm may only be stored at the address located on the registration. Keep in mind that storing ammunition in an unvented container may create an explosive hazard during a fire.



Figure 133. Lockable Carrying/Storage Case

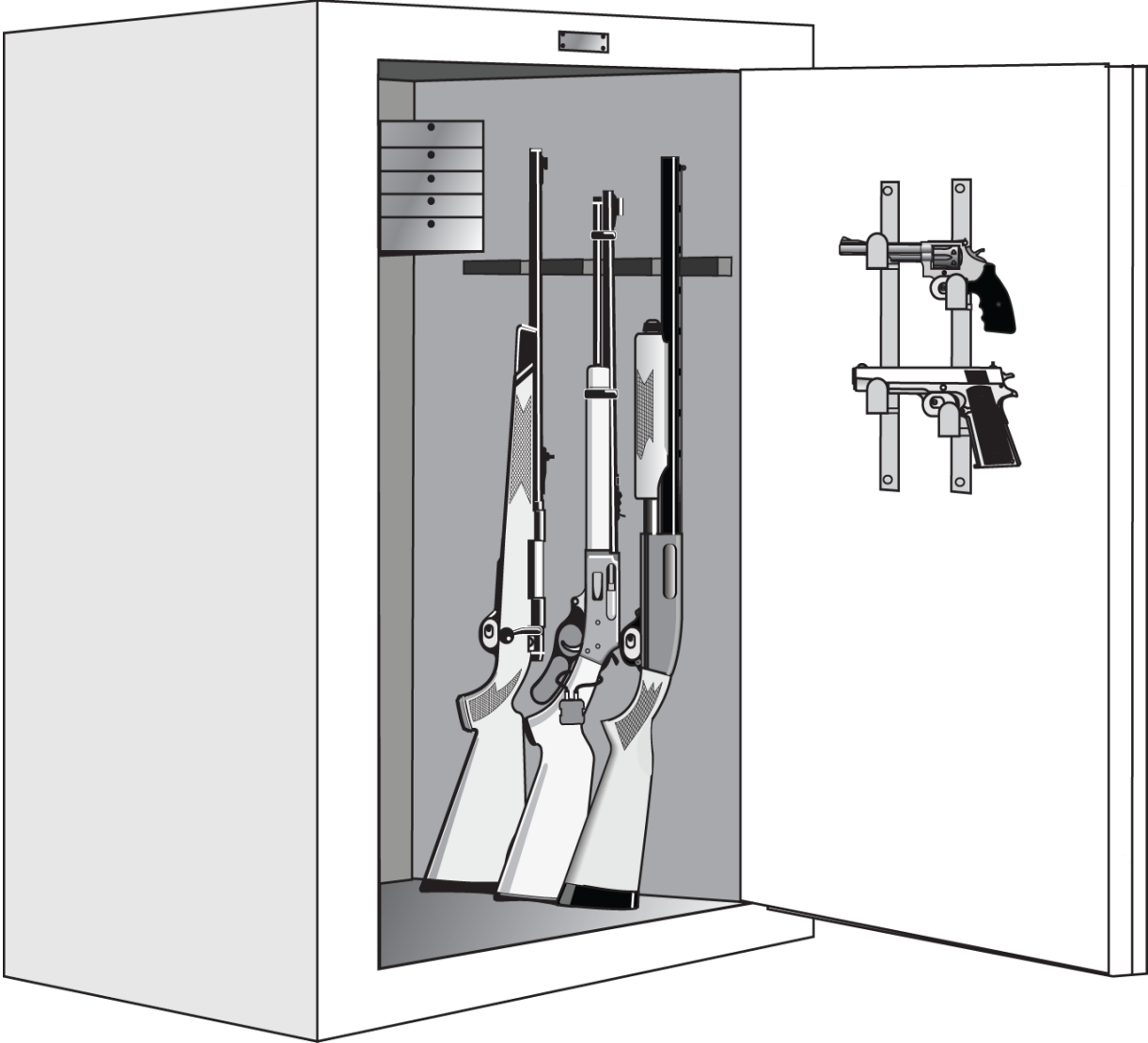

Figure 134. Storage Vault (safe)

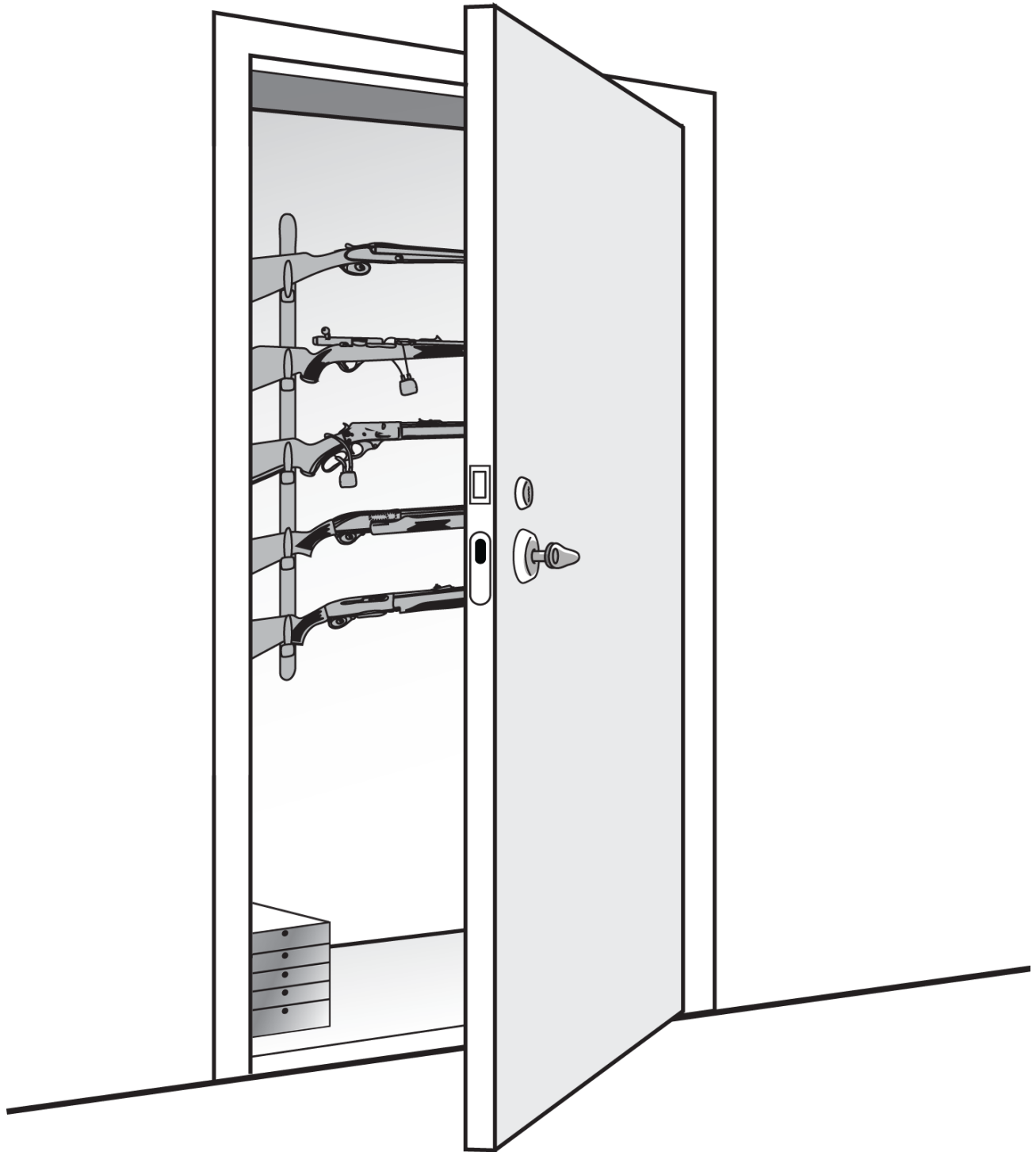

Figure 135. Secure Room (restricted firearms)

17.4. Display

- a. A restricted firearm may be displayed in a dwelling house only under the following conditions:
 - it is unloaded;
 - it is rendered inoperable by using a secure locking device;
 - it is securely attached to a non-portable structure that cannot be easily removed (Figure 136); and
 - it is not displayed with and not within easy access to ammunition that can be discharged from it.

- b. A restricted firearm may be displayed in a place other than at the legal address where the firearm has to be for storage or display only if it meets the following conditions:
 - it is unloaded;
 - it is rendered inoperable by using a secure locking device;
 - it is securely attached to a structure by a chain, metal cable or similar device in a manner that the firearm cannot be easily removed; (a firearm may be removed from the display to allow someone to handle it, if the firearm is under the direct supervision of the person displaying it); and
 - it is not displayed with, and not within easy access to, ammunition that can be discharged from it, unless the ammunition is displayed in a securely locked container or receptacle that cannot be easily broken open or into.

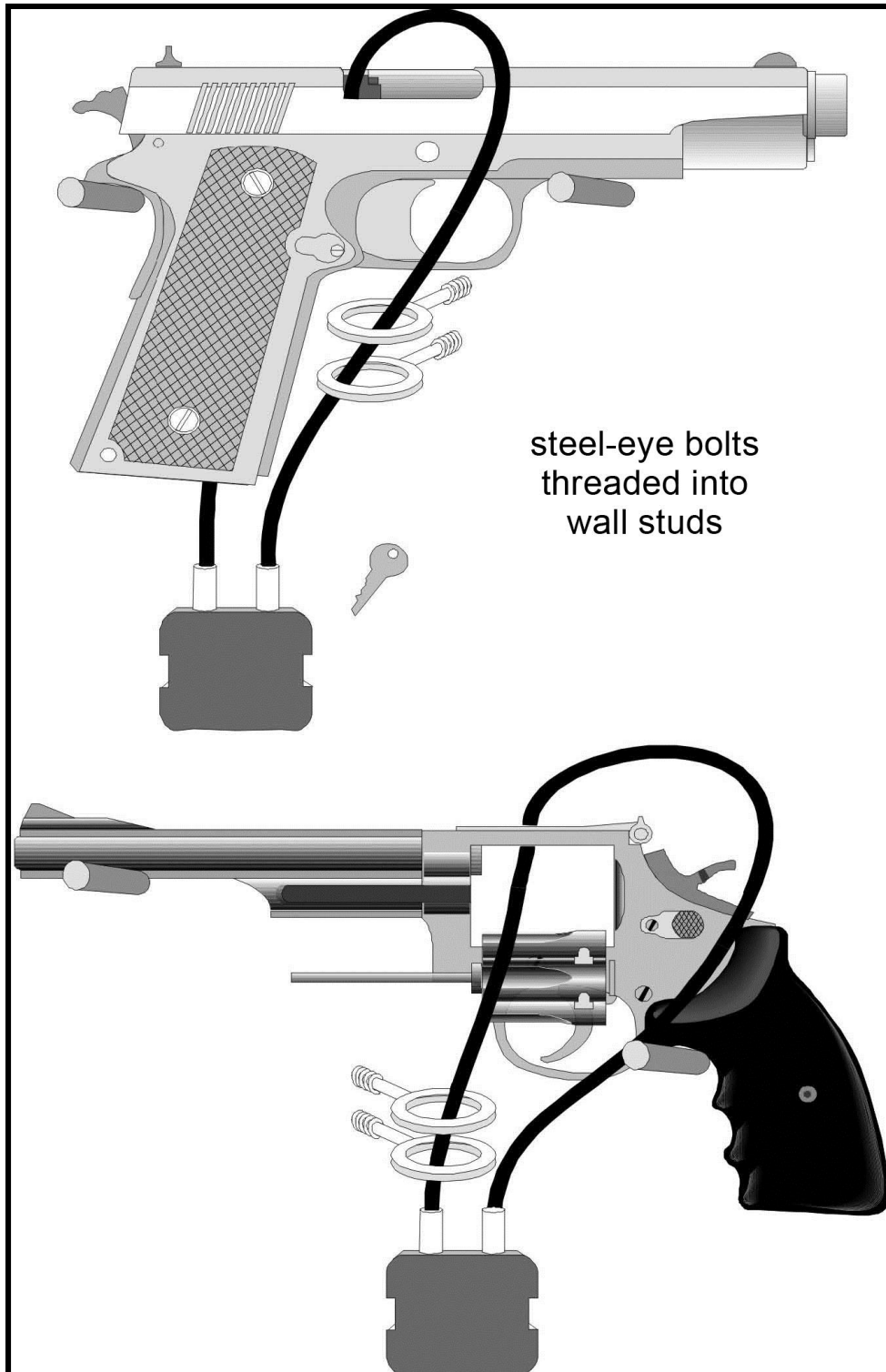

Figure 136. Display

17.5. Transportation

- a. When transporting your restricted firearm between two or more specific places, you will need an “Authorization to Transport.” To obtain an “Authorization to Transport,” you need to contact a CFO or call 1-800-731-4000. You will need to provide the following information: your firearms licence number, the registration certificate number of the firearm(s) to be transported, the frequency, dates and times the firearm(s) will be transported, the place of departure and destination of the transported firearms, and the reason for transporting the firearm(s).



Please note: provincial/territorial policies may also apply.

- b. A restricted firearm may be transported only under the following conditions:
- It is unloaded, and
 - rendered inoperable by using a secure locking device; and
 - in a locked container that is made of an opaque material and cannot be easily broken open or into or accidentally opened during transportation. A heavy-duty soft case (i.e., made of nylon) meets these requirements as long as you can lock it securely.
 - You may leave the locked container (carrying the restricted firearm) in an unattended vehicle’s securely locked trunk or similar compartment.
 - If the unattended vehicle does not have a securely locked trunk or similar compartment, lock the vehicle, or the part of the vehicle that contains the container, and leave the locked container out of sight.



IMPORTANT: Removing the firing pin or any other component of a restricted or prohibited handgun does not meet the requirement for safe transport.

If you want to transport firearms on an aircraft, you should first contact the air carrier. The air carrier will provide information on its regulations and requirements.

17.6. Handling

- a. Before obtaining a restricted firearm, think about how you will transport it home. The law requires that all restricted firearms be transported unloaded and rendered inoperable with a secure locking device. They must also be in a locked opaque case or container (Figure 137).
- b. There are locations where discharging a firearm violates federal or provincial acts and regulations, or municipal bylaws. It may also be an offence to load or handle firearms in these places. You may load a firearm or handle a loaded firearm only in a place where it is lawful to discharge it.



A restricted firearm may only be loaded and discharged in a place where it can be safely and legally discharged.



Figure 137. Lockable Carrying/Storage Case



Every person commits an offence who, without lawful excuse, points a firearm at another person, whether the firearm is loaded or unloaded, and is

1. guilty of an indictable offence and liable imprisonment for a term not exceeding five years; or
2. guilty of an offence punishable on summary conviction (a fine of \$5,000 and/or six months imprisonment).





Reference: Subsections 87(1) and (2) of Part III of the *Criminal Code*





Every person who stores, displays, transports or handles any firearm in a manner contrary to the *Storage, Display, Transportation and Handling of Firearms by Individuals Regulations* is

1. guilty of an indictable offence and liable to imprisonment,
 - in the case of a first offence, for a term not exceeding two years, and
 - in the case of a second or subsequent offence, for a term not exceeding five years; or
2. guilty of an offence punishable on summary conviction (a fine of \$5,000 and/or six months imprisonment).

Reference: Subsections 86(2) and (3) of Part III of the *Criminal Code*

They may also lose their firearm, lose their licence, receive a fine, receive jail time and/or be prohibited from possessing a firearm for a period of time.

The Vital Four ACTS of Firearm Safety	
	<p>Assume every firearm is loaded.</p> <ul style="list-style-type: none">• Regard any firearm as a potential danger.
	<p>Control the muzzle direction at all times.</p> <ul style="list-style-type: none">• Identify the safest available muzzle direction.• Keep the firearm pointed in the safest available direction.• The muzzle of a firearm should not be pointed towards yourself or any other person.
	<p>Trigger finger must be kept off the trigger and out of the trigger guard.</p> <ul style="list-style-type: none">• Do NOT put your finger on the trigger or inside the trigger guard when you pick up a firearm.
	<p>See that the firearm is unloaded—PROVE it safe.</p> <ul style="list-style-type: none">• Do not handle the firearm unless you can properly PROVE it safe.• Check to see that both chamber and magazine are empty. Do this every time you handle a firearm, for any reason.• Pass or accept only open and unloaded firearms. It is an essential rule to adopt.

PROVE it safe	
	P oint the firearm in the safest available direction.
	R emove all ammunition.
	O bserve the chamber.
	V erify the feeding path.
	E xamine the bore for obstructions.

The firearm is now unloaded and safe until it leaves the direct control of the person who unloaded and PROVED it safe.



Direct control is defined as having the firearm within eyesight and/or arm's reach of the shooter. Only load a firearm when you intend to use it, and only in an area where it can be safely and legally discharged.

17.7. Review questions

1. List three reasons permitting you to possess a handgun.
2. Describe the legal parameters of handgun storage.
3. List the documents you must carry when transporting your handgun to the range.
4. Is it legal to store your restricted firearm at your friend's house?
5. List the legal requirements for transporting a restricted handgun.

APPENDICES

APPENDICES

Overview

These appendices are provided for general information purposes only. The information contained in this section may be additional to that contained in the course. Information contained in the Appendix will not form part of the written or practical tests.

For legal references, please refer to the actual legislation, namely the *Firearms Act* and its Regulations, and Part III of the *Criminal Code*.

Appendix A: Antique firearms

An antique firearm refers to any firearm manufactured before 1898 that was not designed or redesigned to discharge rim-fire or centre-fire ammunition, plus any other firearm specifically identified as an antique by the Regulations. Owners of antique firearms do not need to have a firearms licence or a registration certificate. There are also no restrictions on the transfer of antique firearms. However, antique firearm owners must comply with the requirements found in the *Storage, Display, Transportation and Handling of Firearms by Individuals Regulations*.

Source: Section 84, Part III of the *Criminal Code*, Paragraph 117(h), *Firearms Act*

Appendix B: Buying ammunition

Any individual wishing to buy ammunition in Canada must have a valid Canadian firearms licence. (Non-residents must have either a confirmed declaration or a temporary borrowing licence to buy ammunition in Canada.)

Appendix C: Legal definitions

The following definitions are taken from the *Firearms Act* and its Regulations, and Part III of the *Criminal Code*.

ammunition: A cartridge containing a projectile designed to be discharged from a firearm and, without restricting the generality of the foregoing, includes a caseless cartridge and a shot shell. (*munitions*)

antique firearm: (1) Any firearm manufactured before 1898 that was not designed to discharge rim-fire or centre-fire ammunition and that has not been redesigned to discharge such ammunition. (2) Any firearm that is prescribed to be an antique firearm. (*arme à feu historique*)

firearm: A barrelled weapon from which any shot, bullet or other projectile can be discharged and that is capable of causing serious bodily injury or death to a person, and includes any frame or receiver of such a barrelled weapon and anything that can be adapted for use as a firearm. (*arme à feu*)

handgun: A firearm that is designed, altered or intended to be aimed and fired by the action of one hand, whether or not it has been redesigned or subsequently altered to be aimed and fired by the action of both hands. (*arme de poing*)

non-restricted firearm: A firearm that is neither a prohibited firearm nor a restricted firearm. (*arme à feu sans restrictions*)

prohibited ammunition: Ammunition, or a projectile of any kind, that is prescribed to be prohibited ammunition. (*munitions prohibées*)

prohibited device: (1) Any component or part of a weapon, or any accessory for use with a weapon, that is prescribed to be a prohibited device. (2) A handgun barrel that is equal to or less than 105 mm in length, but does not include any such handgun barrel that is prescribed, where the handgun barrel is for use in international sporting competitions governed by the rules of the International Shooting Sport Federation. (3) A device or contrivance designed or intended to muffle or stop the sound or report of a firearm. (4) A cartridge magazine that is prescribed to be a prohibited device. (5) A replica firearm. (*dispositif prohibé*)

prohibited firearm: (1) A handgun that has a barrel equal to or less than 105 mm in length, or is designed or adapted to discharge a 25- or 32-calibre cartridge, but does not include any such handgun that is prescribed, where the handgun is for use in international sporting competitions governed by the rules of the International Shooting Sport Federation. (2) A firearm that is adapted from a rifle or shotgun, whether by sawing, cutting or any other alteration, and that, as so adapted, is less than 660 mm in length, or is 660 mm or greater in length and has a barrel less than 457 mm in length. (3) An automatic firearm, whether or not it has been altered to discharge only one projectile with one pressure of the trigger. (5) Any firearm that is prescribed to be a prohibited firearm. (*arme à feu prohibée*)

replica firearm: Any device that is designed or intended to exactly resemble, or to resemble with near precision, a firearm, and that itself is not a firearm, but does not

include any such device that is designed or intended to exactly resemble, or to resemble with near precision, an antique firearm. (*réplique*)

restricted firearm: (1) A handgun that is not a prohibited firearm. (2) A firearm that is not a prohibited firearm, has a barrel less than 470 mm in length, and is capable of discharging centre-fire ammunition in a semi-automatic manner. (3) A firearm that is designed or adapted to be fired when reduced to a length of less than 660 mm by folding, telescoping or otherwise. (4) A firearm of any other kind that is prescribed to be a restricted firearm. (*arme à feu à autorisation restreinte*)

secure locking device: A device that can only be opened or released by the use of an electronic, magnetic or mechanical key or by setting the device in accordance with an alphabetical or numerical combination; and that, when applied to a firearm, prevents the firearm from being discharged. (*dispositif de verrouillage sécuritaire*)

unattended: In respect of a vehicle, means that the vehicle is not under the direct and immediate supervision of a person who is 18 years of age or older or to whom a licence has been issued under the Act. (*non surveillé*)

unloaded: In respect of a firearm, means that any propellant, projectile or cartridge that can be discharged from the firearm is not contained in the breech or firing chamber of the firearm nor in the cartridge magazine attached to or inserted into the firearm. (*non chargée*)

vehicle: Any conveyance that is used for transportation by water, land or air. (*véhicule*)

Appendix D: Personal firearms inventory (example)

MAKE:

MODEL:

SERIAL NO:

FIREARM IDENTIFICATION NUMBER:

MANUFACTURER:

BARREL LENGTH:

CALIBRE / GAUGE:

REGISTRATION CERTIFICATE NUMBER:

PURCHASED FROM:

DATE OF PURCHASE:

VALUE:

DISTINGUISHING MARKS:

ACCESSORIES (case, grips, etc.):

Appendix E: Replica firearms

A replica firearm is designed or intended to exactly, or almost exactly, resemble a firearm, but itself is not a firearm. Under Part III of the *Criminal Code*, a replica firearm is a prohibited device. Owners of replica firearms do not need to have a firearms licence or a registration certificate. However, replica firearm owners must comply with the transportation requirements found in the *Storage, Display, Transportation and Handling of Firearms by Individuals Regulations*.

Source: Section 84, Part III of the *Criminal Code*, Paragraph 117(i), *Firearms Act*

Appendix F: Reporting lost or stolen firearms, licences, etc.

Where a firearm or other weapon is lost or stolen, or a licence, registration certificate or authorization is lost or stolen—it must be reported.

A person commits an offence if after having lost a firearm, a prohibited weapon, a restricted weapon, a prohibited device, any prohibited ammunition, an authorization, a licence or a registration certificate, or having had it stolen, does not report the loss or theft with reasonable dispatch to a peace officer, firearms officer, or Chief Firearms Officer (CFO).

Similarly, a person commits an offence, if on finding a firearm, a prohibited weapon, a restricted weapon, a prohibited device, or any prohibited ammunition, does not report the find, or deliver the item with reasonable dispatch to a peace officer, firearms officer, or CFO. This offence does not extend to documents, specifically an authorization, a licence or a registration certificate.

Commission of either offence is punishable on summary conviction or by indictment.

Source: Section 105, Part III of the *Criminal Code*

Appendix G: Visual range signals and devices

Flags or Signs: Typically a red flag flown at or near the entrance to the property. It serves to warn people that live fire may occur at any time and that shooters are actively using one or more ranges. Some clubs have individual "in use" flags for each range.

Down Range Activity Signals: Typically a red light, rope, or red flag at the entrance to the down range area. Red means stop! Do not go down range. A few clubs use a green flag or light to indicate it is safe to go down range. This display should NOT be visible from the shooting positions! Some ranges fly "down range" red flags to show it is NOT safe to discharge firearms; this is potentially confusing unless the flag cannot be seen by people in the down range area.

Shooting Line Activity Signals: Typically a red light, a red flashing light, a red flag, or a baffle clearly visible to the shooter when in the shooting position. Red means stop shooting! On some indoor ranges, the white lights that illuminate the firing line are dimmed and red illumination supplied. This display should NOT be positioned or used in a manner to be confused with the red signal at the entry to the down range area. Some ranges fly "down range" green flags to show that the range is safe for live fire; this is potentially confusing unless the flag cannot be seen by people in the down range area.

Appendix H: Gun collector

The *Firearms Act* recognizes that collecting firearms is a legitimate reason for owning firearms. The rules on gun collecting apply to restricted firearms and to "grandfathered" prohibited handguns with barrel lengths of 105 mm or less, or 25 and 32 calibre. In order to collect grandfathered handguns, an individual must have registered one such handgun as of December 1, 1998, and then continuously thereafter maintained a registration for one such handgun. In order to qualify as a gun collector, a person must:

- have knowledge of the historical, technical or scientific characteristics of the firearms that are part of a collection;
- give signed consent to periodic inspections of the area where the collection is stored; and
- comply with safe storage, display, handling and transportation standards.

When a person acquires a restricted firearm or prohibited handgun, or when he or she renews their firearms licence, the Chief Firearms Officer must determine whether the firearm is being acquired, or firearms already in possession are for the purpose of gun collection.

Source: Sections 67, 28 and 30, *Firearms Act*

Appendix I: Firearms licences

Under the *Firearms Act*, anyone wishing to possess, borrow, buy, inherit or otherwise acquire firearms must have a valid firearms licence.

The *Firearms Act* and *Firearms Licences Regulations* set out the following types of individual firearms licences:

- Possession and Acquisition Licence (PAL);
- Minor's Possession licence;
- Non-resident Sixty-day Possession Licence (Borrowed Firearms); and
- Non-resident Firearm Declaration (Confirmation of Importation of a Firearm by a Non-resident).

Requirements for obtaining firearms licences are the same across Canada.

Possession and Acquisition Licence

This type of licence is required for anyone wishing to acquire firearms, whether for the first time or in addition to the firearms already owned. An individual must successfully complete the Canadian Firearms Safety Course and tests to obtain the licence for non-restricted firearms. To obtain the licence for restricted firearms and/or prohibited firearms an individual must also successfully complete the Canadian Restricted Firearms Safety Course and tests. There is a minimum 28-day waiting period for this licence, unless the applicant already holds a valid PAL or Minor's Possession licence.

Appendix J: Transferring restricted firearms

Sections 22 and 23 of the *Firearms Act* set out a number of conditions that must be satisfied by both parties involved in the transfer of a restricted firearm before the transfer is authorized. In addition, there are a number of conditions that apply in the ***Conditions of Transferring Firearms and Other Weapons Regulations***.

The following outlines the information that must be provided when individuals transfer (sell, barter, or give away) firearms.

Transferor's Obligations

An individual who wants to transfer a firearm must:

- be reasonably sure that the transferee does not have a mental illness which would give rise to public safety concerns;
- be reasonably sure that the transferee is not impaired by alcohol or drugs;
- require the transferee to show a valid licence which authorizes the transferee to acquire and possess the particular class of firearm;
- be satisfied that the licence shown authorizes the transferee to acquire and possess the particular class of firearm;
- inform a Chief Firearms Officer (CFO) of the transfer and obtain his or her authorization; and
- ensure that the following conditions (subsection 2(1) of the *Conditions of Transferring Firearms and Other Weapons Regulations*) are complied with:
 - provide the CFO with the transferor's and transferee's name and address;
 - provide the CFO with the transferor's and transferee's licence numbers; and
 - provide the registration certificate number of the firearm being transferred to the CFO.

Transferee's Obligations

In order for a transfer to be authorized, the individual to whom the firearms will be transferred must:

- hold a valid Possession and Acquisition Licence for the particular class of firearm;
- ensure that a new registration certificate is issued by the Registrar;

- for the transfer of restricted firearms and prohibited handguns (pre-December 1, 1998) only,
 - inform the CFO why he or she needs to acquire the firearms (lawful profession or occupation, target practice or competition, or part of a gun collection); and
 - if the transferee is acquiring the firearm to form part of a gun collection, he or she will have to provide the CFO with:
 - information regarding his or her knowledge of characteristics which relate or distinguish the restricted firearms or handguns that he or she possesses;
 - signed consent to reasonably conducted periodic inspections of the area where the collection is kept; and
 - details of his or her knowledge of safe storage requirements for restricted firearms or prohibited handguns;
- for the transfer of restricted and prohibited firearms only, provide the CFO with the number of the registration certificate issued to him or her.

Before authorizing a transfer, the CFO must determine whether or not the transfer will affect the safety of others. If the transfer is authorized, the CFO will issue a unique transfer authorization number to both parties. Where transfers are completed by telephone, the transfer number provided to both parties will serve as a confirmation of the transfer and as a temporary registration certificate until a new registration certificate is sent in the mail.

Annex K: Transferring a non-restricted firearm

On April 5, 2012, Bill C-19, ending the *Long-Gun Registry Act*, came into effect ending the requirement for a transferor of a non-restricted firearm to wait for confirmation of the Transfer approval prior to releasing the non-restricted firearm to the transferee. The transferor must be satisfied that the transferee is a holder of a valid Possession and Acquisition Licence, with the proper privileges of acquisition, before transfer is finalized.

Sections 22 and 23 of the *Firearms Act* set out a number of conditions that must be satisfied by both parties involved in the transfer of a non-restricted firearm before the transfer is authorized. In addition, there are a number of conditions that apply in the ***Conditions of Transferring Firearms and Other Weapons Regulations***.

The following outlines the information that must be provided when individuals transfer (sell, barter, or give away) firearms.

Transferor's Obligations

An individual who wants to transfer a firearm must:

- be reasonably sure that the transferee does not have a mental illness which would give rise to public safety concerns;
- be reasonably sure that the transferee is not impaired by alcohol or drugs; and
- require the transferee to show a valid licence which authorizes the transferee to acquire and possess the particular class of firearm;

Transferee's Obligations

In order for a transfer to be authorized, the individual to whom the firearms will be transferred must:

- hold a valid Possession and Acquisition Licence for the particular class of firearm.

GLOSSARY

GLOSSARY

A

action: The moving parts of a firearm that load, fire, extract and eject ammunition.

action release: The part of a firearm that unlatches or opens the action to give access to the chamber.

air gun: A firearm that uses compressed air or carbon dioxide to propel a projectile.

ammunition: See under [Appendix C: Legal Definitions](#).

antique firearm: See under [Appendix C: Legal Definitions](#).

aperture sight: A rear sight with a hole for viewing the target. Also known as a peep sight.

automatic: An action that fires cartridges in rapid succession during one sustained pressure of the trigger.

B

ball:

- a) A lead projectile fired by black-powder firearms.
- b) Full-metal jacket ammunition.

ballistics: The study of projectiles in flight and what affects them. This means the barrel, in flight and within the target, including trajectory, force, impact and penetration.

barrel: The metal tube of a firearm. The bullet, shot or projectile accelerates down it when the firearm is fired.

barrel length: The distance from the muzzle to the chamber, including the chamber itself. This measurement does not include accessories or barrel extensions like flash suppressors or muzzle brakes. The barrel length of a revolver is the distance from the muzzle to the breech end immediately in front of the cylinder.

BB gun: A type of air gun designed to use spherical steel BB pellets.

big bore: A rifle shooting term that refers to centre-fire firearms or ammunition.

black powder: A finely ground powder, mainly used in muzzleloaders and antique cartridge firearms. The basic ingredients are saltpetre (potassium nitrate), charcoal (carbon) and sulphur.

blueing or bluing: An oxidation (rust) process applied to firearm metal parts. Controlled by applying oil that mixes with the nitrates used in the process. The oil prevents further rusting by sealing the metal. This gives the metal a blue/black colour that resulted in the name "bluing."

boat tail: The tapered rear end of some bullets, used to increase ballistic efficiency at long range.

bolt: A steel rod-like assembly that moves back and forth in an action, sealing the cartridge in the chamber during firing.

bolt action: A repeating firearm that has a magazine and in which the breech bolt or closure device operates in line with the bore; manually operated by a permanent projection or handle attached to the bolt or closure device.

bolt face: The forward end of the bolt that supports the base of the cartridge.

bore: The inside of the barrel of a firearm excluding the chamber. The channel through which the bullet or other projectile is fired from the gun.

bore diameter: The measurement from one side of the bore to the other. See also **rifling**; **calibre**.

breech: The rear end of the barrel into which the ammunition is loaded. See also **chamber**.

breechblock: The part in the breech mechanism that locks the action against the firing of the cartridge.

breechloader: A firearm loaded through the breech.

buckshot: Large lead pellets used in shotgun shells.

bullet: A projectile designed to be fired from a rifled barrel.

butt: The rear end of a rifle or shotgun (the portion that rests against the shoulder). In a handgun, the bottom part of the grip.

buttstock: In long guns, the part of the stock which extends from the receiver to the butt.

C

calibre: A measurement in metric or imperial units to describe the inside diameter of the barrel of a rifled firearm. Calibre is also used to describe the diameter of a projectile in a cartridge.

cap: See **percussion cap**.

carbine: A light short-barrelled rifle.

cartridge: A complete unit of ammunition consisting of a case, primer, powder and a projectile. Modern cartridges are generally classified into two categories: centre-fire and rim-fire. See also **shell**.

cartridge magazine: A device or container from which ammunition may be fed into the firing chamber of a firearm. Part 4 of the *Regulations Prescribing Certain Firearms and other Weapons, Components, and Parts of Weapons, Accessories, Cartridge Magazines, Ammunition and Projectiles as Prohibited or Restricted* sets out the limit for the number of cartridges permitted for different types of magazines. The two common types are box-type magazine and tubular magazine.

case: Also called casing. The container of a cartridge. It is usually of brass or other metal when used for rifles and handguns. When used for shotguns, it is usually of paper or plastic with a metal head, and is more often called a hull.

cease-fire:

- a) As a verb - The command to stop shooting, unload firearms and step behind the cease-fire line.
- b) As a noun - Time or period of range inactivity while targets are changed or other activities are conducted.

centre-fire: A cartridge with its primer located in the centre of the base of the case.

chainfiring: The term used to describe the dangerous result of not using grease over the balls used in a black-powder revolver. When the primary cylinder is fired, lack of grease on the other cylinders may cause them to discharge before they are lined up with the barrel.

chamber:

- a) The portion at the breech end of the barrel. The cartridge is placed in the chamber ready for firing. A revolver is multi-chambered.
- b) To place a cartridge in the barrel.

charge:

- a) The amount, by weight, of the powder in a cartridge.
- b) In the case of black powder, the amount, by volume, of the powder used.
- c) To fill a magazine with cartridges.

Chief Firearms Officer: The person in authority in a province or territory responsible for licences, authorizations to transport, authorizations to carry and other functions related to the administration of the *Firearms Act* and its Regulations.

choke: Narrowing at the muzzle end of a shotgun barrel that determines the shot pattern.

cleaning kit: A set of specialized accessories used to clean and maintain a firearm.

clip: An informal term used to describe a magazine.

cock: To set the action into position for firing. On some firearms, the action has an intermediate position called half cock. On muzzleloading firearms, the cock holds the flint or match.

coking: The burning of black powder residue with much heat and little smoke.

comb: The upper edge of a rifle or shotgun stock where the holder's cheek rests.

conical bullet: A cylindrical-shaped bullet with a cone-shaped tip.

core: The part of a bullet that is covered by a jacket, i.e., the centre of a bullet.

corrosion: The gradual eating away of the metal parts of a firearm caused by rust or other chemical reactions.

crimp: The portion of a cartridge or shell case that is bent inward to hold the bullet or shot in place.

cross-bolt safety: A device that blocks the firing mechanism of a firearm.

cross-hairs: The sighting lines in a telescopic sight.

cylinder: The part of a revolver that rotates and in which chambers are bored to hold cartridges. It combines the functions of magazine, feed system and firing chamber.

cylinder bore: A shotgun barrel having the same diameter throughout, i.e., without choke. It is used to fire solid slugs.

D

dangerous range: The maximum distance at which a projectile will travel. See also **range**.

deactivated firearm: A deactivated firearm is one that has been rendered permanently inoperable. The standards for deactivated firearms are determined by the RCMP/CFP.

direct control: Defined as having the firearm within eyesight and/or arm's reach of the shooter.

dominant eye: See **master eye**.

double action: An action that cocks and fires with a complete pull of the trigger.

double action only: An action that cannot fire in a single action mode.

double-action revolver: A revolver that both cocks and fires with a complete pull of the trigger.

double-barrel: A firearm with two barrels, either side-by-side or one over the other.

down range: The direction from the shooting position towards the target on a range. See also **range**.

dry firing: Firing of an unloaded firearm to practise handling and shooting techniques. This can damage some types of actions, particularly rim-fire.

dummy ammunition: Inactive ammunition used for practising handling of firearms. It has no primers or propellants. See also **live ammunition**.

E

effective range: The maximum distance for a shooter at which he or she can confidently hit the target. Also refers to the useful range of the projectile(s). See also **range**.

ejector: The mechanism that expels the cartridge or case from the firearm.

extraction: The removal of a cartridge or case from the chamber of a firearm.

F

feed: The action of moving a fresh cartridge into the chamber.

feeding path: The path a cartridge follows within an action.

field stripping: Taking apart a firearm for regular maintenance and cleaning.

firearm: See under [Appendix C: Legal Definitions](#).

firing pin: The part of the breech mechanism that strikes the primer of the cartridge.

flash suppressor: Muzzle attachment designed to cool emergent gases and prevent or reduce muzzle flash.

flat-nosed bullet: A bullet with a flattened front end. It is used mainly in cartridges designed for rifles with tubular magazines.

fléchette: A small dart stabilized by fins. It is encased in a discarding sabot (case) and loaded into a shotgun shell. Usually, one shell will contain a number of fléchettes. This type of ammunition is prohibited.

flintlock: The gunlock of early firearms in which flint is struck against steel. This causes sparks to ignite the powder charge.

floor plate: The metal plate at the bottom of some cartridge magazines. (The floor plate is usually hinged at the front and held by a release spring located just ahead of the trigger guard.)

follow-through: Staying in the same position after squeezing the trigger or continuing the swing in firing at a moving target. This helps to shoot accurately.

follower: The part of a magazine between the spring and the ammunition. You must be able to see or feel the follower to know the magazine is empty. See also **magazine follower**.

forcing cone: In smooth bore and revolver barrels, a cone that joins the chamber to the bore. It assists the passage of the projectile(s) into the bore. Also called a throat.

forearm/fore-stock: The forward part of a one or two piece stock. It is sometimes called a slide on pump action firearms.

frizzen: The metal arm of a flintlock mechanism. The flint strikes the frizzen to create sparks in the flash pan. It is also called a battery.

full cock: The position of the hammer or striker when the firearm is ready to fire.

full-metal jacket: A bullet with a jacket, usually of harder metal, encasing the core. It is also called a hard-point bullet. Used in ball ammunition.

G

gauge: The measurement of the diameter of a shotgun bore.

grain: A unit of weight (7,000 grains equal one pound) commonly used to measure the weight of ammunition components. Black powder and its substitutes are measured in grains by volume. Modern powders are measured by weight.

grip: The small portion of the stock gripped by the trigger hand.

grooves: See **rifling**.

H

half cock: A safety feature on some firearms. When the hammer is pulled back half-way, it cannot be fired by squeezing the trigger.

hammer: The part of the action that drives the firing pin forward.

handgun: See under [Appendix C: Legal Definitions](#).

hangfire: A malfunction causing a delay in firing a cartridge after the firing pin has struck the primer.

high power: A term applied to the first smokeless powder cartridges with velocities of approximately 609.6 m/s (2,000 ft./s).

high-powered rifle: Generally, a firearm that uses centre-fire ammunition.

holding: The action of keeping the sights on the target while squeezing the trigger.

hollow point: A bullet with a hollow at the tip (nose) that makes it expand more on impact.

hull: The outer covering or casing of a shotgun shell.

I

No applicable entry.

J

jacket: The outer covering over the inner metal core of a bullet.

K

kick: See **recoil**.

L

lands: See **rifling**.

leading: Particles from shot or bullets that stick to the metal surface of the bore. This is due to heat or friction.

lever action:

a) An action operated by a lever located underneath it. (A secondary purpose of the lever is to serve as a trigger guard.)

b) A repeating firearm that has a magazine and a breech mechanism cycled by an external lever, usually below the receiver or frame.

line of sight: An imaginary straight line from the shooter's eye to the target; usually through the sights.

live ammunition: Ammunition containing primers and propellants capable of firing bullets or other projectiles.

load: To prepare a firearm for firing by inserting ammunition into it.

loading gate: The hinged cover over the opening through which cartridges are inserted into the magazine or chamber.

loading port: The opening through which cartridges are inserted into the magazine or chamber.

lock: The firing mechanism of a muzzleloader. In firearms that are loaded through the breech, the lock is both the firing mechanism and breech-sealing assembly.

long gun: Generic term used to describe rifles and shotguns.

M

magazine: See **cartridge magazine**.

magazine cut off: Disengages magazine feed from firearm.

magazine follower: Spring-loaded platform in a magazine. It pushes cartridges or shells to the feeding position. When checking that a firearm is completely unloaded, the magazine follower should be clearly in view. This is especially important with tubular magazines.

magazine release: A button or switch that allows for the removal of a magazine from the firearm.

magnum:

- a) A cartridge or shell with a larger capacity or with a higher velocity than average (e.g., 3.5-inch Magnum shot shell, .300 Winchester Magnum rifle, .44 Remington Magnum handgun). Firearms that use magnum ammunition may also be called magnum.
- b) A marketing term used by manufacturers which may or may not indicate greater power or range.

mainspring: A strong spring which activates the striker or hammer of a firearm.

malfunction: The failure of a firearm to work properly. This can be caused by a jam or stoppage, or a mechanical or structural failure.

master eye: The stronger eye; the eye through which a person usually views an object as when sighting a firearm.

match/wick: A long cord soaked in saltpetre, which burns slowly. Used to ignite powder in early firearms.

matchlock: A firearm action that uses a serpentine or S-shaped piece of metal to hold a smouldering match. The burning match contacts the priming powder in the pan to ignite the charge.

metallic cartridge: A cartridge with a metallic case. In contrast, early cartridge cases were made of linen, paper, etc.

mid-range: The point in the trajectory halfway between the muzzle and the target.

Mini-ball or Minie ball: A cylindrical-shaped bullet used in muzzleloaders. It has a pointed tip and a hollow base that spreads as it is fired.

misfire: The failure of a cartridge to fire after the firing pin has struck the primer. Do not confuse with hangfire, which is a delay in firing.

mushroom: The shape many soft-point bullets become when they expand upon impact.

musket: An early smoothbore shoulder firearm.

muzzle: The opening at the end of the barrel from which the bullet or shot emerges.

muzzle brake: A device attached to the muzzle that softens the recoil of the firearm. Also known as a compensator.

muzzleloader: A firearm that is loaded through the muzzle.

N

non-restricted firearm: See under [Appendix C: Legal Definitions](#).

O

open sight: A type of firearm sight, usually with a "V" or "U" notch in the rear sight. See also **sight**.

over-and-under: A firearm, usually a shotgun, with two barrels placed one over the other.

P

pan: The small container located on the side or top of a matchlock, wheel lock or flintlock firearm used to hold the priming powder.

patch:

a) A small piece of leather or cloth that is greased and placed around a bullet before ramming it down the barrel of a muzzleloader.

b) A piece of cloth drawn through the bore of a firearm to clean it.

patch box: A small compartment in the butt of a muzzleloader used to store patches or other small items.

pattern: Distribution of the shot in a shotgun charge. This is measured at a standard distance of 40 yards and in a 30-inch circle.

peep sight: A rear sight with a hole through which the target is viewed. Also known as an aperture sight.

pellet: Small round projectiles loaded into shotgun shells. Usually referred to as shot. Also a lead projectile used in some air guns.

penetration: The depth that a projectile travels into a target before it stops.

percussion cap: A small metal explosive-filled cup that is placed over the nipple of a percussion firearm.

pistol: A small hand-held firearm.

powder: The general term for any propellant used in firearms which burns upon ignition. The two major types are black powder (an explosive) and smokeless powder (a propellant).

powder burn: Charring caused by gunshot residue.

powder charge: The amount of powder by weight in the case of smokeless powder, and by volume, in the case of black powder.

prime: In the case of a black-powder firearm, to place powder on the pan or percussion cap on the nipple. Also, to place a primer in a cartridge case.

primer: The overall term for the priming compound, cup and anvil which, when struck, ignites the powder charge.

primer pop: The sound of only the primer discharging due to no or grossly inadequate charge of powder in the cartridge.

prohibited ammunition: See under [Appendix C: Legal Definitions](#).

prohibited device: See under [Appendix C: Legal Definitions](#).

prohibited firearm: See under [Appendix C: Legal Definitions](#).

projectile: A bullet or shot in flight after firing from a firearm.

propellant: The chemical substance which, when ignited, propels the projectile. Also called powder.

pull-through: The cord used to pull a bore brush or cleaning patch through the bore of a firearm.

pump action:

- a) An action that is operated by moving the fore-end in a motion parallel to the bore.
- b) A repeating firearm that has a magazine and is manually set in motion usually parallel to the barrel; also called slide action or trombone action.

Q

No applicable entry.

R

ramrod: A wood or metal rod used to push the patch and bullet down the barrel of a muzzleloader.

range:

- a) The distance travelled by a projectile from firearm to target.
- b) A projectile's maximum travelling distance.
- c) An area or facility designed for the safe shooting of firearms.
- d) Dangerous range: the maximum distance at which a projectile will travel.
- e) Effective range: the greatest distance a projectile will travel with accuracy.

receiver: A firearm's metal frame that generally contains the breech, locking and loading mechanisms. Normally the serial number is on the receiver. Also called the frame.

recoil: The backward movement of a firearm when it is fired. Also called kick.

replica firearm: See under [Appendix C: Legal Definitions](#).

restricted firearm: See under [Appendix C: Legal Definitions](#).

revolver:

- a) A repeating handgun that has a revolving cylinder with a series of chambers. The cylinder may revolve in either direction, depending on the manufacturer.
- b) A firearm, usually a handgun, that has a revolving cylinder with a series of chambers, and is discharged successively by the same firing mechanism. The chamber may revolve in either direction depending on the manufacturer.

revolving action: An action with a revolving cylinder containing a number of cartridge chambers. One chamber at a time lines up with the barrel.

ricochet: The redirection of a projectile after impact, usually with a hard surface. For example, a bullet bouncing off a rock.

rifle: A shoulder firearm with a rifled bore. Designed to fire one projectile at a time. See also **rifling**.

rifled slug: A large, single projectile with spiral grooves used in shotguns.

rifling: Spiral grooves inside the barrel. Rifling causes the bullet to spin, increasing its accuracy and range. The depressed portions of the rifling are called grooves and the raised portions are called lands.

rim: The edge on the base of a cartridge case. The rim is the part of the case that the extractor grips to remove the cartridge from the chamber.

rim-fire: A cartridge that has its primer located inside the rim of the case. See also **cartridge**.

rod: A rod used for cleaning a firearm. It is used to check for obstructions prior to loading the firearm. It may also be referred to as a ramrod, proving stick or dummy rod.

round: One shot fired by a firearm. It is also a complete item of ammunition or a cartridge that has all the components needed to fire one shot.

round-nose bullet: A bullet with a rounded nose.

S

sabot: A plastic sleeve that holds a slug that is smaller than the bore diameter of a firearm. It is used mainly in shotguns and muzzleloading firearms.

safety: A device that blocks the firing mechanism of a firearm.

scope: See **sight**.

sear: Part of the firing mechanism linked to the trigger. The sear holds the hammer, firing pin or striker in the cocked position until the trigger is squeezed.

secure locking device: See under [Appendix C: Legal Definitions](#).

semi-automatic:

- a) An action which fires, extracts, ejects, chambers and cocks with each separate pull of the trigger.
- b) A repeating firearm requiring that the trigger be pulled for each shot fired and which uses the energy of the discharge to perform part of the operating cycle; sometimes called auto-loading or self-loading actions.

semi-wadcutter: A cylindrical bullet with a short truncated cone at the nose. Often used for paper target shooting.

shell: A complete unit of ammunition consisting of a hull, primer, powder, wad and projectile(s) for use in shotguns.

shotgun: A shoulder firearm with a smooth bore designed to fire multiple pellets called shot, or a single projectile called a slug.

shot shell / shotgun shell: A cartridge used in a shotgun. It contains multiple shot pellets or a single projectile called a slug.

side by side: A firearm, usually a shotgun, with two barrels placed side by side.

sight: A firearm device, either mechanical or optical, that helps the shooter aim accurately.

single action: An action that releases the hammer from a cocked position when the trigger is pulled. Usually found on handguns.

single action revolver: A revolver that requires the hammer to be cocked manually. Pressing the trigger will not cause it to fire until this is done.

single shot: A single-barrel firearm that is manually loaded and has no magazine-feed device.

slide safety: A device that blocks the firing mechanism of a firearm.

sling: A strap used to carry and aid in aiming a rifle.

slug: A large single projectile used in shotguns. See also **rifled slug**.

small bore: Generally refers to a .22 calibre firearm or rim-fire ammunition.

smokeless powder: Propellant powder used in modern firearms.

smooth bore: A firearm with a bore that is not rifled, such as a shotgun.

soft-point bullet: A bullet with a partial jacket exposing a portion of the lead core at the nose.

spent bullet: A bullet near the end of its flight that has lost nearly all its energy. Despite a loss in energy, spent bullets can still penetrate targets.

spire-point bullet: A bullet with a cone-shaped nose.

stock: The part of a rifle or shotgun used in holding the firearm.

T

tang safety: A device that blocks the firing mechanism of a firearm.

telescopic sight: See **sight**.

trajectory: The path a projectile takes during flight.

trigger: The part of the firearm mechanism that releases the part of the action that fires the cartridge.

trigger guard: The metal loop around the trigger made to protect it and prevent accidentally touching the trigger.

U

unattended: See under [Appendix C: Legal Definitions](#).

unloaded: See under [Appendix C: Legal Definitions](#).

V

vehicle: See under [Appendix C: Legal Definitions](#).

velocity: The speed at which a projectile travels in a given direction.

W

wad: A paper fibre or plastic disc used to separate the powder charge from the shot or slug, to seal propellant gases behind the charge, and to hold the shot together in the barrel.

wad-cutter: A cylindrical bullet with a sharp, shouldered, nearly flat nose. It is designed to cut paper targets cleanly so they can be scored accurately.

wheel lock: An early firearm mechanism. A wheel with serrated edges is spun against a piece of iron pyrite. This sends sparks into the pan to ignite the charge.

wing safety: A device that blocks the firing mechanism of a firearm.

X

No applicable entry.

Y

No applicable entry.

Z

No applicable entry.

All instructors who teach the Canadian Firearms Safety Course (CFSC) and the Canadian Restricted Firearms Safety Course (CRFSC) must meet and maintain certain service standards and quality of instruction. The Canadian Firearms Program (CFP) relies on student feedback in order to monitor and constantly improve how this firearms safety training is being provided.

If you would like to provide feedback to the CFP regarding your CFSC or CRFSC training experience, we welcome you to contact us at: CFO_Program-Programme_CAF@rcmp-grc.gc.ca

