

PNet

Program for the Simulation and Estimation of
Exponential Random Graph (p^*) Models

USER MANUAL

Peng Wang

Garry Robins

Philippa Pattison

Department of Psychology
School of Behavioural Science
University of Melbourne
Australia

September, 2009

Table of Content

<i>Introduction</i>	<i>1</i>
Acknowledgements	1
System Requirements	2
Setup PNet	2
Update PNet	2
<i>Using PNet</i>	<i>3</i>
Start PNet	3
Simulation	4
Simulation Setup	4
Simulation Output	8
Estimation	9
Estimation Setup	9
Estimation Options:	9
Estimation Output	11
Goodness of Fit	12
Goodness of Fit Setup	12
Goodness of Fit Output	12
Approximate Bayesian goodness of fit	13
<i>PNet Extensions</i>	<i>14</i>
BPNet	14
Introduction	14
Simulation	14
Estimation	17
Goodness of Fit	17
<i>References</i>	<i>18</i>
<i>Appendix A – Sample Files</i>	<i>21</i>
Sample Input Files	21
Sample Output Files	23
“start_statistics_[session name].txt”, “end_statistics_[session name].txt” and “sample_statistics_[session name].txt”	23
“simulation_[session name].txt”	24
“parameter_[session name].txt”	25
“estimation_[session name].txt”	25
“covariance_[session name].txt”	26
“gof_[session name].txt”	27
<i>Appendix B – Model Parameter Description</i>	<i>32</i>
Non-directed Graphs	32
Directed Graphs	34
XPNet Graph Statistics	36
BPNet Graph Statistics	39
IPNet Graph Statistics	42

Introduction

PNet is a program for statistical analysis of exponential random graph (p^*) models (ERGMs). It has three major functionalities:

- Simulation:
 - Simulating network distributions with specified model parameter values.
- Estimation:
 - Estimating specified ERGM parameters for a given network.
- Goodness of Fit:
 - Testing the goodness of fit of a specified model to a given network with a particular set of parameters.

Acknowledgements

PNet contains code and ideas from many people. We would like to thank the following people for contributing to this program.

Carter Butts, Galina Daraganova, Steve M. Goodreau, Mark S. Handcock, Nicholas Harrigan, David Hunter, Tasuku Igarashi, Johan Koskinen, Dean Lusher, Martina Morris, Ken Sharpe, Tom A.B. Snijders, Christian E.G. Steglich, Lei Xing, Yu Zhao.

System Requirements

Operating system	Microsoft® Windows operating systems
Software	Microsoft .NET framework version 1.1+ Java TM 2 platform standard edition 5.0+

The Software required is freely available from Microsoft and Sun's web site.

- Microsoft: www.microsoft.com
 - Under Download, search for [.NET Framework Version 1.1 Redistributable Package](#)

- JAVA TM 2 Platform Standard Edition 6.0
 - <http://java.sun.com/javase/downloads/index.jsp>

Setup PNet

PNet consists of two components, a user interface developed in Java “PNet.jar”, and a simulation/estimation engine “pnet.dll” developed in C to achieve good performance.

Before installing PNet, make sure your system meets the specified system requirements as described.

Copy the PNet.jar and pnet.dll into the same folder; you can then start the program by double clicking on the PNet.jar icon.

Note that PNet.jar and pnet.dll files must be located in the same folder for the Java interface PNet.jar to call the library functions in pnet.dll.

Update PNet

Newer version of PNet will be available and can be downloaded from www.sna.unimelb.edu.au/pnet/pnet.html

Please replace your current PNet.jar and pnet.dll files, and update the Java runtime environment to finish the update.

Using PNet

To setup a simulation, estimation or goodness of fit, you will need to choose the relevant options from the user interface and specify several program settings. The program requires input files, and produces text file output. Samples of input files and output files can be found in Appendix A.

Start PNet

PNet can be started from the Windows Start menu under Program Files, PNet. At the top of PNet main window, both Session Name and Session Folder are required for the output file names and location.

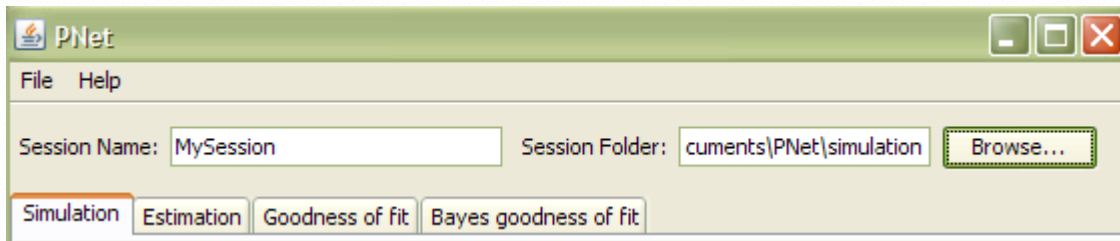

■ Session Name

Provide a name for the current session for simulation, estimation, goodness of fit or approximate Bayesian goodness of fit. This name will be used for the names of the output files. All output files will have file names that end with the Session Name you provided here, (E.g. if you have a session name MySession under simulation, you will have an output file named “simulation-MySession.txt.”)

■ Session Folder

All program output files will be located in the Session Folder selected here. You can browse through your system and select the folder by clicking on the Browse button.

Simulation, Estimation, Goodness of fit and Approximate Bayesian goodness of fit, each has its own tab, with similar structures. Under each tab, several settings need to be specified to configure your p* model.

Simulation

Simulation Setup

To correctly configure simulation, you need to specify several settings

- Number of Actors

Type in the number of actors in the network.

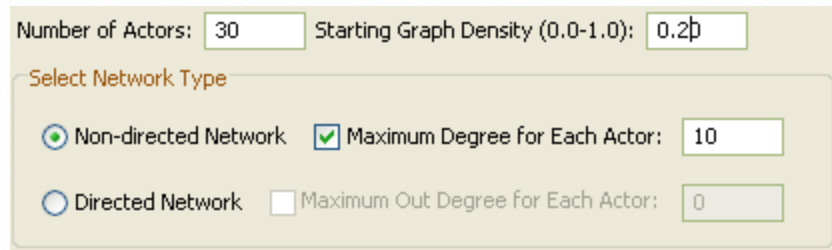

- Starting Graph Density

Type in the starting density of a random graph in the simulation that used to generate the starting simulation network. Type in a floating point number between 0.0 and 1.0.

- Select Network Type:

Models for directed and non-directed networks can be simulated. Choose the network type here. If you have a model that having constraint on the maximum number of ties that an actor can have, you should also specify it here by clicking on the checkbox and type in the maximum degree.

- Select Structural Parameters

Click on the Structural Parameters Checkbox to enable the selection button.

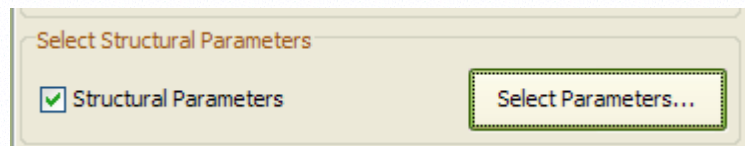

By clicking the Select Parameters button, structural parameter dialog appears.

Select parameters for your simulation model and specify their values and lambda values if they are higher order parameters.

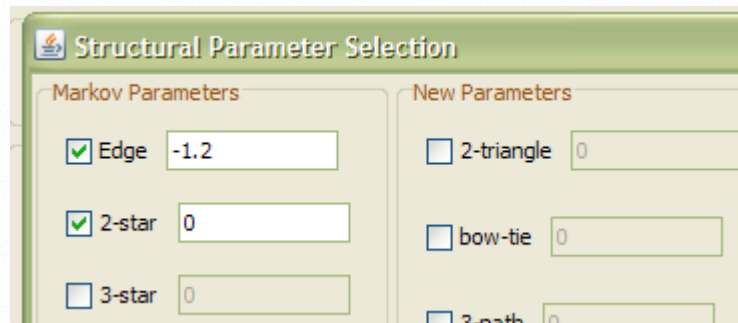

The "Clear All" button will deselect all parameters and reset their values to

0. It will also reset lambda to the default value of 2.0

The “Select All” button will select all parameters.

Finish the structural parameter selection by clicking on the OK button.

■ Select Dyadic Attribute Parameters

Select the dyadic attribute parameters if you have one or more fixed setting network as network covariates.

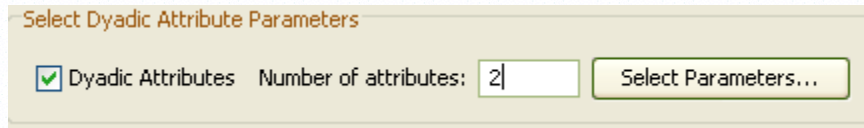

By clicking on the Browse button, a file open dialog appears, select the Covariate network file and click on OK.

The dyadic attribute file is a plain text file having the dyadic attributes listed in the adjacency matrix format.

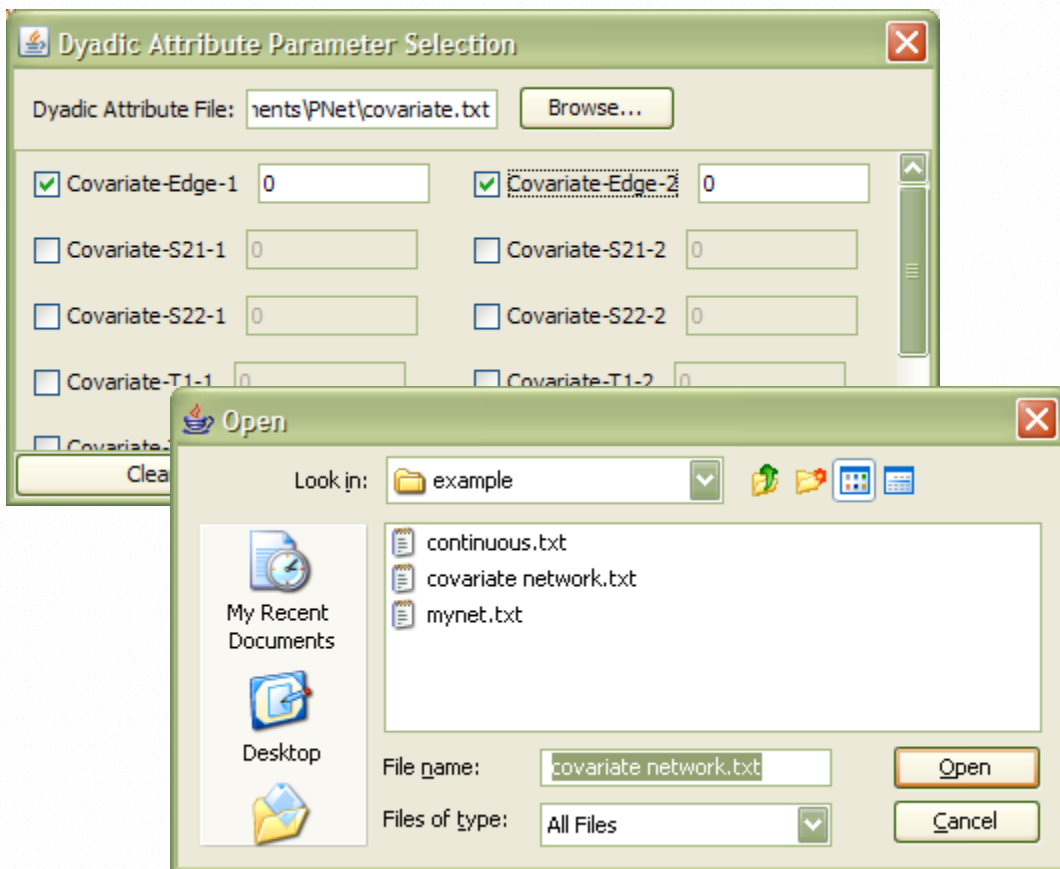

■ Select Actor Attribute Parameter

Actor attribute Parameters are used in social selection models. You may have three different types of attributes, Binary, Continuous and Categorical. The can be selected in a similar manner. The number of attributes should be specified before select the actual parameters. Attribute files should also be specified similar to the way how dyadic attribute file is specified. Please check Appendix A for attribute file format.

The image shows two overlapping dialog boxes. The top dialog, titled "Select Actor Attribute Parameters", has a title bar with a small icon and a close button. It contains a checked checkbox for "Actor Attribute Parameters". Below it are three rows, each with a checked checkbox, a label, and a "Number of attributes:" field with a text input box and a "Select Parameters..." button. The rows are: "Binary Attributes" with value "1", "Continuous Attributes" with value "2", and "Categorical Attributes" with value "1". The bottom dialog, titled "Continuous Attribute Parameter Selection", has a title bar with a close button. It features a "Continuous Attribute File:" label, a text input field containing ":s\\example\\continuos.txt", and a "Browse..." button. Below this are six rows of parameter selection, each with a checkbox and a text input field. The rows are: "Sum-1" (checked, value "0.2"), "Sum-2" (checked, value "-0.5"), "Difference-1" (checked, value "1.2"), "Difference-2" (checked, value "-0.5"), "Product-1" (unchecked, value "0"), and "Product-2" (unchecked, value "0"). At the bottom are three buttons: "Clear All", "Select All", and "OK".

■ Simulation Options

■ Fix out-degree distribution

Directed networks only, this option will make simulated samples having identical out-degree distribution.

■ Fix the graph density

Fix the density of the graph, i.e. the number of arcs/edges in the network does not change through the entire simulation. Note, as the number of arcs/edges has been fixed, the arc/edge parameter should not be selected for simulation.

■ Structural "0" File:

Structural-zeros refers to the indicators for tie variables that are fixed

through the simulation. One may fix part of the network by applying a structural-zero file to the simulation. The file should contain a binary adjacency matrix with the same number of rows/columns as in the number of actors. In the matrix, “1” indicates the corresponding tie in the network is NOT fixed, “0” otherwise.
Please check Appendix A for structural-zero file format.

- Pick up Sample graph Files,
 Sample degree distribution,
 Sample geodesic distribution and
 Sample clustering coefficient.

If selected, the corresponding samples will set to be part of the program output in separate files.

The screenshot shows a dialog box titled "Simulation Options". It contains the following elements:

- Radio buttons: "No conditions" (selected), "Fix out-degree distribution", and "Fix graph density".
- Checkboxes: "Structural '0' File:" (unchecked), "Pick up sample graph files." (unchecked), "Pick up sample degree distribution." (unchecked), "Pick up sample geodesic distribution." (unchecked), and "Pick up sample clustering coefficient." (unchecked).
- Input fields: "Burn in:" with value 100000, "Number of Iterations:" with value 1000000, and "Number of samples to pick up" with value 1000.
- A "Browse..." button next to the "Structural '0' File:" input field.

- Burn in
 Burn in is the starting period of a simulation during which the network is evolving and getting adapted to the specified parameter values.

Depends on the size of the network and number of parameter values, burn-in can vary largely. The larger the network, or the more parameter involved, the longer burn-in is needed. K-statistics tend to have longer burn-in.

- Number of iterations

Type in the number of iterations after burn in for the simulation

- Number of samples to pickup

Type in the number of sample graph statistics should be picked up in the simulation

Click on the start button, the simulation starts. PNet will notify you once the simulation finished.

Simulation Output

File Output

- “start_statistics_session.txt”

This file contains the starting graph with selected statistics

- “simulation_graph.sps” or “simulation_digraph.sps”

This file contains the SPSS script to plot the scatter-plot and histogram of the simulated graph statistics using SPSS version 12.0 and above.

- “simulation_graph.txt” or “simulation_digraph.txt”

This file contains the list of sample statistics collected during the simulation.

Using the SPSS script file, you can plot the statistics as scatter-plots and histograms.

- “parameter_graph.txt” or “parameter_digraph.txt”

Showing parameter values used in simulation.

Estimation

Estimation Setup

To correctly setup an estimation run, several settings need to be configured.

- Same as in Simulation, Session Name and Number of Actors should be provided.
- Network File can be selected by clicking on the Browse Button.
- Network Type is selected the same way as in Simulation. By setting up the maximum degree, the model is conditional on the maximum degree of each actor.
- Structural, Covariate and different kind of Actor Attribute parameters can be selected as in Simulation. See detailed parameter description in Appendix B.
- Starting parameter values can be specified as well at the parameter selection dialog. If parameter values are not specified, all starting parameter values are set to 0.0, except the edge or arc parameter which is calculated based on the density of the network.

Estimation Options:

- Fix out-degree distribution

For Directed networks only, this option will estimate conditional models such that the out-degree distribution will be fixed through out the estimation.

- Fix the graph density

Fix the density of the graph, i.e. the number of arcs/edges in the network does not change through the entire simulation. Note, as the number of arcs/edges has been fixed, the arc/edge parameter is not estimable, and it should not be selected for estimation.

- Fix the graph density

By fixing the graph density, the number of arcs/edges will not change during estimation. Fixing graph density may help convergence for parameter estimation, especially for large networks. Note, as the number of arcs/edges has been fixed, the arc/edge parameter should not be selected for estimation.

■ Structural “0” File:

By applying structural “0” file, part of the network under estimation can be fixed. The file should contain a binary matrix where “1” indicates the corresponding tie in the network is NOT fixed, “0” otherwise. Please check Appendix A for the format of the structural-zero file.

■ Number of Sub-phases

Each sub-phase refines the parameter values, but more sub-phases do not guarantee convergence. The default value is 5. If a good set of starting parameter values is available, small number of sub-phases may help reduce time required for the estimation.

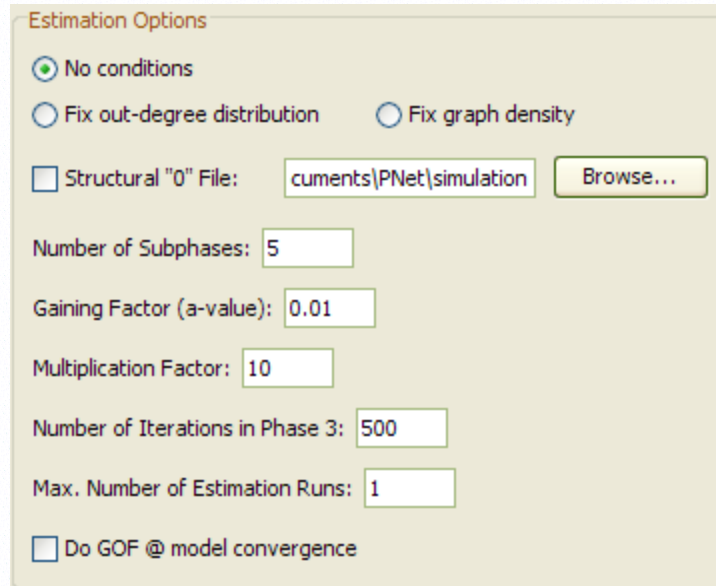

■ Gaining Factor (a-value)

The a-value is halved after each sub-phase. The default a-value is 0.01. Smaller a-value may be used, if a good set of starting parameter values is available.

■ Multiplication Factor

The larger the multiplication factor, the longer the estimation, but it may help convergence especially for some large networks. The default value is 10. Set it to the number of parameters may be helpful, and K-statistics tends to need factor values bigger than 20 (e.g. 20 to 100).

■ Number of steps in phase 3

In phase 3, the program simulates network graphs using estimated parameters from phase2, and produce t-statistics according to the simulation and observation. The default value is 500 steps.

- Maximum number of estimation runs

As default, the program will perform 1 run of estimation and quit. Multiple runs can be performed one after the other; each run uses the parameter values from the end of the previous run. A better parameter estimate may be obtained as the new estimation may start with a better set of parameter values. The program will stop once the model has converged, or the maximum number of estimation runs has reached.

- Do GOF @ model convergence

PNet can perform automatic goodness of fit test once the model under estimation has converged. The GOF output file will be located in the session folder.

- Update

After first estimation run, the update button will be enabled. It is used when you want to start next estimation run with previous estimated parameters so that you may start from a better set of parameters.

Note: PNet will always load the previous estimation session. Please do NOT use update, if the session name, session folder, or network file has been changed.

Estimation Output

File Output

- “start_statistics_graph.txt”

This file contains the starting graph with graph statistics

- “estimation_graph.txt”

Estimation result shows starting parameter values, starting graph statistics and parameter updates through Phase 2 of the estimation. The final estimates and estimated covariance matrix are shown at bottom of the file.

- “covariance_graph.txt”

It contains the estimated covariance matrix by itself, and it can be used as the covariance file in Approximate Bayesian goodness of fit.

Goodness of Fit

Goodness of Fit Setup

Most settings for Goodness of Fit is the same as in Simulation, except the observed network and parameter values are required. The observed network file can be specified as in Estimation.

Make sure that all parameters are selected; you may do this by using the “select all button in the parameter selection panel.

The parameter values from your model should also be specified. You can type in the parameter values as in simulations, or you can use the “Update” button. Note: Update button will only work once all parameters have been selected (you may use “select all” button in parameter selection panels). It always loads parameters from immediate previous estimation session. Please only use update button immediately after a successful estimation.

Goodness of Fit Output

File Output

- “start_statistics_graph.txt”

This file contains the observed graph and graph statistics

- “simulation_graph.sps”

This file contains the SPSS script to plot the scatter-plot and histogram of the simulated graph statistics using SPSS version 15.0 and above.

- “accept_graph.txt”

Showing the ratio of accepted simulation tie changes within each simulation intervals between every two sample graphs.

- “gof_graph.txt”

Goodness of fit file contains the original or observed statistics for the given network graph, and goodness of fit for the specified model for all available graph statistics.

Approximate Bayesian goodness of fit

In terms of program setup, the difference between approximate Bayesian goodness of fit and Goodness of fit described in previous section is that approximate Bayesian goodness of fit requires the estimated covariance matrix as part of the input.

The covariance file is a text file containing the estimated covariance matrix only. One may use the covariance file generated from the immediate previous estimation session; or one can copy the estimated covariance matrix from the estimation result file and past it into a new text file.



Covariance File:

As covariance matrix is only regards to the model estimates, pleas ONLY select parameters that are included in the model in the parameter selection panels.

Other options for Approximate Bayesian goodness of fit are identical to the settings in Goodness of fit described in previous section.

PNet Extensions

BPNet

Introduction

BPNet is a program designed for exponential random graph models for bipartite networks where network ties are only defined between two sets of actors. The network statistics include both structural and configurations involving actor attributes.

The general setup and use of the program is similar to PNet. It has a Java user interface, and C simulation engine. Modifications are made to accompany features of bipartite networks.

Following are screen shots for BPNet with user instructions aside.

Simulation

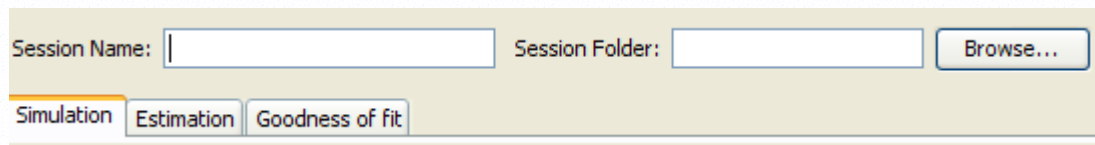

Session Name: Session Folder:

Simulation

The same as in PNet, Session Name and Folder need to be specified first, and output files will have file names ending with session name, and they will be located in the session folder.

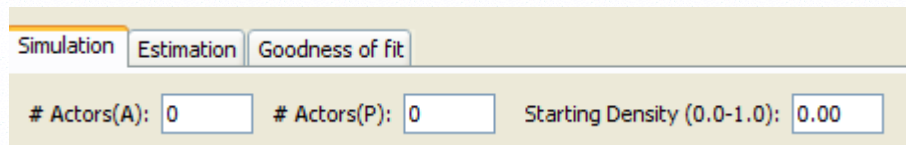

Simulation

Actors(A): # Actors(P): Starting Density (0.0-1.0):

Numbers of actors (A) and (P) are the number of nodes in set A and set P. Simulations can be started with a random bipartite networks with specified density.



Select Structural Parameters

Structural Parameters

Structural parameters can be selected by clicking on the check boxes. The details of the network configurations can be found in Appendix B.

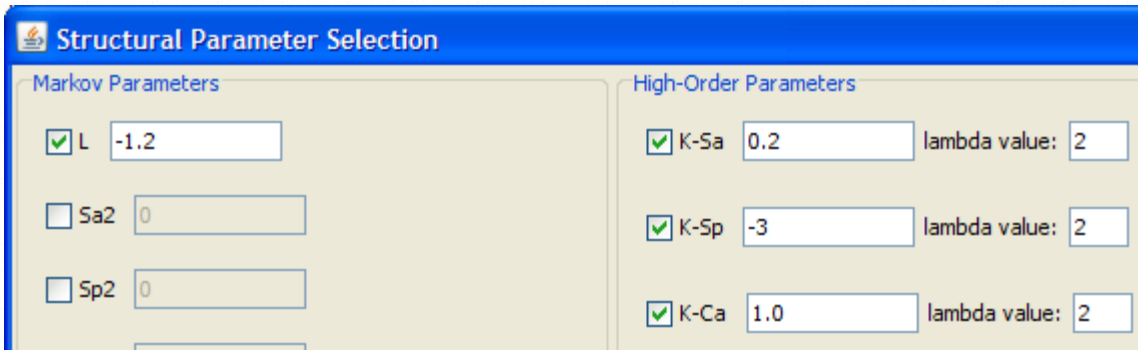

Parameter values for simulations can be specified during parameter selection. The default values are 0s.

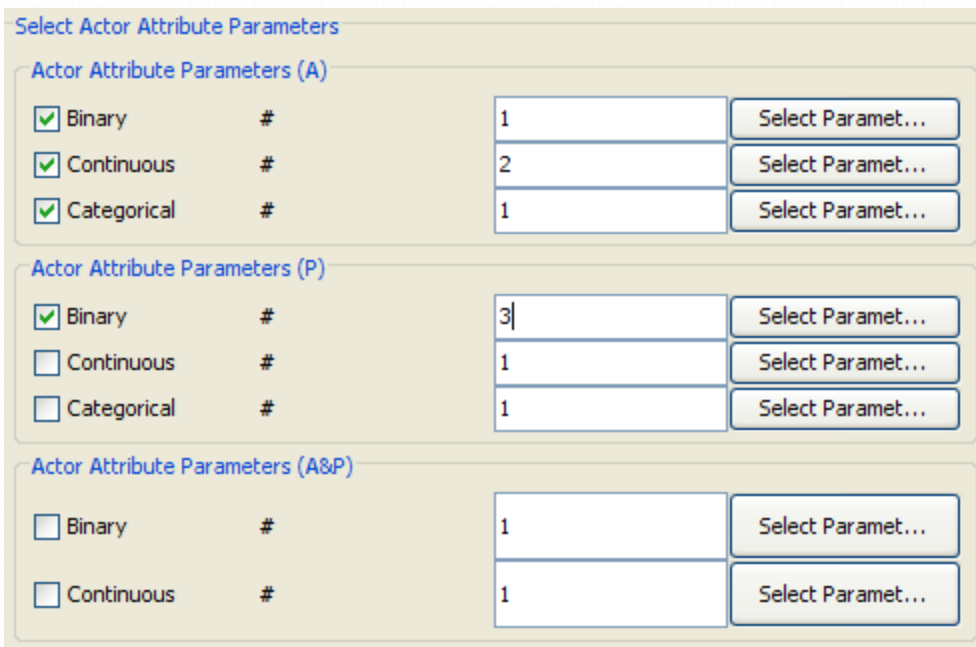

Actor attribute parameters are selected by click on the check boxes, and type in the number of attributes for a particular type (binary, continuous, or categorical). Available parameters will show up after clicking the “Select Parameters...” button.

Using continuous attribute as an example, attribute file name must be specified, and parameters and their values can then be selected. The attribute file format are the same as in PNet, where attribute names are separated using (,) as the first line, then the attributes listed in space, or tab separated columns. Attribute file format examples are listed in Appendix A.

Since two sets of actors are involved in BPNNet, separate attribute files are required for parameters involving only one set of actors, either A or P. For interaction actor attribute effects, the attribute file should list attributes for nodes

in set A first, then followed by attributes for nodes in set P. Putting them in the other order will produce wrong modeling results.

Continuous Attribute Parameter Selection (A)

Continuous Attribute File (A): Documents\ContAttr.txt

<input checked="" type="checkbox"/> RAc-1	<input type="text" value="-1"/>	<input type="checkbox"/> RAc-2	<input type="text" value="0"/>
<input type="checkbox"/> TscAc-1	<input type="text" value="0"/>	<input checked="" type="checkbox"/> TscAc-2	<input type="text" value="2"/>
<input type="checkbox"/> TsoAcs-1	<input type="text" value="0"/>	<input type="checkbox"/> TsoAcs-2	<input type="text" value="0"/>
<input checked="" type="checkbox"/> TsoAcd-1	<input type="text" value="0.5"/>	<input type="checkbox"/> TsoAcd-2	<input type="text" value="0"/>
<input type="checkbox"/> C4Acs-1	<input type="text" value="0"/>	<input type="checkbox"/> C4Acs-2	<input type="text" value="0"/>
<input type="checkbox"/> C4Acd-1	<input type="text" value="0"/>	<input checked="" type="checkbox"/> C4Acd-2	<input type="text" value="-0.8"/>

Simulation Options

No conditions Fix graph density

Structural "0" File:

Pick up sample graph files.

Pick up sample degree distribution.

Pick up sample clustering coefficient.

Burn in:

Number of Iterations:

Number of samples to pick up

Simulation options are similar to PNet, where we can fix the graph density, or use structural zero files to fix part of the network and treat them as exogenous.

Sample graphs, degree distributions, and clustering coefficients can be collected in separate output files.

Burn in, number of iterations, and number of samples to pick up are the same as in PNet.

Estimation

Actors(A): # Actors(P): Network File:

The Network File is text file with a binary rectangular matrix. The number of rows for the matrix should be the same as the number of Actors(A), and the number of columns is the number of Actors(P). Note: putting the number of actors in the other order will produce wrong modeling results.

Other settings for estimation are the same as in PNet.

Goodness of Fit

Goodness of fit settings are the same as in simulation, except the network file needs to be specified in the same way as in estimation.

References

A. Baddeley and J. Möller. Nearest-neighbour markov point processes and random sets. *International Statistical Review*, 57:89–121, 1989.

Peter Bore, Mark Hujsman, Tom A.B. Snijders, Christian Steglich, Lotte Wichers and Evelien Zeggelink. StOCNET: An open software system for the advanced statistical analysis of social networks. Groningen ICS / SciencePlus. <http://stat.gamma.rug.nl/stocnet/>. 2003

P. Erdős and A. Renyi. On the evolution of random graphs. *Publications of the Mathematical Institute of the Hungarian Academy of Science.*, 5:17–61, 1960.

Ove Frank and David Strauss. Markov graphs. *Journal of the American Statistical Association*, 81:832–842, Sep. 1986.

Charles J. Geyer and Elizabeth A. Thompson. Constrained Monte Carlo maximum likelihood for dependent data. *Journal of the Royal Statistical Society. Series B (Methodological)*, 54(3):657–699, 1992.

Steven M. Goodreau. Advances in exponential random graph (p^*) models applied to a large social network. *Social Networks (Special Edition)*., 29:231–248, 2007.

Mark S. Handcock. Assessing degeneracy in statistical models of social Networks, working paper no. 39., Center for Statistics and the Social Sciences, University of Washington, 2003.

Mark S. Handcock, David R. Hunter, Carter T. Butts, Steven M. Goodreau, and Martina Morris, *statnet: An R package for the Statistical Modeling of Social Networks*. Funding support from NIH grants R01DA012831 and R01HD041877. URL <http://www.csde.washington.edu/statnet>. 2003.

Paul W. Holland and Samuel Leinhardt. An exponential family of probability distributions for directed graphs. *Journal of the American Statistical Association*, 76(373):33–50, Mar. 1981.

David R. Hunter. Curved exponential family models for social networks. *Social Networks (Special Edition)*., 29:216–230, 2007.

David R. Hunter, Steven M. Goodreau, and Mark S. Handcock. Goodness of fit of social network models. *Journal of the American Statistical Association*, In Press.

Philippa E. Pattison and Garry L. Robins. Neighborhood-based models for social networks. *Social Methodology*, 32:301–337, 2002.

Philippa E. Pattison and Garry L. Robins. Building models for social space: Neighbourhood-based models for social networks and affiliation structures. *Mathematics and Social Sciences*, 42(168):11–29, 2004.

Philippa E. Pattison and Stanley Wasserman. Logit models and logistic regression for social networks, ii. multivariate relations. *British Journal of Mathematical and Statistical Psychology*, 52:169–194, 1999.

Herbert Robbins and Sutton Monro. A stochastic approximation method. *The Annals of Mathematical Statistics*, 22(3):400–407, Sep. 1951.

Garry L. Robins and Philippa E. Pattison. *Models and Methods in Social Network Analysis. Interdependencies and Social Processes: Generalized Dependence Structures*. Cambridge University Press, 2005.

Garry L. Robins, Philippa E. Pattison, Yuval Kalish, and Dean Lusher. An introduction to exponential random graph (p^*) models for social networks. *Social Networks (Special Edition)*, 29:173–191, 2007.

Garry L. Robins, Philippa E. Pattison, and Stanley Wasserman. Logit models and logistic regression for social networks, iii. valued relations. *Psychometrika*, 64(3):371–394, Sep. 1999.

Garry L. Robins, Philippa E. Pattison, and Jodie Woolcock. Small and other worlds: Global network structures from local processes. *American Journal of Sociology*, 110(4):894–936, Jan. 2005.

Garry L. Robins, Tom A.B. Snijders, Peng Wang, Mark Handcock, and Philippa E. Pattison. Recent developments in exponential random graph (p^*) models for social networks. *Social Networks (Special Edition)*, 29:192–215, 2007.

John Skovretz and Katherine Faust. Logit models for affiliation networks. *Sociological Methodology*, 29:253–280, 1999.

Tom A.B. Snijders. Markov Chain Monte Carlo estimation of exponential random graph models. *Journal of Social Structure*, 3:2, 2002.

Tom A.B. Snijders, Peter Boer, Evelien Zeggelink, Mark Huisman, and Christian Steglich. Siena: Simulation investigation for empirical network analysis. 2001.

Tom A.B. Snijders, Philippa E. Pattison, Garry L. Robins, and Mark Handcock. New specifications for exponential random graph models. *Sociological Methodology.*, 36:99–153, 2006.

Christian Steglich and Tom A.B. Snijders. Dyanmic networks and behavior: Separating selection from influence. In Press.

Stanley Wasserman and Katherine Faust. *Social Network Analysis*. Cambridge University Press, 1994.

Stanley Wasserman and Philippa E. Pattison. Logit models and logistic regression for social networks, i. an introduction to markov graphs and p^* . *Psychometrika*, 6(3):401–425, Sep. 1996.

Stanley Wasserman and Garry L. Robins. *Models and Methods in Social Network Analysis. An Introduction to Random Graphs, Dependence Graphs, and p^** . Cambridge University Press, 2005

Appendix A – Sample Files

Sample Input Files

Sample network or dyadic attribute file:

Network files or dyadic attribute setting files contain the observed or covariate network of interest in the adjacency matrix format.

```
0 0 0 0 0 0 0 0 0 0 0 0 0 0 0
0 0 0 0 0 0 0 0 0 0 0 0 0 0 0
0 0 0 0 1 0 0 0 0 0 1 1 0 0
0 0 0 0 1 1 0 0 0 0 0 1 0 0
0 0 0 1 0 0 0 0 0 0 0 0 0 0
0 0 1 0 1 0 0 1 0 0 0 0 0 0
0 0 0 0 1 0 0 0 0 0 0 0 0 0
0 0 0 0 1 0 0 0 1 1 1 0 0 0
0 0 0 0 0 0 0 0 0 0 0 0 0 1
0 0 0 0 0 0 0 1 1 0 1 0 0 0
0 0 0 0 0 0 0 0 0 0 0 0 0 1
0 0 0 0 0 0 0 0 1 0 0 0 0 0
0 0 0 0 0 0 0 1 0 0 0 0 0 0
0 0 0 0 0 1 0 0 0 1 0 0 0 0
```

Sample structural zero file:

The file contains a binary matrix where '1' indicates changeable ties, and '0' indicates fixed ties. Applying this structural zero file example will fix all the tie variables related to node 2 and 5. Also ties between node 1 and 13, node 1 and 14, are also fixed.

```
0 0 1 1 0 1 1 1 1 1 1 1 1 0 0
0 0 0 0 0 0 0 0 0 0 0 0 0 0 0
1 0 0 1 0 1 1 1 1 1 1 1 1 1 1
1 0 1 0 0 1 1 1 1 1 1 1 1 1 1
0 0 0 0 0 0 0 0 0 0 0 0 0 0 0
1 0 1 1 0 0 1 1 1 1 1 1 1 1 1
1 0 1 1 0 1 0 1 1 1 1 1 1 1 1
1 0 1 1 0 1 1 0 1 1 1 1 1 1 1
1 0 1 1 0 1 1 1 0 1 1 1 1 1 1
1 0 1 1 0 1 1 1 1 0 1 1 1 1 1
1 0 1 1 0 1 1 1 1 1 1 0 1 1 1
1 0 1 1 0 1 1 1 1 1 1 1 0 1 1
1 0 1 1 0 1 1 1 1 1 1 1 1 0 1
1 0 1 1 0 1 1 1 1 1 1 1 1 1 0
```

Attribute file format

- Each column represents an attribute.
- Each row corresponds to the same row as in the adjacency matrix
- Attribute names should be listed in the first line, delimited by ','s.
 - Note that attribute names should not start with numbers to meet the SPSS script requirements for variable names.

Sample binary actor attribute file:

```
member , gender
1      1
1      1
0      1
1      0
1      1
0      0
1      0
0      0
1      1
1      0
0      1
0      0
0      1
1      0
```

Sample categorical actor attribute file:

```
department , club
1      1
3      2
2      3
3      2
1      3
2      1
1      2
2      3
3      1
3      3
2      2
3      2
1      1
1      2
```

Sample continuous actor attribute file:

```
income , age , performance
1.0    23    2
1.1    34    6
1.1    42    5
0.5    23    4
0.3    24    1
1.1    19    1
1.5    38    2
0.2    49    1
0.1    58    1
0.2    47    2
1.0    24    3
0.2    36    2
0.1    19    4
0.5    20    3
```

Sample Output Files

- Estimation and goodness of fit output files are tab delimited to easy creating tables in excel. Following are examples of output files, and excel tables where applicable.

“start_statistics_[session name].txt”, “end_statistics_[session name].txt” and “sample_statistics_[session name].txt”

```
vertices 14
matrix
0 0 0 0 0 0 0 0 0 0 0 0 0 0
0 0 0 0 0 0 0 0 0 0 0 0 0 0
0 0 0 0 1 0 0 0 0 0 1 1 0 0
0 0 0 0 1 1 0 0 0 0 0 1 0 0
0 0 0 1 0 0 0 0 0 0 0 0 0 0
0 0 1 0 1 0 0 1 0 0 0 0 0 0
0 0 0 0 1 0 0 0 0 0 0 0 0 0
0 0 0 0 1 0 0 0 1 1 1 0 0 0
0 0 0 0 0 0 0 0 0 0 0 0 0 1
0 0 0 0 0 0 0 1 1 0 1 0 0 0
0 0 0 0 0 0 0 0 0 0 0 0 0 1
0 0 0 0 0 0 0 0 1 0 0 0 0 0
0 0 0 0 0 0 0 1 0 0 0 0 0 0
0 0 0 0 0 1 0 0 0 1 0 0 0 0
```

```
***This graph contains:****
vertices          14
arc              24
reciprocity      2
AinS(2.00)      17.62500
AoutS(2.00)     15.25000
AT-T(2.00)       6.50000
A2P-T(2.00)     40.50000
member_interaction      6
gender_interaction      2
member_sender          11
gender_sender           7
member_receiver        13
gender_receiver        12
```

Digraph Density = 0.13187

```
In-degree Distribution: (range[0..n-1])
4 2 4 3 0 1 0 0 0 0 0 0 0 0
Standard deviation of in-degree distribution = 1.435697
Skewness of in-degree distribution = 0.508356
Out-degree Distribution: (range[0..n-1])
2 6 1 4 1 0 0 0 0 0 0 0 0 0
Standard deviation of out-degree distribution = 1.220572
Skewness of out-degree distribution = 0.322264
Corr. Coef. between in and out degree distributions = 0.238744
```

Mean degree = 1.71429

Global Clustering Coefficients:

Cto = 0.18421
Cti = 0.15217
Ctm = 0.16279
Ccm = 0.20930
AKC-T = 0.16049
AKC-D = 0.20000
AKC-U = 0.13953
AKC-C = 0.20988

Geodesic Distribution: (range[1..n-1,inf])

Note: geodesic = shortest path between two nodes.
The geodesic distribution is not based on semi-paths.
24 32 29 20 5 0 0 0 0 0 0 0 0 0 72

Quartiles of the geodesic distribution.

Note: Quartiles equal to the number of nodes refer to infinite geodesics.
2 4 14 14

Triad Census:

300 0
210 0
120C 1
120D 0
120U 2
201 0
111D 6
111U 2
030T 2
030C 2
102 13
021D 10
021C 20
021U 12
012 130
003 164

“simulation_[session name].txt”

```
id arc recip in2star out2star in3star out3star uktri
1000 16 3 6 5 0 0 0.00
2000 12 1 3 4 0 1 2.00
3000 14 1 5 3 1 0 1.00
4000 14 2 3 2 0 0 0.00
5000 15 2 4 4 0 0 3.00
6000 15 1 4 3 1 0 1.00
...
...
...
97000 18 2 6 7 0 1 3.00
98000 13 1 2 1 0 0 0.00
99000 17 1 4 5 0 0 0.00
100000 19 4 5 6 0 0 1.00
```

“parameter_[session name].txt”

Simulation result for digraph with 14 of vertices.

Parameter Values of:

arc -1.50000
reciprocity 1.20000
2-in-star -1.30000
2-out-star -1.20000
3-in-star -1.10000
3-out-star -1.30000
AT-U(2.00) 1.50000

Proposed 1000000 digraphs.

Samples are picked up at 1 per 1000 digraphs.

Accepted 127343 proposed digraphs.

“estimation_[session name].txt”

STOCHASTIC ESTIMATION FOR NETWORK example

ESTIMATION SETTINGS

Number of sub-phases in estimation (phase 2) = 5

starting a-value in estimation (phase 2) = 0.010000

Multiplication factor for estimation (phase 2) = 10

Number of steps in final simulation (phase 3) = 500

Number of estimation runs = 10

STOCHASTIC APPROXIMATION RUN 1

original statistics:24.000000 2.000000 17.625000 15.250000 6.500000
40.500000

starting parameters:-2.902123 0.200148 0.546233 -0.013692 -0.046386
0.143345

Phase1 started with the following setup:

a = 0.010000

num of steps = 25

num of iterations in each step = 224.378698

mean statistics in phase1:22.880000 1.760000 16.556250 14.147500

5.880000 37.625000

END PHASE1 parameter:-2.902123 0.200148 0.546233 -0.013692 -0.046386

0.143345

Phase 2 started

Subphase 0 started with a valued 0.010000

Subphase 0 has gone up to 213 steps

Parameter after Subphase 0:-2.90351 0.33987 0.55254 -0.01341 -0.03369
0.12749

Subphase 1 started with a valued 0.010000

Subphase 1 has gone up to 233 steps

Parameter after Subphase 1:-2.86694 0.26247 0.54200 -0.01491 -0.04047
0.12810

Subphase 2 started with a valued 0.005000

...

Subphase 4 started with a valued 0.001250

Subphase 4 has gone up to 725 steps

Parameter after Subphase 4:-2.90684 0.20529 0.55291 -0.00977 -0.04367
0.14037

END PHASE2 parameter:-2.906837 0.205294 0.552914 -0.009773 -0.043674
0.140375

Phase3 started with the following setup:

num of steps = 500

num of iterations in each step = 224.378698

mean statistics in phase3:24.616000 2.096000 18.135141 15.876000
6.834750 42.064875

Estimation Result for Network SUMMARY (parameter, standard error, t-
statistics)

NOTE: t-statistics = (observation - sample mean)/standard error

effects	estimates	stderr	t-ratio	
arc	-2.906837	0.98133	-0.08919	*
reciprocity	0.205294	0.81794	-0.05820	
AinS(2.00)	0.552914	0.52603	-0.06192	
AoutS(2.00)	-0.009773	0.59406	-0.07868	
AT-T(2.00)	-0.043674	0.51150	-0.06069	
A2P-T(2.00)	0.140375	0.19825	-0.07173	

Estimated Covariance Matrix

0.963005	-0.009254	-0.318091	-0.384405	0.264326	-0.107297
-0.009254	0.669034	-0.027916	-0.058325	0.007124	-0.001399
-0.318091	-0.027916	0.276712	0.073059	-0.151908	0.009170
-0.384405	-0.058325	0.073059	0.352912	-0.136727	0.002928
0.264326	0.007124	-0.151908	-0.136727	0.261629	-0.038435
-0.107297	-0.001399	0.009170	0.002928	-0.038435	0.039304

effects	estimates	stderr	t-ratio	
arc	-2.906837	0.98133	-0.08919	*
reciprocity	0.205294	0.81794	-0.0582	
AinS(2.00)	0.552914	0.52603	-0.06192	
AoutS(2.00)	-0.009773	0.59406	-0.07868	
AT-T(2.00)	-0.043674	0.5115	-0.06069	
A2P-T(2.00)	0.140375	0.19825	-0.07173	

“covariance_[session name].txt”

0.963005	-0.009254	-0.318091	-0.384405	0.264326	-0.107297
-0.009254	0.669034	-0.027916	-0.058325	0.007124	-0.001399
-0.318091	-0.027916	0.276712	0.073059	-0.151908	0.009170
-0.384405	-0.058325	0.073059	0.352912	-0.136727	0.002928
0.264326	0.007124	-0.151908	-0.136727	0.261629	-0.038435
-0.107297	-0.001399	0.009170	0.002928	-0.038435	0.039304

“gof_[session name].txt”

GOODNESS OF FIT

Parameter Values:

arc -1.19735
reciprocity 0.28248
2-in-star 0.00000
...
Isolates 0.00000
AinS(2.00) 0.61944
AoutS(2.00) -0.92446
AinS(2.00) 0.00000
...
K-L-star(2.00) 0.00000
AT-T(2.00) -0.02294
...
AT-TDU(2.00) 0.00000
A2P-T(2.00) 0.21751
A2P-D(2.00) 0.00000
...
A2P-TDU(2.00) 0.00000
member_interaction 0.39270
gender_interaction -1.01727
member_sender -1.12695
gender_sender -1.33001
member_receiver -0.18683
gender_receiver 0.49272

...
gender_out2star 0.00000
Simulated 1000000 digraphs.
Statistic samples are picked up at 1 per 1000 digraphs.
Accepted 262407 proposed digraphs.

observation, sample mean (standard error), t-statistic
t-statistics = (observation - sample mean)/standard deviation

effects	observed	mean	stddev	t-ratio
arc 24	24.135	4.888	0.028	
reciprocity 2	2.063	1.467	-0.043	
2-in-star 23	23.997	9.764	-0.102	
2-out-star 19	20.436	9.849	-0.146	
3-in-star 13	15.866	12.423	-0.231	
3-out-star 8	12.216	11.910	-0.354	
path2 43	43.605	18.853	-0.032	
T1 0	0.014	0.133	-0.105	
T2 0	0.357	1.109	-0.322	
T3 1	1.535	2.261	-0.237	
T4 0	0.819	1.266	-0.647	
T5 2	0.687	1.231	1.067	
T6 0	0.918	1.694	-0.542	
T7 7	9.042	8.190	-0.249	
T8 7	7.819	7.847	-0.104	
T9(030T) 7	7.216	5.313	-0.041	
T10(030C) 3	2.416	2.082	0.280	
Sink 0	1.430	1.101	-1.299	

Source	2	2.742	1.311	-0.566					
Isolates	2	0.685	0.824	1.596					
AinS(2.00)	17.625		17.646		5.961	-0.004			
AoutS(2.00)	15.250		15.500		6.049	-0.041			
AinS(2.00)	17.625		17.646		5.961	-0.004			
AoutS(2.00)	15.250		15.500		6.049	-0.041			
K-1-star(2.00)	30.125		27.346		9.801	0.284			
1-L-star(2.00)	30.500		28.742		9.674	0.182			
K-L-star(2.00)	20.750		18.188		5.091	0.503			
AT-T(2.00)	6.500	6.737	4.665	-0.051					
AT-C(2.00)	8.500	6.736	5.469	0.323					
AT-D(2.00)	7.000	6.656	4.608	0.075					
AT-U(2.00)	6.000	6.678	4.577	-0.148					
AT-TD(2.00)	6.750	6.697	4.627	0.012					
AT-TU(2.00)	6.250	6.708	4.612	-0.099					
AT-DU(2.00)	6.500	6.667	4.579	-0.036					
AT-TDU(2.00)	6.500	6.690	4.602	-0.041					
A2P-T(2.00)	40.500		41.202		16.830		-0.042		
A2P-D(2.00)	17.500		18.975		8.679	-0.170			
A2P-U(2.00)	21.500		22.538		8.644	-0.120			
A2P-TD(2.00)	29.000		30.089		12.376		-0.088		
A2P-TU(2.00)	31.000		31.870		12.187		-0.071		
A2P-DU(2.00)	19.500		20.756		7.982	-0.157			
A2P-TDU(2.00)	26.500		27.572		10.689		-0.100		
member_interaction	6		5.895	2.458	0.043				
gender_interaction	2		1.993	1.417	0.005				
member_sender	11	10.940			2.902	0.021			
gender_sender	7	7.055	2.243	-0.025					
member_receiver	13	12.828			3.821	0.045			
gender_receiver	12	12.135			3.445	-0.039			
member_interaction_reciprocity	1				0.393	0.655	0.927		
gender_interaction_reciprocity	0				0.060	0.242	-0.248		
member_activity_reciprocity	2				1.295	1.139	0.619		
gender_activity_reciprocity	1				1.346	1.107	-0.313		
member_in2star	15	11.970			7.073	0.428			
gender_in2star	16	11.759			6.633	0.639			
member_path2	18	17.830			10.092		0.017		
gender_path2	13	12.390			6.845	0.089			
member_out2star	7	6.453	4.351	0.126					
gender_out2star	3	2.338	2.058	0.322					
Std Dev in-degree dist	1.436	1.408	0.275	0.100					
Skew in-degree dist	0.508	0.555	0.490	-0.094					
Std Dev out-degree dist	1.221	1.215	0.270	0.019					
Skew out-degree dist	0.322	0.600	0.528	-0.526					
CorrCoef in-out-degree dists	0.239	0.163	0.293	0.258					
Global Clustering Cto	0.184	0.166	0.079	0.233					
Global Clustering Cti	0.152	0.138	0.066	0.219					
Global Clustering Ctm	0.163	0.152	0.072	0.144					
Global Clustering Ccm	0.209	0.147	0.096	0.643					
Global Clustering AKC-T	0.160	0.152	0.070	0.124					
Global Clustering AKC-D	0.200	0.166	0.077	0.441					
Global Clustering AKC-U	0.140	0.137	0.064	0.036					
Global Clustering AKC-C	0.210	0.146	0.093	0.683					

ACCEPTANCE RATE: 0.2624

SAMPLE GEODESIC DISTRIBUTION

Note: geodesic = shortest path between two nodes.
 The geodesic distribution is not based on semi-paths.

FIRST QUANTILES

Median of sample G25s: 2
 Interquartile range: 1
 Observed first quartile geodesic: 2
 in model samples, 0.00% of graphs have lower G25.
 in model samples, 27.50% of graphs have higher G25.

SECOND QUANTILES

Median of sample G50s: 4
 Interquartile range: 11
 Observed median geodesic: 4
 in model samples, 36.80% of graphs have lower G50.
 in model samples, 48.40% of graphs have higher G50.

THIRD QUANTILES

Median of sample G75s: 14
 Interquartile range: 0
 Observed first quartile geodesic: 14
 in model samples, 14.00% of graphs have lower G75.
 in model samples, 0.00% of graphs have higher G75.

GOF on Triad Census

Triad	observed	mean	stddev	t-ratio
300	0	0.014	0.133	-0.105
210	0	0.273	0.636	-0.429
120C	1	0.905	1.138	0.083
120D	0	0.504	0.800	-0.630
120U	2	0.372	0.693	2.350
201	0	0.603	1.198	-0.503
111D	6	5.020	3.855	0.254
111U	2	4.061	3.415	-0.603
030T	2	3.656	2.788	-0.594
030C	2	1.210	1.327	0.596
102	13	12.100	8.607	0.105
021D	10	9.375	4.749	0.132
021C	20	20.389	8.096	-0.048
021U	12	11.845	4.778	0.032
012	130	129.376	16.257	0.038
003	164	164.297	29.134	-0.010

Mahalanobis distance =7.168743 (51.390873)

50% simulated samples have smaller Mahalanobis distances than the observed network.

effects	observed	mean	stddev	t-ratio
arc	24	24.135	4.888	-0.028
reciprocity	2	2.063	1.467	-0.043
2-in-star	23	23.997	9.764	-0.102
2-out-star	19	20.436	9.849	-0.146
3-in-star	13	15.866	12.423	-0.231







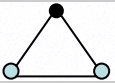

3-out-star	8	12.216	11.91	-0.354
path2	43	43.605	18.853	-0.032
T1	0	0.014	0.133	-0.105
T2	0	0.357	1.109	-0.322
T3	1	1.535	2.261	-0.237
T4	0	0.819	1.266	-0.647
T5	2	0.687	1.231	1.067
T6	0	0.918	1.694	-0.542
T7	7	9.042	8.19	-0.249
T8	7	7.819	7.847	-0.104
T9 (030T)	7	7.216	5.313	-0.041
T10 (030C)	3	2.416	2.082	0.28
Sink	0	1.43	1.101	-1.299
Source	2	2.742	1.311	-0.566
Isolates	2	0.685	0.824	1.596
AinS (2.00)	17.625	17.646	5.961	-0.004
AoutS (2.00)	15.25	15.5	6.049	-0.041
AinS (2.00)	17.625	17.646	5.961	-0.004
AoutS (2.00)	15.25	15.5	6.049	-0.041
K-1-star (2.00)	30.125	27.346	9.801	0.284
1-L-star (2.00)	30.5	28.742	9.674	0.182
K-L-star (2.00)	20.75	18.188	5.091	0.503
AT-T (2.00)	6.5	6.737	4.665	-0.051
AT-C (2.00)	8.5	6.736	5.469	0.323
AT-D (2.00)	7	6.656	4.608	0.075
AT-U (2.00)	6	6.678	4.577	-0.148
AT-TD (2.00)	6.75	6.697	4.627	0.012
AT-TU (2.00)	6.25	6.708	4.612	-0.099
AT-DU (2.00)	6.5	6.667	4.579	-0.036
AT-TDU (2.00)	6.5	6.69	4.602	-0.041
A2P-T (2.00)	40.5	41.202	16.83	-0.042
A2P-D (2.00)	17.5	18.975	8.679	-0.17
A2P-U (2.00)	21.5	22.538	8.644	-0.12
A2P-TD (2.00)	29	30.089	12.376	-0.088
A2P-TU (2.00)	31	31.87	12.187	-0.071
A2P-DU (2.00)	19.5	20.756	7.982	-0.157
A2P-TDU (2.00)	26.5	27.572	10.689	-0.1
member_interaction	6	5.895	2.458	0.043
gender_interaction	2	1.993	1.417	0.005
member_sender	11	10.94	2.902	0.021
gender_sender	7	7.055	2.243	-0.025
member_receiver	13	12.828	3.821	0.045
gender_receiver	12	12.135	3.445	-0.039
member_interaction_reciprocity	1	0.393	0.655	0.927
gender_interaction_reciprocity	0	0.06	0.242	-0.248
member_activity_reciprocity	2	1.295	1.139	0.619

gender_activity_reciprocity	1	1.346	1.107	-0.313
member_in2star	15	11.97	7.073	0.428
gender_in2star	16	11.759	6.633	0.639
member_path2	18	17.83	10.092	0.017
gender_path2	13	12.39	6.845	0.089
member_out2star	7	6.453	4.351	0.126
gender_out2star	3	2.338	2.058	0.322
Std Dev in-degree dist	1.436	1.408	0.275	0.1
Skew in-degree dist	0.508	0.555	0.49	-0.094
Std Dev out-degree dist	1.221	1.215	0.27	0.019
Skew out-degree dist	0.322	0.6	0.528	-0.526
CorrCoef in-out-degree dists	0.239	0.163	0.293	0.258
Global Clustering Cto	0.184	0.166	0.079	0.233
Global Clustering Cti	0.152	0.138	0.066	0.219
Global Clustering Ctm	0.163	0.152	0.072	0.144
Global Clustering Ccm	0.209	0.147	0.096	0.643
Global Clustering AKC-T	0.16	0.152	0.07	0.124
Global Clustering AKC-D	0.2	0.166	0.077	0.441
Global Clustering AKC-U	0.14	0.137	0.064	0.036
Global Clustering AKC-C	0.21	0.146	0.093	0.683

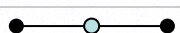
Appendix B – Model Parameter Description

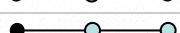
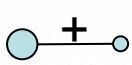
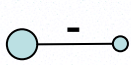
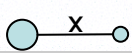
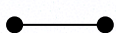

Non-directed Graphs

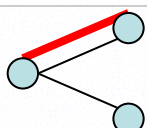
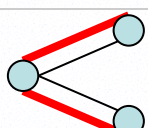
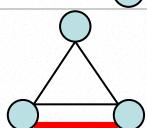
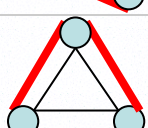
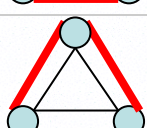
Parameters Without Actor Attributes			
Edge (L)		Isolate	
2-Star (S ₂)		3-Star (S ₃)	
Triangle (T ₁)		Alt-Triangle (AT)	
Alt-Star (AS)		Alt-2-Path (A2P)	
2-Triangle (T ₂)		Bow-Tie	
3-Path		4-Cycle	
1-Edge-Triangle (1-ET)		2-Edge-Triangle (2-ET)	
Alt-Edge-Triangle (AET)			
4-Clique		5-Clique	
6-Clique		7-Clique	
Alt-Clique (AC)			
Parameters with Actor Attributes			
<ul style="list-style-type: none"> ● – actors with attribute ○ – actors with or without attribute [Attr] – attribute name 			
[Attr]-interaction		[Attr]-activity	
[Attr]-T3u		[Attr]-T2u	

[Attr]-T1u			
[Attr]-O3u			
[Attr]-O2au		[Attr]-O2bu	
[Attr]-O1au		[Attr]-O1bu	
Parameters for Continuous Attributes			
[Attr]-Sum		[Attr]-difference ¹	
[Attr]-interaction			
Parameters for Categorical Attributes			
[Attr]-Matching		[Attr]-Mismatch	
Parameters for Dyadic Attributes			
Dyadic covariate 			
[Attr]-Edge		[Attr]-S21	
[Attr]-S22		[Attr]-T1	
[Attr]-T2		[Attr]-T3	

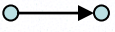
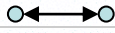
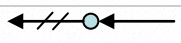
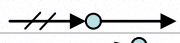
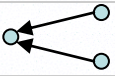
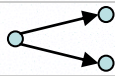
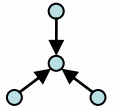
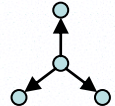
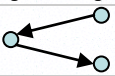
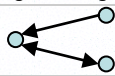
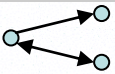
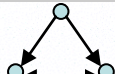
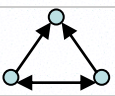
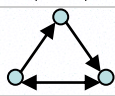
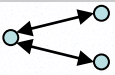

¹ Absolute difference between two actor attributes

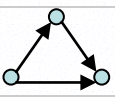
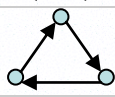
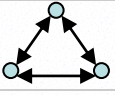
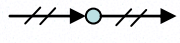
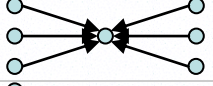
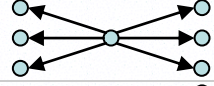
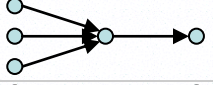
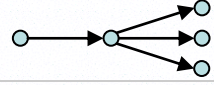
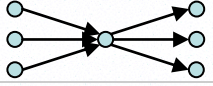
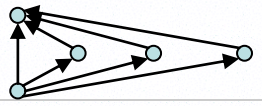
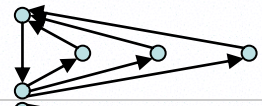
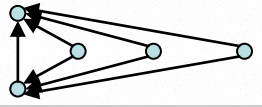
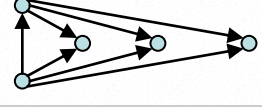
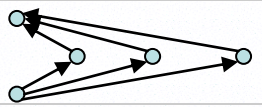
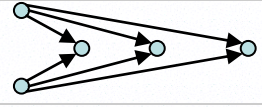
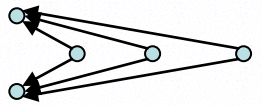



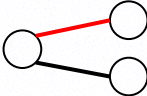
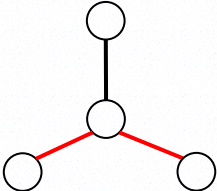
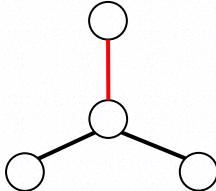
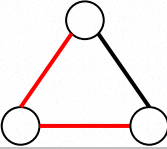
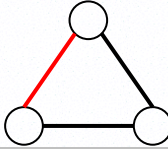
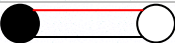
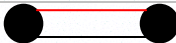
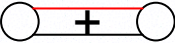
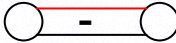
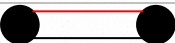
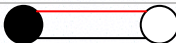

Directed Graphs

Parameters Without Actor Attributes			
Arc		Reciprocity	
sink		source	
In-2-star		Out-2-star	
In-3-star		Out-3-star	
2-path		T ₇	
T ₈		T ₄	
T ₅		T ₃	
T ₆		T ₂	
Transitive Triad (T ₉)		Cyclic Triad (T ₁₀)	
T ₁		isolate	
Alt-in-star (AinS)		Alt-out-star (AoutS)	
Alt-in-1-out-star (Ain1outS)		1-in-alt-out-star (1inAoutS)	
Alt-in-alt-out-star (AinAoutS)			
AT-T		AT-C	
AT-D		AT-U	
A2P-T		A2P-U	
A2P-D			

Parameters with Actor Attributes			
<ul style="list-style-type: none"> ● – actors with attribute ○ – actors with or without attribute [Attr] – attribute name 			
[Attr]-Interaction			
[Attr]-Sender		[Attr]-Sender-missing	
[Attr]-Receiver		[Attr]-Receiver-missing	
[Attr]-Interaction-reciprocity		[Attr]-Activity-reciprocity	
[Attr]-in-2-star		[Attr]-2-path	
[Attr]-out-2-star			
Parameters for Continuous Attributes			
[Attr]-Sender		[Attr]-Receiver	
[Attr]-Sender-missing		[Attr]-Receiver-missing	
[Attr]-Sum		[Attr]-Difference	
[Attr]-Product		[Attr]-Sum-reciprocity	
[Attr]-Difference-reciprocity		[Attr]-Product-reciprocity	
[Attr]-in-2-star		[Attr]-2-path	
[Attr]-out-2-star			
Parameters for Categorical Attributes			
[Attr]-Matching		[Attr]-Mismatch	
[Attr]-Matching-reciprocity		[Attr]-Mismatch-reciprocity	
Parameters for Dyadic Attributes			
Dyadic covariate			
[Attr]-Arc			

XPNet Graph Statistics

Parameters for two nondirected networks (A and B)			
Network A		Network B	
EdgeAB		2-StarAB	
3-Star-AAB		3-Star-ABB	
TriangleAAB		TriangleABB	
Binary Attributes			
Rab		Rbab	
Continuous Attributes			
SumAB		DifferenceAB	
Categorical attributes			
Same-category-AB		Diff- category -AB	

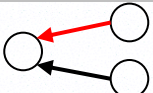
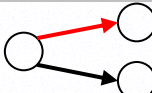
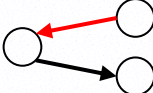
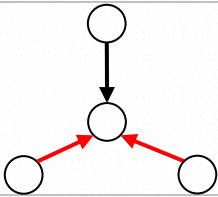
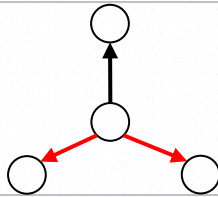
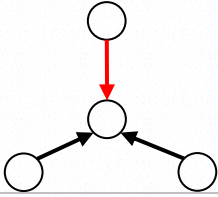
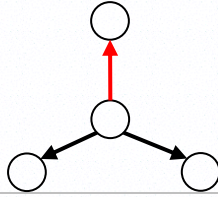
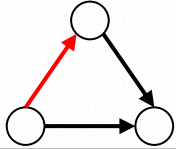
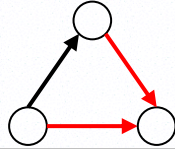
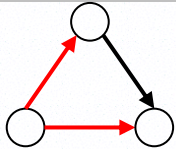
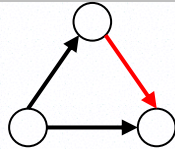
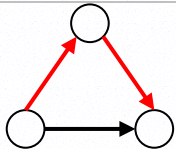
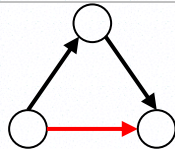
Parameters for two directed networks (A and B)			
Network A		Network B	
ArcAB		ReciprocityAB	
ReciprocityAAB		ReciprocityABB	
ReciprocityAABB			
In-2-StarAB		Out-2-StarAB	
Mixed-2-StarAB			
In-3-Star-AAB		Out-3-Star-AAB	
In-3-Star-ABB		Out-3-Star-ABB	
T-ABB		T-BAA	
T-AAB		T-BBA	
T-ABA		T-BAB	

C-AAB		C-ABB	
-------	--	-------	--

Binary Attributes

Mrs		Mrr	
Mrb			
Mrbm		Mrm	



Continuous Attributes

Msum		Mdiff	
Msumm		Mdiffm	

Categorical attributes

Same-cate-arcAB		Diff-cate-arcAB	
Same-cate-reciAB		Diff-cate-reciAB	

BPNet Graph Statistics

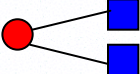
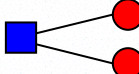
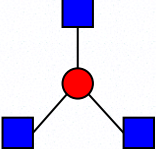
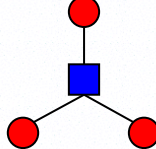
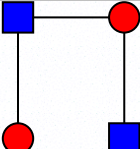
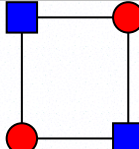
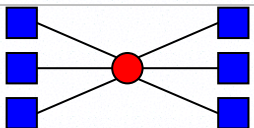
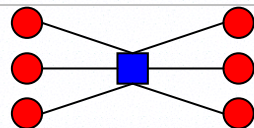
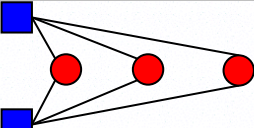
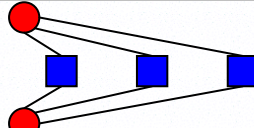
Set-P			
Set-A			
L			
Sp2		Sa2	
Sp3		Sa3	
L3		C4	
K-Sp		K-Sa	
K-Cp		K-Ca	

Binary Attributes

- – actors with attribute
- – actors with or without attribute
- [Attr] – attribute name

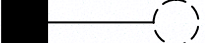
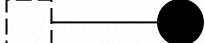
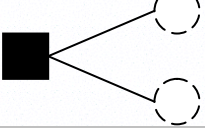
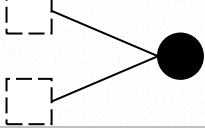
[Attr]_RA		[Attr]_RP	
[Attr]_TSCA		[Attr]_TSCP	

[Attr]_TSOA1		[Attr]_TSOP1	
[Attr]_TSOA2		[Attr]_TSOP2	
[Attr]_C4A1		[Attr]_C4P1	
[Attr]_C4A2		[Attr]_C4P2	
[Attr]_rAP			

Continuous Attributes			
[Attr]_RAC		[Attr]_RPC	
[Attr]_TSCAC		[Attr]_TSCPC	
[Attr]_TSOACS		[Attr]_TSOPCS	
[Attr]_TSOACD		[Attr]_TSOPCD	

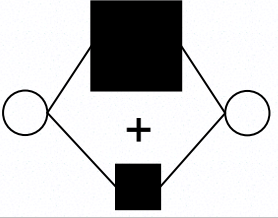
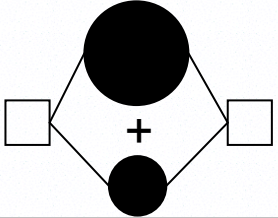
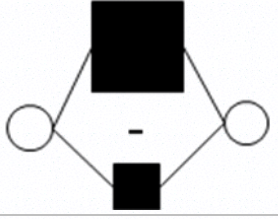
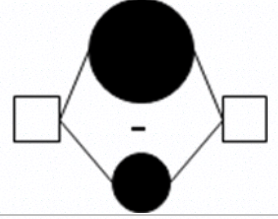
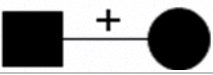
[Attr]_C4ACS		[Attr]_C4PCS	
[Attr]_C4ACD		[Attr]_C4PCD	
[Attr]_RAPC			

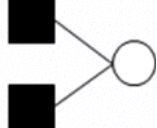
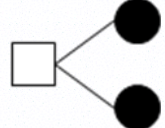
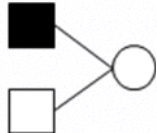
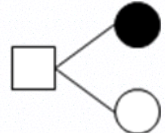
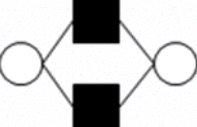
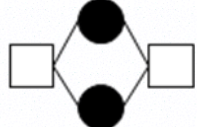
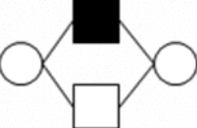
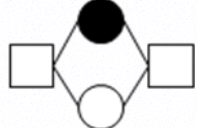
Categorical Attributes			
[Attr]_2path_match_A		[Attr]_2path_match_P	
[Attr]_2path_mismatch_A		[Attr]_2path_mismatch_P	
[Attr]_4cycle_match_A		[Attr]_4cycle_match_P	
[Attr]_4cycle_mismatch_A		[Attr]_4cycle_mismatch_P	

IPNet Graph Statistics

<p>● Denotes actors with attribute. ○ Denotes actors with or without attribute.</p>			
Attribute Density		Activity	
Star2		Star3	
Contagion		Two-Path-Equivalence	
Partner-Activity		Partner-Resource	
T1		T2	
T3			
Setting matrix			
Setting-Homophily			
Distance matrix			
Remoteness		Geographic-Homophily	
Remoteness-to-partners		Contagion-among-partners	
Parameters for Binary Attributes			
oOb		o_Ob	
Parameters for Continuous Attributes			
oOc		o_Oc	

Parameters for Categorical Attributes

oO_Osame		oO_Odiff	
----------	---	----------	---