

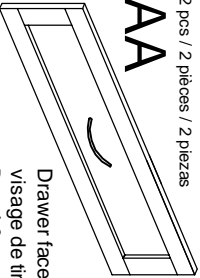
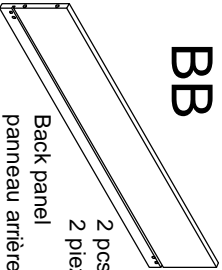
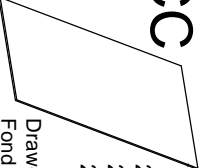
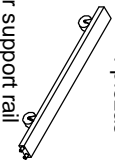
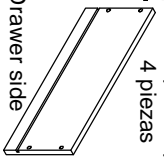
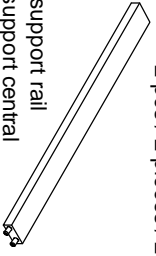

Hardware List

Quincaillerie

Lista de piezas

<p>2 pcs / 2 pièces / 2 piezas</p> <p>AA</p>  <p>Drawer face visage de tiroir Panel frontal de cajón</p>	<p>2 pcs / 2 pièces / 2 piezas</p> <p>BB</p>  <p>Back panel panneau arrière Panel trasero</p>	<p>2 pcs / 2 pièces / 2 piezas</p> <p>CC</p>  <p>Drawer bottom Fond de tiroir Fondo del cajón</p>	<p>4 pcs / 4 pièces / 4 piezas</p> <p>DD</p>  <p>Caster support rail rail de support Riel de soporte con ruedas</p>	<p>4 pcs / 4 pièces / 4 piezas</p> <p>EE</p>  <p>L & R Drawer side côté du tiroir gauche and droit Placa lateral Y D del cajón</p>	<p>2 pcs / 2 pièces / 2 piezas</p> <p>FF</p>  <p>Middle support rail rail de support central Soporte intermedio</p>
<p>3 16 pcs / 16 pièces / 16 piezas</p> <p>Allen head bolt M6 x 35 mm Boulon à tête Allen M6 x 35 mm Perno hexagonal M6 x 35 mm</p> 					
<p>7</p> <p>Allen key Clé Allen Llave Allen</p> 					

RYAN STORAGE ASSEMBLY INSTRUCTIONS
RYAN TIROIS DE RANGEMENT INSTRUCTIONS D'ASSEMBLAGE
INSTRUCCIONES DE ARMADO DE CAJÓN DE ALMACENAMIENTO RYAN

Step 1 / Étape 1 / Paso 1

Step 2 / Étape 2 / Paso 2

Step 3 / Étape 3 / Paso 3

caramia
furniture

RYAN STORAGE ASSEMBLY INSTRUCTIONS
RYAN TIROIS DE RANGEMENT INSTRUCTIONS D'ASSEMBLAGE
INSTRUCCIONES DE ARMADO DE CAJÓN DE ALMACENAMIENTO RYAN

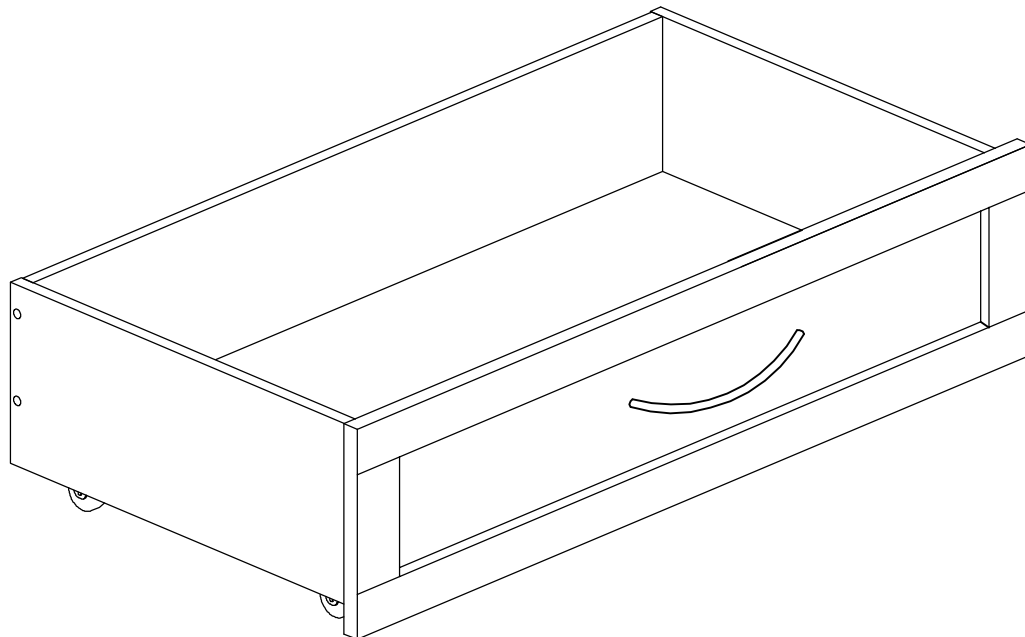

CARAMIA FURNITURE 1 Woodslea Road, Brampton
Ontario Canada L6T 5P2, phone/téléphone :, fax/télécopieur :

Toll Free / Sans frais :

www.caramiafurniture.com