

ESL3881GR-A

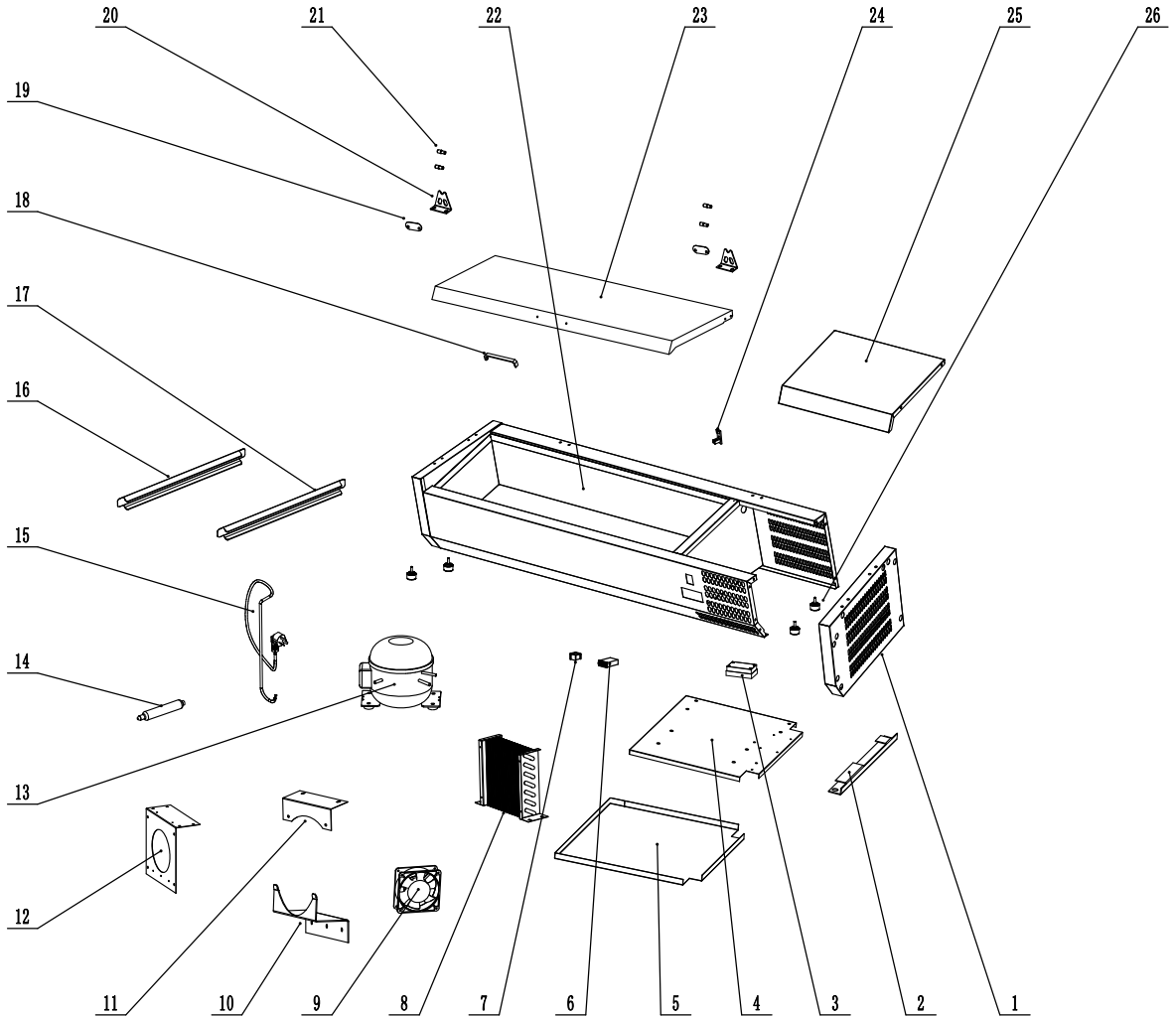

NO	NAME	ENGLISH NAME	CODE	MATERIAL	QTY	UNIT PRICE (USD)
1	比萨台右侧板	Right Plate	3861010	0.7/SUS304/417X295	1	
2	比萨台右侧板衬档	Right Plate Support	3861012	1.5/镀锌板/279X58	1	
3	接线盒	Wire Box	W0309001	220V50HZ冷藏单点	1	
4	比萨台机器底板	Bottom Plate	3861004	1.0/镀锌板/296X316	1	
5	比萨台右下板	Right Bottom Plate	3861015	0.7/SUS304/324X305	1	
6	单点电子温控器	Digital Controller	W0302170	220V蓝屏压机30A/卡乐EZ系列	1	
7	防水船形开关	Power Switch	W0308001	AC16A/250V/4脚双刀单掷	1	
8	冷凝器	Condenser	W0203018	翅片式/2列7排	1	
9	12038风机	Fan Motor	W0301011	220V-50HZ/0.13A	1	
10	比萨台风机下支架	Bracket for Fan otor	3861073	0.8/镀锌板/130X93.3	1	
11	比萨台冷凝风机支架	Bracket for Fan otor	3861006	1.0/镀锌板/125X107	1	
12	比萨台冷凝风机风道板	Air Flow Plate	3861005	1.0/镀锌板/180X249	1	
13	R600a压缩机	Compressor	W0201160	R600a/220~240V50Hz	1	
14	干燥过滤器	Dry Filter	W0204101	Φ19X165/XH-9	1	
15	电源线	Power Cord	W0305114	法式插头16A/3X1.0mm/2600	1	
16	1200比萨台数盘调整搁档	Pilaster	3861043	0.6/SUS304/75X270	1	
17	1400比萨台数盘调整搁档	Pilaster	3861018	0.6/SUS304/60X270	4	
18	318金属小拉手	Handle	W0401100	安装孔距128mm	1	
19	上盖轴内衬片	Support Plate	38001030	1.0X40X18/SUS201	4	
20	上盖铰链	Hinge	38000104	2.0X60X43/SUS201	2	
21	上盖铰链轴	Hinge Axis	B0604109	%c6-M5长17/SUS304	4	
22	1200比萨台箱体组件	Cabinet Body		发泡箱体/1175X335X225	1	
23	1200比萨台不锈钢上盖	Lid	3861079	0.7X909X392.5/SUS304	1	
24	探头夹	Probe Clip	W0409818	注塑件	1	
25	比萨台机房顶盖	Canopy	3861003	0.7/SUS304/371X325.7	1	
26	调整脚	Leg	W0409004	塑料脚高30mm	4	