



**Dedacciai** 25 **ZERO / ZERO UNO**  
1992 - 2017





**Dedacciai was established in 1992  
with the aim of manufacturing state of  
the art steel tubing for bicycle frames.**



**Dedacciai**  
TECNOLOGIA DEI TUBI

DEDACCIAI S.R.L. - 20010 CAMPAGNOLA CREMASCA (CR) ITALY  
VIA LEONARDO DA VINCI, 19  
Tel. 0373/74499 - Fax 0373/750027  
[www.dedacciai.com](http://www.dedacciai.com)



Today's result of a more than quarter century of development and sport success is summarized in the current catalogue of high performance steel tubing.

Dedacciai frame tubing are available in two classes:

- **ZERO** class tubing, state of the art light tubing, for racing and high performances frames,
- **ZERO UNO** class tubing, designed and engineered for commuter and long range users.

All our steel tubing are seamless, manufactured in our plant in Italy, using EN-10305-1 25CrMo4 steel made in Europe.

To obtain the best results from the use of this class of products, please look carefully at the drawings, and read the advices at the end of this catalogue.

# Zero class top tubing

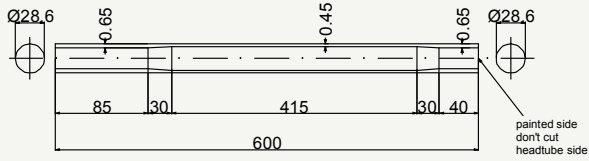

cod : MTO286A303

State	Weight	Use
HTS	196 g	Road

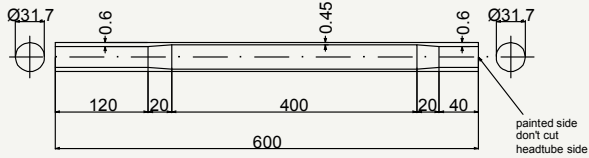

cod : MTO317A502

State	Weight	Use
HTS	230 g	Road - Cyclocross - MTB

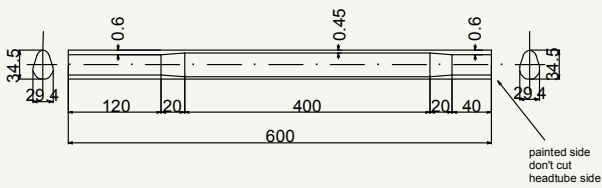

cod : MTO317A50240

State	Weight	Use
HTS	230 g	Road - Cyclocross - MTB

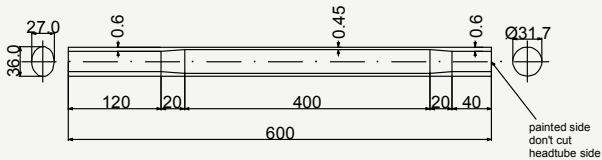

cod : MTO317A50230

State	Weight	Use
HTS	230 g	Road - Cyclocross - MTB

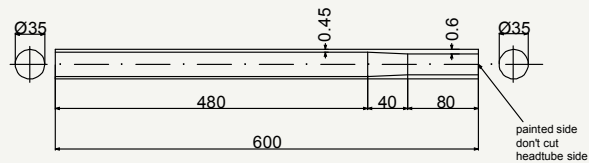

cod : MTO350K601

State	Weight	Use
HTS	256 g	Road

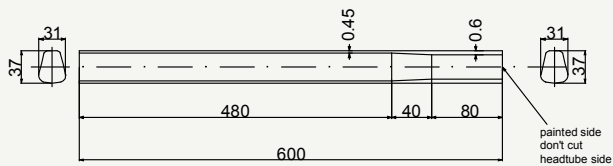

cod : MTO350K60111

State	Weight	Use
HTS	256 g	Road

# Zero class down tubing

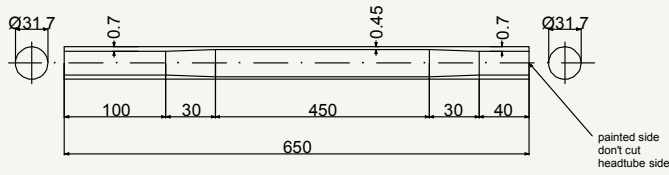

cod : MTQ317A503

State	Weight	Use
HTS	268 g	Road

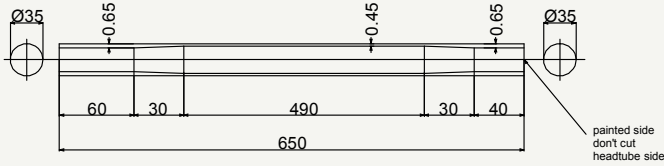

cod : MTQ350A702

State	Weight	Use
HTS	285 g	Road

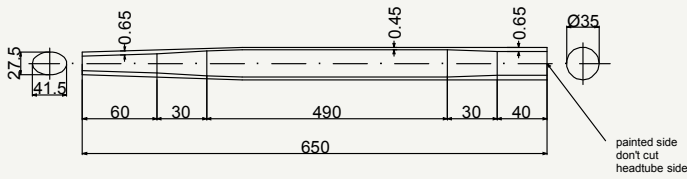

cod : MTQ350A705

State	Weight	Use
HTS	285 g	Road

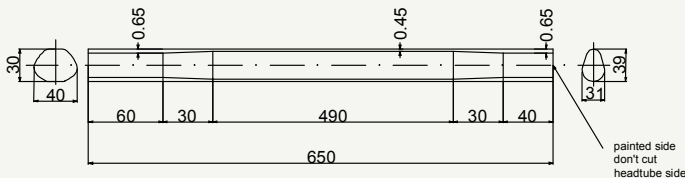

cod : MTQ350A70242

State	Weight	Use
HTS	285 g	Road

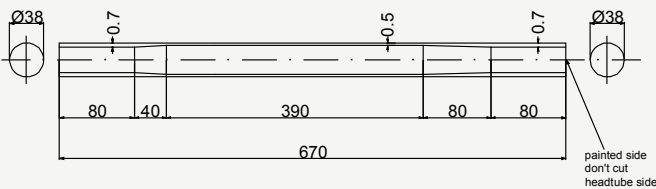

cod : MTQ380A801

State	Weight	Use
HTS	373 g	Road - Cyclocross - MTB

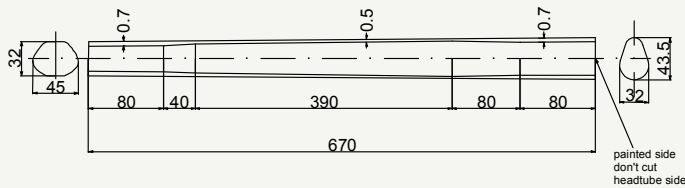

cod : MTQ380A80141

State	Weight	Use
HTS	373 g	Road - Cyclocross - MTB

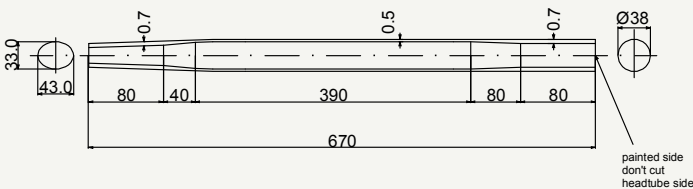

cod : MTQ380A805

State	Weight	Use
HTS	373 g	Road - Cyclocross - MTB

# Zero class down tubing

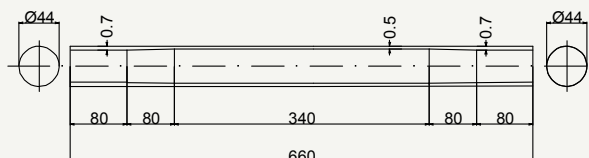

cod : MTQ440K902

State	Weight	Use
HTS	390 g	Road - Cyclocross - MTB

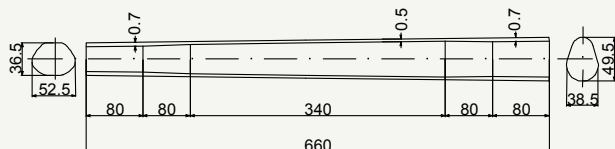

cod : MTQ440K901

State	Weight	Use
HTS	390 g	Road - Cyclocross - MTB

# Zero class seat tubing

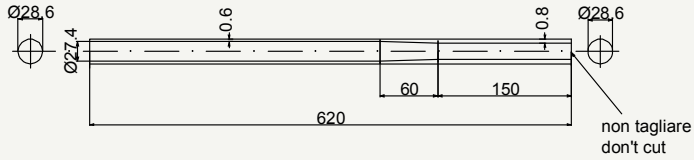

cod : MTV286A304

State	Weight	Use
HTS	297 g	Road

Aluminium sleeve to be glued

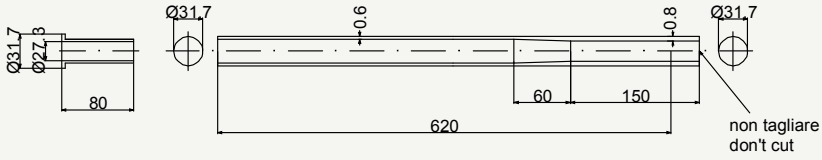

cod : MTV317B303

State	Weight	Use
BKS	346 g	Road

Aluminium sleeve to be glued

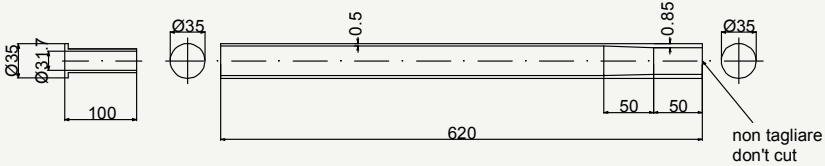

cod : MTV350A601

State	Weight	Use
BKS	365 g	Road

# Zero class chain stay

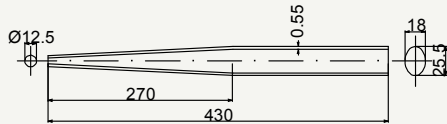

SIDE VIEW

cod : MPO222A303

State	Weight	Use
HTS	126 g	Road

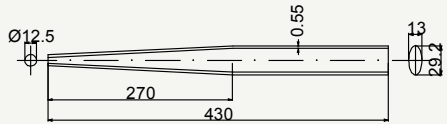

SIDE VIEW

cod : MPO222A102

State	Weight	Use
HTS	126 g	Road

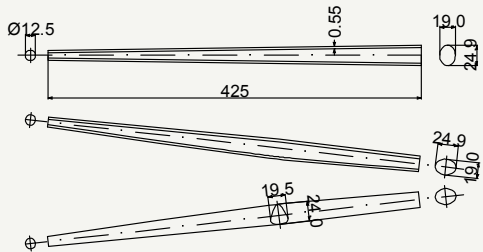

SIDE VIEW

cod : MPO222A101

State	Weight	Use
HTS	126 g	Road

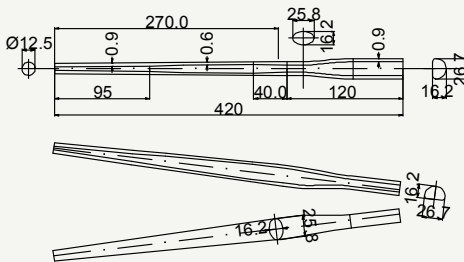

SIDE VIEW

cod : MPO222B104

State	Weight	Use
DSR	187 g	Road Disc Brake

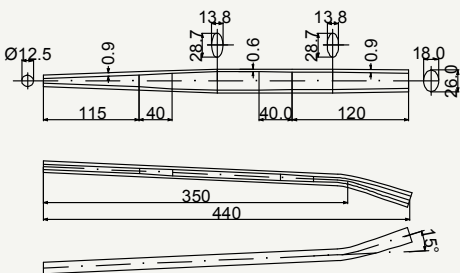

SIDE VIEW

cod : MPO222B106

State	Weight	Use
DSR	187 g	MTB

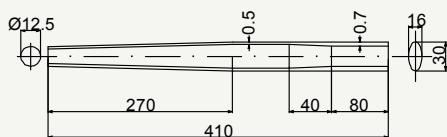

SIDE VIEW

cod : MPO240A203

State	Weight	Use
HTS	154 g	Road



# Zero class seat stay

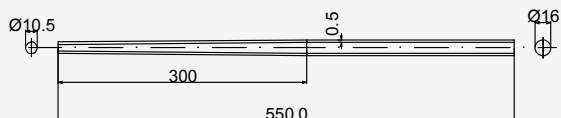

cod : MPV160B201

State	Weight	Use
DSR	104 g	Road

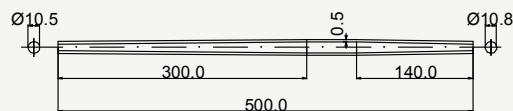

cod : MPV160B202

State	Weight	Use
DSR	93 g	Road

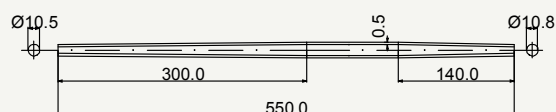

cod : MPV160B203

State	Weight	Use
DSR	102 g	Road

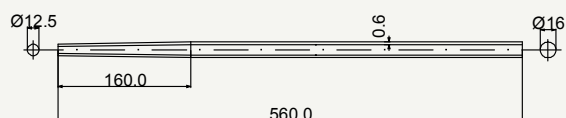

cod : MPV160B205

State	Weight	Use
DSR	105 g	Road



cod : MPV180A501

State	Weight	Use
DSR	116 g	Road

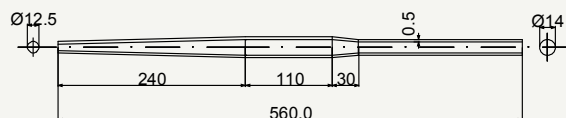

cod : MPV180A502

State	Weight	Use
DSR	110 g	Road

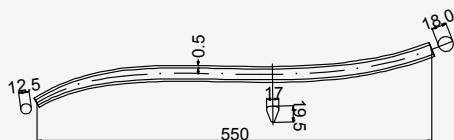

SIDE VIEW

cod : MPV180A505

State	Weight	Use
DSR	116 g	Road

# Zero class seat stay

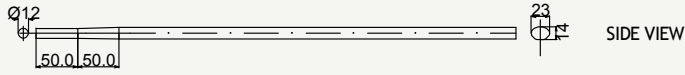

SIDE VIEW



TOP VIEW

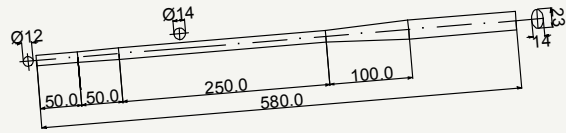

SIDE VIEW



SIDE VIEW



TOP VIEW

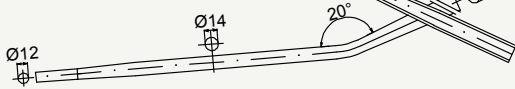

TOP VIEW

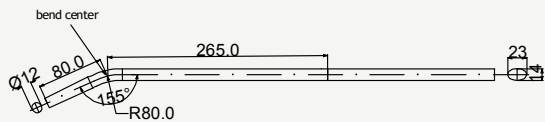

SIDE VIEW



TOP VIEW

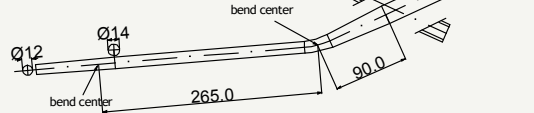

TOP VIEW

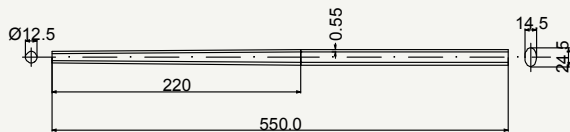

SIDE VIEW

cod : MPV180A508

State	Weight	Use
DSR	172 g	Road

cod : MPV180A507

State	Weight	Use
DSR	172 g	Road - MTB

cod : MPV180A506

State	Weight	Use
DSR	172 g	Road - MTB

cod : MPV200A701

State	Weight	Use
DSR	145 g	Road

# Zero Uno class top tubing

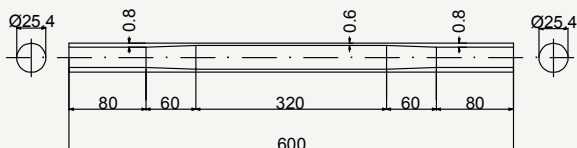

cod : MTO254C102

State	Weight	Use
BKS	242 g	Road

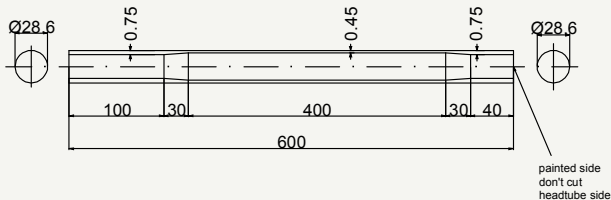

cod : MTO286B301

State	Weight	Use
BKS	247 g	Road

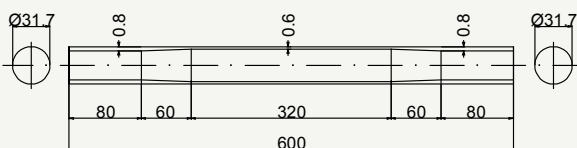

cod : MTO317C501

State	Weight	Use
BKS	338 g	Road - Cyclocross - MTB

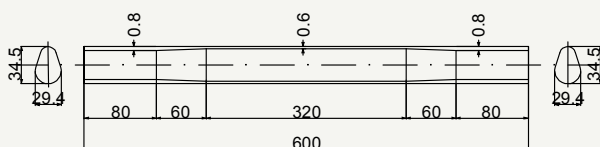

cod : MTO317C50140

State	Weight	Use
BKS	338 g	Road - Cyclocross - MTB

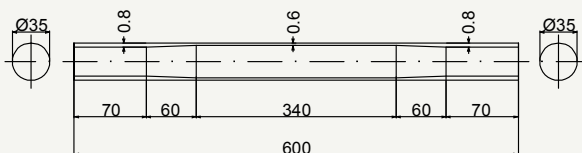

cod : MTO350B703

State	Weight	Use
BKS	365 g	Cyclocross - MTB

# Zero Uno class down tubing

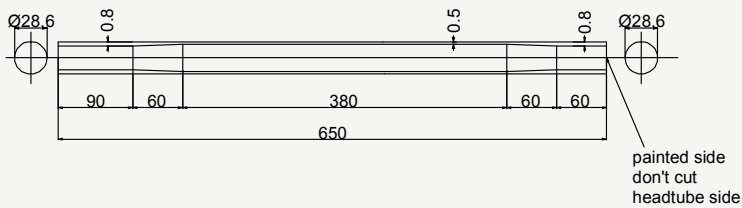

cod : MTQ286B301

State	Weight	Use
BKS	290 g	Road

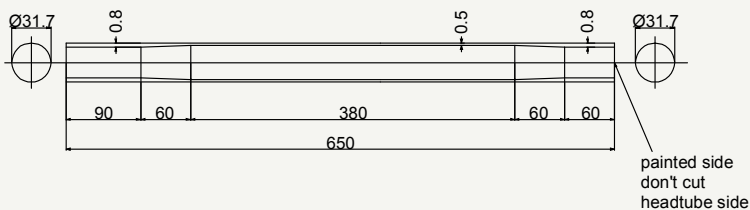

cod : MTQ317B501

State	Weight	Use
BKS	340 g	Road

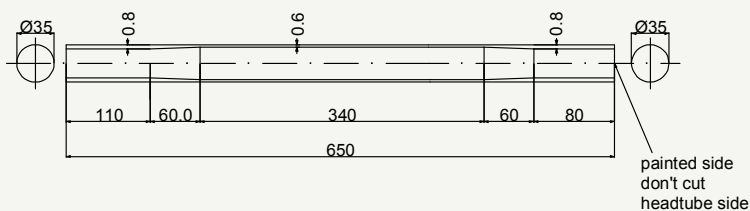

cod : MTQ350B703

State	Weight	Use
BKS	402 g	Road - Cyclocross - MTB

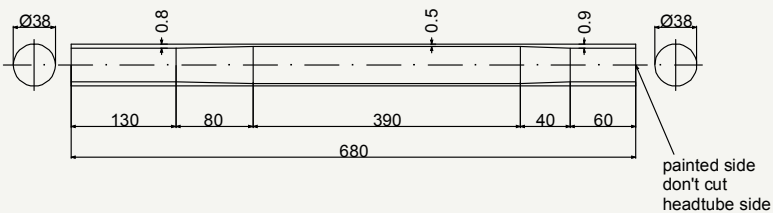

cod : MTQ380B802

State	Weight	Use
BKS	418 g	Road - Cyclocross - MTB

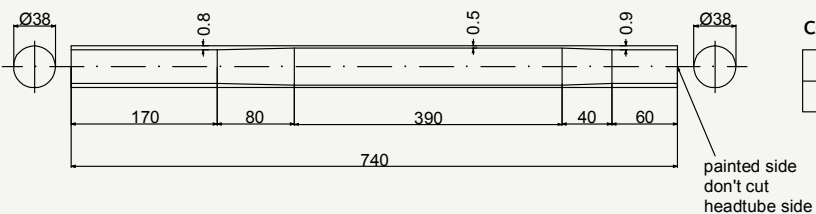

cod : MTQ380B803

State	Weight	Use
BKS	462 g	MTB 29"

# Zero Uno class seat tubing

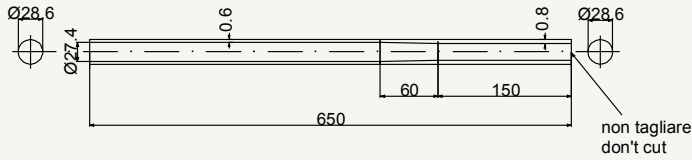

cod : MTV286B301

State	Weight	Use
BKS	312 g	Road

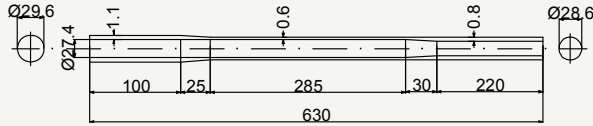

cod : MTV286B310

State	Weight	Use
BKS	333 g	Road - Cyclocross - MTB

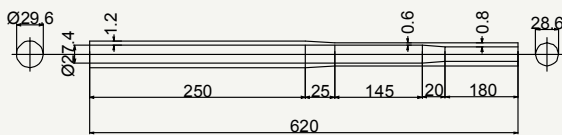

cod : MTV286B311

State	Weight	Use
BKS	393 g	Road Low Geometry

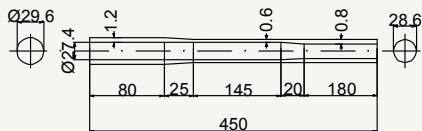

cod : MTV286C306

State	Weight	Use
BKS	258 g	Road - Cyclocross - MTB

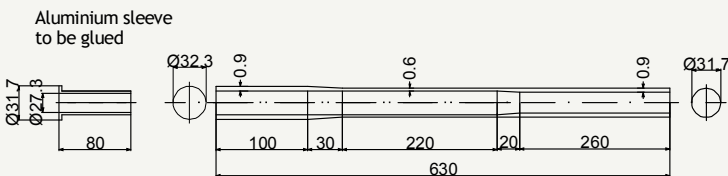

cod : MTV317B304

State	Weight	Use
BKS	397 g	Cyclocross - MTB

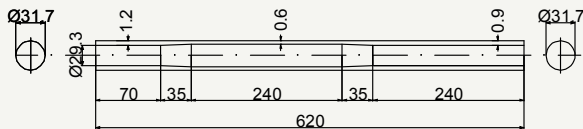

cod : MTV317B505

State	Weight	Use
BKS	384 g	Road - Cyclocross - MTB

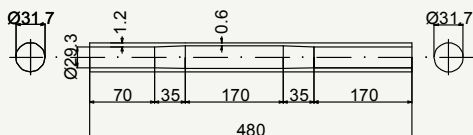

cod : MTV317B506

State	Weight	Use
BKS	290 g	Road - Cyclocross - MTB

# Zero Uno class chain stay

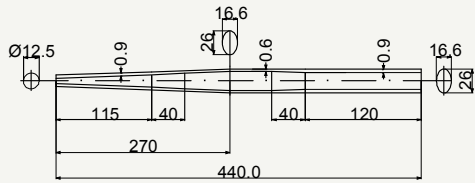

SIDE VIEW

cod : MPO222B101

State	Weight	Use
DSR	187 g	Road Disc Brake

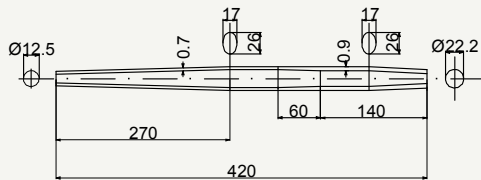

SIDE VIEW

cod : MPO222B102

State	Weight	Use
DSR	150 g	Road

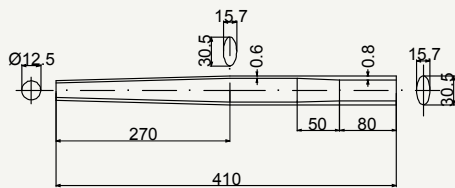

SIDE VIEW

cod : MPO240B201

State	Weight	Use
DSR	170 g	Road

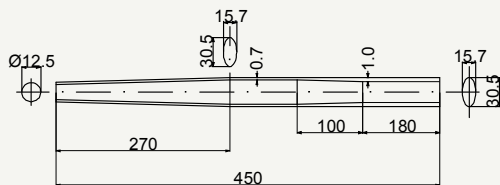

SIDE VIEW

cod : MPO240C202

State	Weight	Use
DSR	212 g	Road

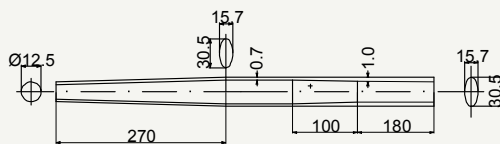

SIDE VIEW

cod : MPO240C2024

State	Weight	Use
DSR	212 g	Cyclocross

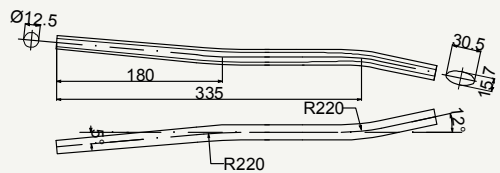

TOP VIEW

# Zero Uno class chain stay

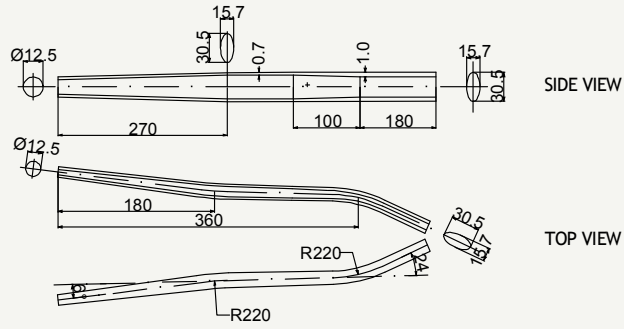

cod : MPO240C2022

State	Weight	Use
DSR	212 g	Gravel - MTB 29"

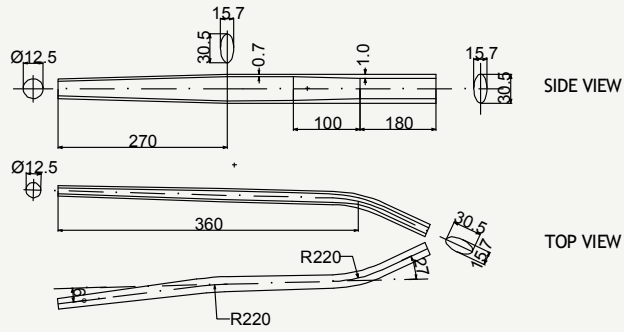

cod : MPO240C2023

State	Weight	Use
DSR	212 g	Fat Bike

# Zero Uno class seat stay

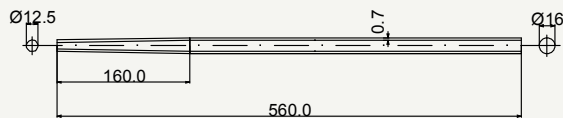

cod : MPV160B210

State	Weight	Use
DSR	144 g	Road

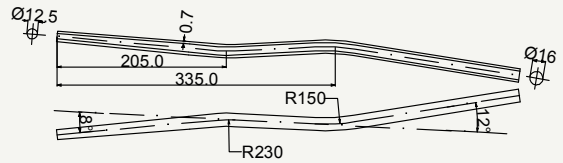

TOP VIEW

cod : MPV160B207

State	Weight	Use
DSR	144 g	Cyclocross

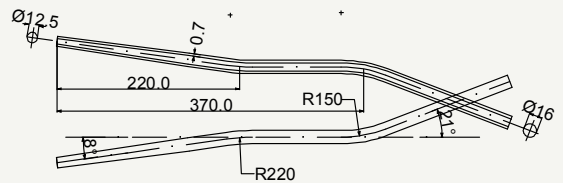

TOP VIEW

cod : MPV160B208

State	Weight	Use
DSR	144 g	Gravel - MTB 29"

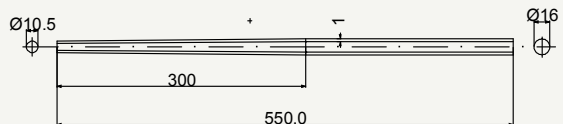

cod : MPV160D201

State	Weight	Use
DSR	202 g	Road

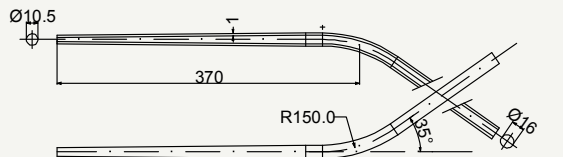

TOP VIEW

cod : MPV160D202

State	Weight	Use
DSR	202 g	Fat Bike

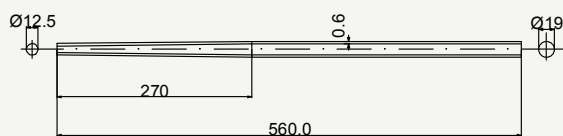

cod : MPV190B604

State	Weight	Use
DSR	152 g	Road



# Zero Uno class seat stay

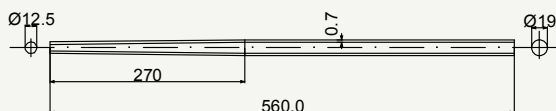

cod : MPV190B601

State	Weight	Use
DSR	169 g	Road

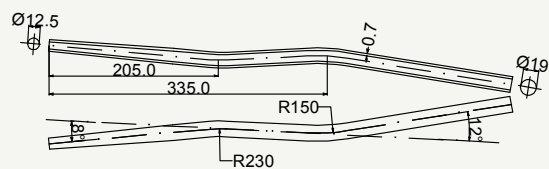

TOP VIEW

cod : MPV190B602

State	Weight	Use
DSR	169 g	Cyclocross

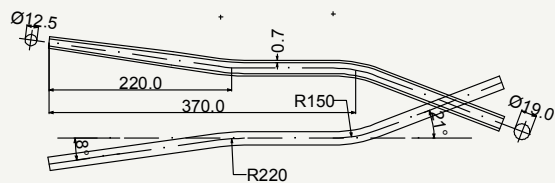

TOP VIEW

cod : MPV190B6022

State	Weight	Use
DSR	169 g	Gravel - MTB 29"

# Zero Uno class head tubing

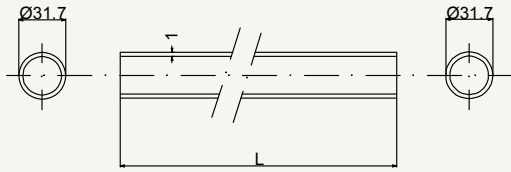

cod : MTS31710200Z

State	Lenght	Weight	Use
DSR	200	150 g	Road

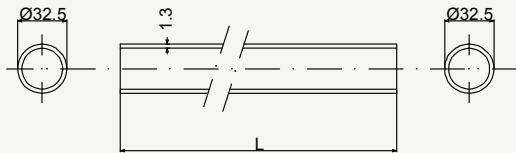

cod : MTS31710650Z

State	Lenght	Weight	Use
DSR	650	489 g	Road

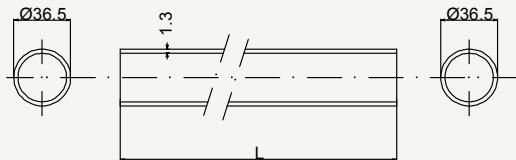

cod : MTS32513200Z

State	Lenght	Weight	Use
DSR	200	198 g	Road - Off Road

cod : MTS32513650Z

State	Lenght	Weight	Use
DSR	650	646 g	Road - Off Road

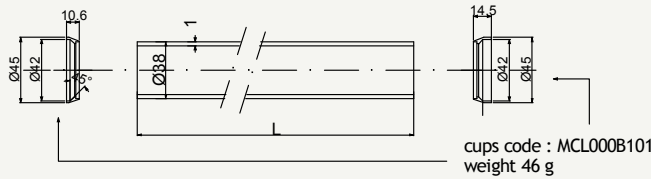

cod : MTS36513200Z

State	Lenght	Weight	Use
DSR	200	224 g	Road - Off Road

cod : MTS36513650Z

State	Lenght	Weight	Use
DSR	650	729 g	Road - Off Road

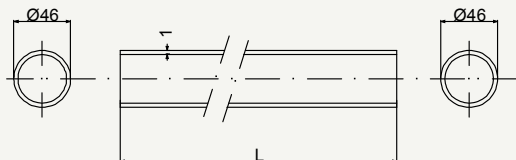

cod : MTS38010200Z

State	Lenght	Weight	Use
DSR	200	181 g	Road - Off Road

cod : MTS38010650Z

State	Lenght	Weight	Use
DSR	650	588 g	Road - Off Road

Alloy cup  
remove anodization  
before gluing

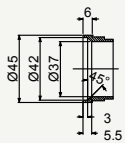

Alloy cup  
remove anodization  
before gluing

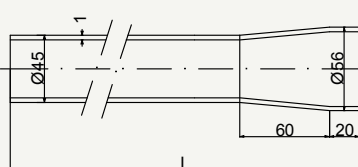
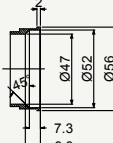

cod : MTS46010200Z

State	Lenght	Weight	Use
DSR	200	245 g	Road - Off Road

cod : MTS46010650Z

State	Lenght	Weight	Use
DSR	650	245 g	Road - Off Road

cod : MTS56250 (cups included)

State	Lenght	Weight	Use
DSR	260	360 g	Road - Off Road

cod : MTS56250WOC (cups not included)

State	Lenght	Weight	Use
DSR	260	328 g	Road - Off Road

# Zero Uno class steerer and blades

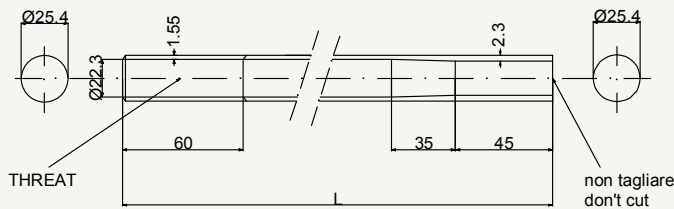

cod : MCN254180B

State	Lenght	Weight	Use
BKS	180	200 g	Road

cod : MCN254200B

State	Lenght	Weight	Use
BKS	200	225 g	Road

cod : MCN254220B

State	Lenght	Weight	Use
BKS	220	248 g	Road

cod : MCN254240B

State	Lenght	Weight	Use
BKS	240	277 g	Road

cod : MCN254260B

State	Lenght	Weight	Use
BKS	260	299 g	Road

cod : MCN254280B

State	Lenght	Weight	Use
BKS	280	312 g	Road

cod : MCN254300B

State	Lenght	Weight	Use
BKS	300	325 g	Road

cod : MCN254319B

State	Lenght	Weight	Use
BKS	320	360 g	Road

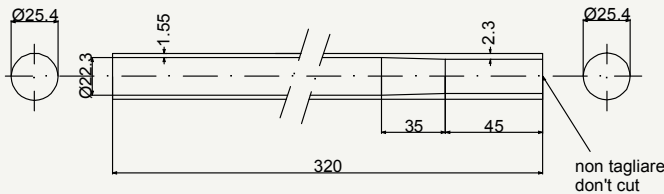

cod : MCN254320B (Threatless)

State	Weight	Use
BKS	360 g	Road

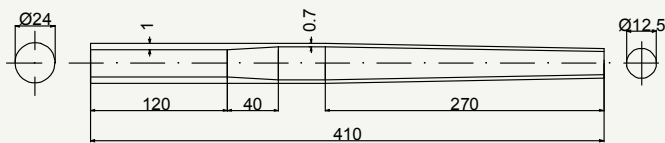

cod : MFT240B105

State	Weight	Use
DSR	208 g	Road - Track

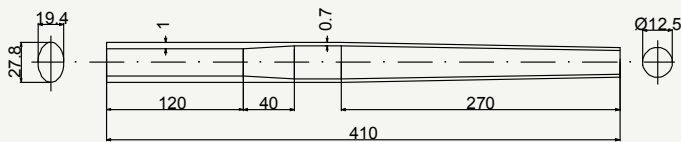

cod : MFT240B103

State	Weight	Use
DSR	208 g	Road

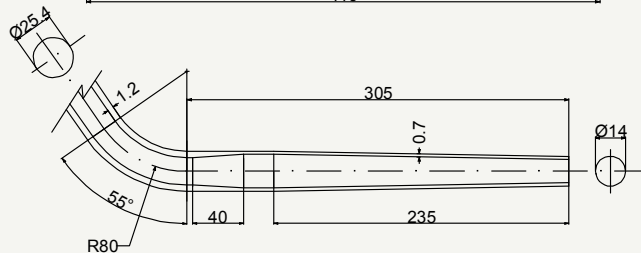

cod : MFU254B201

State	Weight	Use
DSR	302 g	Road







## Assembling of the tubing Geometrical features

All the Dedacciai tubes and tube sets are designed for assembling frames based on current UCI geometry.

In the choice of tubing for manufacturing a frames, please keep into account the following safety rules:

- Verify that for the selected geometry you will save a butt length longer than the thermal affected zone, and in any case longer than the tube diameter.
- If the butt length of down and top tubing butts are not symmetrical, pay attention in the tube orientation : at the head tube joint the tube must be only mitred, and not cut.
- Depending on geometry, it is always better to keep top and down tubing spaced on head tube. Over imposed tubing geometries are less safe.
- Road recommended tubing can't be used for off-road frames.
- Fixing point and welding cordons closure points can give origin to fatigue cracks, realize them in the less stressed areas of the joints.
- It is recommended to completely weld the seat tube on bottom bracket, and then all other tubing.
- Top tube and seat stays must be approximately aligned at the seat tube joint. If you want to weld the seat stays below the top tube center line, please use the "low geometry (LG)" seat tube





## Welding and post-welding advices

- Before welding the tubing, carefully clean them and remove dirty and grease inside and outside of the tube in the area to be jointed. The surfaces must be smooth and without notches. After mechanical cleaning, use acetone or MEK. Do not use chlorinated solvents.
- The suggested welding wire composition for TIG is C - 0.1% Si 0.5% Mn 1.0 % Cr 1.2 % Mo 0.5 % (i.e. CASTOTIG 680 / AWS A5 ER70S-2 or similar) Welding wire diameter: from 1.0 to 2.0 mm.
- For brazing choose low melting temperature alloy, if possible below 530 °C.
- Also the welding wire surface state is very important: stock it in clean areas, clean it before use and handle tubing and welding wire with gloves.
- Do not grind and/or polish the welding cordons. The risk of reducing the tube wall thickness is too high!
- Anticorrosion treatment is needed on the finished frame, cataphoresis is the most effective in long term protection
- As all the hi-resistance (> 1000 Mpa) steel, tubing in state HTS are sensitive to hydrogen embrittlement. Pay attention in avoid exposure to acid or hydrogen environments during frame fabrication. They can cause immediate and spontaneous breaks on tubing. In this case please contact our technical department.



Dedacciai Srl - Via Leonardo da Vinci, 19 - 26010 Campagnola Cremasca (CR) - Italy - Ph. +39 0373 74 499 - [www.dedacciaistrada.com](http://www.dedacciaistrada.com)

