



ASPIRAPOLVERE / LIQUIDI  
PROFESSIONALI  
*PROFESSIONAL WET & DRY*  
*VACUUM CLEANERS*



Forza aspirante, maneggevolezza, affidabilità, facilità di utilizzo e silenziosità: sono queste le linee guida che Biemmedue ha seguito per progettare la propria gamma di aspiratori ed aspiraliquidi professionali.

*Superior vacuum power, manoeuvrability, reliability, ease of use and noise reduction: these are the guiding principles followed by Biemmedue in the design and manufacture of its range of professional vacuum cleaners.*

### **Portata d'aria VS depressione**

La portata d'aria è il volume di aria aspirata in litri al secondo ed è data dalla velocità media dell'aria, moltiplicata per il diametro del condotto. La depressione è la forza aspirante ed è inversamente proporzionale alla portata d'aria: infatti per aver maggior depressione occorre un diametro del condotto minore. L'efficienza di un aspiratore Biemmedue è data dalla combinazione ottimale fra la portata d'aria e la depressione, efficienza che fa sì che la potenza richiesta dal motore sia la più contenuta possibile, per evitare consumo di energia elettrica.

#### **Air flow Vs depression**

*Air flow is the volume of vacuumed air measured in litres per second and is the product of average air speed multiplied by the conduit diameter. Depression is the vacuum force and is inversely proportional to air flow: the lower the diameter of the conduit, the higher the depression. The efficiency of a Biemmedue vacuum cleaner lies in the optimal ratio between air flow and depression, allowing the motor to provide maximum output with minimum power consumption.*

### **Carrello fisso VS carrello basculante**

Dipende dal tipo di applicazione ma in generale il carrello fisso, combinato con il tubo di scarico, è preferibile per l'aspirazione dei liquidi: infatti, per lo svuotamento, si evita lo sforzo di sollevamento del fusto. Il carrello basculante invece è più indicato in presenza di rifiuti solidi e polveri: la possibilità di ribaltamento del fusto facilita il travaso e lo svuotamento.

#### **Fixed trolley VS tipping trolley**

*The choice depends largely on the application, but as a general rule the fixed trolley equipped with a drain hose is more suitable for liquid pick-up and disposal, avoiding the need to lift and tip the recovery tank. The tipping trolley on the other hand, is more indicated for the removal of solid waste mater and dust due to the easy and effortless tipping and emptying of the recovery tank.*

### **Fusto in plastica VS fusto in acciaio**

Il fusto in plastica è preferibile, grazie alla sua flessibilità, laddove sia richiesta resistenza agli urti e movimentazione frequente. Inoltre è indicato in presenza di prodotti chimici particolarmente aggressivi. Per contro, il fusto in acciaio inox è più rigido, stabile, resiste meglio all'abrasione meccanica e gode della miglior percezione estetica del prodotto; quindi è preferibile per utilizzi statici, con materiali abrasivi e dove l'estetica non sia un fattore trascurabile.

#### **Plastic tank VS steel tank**

*The flexibility and resistance to potential denting and mechanical stress, make the plastic tanks a better choice where the machine might be subjected to contusions and undergo frequent displacements. It is also suitable in the presence of aggressive chemical agents. The steel tank constructed in stainless steel, is more rigid, stable and resistant to mechanical abrasions, and is generally considered more aesthetically pleasing. It is therefore more indicated where the machine is mostly stationary, in the presence of abrasive materials and where the physical image of the machine is a considerable factor.*

### **Filtri**

Negli aspirapolvere/liquidi professionali, la scelta della tipologia di filtro riveste un ruolo fondamentale per la soddisfazione delle necessità di pulizia richieste dalle diverse applicazioni. Nelle pagine seguenti è stato dato ampio risalto alle diverse tipologie di filtri, disponibili con chiare istruzioni di utilizzo per le diverse applicazioni.

#### **Filters**

*In professional wet & dry vacuum cleaners, the choice of filter plays a major role in the fulfilment of the requirements implied in various cleaning applications. In the following pages particular emphasis is placed on the variety of available filters, providing ample explanations and instructions for their diverse uses and applications.*

### **1 motore VS 2-3 motori**

Dipende molto dalle applicazioni. Per tale motivo la Biemmedue ha sviluppato una gamma completa dalle diverse configurazioni che vi invitiamo a scoprire nelle pagine seguenti.

#### **1 motor VS 2-3 motors**

*The choice depends largely on the application. For this reason, Biemmedue has developed a complete range of different configurations which you are invited to consider in the following pages.*



# OTHELLO

---

ASPIRAPOLVERE PROFESSIONALE COMPATTO E SILENZIOSO  
*COMPACT AND QUIET PROFESSIONAL VACUUM CLEANER*

# OTHELLO - ASPIRAPOLVERE PROFESSIONALE COMPATTO E SILENZIOSO

## COMPACT AND QUIET PROFESSIONAL VACUUM CLEANER

- Aspiratore compatto e silenzioso con grandi prestazioni
  - Ideale per la pulizia professionale di alberghi, uffici, abitazioni e tutti i piccoli spazi
  - Motore di ultima generazione, potente ma efficiente e rispettoso dell'ambiente per alto rendimento a basso consumo
  - 4 livelli di filtrazione per aria più pulita e libera di polvere
  - Spia luminosa che allerta l'utilizzatore nel caso di intasamento del filtro
- High performance, compact, low-noise vacuum cleaner
  - Ideal for the professional cleaning of hotels, offices, homes and small spaces
  - Powerful yet efficient and environmentally friendly new generation motor for low consumption and high output
  - 4 levels of filtration for cleaner dust-free air
  - Illuminated signal to alert in case of filter saturation



### ACCESSORI IN DOTAZIONE / SUPPLIED ACCESSORIES

	N°	COD.	DESCRIZIONE - DESCRIPTION
	1	004.317	Tubo flessibile diam.36 mm completo (l=1,8m) Flexible hose diam.36mm complete (l= 1.8 m)
	2	004.473*	Prolunga diam. 36 mm (2 pezzi) Extension tubes (2 pieces), diam.36 mm
	3	004.399	Spazzola combinata diam.36 mm Combination brush diam.36 mm
	4	004.400	Lancia piatta diam.36mm Crevice tool diam.36 mm
	5	004.402	Pennello diam.36 - Round brush diam.36 mm
	6	004.401	Bocchettina diam.36 mm - Upholstery tool diam.36 mm
		004.499.004	Filtro cartuccia Cartridge filter
		B.CCFL00000	Filtro a sacco in microfibra Microfiber filter bag

\* Codice riferito a 1 singolo pezzo - Code referred to 1 single piece

### ACCESSORI A RICHIESTA/ ACCESSORIES ON DEMAND

FILTRO HEPA CLASSE H13 HEPA FILTER CLASS H13	FILTRO NYLON NYLON FILTER BAG							
<b>Cod.</b> 004.499.007	<b>Cod.</b> 004.499.012							
PESI E DIMENSIONI MACCHINA WEIGHTS AND DIMENSIONS MACHINE								
MOD	A	B	C	Netto/Net	X	Y	H	Lordo/Gross
	[mm]	[mm]	[mm]	[kg]	[mm]	[mm]	[mm]	[kg]
OTHELLO	320	440	450	7	429	429	520	8

		OTHELLO
codice - code		008.435
potenza max - max. power	[ W ]	850
alimentazione - power supply	[ V - ph - Hz ]	230-1-50/60
tipo motore - motor type		diretto/direct
depressione - water lift	[ mm H <sub>2</sub> O ]	2.450
portata aria - air flow	[ m <sup>3</sup> /h ]	170
volume fusto in litri - tank volume in liters	[ l ]	7
materiale fusto - tank material		PP
livello rumore - noise level	[ dBA ]	58
kit accessori - attachments kit	[ mm ]	36
lunghezza cavo elettrico - electric cable length	[ m ]	7
dimensioni pallet - pallet dimensions	[ cm ]	110x130x190
quantità per pallet - pallet quantities	[ pz - pcs ]	18

PP = polipropilene - polypropylene





# MAXIM

---

ASPIRAPOLVERE/LIQUIDI A 1 MOTORE PER USO PROFESSIONALE  
SINGLE-MOTOR WET & DRY VACUUM CLEANERS FOR PROFESSIONAL USE

## MAXIM - ASPIRAPOLVERE/LIQUIDI A 1 MOTORE PER USO PROFESSIONALE

- Maneggevoli, facili da spostare
  - Ideali per l'utilizzo in ambienti quali: piccoli uffici, abitazioni, garage, negozi, botteghe, magazzini, etc.
  - Attrezzature necessarie per tutte le imprese di pulizia
  - Includono kit di accessori professionali e filtri per la pulizia di pavimenti, di piccoli angoli e fessure difficili da raggiungere, interni auto e molte altre diverse zone
- *Easy to handle, easy to move, self-contained units*
  - *Ideal for use in environments such as: small offices, workshops, homes, garages, stores, warehouses, etc.*
  - *Necessary equipment for all cleaning companies*
  - *Include professional attachment kits and filters, for cleaning of floors, upholstery, small corners and crevices, hard to reach places, car interiors, and many other different areas*

MAXIM 15 DRY - MAXIM 15



MAXIM 25



## ACCESSORI IN DOTAZIONE / SUPPLIED ACCESSORIES

	N°	MOD.	COD.	DESCRIZIONE - DESCRIPTION
	1	Tutti - All	004.317	Tube flessibile diam.36 mm completo (l= 1,8 m) Flexible hose diam.36mm complete (l= 1,8 m)
	2	Tutti - All	004.404*	Prolunga acciaio diam. 36 mm (2 pezzi) Extension tubes (2 pieces), steel diam.36 mm
	3	Tutti - All	004.399	Spazzola combinata diam.36 mm Combination brush diam.36 mm
	4	Tutti - All	004.400	Lancia piatta diam.36 Crevice tool diam.36 mm
	5	Tutti - All	004.402	Pennello diam.36 Round brush diam.36 mm
	6	Tutti - All	004.401	Bocchetta diam.36 mm Upholstery tool diam.36 mm
	7	MAXIM 15 MAXIM 25	004.319	Ventosa liquidi diam.36 mm Squeegee floor tool diam.36 mm
	MAXIM 15 DRY		004.423	Filtro in Poliestere con anello portafiltro e tendifiltro Polyester filter with support ring and basket
	MAXIM 15 MAXIM 25		004.179	Filtro in Poliestere con anello portafiltro Polyester filter with support ring
	MAXIM 15 MAXIM 25		004.410	Filtro spugna Sponge filter
	Tutti - All		004.321	Filtro a sacco super Super filter bag

\* Codice o riferito a 1 singolo pezzo - Code referred to 1 single piece

## ACCESSORI A RICHIESTA/ ACCESSORIES ON DEMAND

FILTRO CARTUCCIA POLIESTERE CLASSE M CARTRIDGE POLYESTER FILTER CLASS M	FILTRO HEPA CLASSE H13 HEPA FILTER CLASS H13	FILTRO NYLON NYLON FILTER
<b>Mod.</b> MAXIM 15 - MAXIM 25 <b>Cod.</b> 004.387	<b>Mod.</b> MAXIM 15 - MAXIM 25 <b>Cod.</b> 004.437	<b>Mod.</b> Tutti-All <b>Cod.</b> 004.180

# MAXIM - ASPIRAPOLVERE/LIQUIDI A 1 MOTORE PER USO PROFESSIONALE

## SINGLE-MOTOR WET & DRY VACUUM CLEANERS FOR PROFESSIONAL USE

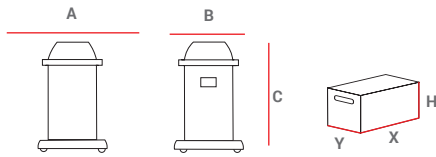

PESI E DIMENSIONI MACCHINA WEIGHTS AND DIMENSIONS MACHINE					IMBALLO PACKAGING			
MOD	A	B	C	Netto/Net	X	Y	H	Lordo/Gross
	[mm]	[mm]	[mm]	[kg]	[mm]	[mm]	[mm]	[kg]
MAXIM 15 DRY	385	385	520	8,2	429	429	520	9,4
MAXIM 15	385	385	520	8,2	429	429	520	9,4
MAXIM 25	385	385	605	8,7	429	429	640	9,9

		MAXIM 15 DRY*	MAXIM 15	MAXIM 25
codice - code		● 008.330	● 008.357	● 008.331
potenza max - max. power	[ W ]	1.000	1.000	1.000
alimentazione - power supply	[ V - ph - Hz ]	230-1-50/60	230-1-50/60	230-1-50/60
tipo motore - motor type		TF	BP	BP
depressione - water lift	[ mm H <sub>2</sub> O ]	2.400	2.400	2.400
portata aria - air flow	[ m <sup>3</sup> /h ]	160	180	180
volume fusto in litri - tank volume in liters	[ l ]	15	15	25
materiale fusto - tank material		PP	PP	PP
livello rumore - noise level	[ dBA ]	64	66	66
kit accessori - attachments kit	[ mm ]	36 dry	36 wd	36 wd
lunghezza cavo elettrico - electric cable lenght	[ m ]	7	7	7
dimensioni pallet - pallet dimensions	[ cm ]	80x120x172	80x120x172	80x120x207
quantità per pallet - pallet quantities	[ pz - pcs ]	18	18	18

\* Modello MAXIM 15 DRY solo per polvere. No liquidi - MAXIM 15 DRY model is for dry use only. No liquids

PP = polipropilene - polypropylene

TF = Bi-stadio con raffreddamento diretto - 2 stage with direct cooling

BP = Bi-stadio con raffreddamento bypass - 2 stage with bypass cooling



# SP 30 - 45 & SM 25 - 40

ASPIRAPOLVERE/LIQUIDI A 1 MOTORE PER USO PROFESSIONALE  
SINGLE-MOTOR WET & DRY VACUUM CLEANERS FOR PROFESSIONAL USE

## SP 30-45 & SM 40-25 - ASPIRAPOLVERE/LIQUIDI A 1 MOTORE PER USO PROFESSIONALE

- Maneggevoli, facili da spostare
- Super silenzioso e compatto (SP 30 DRY, SM 25 DRY)
- Ideali per l'utilizzo in ambienti quali: piccoli uffici, abitazioni, garage, negozi, botteghe, magazzini, etc.
- Attrezzature necessarie per tutte le imprese di pulizia
- Includono kit di accessori professionali e filtri per la pulizia di pavimenti, di piccoli angoli e fessure difficili da raggiungere, interni auto e molte altre diverse zone
- La maggior parte dei modelli è disponibile con un serbatoio in plastica anti-urto, o con un serbatoio in acciaio inox AISI 430
- Base aspiratore montata su quattro ruote robuste per una maggiore stabilità
- Ruote in gomma antitraccia
- Paraurti in gomma per protezione antiurto contro pareti e mobili per modelli con fusto in acciaio inox

- *Easy to handle, easy to move, self-contained units.*
- *Super silent compact dry models (SP 30 DRY, SM 25 DRY)*
- *Ideal for use in environments such as: small offices, workshops, homes, garages, stores, warehouses, etc.*
- *Necessary equipment for all cleaning companies*
- *Include professional attachment kits and filters, for cleaning of floors, upholstery, small corners and crevices, hard to reach places, car interiors, and many other diverse areas*
- *Most models are available with either a shock-proof plastic tank, or a stainless steel AISI 430 tank*
- *Mounted on sturdy wheel base for extra stability*
- *Non-marking rubber wheels*
- *Rubber bumper for wall and furniture protection on stainless steel models*

SP 30

SP 45

SM 40

SM 25





## ACCESSORI IN DOTAZIONE / SUPPLIED ACCESSORIES

	N°	MOD.	COD.	DESCRIZIONE - DESCRIPTION
	1	SP 30 - SM 25 (Tutti - All)	004.317	Tube flessibile diam.36 mm completo (l= 1,8 m) Flexible hose diam.36 mm complete (l= 1,8 m)
	2	SP 30 - SM 25 (Tutti - All)	004.404*	Prolunga acciaio diam. 36 mm (2 pezzi) Extension tubes (2 pieces), steel diam.36 mm
	3	SP 30 - SM 25 (Tutti - All)	004.399	Spazzola combinata diam.36 mm Combination brush diam.36 mm
	4	SP 30 - SM 25 (Tutti - All)	004.400	Lancia piatta diam.36 mm Crevice tool diam.36 mm
	5	SP 30 - SM 25 (Tutti - All)	004.402	Pennello diam.36 mm Round brush diam.36 mm
	6	SP 30 - SM 25 (Tutti - All)	004.401	Bocchettina diam.36 mm Upholstery tool diam.36 mm
	7	SP 30 - SM 25 (no dry)	004.319	Ventosa liquidi diam.36 mm Squeegee floor tool diam.36 mm
	1	SP 45 - SM 40	004.329	Tubo flessibile diam.40 mm completo (l= 3 m) Flexible hose diam.40 mm complete (l= 3 m)
	2	SP 45 - SM 40	004.046	Doppia curva acciaio diam.40 mm Double-elbow steel tube, diam.40 mm
	3	SP 45 - SM 40	004.331	Spazzola setole "S" diam.40 mm Brush floor tool "S" diam.40 mm
	4	SP 45 - SM 40	004.326	Ventosa liquidi diam.40 mm Squeegee floor tool diam.40 mm
	5	SP 45 - SM 40	004.421	Lancia piatta diam.40 mm Crevice tool diam.40 mm
	6	SP 45 - SM 40	004.088	Pennello diam.40 mm Round brush diam.40 mm
		Tutti - All	004.424	Filtro in Poliestere con anello portafiltra Polyester filter with support ring
		SP 30 - SM 25 (NO DRY) SP 45 - SM 40	004.410	Filtro spugna Sponge filter
		SP 30 DRY - SP 30 - SM 25 DRY - SM 25	004.321	Filtro a sacco super Super filter bag
		SP 45 - SM 40	004.335	

\* Codice riferito a 1 singolo pezzo - Code referred to 1 single piece

## ACCESSORI A RICHIESTA/ ACCESSORIES ON DEMAND

FILTRO CARTUCCIA POLIESTERE CLASSE M CARTRIDGE POLYESTER FILTER CLASS M	FILTRO HEPA CLASSE H13 HEPA FILTER CLASS H13	FILTRO NYLON NYLON FILTER
<b>Mod.</b> Tutti-All <b>Cod.</b> 004.387	<b>Mod.</b> Tutti-All <b>Cod.</b> 004.437	<b>Mod.</b> Tutti-All <b>Cod.</b> 004.180

# SP 30-45 & SM 25-40 - ASPIRAPOLVERE/LIQUIDI A 1 MOTORE PER USO PROFESSIONALE SINGLE-MOTOR WET & DRY VACUUM CLEANERS FOR PROFESSIONAL USE

FILTRO CALOR HEAT-RESISTANT FILTER	KIT FORNO OVEN KIT
	
<b>Mod.</b> SM 25 DRY - SM 25 - SM 40 <b>Cod.</b> 004.346	<b>Mod.</b> SM 25 DRY - SM 25 - SM 40 <b>Cod.</b> 004.332

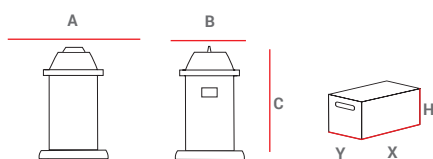

PESI E DIMENSIONI MACCHINA WEIGHTS AND DIMENSIONS MACHINE				IMBALLO PACKAGING				
MOD	A	B	C	Netto/Net	X	Y	H	Lordo/Gross
	[mm]	[mm]	[mm]	[kg]	[mm]	[mm]	[mm]	[kg]
SP 30	430	430	518	9,2	474	474	580	10,8
SM 25	430	430	518	9,7	474	474	580	11,3
SP 45	430	430	720	10,7	474	474	760	12,3
SM 40	430	430	720	11,4	474	474	760	13

		SP 30 DRY*	SP 30	SP 45	SM 25 DRY*	SM 25	SM 40
codice - code		● 008.314	● 008.318	● 008.319	● 008.334	● 008.335	● 008.337
potenza max - max. power	[W]	1.000	1.000	1.000	1.000	1.000	1.000
alimentazione - power supply	[V-ph-HZ]	230-1-50/60	230-1-50/60	230-1-50/60	230-1-50/60	230-1-50/60	230-1-50/60
tipo motore - motor type		TF	BP	BP	TF	BP	BP
depressione - water lift	[mm H <sub>2</sub> O]	2.200	2.200	2.200	2.200	2.200	2.200
portata aria - air flow	[m <sup>3</sup> /h]	198	198	198	198	198	198
volume fusto in litri - tank volume in liters	[l]	30	30	45	25	25	40
materiale fusto - tank material		PE HD	PE HD	PE HD	SS 430	SS 430	SS 430
livello rumore - noise level	[dBA]	62	65	65	62	65	65
kit accessori - attachments kit	[mm]	36 DRY	36 WD	40	36 DRY	36 WD	40
lunghezza cavo elettrico - electric cable lenght	[m]	7	7	7	7	7	7
dimensioni pallet - pallet dimensions	[cm]	110x130x190	110x130x190	110x130x160	110x130x190	110x130x190	110x130x160
quantità per pallet - pallet quantities	[pz - pcs]	18	18	12	18	18	12

\* SP30 DRY - SM25DRY: solo per polvere. No liquidi - SP30 DRY - SM25DRY: for dry use only. No liquids.

TF = Bi-stadio con raffreddamento diretto - 2 stage with direct cooling

BP = Bi-stadio con raffreddamento bypass - 2 stage with bypass cooling

PP = polipropilene - polypropylene

SS 430 = Inox AISI 430 - Stainless steel AISI 430

PE HD = Polietilene alta densità - High density polyethylene



# SP 65 - 65 T & SM 50 - 50 B AC

ASPIRAPOLVERE/LIQUIDI A 1 MOTORE PER USO PROFESSIONALE  
SINGLE-MOTOR WET & DRY VACUUM CLEANERS FOR PROFESSIONAL USE

## SP 65 - 65 T & SM 50 - 50 B AC - ASPIRAPOLVERE/LIQUIDI A 1 MOTORE PER USO PROFESSIONALE

- Maneggevoli, facili da spostare
- Un maxi filtro per una maggiore superficie filtrante
- Un potente motore a due stadi bypass da 1400 W fornisce una prestazione superiore per aspirare polveri e liquidi
- Ideale per l'utilizzo in ambienti quali botteghe, laboratori, officine, garage, magazzini, ecc.
- Attrezzature necessarie per tutte le imprese di pulizia e per rimuovere grandi volumi di sporco e polvere
- Includono kit di accessori professionali e filtri per la pulizia di pavimenti, di piccoli angoli e fessure difficili da raggiungere, interni auto e molte altre diverse zone
- Tutti i modelli SM 50 sono dotati con serbatoio in acciaio inox AISI 430
- SM 50 B AC è montato su un robusto carrello basculante per facilitare le operazioni di svuotamento e di una stabile base ruote resistente per tutti i tipi di superficie
- Tutti i modelli SP 65 hanno un fusto in plastica da 65 litri robusto e antiurto: massimo volume in minimo spazio
- La maniglia e le larghe ruote posteriori rendono il modello SP 65 T adatto e particolarmente utile per l'utilizzo su terreni sconnessi e irregolari
- *Easy to handle, easy to move, self-contained units*
- *Oversized filter for higher filtration surface area*
- *An extra powerful 1400 W two-stage bypass motor provides superior performance for both wet and dry pick-up*
- *Ideal for use in workshops, garages, warehouses, etc.*
- *Necessary equipment for all cleaning companies and for large-volume dust and waste removal*
- *Include professional attachment kits and filters, for cleaning of floors, upholstery, small corners and crevices, hard to reach places, car interiors, and many other diverse areas*
- *All SM 50 models have a stainless steel AISI 430 tank*
- *SM 50 B AC is mounted on a robust tip & tilting trolley to facilitate emptying operations and to provide a resistant wheel base for all terrains*
- *All SP 65 models have robust, shock-proof 65 litre plastic tanks: maximum volume in minimum space*
- *The handle and large rear wheels of the SP 65 T make it suitable and convenient for use on rough grounds*

SP 65

SP 65 T

SM 50

SM 50 B AC



## ACCESSORI IN DOTAZIONE / SUPPLIED ACCESSORIES

	N°	MOD.	COD.	DESCRIZIONE - DESCRIPTION
	1	Tutti - All	004.329	Tubo flessibile diam.40 mm completo (l=3m) Flexible hose diam.40 mm complete (l=3 m)
	2	Tutti - All	004.046	Doppia curva acciaio diam.40 mm Double-elbow steel tube, diam. 40 mm
	3	Tutti - All	004.331	Spazzola setole "S" diam.40 mm - Brush floor tool "S" diam.40 mm
	4	Tutti - All	004.326	Ventosa liquidi diam.40 mm Squeegee floor tool diam.40 mm
	5	Tutti - All	004.421	Lancia piatta diam.40 mm Crevice tool diam.40 mm
	6	Tutti - All	004.088	Pennello diam.40 mm Round brush diam.40 mm
		Tutti - All	004.430	Filtro in Poliestere con anello portafiltro e tendifiltro Polyester filter with support ring and basket
		Tutti - All	004.410	Filtro spugna Sponge filter
		Tutti - All	004.335	Filtro a sacco super Super filter bag

## ACCESSORI A RICHIESTA/ ACCESSORIES ON DEMAND

FILTRO CARTUCCIA POLIESTERE CLASSE M CARTRIDGE POLYESTER FILTER CLASS M	FILTRO HEPA CLASSE H13 HEPA FILTER CLASS H13	FILTRO NYLON NYLON FILTER
<b>Mod.</b> Tutti-All <b>Cod.</b> 004.387	<b>Mod.</b> Tutti-All <b>Cod.</b> 004.437	<b>Mod.</b> Tutti-All <b>Cod.</b> 004.103
FILTRO CALOR HEAT-RESISTANT FILTER	KIT FORNO OVEN KIT	KIT TUBO SCARICO LIQUIDI DRAIN HOSE KIT
<b>Mod.</b> SM 50 - SM 50 B AC <b>Cod.</b> 004.417	<b>Mod.</b> SM 50 - SM 50 B AC <b>Cod.</b> 004.332	<b>Mod.</b> SP 65 - SP 65 T <b>Cod.</b> 004.499.001**  <b>Mod.</b> SM 50 <b>Cod.</b> 004.425**

(\*\*) Installato in fase di produzione macchina - Must be installed during manufacturing

**SP 65 - 65T & SM 50 - 50 B AC - ASPIRAPOLVERE/LIQUIDI A 1 MOTORE PER USO PROFESSIONALE**  
**SINGLE-MOTOR WET & DRY VACUUM CLEANERS FOR PROFESSIONAL USE**

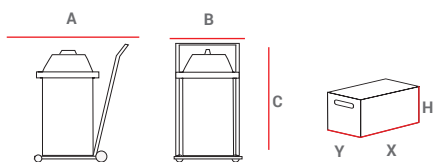

PESI E DIMENSIONI MACCHINA WEIGHTS AND DIMENSIONS MACHINE					IMBALLO PACKAGING			
MOD	A	B	C	Netto/Net	X	Y	H	Lordo/Gross
	[mm]	[mm]	[mm]	[kg]	[mm]	[mm]	[mm]	[kg]
SP 65	445	415	800	12,5	512	512	965	14,5
SP 65 T	610	520	800	14	694	604	1.035	16
SM 50	400	400	830	14,4	512	512	965	18,6
SM 50 B AC	620	540	900	17	694	604	1.035	21,2

		SP 65	SP 65 T	SM 50	SM 50 B AC
codice - code		● 008.363	● 008.328	● 008.370	● 008.339
potenza max - max. power	[ W ]	1.200	1.200	1.200	1.200
alimentazione - power supply	[ V - ph - Hz ]	230-1-50/60	230-1-50/60	230-1-50/60	230-1-50/60
tipo motore - motor type		BP	BP	BP	BP
depressione - water lift	[ mm H <sub>2</sub> O ]	2.450	2.450	2.450	2.450
portata aria - air flow	[ m <sup>3</sup> /h ]	210	210	210	210
volume fusto in litri - tank volume in liters	[ l ]	65	65	50	50
materiale fusto - tank material		PE HD	PE HD	SS 430	SS 430
livello rumore - noise level	[ dBA ]	65	65	65	65
kit accessori - attachments kit	[ mm ]	40	40	40	40
lunghezza cavo elettrico - electric cable lenght	[ m ]	7	7	7	7
dimensioni pallet - pallet dimensions	[ cm ]	100x120x195	110x130x217	100x120x195	110x130x217
quantità per pallet - pallet quantities	[ pz - pcs ]	8	8	8	8

BP = Bistadio con raffreddamento bypass - 2 stage with bypass cooling

SS 430 = Inox AISI 430 - Stainless steel AISI 430

PE HD = Polietilene alta densità - High density polyethylene





# SP 70 - 70 T & SM 70 - 70 B AC

---

ASPIRAPOLVERE/LIQUIDI COMPATTI A 2/3 MOTORI  
COMPACT 2/3 MOTOR WET & DRY VACUUM CLEANERS

## SP 70 - 70 T & SM 70 - 70 B AC ASPIRAPOLVERE/LIQUIDI COMPATTI A 2/3

- Massima potenza in minimo ingombro
  - Maneggevoli, facili da spostare
  - Motori bypass ad alta efficienza e rendimento di ultima generazione erogano livelli insuperabili di depressione e portata d'aria
  - Design intelligente per maggiore silenziosità
  - SM 70: involucro in Inox AISI430 montato su un robusto basamento ruote in acciaio con copri ruote protettive
  - SM 70 B AC: involucro in Inox AISI430 montato su un resistente carrello basculante in acciaio per facilitare lo svuotamento
  - SP 70 - SP 70 T: fusti anti-urto ultrasensibili in polietilene ad alta densità
  - La maniglia di spostamento e le larghe ruote posteriori del modello SP 70 T lo rendono adatto e particolarmente utile per l'utilizzo su terreni sconnessi e irregolari
  - Tutta la serie è dotata di kit completo di accessori professionali diametro 40 mm, e tutti i filtri necessari
  - Vasta gamma di accessori opzionali disponibili per adattare le macchine a varie e diverse applicazioni
- *Extreme power in a compact high capacity frame*
  - *Easy to move, easy to maneuver, easy to store*
  - *New generation high efficiency and high output bypass motors provide unsurpassed depression and air flow*
  - *Intelligent design for lower noise levels*
  - *SM 70: stainless steel AISI430 tank mounted on a sturdy steel wheel base with protective wheel covers*
  - *SM 70 B AC: stainless steel AISI430 tank mounted on a heavy-duty tip&pour steel trolley for effortless emptying*
  - *SP 70 models have shock-proof, ultra-resistant plastic tanks made of high-density polyethylene*
  - *The convenient handle and large rear wheels of SP 70 T models make it suitable for use on rough uneven grounds*
  - *All models are equipped with a full professional diameter 40 mm accessories kit and all necessary filters*
  - *Vast choice of optional accessories available to adapt the units for many different applications*

SP 70 (3/4 HP)    SP 70 T (3/4 HP)    SM 70 (3/4 HP)    SM 70 B AC (3/4 HP)



## ACCESSORI IN DOTAZIONE / SUPPLIED ACCESSORIES

	N°	MOD.	COD.	DESCRIZIONE - DESCRIPTION
	1	Tutti - All	004.329	Tubo flessibile diam.40 mm completo (l=3 m) Flexible hose diam.40 mm complete (l=3 m)
	2	Tutti - All	004.046	Doppia curva acciaio diam.40 mm Double-elbow steel tube, diam. 40 mm
	3	Tutti - All	004.331	Spazzola setole "S" diam.40 mm Brush floor tool "S" diam.40 mm
	4	Tutti - All	004.326	Ventosa liquidi diam.40 mm Squeegee floor tool diam.40 mm
	5	Tutti - All	004.421	Lancia piatta diam.40 mm Crevice tool diam.40 mm
	6	Tutti - All	004.088	Pennello diam.40 mm Round brush diam.40 mm
		Tutti - All	004.429	Filtro in Poliestere con anello portafiltro Polyester filter with support ring
		Tutti - All	004.367	Filtro spugna Sponge filter

## ACCESSORI A RICHIESTA/ ACCESSORIES ON DEMAND

FILTRO A SACCO SUPER SUPER FILTER BAG	FILTRO CARTUCCIA POLIESTERE CLASSE M CARTRIDGE POLYESTER FILTER CLASS M	FILTRO HEPA CLASSE H13 HEPA FILTER CLASS H13
Mod. Tutti-All Cod. 004.335	Mod. Tutti-All Cod. 004.441	Mod. Tutti-All Cod. 004.499.002
FILTRO NYLON NYLON FILTER	FILTRO CALOR HEAT-RESISTANT FILTER	KIT FORNO OVEN KIT
Mod. Tutti-All Cod. 004.103	Mod. SM 70 - SM 70 B AC Cod. 004.347	Mod. SM 70 - SM 70 B AC Cod. 004.332
KIT TUBO SCARICO LIQUIDI DRAIN HOSE KIT		
Mod. SP 70 - SP 70 T Cod. 004.499.001**		
Mod. SM 70 Cod. 004.425**		

(\*\*) Installato in fase di produzione macchina - Must be installed during manufacturing

# SP 70 - 70 T & SM 70 - 70 B AC - ASPIRAPOLVERE/LIQUIDI COMPATTI A 2/3

## COMPACT 2/3 MOTOR WET & DRY VACUUM CLEANERS

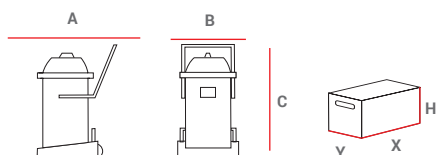

PESI E DIMENSIONI MACCHINA WEIGHTS AND DIMENSIONS MACHINE				IMBALLO PACKAGING				
MOD	A	B	C	Netto/Net	X	Y	H	Lordo/Gross
	[mm]	[mm]	[mm]	[kg]	[mm]	[mm]	[mm]	[kg]
SP 70 3HP	445	415	800	15	512	512	965	17
SP 70 4HP	445	415	800	17	512	512	965	19
SM 70 3HP	400	400	920	17	694	604	1.035	19
SM 70 4HP	400	400	920	19	694	604	1.035	21
SP 70 3HP T	610	520	800	16	694	604	1.035	18
SP 70 4HP T	610	520	800	18	694	604	1.035	20
SM 70 3HP B AC	610	425	920	19	694	604	1.035	21
SM 70 4HP B AC	610	425	920	21	694	604	1.035	23

		SP 70 3HP	SP 70 4HP	SM 70 3HP	SM 70 4HP
codice - code		● 008.457	● 008.458	● 008.459	● 008.460
potenza max - max. power	[W]	2.200	3.300	2.200	3.300
alimentazione - power supply	[V-ph-Hz]	230-1-50/60	230-1-50/60	230-1-50/60	230-1-50/60
tipo motore - motor type		HOE-BP	HOE-BP	HOE-BP	HOE-BP
motori - motors	[NR]	2	3	2	3
depressione - water lift	[mm H <sub>2</sub> O]	2.500	2.500	2.500	2.500
portata aria - air flow	[m <sup>3</sup> /h]	520	780	520	780
volume fusto in litri - tank volume in liters	[l]	65	65	65	65
materiale fusto - tank material		PE HD	PE HD	SS 430	SS 430
livello rumore - noise level	[dBA]	75	77	75	77
kit accessori - attachments kit	[mm]	40	40	40	40
lunghezza cavo elettrico - electric cable lenght	[m]	7	7	7	7
dimensioni pallet - pallet dimensions	[cm]	100x120x195	100x120x195	100x120x195	100x120x195
quantità per pallet - pallet quantities	[pz - pcs]	8	8	8	8

		SP 70 3HP T	SP 70 4HP T	SM 70 3HP B AC	SM 70 4HP B AC
codice - code		● 008.461	● 008.462	● 008.463	● 008.464
potenza max - max. power	[W]	2.200	3.300	2.200	3.300
alimentazione - power supply	[V-ph-Hz]	230-1-50/60	230-1-50/60	230-1-50/60	230-1-50/60
tipo motore - motor type		HOE-BP	HOE-BP	HOE-BP	HOE-BP
motori - motors	[NR]	2	3	2	3
depressione - water lift	[mm H <sub>2</sub> O]	2.500	2.500	2.500	2.500
portata aria - air flow	[m <sup>3</sup> /h]	520	780	520	780
volume fusto in litri - tank volume in liters	[l]	65	65	65	65
materiale fusto - tank material		PE HD	PE HD	SS 430	SS 430
livello rumore - noise level	[dBA]	75	77	75	77
kit accessori - attachments kit	[mm]	40	40	40	40
lunghezza cavo elettrico - electric cable lenght	[m]	7	7	7	7
dimensioni pallet - pallet dimensions	[cm]	110x130x217	110x130x217	110x130x217	110x130x217
quantità per pallet - pallet quantities	[pz - pcs]	8	8	8	8

HOE-BP = Alto rendimento e efficienza - bypass - High output and efficiency - bypass  
 PE HD = polietilene alta densità - High density polyethylene  
 SS 430 = Inox AISI 430 - Stainless steel AISI 430



# SP & SM 80 F - B PL - B AC

ASPIRAPOLVERE/LIQUIDI A 2/3 MOTORI CON CARRELLO FISSO/BASCULANTE  
MULTIPLE-MOTOR (2/3 MOTORS) WET & DRY VACUUM CLEANERS WITH FIXED/TIP & TILTING TROLLEY



## SP & SM 80 F - B PL - B AC - ASPIRAPOLVERE/LIQUIDI A 2/3 MOTORI CON CARRELLO FISSO/BASCULANTE

- Robusti e di grandi dimensioni per l'utilizzo in aree più ampie, dove potrebbe essere necessario un fusto con capacità maggiore
  - Tutti i modelli hanno 2 o 3 motori con una potenza di aspirazione molto elevata
  - Ideali per l'utilizzo in piccoli laboratori, come falegnamerie, lavorazione dei metalli
  - Ottimi per idraulici per la facilità del recupero dei liquidi ed asciugatura delle superfici bagnate
  - Adatti anche per officine meccaniche, per attività di pulizia particolarmente pesanti come per le imprese edili e per ogni tipo di magazzino
  - Includono kit di accessori professionali e filtri per la pulizia di pavimenti, di piccoli angoli e fessure difficili da raggiungere, interni auto e molte altre diverse zone
  - Possibilità di scelta del serbatoio: sia in plastica anti-urto che in acciaio inox AISI 430
  - I modelli B AC sono montati su un carrello basculante interamente costruito in acciaio per garantire durabilità anche nelle condizioni più estreme
  - I modelli B PL sono montati su un carrello basculante in plastica extra resistente
  - Ruote resistenti sono montate su un basamento ruote per maggiore stabilità
- *Robust and large sized for use where a higher capacity recovery tank may be needed*
  - *All units have 2 or 3 vacuum motors for very high suction power*
  - *Ideal for use in artisans' workshops, metal-working and wood-working facilities*
  - *Great for plumbers: vacuums spilled liquids and dries wet floors and surfaces*
  - *Suitable for mechanics' garages, and for heavy-duty work such as construction companies, and all larger workshop and warehouses*
  - *Include professional accessories kits and filters for cleaning of floors, upholstery, small corners and crevices, hard to reach places, car interiors and many other diverse areas*
  - *Choice of tanks: either a shock-proof plastic tank, or a stainless steel tank in AISI 430*
  - *B AC models are mounted on a heavy-duty tip & tilting trolley made entirely of steel to guarantee durability under the most extreme conditions*
  - *B PL models are mounted on a plastic tip & tilting trolley*
  - *Resistant wheels are mounted on a stable wheel base*





SP & SM 80 F - B PL - B AC - MULTIPLE-MOTOR (2/3 MOTORS) WET & DRY  
VACUUM CLEANERS WITH FIXED/TIP & TILTING TROLLEY

ACCESSORI IN DOTAZIONE / SUPPLIED ACCESSORIES

	N°	MOD.	COD.	DESCRIZIONE - DESCRIPTION
	1	Tutti - All	004.329	Tubo flessibile diam.40 mm completo (l= 3m) Flexible hose diam.40 mm complete (l= 3m)
	2	Tutti - All	004.046	Doppia curva acciaio diam.40 mm Double-elbow steel tube, diam. 40 mm
	3	Tutti - All	004.331	Spazzola setole "S" diam.40 mm Brush floor tool "S" diam.40 mm
	4	Tutti - All	004.326	Ventosa liquidi diam.40 mm Squeegee floor tool diam.40 mm
	5	Tutti - All	004.421	Lancia piatta diam.40 mm Crevice tool diam.40 mm
	6	Tutti - All	004.088	Pennello diam.40 mm Round brush diam.40 mm
		Tutti - All	004.134	Filtro in Poliestere con anello portafiltro Polyester filter with support ring
		Tutti - All	004.367	Filtro spugna Sponge filter

ACCESSORI A RICHIESTA/ ACCESSORIES ON DEMAND

FILTRO A SACCO SUPER SUPER FILTER BAG	FILTRO CARTUCCIA POLIESTERE CLASSE M - KIT COMPLETO CARTRIDGE POLYESTER FILTER CLASS M - COMPLETE KIT	FILTRO HEPA CLASSE H13 - KIT COMPLETO HEPA FILTER CLASS H13 - COMPLETE KIT
Mod. Tutti-All Cod. 004.335	Mod. Tutti-All Cod. 004.479	Mod. Tutti-All Cod. 004.411
FILTRO NYLON NYLON FILTER	FILTRO CALOR HEAT-RESISTANT FILTER	KIT FORNO OVEN KIT
Mod. Tutti-All Cod. 004.103	Mod. SM 80 Cod. 004.110	Mod. SM 80 Cod. 004.332
KIT TUBO SCARICO LIQUIDI LIQUID DISCHARGE PIPE KIT		
Mod. SP 80 F - SM 80 F ** Cod. 004.425		

(\*\*) Installato in fase di produzione macchina - Must be installed during manufacturing

**SP & SM 80 F - B PL - B AC - ASPIRAPOLVERE/LIQUIDI A 2/3 MOTORI CON CARRELLO FISSO/BASCULANTE**  
**MULTIPLE-MOTOR (2/3 MOTORS) WET & DRY VACUUM CLEANERS WITH FIXED/TIP & TILTING TROLLEY**

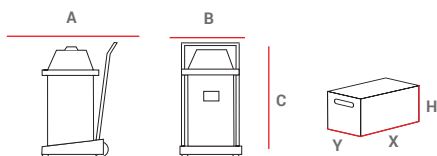

PESI E DIMENSIONI MACCHINA WEIGHTS AND DIMENSIONS MACHINE					IMBALLO PACKAGING			
MOD	A	B	C	Netto/Net	X	Y	H	Lordo/Gross
	[mm]	[mm]	[mm]	[kg]	[mm]	[mm]	[mm]	[kg]
SP 80 3HP F	630	460	980	23	604	694	1.035	27,2
SP 80 4HP F	630	460	980	25,2	604	694	1.035	29,4
SM 80 3HP F	630	460	980	25	604	694	1.035	29,2
SM 80 4HP F	630	460	980	27,2	604	694	1.035	31,4
SP 80 3HP B PL	630	480	980	22,2	604	694	1.035	26,4
SP 80 4HP B PL	630	480	980	24,2	604	694	1.035	28,6
SM 80 3HP B PL	630	480	980	24,2	604	694	1.035	28,4
SM 80 4HP B PL	630	480	980	26,4	604	694	1.035	30,6
SP 80 3HP B AC	630	480	880	21,8	604	694	1.035	26
SP 80 4HP B AC	630	480	880	24	604	694	1.035	28,2
SM 80 3HP B AC	630	480	930	23,8	604	694	1.035	28
SM 80 4HP B AC	630	480	930	26	604	694	1.035	30,2

		SP 80 3HP F	SP 80 4HP F	SM 80 3HP F	SM 80 4HP F
codice - code		● 008.364	● 008.366	● 008.365	● 008.367
potenza max - max. power	[W]	2.400	3.500	2.400	3.500
alimentazione - power supply	[V-ph-Hz]	230-1-50/60	230-1-50/60	230-1-50/60	230-1-50/60
tipo motore - motor type		BP	BP	BP	BP
motori - motors	[NR]	2	3	2	3
depressione - water lift	[mm H <sub>2</sub> O]	2.500	2.500	2.500	2.500
portata aria - air flow	[m <sup>3</sup> /h]	430	650	430	650
volume fusto in litri - tank volume in liters	[l]	80	80	80	80
materiale fusto - tank material		PP	PP	SS 430	SS 430
livello rumore - noise level	[dBA]	78	79	78	79
kit accessori - attachments kit	[mm]	40	40	40	40
dimensioni pallet - pallet dimensions	[cm]	110x130x217	110x130x217	110x130x217	110x130x217
quantità per pallet - pallet quantities	[pz - pcs]	8	8	8	8

		SP 80 3HP B PL	SP 80 4HP B PL	SM 80 3HP B PL	SM 80 4HP B PL
codice - code		● 008.340	● 008.342	● 008.341	● 008.343
potenza max - max. power	[W]	2.400	3.500	2.400	3.500
alimentazione - power supply	[V-ph-Hz]	230-1-50/60	230-1-50/60	230-1-50/60	230-1-50/60
tipo motore - motor type		BP	BP	BP	BP
motori - motors	[NR]	2	3	2	3
depressione - water lift	[mm H <sub>2</sub> O]	2.500	2.500	2.500	2.500
portata aria - air flow	[m <sup>3</sup> /h]	430	650	430	650
volume fusto in litri - tank volume in liters	[l]	80	80	80	80
materiale fusto - tank material		PP	PP	SS 430	SS 430
livello rumore - noise level	[dBA]	78	79	78	79
kit accessori - attachments kit	[mm]	40	40	40	40
dimensioni pallet - pallet dimensions	[cm]	110x130x217	110x130x217	110x130x217	110x130x217
quantità per pallet - pallet quantities	[pz - pcs]	8	8	8	8

		SP 80 3HP B AC	SP 80 4HP B AC	SM 80 3HP B AC	SM 80 4HP B AC
codice - code		● 008.373	● 008.379	● 008.376	● 008.380
potenza max - max. power	[W]	2.400	3.500	2.400	3.500
alimentazione - power supply	[V-ph-Hz]	230-1-50/60	230-1-50/60	230-1-50/60	230-1-50/60
tipo motore - motor type		BP	BP	BP	BP
motori - motors	[NR]	2	3	2	3
depressione - water lift	[mm H <sub>2</sub> O]	2.500	2.500	2.500	2.500
portata aria - air flow	[m <sup>3</sup> /h]	430	650	430	650
volume fusto in litri - tank volume in liters	[l]	80	80	80	80
materiale fusto - tank material		PP	PP	SS 430	SS 430
livello rumore - noise level	[dBA]	78	79	78	79
kit accessori - attachments kit	[mm]	40	40	40	40
dimensioni pallet - pallet dimensions	[cm]	110x130x217	110x130x217	110x130x217	110x130x217
quantità per pallet - pallet quantities	[pz - pcs]	8	8	8	8

Lunghezza cavo elettrico per tutti i modelli= 7m - Electric cable length for all models= 7m

BP = Bistadio con raffreddamento bypass - 2 stage with bypass cooling

PP = polipropilene - polypropylene

SS 430 = Inox AISI 430 - Stainless steel AISI 430



## EX 40 - 80

ASPIRAPOLVERE/LIQUIDI COMBINATI CON MACCHINA A INIEZIONE ED ESTRAZIONE  
WET & DRY VACUUM CLEANERS COMBINED WITH A CARPET/UPHOLSTERY CLEANING MACHINE

- Questi modelli combinano in un unico apparecchio tutte le caratteristiche di un aspirapolvere/liquidi con una macchina a iniezione/estrazione
  - La soluzione detergente viene spruzzata direttamente sulla superficie da pulire attraverso una speciale pompa iniezione a bassa pressione. Gli speciali accessori utilizzati a tale scopo sono utili anche per la loro azione meccanica nella pulizia e smacchiatura delle superfici
  - I potenti motori rimuovono lo sporco e i liquidi dalle superfici lasciandole asciutte. Un modo estremamente sicuro ed efficace per lavare e pulire adeguatamente anche i tessuti e le superfici più delicate come tappeti, tappezzerie, materassi, interni auto, pavimenti, pareti, etc.
  - Modelli nuovi EX 80 P PRO e EX 80 M PRO per il professionista esigente: costruiti con una pompa a membrana con bypass e pressostato integrato specialmente progettato, testato e provato nelle condizioni più severe di lavoro
- *Full use of a wet & dry vacuum cleaner combined with a carpet and upholstery cleaning machine, all in one unit*
  - *A special low-pressure injection pump sprays detergent solution onto the surface to be cleaned and the special attachments used for this purpose also help in mechanical cleaning and stain removal*
  - *The powerful vacuum motor(s) will then remove all dirt and liquids from the surface, leaving it almost dry. A very safe and effective way to wash and properly clean even the most sensitive fabrics and surfaces such as carpets, upholstery, mattresses, car interiors, floors, walls, etc.*
  - *New and improved extra durable and reliable models EX 80 P PRO and EX 80 M PRO for the demanding professional: constructed with a specially designed membrane pump with integrated bypass and pressure switch, tested and proven under the harshest conditions*

EX 40      EX 80 M ECO - EX 80 M PRO      EX 80 P ECO - EX 80 P PRO



POMPA - PUMP  
EX 40 - EX 80

POMPA - PUMP  
EX 80 PRO



## ACCESSORI IN DOTAZIONE / SUPPLIED ACCESSORIES

	MOD.	COD.	DESCRIZIONE - DESCRIPTION
	EX 40	004.453	Bocchetta a mano + tubo (l= 1,8m) Upholstery hand tool, complete with flexible hose (l= 1,8m)
	EX 80	004.398	Bocchetta a mano + tubo (l= 3m) Upholstery hand tool, complete with flexible hose (l= 3m)
	EX 40	004.424	Filtro in Poliestere con anello portafiltro Polyester filter with support ring
	EX 80	004.134	Filtro in Poliestere con anello portafiltro Polyester filter with support ring
	EX 40	004.410	Filtro spugna Sponge filter
	EX 80	004.367	Filtro spugna Sponge filter

## ACCESSORI A RICHIESTA/ ACCESSORIES ON DEMAND

KIT 40 KIT 40	LANCIA PAVIMENTI / MOQUETTE FLOOR / CARPET WAND
	
<b>Mod. Tutti-All</b> Tubo flessibile diam.40 mm completo (l= 3m) Flexible hose diam.40 mm complete (l= 3m) <b>Cod.</b> 004.329	1
<b>Mod. Tutti-All</b> Doppia curva acciaio diam.40 mm Double-elbow steel tube, diam.40 mm <b>Cod.</b> 004.046	2
<b>Mod. Tutti-All</b> Spazzola setole "S" diam.40 mm Brush floor tool "S" diam.40 mm <b>Cod.</b> 004.331	3
<b>Mod. Tutti-All</b> Ventosa liquidi diam.40 mm Squeegee floor tool diam.40 mm <b>Cod.</b> 004.326	4
<b>Mod. Tutti-All</b> Lancia piatta diam.40 mm Crevice tool diam.40 mm <b>Cod.</b> 004.421	5
<b>Mod. Tutti-All</b> Pennello diam.40 mm Round brush diam.40 mm <b>Cod.</b> 004.088	6
	<b>Mod. EX 40</b> <b>Cod.</b> 004.391 Lancia pavimenti / moquette con 1 ugello Floor / carpet wand with 1 spray nozzle
	<b>Mod. EX 80</b> <b>Cod.</b> 004.405 Lancia pavimenti / moquette con 2 ugelli Floor / carpet wand with 2 spray nozzles



# EX 40-80 - ASPIRAPOLVERE/LIQUIDI COMBINATI CON MACCHINA A INIEZIONE ED ESTRAZIONE WET & DRY VACUUM CLEANERS COMBINED WITH A CARPET/UPHOLSTERY CLEANING MACHINE

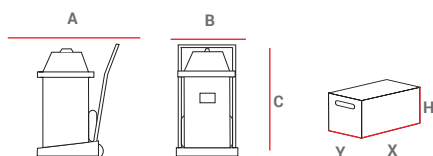

PESI E DIMENSIONI MACCHINA WEIGHTS AND DIMENSIONS MACHINE					IMBALLO PACKAGING			
MOD	A	B	C	Netto/Net	X	Y	H	Lordo/Gross
	[mm]	[mm]	[mm]	[kg]	[mm]	[mm]	[mm]	[kg]
EX 40 M	430	430	720	12,8	474	474	760	13,8
EX 80 P ECO	630	460	980	23,2	694	604	1.035	27,4
EX 80 M ECO	630	460	980	25,2	694	604	1.035	29,4
EX 80 P PRO	630	460	980	24,8	694	640	1.035	29
EX 80 M PRO	630	460	980	26,8	694	640	1.035	31

		EX 40 M	EX 80 P ECO	EX 80 M ECO	EX 80 P PRO	EX 80 M PRO
codice - code		● 008.407	● 008.316	● 008.317	● 008.465	● 008.466
potenza max - max. power	[W]	1.000+65	2.400+65	2.400+65	2.400+50	2.400+50
alimentazione - power supply	[V - ph - Hz]	230-1-50/60	1-230/50-60	1-230/50-60	1-230/50-60	1-230/50-60
tipo motore - motor type		BP	BP	BP	BP	BP
motori - motors	[NR]	1	2	2	2	2
depressione - water lift	[mm H <sub>2</sub> O]	2.400	2.500	2.500	2.500	2.500
portata aria - air flow	[m <sup>3</sup> /h]	180	430	430	430	430
pressione erogata - delivered pressure	[bar]	3,0	3,0	3,0	3,0	3,0
portata pompa resa - delivered flow rate	[l/min]	1,0	1,0	1,0	1,0	1,0
volume fusto in litri - tank volume in liters	[l]	40	80	80	80	80
volume serbatoio acqua pulita clean water tank volume	[l]	3	16	16	16	16
materiale fusto - tank material		SS 430	PP	SS 430	PP	SS 430
livello rumore - noise level	[dBA]	65	78	78	78	78
kit accessori - attachments kit	[mm]	40	40	40	40	40
lunghezza cavo elettrico - electric cable lenght	[m]	7	7	7	7	7
dimensioni pallet - pallet dimensions	[cm]	110x130x160	110x130x217	110x130x217	110x130x217	110x130x217
quantità per pallet - pallet quantities	[pz - pcs]	12	8	8	8	8

BP = Bistadio con raffreddamento bypass - 2 stage with bypass cooling

PP = polipropilene - polypropylene

SS 430 = Inox AISI 430 - Stainless steel AISI 430





# AS 3

ASCIUGATORE PROFESSIONALE PER INTERNI DI AUTOVEICOLI

*PROFESSIONAL DRYER FOR VEHICLE INTERIORS*

## AS 3 - ASCIUGATORE PROFESSIONALE PER INTERNI DI AUTOVEICOLI

- La combinazione fra un generatore d'aria calda elettrico, tubi di diffusione e teli di contenimento aria, consente l'asciugatura di sedili, tappetini, baule in brevissimo tempo, velocizzando notevolmente i tempi di riconsegna dell'autovettura
  - Silenzioso ventilatore radiale a pale rovesce
  - Struttura in acciaio inox AISI 430
  - Base asciugatore installato su quattro robuste ruote per una maggiore stabilità
  - Resistenze elettriche corazzate AISI 321 avvolte a profilo ad alto scambio termico
  - Selettore di potenza
  - Termostato di sicurezza a riarmo manuale
  - Ruote in gomma antitraccia
  - Paraurti in gomma per protezione antiurto
  - Cavo di alimentazione (1,5 m) con spina schuko
- *The combination of an electric hot air generator, diffusion pipes and air containment sheets allows the drying of seats, mats and car trunk in a very short time, considerably speeding up delivery times*
  - *Silent reverse blade radial fan*
  - *Stainless steel AISI 430 body*
  - *Mounted on sturdy wheels base for extra stability*
  - *Extra strenght elements AISI 321 for high performance*
  - *Selector switch*
  - *Safety thermostat with manual reset*
  - *Non Marking rubber wheels*
  - *Rubber bumper for shock protection*
  - *Power cord (1,5 m) with schuko plug*



ACCESSORI IN DOTAZIONE / SUPPLIED ACCESSORIES

	COD.	DESCRIZIONE - DESCRIPTION
	02AC475*	Sacco asciuga sedili anteriori (x2) <i>Front seat drying bag (x2)</i>
	02AC476	Sacco doppio asciuga sedili posteriori <i>Rear seat double drying bag</i>
	02AC477*	Diffusori aria (x2) <i>Air diffuser (x2)</i>
	I40813	Tubo flessibili aria calda - l= 1.420mm (Ø=76mm) <i>Flexible hot air hose - l= 1.420mm (Ø=76mm)</i>
	I40814	Tubo flessibili aria calda - l= 2.000mm (Ø=76mm) <i>Flexible hot air hose - l= 2.000mm (Ø=76mm)</i>

\* Codice e prezzo riferiti a 1 singolo pezzo - Code and price referred to 1 single piece

PRINCIPIO DI FUNZIONAMENTO / OPERATING PRINCIPLES

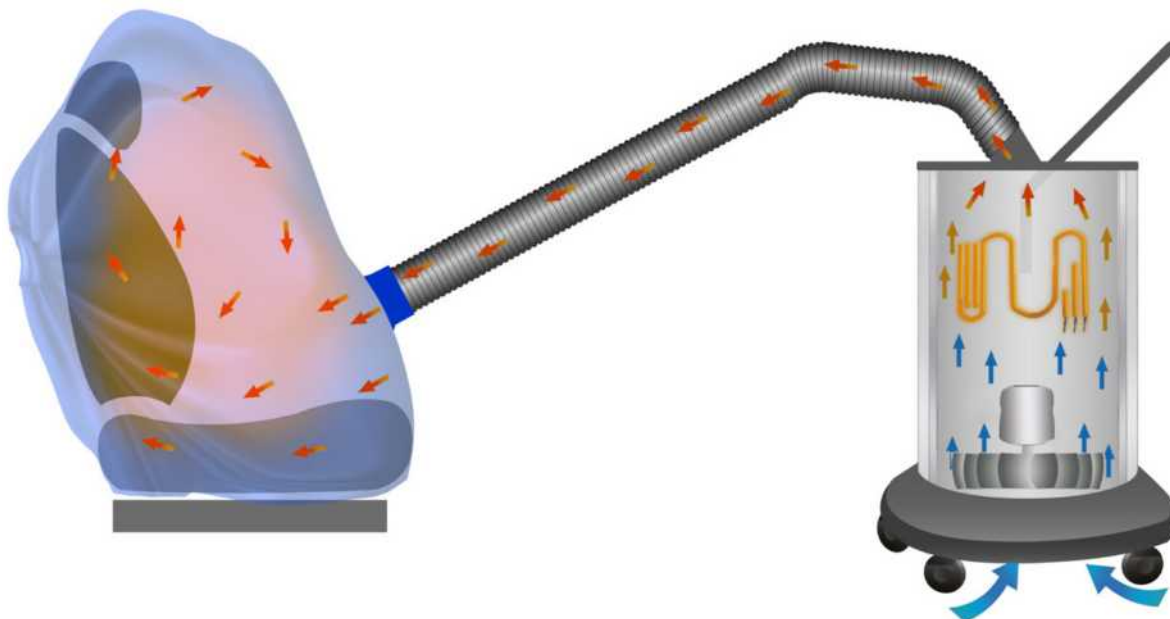

# AS 3 - ASCIUGATORE PROFESSIONALE PER INTERNI DI AUTOVEICOLI PROFESSIONAL DRYER FOR VEHICLE INTERIORS

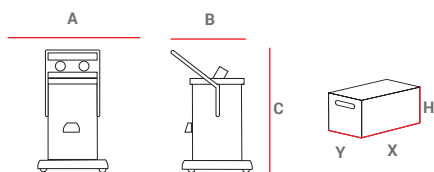

PESI E DIMENSIONI MACCHINA WEIGHTS AND DIMENSIONS MACHINE					IMBALLO PACKAGING			
MOD	A	B	C	Netto/Net	X	Y	H	Lordo/Gross
	[mm]	[mm]	[mm]	[kg]	[mm]	[mm]	[mm]	[kg]
AS 3	461	509	894	21	518	518	970	25

		AS 3
codice code		● 06EK111
potenza riscaldamento min. min. heat power	[ W ]	1500
potenza riscaldamento max max heat power	[ W ]	3200
potenza resa (motore ventilatore) output power (fan motor)	[ W ]	200
portata aria air flow	[ m <sup>3</sup> /h ]	1100
corrente massima current max	[ A ]	14
alimentazione power supply	[ V - ph - Hz ]	230-1-50
livello rumore noise level	[ dBA ] at 2m	60
quantità per pallet pallet quantities	[ pz - pcs ]	4



# SP 80 EVAC

---

ASPIRAPOLVERE/LIQUIDI CON POMPA DI SCARICO  
WET & DRY VACUUM CLEANERS WITH DISCHARGE PUMP

## SP 80 EVAC - ASPIRATORE CON POMPA DI SCARICO - VACUUM CLEANERS WITH DISCHARGE PUMP

- Una pompa potente e integrata a immersione fa di questa macchina un attrezzo unico e versatile particolarmente indicato per l'aspirazione e l'espulsione dei liquidi dalle zone inondate, dalle cisterne e per servizi di emergenza
- Due motori d'aspirazione bi-stadio bypass aspirano velocemente e con efficienza grandi quantità di liquidi
- La pompa, con 800 W di potenza, espelle velocemente i liquidi a lunghe distanze e fino a 8 metri di altezza
- Un sofisticato sistema elettronico rileva il livello del liquido nel serbatoio spegnendo automaticamente i motori di aspirazione quando la pompa di scarico deve essere attivata
- La pompa si spegne automaticamente quando il serbatoio si è svuotato
- Impostando la modalità totalmente automatica, le operazioni di aspirazione ed evacuazione si svolgono automaticamente ed in continuo, senza interruzioni
- Un tubo di scarico aggiuntivo è incluso nella macchina
- A powerful integrated submersible pump makes this a unique and versatile machine, particularly useful in draining flooded areas, emptying tanks, and emergency services
- Two double-stage bypass vacuum motors collect large amounts of liquid quickly and efficiently
- With 800 W of power, the pump will pump out liquids at an amazing speed over long distances and even elevations of up to 8 metres in height
- A sophisticated electronic system detects the level of liquid in the tank and automatically turns off the vacuum motors when the discharge pump needs to be activated
- The pump turns off automatically when the tank is drained
- Select the fully automatic mode for seamless, automatic and continuous operation of the vacuum and evacuation systems, without interruption
- Additional drain hose for small and quick jobs included



## ACCESSORI IN DOTAZIONE / SUPPLIED ACCESSORIES

	N°	MOD.	COD.	DESCRIZIONE - DESCRIPTION
	1	Tutti - All	004.329	Tubo flessibile diam.40 mm completo (l= 3m) Flexible hose diam.40 mm complete (l= 3m)
	2	Tutti - All	004.046	Doppia curva acciaio diam.40 mm Double-elbow steel tube, diam. 40 mm
	3	Tutti - All	004.326	Ventosa liquidi diam.40 mm - Squeegee floor tool diam.40 mm
	4	Tutti - All	004.421	Lancia piatta diam.40 mm - Crevice tool diam.40 mm
	5	Tutti - All	004.499.025	Filtro rete nylon - Nylon mesh filter

## ACCESSORI A RICHIESTA/ ACCESSORIES ON DEMAND

FILTRO IN POLIESTERE CON ANELLO PORTA FILTRO POLYESTER FILTER WITH SUPPORT RING	FILTRO A SACCO SUPER SUPER FILTER BAG	SPAZZOLA SETOLE "S" DIAM.40 mm BRUSH FLOOR TOOL "S" DIAM. 40 mm	PENNELLO DIAM. 40 mm ROUND BRUSH DIAM. 40 mm
Mod. Tutti-All Cod. 004.134	Mod. Tutti-All Cod. 004.335	Mod. Tutti-All Cod. 004.331	Mod. Tutti-All Cod. 004.088

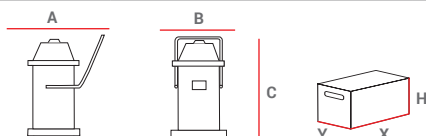

PESI E DIMENSIONI MACCHINA WEIGHTS AND DIMENSIONS MACHINE					IMBALLO PACKAGING			
MOD	A	B	C	Netto/Net	X	Y	H	Lordo/Gross
	[mm]	[mm]	[mm]	[kg]	[mm]	[mm]	[mm]	[kg]
SP 80 EVAC	480	480	880	23	694	604	1.035	27,20

		SP 80 EVAC
codice - code		008.361
potenza - power	[ W ] motors	2.400
	[ W ] pump	700
alimentazione - power supply	[ V - ph - Hz ]	230-1-50/60
tipo motore /n°motori - motor type/n° of motors	[ nr ]	BP-2
depressione - water lift	[ mm H2O ]	2.500
portata aria - air flow	[ m3/h ]	430
erogazione pompa - pump water flow	[ l/min ]	225
prevalenza pompa (max) - pump water lift (max)	[ m ]	8
volume fusto in litri - tank volume in liters	[ l ]	80
materiale fusto - tank material		PP
livello rumore - noise level	[ dBA ]	78
kit accessori - attachments kit	[ mm ]	40
dimensioni pallet - pallet dimensions	[ cm ]	110x130x217
quantità per pallet - pallet quantities	[ pz - pcs ]	8





# RC 40 - 45 - 80

ASPIRAPOLVERE/LIQUIDI PER UTILIZZO ABBINATO AD ELETTROUTENSILI  
WET & DRY VACUUM CLEANERS DESIGNED FOR USE WITH POWER HAND TOOLS

- Progettati per essere utilizzati con elettROUTENSILI (trapani, levigatrici, seghe elettriche, etc...) in modo che quando lo strumento è acceso l'aspirapolvere si accende automaticamente e tutta la polvere e i detriti creati durante il funzionamento dell'attrezzo sono convogliati nel serbatoio attraverso uno speciale tubo flessibile di collegamento
- Questo sistema elimina la polvere alla sorgente, impedendone la diffusione nell'ambiente con conseguenti difficoltà di respirazione, e contribuisce a preservare l'area di lavoro pulita e senza polvere
- *Designed to be used with power hand tools (drills, sanders, saws, etc...) in a way that when the tool is turned on, the vacuum cleaner turns on automatically and the dust and debris created during the operation of the power tool is vacuumed and carried to the tank through the special connecting flexible hose*
- *Removes the dust right from the source, preventing it from getting scattered throughout the work space and causing breathing difficulties, and it helps maintain the work area clean and dust-free*

RC 40 M

RC 45 P

RC 80 M

RC 80 P







Utensile non fornito - Power/pneumatic tools not supplied



## ACCESSORI IN DOTAZIONE / SUPPLIED ACCESSORIES

	N°	MOD.	COD.	DESCRIZIONE - DESCRIPTION
		Tutti - All	004.412	Kit RC (l= 3m) RC Kit (l= 3m)
		RC 40 M - RC 45 P	004.424	Filtro in Poliestere con anello portafiltro Polyester filter with support ring
		RC 80 P - RC 80 M	004.134	Filtro in Poliestere con anello portafiltro Polyester filter with support ring
		RC 40 M - RC 45 P	004.410	Filtro spugna Sponge filter
		RC 80 M - RC 80 P	004.367	Filtro spugna Sponge filter
		RC 40 M - RC 45 P	004.335	Filtro a sacco super Super filter bag

## ACCESSORI A RICHIESTA/ ACCESSORIES ON DEMAND

KIT 40 KIT 40	FILTRO A SACCO SUPER SUPER FILTER BAG	FILTRO CARTUCCIA POLIESTERE CLASSE M CARTRIDGE POLYESTER FILTER CLASS M
		
<b>Mod. Tutti-All</b> Tubo flessibile diam.40 mm completo (l= 3m) Flexible hose diam.40 mm complete (l= 3m) <b>Cod. 004.329</b>	<b>Mod. Tutti-All</b> <b>Cod. 004.335</b>	<b>Mod. RC 40 - RC 45 P</b> <b>Cod. 004.387</b> <b>Mod. RC 80 M - RC 80 P (complete kit)</b> <b>Cod. 004.479</b>
<b>Mod. Tutti-All</b> Doppia curva acciaio diam.40 mm Double-elbow steel tube, diam.40 mm <b>Cod. 004.046</b>	<b>FILTRO HEPA CLASSE H13 HEPA FILTER CLASS H13</b>	<b>FILTRO NYLON NYLON FILTER</b>
<b>Mod. Tutti-All</b> Spazzola setole "S" diam.40 mm Brush floor tool "S" diam.40 mm <b>Cod. 004.331</b>		
<b>Mod. Tutti-All</b> Ventosa liquidi diam.40 mm Squeegee floor tool diam.40 mm <b>Cod. 004.326</b>		
<b>Mod. Tutti-All</b> Lancia piatta diam.40 mm Crevice tool diam.40 mm <b>Cod. 004.421</b>		
<b>Mod. Tutti-All</b> Pennello diam.40 mm Round brush diam.40 mm <b>Cod. 004.088</b>	<b>Mod. RC 40 - RC 45 P</b> <b>Cod. 004.437</b> <b>Mod. RC 80 M - RC 80 P (complete kit)</b> <b>Cod. 004.411</b>	<b>Mod. RC 40 - RC 45 P</b> <b>Cod. 004.180</b> <b>Mod. RC 80 M - RC 80 P</b> <b>Cod. 004.103</b>

# RC 40-80 - ASPIRAPOLVERE/LIQUIDI PER UTILIZZO ABBINATO AD ELETTROUTENSILI WET & DRY VACUUM CLEANERS DESIGNED TO BE USED WITH POWER HAND TOOLS

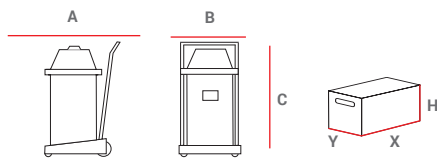

PESI E DIMENSIONI MACCHINA WEIGHTS AND DIMENSIONS MACHINE					IMBALLO PACKAGING			
MOD	A	B	C	Netto/Net	X	Y	H	Lordo/Gross
	[mm]	[mm]	[mm]	[kg]	[mm]	[mm]	[mm]	[kg]
RC 45 P	430	430	720	8,8	474	474	760	10,4
RC 40 M	430	430	720	9,5	474	474	760	11,1
RC 80 P	630	460	980	21,2	694	604	1.035	25,4
RC 80 M	630	460	980	23,2	694	604	1.035	27,4

		RC 45 P	RC 40 M	RC 80 P	RC 80 M
codice - code		● 008.320	● 008.346	● 008.345	● 008.368
potenza max - max. power	[ W ]	1.000	1.000	2.400	2.400
consumo massimo macchina utensile power hand tools maximum consumption	[ W ]	1.500	1.500	1.500	1.500
alimentazione - power supply	[ V - ph - Hz ]	230-1-50/60	230-1-50/60	230-1-50/60	230-1-50/60
tipo motore - motor type		BP	BP	BP	BP
motori - motors	[ nr ]	1	1	2	2
depressione - water lift	[ mm H <sub>2</sub> O ]	2.400	2.400	2.500	2.500
portata aria - air flow	[ m <sup>3</sup> /h ]	180	180	430	430
volume fusto in litri - tank volume in liters	[ l ]	45	40	80	80
materiale fusto - tank material		PE HD	SS 430	PP	SS 430
livello rumore - noise level	[ dBA ]	65	65	78	78
kit accessori - attachments kit	[ mm ]	36	36	36	36
lunghezza cavo elettrico - electric cable lenght	[ m ]	7	7	7	7
dimensioni pallet - pallet dimensions	[ cm ]	110x130x160	110x130x160	110x130x217	110x130x217
quantità per pallet - pallet quantities	[ pz - pcs ]	12	12	8	8

BP = Bistadio con raffreddamento bypass - 2 stage with bypass cooling

PP = polipropilene - polypropylene

SS 430 = Inox AISI 430 - Stainless steel AISI 430

PE HD = Polietilene alta densità - High density polyethylene



CON SCUOTIFILTRO AUTOMATICO  
*WITH AUTOMATIC FILTER CLEANER*



# MRC 30 - 45 - 65

ASPIRAPOLVERI PER UTILIZZO CON ELETTROUTENSILI ED UTENSILI PNEUMATICI - PER POLVERI  
PERICOLOSE IN CLASSE M

*VACUUM CLEANERS FOR USE WITH POWER AND PNEUMATIC TOOLS - FOR HAZARDOUS  
DUST IN CLASS M*



## MRC 30-45-65 - ASPIRAPOLVERI PER UTILIZZO CON ELETTROUTENSILI ED UTENSILI PNEUMATICI - PER POLVERI PERICOLOSE IN CLASSE M

- Progettati per essere utilizzati con elettroutensili (trapani, levigatrici, seghe elettriche, etc...) in modo che quando lo strumento è acceso l'aspirapolvere si accende automaticamente e tutta la polvere e i detriti creati durante il funzionamento dell'attrezzo sono convogliati nel serbatoio attraverso uno speciale tubo flessibile di collegamento
  - Questo sistema elimina la polvere alla sorgente, impedendone la diffusione nell'ambiente conseguenti difficoltà di respirazione, e contribuisce a preservare l'area di lavoro pulita e senza polvere
  - Filtri specificamente progettati per l'uso con polveri pericolose in Classe M
  - Dotati di un innovativo meccanismo automatico di pulizia del filtro: il filtro viene pulito automaticamente ad ogni spegnimento dell'utensile
  - Una spia luminosa altamente visibile avverte l'utente quando il filtro deve essere pulito ed il meccanismo di pulizia del filtro deve essere attivato
  - Filtro a cartuccia in Classe M e filtro a sacco Super in microfibra con elevata efficienza di filtrazione
  - Il modello MRC 65 è stato progettato per essere utilizzato con elettroutensili e con utensili pneumatici
- *Designed to be used with power hand tools (drills, sanders, saws, etc...) in a way that when the tool is turned on, the vacuum cleaner turns on automatically and the dust and debris created during the operation of the power tool is vacuumed and carried to the tank through the special connecting flexible hose*
  - *Removes the dust right from the source, preventing it from getting scattered throughout the work space and causing breathing difficulties, and it helps maintain the work area clean and dust-free*
  - *Special filter suitable for use with hazardous dust in Class M*
  - *Equipped with an innovative and state of the art automatic filter cleaning mechanism: the filter is cleaned automatically each time the tool is turned off*
  - *A highly visible warning light alerts the user when the filter needs to be cleaned and the filter cleaning mechanism needs to be activated*
  - *Class M cartridge filter and microfiber Super filter bag with high filtration efficiency*
  - *Top of the line model MRC 65 is designed for use with power hand tools as well as pneumatic tools*







Utensile non fornito - Power/pneumatic tools not supplied









## ACCESSORI IN DOTAZIONE / SUPPLIED ACCESSORIES

	N°	MOD.	COD.	DESCRIZIONE - DESCRIPTION
		Tutti - All	004.412	Kit RC (l= 3m) RC Kit (l= 3m)
		MRC 65	004.310	Kit MRC aria (l= 10m) MRC air kit (l= 10m)
		Tutti - All	004.387	Filtro cartuccia poliestere Classe M Cartridge polyester filter Class M
		MRC 30	004.321	Filtro a sacco super Super filter bag
		MRC 45 - MRC 65	004.335	



## ACCESSORI A RICHIESTA/ ACCESSORIES ON DEMAND

KIT 36 DRY KIT 36 DRY	KIT 40 DRY KIT 40 DRY	FILTRO HEPA CLASSE H13 HEPA FILTER CLASS H13
		
<b>Mod.</b> MRC 30 Tubo flessibile diam.36 mm completo (l= 1,80m) Flexible hose diam.36 mm complete (l= 1,80m) <b>Cod.</b> 004.317	<b>Mod.</b> MRC 45-65 Tubo flessibile diam.40 mm completo (l= 3m) Flexible hose diam.40 mm complete (l= 3m) <b>Cod.</b> 004.329	<b>Mod.</b> Tutti-All <b>Cod.</b> 004.437
<b>Mod.</b> MRC 30 Prolunga acciaio diam. 36 mm (2 pezzi) Extension tubes (2 pieces), steel diam.36 mm <b>Cod.</b> 004.404*	<b>Mod.</b> MRC 45-65 Doppia curva acciaio diam.40 mm Double-elbow steel tube, diam.40 mm <b>Cod.</b> 004.046	<b>FILTRO NYLON NYLON FILTER</b>
<b>Mod.</b> MRC 30 Spazzola combinata diam.36 mm Combination brush diam.36 mm <b>Cod.</b> 004.399	<b>Mod.</b> MRC 45-65 Spazzola setole "S" diam.40 mm Brush floor tool "S" diam.40 mm <b>Cod.</b> 004.331	
<b>Mod.</b> MRC 30 Lancia piatta diam.36 mm Crevice tool diam.36 mm <b>Cod.</b> 004.400	<b>Mod.</b> MRC 45-65 Lancia piatta diam.40 mm Crevice tool diam.40 mm <b>Cod.</b> 004.421	
<b>Mod.</b> MRC 30 Pennello diam.36 mm Round brush diam.36 mm <b>Cod.</b> 004.402	<b>Mod.</b> MRC 45-65 Pennello diam.40 mm Round brush diam.40 mm <b>Cod.</b> 004.088	<b>Mod.</b> MRC 30 - MRC 45 <b>Cod.</b> 004.180
<b>Mod.</b> MRC 30 Bocchettina diam.36 mm Upholstery tool diam.36 mm <b>Cod.</b> 004.401		<b>Mod.</b> MRC 65 <b>Cod.</b> 004.103

**MRC 30-45-60 - ASPIRAPOLVERI PER UTILIZZO CON ELETTROUTENSILI ED UTENSILI PNEUMATICI - PER POLVERI PERICOLOSE IN CLASSE M**  
**VACUUM CLEANERS FOR USE WITH POWER AND PNEUMATIC TOOLS - FOR HAZARDOUS DUST IN CLASS M**

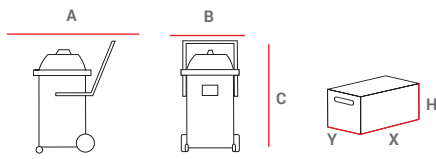

PESI E DIMENSIONI MACCHINA WEIGHTS AND DIMENSIONS MACHINE				IMBALLO PACKAGING				
MOD	A	B	C	Netto/Net	X	Y	H	Lordo/Gross
	[mm]	[mm]	[mm]	[kg]	[mm]	[mm]	[mm]	[kg]
MRC 30	430	430	518	8,2	474	474	580	10,2
MRC 45	430	430	720	8,8	474	474	760	10,8
MRC 65	445	415	800	12,5	694	604	1.035	14,5

		MRC 30	MRC 45	MRC 65
codice - code		● 008.397	● 008.398	● 008.347
potenza max - max. power	[ W ]	1.000	1.000	1.200
consumo massimo macchina utensile power hand tools maximum consumption	[ W ]	1.500	1.500	1.500
alimentazione - power supply	[ V - ph - Hz ]	230-1-50/60	230-1-50/60	230-1-50/60
tipo motore - motor type		BP	BP	BP
motori - motors	[ nr ]	1	1	1
depressione - water lift	[ mm H <sub>2</sub> O ]	2.500	2.500	2.500
portata aria - air flow	[ m <sup>3</sup> /h ]	210	210	210
volume fusto in litri - tank volume in liters	[ l ]	30	45	65
materiale fusto - tank material		PE HD	PE HD	PE HD
livello rumore - noise level	[ dBA ]	65	65	65
kit accessori - attachments kit	[ mm ]	36	36	36
lunghezza cavo elettrico - electric cable lenght	[ m ]	7	7	7
dimensioni pallet - pallet dimensions	[ cm ]	110x130x190	110x130x160	110x130x217
quantità per pallet - pallet quantities	[ pz - pcs ]	18	12	8

BP = Bistadio con raffreddamento bypass - 2 stage with bypass cooling

PE HD = Polietilene alta densità - High density polyethylene



# MAXIM 40-70 M OIL

ASPIRALIQUIDI PROFESSIONALE PER SEPARAZIONE E RECUPERO DI OLIO EMULSIONATO E TRUCIOLI  
PROFESSIONAL VACUUM CLEANER FOR PICK-UP AND SEPARATION OF EMULSIFIED OIL AND CHIPPINGS

# MAXIM 40-70 M OIL - ASPIRALIQUIDI PROFESSIONALE PER SEPARAZIONE E RECUPERO DI OLIO EMULSIONATO E TRUCIOLI

## PROFESSIONAL VACUUM CLEANER FOR PICK-UP AND SEPARATION OF EMULSIFIED OIL AND CHIPPINGS

- Aspiraliquidi professionale progettato specificatamente per il recupero e separazione di olio emulsionato e trucioli
  - Ideale per le officine meccaniche, tornerie ed officine lavorazione metallo
  - L'aspirazione dall'alto facilita il passaggio di liquidi e trucioli, permettendo di sfruttare al massimo la potenza e la portata del motore
  - Olio e trucioli arrivano direttamente e senza impedimento nell'apposito inserto separa-trucioli, dove i trucioli vengono separati dall'olio e trattenuti, mentre l'olio si deposita nel fusto
  - In questo modo i trucioli possono essere facilmente recuperati rimuovendo l'inserto che contiene i trucioli
  - Costruzione robusta, fusto in inox montato su resistente basamento ruote in acciaio
  - Per uso esclusivo con liquidi
- Professional vacuum cleaner designed specifically for the recovery and separation of emulsified oil and chippings
  - Ideal for use in metal working shops, with lathes and in metal forming factories
  - Upper vacuum entry facilitates the passage of liquids and chippings, allowing for the maximum expression of the power and air flow of the motor
  - Oil and chippings arrive directly and without impediment into the special separation insert, where the chippings are deposited and separated from the liquids, while the liquid components are drained into the tank
  - In this way the chippings can be easily recovered by extracting the separation insert
  - Sturdy construction, stainless steel tank mounted on a resistant steel wheel base
  - To be used exclusively for liquid pick-up



## ACCESSORI IN DOTAZIONE / SUPPLIED ACCESSORIES

	COD.	DESCRIZIONE - DESCRIPTION
	004.499.012	Filtro antistatico nylon Antistatic nylon filter
	004.410	Filtro spugna Sponge filter
	004.499.009	Tubo flessibile diam. 40 mm completo per MAXIM 40M OIL Flexible hose diam.40 mm complete for MAXIM 40M OIL
	004.095	Lancia piatta resistente a olio diam. 40 mm Oil-resistant crevice nozzle diam.40 mm
	004.399.019	Separatrucioli inox Metal shavings filtration device in inox

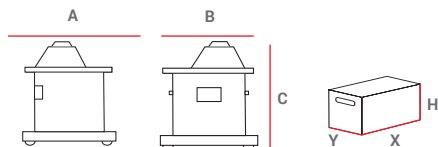

MOD	PESI E DIMENSIONI MACCHINA WEIGHTS AND DIMENSIONS MACHINE				IMBALLO PACKAGING			
	A	B	C	Netto/Net	X	Y	H	Lordo/Gross
	[mm]	[mm]	[mm]	[kg]	[mm]	[mm]	[mm]	[kg]
MAXIM 40M OIL	420	420	710	17	440	440	720	19
MAXIM 70M OIL	425	610	920	19	500	500	950	21

		MAXIM 40 M OIL	MAXIM 70 M OIL
codice - code		● 008.311	● 008.475
potenza max. - max. power	[ W ]	1.200	1.200
alimentazione - power supply	[ V - ph - Hz ]	230-1-50/60	230-1-50/60
tipo motore /n° motori- motor type/n° of motors	[ nr ]	BP-1	BP-1
depressione - water lift	[ mm H <sub>2</sub> O ]	2.400	2.400
portata aria - air flow	[ m <sup>3</sup> /h ]	220	220
volume fusto in litri - tank volume in liters	[ l ]	40	70
materiale fusto - tank material		SS 430	SS 430
livello rumore - noise level	[ dBA ]	65	65
diametro accessori - accessories diameter	[ mm ]	40	40
lunghezza cavo elettrico - electric cable length	[ m ]	7	7
dimensioni pallet - pallet dimensions	[ cm ]	110X130X160	103X103X208
quantità per pallet - pallet quantities	[ pz - pcs ]	12	8

BP = Bistadio con raffreddamento bypass - 2 stage with bypass cooling

SS 430 = Inox AISI 430 - Stainless steel AISI 430

# ASPIRAPOLVERI INDUSTRIALI INDUSTRIAL VACUUM CLEANERS



Forza aspirante, robustezza costruttiva, efficienti sistemi di filtraggio, maneggevoli sistemi di movimentazione fusti: sono queste le linee guida che Biemmedue ha seguito per progettare la propria gamma di aspiratori ed aspiraliquidi industriali.

*Superior vacuum power, robust construction, filtration efficiency, facilitated system of tank displacement: these are the guiding principles followed by Biemmedue in the design and manufacture of its range of industrial vacuum cleaners.*

### **Aspirante a turbina**

Essendo progettati per lavorare a servizio continuo, negli aspiratori industriali viene solitamente montato un aspirante a turbina. Gli aspiranti a turbina sono costruiti secondo il particolare principio dei canali laterali: l'aria aspirata, costretta a seguire un percorso a spirale per mezzo di una particolare girante, viene sottoposta a ripetute accelerazioni, che permettono di raggiungere un elevato valore di pressione e vuoto. La girante è montata direttamente sull'asse motore e tutte le parti rotanti sono dinamicamente equilibrate, ottenendo in tal modo una assoluta assenza di vibrazioni. Le turbine possono essere mono-stadio (una sola girante) o bi-stadio (due giranti).

#### **Vacuum turbine**

*The use of vacuum turbines in the construction of industrial vacuum cleaners allows for the non-stop continuous use of the vacuum cleaner. These vacuum turbines are designed according to the specific principle of lateral channels: An impeller moves the vacuumed air through an obligatory spiral route causing numerous air accelerations and resulting in substantial pressure and vacuum. The impeller is mounted directly over the motor axle and all rotating parts are dynamically stabilized, eliminating all vibrations. The turbines are either single-stage (one impeller) or two-stage (two impellers).*

### **Mono-stadio VS bi-stadio in parallelo o in serie**

Dipende dalle potenze installate, dalle dimensioni e dalle applicazioni. Punto di forza della mono-stadio è la compattezza, caratteristica per la quale è adottata principalmente quando abbiamo medio-basse potenze in gioco e necessità di dimensioni contenute. Laddove serve maggior portata d'aria, è preferibile la bi-stadio in parallelo perchè, rispetto ad una mono-stadio, si arriva a raddoppiare la portata d'aria. Qualora serve avere maggiore depressione, si utilizza la bi-stadio in serie, la quale ha portata simile alla mono-stadio ma una depressione raddoppiata.

#### **Single-stage VS two-stage turbine in parallel or in series**

*The choice largely depends on the required power, size restrictions and application requirements. The advantage of the single-stage turbine lies in its compact dimensions making it indicated in cases of low to medium power requirements in a compact vacuum cleaner. In all applications where a higher air flow is required, a two-stage turbine in parallel is advisable, providing twice as much air flow as the single-stage turbine. Conversely a double-stage turbine in series has similar air flow values as the single-stage turbine but twice as much depression.*

### **Più portata VS più depressione**

All'aumentare della lunghezza del tubo di aspirazione, è preferibile avere maggiore portata rispetto alla depressione, in quanto la portata aiuta il trasporto dello sporco attraverso i condotti. In presenza di elevata quantità di sporco e rifiuti leggeri è preferibile maggior portata mentre, nel caso di residui con alto peso specifico, la depressione è determinante, al fine di riuscire a vincere la forza di gravità dello sporco.

#### **Higher air flow VS higher depression**

*For sending dust and waste matter through longer distances and lengths of tube, a higher air flow is more helpful. Furthermore a higher air flow is indicated for the removal of large amounts of dust and light matter, whereas for the removal of heavier particles and all matter with a larger specific weight, a higher depression is required to overcome the force of gravity.*

### **Filtri**

Negli aspiratori industriali la scelta della tipologia di filtro riveste un ruolo fondamentale per la soddisfazione delle necessità di pulizia richieste dalle diverse applicazioni. Nelle pagine seguenti è stato dato ampio risalto alle diverse tipologie di filtri disponibili con chiare istruzioni di utilizzo per le diverse applicazioni.

#### **Filters**

*In industrial vacuum applications, the choice of filter plays a major role in the fulfillment of the requirements implied in various cleaning applications. In the following pages particular emphasis is placed on the variety of available filters, providing ample explanations and instructions for their diverse uses and applications.*

### **Accessori**

Dipendono molto dalle applicazioni. Per tale motivo la Biemmedue ha dedicato, in combinazione con la gamma di aspiratori industriali, una sezione specifica con i diversi accessori disponibili che vi invitiamo a scoprire nelle pagine seguenti. Inoltre, per facilitare la scelta di macchine per scopi specifici, sono state individuate le applicazioni più comuni (APPS) e per queste sono stati codificati "pacchetti" specifici per l'adattamento delle macchine.

#### **Accessories**

*The choice of accessories depends largely on the applications. For this reason, in the following pages Biemmedue has dedicated a specific section for the vast range of available accessories, which we invite you to discover. In addition, in order to facilitate the choice of industrial vacuum cleaners for specific purposes and environments, the most commonly-used applications have been identified, and the required adaptations have been packaged and codified in convenient "APPS" which can be ordered together with most of our industrial vacuum cleaners.*





# TH

ASPIRATORI INDUSTRIALI FISSI  
*STATIONARY INDUSTRIAL VACUUM CLEANERS*

## TH - ASPIRATORI INDUSTRIALI FISSI

- Aspiratori fissi per il lavoro continuo
- Adatto per la rimozione di polveri e materiali solidi da superfici di lavoro
- Normalmente installato a bordo di macchine di produzione
- Può anche essere facilmente trasportato e spostato grazie alle ruote opzionali con freni
- Potente gruppo motore / turbina che permette un utilizzo ininterrotto e senza particolare manutenzione
- Scuotifiltro manuale
- Vari filtri disponibili per diverse applicazioni
- *Stationary vacuum units for continuous work*
- *Suitable for the removal of dust and solid matter from work surfaces*
- *Normally installed aboard production machines*
- *Can also be easily transported and moved thanks to optional wheels with brakes*
- *Powerful maintenance-free motor/turbine group permit uninterrupted work*
- *Manual filter shaking mechanism*
- *Various filters available for different applications*



## ACCESSORI IN DOTAZIONE / SUPPLIED ACCESSORIES

	COD.	DESCRIZIONE - DESCRIPTION
	004.429	Filtro in poliestere Polyester filter
	004.387	Filtro cartuccia classe M Cartridge Filter class M
	004.329	Tubo flessibile diam. 40 mm completo Flexible hose diam. 40 mm complete
	004.421	Lancia Piatta diam. 40 mm Crevice tool diam. 40 mm

## ACCESSORI A RICHIESTA / ACCESSORIES ON DEMAND

	COD.	DESCRIZIONE - DESCRIPTION
	004.136*	Kit ruote Wheels kit

\* Installato in fase di produzione macchina - Must be installed during manufacturing

ACCESSORI A RICHIESTA E FILTRI VEDI PAG. 210  
ACCESSORIES ON DEMAND AND FILTER SEE PAG. 210



## APPLICAZIONI SPECIALI (APPS)

PER ASPIRATORI INDUSTRIALI DISPONIBILI (VEDERE PAG.212)

## SPECIAL APPLICATION SYSTEMS (APPS)

FOR INDUSTRIAL VACUUM CLEANERS AVAILABLE (SEE PAG.212)



ATTENZIONE: le speciali applicazioni sono realizzate esclusivamente durante la costruzione delle macchine.  
PLEASE NOTE: APPS are exclusively implemented during the construction of the vacuum cleaner.

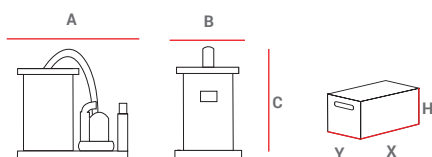

MOD	PESI E DIMENSIONI MACCHINA WEIGHTS AND DIMENSIONS MACHINE			IMBALLO PACKAGING				
	A	B	C	Netto/Net	X	Y	H	Lordo/Gross
	[mm]	[mm]	[mm]	[kg]	[mm]	[mm]	[mm]	[kg]
TH 15	890	430	845	47,2	950	480	1.020	56,2
TH 30	890	430	845	57,2	950	480	1.020	66,2
TH 40	890	430	845	55,8	950	480	1.020	64

		TH 15	TH 30	TH 40
codice - code		● 008.043	● 008.006	● 008.007
potenza max - max. power	[ W ]	1.500 W - 2 HP	2.200 W - 3 HP	3000 W - 4 HP
alimentazione - power supply	[ V - ph - Hz ]	230-1-50	230-1-50	400-3-50
tipo motore - motor type		TR	TR	TR
depressione - water lift	mm H <sub>2</sub> O	2.300	3.000	3.200
portata aria - air flow	m <sup>3</sup> h	270	350	350
volume fusto in litri - tank volume in liters	[ l ]	50	50	50
materiale fusto - tank material		INOX AISI 430	INOX AISI 430	INOX AISI 430
livello rumore - noise level	[ dBA ]	73	73	73
superficie filtrante - filter surface area	[ cm <sup>2</sup> ]	4.500	4.500	4.500
kit accessori - attachments kit	[ mm ]	40	40	40
lunghezza cavo elettrico - electric cable length	[ m ]	10	10	10
dimensioni pallet - pallet dimensions	[ cm ]	70x90x110	70x90x110	70x90x110

TR = Turbina - Turbine

SS 430 = Inox AISI 430 - Stainless steel AISI 430



# QT & Q-BAT

ASPIRATORI INDUSTRIALI COMPATTI  
COMPACT INDUSTRIAL VACUUM CLEANERS



## QT & Q-BAT - ASPIRATORI INDUSTRIALI COMPATTI

- Per l'aspirazione di polveri e liquidi
  - Facilità di trasporto: grazie alla facile rimozione dei fusti, le macchine possono essere caricate e trasportate anche in autovetture
  - Tutte le unità sono dotate di un efficiente meccanismo di pulizia del filtro meccanico, ed un comodo tubo flessibile di svuotamento
  - Modelli con turbina (QT) che sono particolarmente indicati per grandi periodi di utilizzo ininterrotto
  - Modelli a batteria (Q-BAT): indispensabili in tutti gli ambienti in cui non può essere utilizzata l'elettricità. Ideale per la pulizia in assoluta autonomia senza cavo di alimentazione per almeno 2 ore consecutive in una singola carica
  - Dotate di un vuotometro (QT) per indicare il livello di saturazione del filtro e quindi il momento giusto per pulire o sostituire il filtro
  - Modello Q-BAT dotato di caricabatterie installato a bordo.
- *Wet and dry use*
  - *Easy transport: Due to removable tanks, the units can be loaded and transported in most vehicles*
  - *All units are equipped with an efficient mechanical filter cleaning mechanism, and a convenient emptying hose*
  - *Units with turbines (QT) are particularly indicated for large periods of uninterrupted use*
  - *Units which are battery-driven (Q-BAT): Essential in all environments where electricity cannot be used. Ideal for cleaning in absolute autonomy without a power cord for at least 2 consecutive hours on one single charge*
  - *Equipped with a vacuum gauge (QT) to indicate the level of filter saturation and consequently the right time to clean or change the filter*
  - *Battery charger included on board (mod. Q-BAT)*

QT 30 - QT 40



Q - BAT



## ACCESSORI IN DOTAZIONE / SUPPLIED ACCESSORIES

	COD.	DESCRIZIONE - DESCRIPTION
	004.134	Filtro in Poliestere con anello portafiltro <i>Polyester filter with support ring</i>
 l= 3m	004.329	Tubo flessibile completo diam. 40 mm <i>Flexible hose diam. 40 mm complete</i>
	004.421	Lancia piatta diam. 40 mm <i>Crevice tool diam. 40 mm</i>
	121AC267-ACQ	Caricabatterie elettronico <i>Electronic battery charger</i>

## ACCESSORI A RICHIESTA / ACCESSORIES ON DEMAND

	COD.	DESCRIZIONE - DESCRIPTION
	121AC131	Batterie gel 12V-140Ah (345x170x285 mm - 37 Kg) (Q-BAT) <i>Gel batteries 12V-140Ah (345x170x285 mm - 37 Kg) (Q-BAT)</i>

ACCESSORI A RICHIESTA E FILTRI VEDI PAG. 210  
 ACCESSORIES ON DEMAND AND FILTER SEE PAG. 210



### APPLICAZIONI SPECIALI (APPS)

PER ASPIRATORI INDUSTRIALI DISPONIBILI (VEDERE PAG.212)

### SPECIAL APPLICATION SYSTEMS (APPS)

FOR INDUSTRIAL VACUUM CLEANERS AVAILABLE (SEE PAG.212)



ATTENZIONE: le speciali applicazioni sono realizzate esclusivamente durante la costruzione delle macchine.  
 PLEASE NOTE: apps are exclusively implemented during the construction of the vacuum cleaner.

# QT & Q-BAT - ASPIRATORI INDUSTRIALI COMPATTI

## COMPACT INDUSTRIAL VACUUM CLEANERS

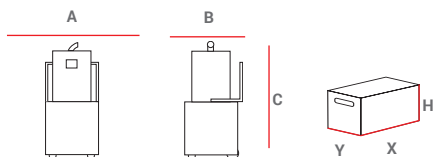

PESI E DIMENSIONI MACCHINA WEIGHTS AND DIMENSIONS MACHINE					IMBALLO PACKAGING			
MOD	A	B	C	Netto/Net	X	Y	H	Lordo/Gross
	[mm]	[mm]	[mm]	[kg]	[mm]	[mm]	[mm]	[kg]
Q-BAT	560	655	1.255	123	700	600	1.470	133
QT 30	560	655	1.255	80	700	600	1.470	90
QT 40	560	655	1.255	80	700	600	1.470	90
QT 55	560	655	1.255	80	700	600	1.470	90

		Q-BAT	QT 30	QT 40	QT 55
codice - code		● 008.044	● 008.050	● 008.042	● 08QT020
potenza max - max. power	[W - HP]	1.000 W	2.200 W - 3 HP	3.000 W - 4 HP	4.000 W - 5,5 HP
alimentazione - power supply	[V - ph - Hz]	2x24 Vdc	230-1-50	400-3-50	400-3-50
motori / turbine - motors / turbines	[NR]	2 motori BP 2 motors BP	1 turbina 1 turbine	1 turbina 1 turbine	1 turbina 1 turbine
depressione - water lift	[mm H <sub>2</sub> O]	2.000	3.200	3.200	3.300
portata aria - air flow	[m <sup>3</sup> h]	360	350	350	380
volume fusto in litri - tank volume in liters	[l]	80	80	80	80
materiale fusto - tank material		SS 430	SS 430	SS 430	SS 430
livello rumore - noise level	[dBA]	75	70	70	73
superficie filtrante - filter surface area	[cm <sup>2</sup> ]	5.000	4.000	4.000	4.000
lunghezza cavo elettrico - electric cable lenght	[m]	10	10	10	10
autonomia - working time*	[h]	6	-	-	-
diametro accessori - diameter of accessories	[mm]	40	40	40	40
dimensioni pallet - pallet dimensions	[cm]	70x91x162	70x91x162	70x91x162	70x91x162

\* Valore relativo a batterie 121AC131 cariche - 121AC131 charged batteries value

BP = Bistadio con raffreddamento bypass - 2 stage with bypass cooling

SS 430 = Acciaio Inox AISI 430 - Stainless steel AISI 430



# MTP & MTX

---

ASPIRAPOLVERE INDUSTRIALE BASCULANTE DI GRANDE CAPIENZA  
SWIVEL TANK HIGH CAPACITY INDUSTRIAL VACUUM CLEANER

## MTP & MTX - ASPIRAPOLVERE INDUSTRIALE BASCULANTE DI GRANDE CAPIENZA SWIVEL TANK HIGH CAPACITY INDUSTRIAL VACUUM CLEANER

- Aspiratori industriali monofase con 3 potenti motori a 2 stadi bypass
  - Testata robusta costruita interamente in acciaio
  - Fusto in plastica di alta capacità, antiurto, stampato con il metodo rotazionale, resistente agli agenti chimici aggressivi e nelle condizioni più gravose
  - Meccanismo basculante ed chassis in acciaio, progettati sapientemente per la massima facilità dell'operazione di svuotamento del contenitore
  - Ideali per l'eliminazione della polvere e dei detriti provenienti dalle superfici di lavoro delle fabbriche e officine
  - La vasta gamma di accessori permettono la rimozione di ogni tipo di polvere o liquidi da qualsiasi superficie
- Single-phase industrial units with 3 powerful 2-stage bypass motors
  - Robust motor-head constructed entirely of steel.
  - High capacity shock-proof roto-molded plastic tank resists exposure to harsh chemicals and under the most demanding conditions
  - Intelligent design of the steel frame and tipping mechanism allow user to tip and empty the tank with maximum ease and comfort
  - Ideal for eliminating dust and waste particles from the work surfaces of factories and work shops
  - The vast assortment of accessories adapt the machines for use in the removal of any type of dust or liquid from any surface



### ACCESSORI IN DOTAZIONE / ACCESSORI A RICHIESTA / SUPPLIED ACCESSORIES / ACCESSORIES ON DEMAND

FILTRO IN POLIESTERE CON ANELLO PORTAFILTRO POLYESTER FILTER WITH SUPPORT RING	KIT STANDARD (tubo EVA) STANDARD KIT (EVA hose) diam.40/50 mm	KIT ANTISTATICO/ANTIOLIO (tubo EVA) ANTISTATIC/OIL PROOF KIT (EVA hose) diam.40/50 mm	KIT CALOR (tubo PUR CALORANTIABRASIVO) CALOR KIT (PUR CALOR/ANTIABRASIVE hose) diam.40/50 mm
			
<b>Cod. 004.215</b>	<b>Mod. Ø 40 mm Cod. 004.299.007</b> <b>Mod. Ø 50 mm Cod. 004.299.006</b>	<b>Mod. Ø 40 mm Cod. 004.299.008</b> <b>Mod. Ø 50 mm Cod. 004.299.004</b>	<b>Mod. Ø 40 mm Cod. 004.299.009</b> <b>Mod. Ø 50 mm Cod. 004.299.005</b>

### ACCESSORI A RICHIESTA E FILTRI VEDI PAG. 210 ACCESSORIES ON DEMAND AND FILTER SEE PAG. 210

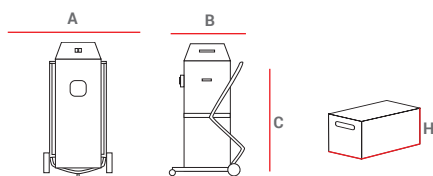

PESI E DIMENSIONI MACCHINA WEIGHTS AND DIMENSIONS MACHINE					IMBALLO PACKAGING			
MOD	A	B	C	Netto/Net	X	Y	H	Lordo/Gross
	[mm]	[mm]	[mm]	[kg]	[mm]	[mm]	[mm]	[kg]
MTP 40 - MTX 40	700	680	1.145	43	750	700	1.150	49

	MTP 40	MTX 40
codice - code	● 008.056	● 008.074
potenza max - max. power	[ W - HP ]	3.500 - 4 HP
alimentazione - power supply	[ V - ph - Hz ]	230-1-50/60
tipo motore - motor type	BP	BP
motori - motors	[ NR ]	3
depressione - water lift	[ mm H <sub>2</sub> O ]	2.500
portata aria - air flow	[ m <sup>3</sup> /h ]	650
volume fusto in litri - tank volume in liters	[ l ]	115
materiale fusto - tank material	PP	SS 304
livello rumore - noise level	[ dBA ]	79
lunghezza cavo elettrico - electric cable length	[ m ]	10
diametro accessori - diameter of accessories	[ mm ]	40/50

BP = bistadio bypass - 2-stage bypass  
PP = polipropilene - polypropylene  
SS 304 = Acciaio INOX AISI 304 - Stainless steel AISI 304





# MT & MTV

ASPIRAPOLVERI INDUSTRIALI DI ROBUSTA COSTRUZIONE  
HEAVY DUTY INDUSTRIAL VACUUM CLEANERS



## MT & MTV-ASPIRAPOLVERI INDUSTRIALI DI ROBUSTA COSTRUZIONE

- Aspiratori industriali monofase con 3 potenti motori a 2 stadi bypass
  - Manutenzione esternamente semplice: facile rimozione di entrambi i contenitori per facilitare le operazioni di svuotamento e pulizia del filtro
  - Ideali per l'eliminazione dei detriti e polvere provenienti dalle superfici di lavoro delle fabbriche e officine
  - Innovativo sistema incorporato di autopulizia del filtro che aiuta a mantenere il filtro più pulito durante normali lavori di pulizia con un livello moderato di polvere
  - Scuotifiltro manuale per la pulizia del filtro in dotazione con tutte le macchine.
  - La vasta gamma di accessori e filtri permettono la rimozione di ogni tipo di polvere e liquidi
  - Ideale per l'utilizzo con le unità di lavoro fisse o mobili, collegato a seghe elettriche, sabbiatrici, levigatrici etc.
  - Eccellente per cantieri edili, per la pulizia delle auto, officine meccaniche, fabbriche di lavorazione del legno, e in tutte le fabbriche e officine industriali
- *Single-phase industrial units with 3 powerful 2-stage bypass motors*
  - *Extremely easy to maintain: easy removal of both containers to facilitate emptying and filter changing operations*
  - *Ideal for eliminating dust and waste particles from the work surfaces of factories and work shops*
  - *Innovative incorporated self-cleaning filter system helps keep the filter cleaner, during regular cleaning work with moderate dust level*
  - *Additional mechanical filter cleaning mechanism included with all machines.*
  - *The vast assortment of accessories and filters adapt the machines for use in the removal of any type of dust and/or liquid*
  - *Ideal for use with stationary or mobile work units, attached to power saws, drilling equipment, sanding equipment, and many more*
  - *Excellent for construction sites, car detailing and cleaning, mechanics' workshops, wood working factories, and basically all factories and industrial workshops and warehouses*

MT



MTV



## ACCESSORI IN DOTAZIONE / SUPPLIED ACCESSORIES

	COD.	DESCRIZIONE - DESCRIPTION
	004.134	Filtro in Poliestere con anello portafiltro Polyester filter with support ring

## ACCESSORI A RICHIESTA / ACCESSORIES ON DEMAND

	COD.KIT	DESCRIZIONE - DESCRIPTION
	004.299.007	Kit standard Ø 40 mm (tubo EVA) Standard kit Ø 40 mm (EVA hose) (004.399.020(1) + 004.024(2) + 004.421(3))
	004.299.006	Kit standard Ø 50 mm (tubo EVA) Standard kit Ø 50 mm (EVA hose) (004.295(1) + 004.024(2) + 004.299.002(3))
	004.299.008	Kit antistatico/Antioliolo Ø 40 mm (tubo EVA) Antistatic/Oil proof kit Ø 40 mm (EVA hose) (004.399.022(1) + 004.024(2) + 004.095(3))
	004.299.004	Kit antistatico/Antioliolo Ø 50 mm (tubo EVA) Antistatic/Oil proof kit Ø 50 mm (EVA hose) (004.297(1) + 004.024(2) + 004.095(3))
	004.299.009	Kit calor Ø 40 mm (tubo PUR CALOR/ANTIABRASIVO) Calor kit Ø 40 mm (PUR CALOR/ANTIABRASIVE hose) (004.299.012(1) + 004.024(2) + 004.095(3))
	004.299.005	Kit calor Ø 50 mm (tubo PUR CALOR/ANTIABRASIVO) Calor kit Ø 50 mm (PUR CALOR/ANTIABRASIVE hose) (004.299(1) + 004.024(2) + 004.095(3))

ACCESSORI A RICHIESTA E FILTRI VEDI PAG. 210  
ACCESSORIES ON DEMAND AND FILTER SEE PAG. 210



## APPLICAZIONI SPECIALI (APPS)

PER ASPIRATORI INDUSTRIALI DISPONIBILI (VEDERE PAG.212)

## SPECIAL APPLICATION SYSTEMS (APPS)

FOR INDUSTRIAL VACUUM CLEANERS AVAILABLE (SEE PAG.212)



ATTENZIONE: le speciali applicazioni sono realizzate esclusivamente durante la costruzione delle macchine.  
PLEASE NOTE: apps are exclusively implemented during the construction of the vacuum cleaner.

# MT & MTV - ASPIRAPOLVERE INDUSTRIALE DI ROBUSTA COSTRUZIONE HEAVY DUTY INDUSTRIAL VACUUM CLEANER

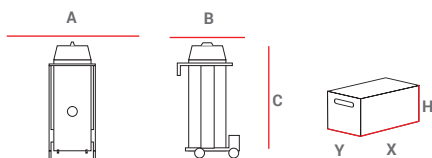

PESI E DIMENSIONI MACCHINA WEIGHTS AND DIMENSIONS MACHINE					IMBALLO PACKAGING			
MOD	A	B	C	Netto/Net	X	Y	H	Lordo/Gross
	[mm]	[mm]	[mm]	[kg]	[mm]	[mm]	[mm]	[kg]
MT/MTV 40	640	860	1.305	56	950	700	1.520	70

		MT 40	MTV 40
codice - code		● 008.012	● 008.017
potenza max - max. power	[ W - HP ]	3.500 - 4 HP	3.500 - 4 HP
alimentazione - power supply	[ V - ph - Hz ]	230-1-50/60	230-1-50/60
tipo motore - motor type		BP	BP
motori - motors	[ NR ]	3	3
depressione - water lift	[ mm H <sub>2</sub> O ]	2.500	2.500
portata aria - air flow	[ m <sup>3</sup> /h ]	650	650
volume fusto in litri - tank volume in liters	[ l ]	80	80
materiale fusto - tank material		SS 304	AV
livello rumore - noise level	[ dBA ]	79	79
superficie filtrante - filter surface area	[ cm <sup>2</sup> ]	4.000	4.000
lunghezza cavo elettrico - electric cable lenght	[ m ]	10	10
diametro accessori - diameter of accessories	[ mm ]	40/50	40/50
dimensioni pallet - pallet dimensions	[ cm ]	70x91x162	70x91x162

BP = bistadio bypass - 2-stage bypass

SS 304 = Acciaio INOX AISI 304 - Stainless steel AISI 304

AV = Acciaio verniciato a polvere - Powder coat painted steel



# TT & TTV - TTX & TTXV

---

ASPIRAPOLVERI INDUSTRIALI DI ROBUSTA COSTRUZIONE  
HEAVY DUTY INDUSTRIAL VACUUM CLEANERS



- Modelli monofase e trifase
- Utilizzo continuativo senza interruzione
- Camera di filtrazione extra-large per una maggiore efficienza di filtrazione (TTX - TTXV)
- Serbatoio di recupero di grandi dimensioni: può contenere 100 litri di rifiuti (TTX - TTXV)
- Scuotifiltro manuale per la pulizia del filtro in dotazione con tutte le macchine.
- Manutenzione estremamente semplice: facile rimozione di entrambi i contenitori per facilitare le operazioni di svuotamento e pulizia del filtro senza bisogno di alzare e rimuovere la pesante turbina
- Unità multiple possono essere installati in serie o in parallelo per fornire una rete di sistemi di aspirazione che eliminano le particelle di polvere provenienti dalle superfici di lavoro delle fabbriche e officine
- La vasta gamma di accessori e filtri permettono la rimozione di ogni tipo di polvere e liquidi e oli
- Ideale per l'utilizzo con le unità di lavoro fisse o mobili, collegato a seghe elettriche, sabbiatrici, levigatrici etc.
- Eccellente per cantieri edili, per la pulizia delle auto, officine meccaniche, fabbriche di lavorazione del legno, e in tutte le fabbriche e officine industriali
- Tutte le unità sono dotate di un vuotometro per indicare il livello di saturazione del filtro e quindi il momento giusto per pulire o sostituire quest'ultimo

- *Single-phase and three-phase models*
- *Continuous use without interruption*
- *Extra-large filtration chamber for even higher filtration efficiency (TTX - TTXV)*
- *Extra-large recovery tank can hold 100 litres of waste material (TTX - TTXV)*
- *Additional mechanical filter cleaning mechanism included with all machines.*
- *Extremely easy to maintain: easy removal of both containers to facilitate emptying and filter changing operations without the need to lift and remove the heavy turbine*
- *Several units can be installed in series or parallel to provide a network vacuum system to eliminate dust and waste particles from the work surfaces of factories and work shops*
- *The vast assortment of accessories and filters adapt the machines for use in the removal of any type of dust and/or liquid, even oil separation*
- *Ideal for use with stationary or mobile work units, attached to power saws, drilling equipment, sanding equipment, and many more*
- *Excellent for construction sites, car detailing and cleaning, mechanics' workshops, wood working factories, and basically all factories and industrial workshops and warehouses*
- *All units are equipped with a vacuum gauge to indicate the level of filter saturation and consequently the right time to clean or change the latter one mentioned*



## ACCESSORI IN DOTAZIONE / SUPPLIED ACCESSORIES

	MOD.	COD.	DESCRIZIONE - DESCRIPTION
	TT - TTV	004.134	Filtro in Poliestere con anello portafiltro Polyester filter with support ring
	TTX - TTXV	004.204	Filtro stellare con grande superficie filtrante, con anello portafiltro Star-shaped filter with large filtration surface area with support ring

## ACCESSORI A RICHIESTA / ACCESSORIES ON DEMAND

	COD.KIT	DESCRIZIONE - DESCRIPTION
	004.299.007	Kit standard Ø 40 mm (tubo EVA) Standard kit Ø 40 mm (EVA hose) (004.399.020(1) + 004.024(2) + 004.421(3))
	004.299.006	Kit standard Ø 50 mm (tubo EVA) Standard kit Ø 50 mm (EVA hose) (004.295(1) + 004.024(2) + 004.299.002(3))
	004.299.008	Kit antistatico/Antiolio Ø 40 mm (tubo EVA) Antistatic/Oil proof kit Ø 40 mm (EVA hose) (004.399.022(1) + 004.024(2) + 004.095(3))
	004.299.004	Kit antistatico/Antiolio Ø 50 mm (tubo EVA) Antistatic/Oil proof kit Ø 50 mm (EVA hose) (004.297(1) + 004.024(2) + 004.095(3))
	004.299.009	Kit calor Ø 40 mm (tubo PUR CALOR/ANTIABRASIVO) Calor kit Ø 40 mm (PUR CALOR/ANTIABRASIVE hose) (004.299.012(1) + 004.024(2) + 004.095(3))
	004.299.005	Kit calor Ø 50 mm (tubo PUR CALOR/ANTIABRASIVO) Calor kit Ø 50 mm (PUR CALOR/ANTIABRASIVE hose) (004.299(1) + 004.024(2) + 004.095(3))

ACCESSORI A RICHIESTA E FILTRI VEDI PAG. 210  
ACCESSORIES ON DEMAND AND FILTER SEE PAG. 210



## APPLICAZIONI SPECIALI (APPS)

PER ASPIRATORI INDUSTRIALI DISPONIBILI (VEDERE PAG.212)

## SPECIAL APPLICATION SYSTEMS (APPS)

FOR INDUSTRIAL VACUUM CLEANERS AVAILABLE (SEE PAG.212)



ATTENZIONE: le speciali applicazioni sono realizzate esclusivamente durante la costruzione delle macchine.  
PLEASE NOTE: apps are exclusively implemented during the construction of the vacuum cleaner.



# TT & TTV - TTX & TTXV - ASPIRAPOLVERI INDUSTRIALI DI ROBUSTA COSTRUZIONE HEAVY DUTY INDUSTRIAL VACUUM CLEANERS

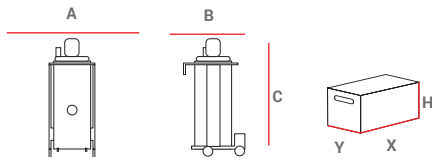

PESI E DIMENSIONI MACCHINA WEIGHTS AND DIMENSIONS MACHINE					IMBALLO PACKAGING			
MOD	A	B	C	Netto/Net	X	Y	H	Lordo/Gross
	[mm]	[mm]	[mm]	[kg]	[mm]	[mm]	[mm]	[kg]
TT/TTV 30 - 40 - 55	650	820	1.500	85	900	700	1.720	100
TTX/TTXV 30 - 40 - 55	660	830	1.710	105	940	700	1.920	121

		TT 30	TT 40	TT 55	TTV 30	TTV 40	TTV 55
codice - code		● 008.011	● 008.010	● 008.045	● 008.018	● 008.019	● 008.046
potenza max - max. power	[ W -HP ]	2.200 W - 3HP	3.000 W - 4HP	4.000 W - 5,5HP	2.200 W - 3 HP	3.000 W - 4 HP	4.000 W - 5,5 HP
alimentazione - power supply	[ V - ph - Hz ]	230-1-50	400-3-50	400-3-50	230-1-50	400-3-50	400-3-50
tipo motore - motor type		TR	TR	TR	TR	TR	TR
depressione - water lift	[ mm H <sub>2</sub> O ]	3.200	3.200	3.300	3.200	3.200	3.300
portata aria - air flow	[ m <sup>3</sup> /h ]	350	350	380	350	350	380
volume fusto in litri tank volume in liters	[ l ]	80	80	80	80	80	80
materiale fusto - tank material		SS 304	SS 304	SS 304	AV	AV	AV
livello rumore - noise level	[ dBA ]	73	73	73	73	73	73
superficie filtrante filter surface area	[ cm <sup>2</sup> ]	4.400	4.400	4.400	4.400	4.400	4.400
lunghezza cavo elettrico electric cable lenght	[ m ]	10	10	10	10	10	10
diametro accessori diameter of accessories	[ mm ]	40/50	40/50	40/50	40/50	40/50	40/50
dimensioni pallet pallet dimensions	[ cm ]	70x91x162	70x91x162	70x91x162	70x91x162	70x91x162	70x91x162

TR = Turbina - Turbine

SS 304 = Acciaio Inox AISI 304 - Stainless steel AISI 304

		TTX 30	TTX 40	TTX 55	TTXV 30	TTXV 40	TTXV 55
codice - code		● 008.009	● 008.008	● 008.013	● 008.020	● 008.021	● 008.022
potenza max - max. power	[ W -HP ]	2.200 W - 3 HP	3.000 W - 4 HP	4.000 W - 5,5 HP	2.200 W - 3 HP	3.000 W - 4 HP	4.000 W - 5,5 HP
alimentazione - power supply	[ V - ph - Hz ]	230-1-50	400-3-50	400-3-50	230-1-50	400-3-50	400-3-50
tipo motore - motor type		TR	TR	TR	TR	TR	TR
depressione - water lift	[ mm H <sub>2</sub> O ]	3.200	3.200	3.300	3.200	3.200	3.300
portata aria - air flow	[ m <sup>3</sup> /h ]	350	350	380	350	350	380
volume fusto in litri tank volume in liters	[ l ]	100	100	100	100	100	100
materiale fusto - tank material		SS 304	SS 304	SS 304	AV	AV	AV
livello rumore - noise level	[ dBA ]	73	73	73	73	73	73
superficie filtrante filter surface area	[ cm <sup>2</sup> ]	21.000	21.000	21.000	21.000	21.000	21.000
lunghezza cavo elettrico electric cable lenght	[ m ]	10	10	10	10	10	10
diametro accessori diameter of accessories	[ mm ]	40/50	40/50	40/50	40/50	40/50	40/50
dimensioni pallet pallet dimensions	[ cm ]	70x91x192	70x91x192	70x91x192	70x91x192	70x91x192	70x91x192

TR = Turbina - Turbine

AV = Acciaio verniciato a polvere - Powder coat painted steel

SS 304 = Acciaio Inox AISI 304 - Stainless steel AISI 304



# TT<sub>EX</sub> - TTX<sub>EX</sub>

ASPIRAPOLVERI INDUSTRIALI DI ROBUSTA COSTRUZIONE PER ZONE ATEX  
HEAVY DUTY INDUSTRIAL VACUUM CLEANERS FOR ATEX ZONE

- Modelli monofase e trifase per utilizzo continuativo senza interruzione
- Camera di filtrazione extra-large per una maggiore efficienza di filtrazione (TTXEx)
- Serbatoio di recupero di grandi dimensioni: può contenere 100 litri di rifiuti (TTXEx)
- Manutenzione estremamente semplice: facile rimozione di entrambi i contenitori per facilitare le operazioni di svuotamento e pulizia del filtro senza bisogno di alzare e rimuovere la pesante turbina
- Tutte le unità sono dotate di un vuotometro per indicare il livello di saturazione del filtro e quindi il momento giusto per pulire o sostituire quest'ultimo
- Capsula termica integrata nel motore per protezione da eccessivo riscaldamento
- Tutte le unità sono dotate di sistema per impedire le ripartenze accidentali dovute a cali di tensione
- ⚡ Turbina a canale laterale certificata ATEX Z22
- ⚡ Impianto di messa a terra speciale che garantisce una resistenza verso terra < 10 Ohm delle varie parti del telaio
- ⚡ Deflettore polveri interno fusto con lamina di ottone antiscintilla per evitare che il materiale che lo urta crei scintille
- ⚡ Pinza di messa a terra con 3 metri di cavo per assicurare alla terra dell'edificio l'aspiratore
- ⚡ Scuotifiltro versione nuova con parti in gomma realizzate con miscela dissipativa
- ⚡ Diffusore in uscita aria antistatico, che serve a evitare correnti concentrate di aria
- ⚡ Valvola rompivuoto di serie per evitare il surriscaldamento della turbina oltre la temperatura dichiarata nella stringa ATEX (125°C)
- Single-phase and three-phase models for continuous use without interruption
- Extra-large filtration chamber for even higher filtration efficiency (TTXEx)
- Extra-large recovery tank can hold 100 litres of waste material (TTXEx)
- Extremely easy to maintain: easy removal of both containers to facilitate emptying and filter changing operations without the need to lift and remove the heavy turbine
- All units are equipped with a vacuum gauge to indicate the level of filter saturation and consequently the right time to clean or change the latter mentioned
- Motor embedded thermal switch to prevent overheating
- All units have a safety device to prevent unexpected restart (ex. after power failure)
- ⚡ ATEX Z22 certified side channel turbine
- ⚡ Special grounding system ensures resistance to ground < 10 Ohm of the various parts of the frame
- ⚡ Inner drum dust deflector with non-sparking brass foil to prevent impacting material from creating sparks
- ⚡ Grounding clamp with 3 meters of cable to secure the vacuum cleaner to the building ground
- ⚡ New version filter shaker with rubber parts made with dissipative compound
- ⚡ Anti-static air outlet diffuser, which serves to prevent concentrated air currents
- ⚡ Standard vacuum relief valve to prevent the turbine from overheating beyond the temperature stated in the ATEX string (125°C)



Pinza di messa a terra / Grounding clamp



Valvola rompivuoto / Vacuum relief valve



Deflettore polveri interno fusto con lamina di ottone antiscintilla / Inner drum dust deflector with non-sparking brass foil



## ACCESSORI IN DOTAZIONE / SUPPLIED ACCESSORIES

	MOD.	COD.	DESCRIZIONE - DESCRIPTION
	TTEx	B.CRFL00000	Filtro a canestro antistatico in classe M con anello portafiltro Canister filter in M class with support ring
	TTXEx	B.CRFL00001	Filtro stellare in classe M con grande superficie filtrante, con anello portafiltro Star-shaped filter in M class with large filtration surface area with support ring

## ACCESSORI A RICHIESTA / ACCESSORIES ON DEMAND

	COD.KIT	DESCRIZIONE - DESCRIPTION
	004.299.008	Kit antistatico/Antiolio Ø 40 mm (tubo EVA) Antistatic/Oil proof kit Ø 40 mm (EVA hose) (004.399.022(1) + 004.024(2) + 004.095(3))
	004.299.004	Kit antistatico/Antiolio Ø 50 mm (tubo EVA) Antistatic/Oil proof kit Ø 50 mm (EVA hose) (004.297(1) + 004.024(2) + 004.095(3))



## ACCESSORI A RICHIESTA E FILTRI ACCESSORIES ON DEMAND AND FILTER



# TTEx & TTXex - ASPIRAPOLVERI INDUSTRIALI DI ROBUSTA COSTRUZIONE PER ZONE ATEX HEAVY DUTY INDUSTRIAL VACUUM CLEANERS FOR ATEX ZONE

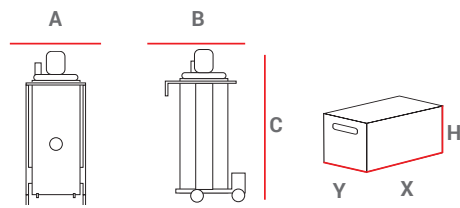

PESI E DIMENSIONI MACCHINA WEIGHTS AND DIMENSIONS MACHINE					IMBALLO PACKAGING			
MOD	A	B	C	Netto/Net	X	Y	H	Lordo/Gross
	[mm]	[mm]	[mm]	[kg]	[mm]	[mm]	[mm]	[kg]
TT 30 - 40 - 55 EX	650	820	1.500	85	900	700	1.720	100
TTX 30 - 40 - 55 EX	675	850	1.710	85	940	700	1.920	100

		TT 30 EX	TT 40 EX	TT 55 EX
codice - code		● 008.011EX	● 008.010EX	● 008.045EX
potenza max - max. power	[ W -HP ]	2.200 W - 3 HP	3.000 W - 4 HP	4.000 W - 5,5 HP
alimentazione - power supply	[ V - ph - Hz ]	230-1-50	400-3-50	400-3-50
tipo motore - motor type		TR EX	TR EX	TR EX
depressione - water lift	[ mm H <sub>2</sub> O ]	1.900	2.000	2.200
portata aria - air flow	[ m <sup>3</sup> /h ]	360	360	360
volume fusto in litri - tank volume in liters	[ l ]	80	80	80
materiale fusto - tank material		SS 304	SS 304	SS 304
livello rumore - noise level	[ dBA ]	73	73	73
superficie filtrante - filter surface area	[ cm <sup>2</sup> ]	4.400	4.400	4.400
lunghezza cavo elettrico - electric cable lenght	[ m ]	10	10	10
diametro accessori - diameter of accessories	[ mm ]	40/50	40/50	40/50
categoria ATEX - ATEX marking	-	Ex II 3D Ex htc IIIB T125°C Dc		
dimensioni pallet - pallet dimensions	[ cm ]	70x91x162	70x91x162	70x91x162

TR = Turbina omologata ATEX - Turbine ATEX approved

SS 304 = Acciaio Inox AISI 304 - Stainless steel AISI 304

		TTX 30 EX	TTX 40 EX	TTX 55 EX
codice - code		● 008.009EX	● 008.008EX	● 008.013EX
potenza max - max. power	[ W -HP ]	2.200 W - 3 HP	3.000 W - 4 HP	4.000 W - 5,5 HP
alimentazione - power supply	[ V - ph - Hz ]	230-1-50	400-3-50	400-3-50
tipo motore - motor type		TR EX	TR EX	TR EX
depressione - water lift	[ mm H <sub>2</sub> O ]	1.500	2.000	2.200
portata aria - air flow	[ m <sup>3</sup> /h ]	360	360	360
volume fusto in litri tank volume in liters	[ l ]	100	100	100
materiale fusto - tank material		SS 304	SS 304	SS 304
livello rumore - noise level	[ dBA ]	73	73	73
superficie filtrante filter surface area	[ cm <sup>2</sup> ]	21.000	21.000	21.000
lunghezza cavo elettrico electric cable lenght	[ m ]	10	10	10
diametro accessori diameter of accessories	[ mm ]	40/50	40/50	40/50
categoria ATEX - ATEX marking	-	Ex II 3D Ex htc IIIB T125°C Dc		
dimensioni pallet pallet dimensions	[ cm ]	70x91x192	70x91x192	70x91x192

TR = Turbina omologata ATEX - Turbine ATEX approved

SS 304 = Acciaio Inox AISI 304 - Stainless steel AISI 304





# TCX & TCXV

ASPIRATORI INDUSTRIALI AD ALTE PRESTAZIONI E ROBUSTEZZA  
*HIGH PERFORMANCE HEAVY DUTY INDUSTRIAL VACUUM CLEANERS*



## TCX & TCXV - ASPIRATORI INDUSTRIALI AD ALTE PRESTAZIONI E ROBUSTEZZA

- Robusti e durevoli
  - Resiste alle più dure condizioni di lavoro
  - Estremamente versatili: possono essere utilizzati con tutti i tipi di filtro da L a H (inclusi filtri HEPA)
  - Vasta gamma di potenza da 3hp a 7,5hp
  - I modelli con turbine a due stadi collegati in parallelo forniscono flusso d'aria superiore per la rimozione rapida di grandi quantità di polvere, mentre i modelli con turbine a due stadi collegati in serie garantiscono maggiore aspirazione su lunghe distanze per la raccolta dei rifiuti, liquidi, oli e particelle pesanti
  - Unità multiple possono essere installate in serie o in parallelo per fornire una rete di sistemi di aspirazione che eliminano le particelle di polvere provenienti dalle superfici di lavoro delle fabbriche e officine
  - Tutte le unità sono dotate di un filtro a forma di stella che fornisce una grande superficie filtrante e un meccanismo scuotifiltro efficiente. In alternativa a richiesta sono disponibili sistemi scuotifiltro completamente automatici per la pulizia del filtro con timer programmabili
  - La vasta gamma di accessori e filtri permettono la rimozione di ogni tipo di polvere e liquidi e oli
  - Eccellente per cantieri edili, per la pulizia delle auto, officine meccaniche, fabbriche di lavorazione del legno, e in tutte le fabbriche e officine industriali
- *Extremely robust and durable construction*
  - *Withstands the harshest working environments*
  - *Versatility of function: can be used with ALL types of filters from L to H ( including HEPA filters)*
  - *Large range of powers from 3 hp to 20 hp*
  - *Models with two-stage turbines connected in parallel, provide superior air flow for fast removal of huge quantities of dust, whereas models with two-stage turbines connected serially, provide extra vacuum power for the collection of waste material, liquids, oils, and heavier particles over longer distances*
  - *Several units can be installed in series or parallel to provide a network vacuum systems to eliminate dust and waste particles from the work surfaces of factories and work shops*
  - *All units are equipped with a star-shaped filter providing a large filtration surface area and an efficient filter shaking mechanism. Alternatively fully automatic filter cleaning systems with programmable timers are available on demand*
  - *The vast assortment of accessories and filters adapt the machines for use in the removal of any type of dust and/or liquid, even oil separation*
  - *Excellent for construction sites, car detailing and cleaning, mechanics' workshops, wood working factories, and basically all factories and industrial workshops and warehouses*



## ACCESSORI IN DOTAZIONE / SUPPLIED ACCESSORIES

	COD.	DESCRIZIONE - DESCRIPTION
	004.204	Filtro stellare con grande superficie filtrante, con anello portafiltro Star-shaped filter with large filtration surface area with support ring

## ACCESSORI A RICHIESTA / ACCESSORIES ON DEMAND

	COD.KIT	DESCRIZIONE - DESCRIPTION
	004.299.007	Kit standard Ø 40 mm (tubo EVA) Standard kit Ø 40 mm (EVA hose) (004.399.020(1) + 004.024(2) + 004.421(3))
	004.299.006	Kit standard Ø 50 mm (tubo EVA) Standard kit Ø 50 mm (EVA hose) (004.295(1) + 004.024(2) + 004.299.002(3))
	004.299.008	Kit antistatico/Antioliolo Ø 40 mm (tubo EVA) Antistatic/Oil proof kit Ø 40 mm (EVA hose) (004.399.022(1) + 004.024(2) + 004.095(3))
	004.299.004	Kit antistatico/Antioliolo Ø 50 mm (tubo EVA) Antistatic/Oil proof kit Ø 50 mm (EVA hose) (004.297(1) + 004.024(2) + 004.095(3))
	004.299.009	Kit calor Ø 40 mm (tubo PUR CALOR/ANTIABRASIVO) Calor kit Ø 40 mm (PUR CALOR/ANTIABRASIVE hose) (004.299.012(1) + 004.024(2) + 004.095(3))
	004.299.005	Kit calor Ø 50 mm (tubo PUR CALOR/ANTIABRASIVO) Calor kit Ø 50 mm (PUR CALOR/ANTIABRASIVE hose) (004.299(1) + 004.024(2) + 004.095(3))

ACCESSORI A RICHIESTA E FILTRI VEDI PAG. 210  
ACCESSORIES ON DEMAND AND FILTER SEE PAG. 210



### APPLICAZIONI SPECIALI (APPS)

PER ASPIRATORI INDUSTRIALI DISPONIBILI (VEDERE PAG.212)

### SPECIAL APPLICATION SYSTEMS (APPS)

FOR INDUSTRIAL VACUUM CLEANERS AVAILABLE (SEE PAG.212)



ATTENZIONE: le speciali applicazioni sono realizzate esclusivamente durante la costruzione delle macchine.  
PLEASE NOTE: apps are exclusively implemented during the construction of the vacuum cleaner.

# TCX & TCXV - ASPIRATORI INDUSTRIALI AD ALTE PRESTAZIONI E ROBUSTEZZA HIGH PERFORMANCE HEAVY DUTY INDUSTRIAL VACUUM

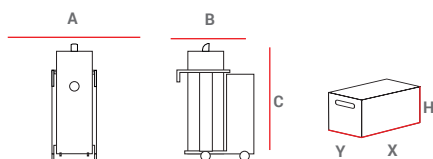

PESI E DIMENSIONI MACCHINA WEIGHTS AND DIMENSIONS MACHINE					IMBALLO PACKAGING			
MOD	A	B	C	Netto/Net	X	Y	H	Lordo/Gross
	[mm]	[mm]	[mm]	[kg]	[mm]	[mm]	[mm]	[kg]
TCX 55 P - TCXV 55 P	680	1.210	1.450	140	1.260	720	1.670	159
TCX 55 S - TCXV 55 S	680	1.210	1.450	140	1.260	720	1.670	159
TCX 75 P - TCXV 75 P	680	1.210	1.450	142,5	1.260	720	1.670	161,5
TCX 75 S - TCXV 75 S	680	1.210	1.450	166,5	1.260	720	1.670	165,5

		TCX 55 P	TCX 55 S	TCX 75 P	TCX 75 S
codice - code		● 008.004	● 008.003	● 008.002	● 008.001
potenza max - max. power	[W] [HP]	4.000 W 5,5 HP	4.000 W 5,5 HP	5.500 W 7,5 HP	5.500 W 7,5 HP
alimentazione - power supply	[V - ph - Hz]	400-3-50	400-3-50	400-3-50	400-3-50
tipo motore - motor type		TR-2st	TR-2st	TR-2st	TR-2st
depressione - water lift	[mm H <sub>2</sub> O]	3.500	5.000	3.600	5.100
portata aria - air flow	[m <sup>3</sup> /h]	580	380	620	400
volume fusto in litri - tank volume in liters	[l]	100	100	100	100
materiale fusto - tank material		SS 304	SS 304	SS 304	SS 304
livello rumore - noise level	[dBA]	73	73	73	73
superficie filtrante - filter surface area	[cm <sup>2</sup> ]	21.000	21.000	21.000	21.000
lunghezza cavo elettrico - electric cable lenght	[m]	10	10	10	10
diametro accessori - diameter of accessories	[mm]	40/50	40/50	40/50	40/50
dimensioni pallet - pallet dimensions	[cm]	80x120x160	80x120x160	80x120x160	80x120x160

TR-2st= Turbina 2-stadi - Double-stage turbine

SS 304= Acciaio Inox AISI 304 - Stainless steel AISI 304

		TCXV 55 P	TCXV 55 S	TCXV 75 P	TCXV 75 S
codice - code		● 008.027	● 008.028	● 008.029	● 008.030
potenza max - max. power	[W] [HP]	4.000 W 5,5 HP	4.000 W 5,5 HP	5.500 W 7,5 HP	5.500 W 7,5 HP
alimentazione - power supply	[V - ph - Hz]	400-3-50	400-3-50	400-3-50	400-3-50
tipo motore - motor type		TR-2st	TR-2st	TR-2st	TR-2st
depressione - water lift	[mm H <sub>2</sub> O]	3.500	5.000	3.600	5.100
portata aria - air flow	[m <sup>3</sup> /h]	580	380	620	400
volume fusto in litri - tank volume in liters	[l]	100	100	100	100
materiale fusto - tank material		AV	AV	AV	AV
livello rumore - noise level	[dBA]	73	73	73	73
superficie filtrante - filter surface area	[cm <sup>2</sup> ]	21.000	21.000	21.000	21.000
lunghezza cavo elettrico - electric cable lenght	[m]	10	10	10	10
diametro accessori - diameter of accessories	[mm]	40/50	40/50	40/50	40/50
dimensioni pallet - pallet dimensions	[cm]	80x120x160	80x120x160	80x120x160	80x120x160

TR-2st= Turbina 2-stadi - Double-stage turbine

AV= Acciaio verniciato a polvere - Powder coat painted steel

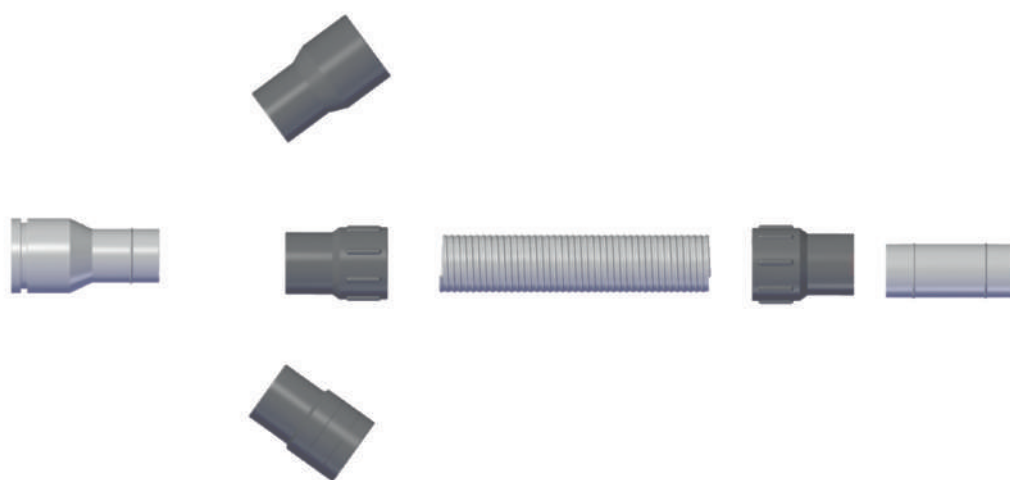
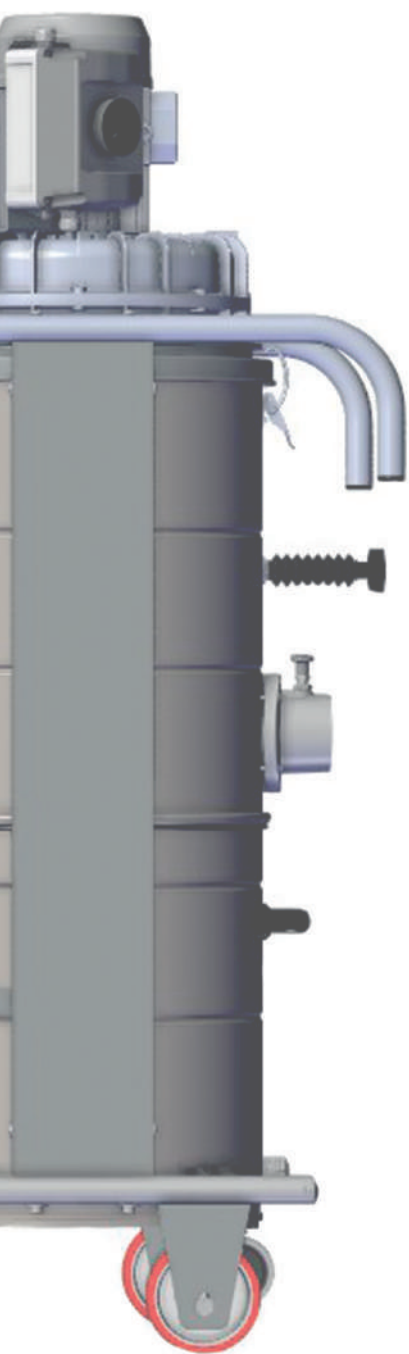

# CONNESSIONI *CONNECTIONS*

COME COLLEGARE GLI ACCESSORI AGLI ASPIRATORI BIEMMEDUE  
*HOW TO CONNECT THE ACCESSORIES TO THE BIEMMEDUE VACUUM CLEANERS*

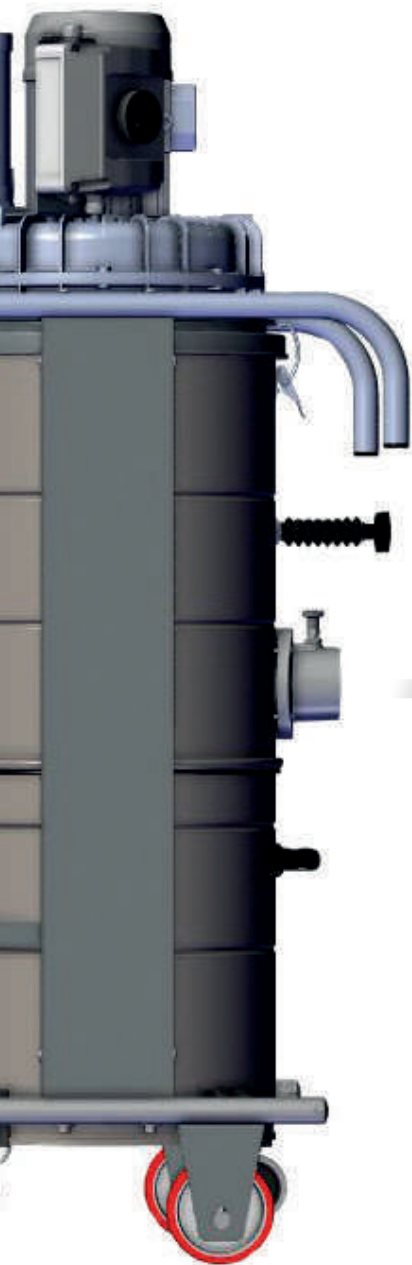

TUBO FLESSIBILE EVA INDUSTRIAL Ø 50  
EVA INDUSTRIAL FLEXIBLE HOSE Ø 50

Cod. 004.295 (5m)  
Cod. 004.296 (10m)



TUBO FLESSIBILE EVA INDUSTRIAL Ø 40  
EVA INDUSTRIAL FLEXIBLE HOSE Ø 40

Cod. 004.399.020 (5m)  
Cod. 004.399.021 (10m)



RIDUTTORE ACCIAIO ZINCATO  
Ø 70 per tubi Ø 40/50  
GALVANIZED STEEL REDUCTION CUFF  
Ø 70 for hose Ø 40/50  
Cod. 004.024



TUBO FLESSIBILE EVA ANTISTATICO/ANTIOLIO  
EVA ANTISTATIC/OIL-PROOF FLEXIBLE HOSE

Cod. 004.297 Ø 50 (5m)  
Cod. 004.298 Ø 50 (10m)  
Cod. 004.399.022 Ø 40 (5m)  
Cod. 004.399.023 Ø 40 (10m)



TUBO FLESSIBILE PUR CALOR/ANTISTATICO  
PUR CALOR/ANTIABRASIVE FLEXIBLE HOSE

Cod. 004.299 Ø 50 (5m)  
Cod. 004.299.001 Ø 50 (10m)  
Cod. 004.299.012 Ø 40 (5m)  
Cod. 004.299.013 Ø 40 (10m)

Tutti i tubi codificati in questo schema sono completi di manicotti/These codified hoses include cuffs

Tubo EVA INDUSTRIAL disponibile in matasse da 30 m - EVA INDUSTRIAL hose available in length of 30 meters (004.001-MAT Ø 40 - 004.002-MAT Ø 50)

Tubo EVA ANTISTATICO/ANTIOLIO disponibile in matasse da 30 m - EVA ANTISTATIC/OIL hose available in length of 30 meters (004.007-MAT Ø 40 - 004.008-MAT Ø 50)

Tubo PUR CALOR/ANTIABRASIVO disponibile in matasse da 30 m - PUR CALOR/ANTIABRASIVE hose available in length of 30 meters (004.027-MAT Ø 40 - 004.028-MAT Ø 50)

NB. Esclusi da queste connessioni i modelli TH e QT Q-BAT - Excluded from these connections TH and QT Q-BAT models



PROLUNGA IN ACCIAIO 50 cm Ø 50 (a)  
STEEL EXTENSION TUBE 50 cm Ø 50 (a)  
Cod. 004.138

PROLUNGA IN ACCIAIO Ø 50 (a+b)  
STEEL EXTENSION TUBE Ø 50 (a+b)  
Cod. 004.137



LANCIA PIATTA Ø 50 - CREVICE TOOL Ø 50  
Cod. 004.299.002



PENNELLO Ø 50 - ROUND BRUSH Ø 50  
Cod. 004.096



DOPPIA CURVA IN ACCIAIO Ø 40  
DOUBLE ELBOW TUBE, STEEL Ø 40  
Cod. 004.046



LANCIA PIATTA Ø 40 - CREVICE TOOL Ø 40  
Cod. 004.421



PENNELLO Ø 40 - ROUND BRUSH Ø 40  
Cod. 004.088



MANINA IN GOMMA ANTISTATICA-ANTIOLIO-CALOR Ø 50  
HAND TOOL ANTISTATIC/OIL PROOF-CALOR Ø 50  
Cod. 004.220



TRONCO PUNTA 45° ANTISTATICA-ANTIOLIO-CALOR Ø 50  
RUBBER NOZZLE WIT 45° ANGLE ANTISTATIC/OIL PROOF-CALOR Ø 50  
Cod. 004.222



LANCIA PIATTA ANTISTATICA-ANTIOLIO-CALOR CON MANICOTTO Ø 50  
CREVICE TOOL ANTISTATIC/OIL PROOF-CALOR WITH CUFF Ø 50  
Cod. 004.095 (Lancia-Lance) Cod. 004.017 (Manicotto-Cuff)



LANCIA CONICA CURVA ANTISTATICA-ANTIOLIO-CALOR Ø 50  
CURVED-TIP RUBBER NOZZLE ANTISTATIC/OIL PROOF-CALOR Ø 50  
Cod. 004.225



PENNELLO ANTISTATICO-ANTIOLIO-CALOR Ø 50  
ROUND BRUSH ANTISTATIC/OIL PROOF-CALOR Ø 50  
Cod. 004.299.003



SPAZZOLA SETOLE VENTOSA Ø 50  
BRUSH SQUEEGEE FLOOR TOOL Ø 50  
Cod. 004.450

RICAMBIO SETOLE (a)  
SPARE PART BRUSH FLOOR  
Cod. 004.291

RICAMBIO VENTOSE (b)  
SPARE PART SQUEEGEE  
Cod. 004.292



SPAZZOLA VENTOSA Ø 40  
SQUEEGEE FLOOR TOOL Ø 40  
Cod. 004.326



SPAZZOLA SETOLE Ø 40  
BRUSH FLOOR TOOL Ø 40  
Cod. 004.331



MANICOTTO IN ACCIAIO  
ZINCATO  
Ø 50 per tubi Ø 40/50  
GALVANIZED STEEL  
JUNCTION CUFF  
Ø 50 for hose Ø 40/50  
Cod. 004.033





## APPLICAZIONI SPECIALI / SPECIAL APPLICATION SYSTEMS

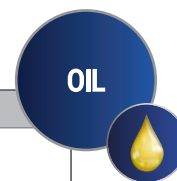

OLIO*	OIL*	
<ul style="list-style-type: none"> <li>Specificamente progettata per la separazione dei trucioli metallici e degli scarti dai lubrificanti e dall'olio prodotti da torni da macchine a controllo numerico e altre installazioni metalliche.</li> <li>L'applicazione è così composta:               <ul style="list-style-type: none"> <li>- tubo di scarico olio</li> <li>- cestello separatrucioli inox</li> <li>- filtro nylon</li> <li>- tubo antiolio 5 mt</li> <li>- lancia piatta antiolio</li> <li>- riduttore in acciaio 70/50</li> </ul> </li> </ul>	<ul style="list-style-type: none"> <li>Specifically designed for the separation of metal shavings and scrap waste from lubricants and oil produced during work with lathers, CNC machines and other metal shaping installations.</li> <li>The application is made up like this:               <ul style="list-style-type: none"> <li>- oil drain hose</li> <li>- metal shavings filtration device in inox</li> <li>- nylon filter</li> <li>- oil-proof hose 5 mt</li> <li>- oil-resistant crevice tool</li> <li>- stainless steel reduction cuff 70/50</li> </ul> </li> </ul>	
DESCRIZIONE - DESCRIPTION		COD.
APP: "OLIO" per serie TT (230 V) - APP: "OIL" for TT series (230 V)		004.200
APP: "OLIO" per serie TTX-TCX (230 V) - APP: "OIL" for TTX-TCX series (230 V)		004.201
APP: "OLIO" per serie TT (400 V) - APP: "OIL" for TT series (400 V)		004.283
APP: "OLIO" per serie TTX-TCX (400 V) - APP: "OIL" for TTX-TCX series (400 V)		004.284
EVAC OPTION - Sistema pompa svuotamento fusto (230 V) - EVAC OPTION - Pump evacuation system (230 V)		004.202
EVAC OPTION - Sistema pompa svuotamento fusto (400 V) - EVAC OPTION - Pump evacuation system (400 V)		004.203



ANTISTATICO	ANTISTATIC	
<ul style="list-style-type: none"> <li>L'intera macchina inclusi filtri e accessori sono realizzati in materiali conduttivi e/o sono completi di messa a terra.</li> <li>L'applicazione è così composta:               <ul style="list-style-type: none"> <li>- filtro antistatico in classe L</li> <li>- tubo di aspirazione antistatico 5 mt</li> <li>- lancia piatta antistatica</li> </ul> </li> </ul>	<ul style="list-style-type: none"> <li>The entire machine including filters and attachments are made of conductive materials and/or are completely grounded.</li> <li>The application is made up like this:               <ul style="list-style-type: none"> <li>- antistatic filter in class L</li> <li>- antistatic vacuum hose 5 mt</li> <li>- antistatic crevice tool</li> </ul> </li> </ul>	
DESCRIZIONE - DESCRIPTION		COD.
APP: "ANTISTATIC" per serie QT - APP: "ANTISTATIC" for QT series		004.195
APP: "ANTISTATIC" per serie TT - APP: "ANTISTATIC" for TT series		004.194
APP: "ANTISTATIC" con filtro stellare per serie TTX-TCX - APP: "ANTISTATIC" with star-shaped filter for TTX-TCX series		004.197



ELEVATA FILTRAZIONE	HIGH FILTRATION
<ul style="list-style-type: none"> <li>Consigliato per la filtrazione e rimozione di polveri molto fini e particelle microscopiche.</li> <li>L'applicazione è così composta:                             <ul style="list-style-type: none"> <li>- filtri HEPA in classe H13 o H14</li> <li>- filtri a sacco o stellari in classe M</li> </ul> </li> <li>Opzionale SCUOTIFILTRO per filtro canestro.</li> </ul>	<ul style="list-style-type: none"> <li>Recommended for the filtration and removal of extremely fine dust and microscopic particles.</li> <li>The application is made up like this:                             <ul style="list-style-type: none"> <li>- HEPA filter in class H13 or H14</li> <li>- filter bag or star-shaped in class M</li> </ul> </li> <li>Optional: basket filter shaker</li> </ul>

	DESCRIZIONE - DESCRIPTION		COD.
	HEPA H13 + filtro sacco in classe M per serie QT - Q-BAT HEPA H13 + filter bag in class M for QT - Q-BAT series	1	004.420
	HEPA H13 + filtro sacco in classe M per serie MT HEPA H13 + filter bag in class M for MT series	1	004.476
	HEPA H13 + filtro stellare in classe M per serie TT HEPA H13 + star-shaped filter in class M for TT series	2	004.159
	HEPA H14 + filtro stellare in classe M per serie TTX HEPA H14 + star-shaped filter in class M for TTX series	2	004.208
	HEPA H14 + filtro stellare in classe M per serie TCX HEPA H14 + star-shaped filter in class M for TCX series	2	004.115
	HEPA H14 + filtro stellare in classe M per serie TT EX HEPA H14 + star-shaped filter in class M for TT EX series	2	08AC006
	HEPA H14 + filtro stellare in classe M per serie TTX EX HEPA H14 + star-shaped filter in class M for TTX EX series	2	08AC007
	Scuotifiltro elettrico per serie TT - TTX - TCX (230 V)** Electric filter shaking mechanism for TT - TTX - TCX series (230 V)**		004.061
	Scuotifiltro elettrico per serie TT - TTX - TCX (400 V)** Electric filter shaking mechanism for TT - TTX - TCX series (400 V)**		004.189
	Scuotifiltro elettrico temporizzato per serie TT - TTX - TCX (230 V)** Electric timed filter shaking mechanism for TT - TTX - TCX series (230 V)**		004.290
	Scuotifiltro elettrico temporizzato per serie TT - TTX - TCX (400 V)** Electric timed filter shaking mechanism for TT - TTX - TCX series (400 V)**		004.062
	Filtro HEPA CLASSE H13 per serie TH HEPA filter CLASS H13 for TH series		004.437
	Filtro HEPA CLASSE H13 per serie QT - Q BAT HEPA filter CLASS H13 for QT - Q BAT series		004.348
	Filtro HEPA CLASSE H13 per serie MT - TT HEPA filter CLASS H13 for MT - TT series		004.289
	Filtro HEPA CLASSE H14 per serie TTX HEPA filter CLASS H14 for TTX series		004.116
	Filtro HEPA CLASSE H14 per serie TCX HEPA filter CLASS H14 for TCX series		004.632

\* Solo per macchine con fusti INOX AISI 304 - Only for machines with stainless steel AISI 304 tanks

\* Installato in fase di produzione macchina - Must be installed during manufacturing

\*\* Installato in fase di produzione macchina - Must be installed during manufacturing

## ACCESSORI A RICHIESTA / ACCESSORIES ON DEMAND

	DESCRIZIONE DESCRIPTION	CODICE CODE	CLASSE CLASS	SUPERFICIE FILTRANTE FILTER SURFACE AREA	DA UTILIZZARE CON: FOR USE WITH:
	Filtro cilindrico Cylindric filter	004.151	POLYESTER CLASS L con anello metallo/ with metal ring	8.800 cm <sup>2</sup>	TTX
		004.257	WATER/OIL PTFE TREATMENT REPELLENT CLASS L con anello plastica/ with plastic ring	4.400 cm <sup>2</sup>	QT - MT - TT
		004.110	CALOR/HEAT RESISTANT CLASS L con anello plastica/ with plastic ring	4.400 cm <sup>2</sup>	QT - MT - TT
		004.261	ANTISTATIC CLASS L con anello plastica/ with plastic ring	4.400 cm <sup>2</sup>	QT - MT - TT
		004.262	POLYESTER CLASS M con anello plastica/ with plastic ring	4.400 cm <sup>2</sup>	QT - MT - TT
	004.417	CALOR/HEAT RESISTANT CLASS L con anello plastica e tendifiltro/ with plastic ring and basket	2.700 cm <sup>2</sup>	TH	
	Filtro stellare con grande superficie filtrante Star-shaped filter with large surface area	004.267	POLYESTER CLASS L con anello plastica/ with plastic ring	15.000 cm <sup>2</sup>	MT - TT
		004.268	WATER/OIL PTFE TREATMENT REPELLENT CLASS L con anello plastica/ with plastic ring	15.000 cm <sup>2</sup>	MT - TT
		004.269	CALOR/HEAT RESISTANT CLASS L con anello plastica/ with plastic ring	15.000 cm <sup>2</sup>	MT - TT
		004.270	ANTISTATIC CLASS L con anello plastica/ with plastic ring	15.000 cm <sup>2</sup>	MT - TT
		004.271	POLYESTER CLASS M con anello plastica/ with plastic ring	15.000 cm <sup>2</sup>	MT - TT
		004.272	WATER/OIL PTFE TREATMENT REPELLENT CLASS L con anello metallo/ with metal ring	21.000 cm <sup>2</sup>	TTX - TCX
		004.273	CALOR/HEAT RESISTANT CLASS L con anello metallo/ with metal ring	21.000 cm <sup>2</sup>	TTX - TCX
		004.274	ANTISTATIC CLASS L con anello metallo/ with metal ring	21.000 cm <sup>2</sup>	TTX - TCX
		004.275	POLYESTER CLASS M con anello metallo/ with metal ring	21.000 cm <sup>2</sup>	TTX - TCX
	Filtro/sacchetto nylon Nylon filter	004.103	-	-	TH - QT - MT - TT
		004.118	-	-	MTP - MTX - TTX - TCX
	Filtro a sacco super Super filter bag	004.335	-	-	TH - QT
	kit Ø 40 mm	004.330	-	-	SP - SM - EX - RC - MRC TH - QT - Q BAT
	kit antistatico Ø 50 mm Antistatic kit Ø 50 mm	08AC008	-	-	MTP - MTX - MT - MTV - TT(EX) - TTV(EX) - TTX - TTXV - TCX - TCXV

	DESCRIZIONE DESCRIPTION	CODICE CODE	DIAMETRO DIAMETER	LATO SIDE	DA UTILIZZARE CON: FOR USE WITH:	
	Tubo EVA EVA INDUSTRIAL hose	004.001 (l=1m)	40 mm	-	MT - MTP - TT TTX - TCX	
		004.001-MAT (l=30m)				
		004.002 (l=1m)	50 mm			
		004.002-MAT (l=30m)				
	Tubo EVA ANTISTATICO/ANTIOLIO EVA ANTISTATIC/OIL hose	004.007 (l=1m)	40 mm	-	MT - MTP - TT TTX - TCX	
		004.007-MAT (l=30m)				
		004.008 (l=1m)	50 mm			
		004.008-MAT (l=30m)				
	Tubo PUR CALOR/ANTIABRASIVO, PUR CALOR/ANTIABRASIVE hose	004.027 (l=1m)	40 mm	-	MT - MTP - TT TTX - TCX	
		004.027-MAT (l=30m)				
		004.028 (l=1m)	50 mm			
		004.028-MAT (l=30m)				
	Manicotto per tubo EVA Pvc cuff for EVA hose	004.014	40 mm	accessori accessories	Tutti (no antistatico/calor) All (no antistatic/calor)	
		004.016	40 mm		Tutti (antistatico/calor) All (antistatic/calor)	
		004.158	50 mm		macchina machine	MT - MTP - TT TTX - TCX
		004.015	50 mm			
	Manicotto per tubo PUR CALOR/ ANTIABRASIVO Cuff for PUR CALOR/ANTIABRASIVE hose	004.050	50 mm	macchina/ accessori machine/ accessories	MT - MTP - TT TTX - TCX	
	Manicotto per tubo EVA antistatico/ antiolio Rubber oil-proof cuff for EVA hose	004.299.010	50 mm		MT - MTP - TT TTX - TCX	
	Manicotto per tubo EVA antistatico/ antiolio Rubber oil-proof cuff for EVA hose	004.031	40/50 mm		MT - MTP - TT TTX - TCX	
Manicotto per tubo PUR CALOR/ ANTIABRASIVO Cuff for PUR CALOR/ANTIABRASIVE hose	004.299.011	40/50 mm		MT - MTP - TT TTX - TCX		
	Manicotto girevole per tubo EVA Roating cuff for EVA hose NO ANTISTATIC	004.472	36 mm	accessori accessories	MAXIM 15-25 OTHELLO	
		004.152	40 mm		SP - SM - EX - RC - MRC TH - QT - Q BAT	
	Manicotto per tubo EVA con gola Cuff with groove for EVA hose (NO ANTISTATIC)	004.316	36 mm	macchina machine	MAXIM 15-25 OTHELLO	
	Manicotto per tubo EVA con gola Cuff with groove for EVA hose (NO ANTISTATIC)	004.328	40 mm		SP - SM - EX - RC - MRC TH - QT - Q BAT	
	Manicotto per tubo EVA con gola Cuff with groove for EVA hose (ANTISTATIC)	004.030	40 mm			
	Manicotto di collegamento in gomma antistatica/antiolio * Rubber antistatic/oil-proof junction cuff *	004.017*	40/50 mm	macchina machine	SP - SM - EX - RC - MRC MT - MTP - TT TTX - TCX	
	Manicotto in acciaio zincato Ø 70/70 Zinc plated steel cuff Ø 70/70	004.188	70 mm	macchina machine	MTP-MTX-MT-MTV TT-TTV-TTX-TTXV TCX-TCXV	
	Lancia conica in gomma antistatica, antiolio, CALOR con foro 10-25 mm Antistatic, oil-resistant, heat-resistant rubber cone nozzle with 10-25 mm tip	004.082	40 mm	accessori accessories	Tutti / All	
		004.083	50 mm		MT-MTP-TT-TTX-TCX	
	Biforcazione con riduttore in acciaio zincato Same-diameter reduction y-cuff in steel	004.294	in 50 mm out 50-50 mm	macchina machine	SP - SM - EX - RC - MRC TH - QT - Q BAT	
		004.285	in 70 mm out 50-50 mm		MT - MTP - TT TTX - TCX	
	Lancia piatta inox Crevice tool, stainless steel	004.064	40 mm	-	Tutti / All	
		004.065	50 mm			
	Kit forno (ventosa senza ruote) Oven tool (squeegee without wheels)	004.332	40 mm	-	TH - QT - Q-BAT	
		004.132	50 mm		MT - TT - TTX - TCX	
	Kit forno (ventosa con ruote) Oven tool (squeegee with wheels)	004.353	40 mm		TH - QT - Q-BAT	
		004.343	50 mm		MT - TT - TTX - TCX	

\*Da utilizzare per trasformare kit forno da Ø 40 a Ø 50  
To be used to transform oven kit from Ø 40 to Ø 50

	DESCRIZIONE DESCRIPTION	CODICE CODE	DIAMETRO DIAMETER	DA UTILIZZARE CON: FOR USE WITH:
	Tubo flessibile acciaio completo Flexible hose, steel, diam.40 mm complete	004.345	40 mm	Tutti/All (kit forno-oven kit)
	Prolunga alluminio diam.40 mm(l=1 m) Aluminum extension tube, diam. 40 mm(l=1 m)	004.341	40 mm	Tutti/All (kit forno-oven kit)
	Prolunga alluminio diam.40 mm(l=1 m) per ventosa senza ruote Aluminum extension tube, diam. 40 mm(l=1 m) for squeegee without wheels	004.341-SR		Tutti/All (kit forno-oven kit)
	Prolunga alluminio diam.40 mm(l=1 m) per ventosa con ruote Aluminum extension tube, diam. 40 mm(l=1 m) for squeegee with wheels	004.341-CR		Tutti/All (kit forno-oven kit)
	Prolunga alluminio semi-protezione diam.40 mm, 1 metro Aluminum extension tube, semi-protection, diam. 40 mm, 1 meter	004.366	40 mm	Tutti/All (kit forno-oven kit)
	Prolunga alluminio protezione totale diam.40 mm, 1 metro Aluminum extension tube, full protection, diam. 40 mm, 1 meter	004.365	40 mm	Tutti/All (kit forno-oven kit)
	Ventosa senza ruote Squeegee without wheels	004.356-01	40 mm	Tutti/All (kit forno-oven kit)
	Ventosa con ruote Squeegee with wheels	004.355	40 mm	Tutti/All (kit forno-oven kit)
	Separatrucioli inox Filtration device for metal shavings from oil emulsions and liquids, stainless steel	004.101	-	MT - TT
		004.093		TTX - TCX
	Ciclone plastica Plastic cyclone	004.133	-	MT - TT
		004.102		TTX - TCX
	Fusto separatore completo, 80 litri Separator tank, complete, 80 litres	001.499.022	-	QT - MT - TT TTX - TCX
	Fusto separatore ciclonico completo, 80 litri Cyclonic separator tank, complete, 80 litres	004.276	-	Tutti/All
	Fusto separatore ad acqua completo, 80 litri Water-cooled separator, complete, 80 litres	004.277	-	Tutti/All
	Scuotifiltro elettrico completo* Electric filter shaking mechanism*	004.061	-	TT - TTX - TCX (230V)
		004.189		TT - TTX - TCX (400V)
	Scuotifiltro elettrico temporizzato* Electric timed filter shaking mechanism*	004.290	-	TT - TTX - TCX (230V)
		004.062		TT - TTX - TCX (400V)
	Sistema pompa svuotamento fusto EVAC OPTION (230V)* Pump evacuation system EVAC OPTION (230V)*	004.202	-	TT - TTX - TCX (230V)
	Sistema pompa svuotamento fusto EVAC OPTION (400V)* Pump evacuation system EVAC OPTION (400V)*	004.203	-	TT - TTX - TCX (400V)
Solo per macchine con fusti INOX AISI 304 Only for machines with stainless steel AISI 304 tanks	Sistema galleggiante elettrico* Electric floater system*	004.278	-	TT - TTX - TCX (230V)
		004.282		TT - TTX - TCX (400V)

\* Installato in fase di produzione macchina - Must be installed during manufacturing