

Lac Courte Oreilles Management Plan

*Phase I: Water Quality Study of Lac Courte Oreilles
Phase II: Hydrologic and Phosphorus Budgets*

*Prepared for
Lac Courte Oreilles Conservation Department*

*with Assistance from:
Lac Courte Oreilles Conservation Department
Courte Oreilles Lakes Association (COLA)
Sawyer County Land and Water Conservation Department
Wisconsin Department of Natural Resources*

April 1998

Barr

Engineering Company

8300 Norman Center Drive

Minneapolis, MN 55437

Phone: (612) 832-2600

Fax: (612) 832-2601

Acknowledgments

The Lac Courte Oreilles Management Plan, Phases I and II, was completed with the assistance of the Lac Courte Oreilles Conservation Department and the Courte Oreilles Lakes Association (COLA). A special thanks to the following volunteers for their help during the project:

Daniel Tyrolt	Overall Project Coordinator Collection of Lake, Stream, and Periphyton Data Summarization of Data in Tables and Graphs
Sam Quagon	Collection of Lake, Stream, and Periphyton Data Summarization of Data in Tables and Graphs
Harry Schroeder	Chairman of COLA
Bob Degen	Volunteer Team Leader Collect Secchi Disc Data Read Rain Gage and Measure Lake Levels
Signe Schroeder	Read Rain Gage
George Paine	Collect Secchi Disc Data Read Rain Gage and Stream Staff Gage
Whitney Ursprung	Collect Secchi Disc Data Read Rain Gage and Stream Staff Gage
Phil Nies	Read Stream Staff Gage
Nancy Pollock	Read Stream Staff Gage
Harry Shannon	Collect Secchi Disc Data and Read Rain Gage

Dick Hagen Collect Secchi Disc Data and Read Rain Gage

Bill Kremer Collect Secchi Disc Data and Read Rain Gage

Bob Hawley Read Rain Gage

Tavila Kalsner Read Rain Gage

Thank you to the Wisconsin Department of Natural Resources for collection of data from the eastern Basin (Station A). Thanks to Dan Ryan of the Wisconsin Department of Natural Resources for help and support throughout the project. Thank you to Dale Olson of the Sawyer County Land Conservation Department for providing land use information for the Lac Courte Oreilles Tributary Watershed. Thank you to the Lac Courte Oreilles College for analyses of periphyton samples.

Forward

This report summarizes the results of the first two phases of work on a planned three phase project being conducted to prepare a Lac Courte Orielles Management Plan. In Phase I, basic in-lake and tributary water quality data were collected from mid-March through early-November of 1996 to characterize existing conditions. These data were subsequently used in Phase II of the project to estimate annual hydrologic and phosphorus budgets. This was done to examine the relationship between watershed landuse activities and lake water quality. In Phase III of the Lac Courte Orielles Management Plan project assessments of the relative importance of phosphorus inputs from various sources will be made in the context of predicting the achievable water quality improvements likely to result from the implementation of watershed best management practices.

In preparing this report on the results of Phase I and Phase II project activities, it was necessary to estimate the yields of water and phosphorus to the lake from various watershed land use activities using export rate coefficients extrapolated from other studies. These coefficients represent the annual mass loading of water or phosphorus to a lake per unit of source (e.g., cubic meters of water or kilograms of phosphorus per hectare of forested land). Selection of these coefficients was done by carefully screening a range of values for each watershed land use activity and selecting the values that seemed most appropriate given the prevailing watershed conditions. The suitability of the selected export rate coefficients for both water and phosphorus were further evaluated in terms of how well they predicted in-lake water quality conditions when used in a watershed water balance and input-output phosphorus lake models. However, good these model predictions are, they result from an estimation process that involves the best professional judgement of the modeler, and additional sampling may be desirable to confirm apparent sources of high phosphorus loads. Mindful of the limitations associated with the estimation procedures used, it is our professional opinion that our estimated hydrologic and phosphorus budgets are reasonably accurate in portraying relative contributions to the lake's total annual phosphorus budget from its constituent sources.

Executive Summary

The study described by this report was initiated by the Lac Courte Oreilles (LCO) Conservation Department to provide information for the development of a lake management plan. The study involved collection of data from Lac Courte Oreilles, its inflows, its outflow, and its watershed during 1996. Annualized hydrologic and phosphorus budgets were then modeled for existing watershed land use conditions.

The lake water quality data showed that Lac Courte Oreilles, with few exceptions, exhibited a relatively homogeneous water quality. Total phosphorus data were generally within the oligotrophic (nutrient poor) category throughout the summer; chlorophyll, and Secchi disc data were generally within the mesotrophic (moderate algal growth, minimal or no recreational use impairment) category. Overall, algal yields from available phosphorus were higher than expected based on the concentrations of chlorophyll present in the lake.

Poorer water quality was observed within Basin D (See Figure 1) and better water quality was observed within the lake's deep east basin (i.e., Station A, See Figure 1) relative to the other locations. Basin D noted a summer average total phosphorus concentration approximately four times higher than comparable concentrations from the other locations. The Basin D summer average phosphorus concentration was within the eutrophic (i.e., well nourished or phosphorus rich) category and suggests the bay has the potential for undesirable algal blooms in the summer months. The summer average chlorophyll *a* concentration within Basin D was approximately double the comparable concentrations observed in all other locations except the deep east basin, where the comparable concentration was approximately 18 percent of the Basin D concentration. The Basin D summer average Secchi disc transparency measurement was approximately 30 percent lower than comparable measurements from other locations. Other indications of poorer water quality in Basin D include a dense macrophyte growth throughout the summer and large mats of filamentous algae that are frequently found floating above the macrophyte beds (Hagen, 1997, Personal Communication).

Although phosphorus concentrations within the lake's deep east basin (Basin A) were similar to other basins (except Basin D), a lower algal yield appears to have occurred within Basin A. Consequently, water transparency was better because fewer algae were found within the basin. Basin A noted an average summer chlorophyll *a* concentration 30 to 50 percent lower than

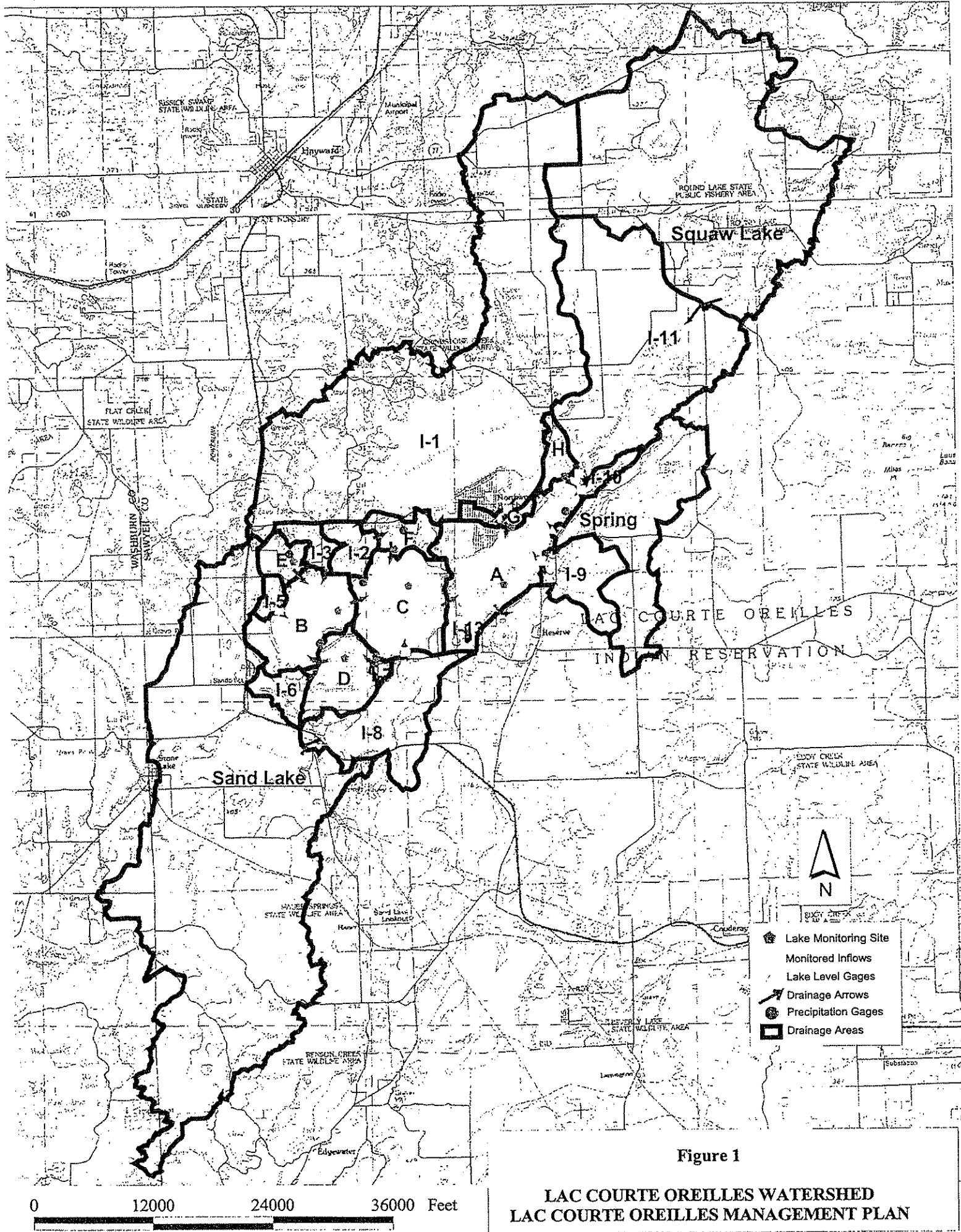

Figure 1

LAC COURTE OREILLES WATERSHED
LAC COURTE OREILLES MANAGEMENT PLAN

measurements observed at all locations except Basin D. Basin A noted a summer average Secchi disc transparency measurement approximately 20 to 50 percent greater than measurements observed at all locations except Basin D.

The results of the overall lake phosphorus budget analysis estimated that the total annual phosphorus load into Lac Courte Oreilles is approximately 4,658 pounds per year, based on 1995-1996 data. Based on modeling results, the individual budgets for each of the lake's three basins and five bay areas (See Table 1) suggest:

- Phosphorus loading to basins within Lac Courte Oreilles was generally proportional to basin water volume. Consequently, a relatively homogeneous water quality was noted in the lake despite different estimates in loading to the lake's basins. Exceptions occurred within Basins D and G (See Figure 1). Higher annual phosphorus loads relative to basin water volume are estimated for Basins D and G. A comparison of pounds of phosphorus per acre-foot loaded to Basins D and G annually result in estimated values of 0.26 and 0.50, respectively. This compares with estimates of 0.02 to 0.09 pounds of phosphorus per acre-foot loaded to other lake basins.

An assessment of the estimated phosphorus loading to Basin G indicates the load consists almost entirely of inflow waters from Grindstone Lake. High volumes of low phosphorus concentrations of water are believed to be loaded to Basin G on a continuous year-round basis, resulting in a relatively high annual phosphorus load. Water quality within Basin G was excellent however, and comparable with other lake basins, presumably because of its relatively rapid flushing rate.

Based on the data collected and assumed export coefficients, Basin D is estimated to receive approximately 44 percent of its annual phosphorus load from tributary cranberry bogs, mostly during the growing season. Although direct measurements were not available, based on modeling estimates, most of the phosphorus load from cranberry bogs is believed to have occurred during the fall period following harvesting and during the spring period when winter/spring flood waters are released and fertilization of the bogs occur. Basin D noted higher phosphorus concentrations and poorer water quality than other basins during the growing season.

- Inflowing stream contributions are predicted to range from more than a quarter to nearly all of the annual phosphorus load to Basins A, C, and G. Squaw Creek is estimated to comprise nearly 30 percent of the annual phosphorus load to Basin A. Whitefish Creek is estimated to

Table 1 Estimated Lac Courte Oreilles Annual Phosphorus Budget Summary of Individual Basins*

Basin	Volume (acre-feet)	Total Annual Phosphorus Loading (pounds)	% Contribution of Phosphorus Loading Inputs										
			Ag.	Res.	Wetl.	Forest	Cran. Bog	Atmos. Dep.	Septic Sys.	Monit. Inflow	Ups. Basins	Int. Load	Water fowl
A	72,882	2,726	0	6.80	0.10	2.30	0.10	17.10	1.40	27.80	39.80	4.60	--
B	33,640	622	1.70	5.99	0	8.71	7.01	48.88	4.22	2.09	18.70	2.69	--
C	48,045	1,540	1.20	0.90	0	2.00	0	27.1	2.00	39.89	11.69	15.20	--
D	1,582	406	6.14	7.44	9.23	14.61	43.51	16.84	1.20	0	0	0	1.09
E	1,323	79	38.66	4.20	0.28	18.21	0	31.65	7.00	0	0	0	--
F	1,636	151	9.05	5.11	0.29	24.67	13.58	45.26	2.04	0	0	0	--
G	904	455	0	4.12	0	2.81	0	3.88	1.89	87.30	0	0	--
H	903	53	0	20.33	0	38.17	0	31.12	10.37	0	0	0	--

Ag. = Agricultural land use Ups. Basins = Upstream Basins
 Res. = Residential land use Int. Load = Internal Load
 Forest = Forested land use Wetl. = Wetlands
 Cran. Bog = Cranberry Bogs Monit. Inflow = Monitored Inflows
 Sep. Sys. = Septic Systems Atmos. Dep. = Atmospheric Deposition

*The total annual and percentage contributions of phosphorus loading are estimated based on assumed phosphorus export rate coefficients and modeling results.

add nearly 40 percent of the annual phosphorus load to Basin C. Grindstone Creek is estimated to add nearly 90 percent of the annual phosphorus load to Basin G.

- Contributions from shallow bay areas to the lake's deep basins are predicted to range from 10 percent to 40 percent of the annual load. Contributions from Basins G and H are estimated to comprise about 40 percent of the annual phosphorus load to Basin A. Contributions from Basin E are estimated to comprise approximately 20 percent of the annual phosphorus load to Basin B. Contributions from Basin F are estimated to comprise approximately 10 percent of the annual phosphorus load to Basin C.
- Basin D (Musky Bay) is sensitive to phosphorus loading because it is shallower (i.e., average depth 6 feet) than the deep basins (i.e., average depths of Basins A through C range from 30 to 44 feet) and other bay areas (i.e., average depths of Basins E through H range from 11 to 15 feet). Consequently, phosphorus added to Basin D appears to be readily available for algal growth.
- Watershed land uses affecting the water quality of the lake include agriculture (estimated to comprise nearly 40 percent of the annual load to Basin E), residential (estimated to comprise approximately 20 percent of the annual phosphorus load to Basin H), and cranberry farming operations (estimated to comprise approximately 44 percent of the annual phosphorus load to Basin D).
- Atmospheric deposition is believed to comprise nearly half the annual phosphorus load to Basins B and F.

Cultural eutrophication impacts on Lac Courte Oreilles were evaluated. Cultural eutrophication describes the acceleration of the natural eutrophication process caused by human activities. An assessment of land uses within the lake's tributary watershed indicates three types of land uses are a result of human activities: agriculture, cranberry farms, and residential land uses. The impact of cultural eutrophication on Lac Courte Oreilles was estimated by modeling pre-development in-lake phosphorus concentrations and comparing estimated pre-development phosphorus concentrations with current phosphorus concentrations (i.e., post-development conditions).

Three modeling scenarios were completed for each lake basin to assess cultural eutrophication impacts:

1. Estimated in-lake phosphorus concentration assuming forest land use (i.e., pre-development condition) instead of residential land use (i.e., current or post-development condition) in the basins' tributary watersheds;
2. Estimated in-lake phosphorus concentration assuming forest land use (i.e., pre-development condition) instead of agricultural land use (i.e., current or post-development condition) in the basins' tributary watersheds;
3. Estimated in-lake phosphorus concentration assuming natural wetlands (i.e., pre-development condition) instead of cranberry farm land use (i.e., current or post-development condition) in the basins' tributary watersheds.

Modeling results indicate that conversion of forest land use to residential or agricultural land use or the conversion of natural wetlands to cranberry farm land use in the watersheds tributary to Basins A through C and Basins F through H did not result in noticeable water quality changes. The no noticeable change estimate is based upon estimated 0 to 2 µg/L increased in-lake total phosphorus concentrations within Basins A through C and Basins F through H for each of the land use changes (i.e., residential, agricultural, or natural wetlands). The estimated 0 to 2 µg/L change in phosphorus concentrations for each of the land use changes results in an estimated decrease in the average annual Secchi disc transparency of 0 to 0.2 meters (0.7 feet) for each of the land use changes. The estimated change in Secchi disc transparency was determined from the predicted relationship between phosphorus and chlorophyll and the predicted relationship between chlorophyll and Secchi disc developed by the Minnesota Pollution Control Agency for phosphorus-limited lakes (Heiskary et al. 1990).

Modeling results indicate that development in the watershed tributary to Basin E has resulted in a noticeable change in water quality. The assumed conversion of forest land use to agricultural land use in the watershed tributary to Basin E results in an estimated 4 µg/L increase in the basin's total phosphorus concentration. The estimated change in phosphorus concentration results in an estimated decrease in the average annual Secchi disc transparency of 1.2 meters (3.8 feet), using the predicted relationship between phosphorus and chlorophyll and the predicted relationship between chlorophyll and Secchi disc developed by the Minnesota Pollution Control Agency for phosphorus-limited lakes (Heiskary et al. 1990).

Modeling results indicate that development in the watershed tributary to Basin D has resulted in a noticeable change in water quality. An estimated 10 µg/L increased in-lake total phosphorus concentration results from the assumed change from natural wetlands to cranberry farm land use. The estimated change in phosphorus concentration results in an estimated decrease in the average

annual Secchi disc transparency of 1.7 meters (5.5 feet), using the predicted relationship between phosphorus and chlorophyll and the predicted relationship between chlorophyll and Secchi disc developed by the Minnesota Pollution Control Agency for phosphorus-limited lakes (Heiskary et al. 1990).

Modeling results indicate the assumed change from forest land use to residential land use and the assumed change from forest land use to agricultural land use in the watershed tributary to Basin D results in an estimated 2 µg/L increased total phosphorus concentration. The modeling results further indicate these assumed land use changes have not resulted in a noticeable change in the water clarity of Basin D. Based upon an estimated 2 µg/L increased total phosphorus concentration in Basin D, a decrease in the average annual Secchi disc transparency of 0.2 meters (0.7 feet) is estimated for each land use change (i.e., residential and agricultural), using the predicted relationship between phosphorus and chlorophyll and the predicted relationship between chlorophyll and Secchi disc developed by the Minnesota Pollution Control Agency for phosphorus-limited lakes (Heiskary et al. 1990).

Cultural eutrophication impacts upon Basin D were also modeled per Vighi et al. (1985). Model results support the estimated changes in total phosphorus concentration from watershed development discussed in the preceding paragraphs.

Completion of a Lake Management Plan for Lac Courte Oreilles is recommended to preserve the existing water quality of the lake and explore water quality improvement options for Basin D. The following project is recommended:

- Additional study of Basin D is recommended to provide further information for the design of an effective management plan. A water quality and macrophyte study is recommended to provide: (1) more detailed information regarding temporal water quality changes during the summer, (2) information regarding spatial changes in water quality during the summer (i.e., collection of samples at several sample locations will help determine the spatial coverage and severity of algal blooms during the summer months), (3) information regarding the coverage, density, and species composition of the macrophyte community, (4) more detailed information regarding waterfowl usage of Basin D, and (5) information regarding the depth of the flocculent sediment layer within Basin D.
- A paleolimnological study of Basin D is recommended to evaluate the rate of sediment accumulation in Basin D over time, back to a time before European settlement of the area.

This would be done through the collection and analyses of Basin D sediment cores. Cores would be analyzed by segmenting them into separate strata at various depth intervals; dating each stratum by Lead-210 isotopic techniques; and then subjecting the same samples to testing for organic matter, carbonate, and phosphorus content as indicators of water column fertility. Such a study would provide data on Basin D water quality dating back to the year 1800.

- Development of a management plan for Lac Courte Oreilles is recommended, including (1) the development of a long-term water quality goal for each basin within Lac Courte Oreilles, (2) an evaluation of different watershed development scenarios to determine acceptable (i.e., the water quality of the lake is within the established goal) and unacceptable (i.e., the water quality of the lake fails to meet its goal) development options, (3) the evaluation of watershed best management practices (BMPs) implementation relative to goal achievement under unacceptable development scenarios (i.e., development scenarios that the water quality of the lake fails to meet its goal without BMPs), and (4) the completion of a lake management plan.

The results of the Lac Courte Oreilles estimated phosphorus budgets indicate the following management recommendations should be considered until completion of the lake management plan occurs.

- Lake management plans for Whitefish Lake and Grindstone Lake are recommended. Water quality degradation of the lakes will result in increased phosphorus loading to Basins C, G, and A.
- BMPs to reduce phosphorus loading to Basin D should be considered to improve the basin's water quality and prevent further degradation.

Lac Courte Oreilles Management Plan

Table of Contents

Executive Summary	i
1.0 Introduction	1
1.1 Report Coverage	1
2.0 General Concepts in Lake Water Quality	3
2.1 Eutrophication	3
2.2 Trophic States	4
2.3 Limiting Nutrients	4
2.4 Nutrient Recycling and Internal Loading	5
2.5 Stratification	5
2.6 Lake Zones	6
2.7 Riparian Zone	8
2.8 Watershed	10
3.0 Basin Characteristics	12
4.0 Methods	13
4.1 Lake Water Quality Data Collection	13
4.2 Periphyton Methods	13
4.3 Inflow/Outflow Monitoring Methods	21
4.4 Evaluation of the Tributary Watershed	21
4.5 Hydrologic Budget Calculations	25
4.6 Phosphorus Budget and Lake Water Quality Mass Balance Model	26
5.0 Results and Discussion	32
5.1 Compiled Data	32
5.2 1996 Lake Water Quality Conditions	32
5.2.1 Phosphorus	32
5.2.2 Chlorophyll <i>a</i>	42
5.2.3 Secchi Disc Transparency	52
5.2.4 Temperature, Dissolved Oxygen, Total Dissolved Solids, and Specific Conductance Isopleth Diagrams	63
5.2.5 pH Isopleth Diagrams	95
5.2.6 Alkalinity Data	104
5.2.7 Water Quality Comparison Between Sample Locations	104
5.3 Inflow Data	105
5.4 Periphyton: Estimated Soluble Reactive Phosphorus Concentrations at Inflow Locations	110
5.5 Evaluation of Historical Secchi Disc Data	112
5.6 Rainfall, Evaporation and Lake Outlet Data	116
5.7 Hydrologic Budget Calculations	116
5.8 Phosphorus Budget and Lake Water Quality Mass Balance Model	118
5.8.1 Basin A—East Basin—Modeling Results	121
5.8.2 Basin B—West Basin—Modeling Results	121
5.8.3 Basin C—Central Basin—Modeling Results	121
5.8.4 Basin D—Musky Bay—Modeling Results	128
5.8.5 Basin E—Stukey Bay—Modeling Results	133

5.8.6	Basin F—Chicago Bay—Modeling Results	133
5.8.7	Basin G—Grindstone Bay—Modeling Results	138
5.8.8	Basin H—Northeast Bay—Modeling Results	138
5.8.9	Model Calibration	138
5.9	Cultural Eutrophication Impacts on Lac Courte Oreilles	144

6.0	Recommendations and Management Actions	153
-----	----------------------------------------------	-----

References
Appendices

List of Tables

Table 1	Estimated Lac Courte Oreilles Annual Phosphorus Budget Summary of Individual Basins	iv
Table 2	Morphologic Characteristics of Lac Courte Oreilles Basins and Bays	12
Table 3	Lac Courte Oreilles Water Quality Parameters	15
Table 4	Lac Courte Oreilles Subwatershed Areas	24
Table 5	1996 Lac Courte Oreilles Surface Water May Through September Average N:P Ratios	33
Table 6	1996 Lac Courte Oreilles Surface Water Alkalinity Measurements (mg/L Calcium Carbonate)	104

List of Figures

Figure 1	Lac Courte Oreilles Watershed	ii
Figure 2	Lake Zones	7
Figure 3	Riparian Zone	9
Figure 4	Watershed Map of a Lake	11
Figure 5	Lac Courte Oreilles Lake Sample Locations	14
Figure 6	Lac Courte Oreilles Periphyton Sample Locations	16
Figure 7	Periphyton Sampler	17
Figure 8	Lac Courte Oreilles Inflow Sample Locations	22
Figure 9	Lac Courte Oreilles Outflow Sample Location	23
Figure 10	LCO Lake: 1996 Total Phosphorus Conc.—Station A	34
Figure 11	LCO Lake: 1996 Total Phosphorus Conc.—Station B (West Hole)	35
Figure 12	LCO Lake: 1996 Total Phosphorus Conc.—Station C (Central Hole)	36
Figure 13	LCO Lake: 1996 Total Phosphorus Conc.—Station D (Musky Bay)	37
Figure 14	LCO Lake: 1996 Total Phosphorus Conc.—Station E (Stukey Bay)	38
Figure 15	LCO Lake: 1996 Total Phosphorus Conc.—Station F (Chicago Bay)	39
Figure 16	LCO Lake: 1996 Total Phosphorus Conc.—Station G (Grindstone Bay)	40
Figure 17	LCO Lake: 1996 Total Phosphorus Conc.—Station H (Northeast Bay)	41
Figure 18	LCO Lake: 1996 Epilimnetic Chlorophyll Concentration -- Station A	43
Figure 19	LCO Lake: 1996 Epilimnetic Chlorophyll Conc.—Station B (West Hole)	44
Figure 20	LCO Lake: 1996 Epilimnetic Chlorophyll Conc.—Station C (Center Hole)	45
Figure 21	LCO Lake: 1996 Epilimnetic Chlorophyll Conc.—Station D (Musky Bay)	46
Figure 22	LCO Lake: 1996 Epilimnetic Chlorophyll Conc.—Station E (Stukey Bay)	47
Figure 23	LCO Lake: 1996 Epilimnetic Chlorophyll Conc.—Station F (Chicago Bay)	48
Figure 24	LCO Lake: 1996 Epilimnetic Chlorophyll Conc.—Station G (Grindstone Bay)	49
Figure 25	LCO Lake: 1996 Epilimnetic Chlorophyll Conc.—Station H (Northeast Bay)	50
Figure 26	Musky Bay Algal Blooms	51
Figure 27	LCO Lake: 1996 Secchi Disc Readings—Station A	54
Figure 28	LCO Lake: 1996 Secchi Disc Readings—Station B (West Hole)	55
Figure 29	LCO Lake: 1996 Secchi Disc Readings—Station C (Central Hole)	56
Figure 30	LCO Lake: 1996 Secchi Disc Readings—Station D (Musky Bay)	57
Figure 31	LCO Lake: 1996 Secchi Disc Readings—Station E (Stukey Bay)	58
Figure 32	LCO Lake: 1996 Secchi Disc Readings—Station F (Chicago Bay)	59
Figure 33	LCO Lake: 1996 Secchi Disc Readings—Station G (Grindstone Bay)	60
Figure 34	LCO Lake: 1996 Secchi Disc Readings—Station H (Northeast Bay)	61
Figure 35	LCO Lake: 1996 Secchi Disc Readings—Station D (Musky Bay) -- Near Shore and Central Sample Locations	62
Figure 36	LCO Lake: 1996 Lake Temperature Isopleths (C)—Station A (Deep Hole—DNR)	65
Figure 37	LCO Lake: 1996 Lake Temperature Isopleths (C)—Station B (West Hole)	66
Figure 38	LCO Lake: 1996 Lake Temperature Isopleths (C)—Station C (Central Hole)	67
Figure 39	LCO Lake: 1996 Lake Temperature Isopleths (C)—Station D (Musky Hole)	68
Figure 40	LCO Lake: 1996 Lake Temperature Isopleths (C)—Station E (Stukey Hole)	69
Figure 41	LCO Lake: 1996 Lake Temperature Isopleths (C)—Station F (Chicago Bay)	70
Figure 42	LCO Lake: 1996 Lake Temperature Isopleths (C)—Station G (Grindstone Bay)	71
Figure 43	LCO Lake: 1996 Lake Temperature Isopleths (C)—Station H (Northeast Bay)	72
Figure 44	LCO Lake: 1996 Lake Dissolved Oxygen Isopleths (mg/L)—Station A (Deep Hole—DNR)	73

Figure 45	LCO Lake: 1996 Lake Dissolved Oxygen Isoleths (mg/L)—Station B (West Hole)	74
Figure 46	LCO Lake: 1996 Lake Dissolved Oxygen Isoleths (mg/L)—Station C (Center Hole)	75
Figure 47	LCO Lake: 1996 Lake Dissolved Oxygen Isoleths (mg/L)—Station D (Musky Bay)	76
Figure 48	LCO Lake: 1996 Lake Dissolved Oxygen Isoleths (mg/L)—Station D (Stukey Bay)	77
Figure 49	LCO Lake: 1996 Lake Dissolved Oxygen Isoleths (mg/L)—Station F (Chicago Bay)	78
Figure 50	LCO Lake: 1996 Lake Dissolved Oxygen Isoleths (mg/L)—Station G (Grindstone Bay)	79
Figure 51	LCO Lake: 1996 Lake Dissolved Oxygen Isoleths (mg/L)—Station H (Northeast Bay)	80
Figure 52	LCO Lake: 1996 Lake Total Dissolved Solids Isoleths (mg/L)—Station B (West Hole)	81
Figure 53	LCO Lake: 1996 Lake Total Dissolved Solids Isoleths (mg/L)—Station C (Central Hole)	82
Figure 54	LCO Lake: 1996 Lake Total Dissolved Solids Isoleths (mg/L)—Station D (Musky Bay)	83
Figure 55	LCO Lake: 1996 Lake Total Dissolved Solids Isoleths (mg/L)—Station E (Stukey Bay)	84
Figure 56	LCO Lake: 1996 Lake Total Dissolved Solids Isoleths (mg/L)—Station F (Chicago Bay)	85
Figure 57	LCO Lake: 1996 Lake Total Dissolved Solids Isoleths (mg/L)—Station G (Grindstone Bay)	86
Figure 58	LCO Lake: 1996 Lake Total Dissolved Solids Isoleths (mg/L)—Station H (Northeast Bay)	87
Figure 59	LCO Lake Conductivity Isoleths ($\mu\text{mhos/cm}$ @ 25C)—Station B (West Hole)	88
Figure 60	LCO Lake Conductivity Isoleths ($\mu\text{mhos/cm}$ @ 25C)—Station C (Central Hole)	89
Figure 61	LCO Lake Conductivity Isoleths ($\mu\text{mhos/cm}$ @ 25C)—Station D (Musky Bay)	90
Figure 62	LCO Lake Conductivity Isoleths ($\mu\text{mhos/cm}$ @ 25C)—Station E (Stukey Bay)	91
Figure 63	LCO Lake Conductivity Isoleths ($\mu\text{mhos/cm}$ @ 25C)—Station F (Chicago Bay)	92
Figure 64	LCO Lake Conductivity Isoleths ($\mu\text{mhos/cm}$ @ 25C)—Station G (Grindstone Bay)	93
Figure 65	LCO Lake Conductivity Isoleths ($\mu\text{mhos/cm}$ @ 25C)—Station H (Northeast Bay)	94
Figure 66	LCO Lake pH Isoleths—Station A (Deep Hole—DNR)	96
Figure 67	LCO Lake pH Isoleths—Station B (West Hole)	97
Figure 68	LCO Lake pH Isoleths—Station C (Central Hole)	98
Figure 69	LCO Lake pH Isoleths—Station D (Musky Hole)	99
Figure 70	LCO Lake pH Isoleths—Station E (Stukey Bay)	100
Figure 71	LCO Lake pH Isoleths—Station F (Chicago Bay)	101
Figure 72	LCO Lake pH Isoleths—Station G (Grindstone Bay)	102
Figure 73	LCO Lake pH Isoleths—Station H (Northeast Bay)	103
Figure 74	LCO Lake: 1996 Average Summer Epilimnetic Total Phosphorus Conc.	106
Figure 75	LCO Lake: 1996 Average Summer Epilimnetic Chlorophyll Conc.	107
Figure 76	LCO Lake: 1996 Average Summer Secchi Disc Transparency	108
Figure 77	Lac Courte Oreilles: Annual Phosphorus Inputs from Inflow	109
Figure 78	Lac Courte Oreilles Estimated Soluble Reactive Phosphorus Concentrations at Sample Stations P-1 through P-11 Sorted by Month	111
Figure 79	Lac Courte Oreilles Summer Secchi Disc Transparencies—Station A (East Basin)	113
Figure 80	Lac Courte Oreilles Summer Secchi Disc Transparencies—Station B (West Basin)	114
Figure 81	Lac Courte Oreilles Summer Secchi Disc Transparencies—Station C (Center Basin)	115
Figure 82	Lac Courte Oreilles Hydrologic Budget	117
Figure 83	Lac Courte Oreilles Annual Phosphorus Inputs (kg)	119
Figure 84	Lac Courte Oreilles Annual Phosphorus Inputs (%)	120
Figure 85	Lac Courte Oreilles Annual Phosphorus Inputs (kg)—Basin A	122
Figure 86	Lac Courte Oreilles Annual Phosphorus Inputs (%)—Basin A	123
Figure 87	Lac Courte Oreilles Annual Phosphorus Inputs (kg)—Basin B	124
Figure 88	Lac Courte Oreilles Annual Phosphorus Inputs (%)—Basin B	125
Figure 89	Lac Courte Oreilles Annual Phosphorus Inputs (kg)—Basin C	126
Figure 90	Lac Courte Oreilles Annual Phosphorus Inputs (%)—Basin C	127
Figure 91	Lac Courte Oreilles Annual Phosphorus Inputs (kg)—Basin D	131
Figure 92	Lac Courte Oreilles Annual Phosphorus Inputs (%)—Basin D	132
Figure 93	Lac Courte Oreilles Annual Phosphorus Inputs (kg)—Basin E	134
Figure 94	Lac Courte Oreilles Annual Phosphorus Inputs (%)—Basin E	135
Figure 95	Lac Courte Oreilles Annual Phosphorus Inputs (kg)—Basin F	136
Figure 96	Lac Courte Oreilles Annual Phosphorus Inputs (%)—Basin F	137
Figure 97	Lac Courte Oreilles Annual Phosphorus Inputs (kg)—Basin G	139
Figure 98	Lac Courte Oreilles Annual Phosphorus Inputs (%)—Basin G	140
Figure 99	Lac Courte Oreilles Annual Phosphorus Inputs (kg)—Basin H	141
Figure 100	Lac Courte Oreilles Annual Phosphorus Inputs (%)—Basin H	142
Figure 101	Lac Courte Oreilles: Predicted and Observed Total Phosphorus Conc.	143

Figure 102	Algal Blooms in Basin E (Stukey Bay)—June 1996	149
Figure 103	Estimated Total Phosphorus Concentration -- Pre-Development versus Agricultural Land Uses ..	150
Figure 104	Estimated Total Phosphorus Conc. Natural Wetlands Versus Cranberry Farm Land Uses	151
Figure 105	Estimated Total Phosphorus Conc. Pre-Development Versus Residential Land Uses	152

List of Appendices

Appendix A	In-Lake Water Quality Data
Appendix B	Periphyton Data
Appendix C	Inflow and Outflow Data
Appendix D	Stream Staff Gage Measurements
Appendix E	Lake Level Data
Appendix F	Precipitation Data

1.0 Introduction

Lac Courte Oreilles in Sawyer County, Wisconsin, is considered a unique and significant water resource by the Lac Courte Oreilles Band of Lake Superior Chippewa Indians (LCO), Courte Oreilles Lakes Association (COLA), and the Wisconsin Department of Natural Resources (WDNR). It is one of the largest natural lakes in Wisconsin.

During recent years, members of COLA have reported observing increased algal blooms in the shallower bay areas of the lake. Monitoring programs to date have focused on the deep basins within the lake and have not addressed the issue of water quality changes within the bay areas. The WDNR has monitored the deepest location on the lake during the period 1986 through 1992 as a part of its water quality trend monitoring program. Data collected from this location did not suggest a trend toward water quality degradation. Volunteers from COLA have monitored Secchi disc transparencies in Lac Courte Oreilles since 1991 to help evaluate the lake's water quality. The transparency data indicated the lake's water quality was stable. The LCO Conservation Department determined that a comprehensive monitoring program was necessary to address its concern and protect the lake from degradation. Consequently, the LCO Conservation Department initiated a project to develop a management plan. The first two phases of the project include:

- Phase I—Collection of data
- Phase II—Estimation of annual hydrologic and phosphorus budgets for existing watershed land use conditions

1.1 Report Coverage

This report discusses the methodology, results, and conclusions from Phases I and II of the lake management plan development. The report will answer the following three questions that apply to properly managing lakes:

1. What is the general condition of the lake?
2. Are there problems?
3. Are there spatial differences in water quality (i.e., between the lake's shallow bays and its deeper locations, between the various bays, and between the deep basins)?

To answer the first question, this report begins with descriptions of the watershed, the lake, methods of data collection and analysis. The results of water quality monitoring are then summarized in tables, figures, and accompanying descriptions.

To answer the second question, water quality data are analyzed and compared to established water quality standards for lakes.

To answer the third question, water quality data from the lake's sample locations are compared.

A fourth and final question will be answered in subsequent projects to develop a lake management plan:

4. Can the lake's water quality be protected from degradation by controlling future development and/or implementation of management practices to reduce current phosphorus loads to the lake?

Estimated hydrologic and phosphorus budgets were prepared in the current project for use in a subsequent management plan development project. Budget results are discussed.

A background information section is also included in the report. Section 2.0 covers general concepts in lake water quality.

2.0 General Concepts in Lake Water Quality

There are many concepts and terminology that are necessary to describe and evaluate a lake's water quality. This section is a brief discussion of those concepts, divided into the following topics:

- Eutrophication
- Trophic states
- Limiting nutrients
- Nutrient recycling and internal loading
- Stratification
- Lake Zones
- Riparian Zone
- Watershed

To learn more about these five topics, one can refer to any text on limnology (the science of lakes and streams).

2.1 Eutrophication

Eutrophication, or lake degradation, is the accumulation of sediments and nutrients in lakes. As a lake naturally becomes more fertile, algae and weed growth increases. The increasing biological production and sediment inflow from the lake's watershed eventually fill the lake's basin. Over a period of many years, the lake successively becomes a pond, a marsh and, ultimately, a terrestrial site. This process of eutrophication is natural and results from the normal environmental forces that influence a lake. Cultural eutrophication, however, is an acceleration of the natural process caused by human activities. Nutrient and sediment inputs (i.e., loadings) from wastewater treatment plants, septic tanks, and stormwater runoff can far exceed the natural inputs to the lake. The accelerated rate of water quality degradation caused by these pollutants results in unpleasant consequences. These include profuse and unsightly growths of algae (algal blooms) and/or the proliferation of rooted aquatic weeds (macrophytes).

2.2 Trophic States

Not all lakes are at the same stage of eutrophication; therefore, criteria have been established to evaluate the nutrient "status" of lakes. Trophic state indices (TSIs) are calculated for lakes on the basis of total phosphorus, chlorophyll *a* concentrations, and Secchi disc transparencies. A TSI value is obtained from any one of these three parameters. TSI values range upward from zero, describing the condition of the lake in terms of its trophic status (i.e., its degree of fertility). Four trophic status designations for lakes are listed below with corresponding TSI value ranges:

1. *Oligotrophic* – [TSI ≤ 37] Clear, low productivity lakes with total phosphorus concentrations less than or equal to 10 µg/L.
2. *Mesotrophic* – [38 ≤ TSI ≤ 50] Intermediate productivity lakes with total phosphorus concentrations greater than 10 µg/L, but less than 25 µg/L.
3. *Eutrophic* – [51 ≤ TSI ≤ 63] High productivity lakes generally having 25 to 57 µg/L total phosphorus.
4. *Hypereutrophic* – [64 ≤ TSI] Extremely productive lakes that are highly eutrophic, disturbed and unstable (i.e., fluctuating in their water quality on a daily and seasonal scale, producing gases, off-flavor, and toxic substances, experiencing periodic anoxia and fish kills, etc.) with total phosphorus concentrations above 57 µg/L.

Determining the trophic status of a lake is an important step in diagnosing water quality problems. Trophic status indicates the severity of a lake's algal growth problems and the degree of change needed to meet its recreational goals. Additional information, however, is needed to determine the cause of algal growth and a means of reducing it.

2.3 Limiting Nutrients

The quantity or biomass of algae in a lake is usually limited by the water's concentration of an essential element or nutrient—the "limiting nutrient." (For rooted aquatic plants, most nutrients are derived from the sediments.) The limiting nutrient concept is a widely applied principle in ecology and in the study of eutrophication. It is based on the idea that plants require many nutrients to grow, but the nutrient with the lowest availability, relative to the amount needed by

the plant, will limit plant growth. It follows then, that identifying the limiting nutrient will point the way to controlling algal growth.

Nitrogen (N) and phosphorus (P) are generally the two growth-limiting nutrients for algae in most natural waters. Analysis of the nutrient content of lake water and algae provides ratios of N:P. By comparing the ratio in water to the ratio in the algae, one can estimate whether a particular nutrient may be limiting. Algal growth is generally phosphorus-limited in waters with N:P ratios greater than 12. Laboratory experiments (bioassays) can demonstrate which nutrient is limiting by growing the algae in lake water with various concentrations of nutrients added. Bioassays, as well as fertilization of in-situ enclosures and whole-lake experiments, have repeatedly demonstrated that phosphorus is usually the nutrient that limits algal growth in fresh waters. Reducing phosphorus in a lake, therefore, is required to reduce algal abundance and improve water transparency. Failure to reduce phosphorus concentrations will allow the process of eutrophication to continue at an accelerated rate.

2.4 Nutrient Recycling and Internal Loading

Phosphorus enters a lake from either runoff from the watershed or direct atmospheric deposition. It would, therefore, seem reasonable that phosphorus in a lake can decrease by reducing these external loads of phosphorus to the lake. All lakes, however, accumulate phosphorus (and other nutrients) in the sediments from the settling of particles and dead organisms. In some lakes this reservoir of phosphorus can be reintroduced in the lake water and become available again for plant uptake. This release of nutrients from the sediments to the lake water is known as "internal loading." The relative amounts of phosphorus coming from internal and external loads vary with each lake. Phosphorus released from internal loading can be estimated from depth profiles (measurements from surface to bottom) of dissolved oxygen and phosphorus concentrations.

2.5 Stratification

The process of internal loading is dependent on the amount of organic material in the sediments and the depth-temperature pattern, or "thermal stratification," of a lake. Thermal stratification profoundly influences a lake's chemistry and biology. When the ice melts and air temperature warms in spring, lakes generally progress from being completely mixed to stratified with only an upper warm well-mixed layer of water (epilimnion), and cold temperatures in a bottom layer (hypolimnion). Because of the density differences between the lighter warm water and the heavier cold water, stratification in a lake can become very resistant to mixing. When this occurs,

generally in midsummer, oxygen from the air cannot reach the bottom lake water and, if the lake sediments have sufficient organic matter, biological activity can deplete the remaining oxygen in the hypolimnion. The epilimnion can remain well-oxygenated, while the water above the sediments in the hypolimnion becomes completely devoid of dissolved oxygen (anoxic). Complete loss of oxygen changes the chemical conditions in the water and allows phosphorus that had remained bound to the sediments to reenter the lake water.

As the summer progresses, phosphorus concentrations in the hypolimnion can continue to rise until oxygen is again introduced. Dissolved oxygen concentration will increase if the lake sufficiently mixes to disrupt the thermal stratification. Phosphorus in the hypolimnion is generally not available for plant uptake because there is not sufficient light penetration into the hypolimnion to allow for growth of algae. The phosphorus, therefore, remains trapped and unavailable to the plants until the lake is completely mixed. In shallow lakes mixing can occur frequently throughout the summer, with sufficient wind energy (polymixis). In deeper lakes, however, only extremely high wind energy is sufficient to destratify a lake during the summer and complete mixing only occurs in the spring and fall (dimixis). Cooling air temperature in the fall reduces the epilimnion water temperature, and consequently increases the density of water in the epilimnion. As the epilimnion water density approaches the density of the hypolimnion water very little energy is needed to cause complete mixing of the lake. When this fall mixing occurs, phosphorus that has built up in the hypolimnion is mixed with the epilimnetic water and some of it becomes available for plant growth, while the remainder combines with iron in the water to form an amorphous ferric-hydroxy-phosphate complex that reprecipitates to the lake's sediment.

2.6 Lake Zones

Lakes are not homogenous, but are rather comprised of several different habitats for aquatic life. Each type of habitat or lake zone impacts the overall health of the lake. Lake zones (See Figure 2) include:

- **Littoral Zone**—The shallow transition zone between dry land and the open water area of the lake is the littoral zone. The shallow water, abundant light, and nutrient-rich sediment provide ideal conditions for plant growth. Aquatic plants, in turn, provide food and habitat for many animals such as fish, frogs, birds, muskrats, turtles, insects, and snails. Lakes with clearer water may have aquatic plants growing at greater depths than lakes with poor water clarity. As a result, the littoral zone may vary depending on the lake's water clarity as well as its depths.

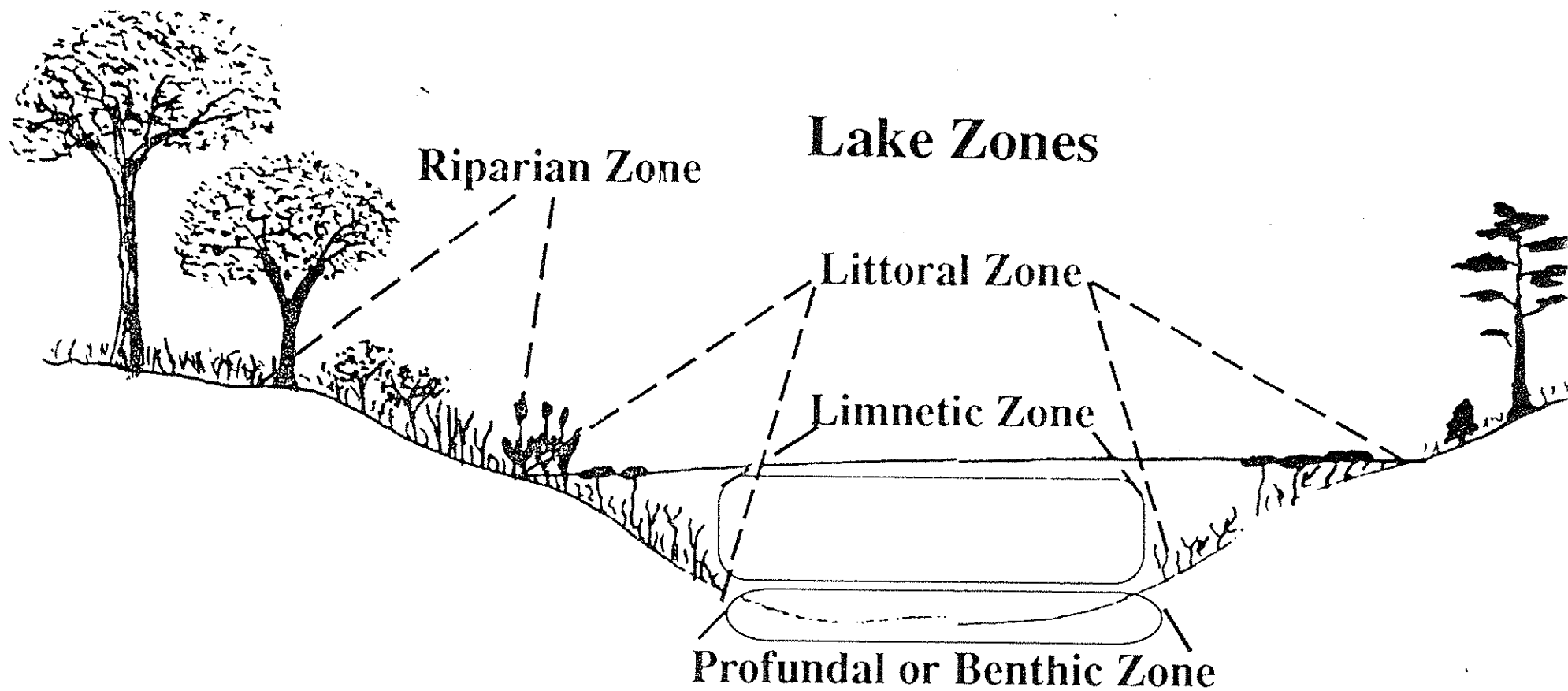

FIGURE 2

- **Profundal Zone**—the bottom zone in the deeper areas of the lake (i.e., in water deeper than the littoral zone). Deposition and decomposition of organic material occurs in this zone. This area often lacks oxygen because decomposition uses up available oxygen. A related term is benthic zone.
- **Limnetic Zone**—the open water area of the lake in water deeper than the littoral zone. It is located from the lake's surface to the depth at which the profundal zone begins. This zone is inhabited by phytoplankton, zooplankton, and/or fish. The microscopic algae or phytoplankton provide the foundation of the food pyramid of the lake. The zooplankton (i.e., small animals) feed upon the phytoplankton and provide a food source for higher life forms such as fish.

Each of the lake zones is important for lake health. None can be neglected or negatively impacted without influencing the entire lake ecosystem.

2.7 Riparian Zone

Riparian zones (see Figure 3) are extremely important to the lake and to the plants living there. Riparian vegetation is that growing close to the lake and may be different from the terrestrial or upland vegetation. The width of the riparian zone varies depending on many variables, including soils, vegetation, slopes, soil moisture, water table, and even by location on the lake. For example, north shore vegetation may provide little or no shade, while vegetation on the southern shore may offer shade and cover well into the lake.

The riparian area and riparian vegetation is important for several reasons:

- Acts as a filter from outside impacts.
- Stabilizes the bank with an extensive root system.
- Helps control or filter erosion
- Provides screening to protect visual quality and hides man's activities and buildings.
- Provides the natural visual backdrop as seen from the lake.
- Provides organic material to the lake's food web. Leaves, needles, and woody debris are fed upon by bacteria, fungi, and aquatic insects. This energy flows upward through the food web.
- Offers cover and shade for fish and other aquatic life.
- Provides valuable wildlife habitat

Riparian Zone

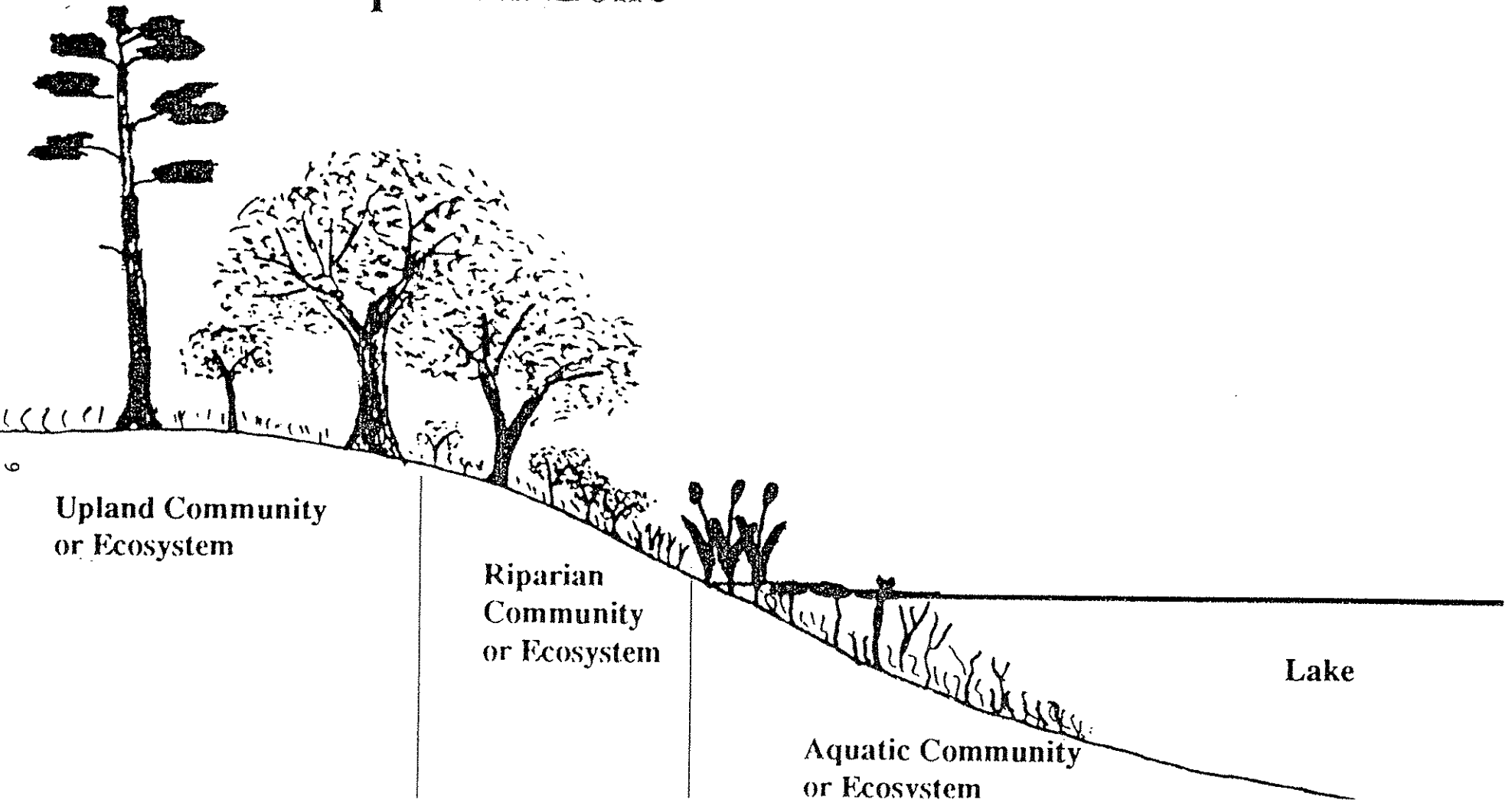

FIGURE 3

Riparian zones are the areas most often impacted, and riparian vegetation is lost when man enters the picture. Cabins, homes, lawns, boat houses, or other structures may replace native riparian vegetation. Additional riparian vegetation may be eliminated to provide a wider vista from the front deck, or it may be mowed and its value to the lake may be lost.

The loss of riparian vegetation may result in the deterioration of many lake values. Water quality may be impacted, wildlife habitat may be lost, scenic quality may suffer, fish habitat may be impacted, bank stability may be weakened, and the potential for erosion may increase. Riparian vegetation filters phosphorus from runoff waters, thereby protecting the lake's water quality. The loss of riparian vegetation may result in increased phosphorus loads to the lake, which may cause water quality degradation.

2.8 Watershed

The land area that drains to the lake is called a watershed (See Figure 4). The watershed may be small, as is the case of small seepage lakes. Seepage lakes have no stream inlet or outlet and, consequently, their watersheds include the land draining directly to the lake. A lake's watershed may be large, as in drainage lakes such as Lac Courte Oreilles. Drainage lakes have both stream inlets and outlets and, consequently, their watersheds include the land draining to the streams in addition to the land draining directly to the lake. Water draining to a lake may carry pollutants that affect the lake's water quality. Consequently, water quality conditions of the lake are a direct result of the land use practices within the entire watershed. Poor water quality may reflect poor land use practices or pollution problems within the watershed. Good water quality conditions suggest that proper land uses are occurring in the watershed.

All land use practices within a lake's watershed impact the lake and determine its water quality. Impacts result from the export of sediment and nutrients, primarily phosphorus, to a lake from its watershed. Each land use contributes a different quantity of phosphorus to the lake, thereby, affecting the lake's water quality differently. An understanding of a lake's water quality, therefore, must go beyond an analysis of the lake itself. An understanding of a lake's watershed, phosphorus exported from the watershed, and the relationship between the lake's water quality and its watershed must be understood.

Watershed Map of a Lake

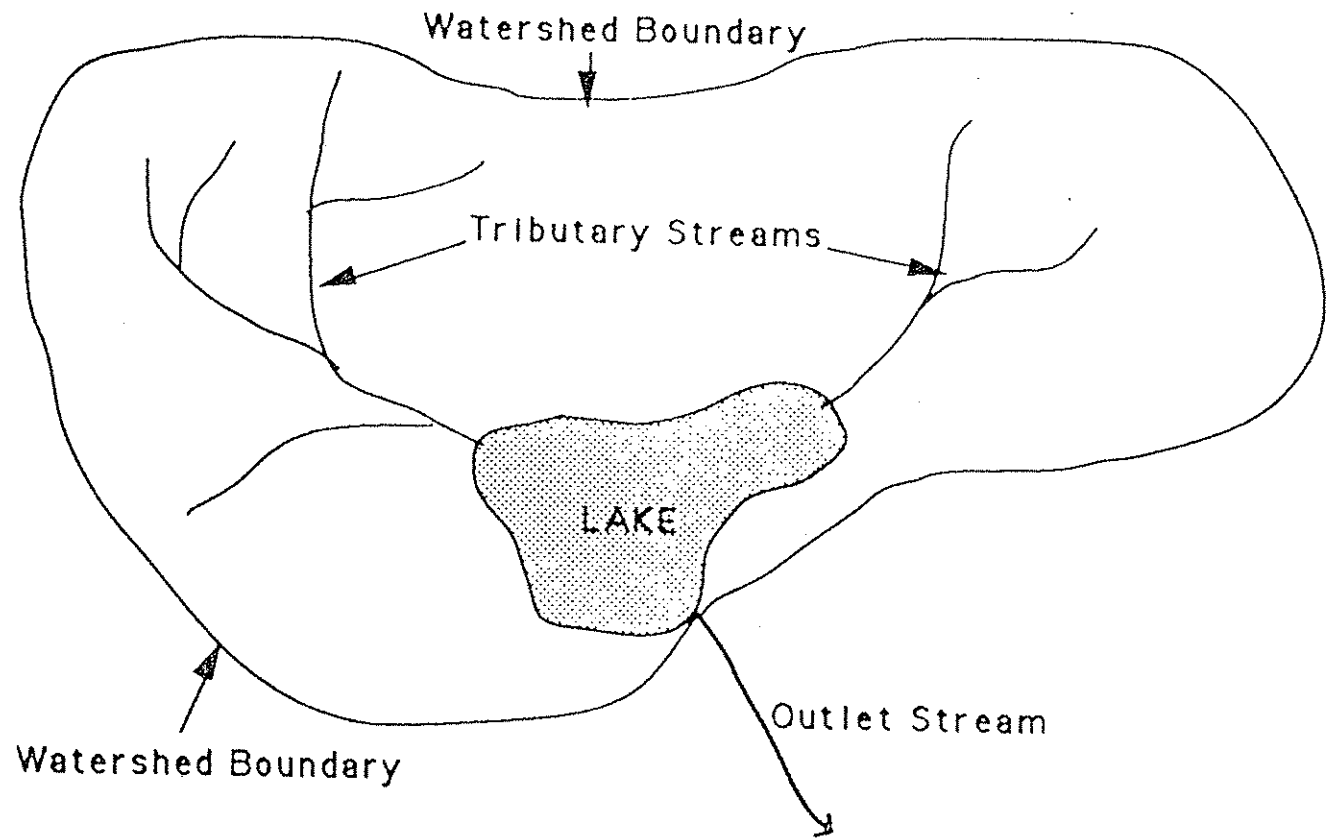

11

FIGURE 4

3.0 Basin Characteristics

Lac Courte Oreilles in Sawyer County Wisconsin covers an area of approximately 5,040 acres and has a volume of approximately 161,000 acre-feet. It has a maximum depth of 92 feet and a mean depth of 34 feet. The lake consists of three basins (Figure 5). However, because the basins are not separated from one another, the lake is perceived as consisting of a single basin. The east basin is the deepest, with a maximum depth of 92 feet. The central and west basins have maximum depths of 63 feet and 67 feet, respectively. The lake notes five bay areas (See Figure 5), ranging in depth from 18 feet to 29 feet (See Table 2). Approximately 68 percent of the lake is more than 20 feet deep, and less than 3 percent of the lake is less than 3 feet deep. Its shoreline spans about 25 miles. The lake is a soft-water drainage lake flowing into Little Courte Oreilles Lake on the Couderay River. The lake notes an excellent fishery, which includes muskellunge, northern pike, walleye, bass, panfish, and cisco. Riparian owners, the Lac Courte Oreilles Band of Lake Superior Chippewa Indians (LCO), and the public, via the public access, use the lake for all types of recreational activities.

Table 2 Morphologic Characteristics of Lac Courte Oreilles Basins and Bays

Basin/Bay	Surface Area (acres)	Maximum Depth (feet)	Mean Depth (feet)	Volume (acre-feet)
A—East Basin	1,645	92	44	72,882
B—West Basin	2,050	67	30	33,640
C—Central Basin	1,561	63	41	48,045
D—Musky Bay	255	18	6	1,582
E—Stukey Bay	93	26	14	1,323
F—Chicago Bay	144	20	11	1,636
G—Grindstone Bay	66	29	14	904
H—Northeast Bay	62	27	15	903

4.1 Lake Water Quality Data Collection

In 1996, a representative lake sampling station was selected for each of the three basins and five bay areas (Figure 5). Samples were collected from each station approximately monthly from May through September. Logistical problems during July, however, prevented the analysis of July samples. Field parameters were measured approximately biweekly and Secchi disc transparency was measured approximately weekly during May through November. Secchi disc measurements within Basin D included measurements from a near shore area monthly during June through September in addition to the approximately weekly measurements from the Basin D deep hole sample location. Near shore and deep hole sampling locations are shown in Figure 5. The additional measurements were completed because mats of floating algae were found in near shore areas and were not found at the Basin D deep hole sample location. Therefore, water transparency measurements from the Basin D central sample location failed to indicate the impacts of floating algal mats on the water transparency of the near shore areas. Table 3 lists the thirteen water quality parameters measured at each station, and specifies how frequently and at what depths samples or measurements were collected. Dissolved oxygen, temperature, specific conductance, total dissolved solids, pH, and Secchi disc transparency were measured in the field; whereas, water samples were analyzed in the laboratory for total phosphorus, soluble reactive phosphorus, total Kjeldahl nitrogen, ammonia nitrogen, nitrate plus nitrite nitrogen, chlorophyll *a*, and alkalinity. The Wisconsin Department of Natural Resources (WDNR) collected samples from Basin A. Samples and measurements from Basins B through H were collected by the Lac Courte Oreilles Conservation Department. All samples were analyzed by the Wisconsin State Laboratory of Hygiene.

4.2 Periphyton Methods

During the May through October period, periphyton samples were collected from 11 lake inflow locations (See Figure 6). The periphyton samples were collected to determine periphyton growth rates and to estimate lake soluble reactive phosphorus concentrations at inflow locations.

Periphytometers (i.e., periphyton samplers shown on Figure 7) were installed within Lac Courte Oreilles next to inflow locations during May and June (i.e., Stations P-1 and P-3 during June and all other locations during May). Vandalism resulted in the removal of samplers at Stations P-7 and P-8 shortly after installation. Samplers were reinstalled at these locations during August.

Lac Courte Oreilles Lake Sample Locations

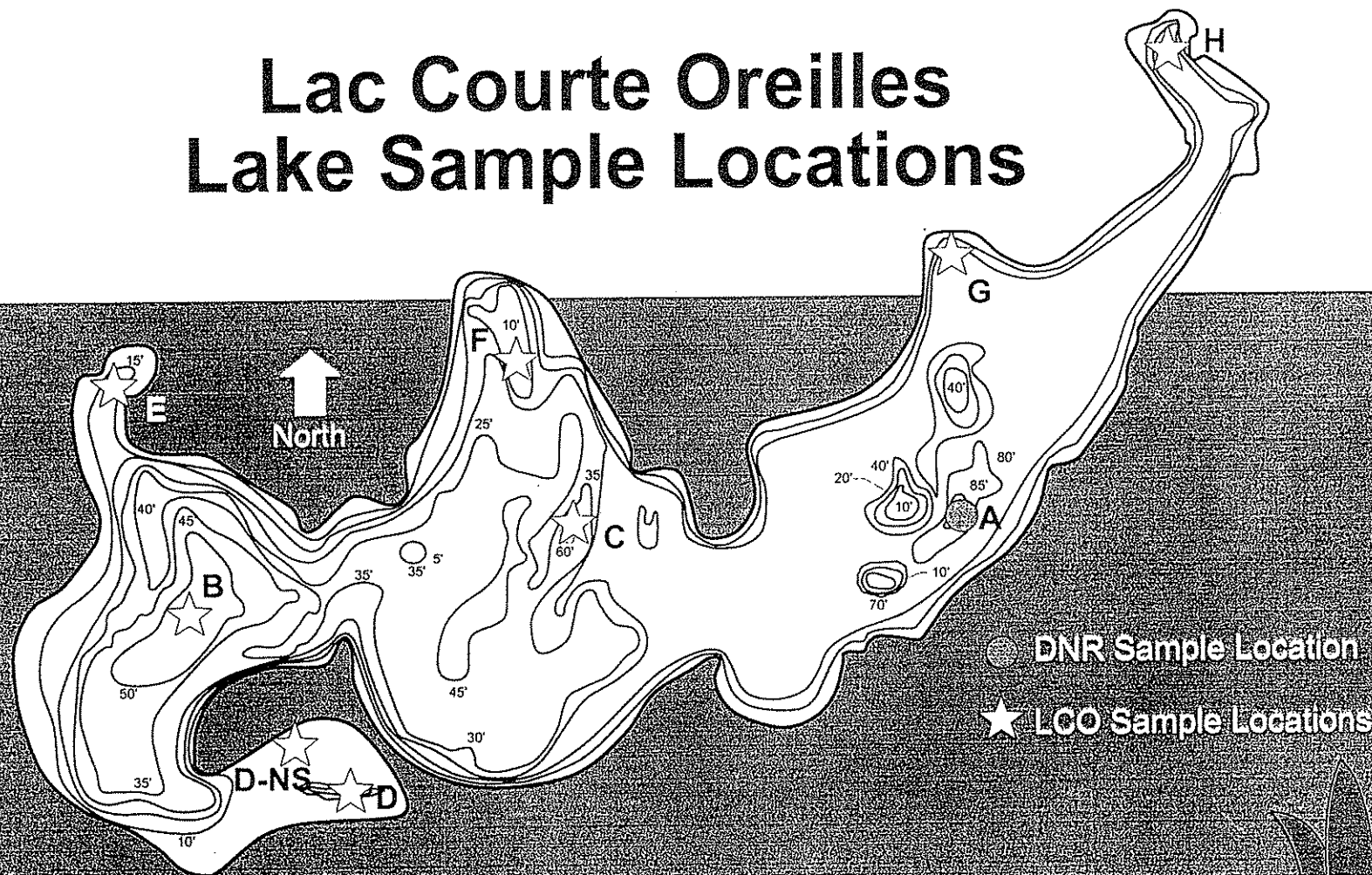

Figure 5

Table 3 Lac Courte Oreilles Water Quality Parameters

Parameters	Depth (meters)	Sample Frequency			
		Approximately Weekly	Approximately Biweekly	Approximately Monthly	Quarterly
Dissolved Oxygen	Surface to bottom profile		X		
Temperature	Surface to bottom profile		X		
Specific Conductance	Surface to bottom profile		X		
Total Dissolved Solids	Surface to bottom profile		X		
pH	Surface to bottom profile		X		
Chlorophyll <i>a</i>	0-2			X	
Secchi Disc	—	X			
Total Phosphorus	0-2			X	
Soluble Reactive Phosphorus	0-2			X	
Total Kjeldahl, Ammonia, and Nitrate + Nitrite Nitrogen	0-2			X	
Alkalinity	0-2				X

Lac Courte Oreilles Periphyton Sample Locations

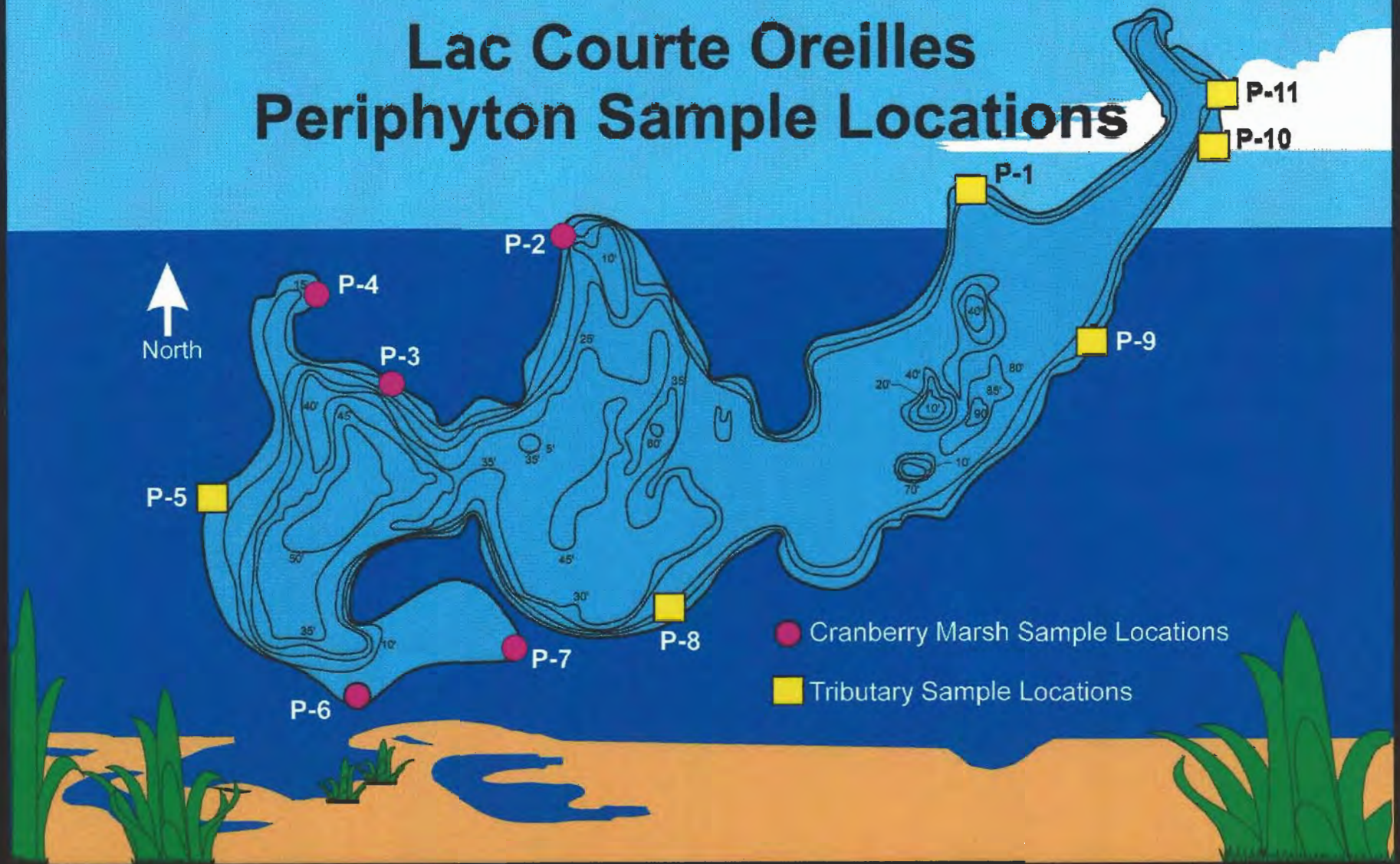
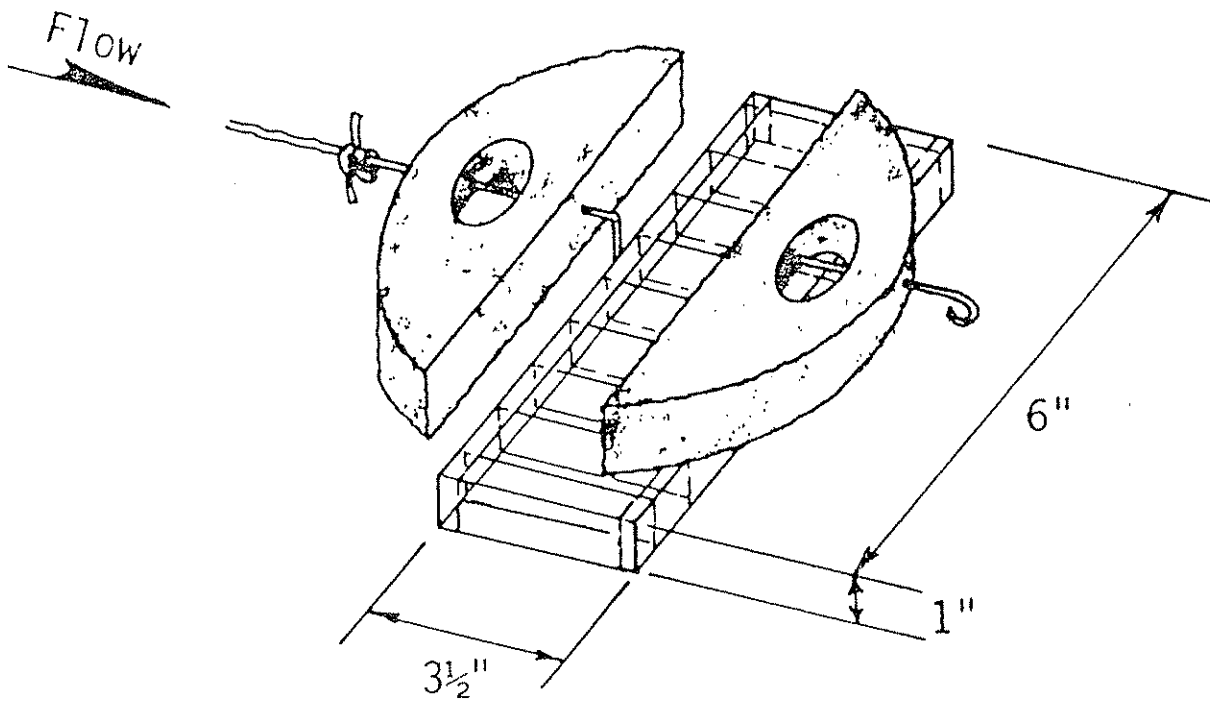

Figure 6

Periphyton Sampler



Periphytometer II Sampler
Depth of Slides 1" Below Water Surface

FIGURE 7

Each sampler contained eight slides used as substrates for periphyton colonization. Each week, two colonized slides from each sampler were removed. Consequently, eight new slides were installed in each sampler every four weeks for colonization. Colonized periphyton slides were removed in the field and placed into a petri dish. Samples were kept on ice until processed (i.e., the same day as collection). Sample processing consisted of cell removal, concentration of cells onto a filter, and analyses of cells (i.e., chlorophyll *a*). A razor blade was used to remove the cells from microscope slides. The contents from the pair of slides collected from each location were then concentrated by filtering onto a Whatman GF/C glass fiber filter. Filters containing periphyton samples were folded with the sample toward the inside, wrapped in aluminum foil, and placed on ice. All samples were analyzed for chlorophyll *a*. Samples collected during May were analyzed by the Wisconsin State Laboratory of Hygiene. All other samples were analyzed by the LCO college. Chlorophyll *a* was determined as follows:

$$\text{Chl } a \text{ } (\mu\text{g}) = \frac{(26.7(664_{\text{BA}} - 665_{\text{AA}}) V_1)}{L}$$

Where:

664_{BA} = Before Acid Absorbency at 664 NM – Before Acid Absorbency at 750 NM

665_{AA} = After Acid Absorbency at 665 NM – After Acid Absorbency at 750 NM

V_1 = Volume of Extract in L

L = Light Path Length (cm)

Chlorophyll *a* on an aerial basis was determined by:

$$\text{Chl } a \text{ } (\mu\text{g}/\text{m}^2) = \text{Chl } a / \text{Area of Slides}$$

Periphyton growth rates were determined for each periphyton sample as follows:

$$\text{Growth Rate } \left(\frac{1}{\text{day}}\right) = \frac{\ln x_2 - \ln x_1}{T_2 - T_1}$$

Where:

X_2 = periphyton biomass (i.e., chlorophyll *a* in $\mu\text{g}/\text{m}^2$) at the end of the time interval

X_1 = periphyton biomass (i.e., chlorophyll *a* in $\mu\text{g}/\text{m}^2$) at the beginning of the time interval

$T_2 - T_1$ = growth period in days

Growth rates were then corrected for photoperiod and water temperature, two variables causing spatial and temporal differences in growth rates. The corrections were necessary to estimate the lake soluble reactive phosphorus concentrations during growth periods. Growth rates were corrected for photoperiod by:

$$\mu' = \frac{\mu}{PP}$$

Where:

μ' = Growth Rate Corrected for Photoperiod
 μ = Growth Rate
 PP = Photoperiod (days)

Where:

$$PP = 0.36 \text{ day} + (\cos \Theta) 0.28 \text{ day}$$

Where:

$$\Theta = \frac{JD - 172}{365} * 2\pi$$

Where:

JD = Julian Day #

Growth rates corrected for photoperiod were then corrected for water temperature as follows:

$$\mu'' = \frac{\mu'}{WTCF}$$

Where:

μ'' = Growth rate corrected for photoperiod and water temperature
 μ' = Growth rate corrected for photoperiod
 WTCF = Water Temperature Correction Factor and

$$WTCF = \frac{\text{Water Temperature During The Four Week Growth Period}}{\text{Maximum Lake Water Temperature During The May Through October Sample Period}}$$

On a per station basis, the maximum growth rate for each four-week sampling period was then determined from the corrected growth rates (i.e., corrected for both photoperiod and water temperature). The soluble reactive phosphorus concentration associated with each monthly maximum growth rate was then estimated as follows:

$$\mu'' = \mu_{\max} \frac{P}{P + K_p}$$

Where:

μ'' = Specific growth rate at limiting nutrient concentration P (i.e., the maximum monthly growth rate corrected for photoperiod and water temperature)

$$\mu_{\max} = 0.851 * (1.066)^t$$

and is the growth rate at saturating concentration of nutrient or the maximum expected growth rate.

t = the maximum lake water temperature during the May through October sample period.

K_p = a constant analogous to the Michaelis-Menton constant of enzyme kinetics, being numerically equal to the substrate concentration supporting a growth rate equal to $1/2 \mu_{\max}$. Values range from 1-10 $\mu\text{g/L}$ and a value of 7 $\mu\text{g/L}$ was used for Lac Courte Oreilles.

P = the estimated soluble reactive phosphorus concentration.

4.3 Inflow/Outflow Monitoring Methods

Grab samples were collected from surface water inflow locations and from the lake's outflow approximately monthly during May through November. In addition grab samples were collected from inflow locations during storms, one spring, four summer, and one fall storm. Samples were analyzed for total phosphorus. However, due to a laboratory accident, samples from two summer storms were not analyzed. Discharge was also measured during each sample event. Staff gages at I-5, I-9, I-10 (See Figure 8), and the outflow (See Figure 9) were generally read on a daily basis. A stage discharge rating curve was developed for I-5 and the outflow to predict discharge on approximately a daily basis.

4.4 Evaluation of the Tributary Watershed

The Lac Courte Oreilles watershed was divided into subwatersheds that include the tributary watershed lakes and wetlands, as well as the remaining areas draining directly to each of the lake basins/bays (see Figure 1). Table 4 shows the watershed areas for each of the 22 subwatersheds.

The Sawyer County Land Conservation Department completed an evaluation of watershed land use within each section of the Lac Courte Oreilles tributary watershed. The evaluation consisted of a determination of watershed land use within each subwatershed. Specifically, acres of cropland, forest land, Conservation Reserve Program (CRP) land, and residential land uses were determined.

Lac Courte Oreilles Inflow Locations



I-5

I-6

I-4

I-3

I-2

I-7

I-8

I-12

I-1

I-9

I-13

I-11

I-10

- Monitored Sites
- ★ Not Monitored, Phosphorus Load Estimated by Modeling
- Cranberry Marsh, P Load Estimated

Figure 8

Lac Courte Oreilles Outflow Monitoring Location

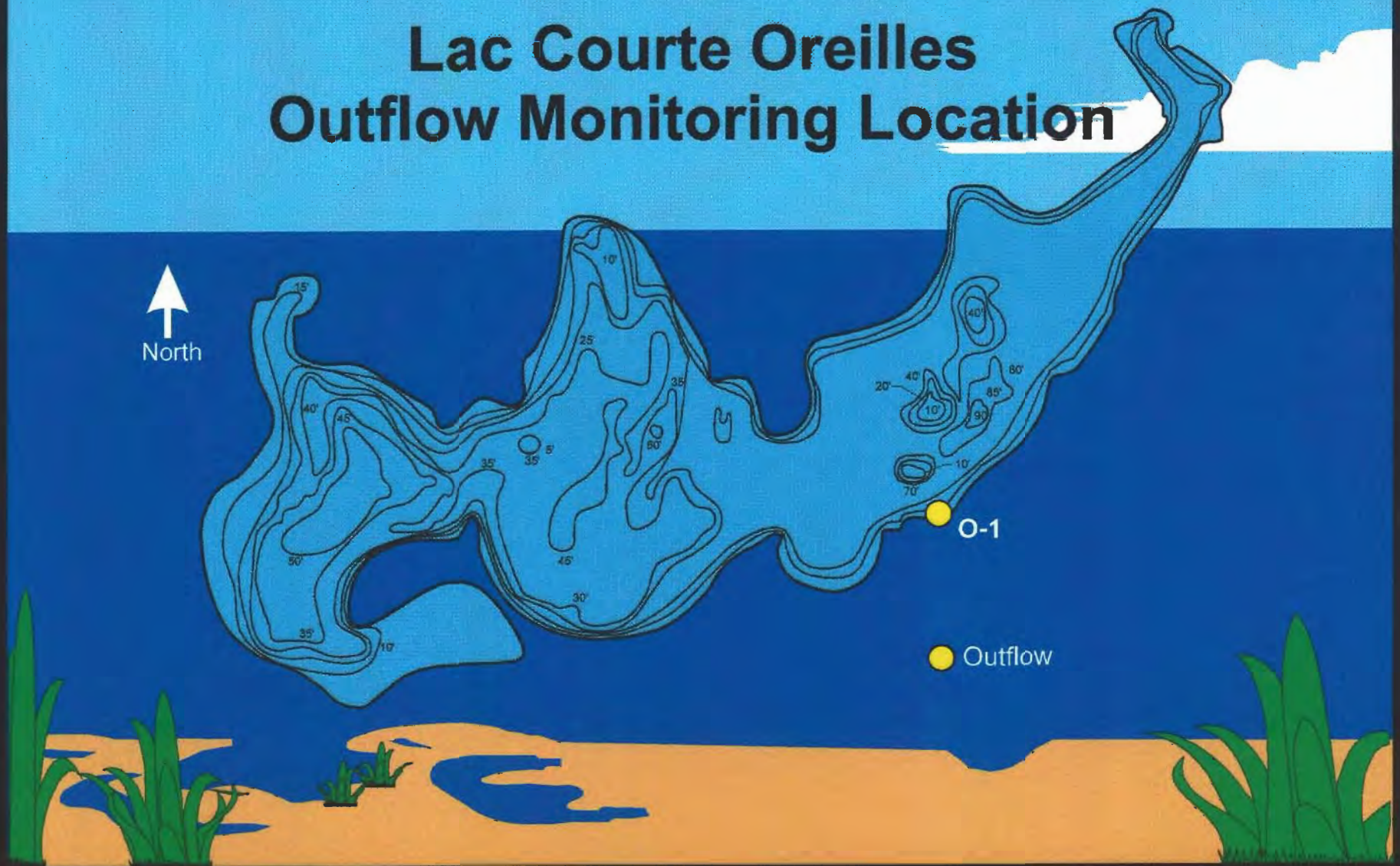

Figure 9

Table 4 Lac Courte Oreilles Subwatershed Areas

	Watershed Area (acres)
A	2,768
B	1,672
C	2,034
D	1,127
E	416
F	560
G	283
H	367
I-1	15,495
I-10	228
I-11	6,743
I-13	6.3
I-2	510
I-3	378
I-5	213
I-6	474
I-7	84.5
I-8	2,330
I-9	1,152
Sand Lake	18,006
Spring	3,543
Squaw Lake	11,709
Total Watershed Area	70,101

4.5 Hydrologic Budget Calculations

Rain gages accurate to within 1/100th-of-an-inch were installed at eight locations within Lac Courte Oreilles' watershed and read daily by volunteers during the ice free period, to determine daily precipitation amounts. Measurements were made between May and September 1996. Data from the Hayward Ranger Station and Couderay were included, and the measurements from all of the gages were used to determine the average precipitation over the watershed. The data from Hayward and Couderay were also used during the winter months to determine total precipitation amounts for the unmonitored periods.

Evaporation from the lake water surface area and surface runoff from the lake's watershed, during the study period, were estimated using the Meyer Watershed Model (Molsather et al., 1977), which incorporates methods developed by Adolph Meyer (1947). This method uses average monthly temperature, wind speed, and relative humidity to predict monthly evaporation from water surfaces. Monthly wind speeds, and humidity used for input in the Meyer Watershed Model were taken from 1995-1996 data from the Minneapolis/St. Paul International Airport National Weather Service station. Average monthly and daily temperature readings from Couderay were also used to estimate evaporation and average daily and total monthly precipitation from the study area were used as input for predicting surface runoff in the model.

Two staff gages were installed and read approximately on a daily basis during the period May 16 through September 30. The staff gage readings and flow measurements, taken at the lake outlet, were used to develop an outlet rating curve for the lake. The outlet rating curve is a statistical relationship that enables prediction of the flow from the lake outlet, based on the observed lake levels. The staff gage readings and outlet rating curve were used to determine daily lake volume changes and average lake outflow volumes.

A hydrologic (water) budget for Lac Courte Oreilles based on the 1995-96 water year (October 1, 1995 through September 30, 1996), was calculated by measuring or estimating the important components of the budget. The important components of the budget include:

- Precipitation
- Surface Runoff
- Lake Outflow
- Evaporation
- Groundwater Flow
- Change in Lake Storage

The net groundwater flow (inflow minus outflow) was estimated from the calibration simulation performed with the WATBUD model. The WATBUD model, developed by the Minnesota Department of Natural Resources, allows for the automatic adjustment of coefficients that will provide the best fit between the observed and simulated lake levels. Net groundwater flow (seepage) for the monitored period was determined by allowing the WATBUD model to solve the water balance equation as presented below:

$$GW = OF + EVAP - P - RO +/-S$$

Where:

- GW = Net Groundwater Flow (Groundwater Inflow minus Groundwater Outflow)
- OF = Lake Outflow
- EVAP = Evaporation from the Lake's Surface
- P = Direct Precipitation on the Lake's Surface
- RO = Watershed Runoff
- S = Change in Lake Storage

The period between May and September 1996 was used for the calibration simulation since precipitation, change in storage and the remaining parameters were either known or could be estimated using generally accepted methods.

The annual yield of surface water runoff from the Lac Courte Oreilles watershed was determined by dividing the predicted watershed runoff (i.e., that predicted by Meyer watershed model and measured at major tributaries) volumes by the watershed area to compute an annual areal yield value expressed in inches of water. The runoff yield was divided by the total precipitation for the monitored period. The resultant number represents the estimated runoff coefficient for the watershed.

4.6 Phosphorus Budget and Lake Water Quality Mass Balance Model

Numerous researchers have demonstrated the relationship between phosphorus loads, water loads and lake basin characteristics to the observed in-lake total phosphorus concentration. This relationship was used to verify the annual phosphorus load into Lac Courte Oreilles based on average surface water phosphorus concentrations, the lake's hydrologic budget, and lake basin characteristics. The relationship has many forms. The equation used for Lac Courte Oreilles was

adapted from one developed by Dillon and Rigler (1974), modified by Nurnberg (1984) and has the form of:

$$P = \frac{L_A (1 - R_p)}{Q_s} + \frac{L_I}{Q_s}$$

Where:

- P = is the mean phosphorus concentration
- L_A = amount of phosphorus added per unit surface area of lake from all sources except from the internal load of the lake
- R_p = the coefficient that describes the total amount of phosphorus retained by the sediments each year [15/(18+Q_s)]
- Q_S = the outflow of the lake divided by its surface area
- L_I = mass of phosphorus per unit surface area of lake added to the lake from internal loading

For Lac Courte Oreilles all variables of the equation were measured or were estimated based on data collected during the study. This equation was added to the Wisconsin Lake Model Spreadsheet (WILMS) (Panuska and Wilson, 1994).

The overall Lac Courte Oreilles phosphorus budget was determined using the tributary water quality data and corresponding watershed runoff volumes to calculate phosphorus export for each of the monitored subwatershed areas. These data were combined with the assumed export rates for each of the phosphorus input sources (or land uses) within the direct subwatersheds to estimate the total loads to each of the lake's basins. The phosphorus budget for Lac Courte Oreilles was determined by measuring or estimating the important components of the budget. The important components of the budget include:

- Watershed Surface Runoff from Forested, Cropland, Residential, Wetlands, and Cranberry Bog Land Uses
- Internal Loading
- Waterfowl Loading
- Atmospheric Wet and Dry Deposition on the Lake Surface
- Septic System Loading
- Monitored Tributaries

The watershed surface runoff components of the phosphorus budget were estimated using an assumed annual phosphorus export coefficient for each land use type within the direct subwatersheds. An annual phosphorus export coefficient of 0.09 lbs/ac/yr was used for the forested portions of the subwatersheds. This value corresponds with the most likely default coefficient in the WILMS model (Panuska and Lilly, 1995 and Corsi et. al., 1997), and that observed by Singer and Rust (1974). The total phosphorus export coefficient of 1.16 lbs/ac/yr observed by Hensler et al. (1970) was used for the row cropland land use. The non-row cropland export coefficient of 0.58 lbs/ac/yr, used in this analysis, agrees well with that observed by others (Burwell et al., 1975; Converse et al., 1976). For this analysis, agricultural land uses were assumed to be in row cropland for two years, followed by five years of non-row cropland (Sawyer County Land and Water Conservation Department, 1996). The residential phosphorus export coefficient of 0.52 lbs/ac/yr corresponds with other published data (Landon, 1977; Bannerman et al., 1983). An annual phosphorus export coefficient of 0.09 lbs/ac/yr was used for the wetland landuses within each subwatershed. This agrees with the most likely default coefficient in the WILMS model (Panuska and Lilly, 1995 and Corsi et. al., 1997). An annual phosphorus export coefficient of 0.62 lbs/ac/yr was used for the cranberry bogs within each subwatershed. This value corresponds with data collected from the Manitowish Waters cranberry area (Konrad and Bryans, 1974) and Thunder Lake (Dunst et al., 1982). Dunst et al. (1982) reported an overall average total phosphorus export of 0.62 lbs/ac., based upon measurements taken only during the discharge of the fall harvest and spring flooding events. Phosphorus loads from individual floods used to prevent freezing were not included in the annual averages. Dunst et al. (1982) further states that the calculated discharge probably is a reasonable minimum value given the variability in marsh management.

Two exceptions to the aforementioned export coefficients were made to calibrate the lake water quality models for Basins D and E. An annual phosphorus export coefficient of 2.04 lbs/ac/yr was used for the cranberry bog land use within Basin D subwatershed. This export rate was determined to be within the range of total phosphorus loadings using the 0.10-0.15 mg/L concentrations observed in cranberry drainage water by Field (1987) and the average annual water use of 6 acre-feet per acre of cranberry bog cited by the St. Paul District of the U.S. Army Corps of Engineers (1995) and by Hamilton (1971). This results in a range of annual phosphorus export coefficients of 1.63 to 2.44 lbs./ac/yr. This export coefficient can be further justified by the aerial fertilizer application employed by the nearby bogs which is not employed in any other areas of the lake. The results of an aerial spray study support the use of a higher phosphorus export rate coefficient. Riekerk (1989) showed that aerial applications of herbicides resulted in a surface runoff concentration roughly 3.5 times greater than applications to the ground. Riekerk attributed the higher concentrations to direct application to the receiving water and/or application to non-

target areas that resulted in increased loading to the receiving water. Therefore, he believed the study results are applicable to the aerial applications of fertilizer (Riekerk, 1997). Basin D residents have observed aerial spray application of fertilizer to riparian cranberry farms, including application to non-target areas (Mason, Personal Communication, 1997). The export rate coefficient used for Basin D (i.e., 2.04 lbs./ac./yr.) is approximately 3.2 times higher than the export coefficients used for other Lac Courte Oreilles cranberry farms using a ground application of fertilizer (i.e., 0.62 lbs./ac./yr.) and is in the middle of the range of export coefficients determined from the range of observed concentrations in cranberry drainage water..

The second exception occurred when an annual phosphorus export coefficient of 0.27 lbs/ac/yr was used for the agricultural land use area within the Basin E subwatershed since all of the fields were at least 700 feet from the lakeshore and are buffered by the forested land use, which is adjacent to the western edge of this basin. The lower export coefficient assumes that sediment-bound phosphorus in the agricultural runoff is removed by the forested buffer.

Internal loading (L_i in the above equation) was estimated for each of the lake basins using the total phosphorus data from the lake's water column. The summer internal load for each basin is calculated by multiplying the percentage of hypolimnetic phosphorus released to the surface waters by the sediment phosphorus release rate, the lake basin surface area experiencing anoxia, and the duration of hypolimnetic anoxia. The 1996 dissolved oxygen profiles of each basin were used to estimate the duration of anoxia (D.O. <0.5 mg/L). The fraction of each lake basin's total surface area experiencing anoxia was based on the depths of the observed summer anoxia and the morphometry of each basin. The average sediment total phosphorus release rate of 3 mg/m²/day (i.e., estimated from phosphorus mass increases in the hypolimnion during the period of anoxia) used for this analysis agrees well with the observed increase of total phosphorus over the anoxic portion of the hypolimnetic waters of each basin during the summer of 1996 and the estimate made using a relationship developed by Nurnberg et al. (1986). Finally, the fraction of hypolimnetic total phosphorus released to the surface waters was estimated to facilitate the calibration of the lake mass balance model. For the calibrated models, this fraction ranged from 0.04 to 0.50 for each basin. These release fractions compare to the range of release fractions, between 0.25 and 0.50, observed by Nurnberg (1985).

An atmospheric wet and dry deposition rate of 0.27 lbs/ac/yr, which agrees well with the most likely export coefficient in the WILMS model (Panuska and Wilson, 1994), was applied to the surface area of Lac Courte Oreilles. One exception to this export rate was an atmospheric wet and dry deposition rate of 0.09 lbs/ac/yr used to take into account the assimilation from the upstream

lakes. The watershed runoff component from the monitored inflows was estimated using the measured inflow concentrations and estimated runoff from each of the monitored watersheds.

Phosphorus export rate computations, used in the WILMS model and published by the U.S. EPA for septic systems, were used to estimate an annual load from drain fields. The equation used for Lac Courte Oreilles estimated the septic system load as follows:

$$\text{Total Septic System Load (kg/yr)} = E_{c_{st}} * \# \text{ of capita-years} * (1 - SR)$$

Where:

- $E_{c_{st}}$ = export coefficient to septic tank systems (0.5 kg/capita/yr)
- cap.-yrs. = # of people occupying a dwelling each year
= (# of permanent residents/dwelling)*(permanent dwellings) + (# of seasonal residents/dwelling)*(days/yr)*(seasonal dwellings)
- SR = weighted soil retention coefficient (0.85 for most likely value used in model)

The USGS Quadrangle maps were used to determine the number of septic systems within each of the lake basin areas and the total number of septic systems for both permanent and seasonal residences. The most likely soil retention coefficients of 0.90 and 0.40 were chosen for properly and improperly functioning systems, respectively (Panuska and Wilson, 1994). Ten percent of the septic systems were assumed to be improperly functioning, yielding a weighted soil retention coefficient of 0.85. The weighted soil retention coefficient for Lac Courte Oreilles was the same as the weighted soil retention coefficient for Balsam Lake in Polk County, Wisconsin (WDNR, 1994). Each permanent and seasonal dwelling unit was assumed to have three and five residents, respectively, on average. The seasonal dwelling units were assumed to have been occupied 100 days per year. Thirty percent of the residences were assumed to be permanent dwellings in each lake basin.

Septic system loading to Basin D or Musky Bay was evaluated via a direct survey of dwellings by the LCO Conservation Department with assistance from riparian residents. The Basin D watershed was reported to have 5 year-round and 10 seasonal residences. An examination of Sawyer County records to determine septic system compliance indicated that all dwellings except one were in compliance. Sawyer County records further indicated that dwellings tributary to Basin D were found on sandy soils and were located at a relatively high elevation, conditions considered ideal for septic systems (Masek, 1994).

Phosphorus loading from waterfowl was estimated to be negligible for all portions of Lac Courte Oreilles except Basin D. Because of the favorable habitat for waterfowl in Basin D, annual

phosphorus loading from waterfowl was estimated. The predicted waterfowl contribution to Basin D is based upon the observed average waterfowl (i.e., species and number of each species) observed on Basin D by area residents (Hagen, 1997, Personal Communication) and loading predictions according to Scherer et al. (1994). The number of waterfowl and species composition used to predict waterfowl loading were based upon observations by year-round residents who are interested in the bay's waterfowl. Sampling personnel generally observed fewer waterfowl on the bay (i.e., 0 to 3 waterfowl) (Tyrolt, 1997, Personal Communication) during sample events. However, the more frequent observations of area residents probably yields a more accurate estimate of average waterfowl presence on the bay. Riparian residents of Basin D have observed approximately 30 waterfowl per day on Basin D, comprised of roughly 40 percent mallards, 30 percent wood ducks, and 30 percent mergansers (Hagen, Personal Communication, 1997). Waterfowl were assumed present on Basin D for 180 days (i.e., from May 15 through November 15). Feces was estimated to be 27 grams/day/bird for mallards and 22.5 grams/day/bird for wood ducks and mergansers. Approximately 80 percent of the waterfowl feces was predicted to be deposited in the lake. The estimated phosphorus content of the feces was 1.87 percent of the dry weight (Scherer et al., 1994). Based upon these assumptions, annual phosphorus loading by waterfowl to Basin D was estimated to be 1.96 kg.

Internal loading from macrophytes was assumed to be negligible for all portions of Lac Courte Oreilles. With the exception of Basin D, few macrophytes were found in the lake's littoral area, and phosphorus loading from macrophyte senescence was assumed to be negligible. Although a dense macrophyte population was found in Basin D from early summer through ice-in, the bay's thick flocculent sediment layer was believed to retain the macrophytes and prevent phosphorus loading from senescing macrophytes to the overlying waters. The depth of the flocculent layer is estimated to be approximately 5 to 6 feet throughout the bay (Hagen, personal communication, 1997). Senescing macrophytes are assumed to sink to the bottom of the flocculent layer and enrich the sediment pore waters rather than the waters overlying the sediment layer.

The accuracy of the coefficients to predict phosphorus loading to the bays was evaluated by comparing the predicted in-lake phosphorus concentration for each bay with the observed concentration. The model prediction of average total phosphorus concentration in Basins A, B, C, and D was the same as the observed average epilimnetic (i.e., surface water, upper 6 feet) total phosphorus concentration. The predicted total phosphorus concentration in Basins E, F, G, and H was very close to the observed average epilimnetic total phosphorus concentration. The data thus support the annual phosphorus export coefficients selected for the model.

5.0 Results and Discussion

5.1 Compiled Data

Water quality data acquired by the 1996 monitoring program are compiled in Appendices A through G. Appendix A presents the tabulated in-lake water quality data for each lake station. Selected water quality parameters from Appendix A are analyzed and summarized in the discussion below. Appendix B contains the tabulated periphyton data. Appendix C contains the tabulated inflow and outflow total phosphorus concentrations. Appendix D contains the stream staff gage measurements, inflow and outflow discharge measurements, and total phosphorus concentrations. From these results, the flux of phosphorus from the watershed was calculated and used to calibrate the phosphorus mass balance model. Lake level data used to determine changes in lake volume are shown in Appendix E. Appendix F contains the precipitation data collected by Courte Oreilles Lakes Association volunteers.

5.2 1996 Lake Water Quality Conditions

5.2.1 Phosphorus

Phosphorus is the plant nutrient that most often limits the growth of algae.

Phosphorus-rich lake water indicates a lake has the potential for abundant algal growth, which can lead to lower water transparency and a decline in hypolimnetic oxygen levels in a lake.

Algal growth is generally phosphorus-limited in waters with nitrogen (N) to phosphorus (P) ratios greater than 12. To determine the nutrient limiting algal growth in Lac Courte Oreilles, May through September average N:P ratios for lake sampling locations were evaluated. Based on the data presented in Table 5, all sampling locations appear to be phosphorus limited.

Table 5 1996 Lac Courte Oreilles Surface Water May Through September Average N:P Ratios

Basin	May Through September Average N:P Ratio
A	25
B	27
C	34
D	25
E	25
F	28
G	33
H	31

Total phosphorus data collected from Lac Courte Oreilles during 1996 were generally within the mesotrophic (i.e., moderate amounts of nutrients) category during May and the oligotrophic (i.e., few nutrients or nutrient-poor) category during June through September. The three deep basins (i.e., Stations A, B, and C on Figure 5) and all bays except Musky Bay (i.e., Station D on Figure 5) exhibited similar phosphorus concentrations during the growing season. The summer (i.e., June through August) average epilimnetic (i.e., surface waters—upper 6 feet) summer phosphorus concentrations at all stations but Basin D ranged from 0.006 mg/L to 0.010 mg/L (See Figures 10-17). These averages are within the oligotrophic category and indicate the lake has excellent water quality.

Total phosphorus data collected from Station D during 1996 were within the mesotrophic (i.e., moderate amounts of nutrients) category during May, the eutrophic (nutrient-rich or well fertilized) category during June, and the mesotrophic category during August through September (See Figure 13). The summer (i.e., June through August) average epilimnetic (i.e., surface waters—upper 6 feet) summer phosphorus concentration for Basin D was 0.028 mg/L. The summer average is within the eutrophic category and indicates the bay has the potential for undesirable algal blooms.

LCO Lake: 1996 Total Phosphorus Conc. Station A

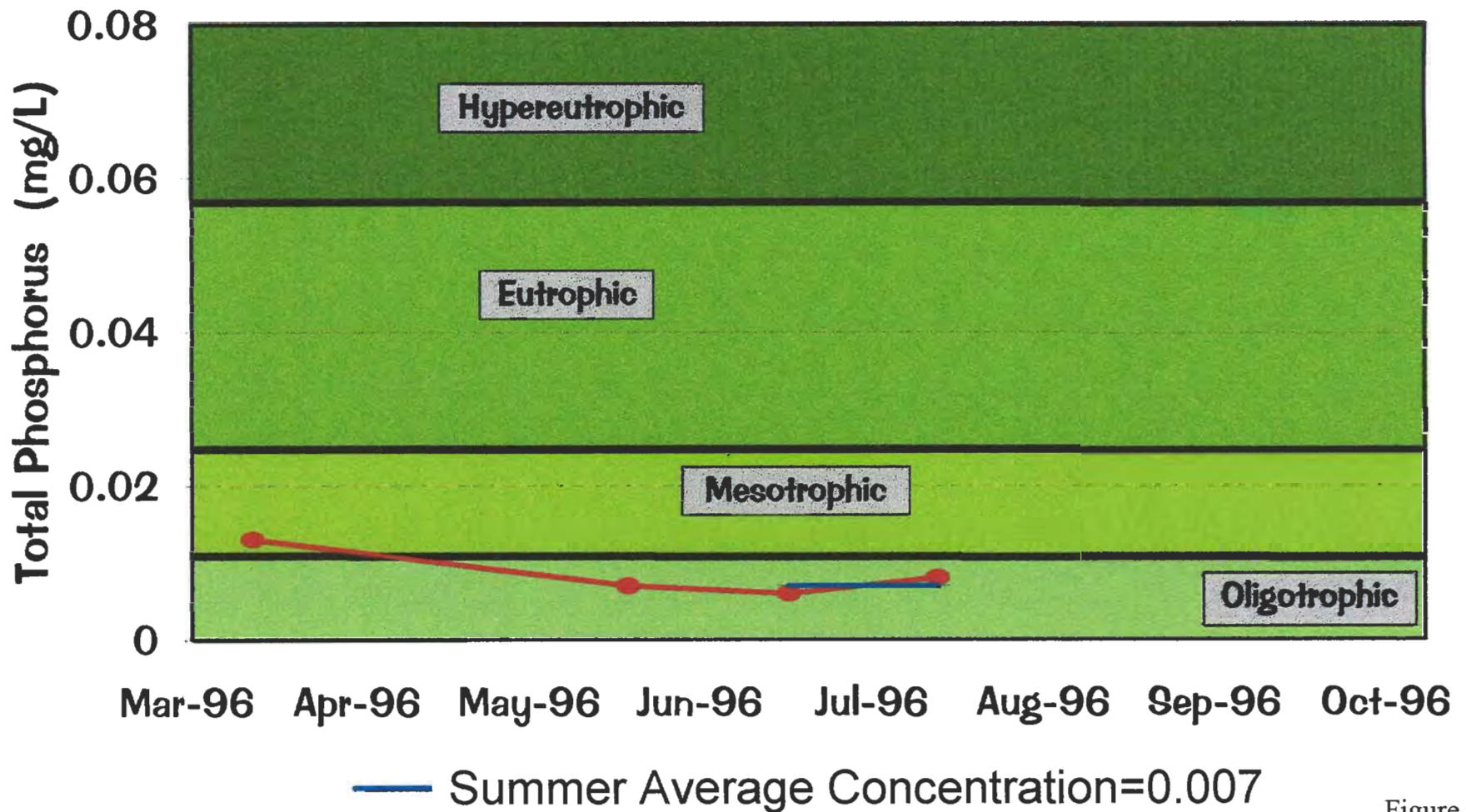

Figure 10

LCO Lake: 1996 Total Phosphorus Conc. Station B (West Hole)

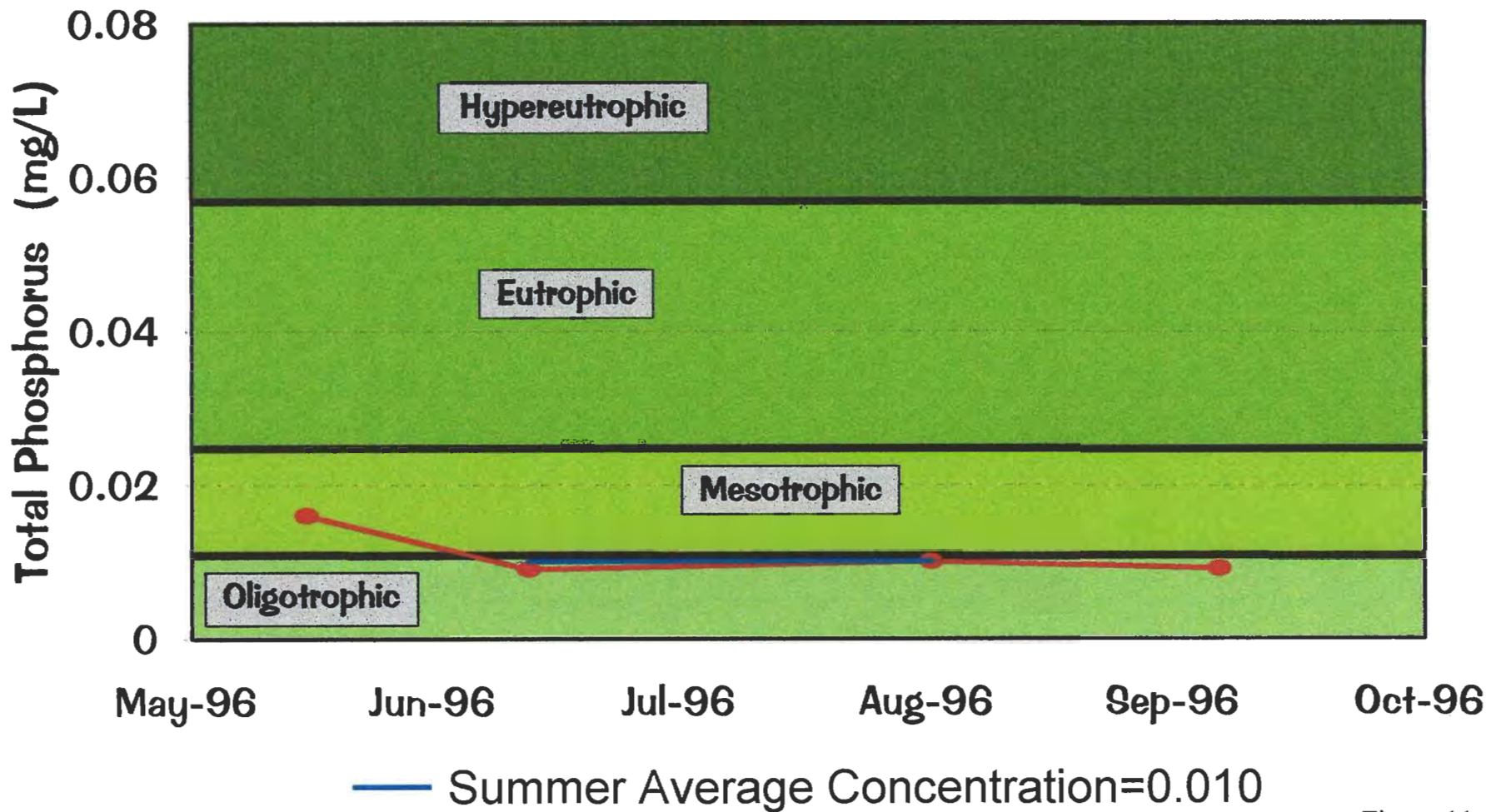

Figure 11

LCO Lake: 1996 Total Phosphorus Conc. Station C (Central Hole)

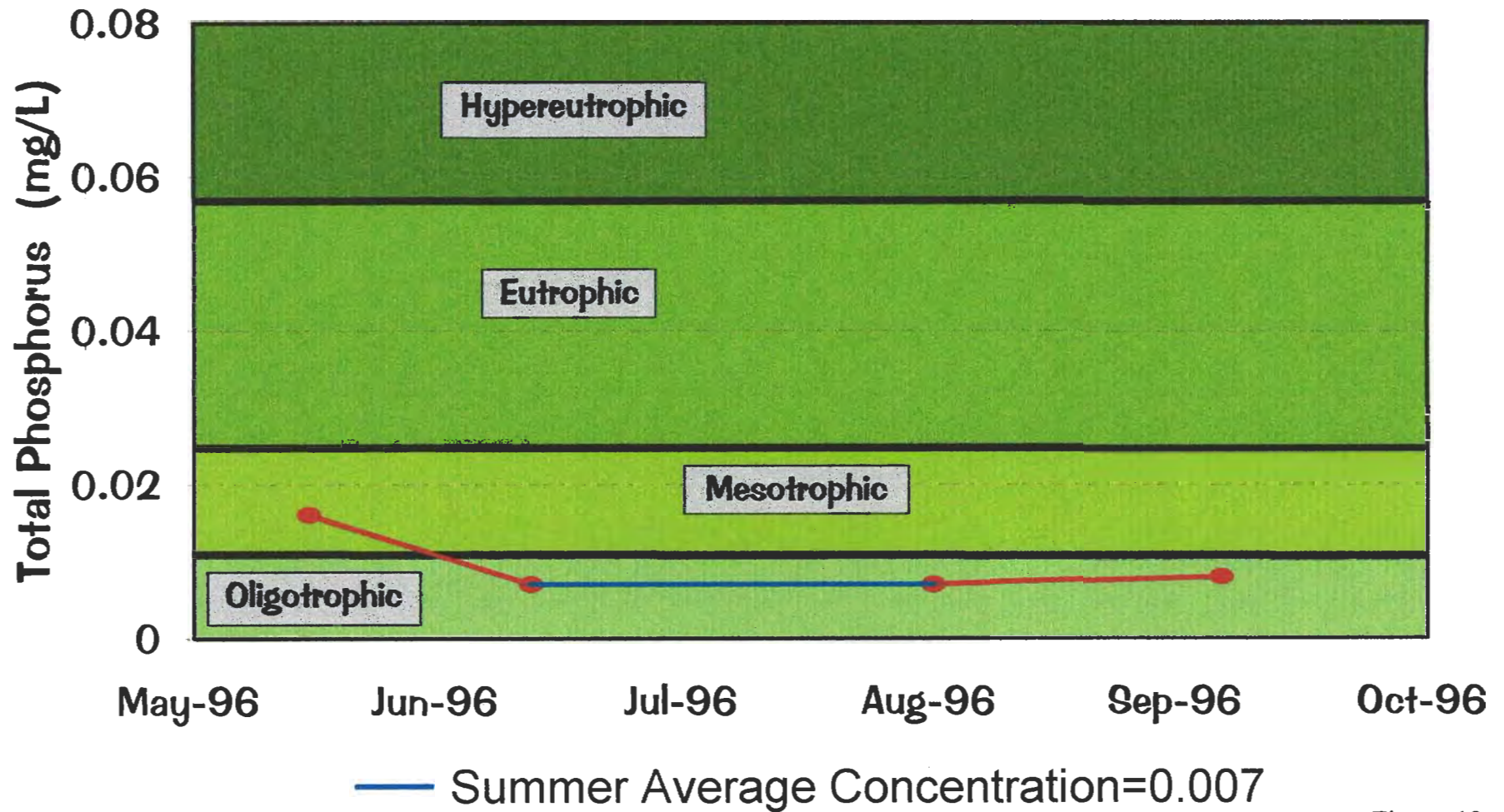

Figure 12

LCO Lake: 1996 Total Phosphorus Conc. Station D (Musky Bay)

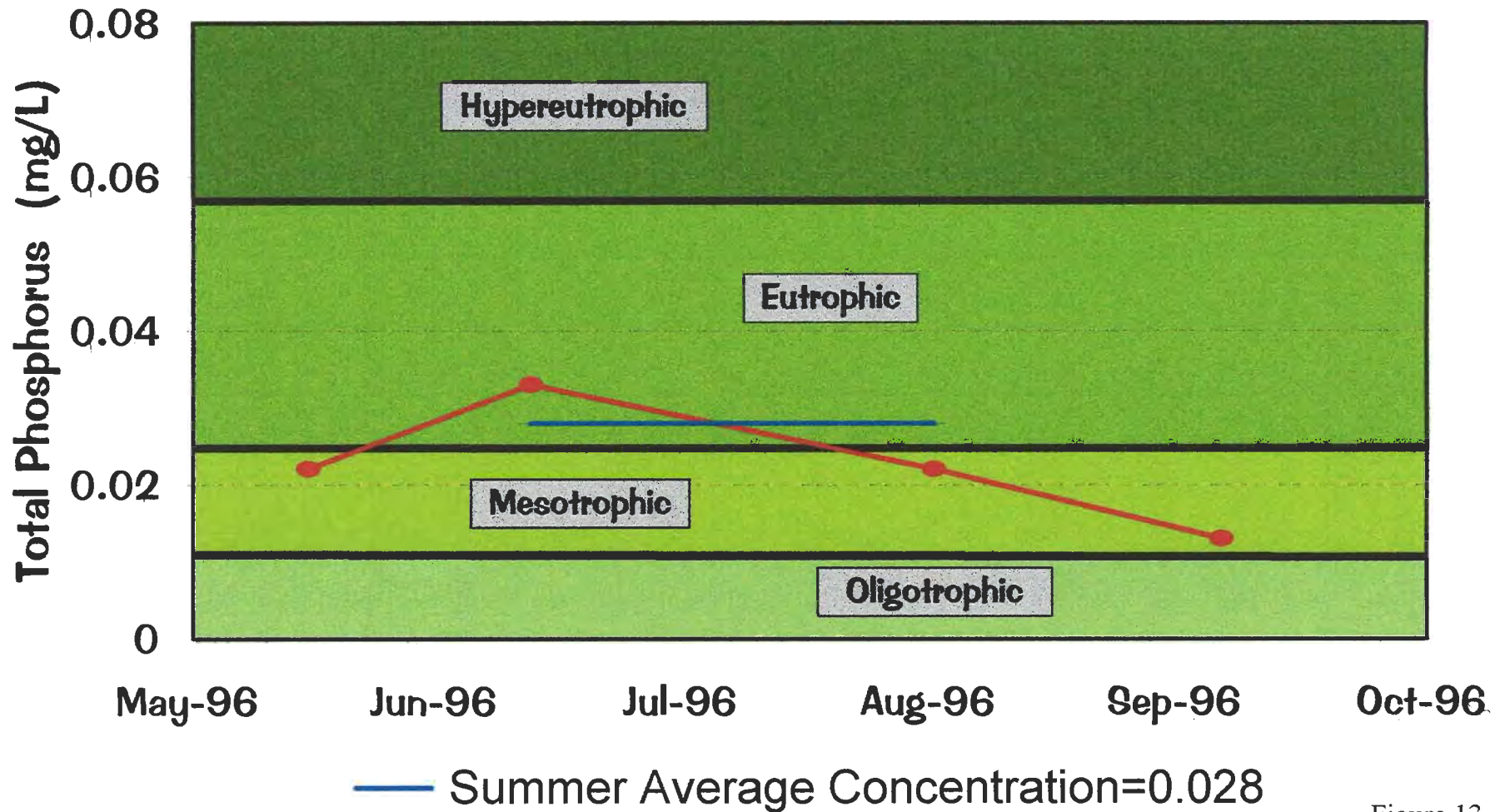

Figure 13

LCO Lake: 1996 Total Phosphorus Conc. Station E (Stukey Bay)

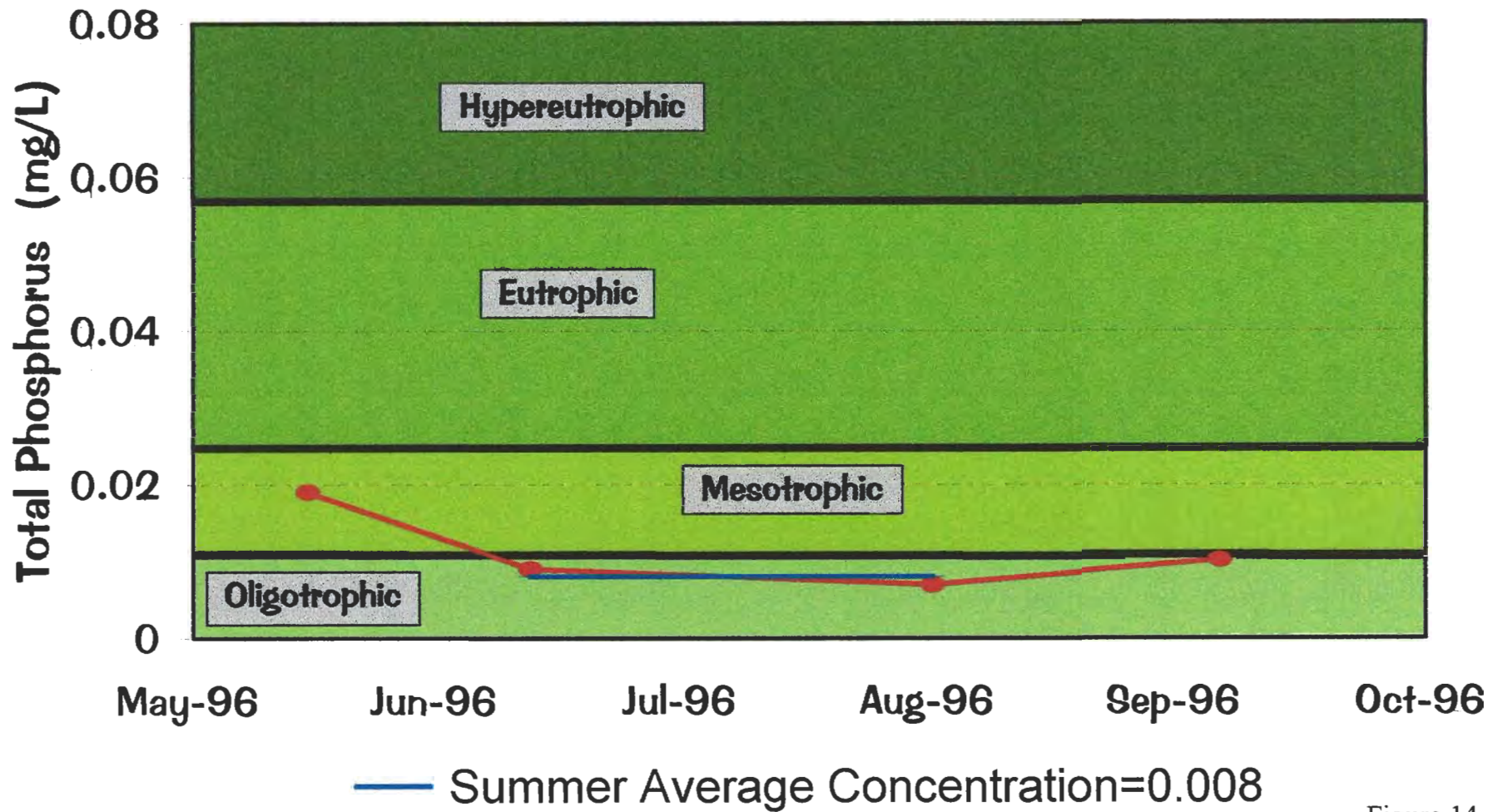

Figure 14

LCO Lake: 1996 Total Phosphorus Conc. Station F (Chicago Bay)

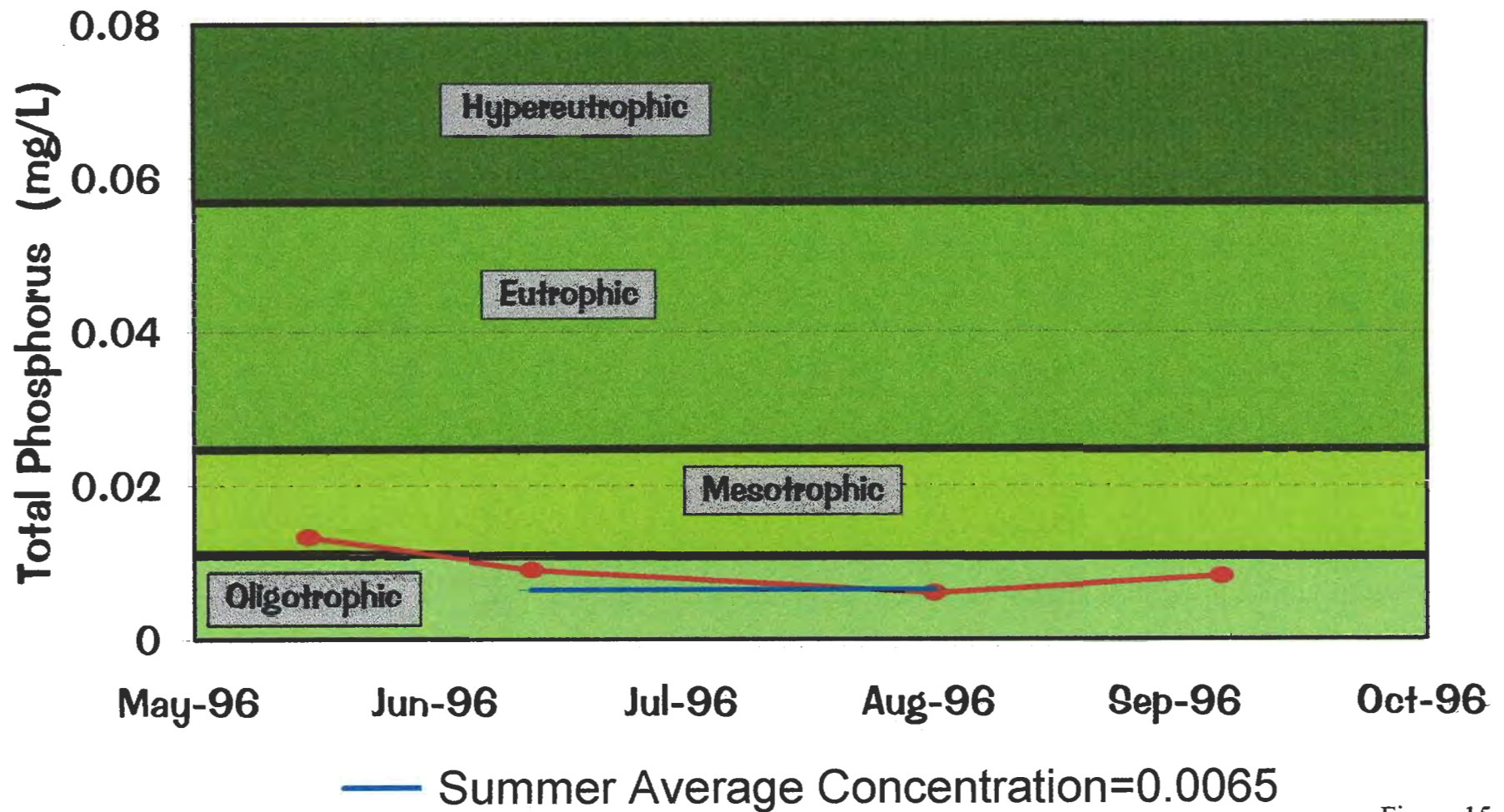
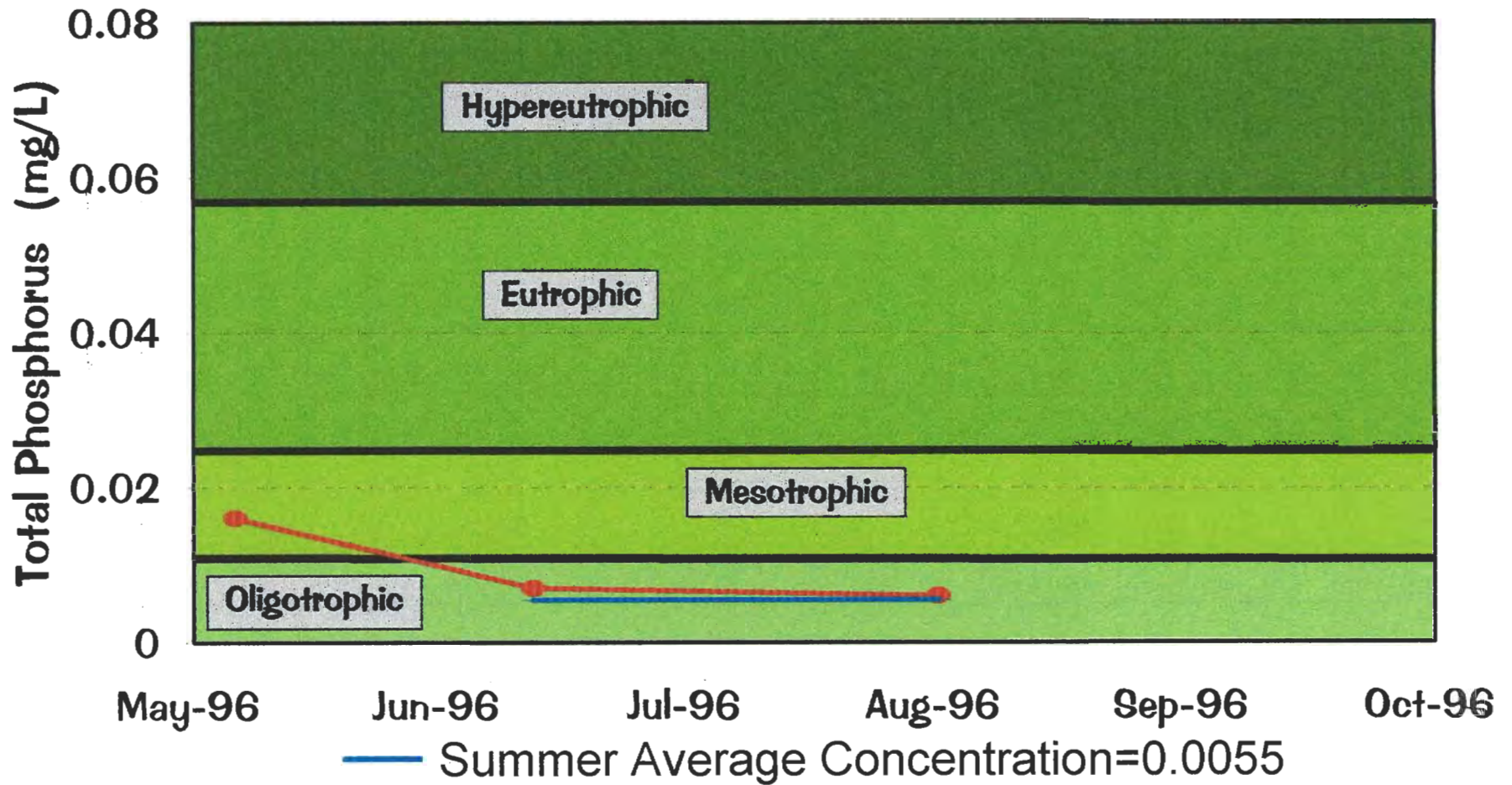

Figure 15

LCO Lake: 1996 Total Phosphorus Conc. Station G (Grindstone Bay)



Sept sample was contaminated

Figure 16

LCO Lake: 1996 Total Phosphorus Conc. Station H (Northeast Bay)

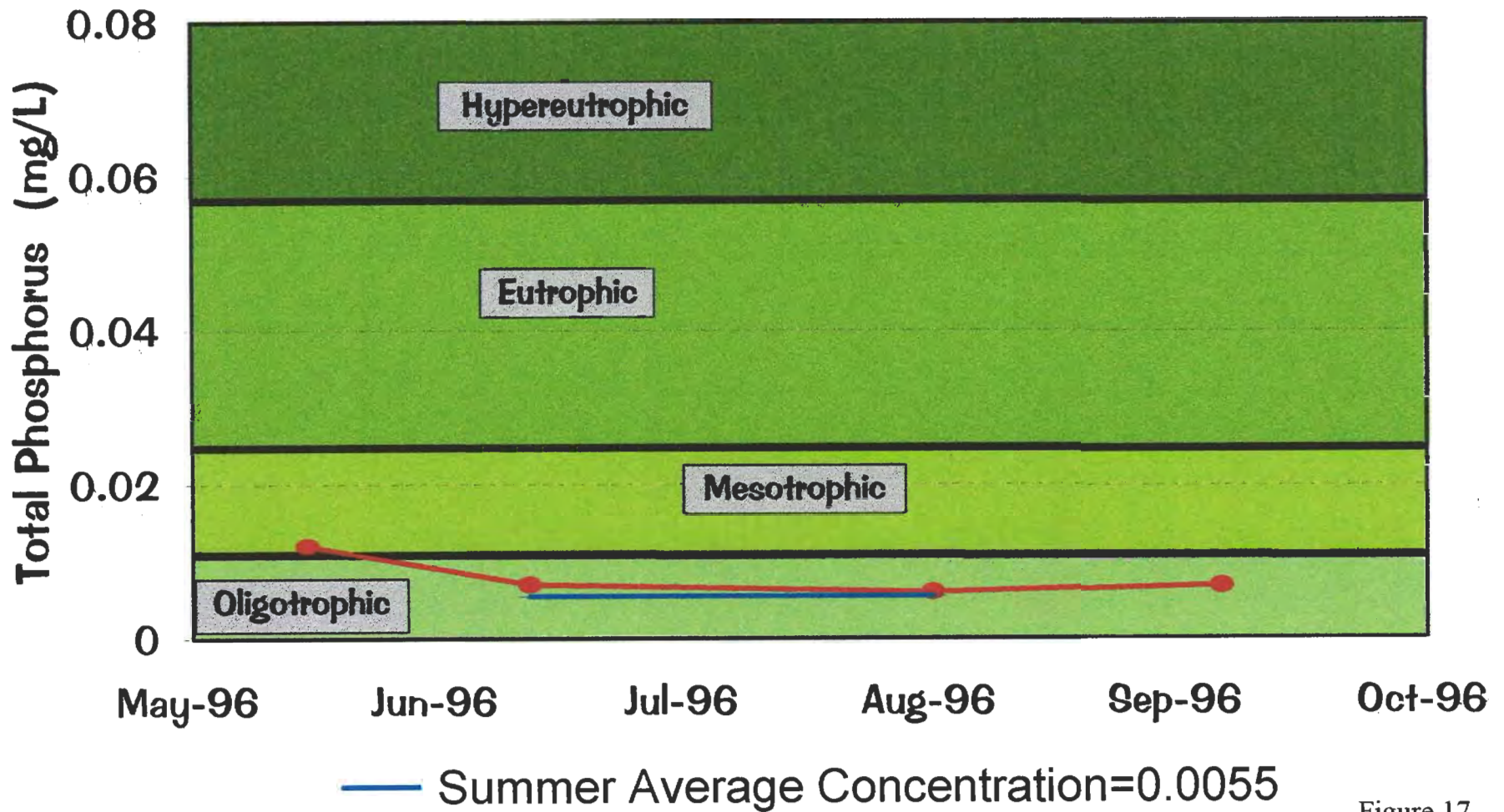

Figure 17

5.2.2 Chlorophyll *a*

Chlorophyll a is a measure of algal abundance within a lake. High chlorophyll a concentrations indicate excessive algal abundance (i.e., algal blooms), which can lead to recreational use impairment.

The 1996 Lac Courte Oreilles chlorophyll *a* data indicate moderate chlorophyll concentrations generally occurred throughout the sampling period. Basin A (See Figure 5) had moderate chlorophyll concentrations during the spring period (i.e., mesotrophic category); however, reduced algal abundance resulted in low chlorophyll concentrations throughout the summer period (i.e., oligotrophic category). All other sample locations noted moderate algal biomass throughout the sampling period. Summer average epilimnetic (i.e., surface waters—upper 6 feet) chlorophyll *a* concentrations ranged from a low of 1.2 µg/L at Station A to a high of 6.91 µg/L at Station D (See Figures 18-25). The seasonal pattern of chlorophyll *a* concentrations was similar to phosphorus concentrations in the basins/bays suggesting that the lake's algal growth is directly related to phosphorus levels. The chlorophyll data indicate a relatively high yield resulted from the lake's available phosphorus in all basins/bays except Basins A and D, Figure 5. A lower chlorophyll yield from the lake's available phosphorus occurred in Basins A and D.

The lower algal yield indicated by samples from Station D may not accurately reflect the algal yield of the basin as a whole. Floating mats of algae observed in portions of Basin D during the summer period were not present at the sample station and were not measured in the chlorophyll samples. Therefore, these algal mats were not included in the estimate of algal abundance within Basin D (Tyrolt, personal communication, 1997). Floating algal mats in Basin D are shown in Figure 26.

LCO Lake: 1996 Epilimnetic Chlorophyll Concentration (Station A)

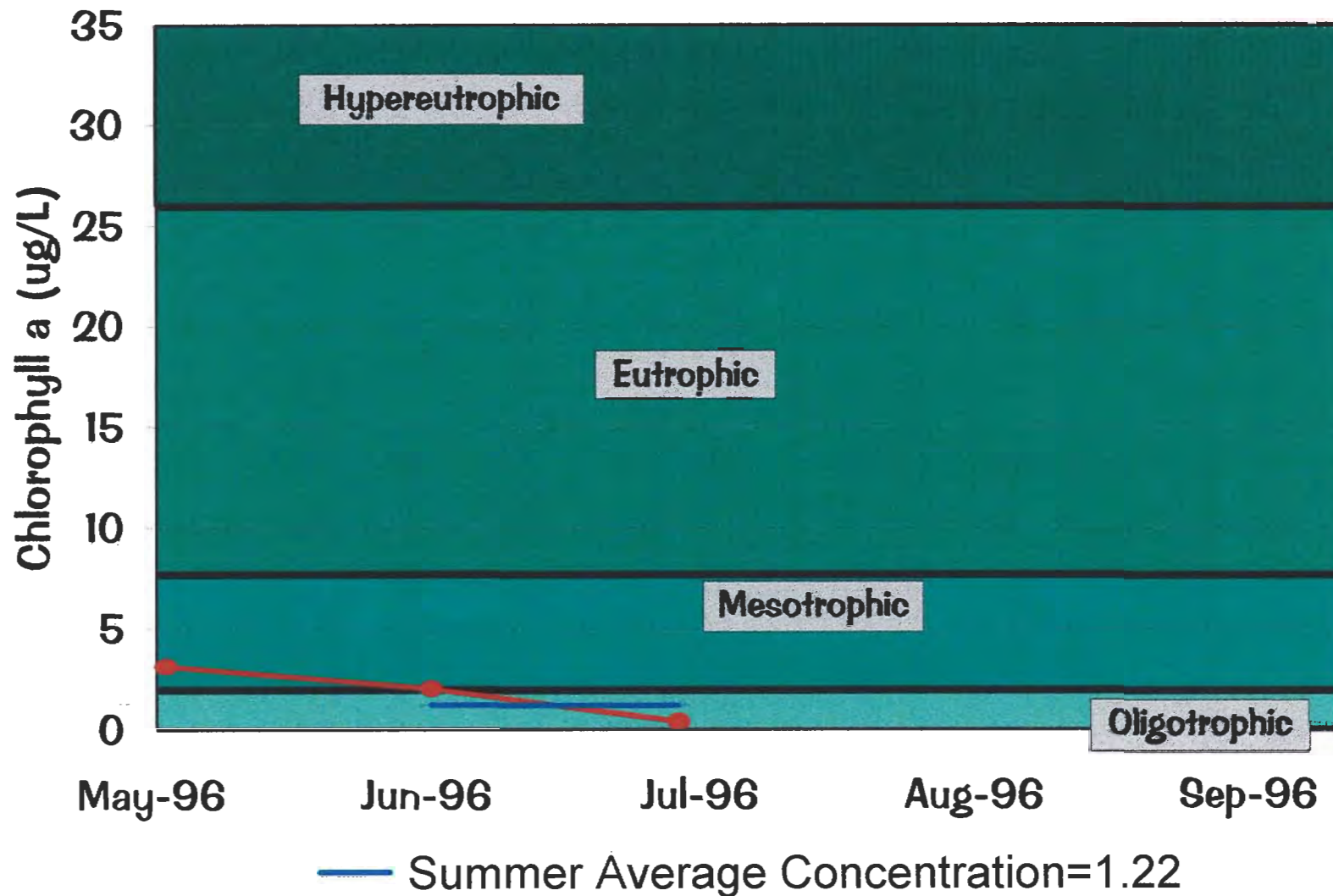

Figure 18

LCO Lake: 1996 Epilimnetic Chlorophyll Conc. (Station B; West Hole)

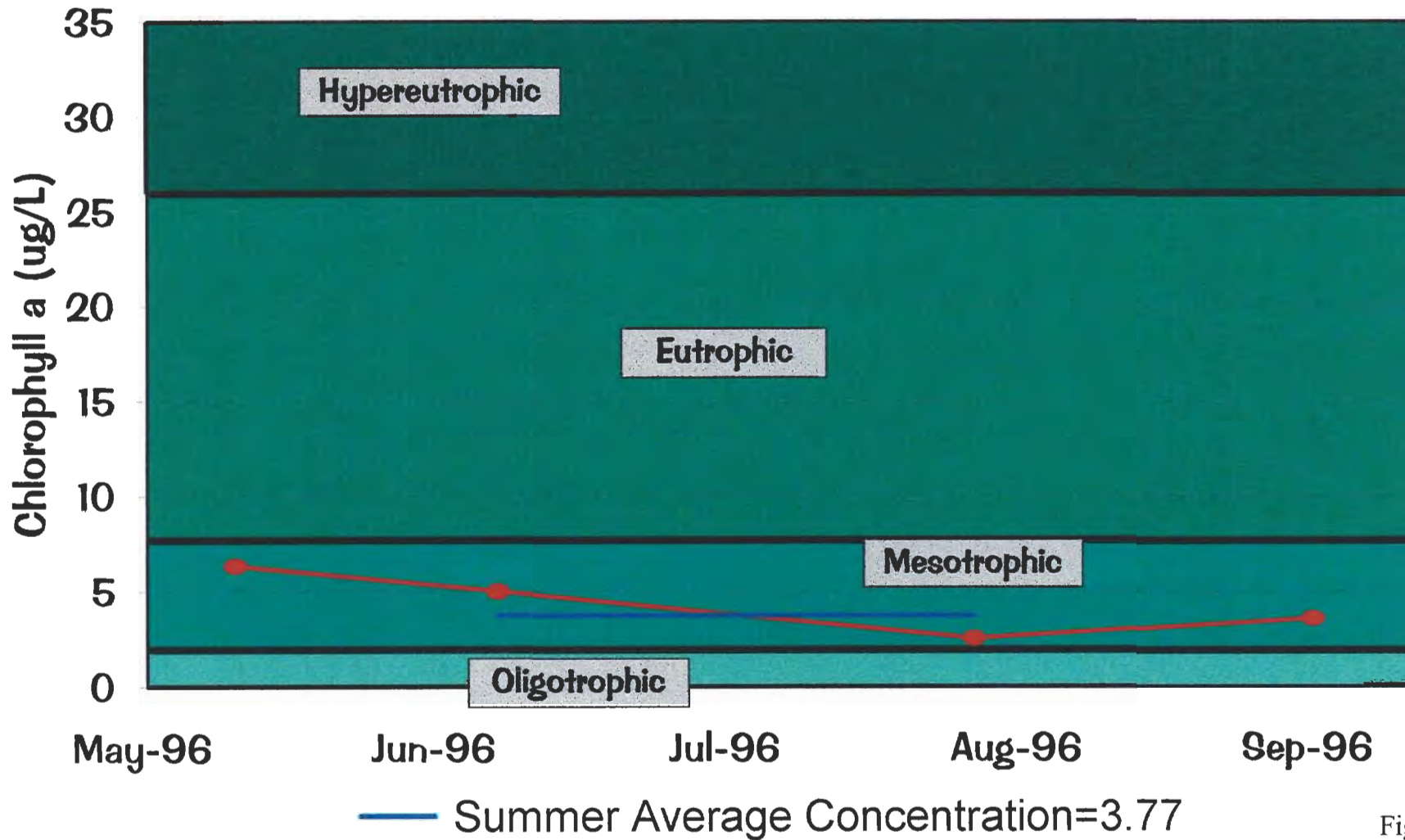

Figure 19

LCO Lake: 1996 Epilimnetic Chlorophyll Conc. (Station C; Center Hole)

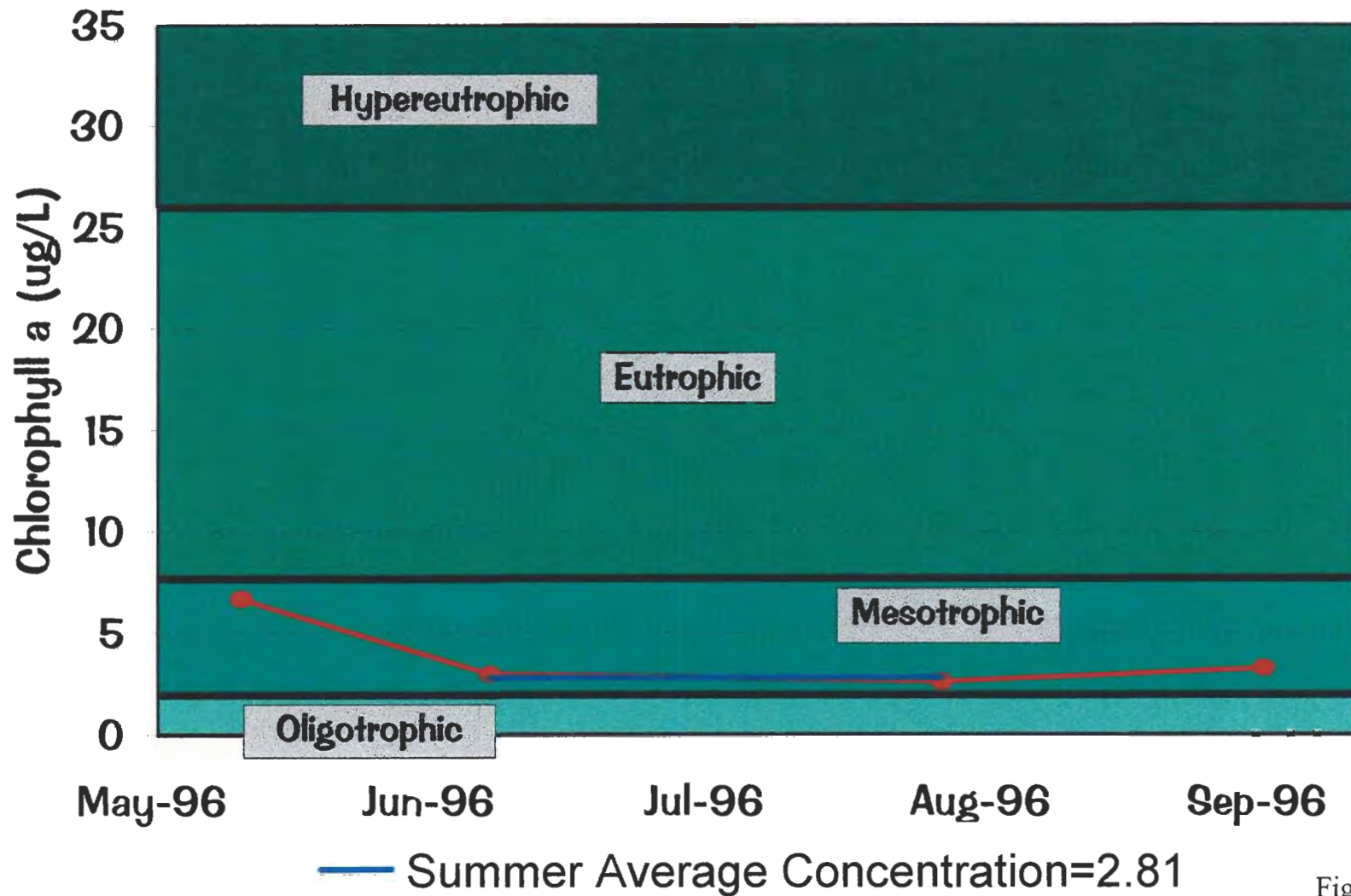

Figure 20

LCO Lake: 1996 Epilimnetic Chlorophyll Conc. (Station D; Musky Bay)

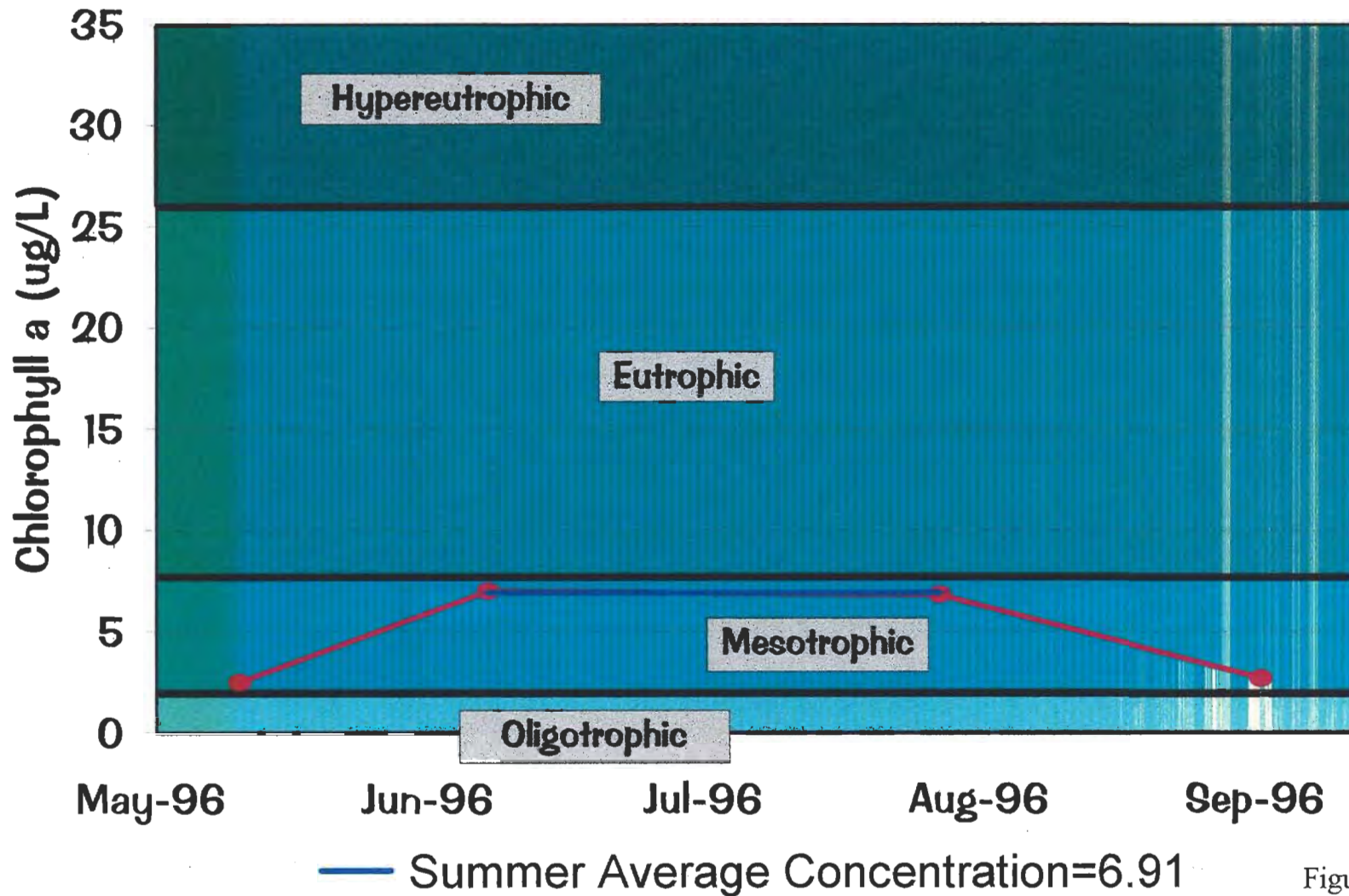

Figure 21

LCO Lake: 1996 Epilimnetic Chlorophyll Conc. (Station E; Stukey Bay)

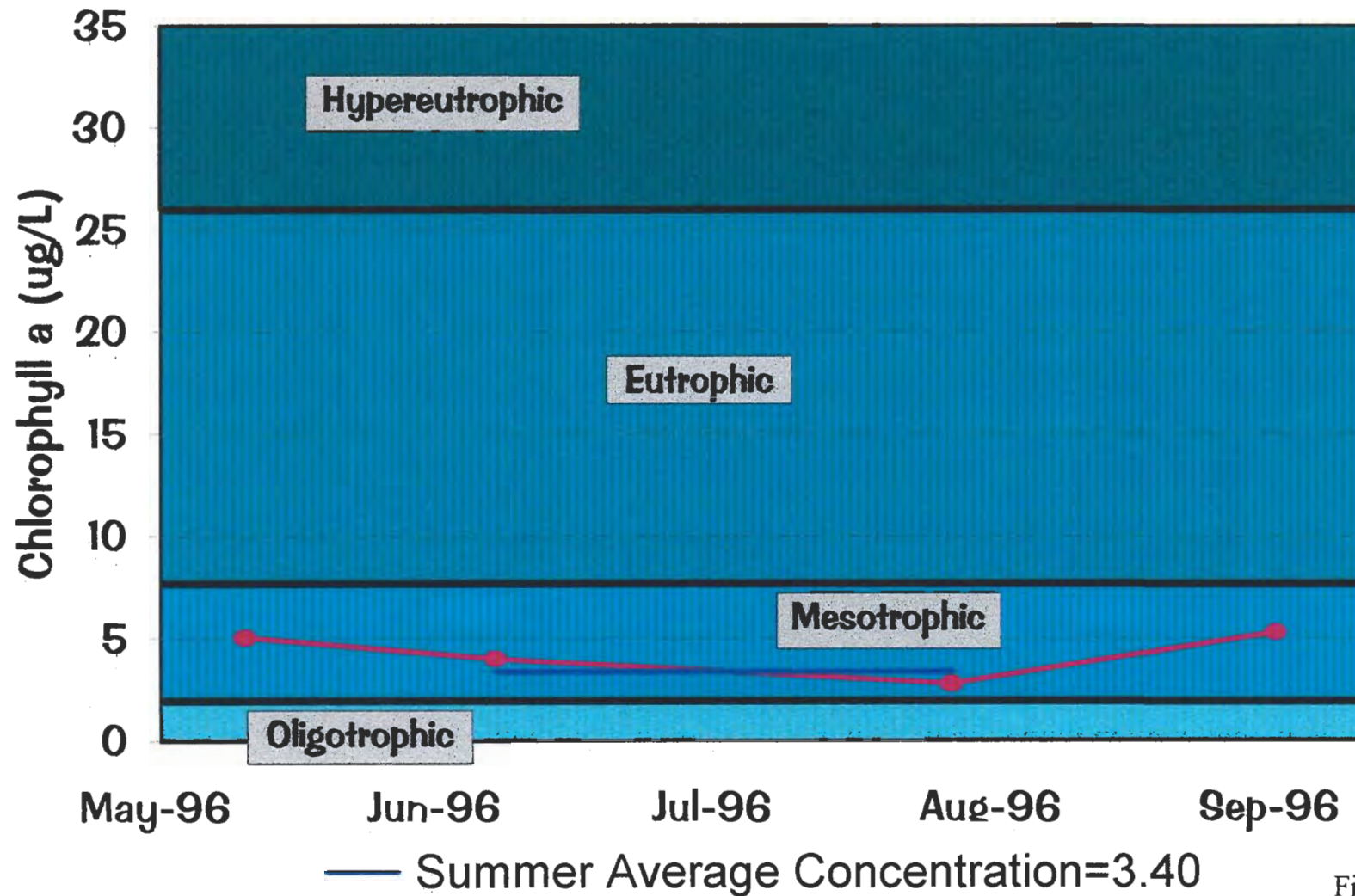

Figure 22

LCO Lake: 1996 Epilimnetic Chlorophyll Conc. (Station F; Chicago Bay)

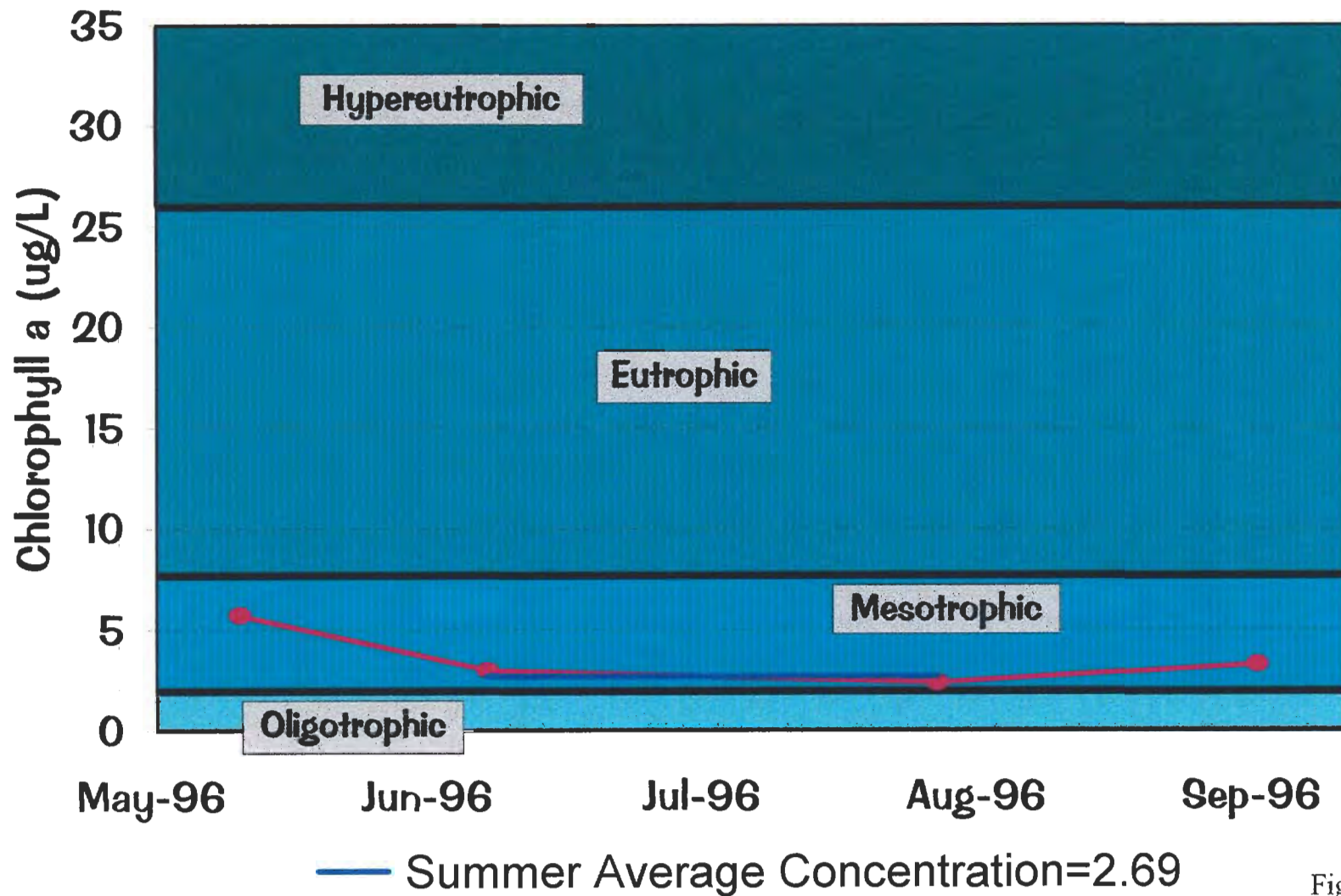

Figure 23

LCO Lake: 1996 Epilimnetic Chlorophyll Conc. (Station G; Grindstone Bay)

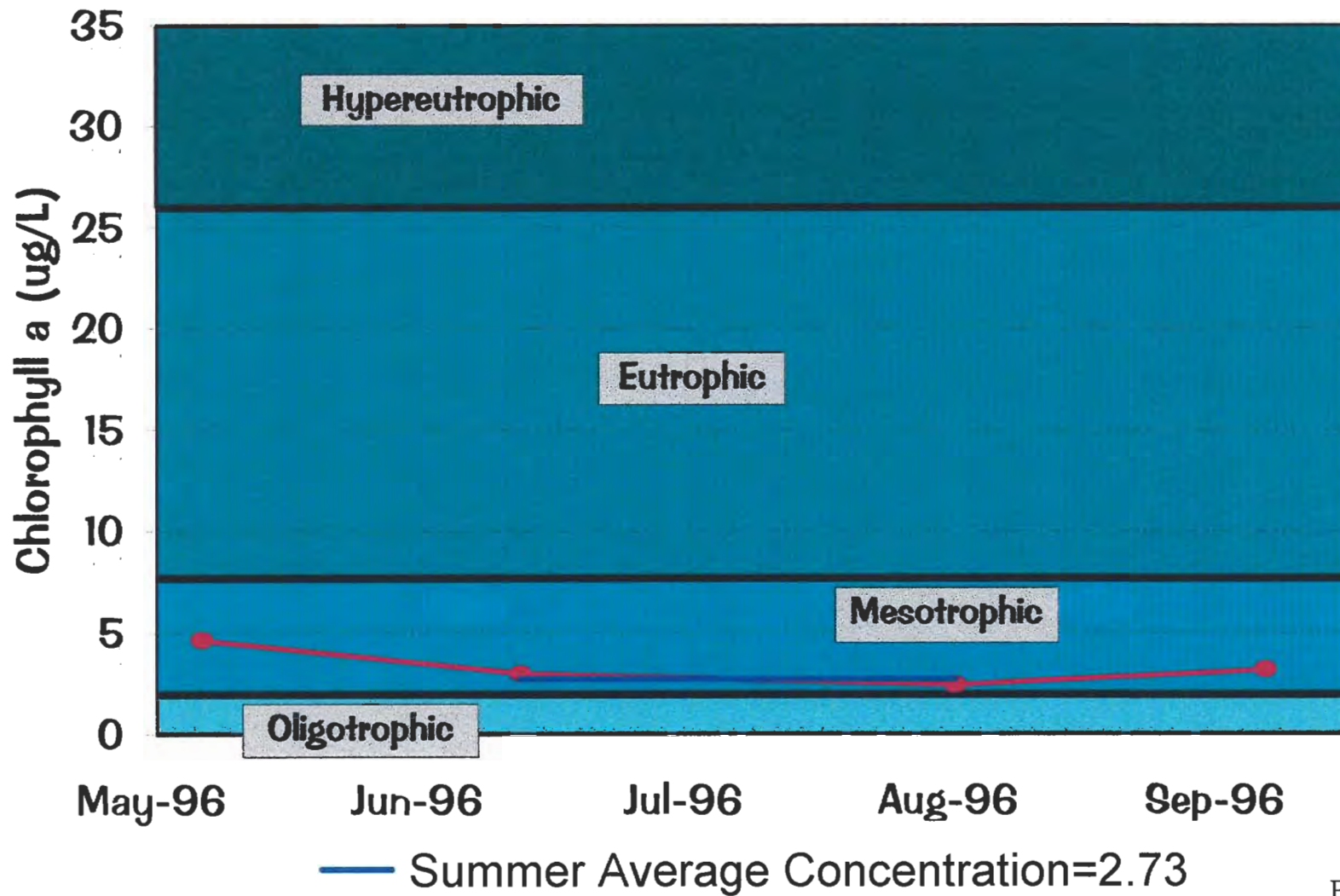

Figure 24

LCO Lake: 1996 Epilimnetic Chlorophyll Conc. (Station H; Northeast Bay)

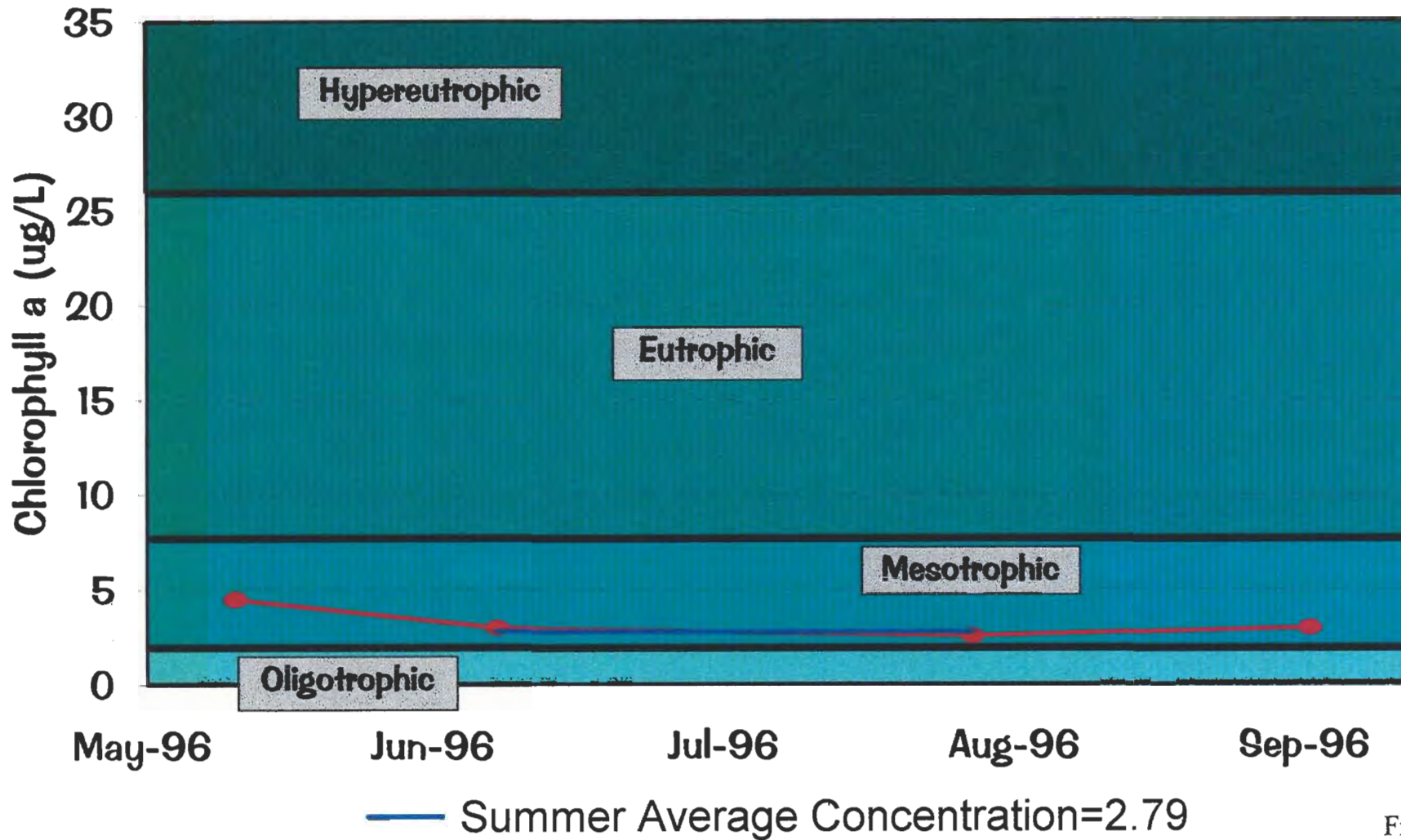
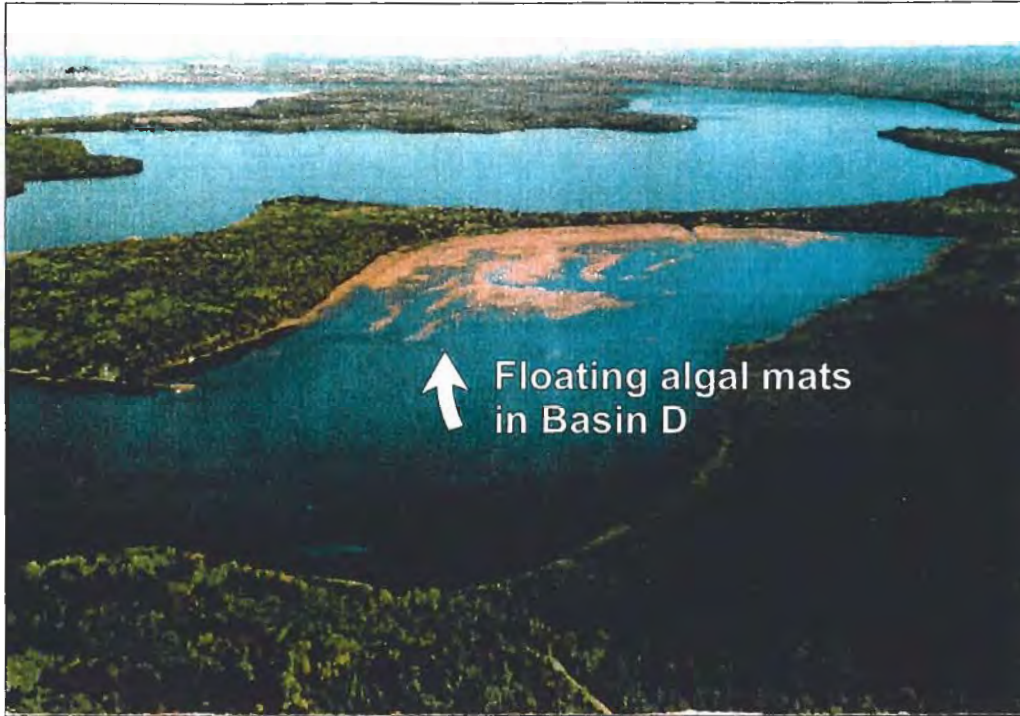

Figure 25

Aerial View of Lac Courte Oreilles



Musky Bay Algal Blooms (Summer 1996)

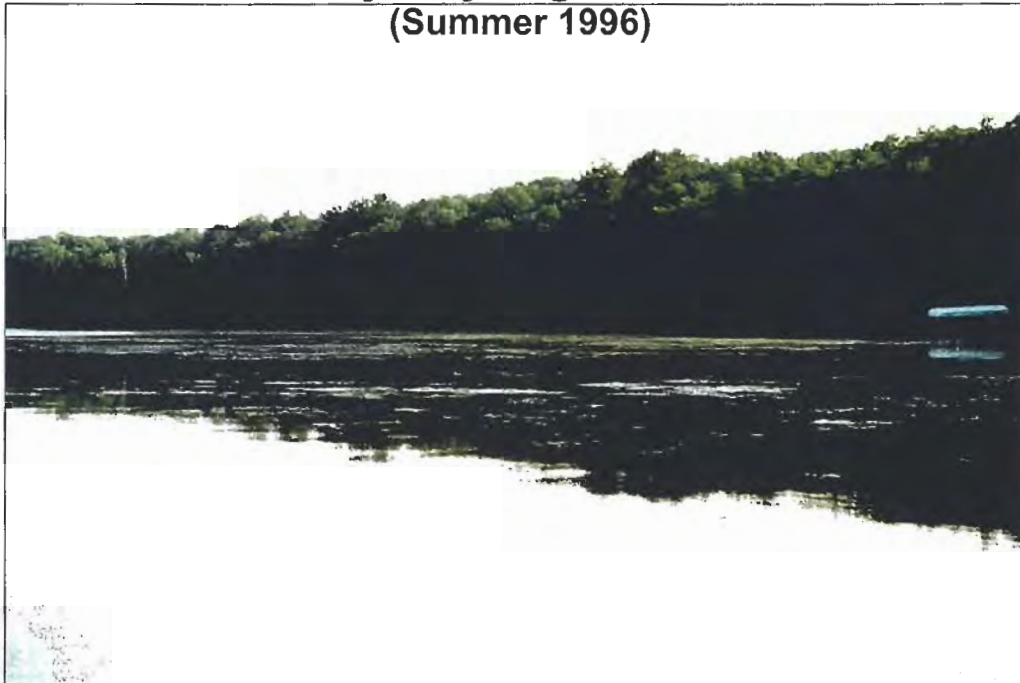

Figure 26
Musky Bay Algal Blooms

5.2.3 Secchi Disc Transparency

Secchi disc transparency is a measure of water clarity. Perceptions and expectations of people using a lake are generally correlated with water clarity. Results of a survey completed by the Metropolitan Council (Osgood, 1989) revealed the following relationship between a lake's recreational use impairment and Secchi disc transparencies:

- *No impairment occurs at Secchi disc transparencies greater than 4 meters.*
- *Minimal impairment occurs at Secchi disc transparencies of 2 to 4 meters.*
- *Moderate impairment occurs at Secchi disc transparencies of 1 to 2 meters.*
- *Moderate to severe use-impairment occurs at Secchi disc transparencies less than 1 meter (3.3 feet).*

Secchi disc measurements in Lac Courte Oreilles generally mirrored phosphorus and chlorophyll *a* concentrations (See Figures 27-34). Although fluctuations occurred, measurements were generally within the mesotrophic category (i.e., transparency from 2 to 4.6 meters). Improved water transparency was found at Station A and measurements at Station A were within the oligotrophic category (i.e., transparency greater than 4.6 meters) during much of the summer. The seasonal patterns suggest that the lake's water transparency is largely determined by algal abundance. Summer average Secchi disc measurements ranged from a low of 3.0 meters at Station D (i.e., Musky Bay, See Figure 5) to a high of 5.3 meters at Station A (i.e., East Deep Basin, See Figure 5). Based on the Metropolitan Council study, the 1996 average summer Secchi disc transparencies in:

- Basins A, B, C, G, and H indicate no recreational use impairment occurred
- Basins D, E, and F indicate minimal recreational use impairment occurred

The water transparency measurements from Station D (Musky Bay) do not accurately reflect the water transparency of the basin as a whole. Floating mats of algae observed in portions of Basin D during the summer period were not present at the deep hole sample station and, consequently, the Secchi disc readings from the lake's deep hole sampling location did not indicate the impacts of algal mats on the lake's water transparency (Tyrolt, personal communication, 1997). Secchi disc measurements were, therefore, collected in a near shore sample location where floating mats of algae were observed to measure the impacts of the algal mats on water transparency (See Figure 5). Measurements from the lake's deep hole sampling location were also collected on each

sample date. Near shore measurements ranged from 0.2 meters to 0.4 meters, indicating that severe recreational use impairment occurs in areas containing algal mats. All near-shore measurements were within the hypereutrophic (i.e., extremely productive lakes that are highly fertile) trophic status category. In contrast, Secchi disc measurements from the deep hole sample location ranged from 1.8 meters to 4.7 meters, indicating moderate to no recreational use impairment occurs at this location. Measurements from the lake's deep hole sample location ranged from the oligotrophic (i.e., clear, low productivity lakes) to the eutrophic (i.e., high productivity lakes) trophic status.

LCO Lake: 1996 Secchi Disc Readings Station A

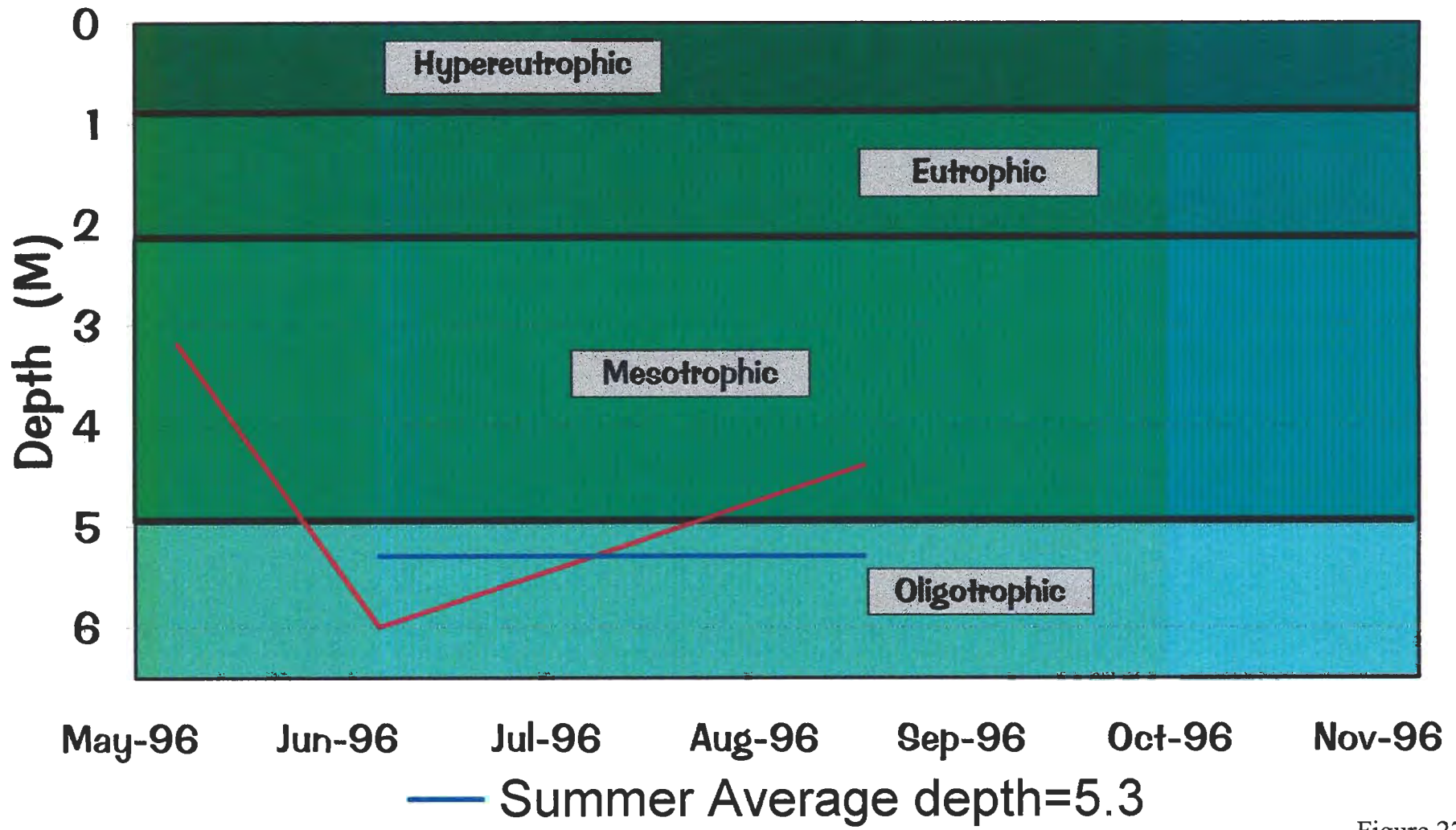
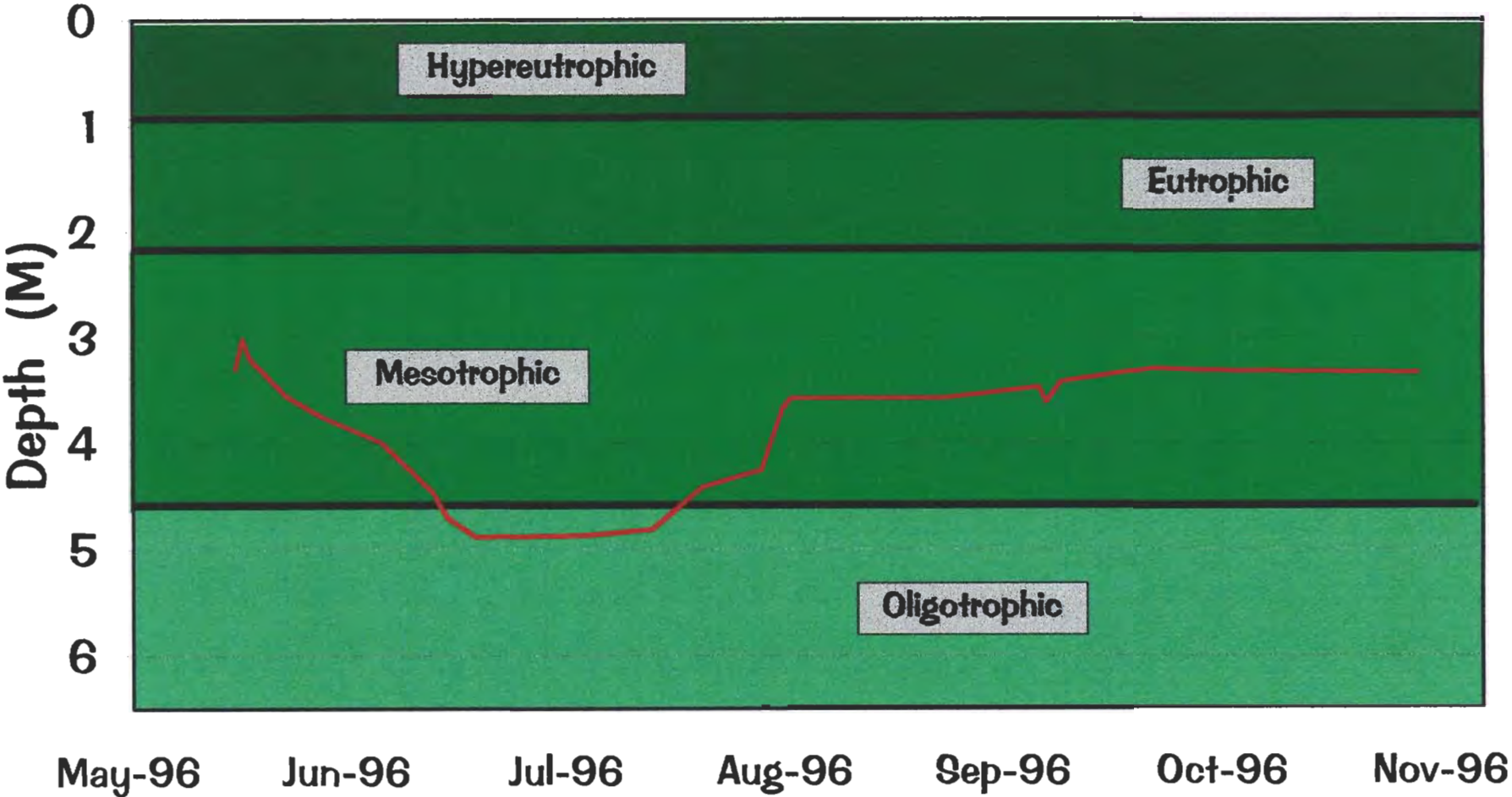

Figure 27

LCO Lake: 1996 Secchi Disc Readings Station B (West Hole)



Summer Average = 4.3

Figure 28

LCO Lake: 1996 Secchi Disc Readings Station C (Central Hole)

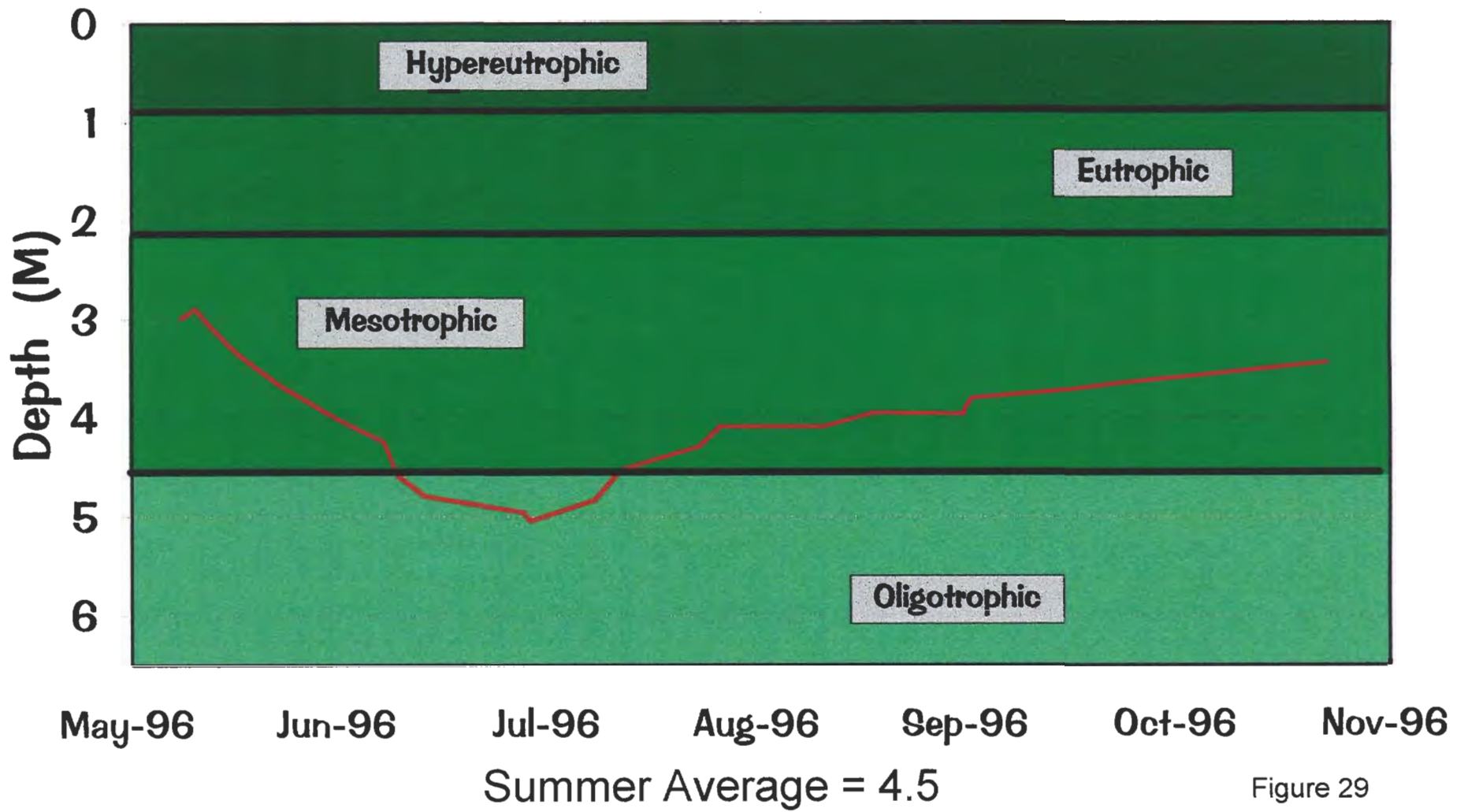
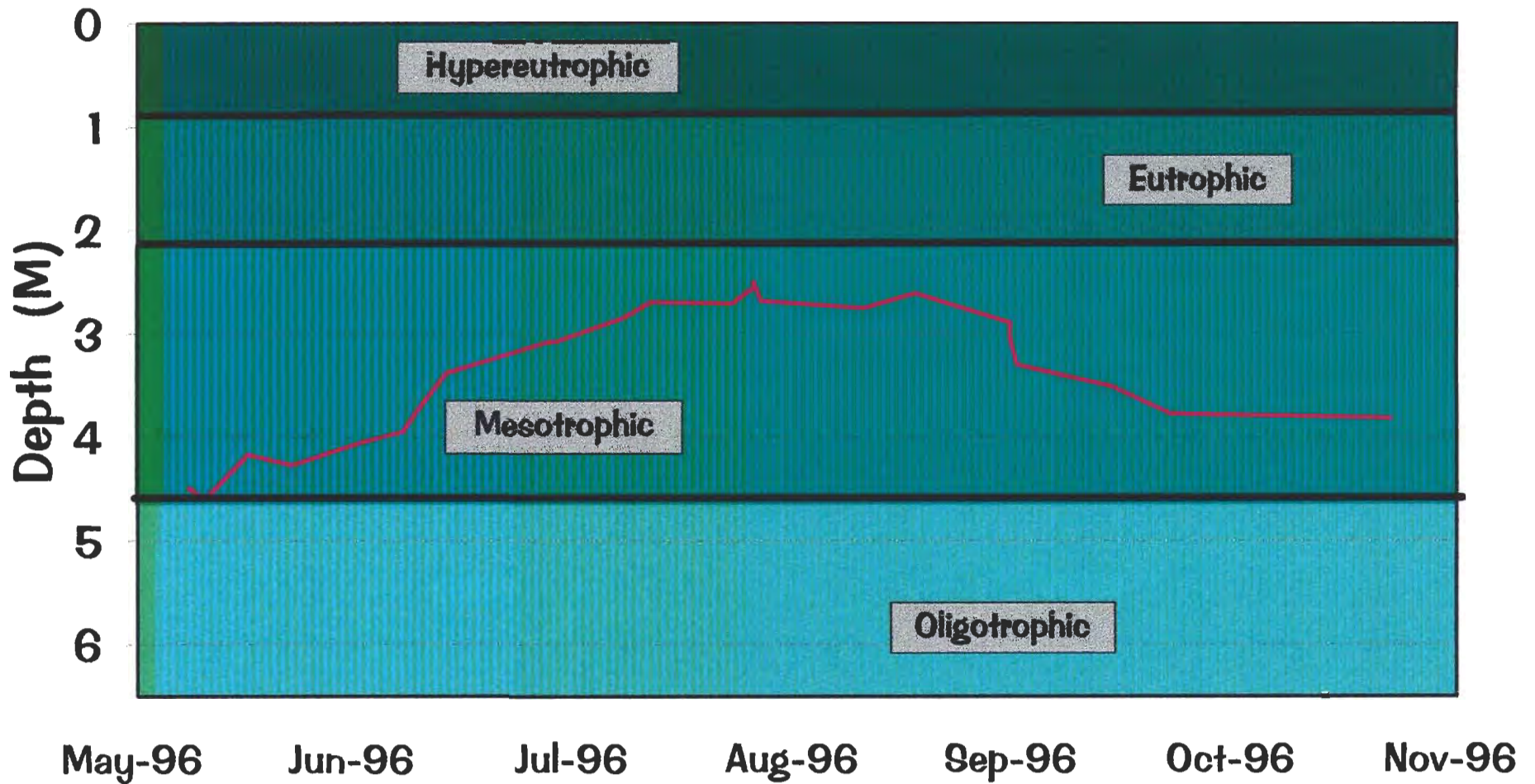

Figure 29

LCO Lake: 1996 Secchi Disc Readings Station D (Musky Bay)



Summer Average = 3.0

Figure 30

LCO Lake: 1996 Secchi Disc Readings Station E (Stukey Bay)

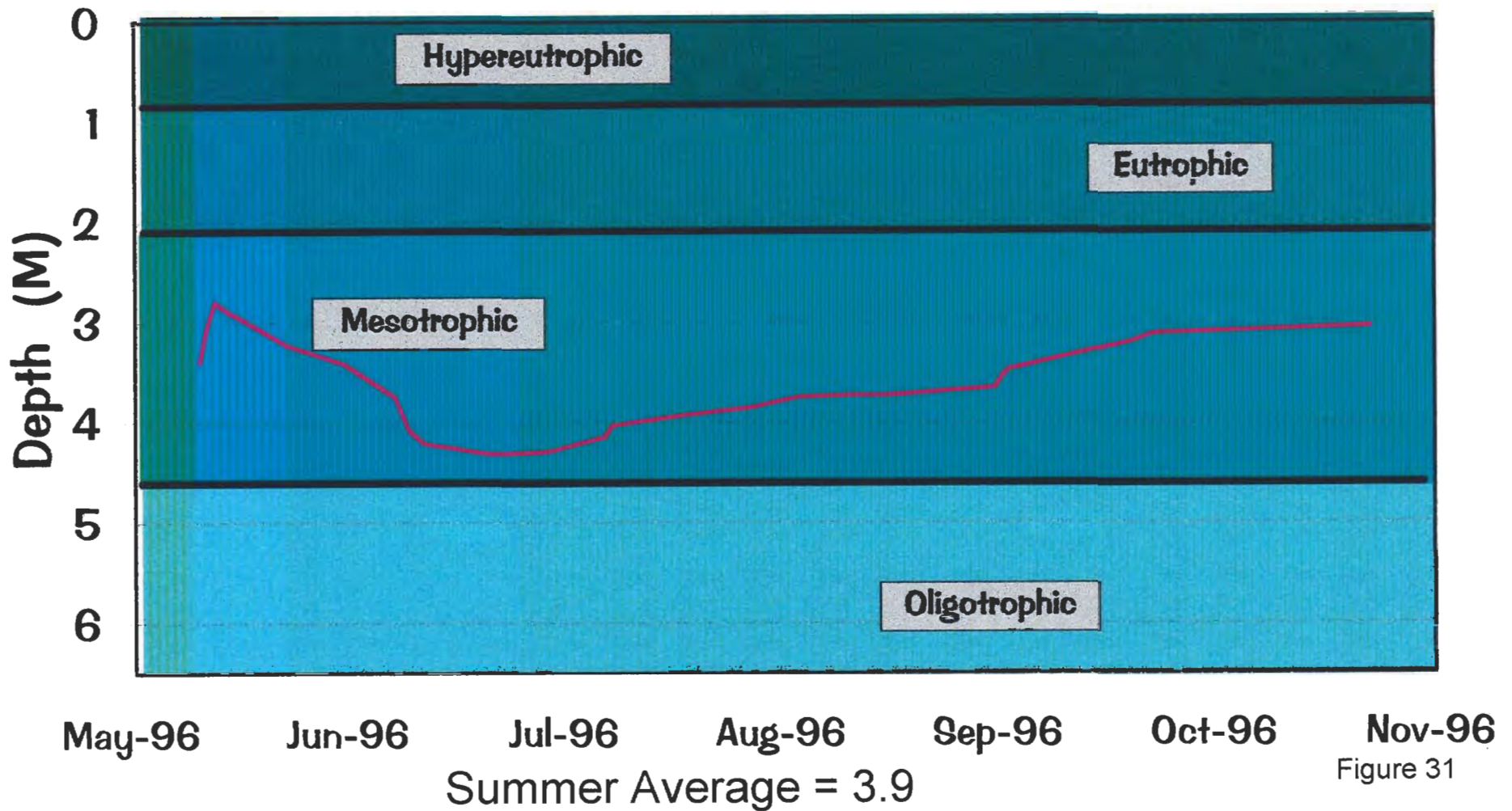

Figure 31

LCO Lake: 1996 Secchi Disc Readings Station F (Chicago Bay)

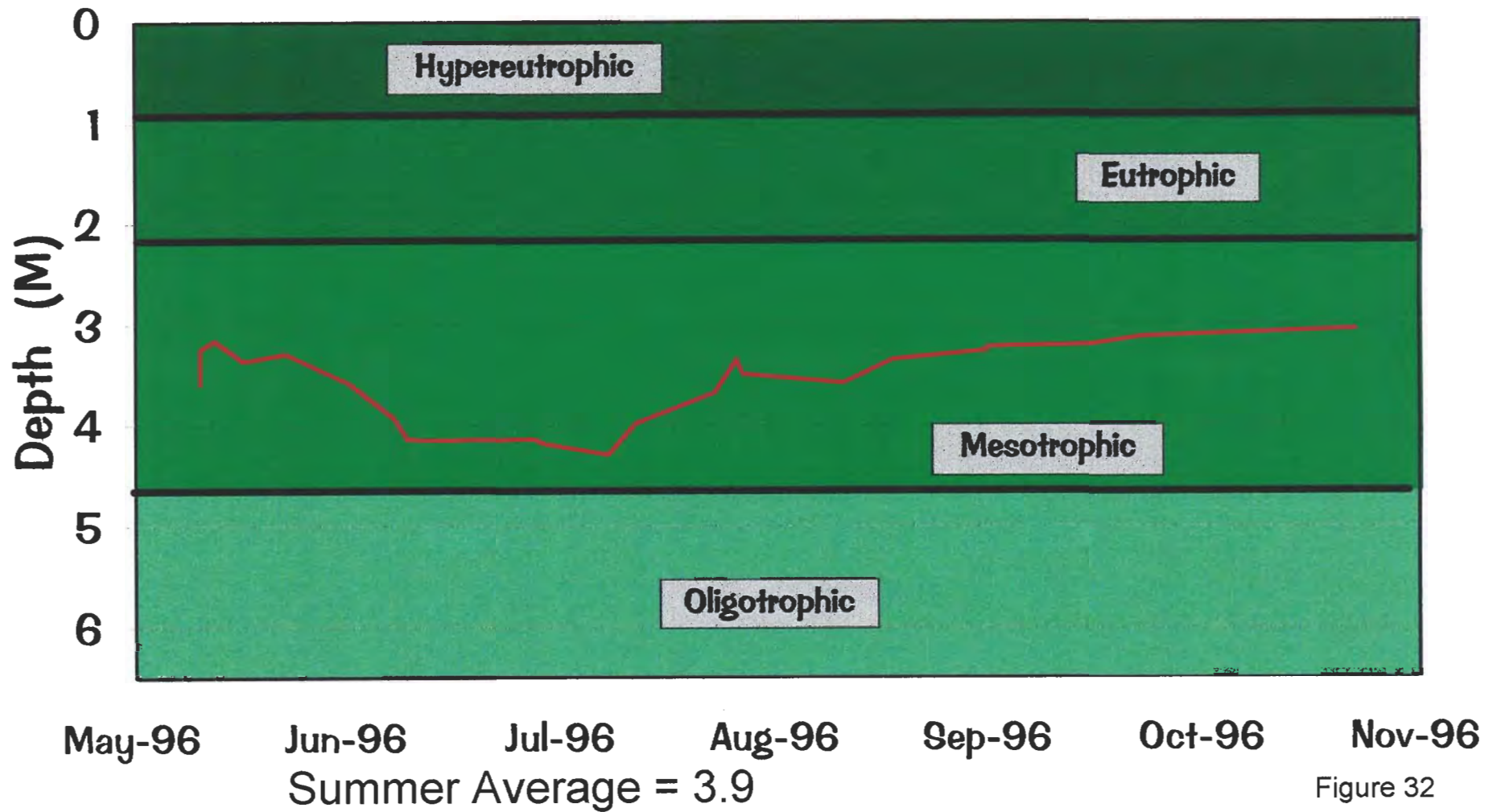

Figure 32

LCO Lake: 1996 Secchi Disc Readings Station G (Grindstone Bay)

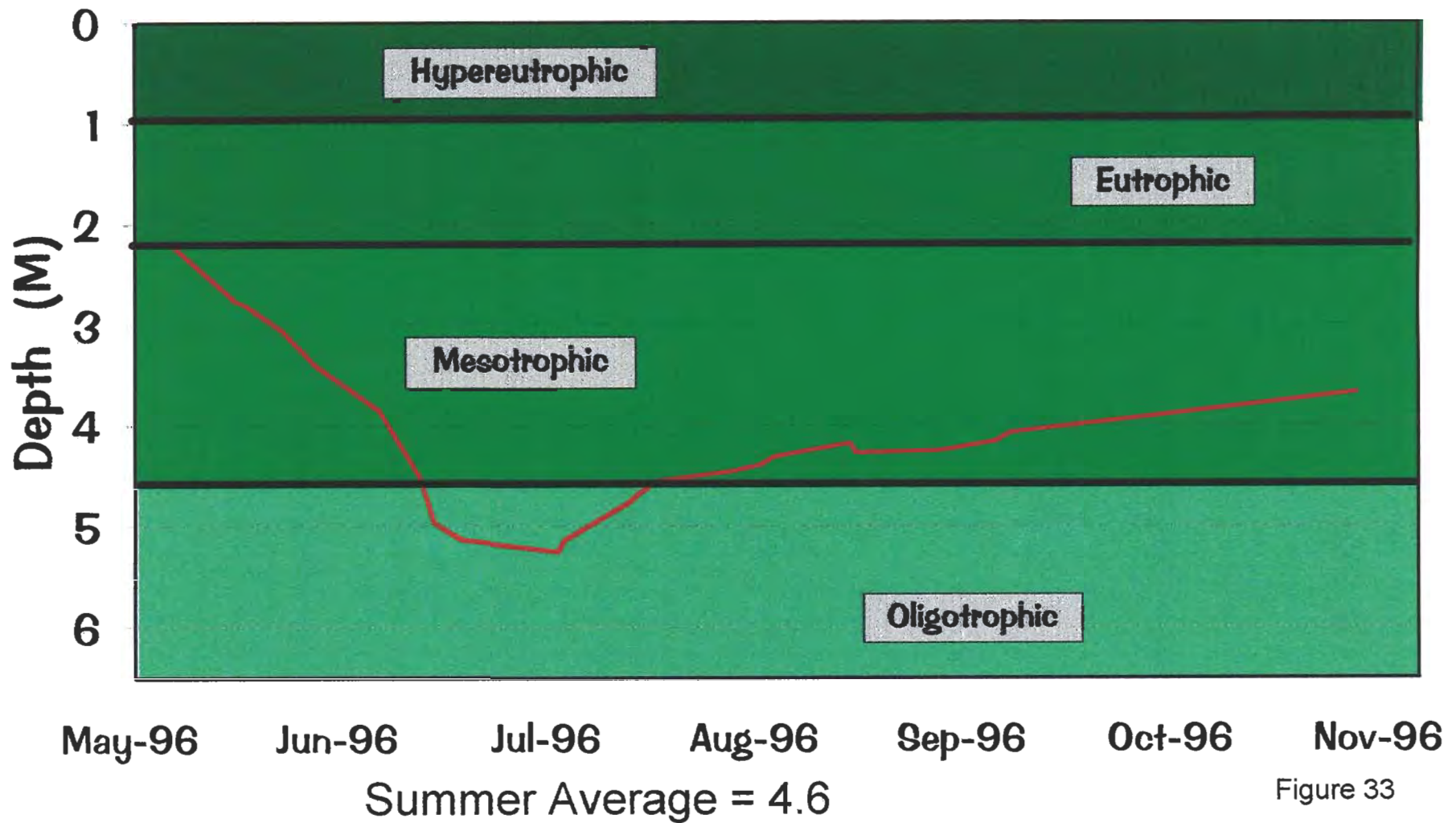

Figure 33

LCO Lake: 1996 Secchi Disc Readings Station H (Northeast Bay)

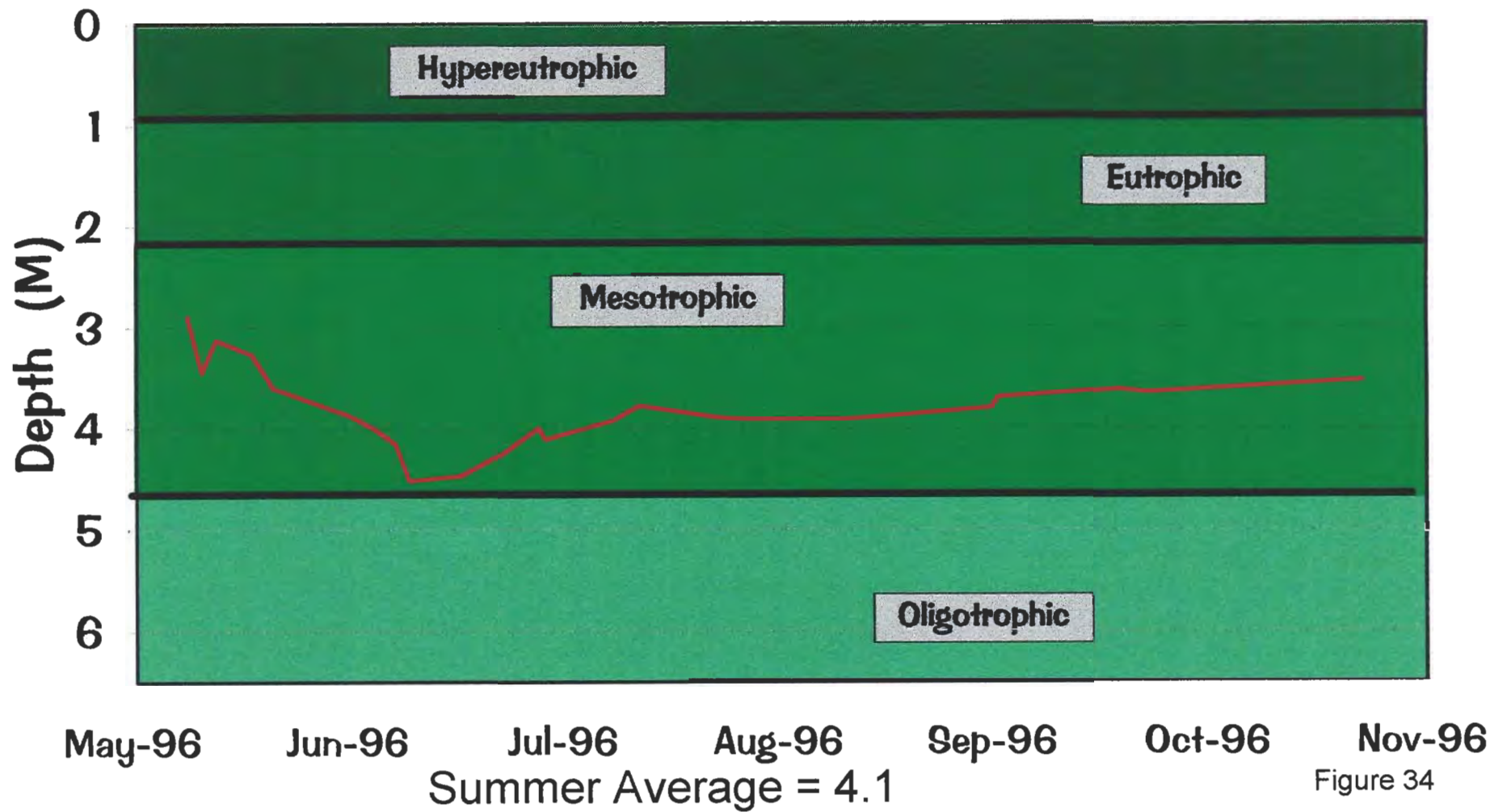

Figure 34

LCO Lake: 1996 Secchi Disc Readings Station D (Musky Bay)

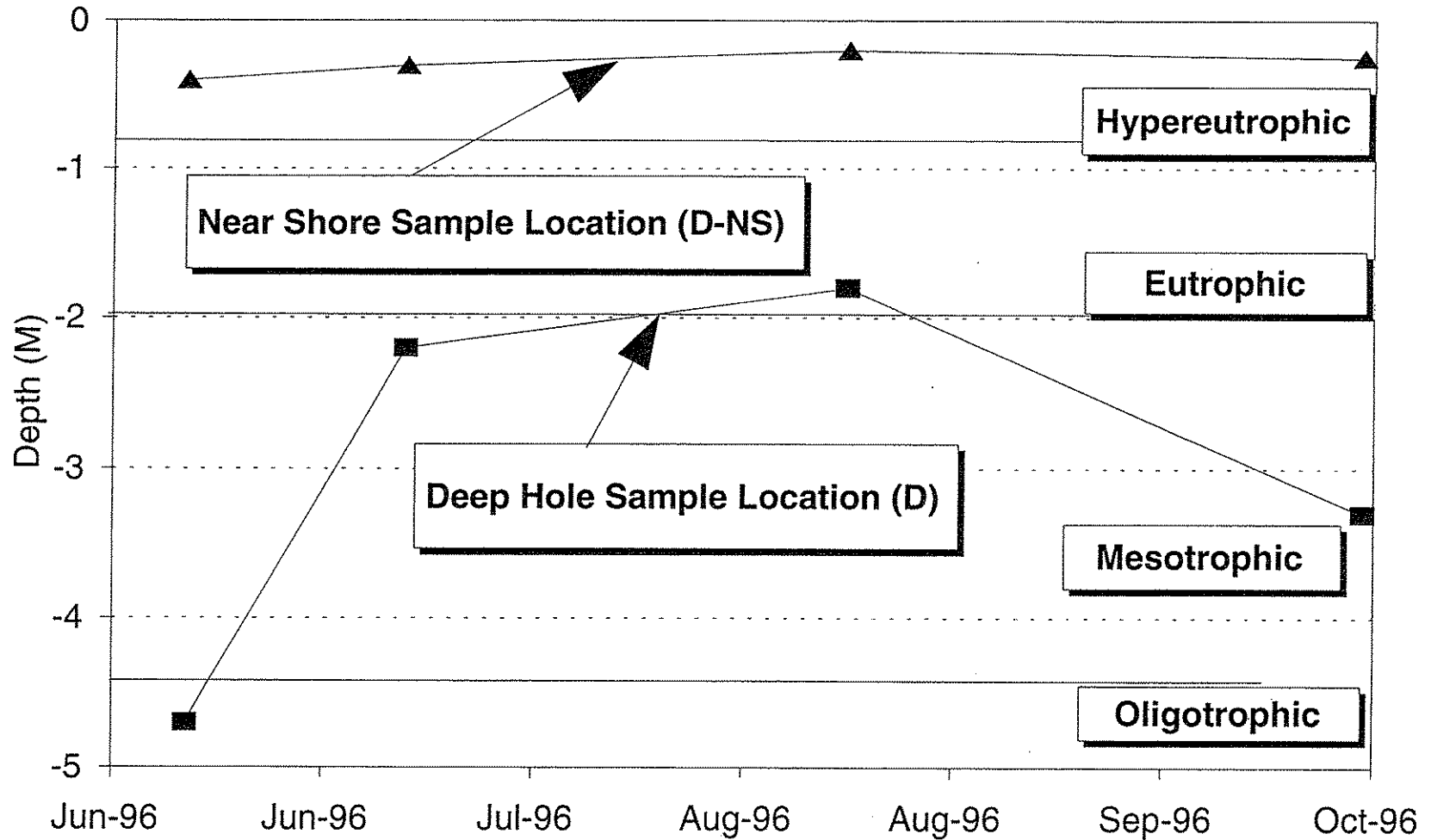

Figure 35

5.2.4 Temperature, Dissolved Oxygen, Total Dissolved Solids, and Specific Conductance Isoleth Diagrams

Isoleth diagrams represent the change in a parameter relative to depth and time.

For a given time period, vertical isopleths indicate complete mixing and horizontal isopleths indicate stratification.

Isoleth diagrams are useful for showing patterns with depth and time when sufficient depth profile data are available. Isoleth diagrams of temperature, dissolved oxygen, total dissolved solids, and specific conductance were prepared for all basins. The temperature isopleth diagrams (Figures 36-43) indicate the deep basins of Lac Courte Oreilles (i.e., Basins A, B, and C, see Figure 5) mixed completely during the spring and fall (i.e., same temperature from surface to lake bottom) and were stratified throughout the summer period (i.e., temperature layers from surface to lake bottom). Basin D (i.e., Musky Bay) exhibited weak stratification during the late summer period. All other basins were mixed throughout the sampling period (i.e., same temperature from surface to lake bottom).

The dissolved oxygen isopleth diagrams (Figures 44-51) show dissolved oxygen concentrations of bottom waters were near zero

- during much of the summer period at Basin C;
- during the late summer period at Basin B.

Oxygen depletion of the bottom waters reduces the available habitat for organisms (e.g., fish and zooplankton). A dissolved oxygen concentration of 5.0 mg/L is considered the minimum desirable level for fish. Oxygen concentrations of 5 mg/L or larger were observed from the lake's surface to at least the 12 meter depth throughout the sampling period at Basins A, B, and C. However, the bottom waters (i.e., profundal zone) had insufficient oxygen for the support of fish. Oxygen concentrations of 5.0 mg/L or larger were observed throughout the monitoring period in all bay areas, except Basin D (i.e., Musky Bay). The bottom waters of Basin D had insufficient oxygen to support fish during late June and early August.

Oxygen depletion of the bottom waters may result in the addition of phosphorus, a process known as internal loading. When the bottom waters become anoxic (i.e., the dissolved oxygen concentration is less than 0.5 mg/L), the chemical conditions in the water change. Consequently, phosphorus that had remained bound to the sediments reenters the water.

The period of oxygen depletion in the hypolimnion of Basins B and C matches the period of apparent internal phosphorus loading. Internal loading is indicated by elevated levels of total dissolved solids and specific conductance in the hypolimnion waters of Basins B and C (See total dissolved solids and specific conductance isopleth diagrams, Figures 52-65). All shallower bay areas (i.e., Basins D through H) observed oxygen concentrations greater than 0.5 mg/L throughout the monitoring period. No apparent internal phosphorus loading is indicated by the total dissolved solids and specific conductance isopleth diagrams of Basins D through H. Total dissolved solids and specific conductance data were not collected from Basin A (i.e., WDNR monitoring site).

Specific conductance is directly related to the amount of dissolved inorganic chemicals (minerals, nutrients, metals, and other inorganic chemicals) in the water. Total dissolved solids provides another measurement of materials dissolved in the lake. Specific conductance and total dissolved solids levels are a reflection of the soils and bedrock in the lake's watershed. They also indicate the level of internal loading occurring within a lake. Lakes with higher specific conductance and total dissolved solids are more productive waters, capable of supporting more aquatic plants and animals. Higher levels also indicate a poorer water quality.

LCO Lake Temperature Isopleths (C) Station A (Deep Hole - DNR)

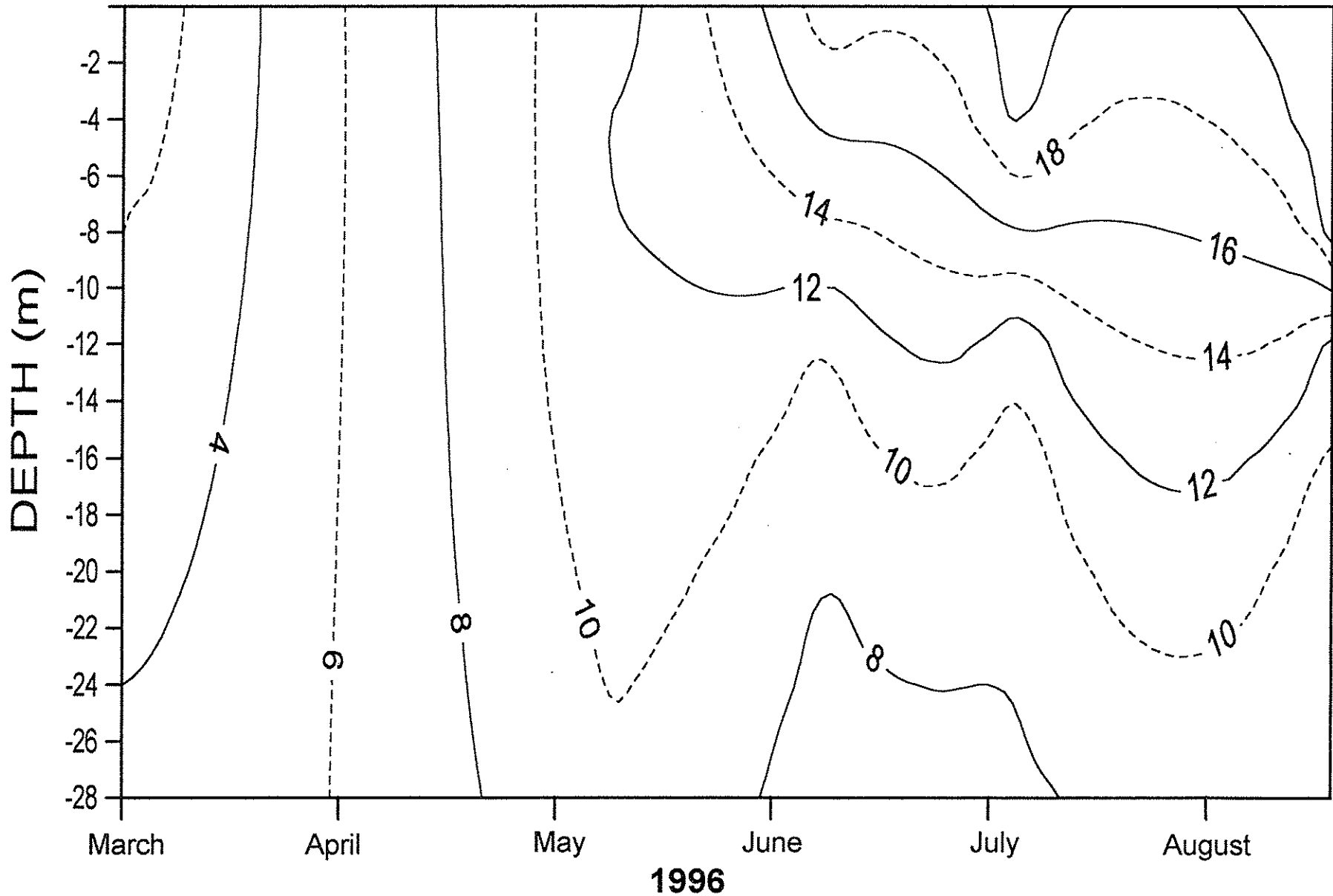

65

Figure 36

LCO Lake Temperature Isopleths (C) Station B (West Hole)

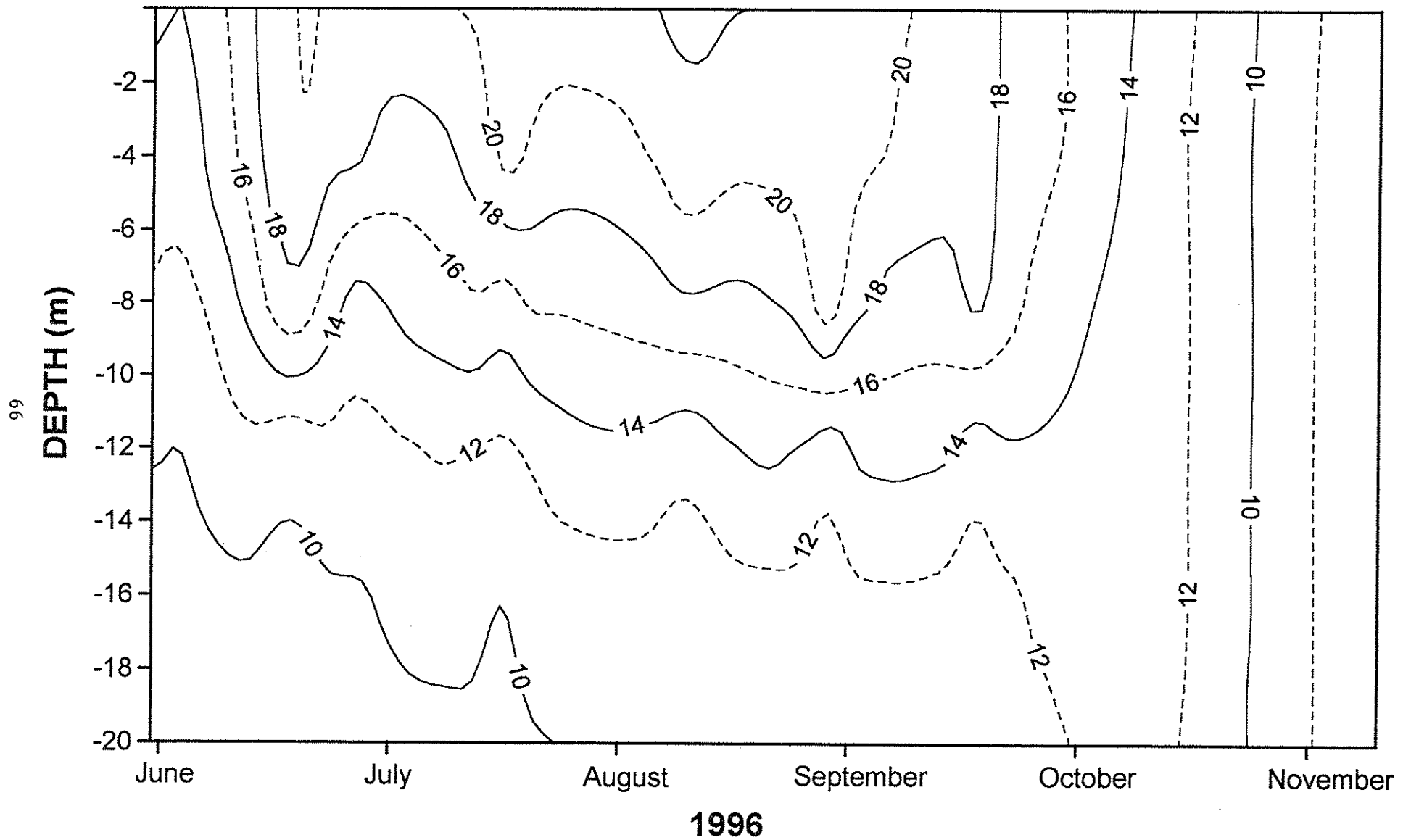

Figure 37

LCO Lake Temperature Isopleths (C) Station C (Central Hole)

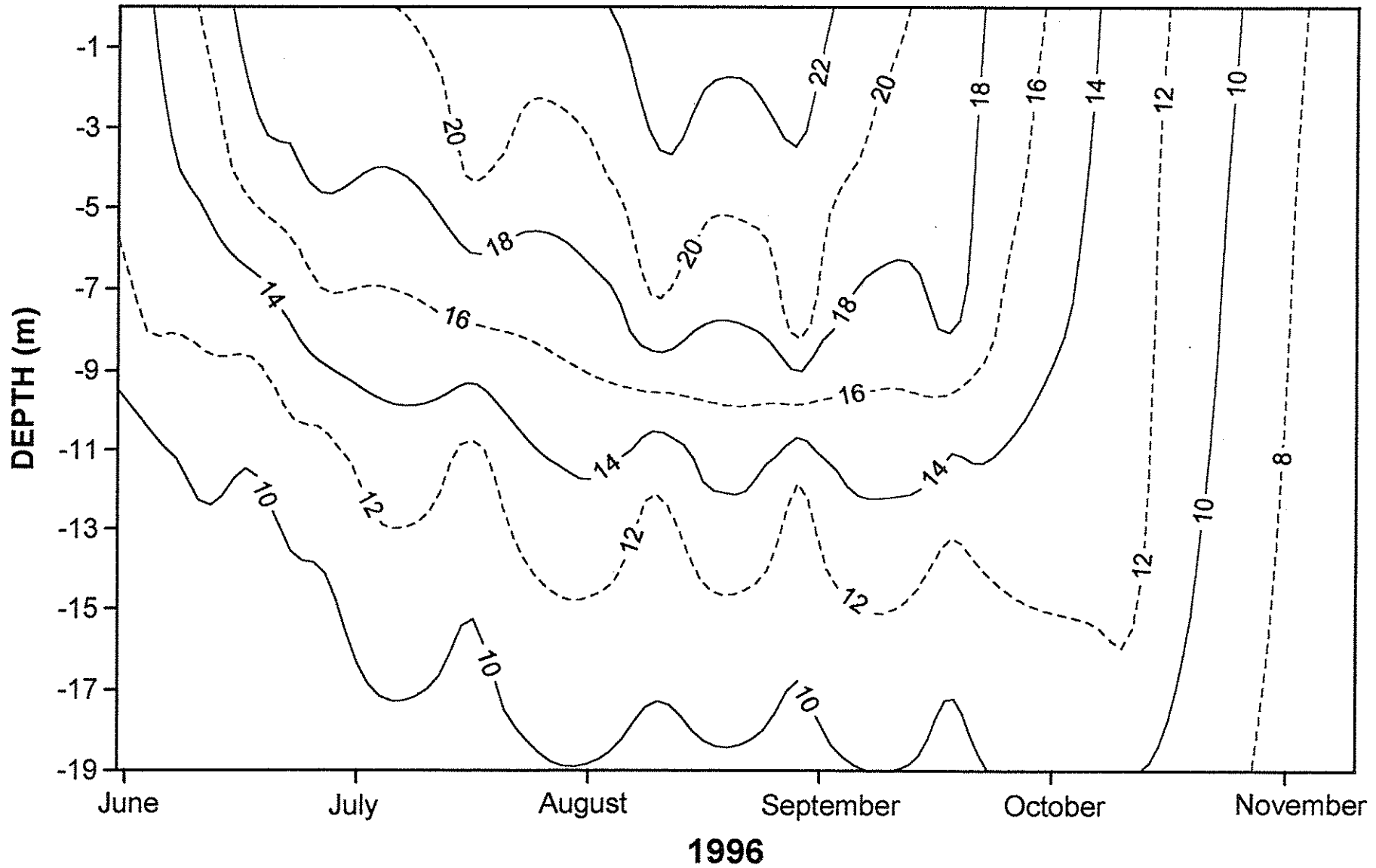

Figure 38

LCO Lake Temperature Isopleths (C) Station D (Musky Bay)

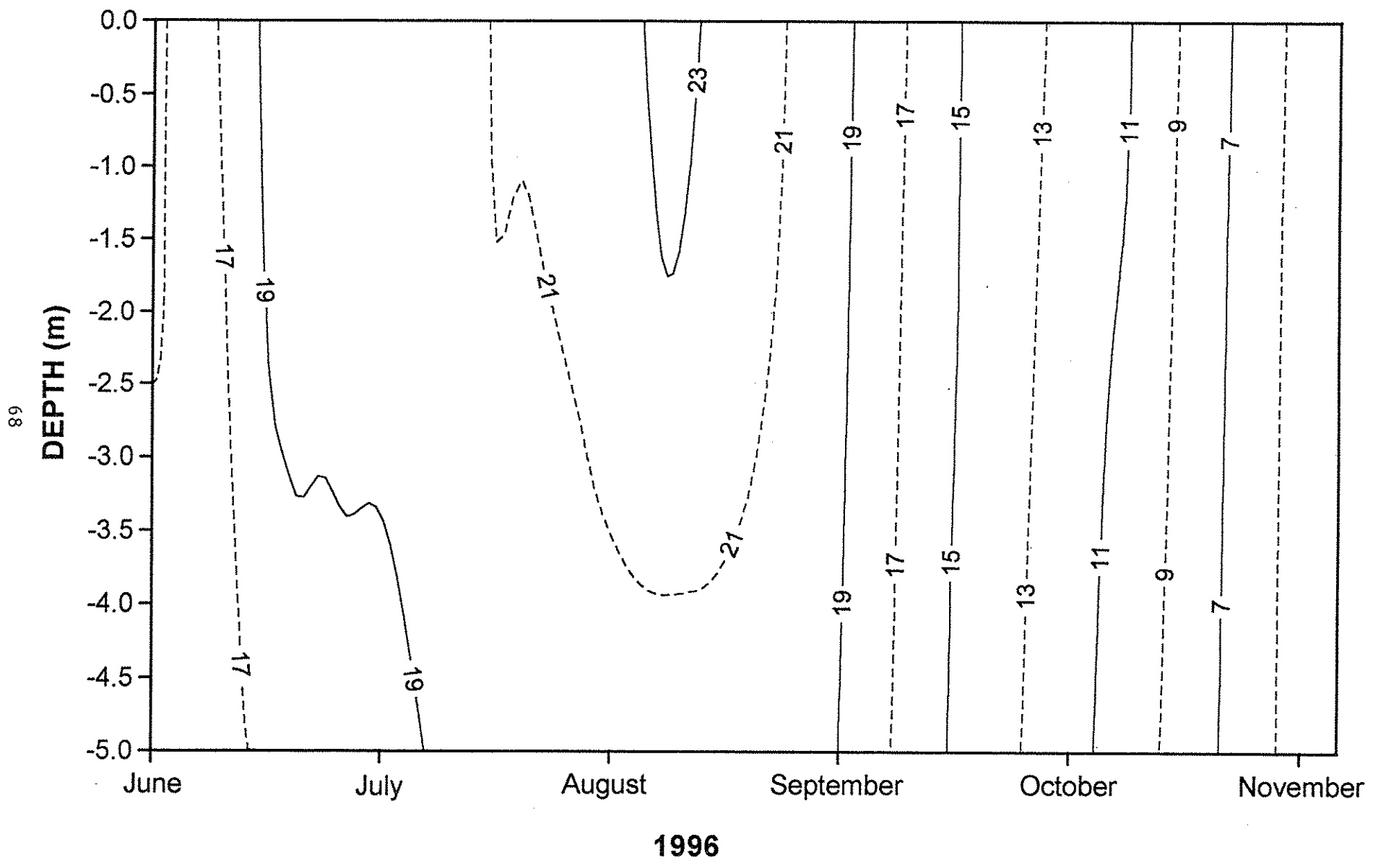

Figure 39

LCO Lake Temperature Isopleths (C) Station E (Stukey Bay)

69

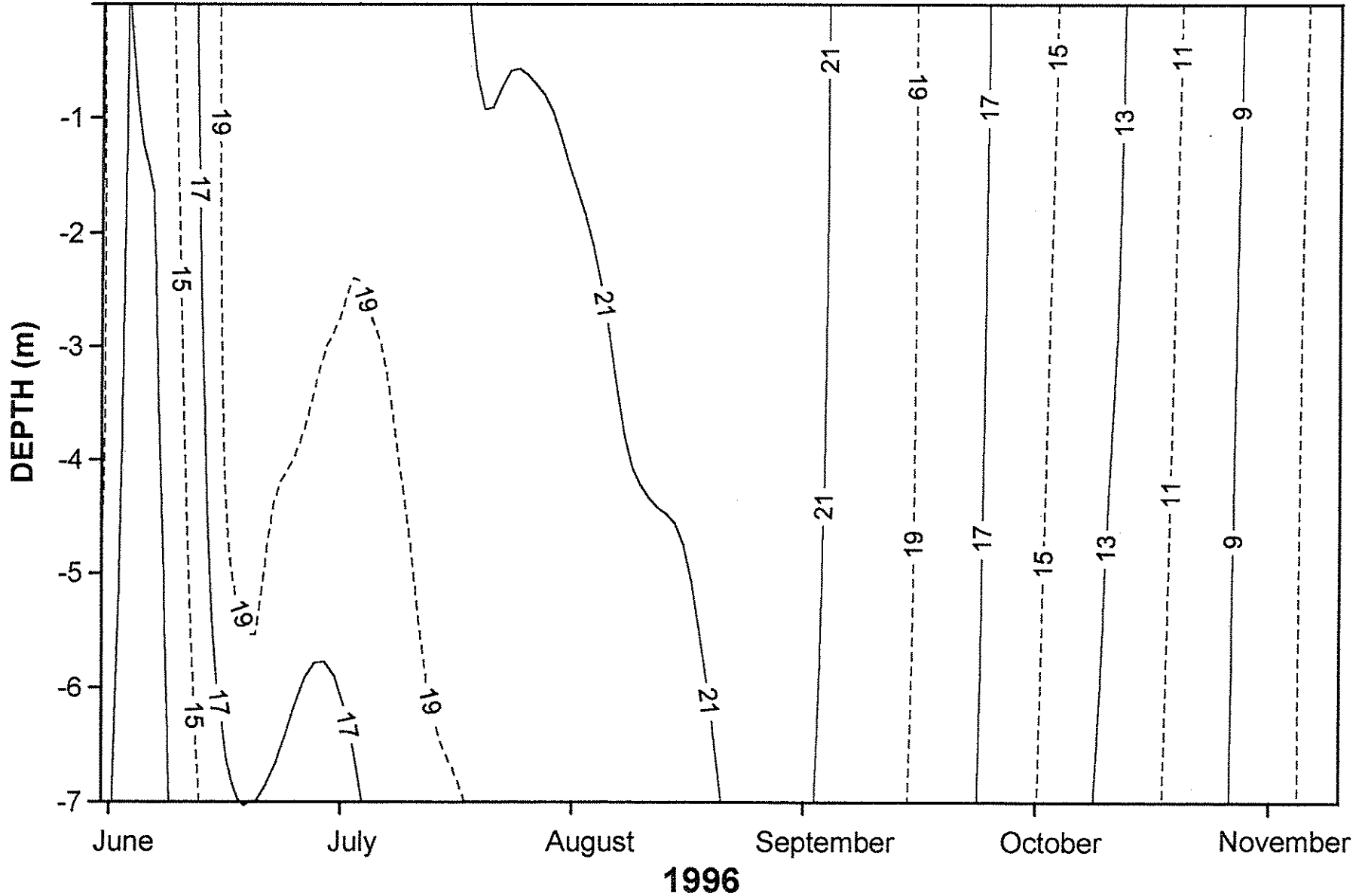

Figure 40

LCO Lake Temperature Isopleths (C) Station F (Chicago Bay)

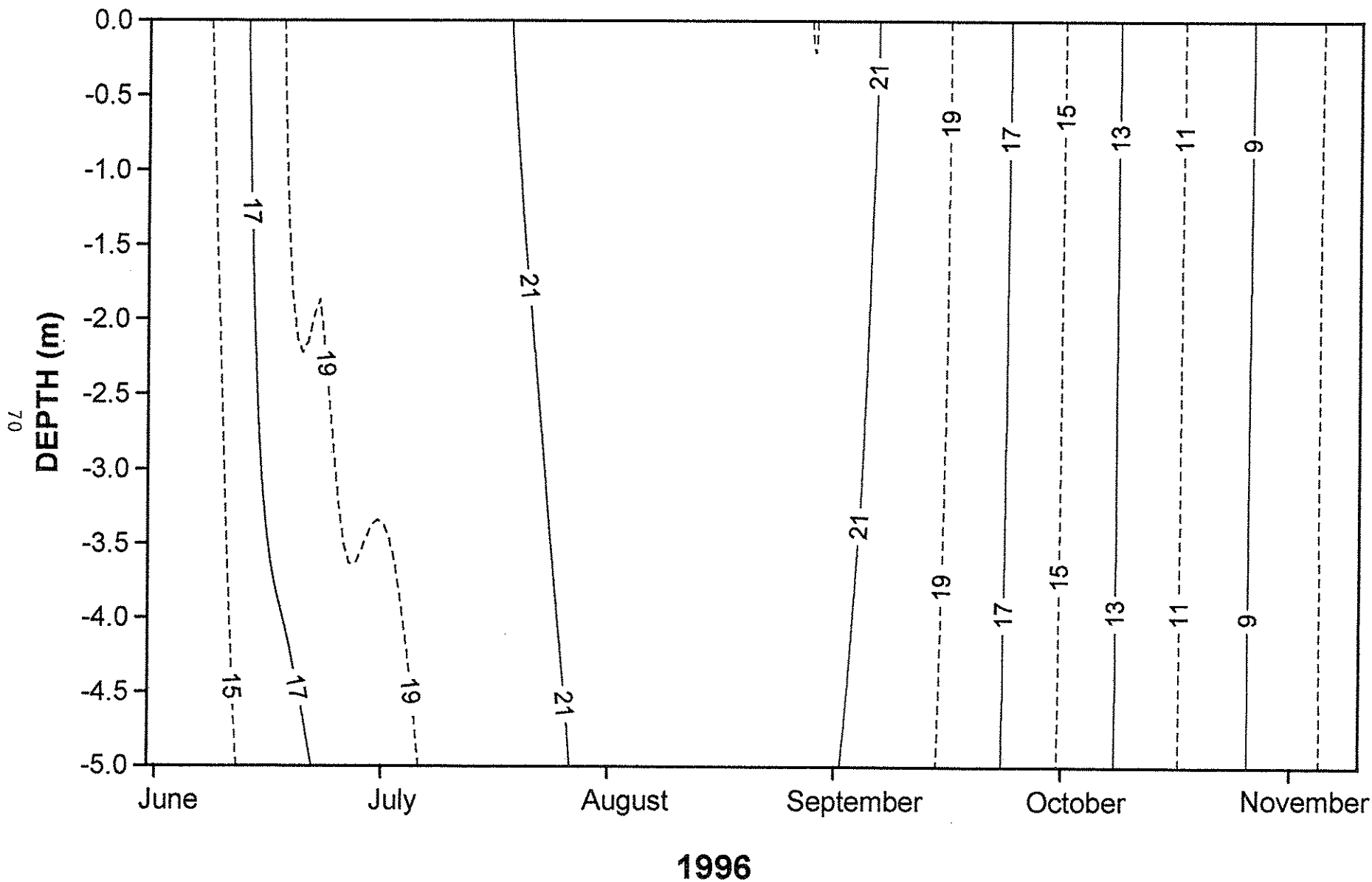

Figure 41

LCO Lake Temperature Isopleths (C) Station G (Grindstone Bay)

71

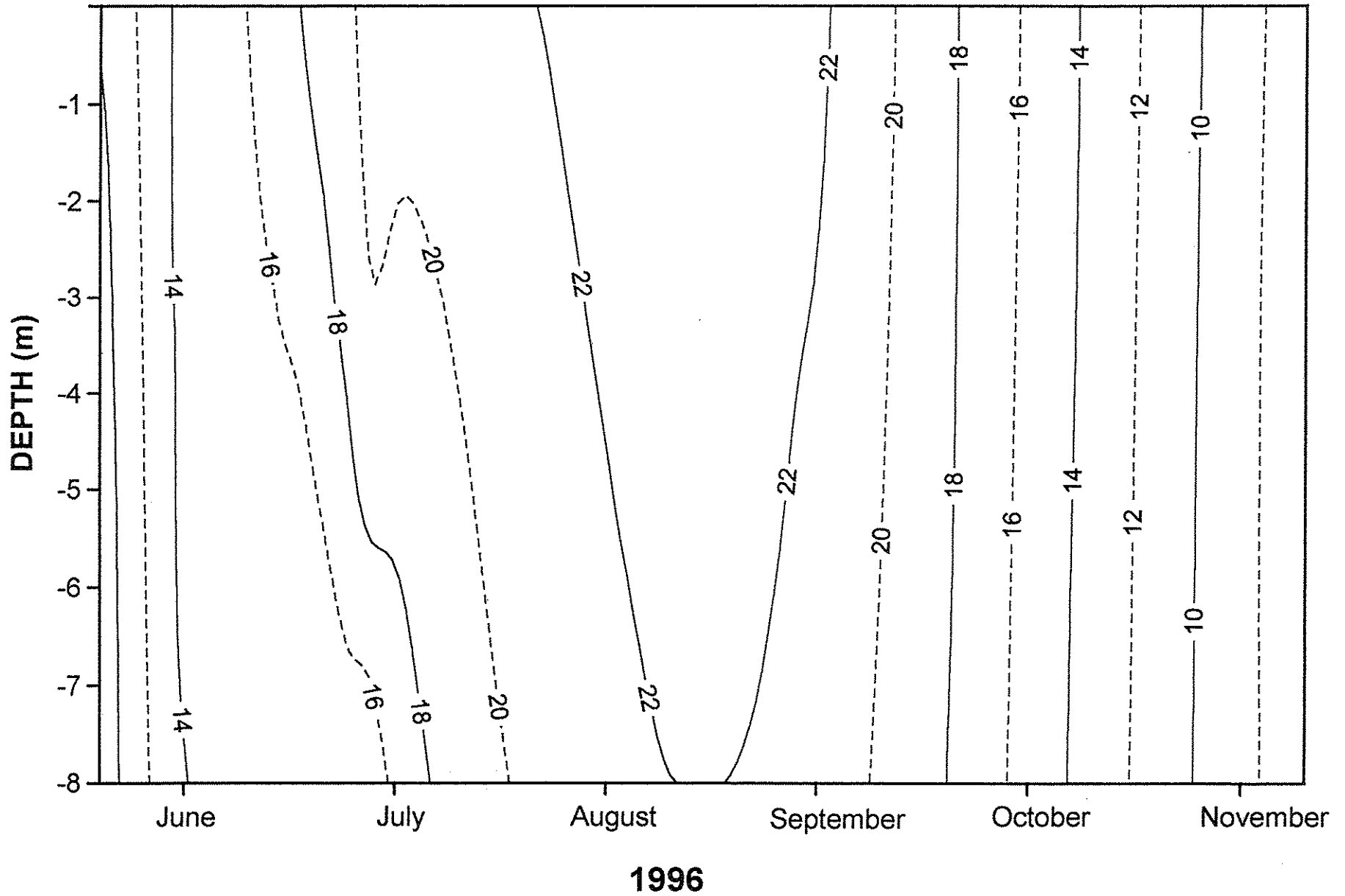

Figure 42

LCO Lake Temperature Isopleths (C) Station H (Northeast Bay)

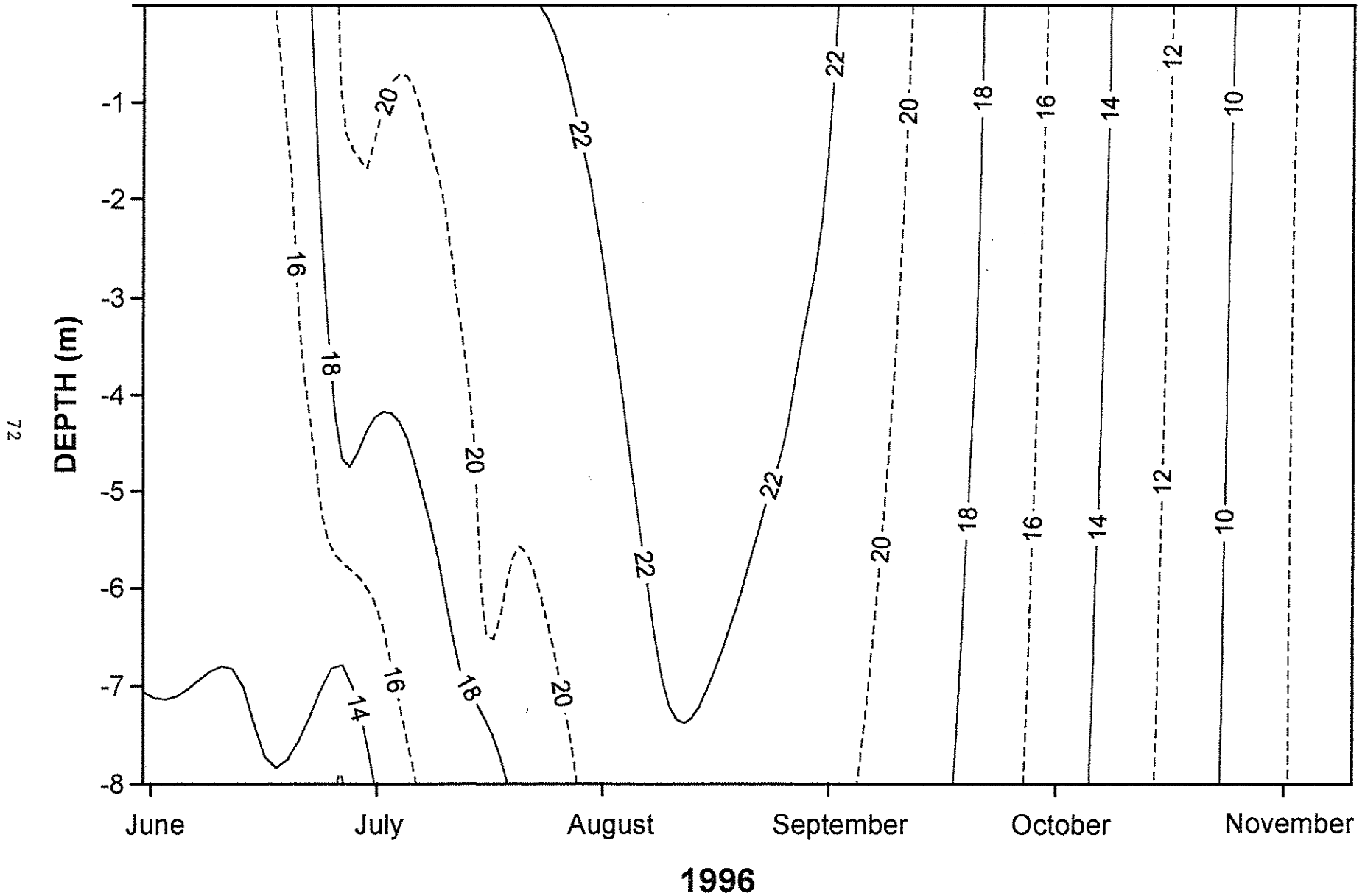

Figure 43

LCO Lake Dissolved Oxygen Isopleths (mg/L) Station A (Deep Hole - DNR)

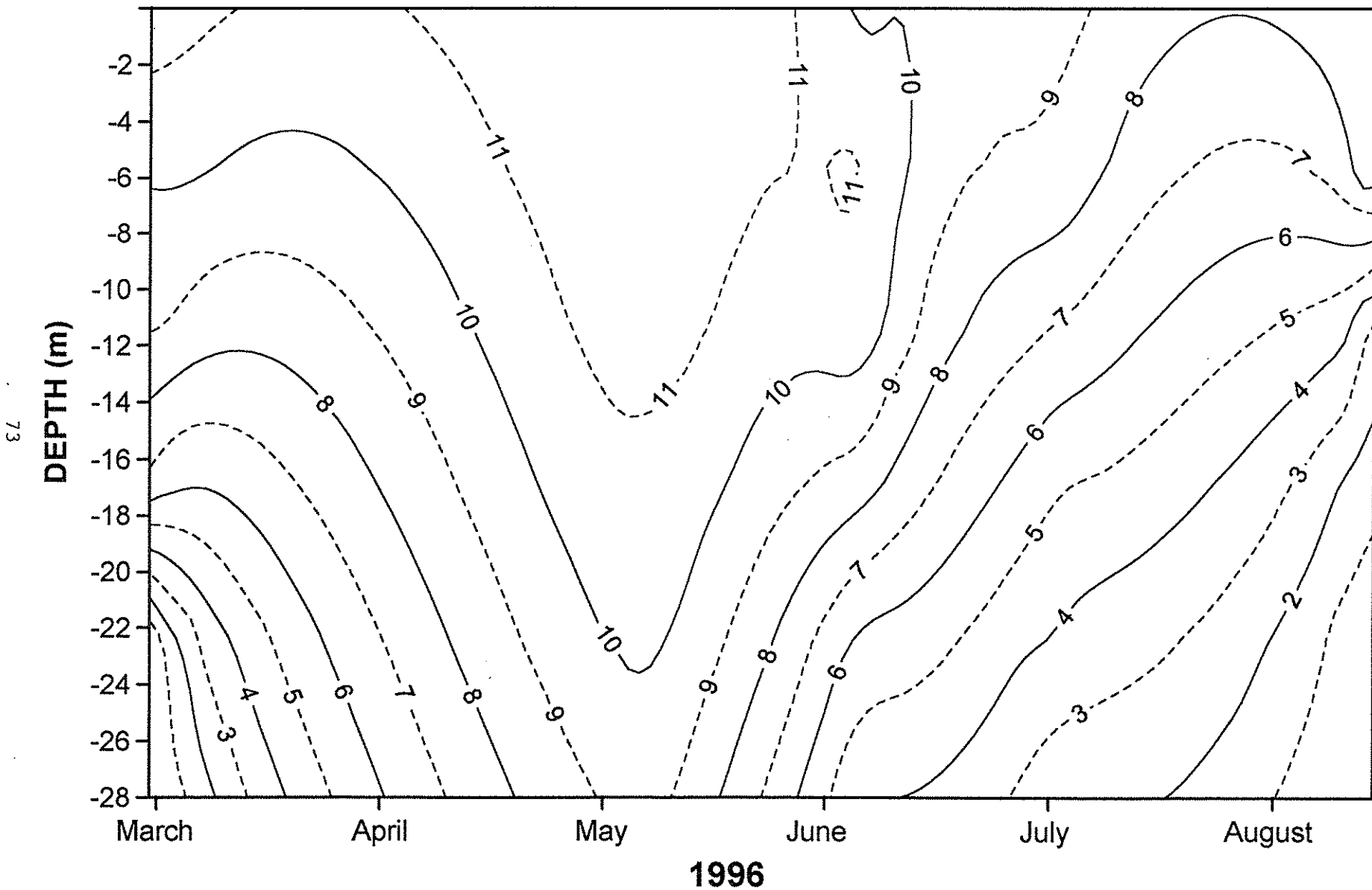

Figure 44

LCO Lake Dissolved Oxygen Isopleths (mg/L) Station B (West Hole)

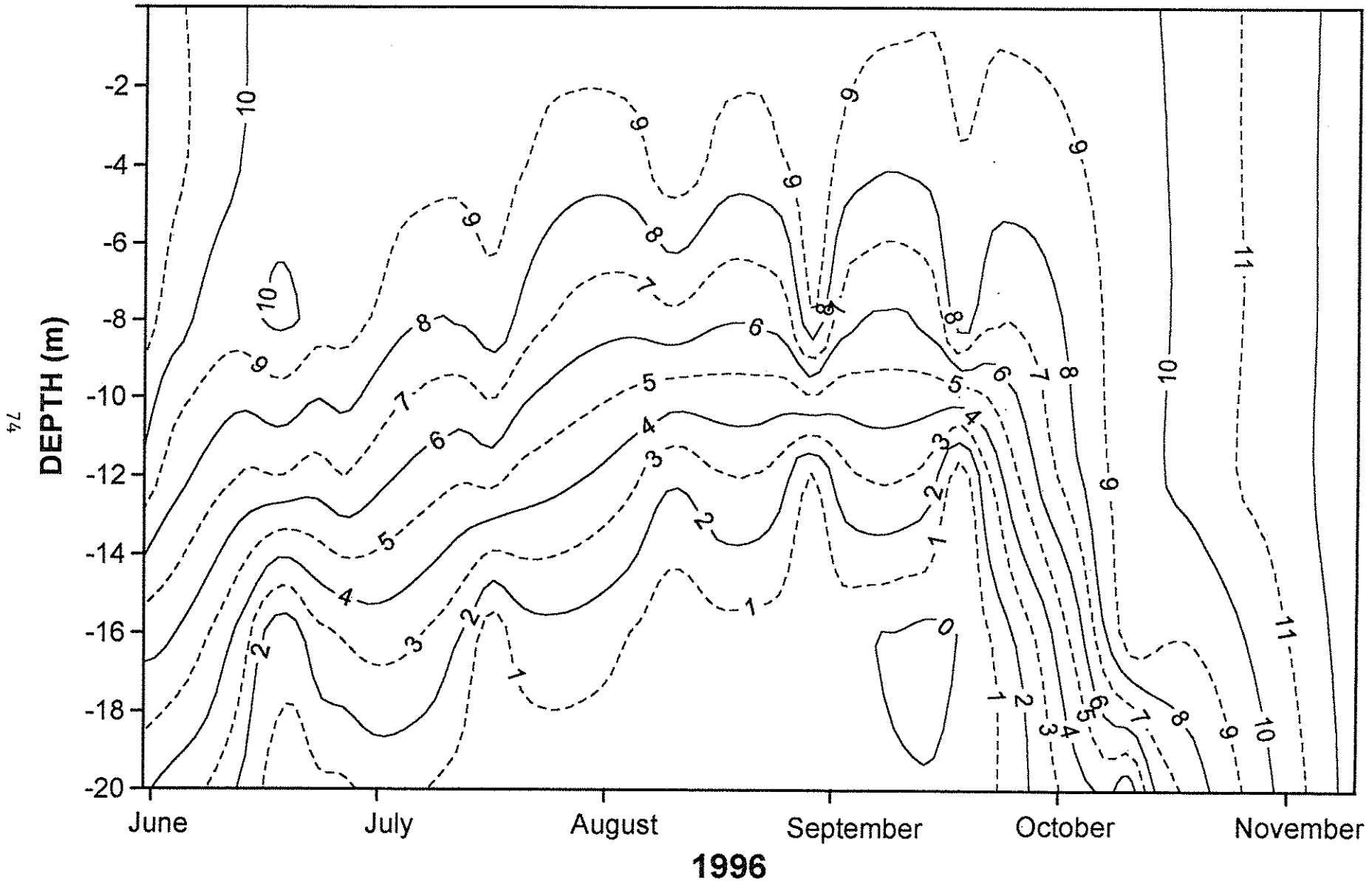

Figure 45

LCO Lake Dissolved Oxygen Isopleths (mg/L) Station C (Center Hole)

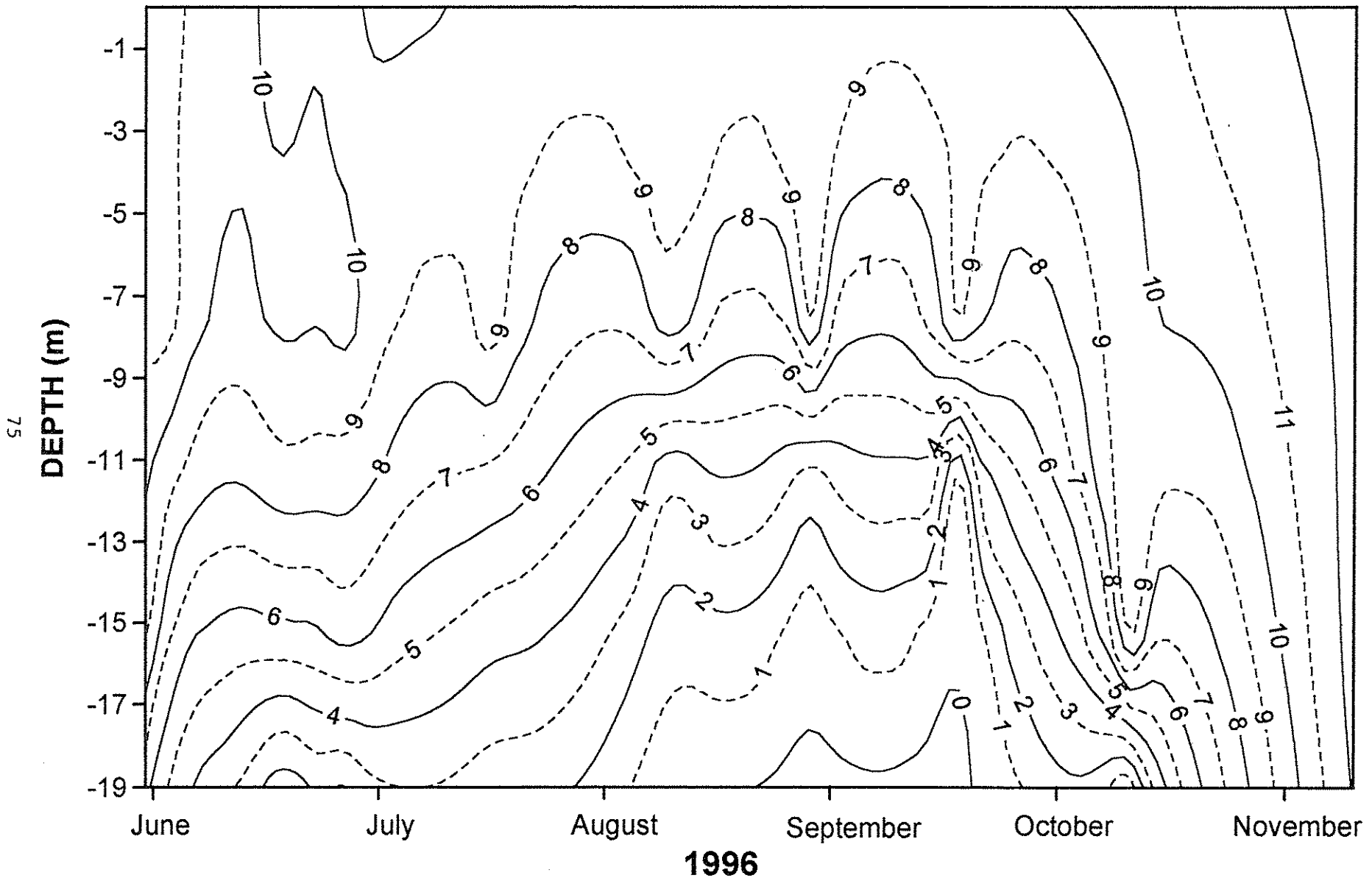

Figure 46

LCO Lake Dissolved Oxygen Isopleths (mg/L) Station D (Musky Bay)

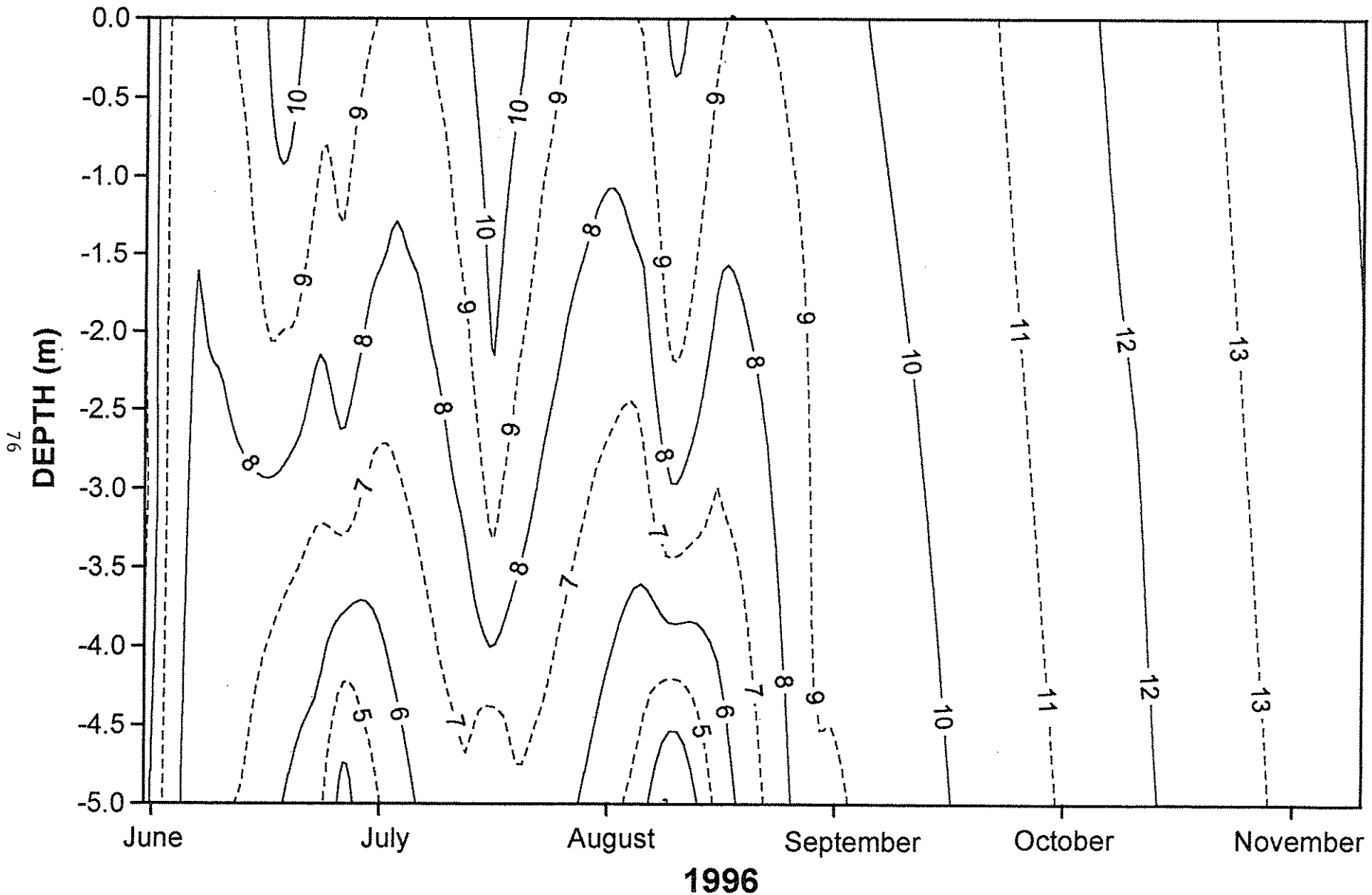

Figure 47

LCO Lake Dissolved Oxygen Isopleths (mg/L) Station E (Stukey Bay)

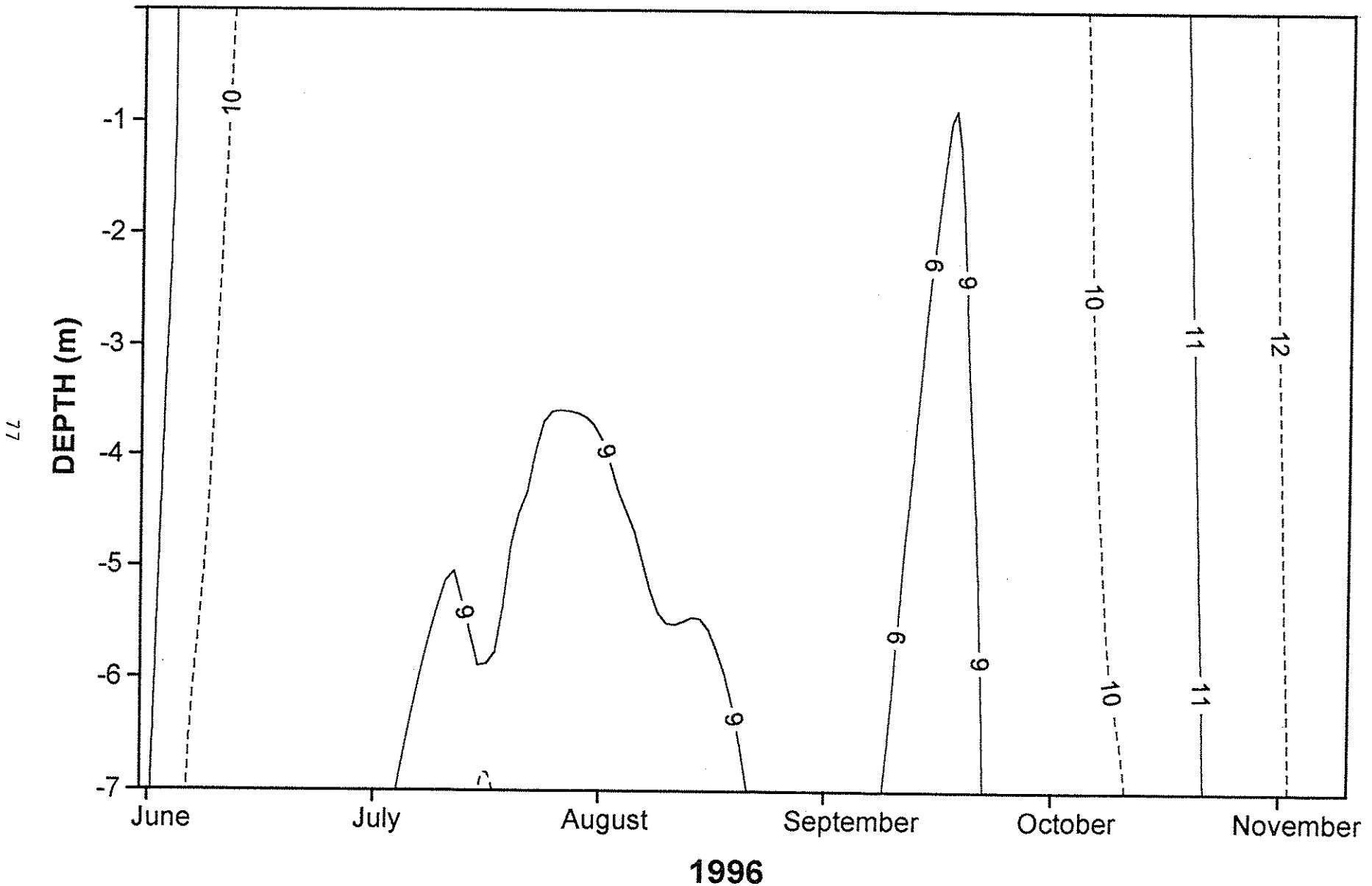

Figure 48

LCO Lake Dissolved Oxygen Isopleths (mg/L) Station F (Chicago Bay)

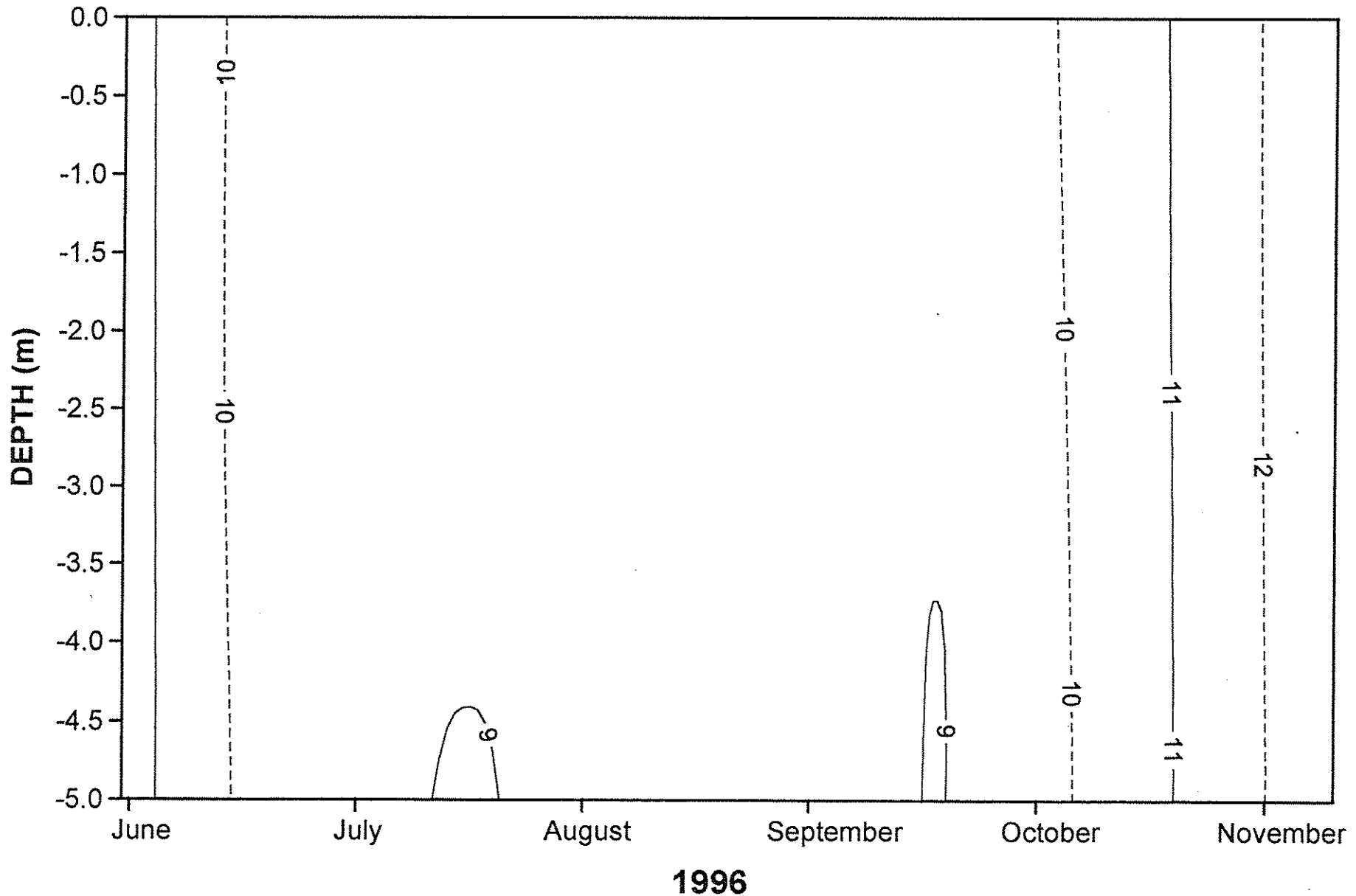

Figure 49

LCO Lake Dissolved Oxygen Isopleths (mg/L) Station G (Grindstone Bay)

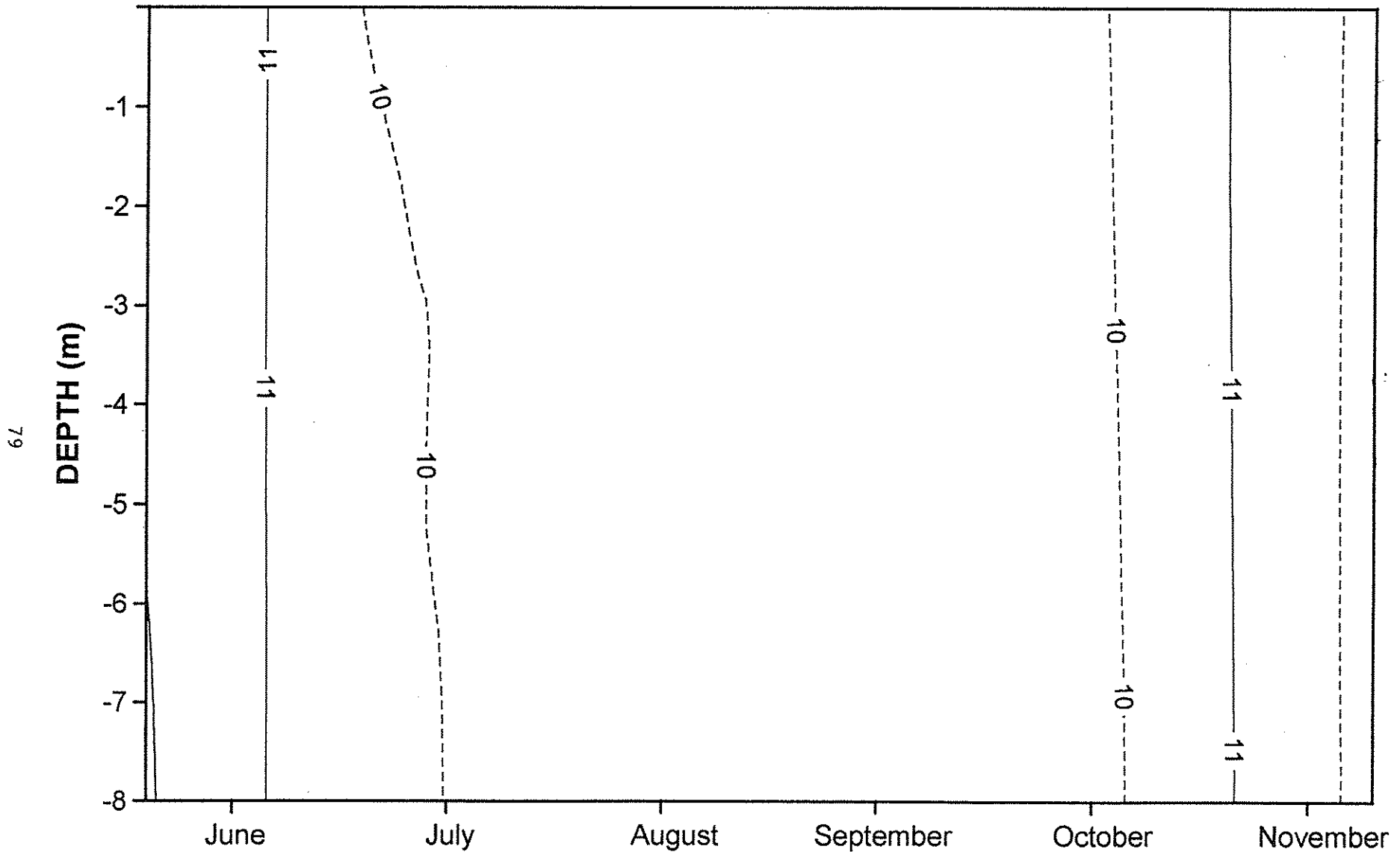

Figure 50

LCO Lake Dissolved Oxygen Isopleths (mg/L) Station H (Northeast Bay)

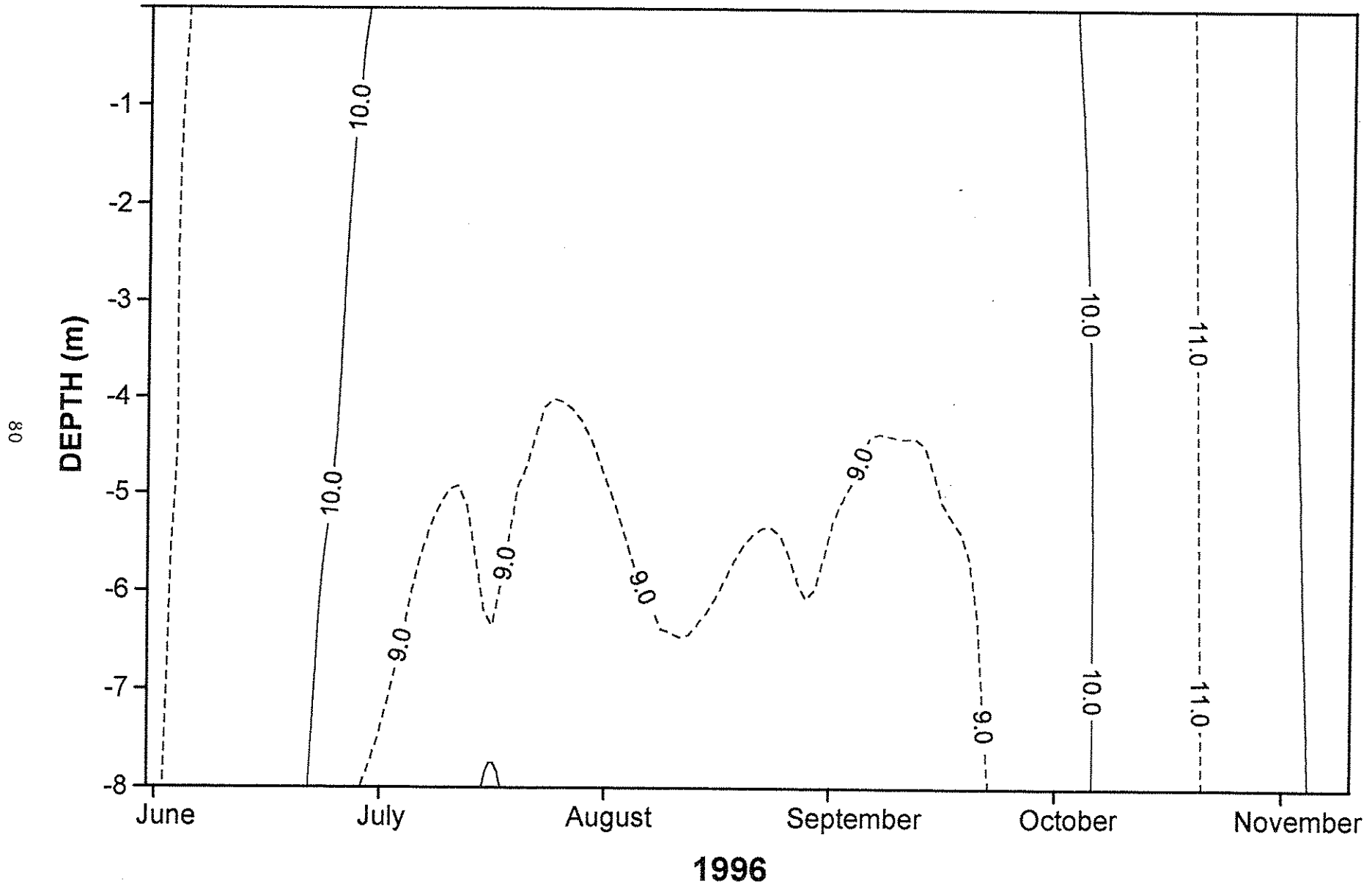

Figure 51

LCO Lake Total Dissolved Solids Isopleths (mg/L) Station B (West Hole)

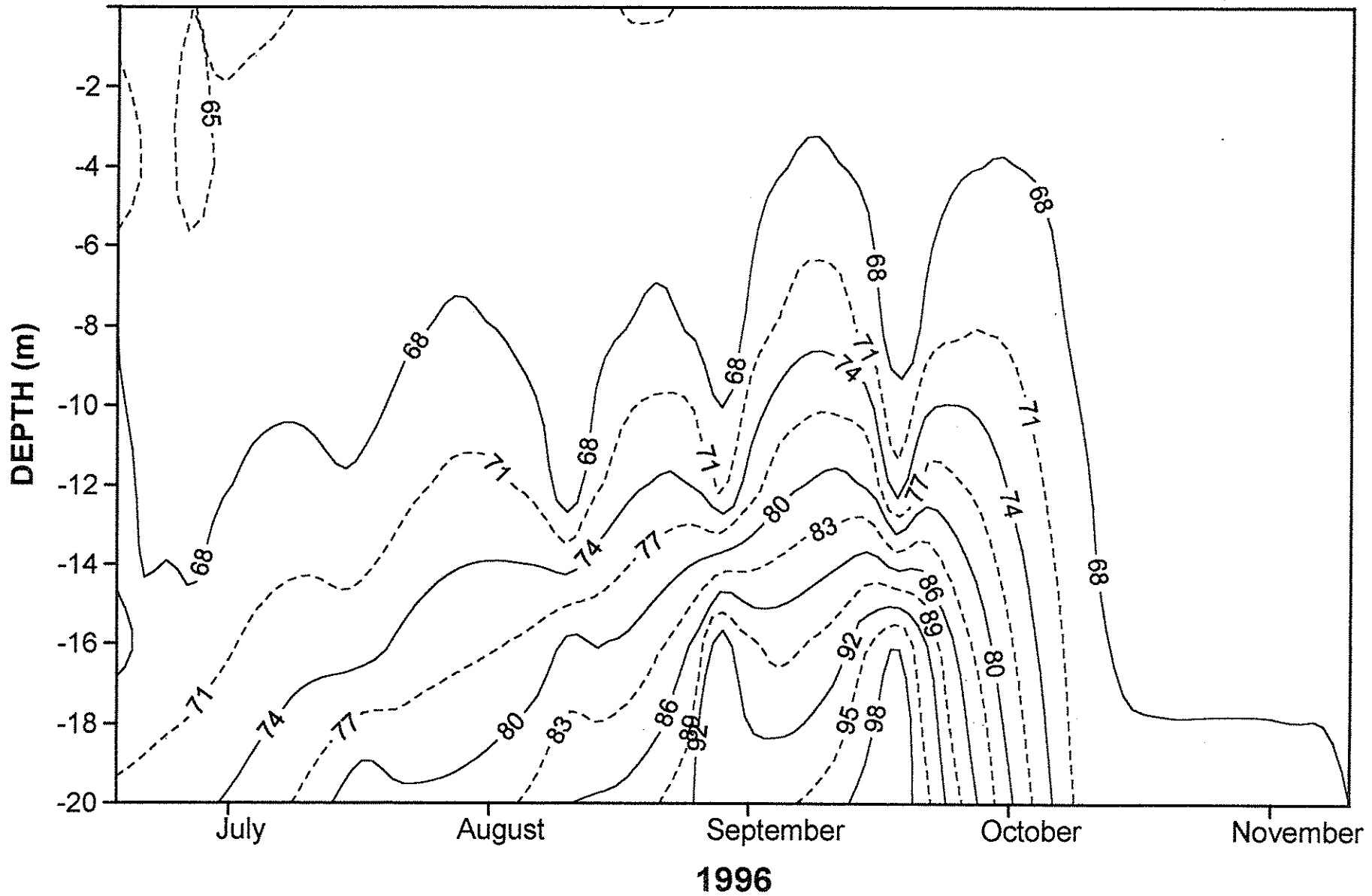
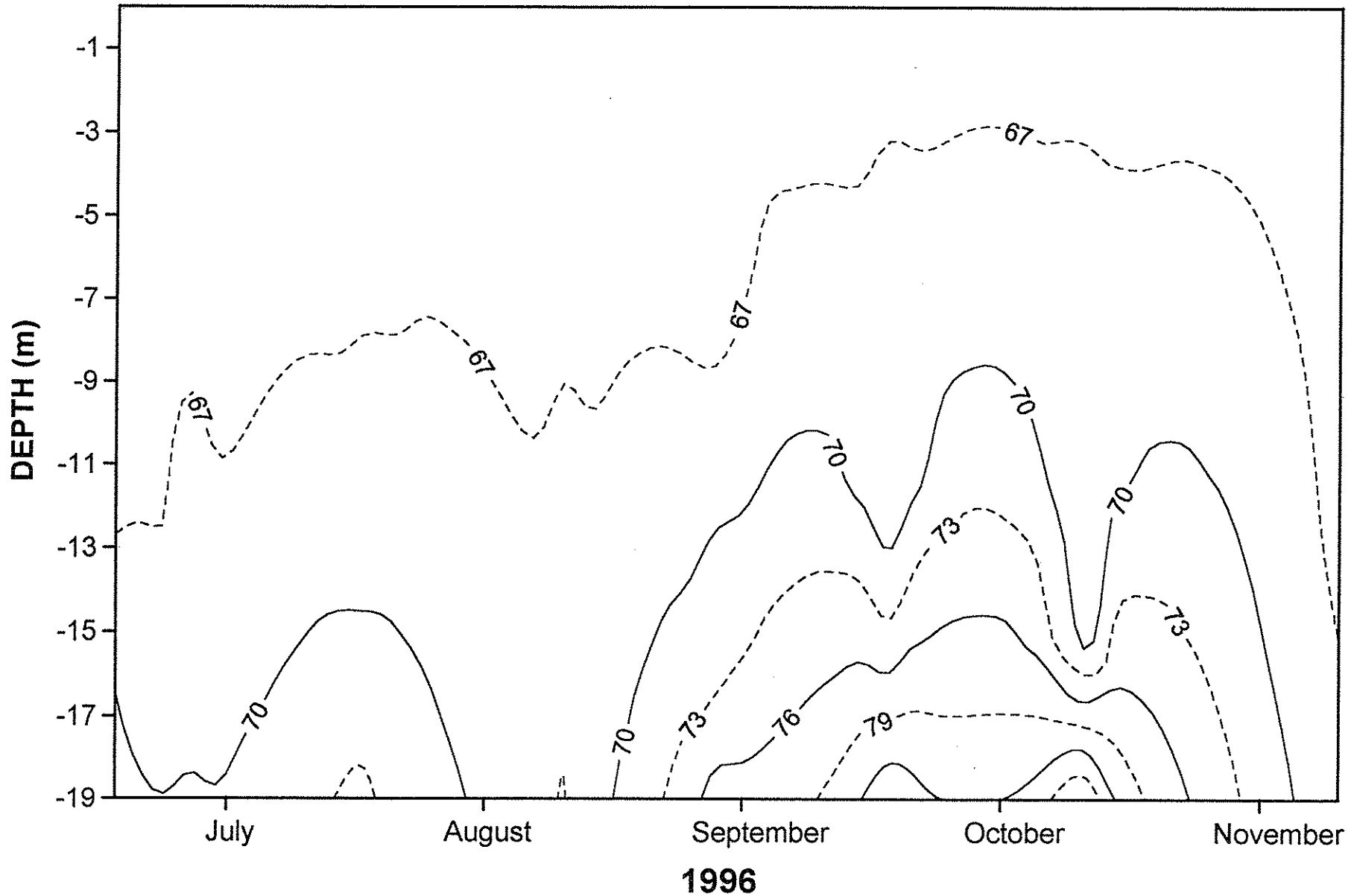

Figure 52

LCO Lake Total Dissolved Solids Isopleths (mg/L) Station C (Central Hole)



82

Figure 53

LCO Lake Total Dissolved Solids Isopleths (mg/L) Station D (Musky Bay)

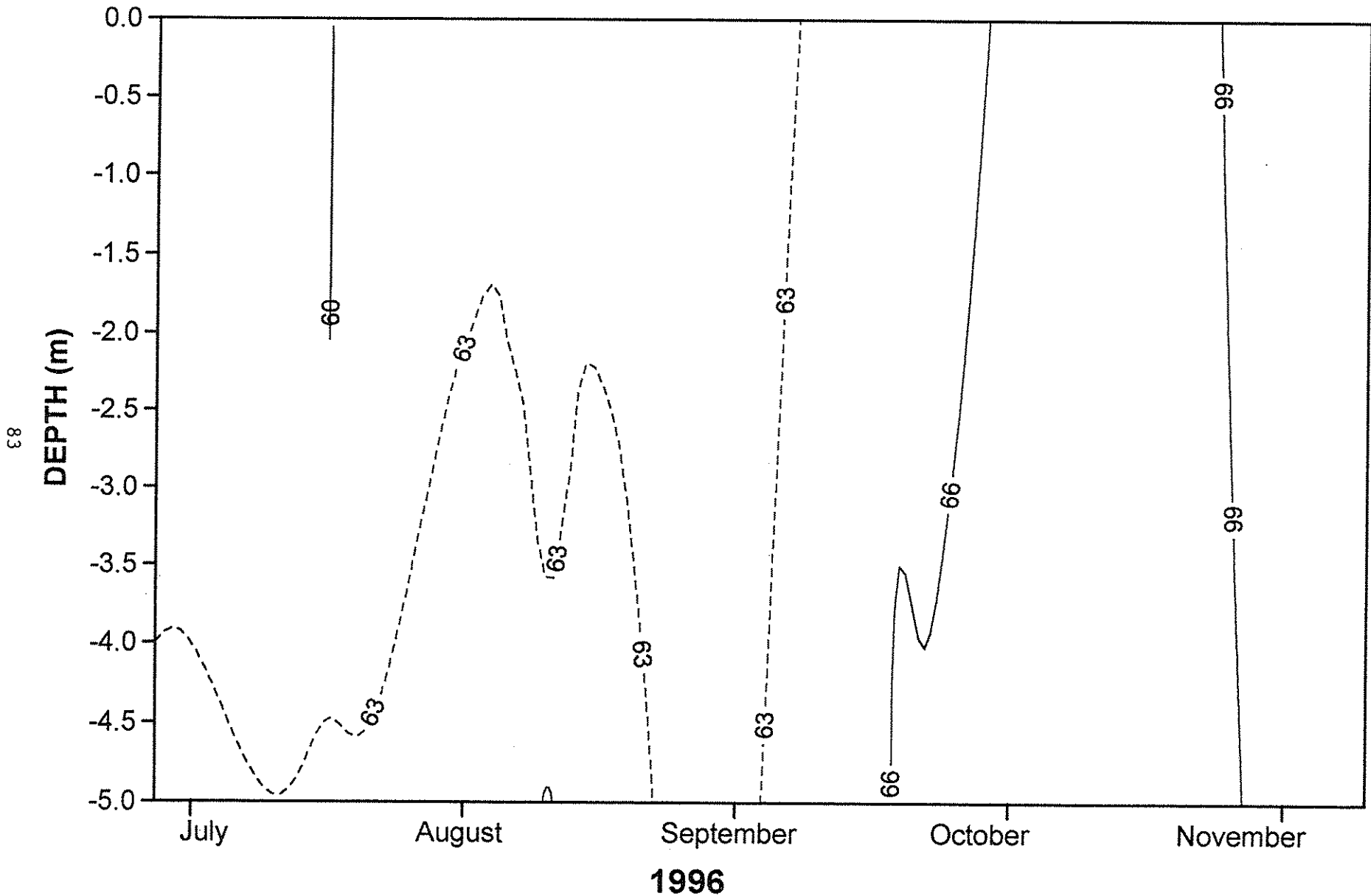

Figure 54

LCO Lake Total Dissolved Solids Isopleths (mg/L) Station E (Stukey Bay)

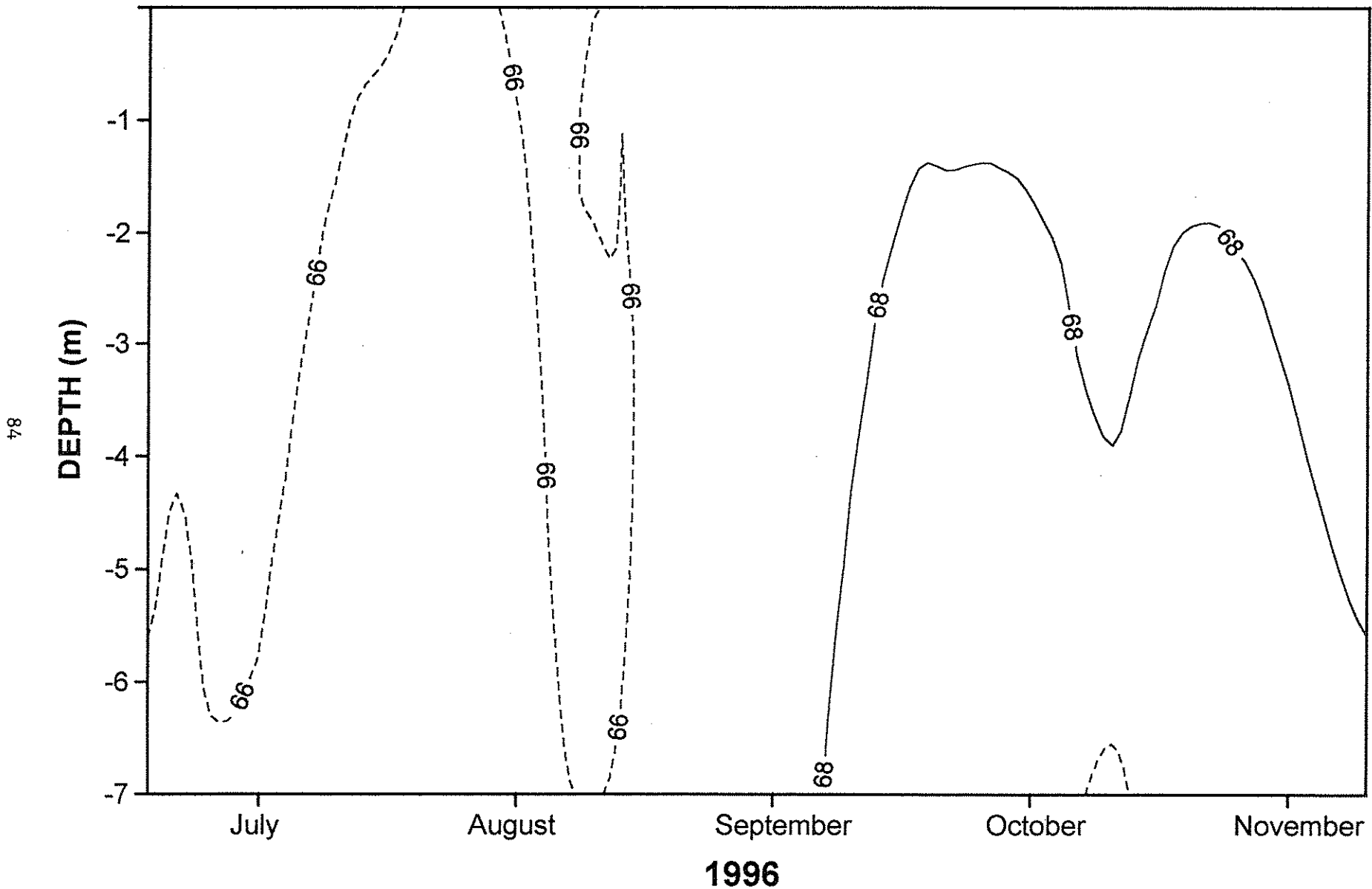

Figure 55

LCO Lake Total Dissolved Solids Isopleths (mg/L) Station F (Chicago Bay)

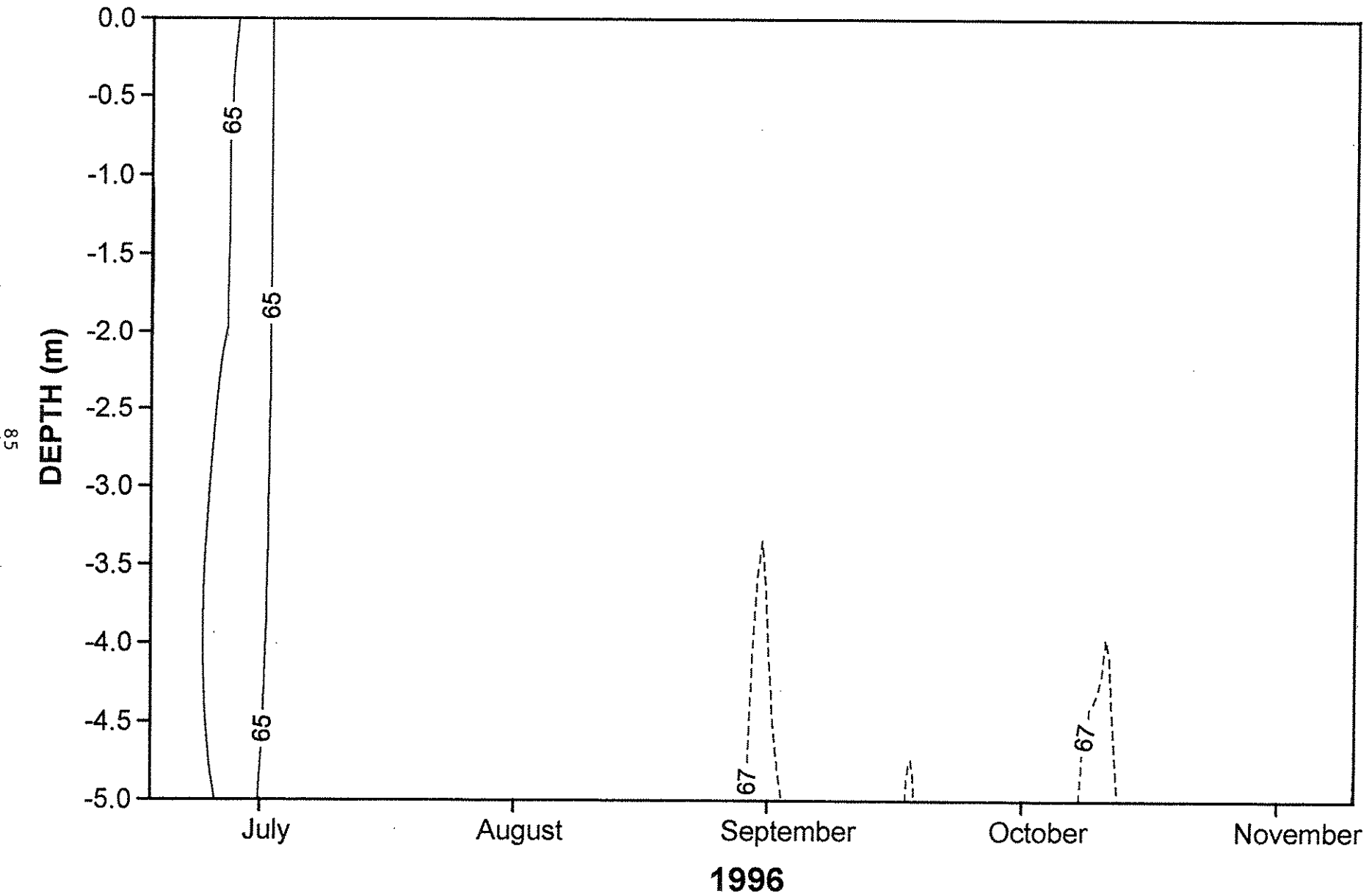

Figure 56

LCO Lake Total Dissolved Solids Isopleths (mg/L) Station G (Grindstone Bay)

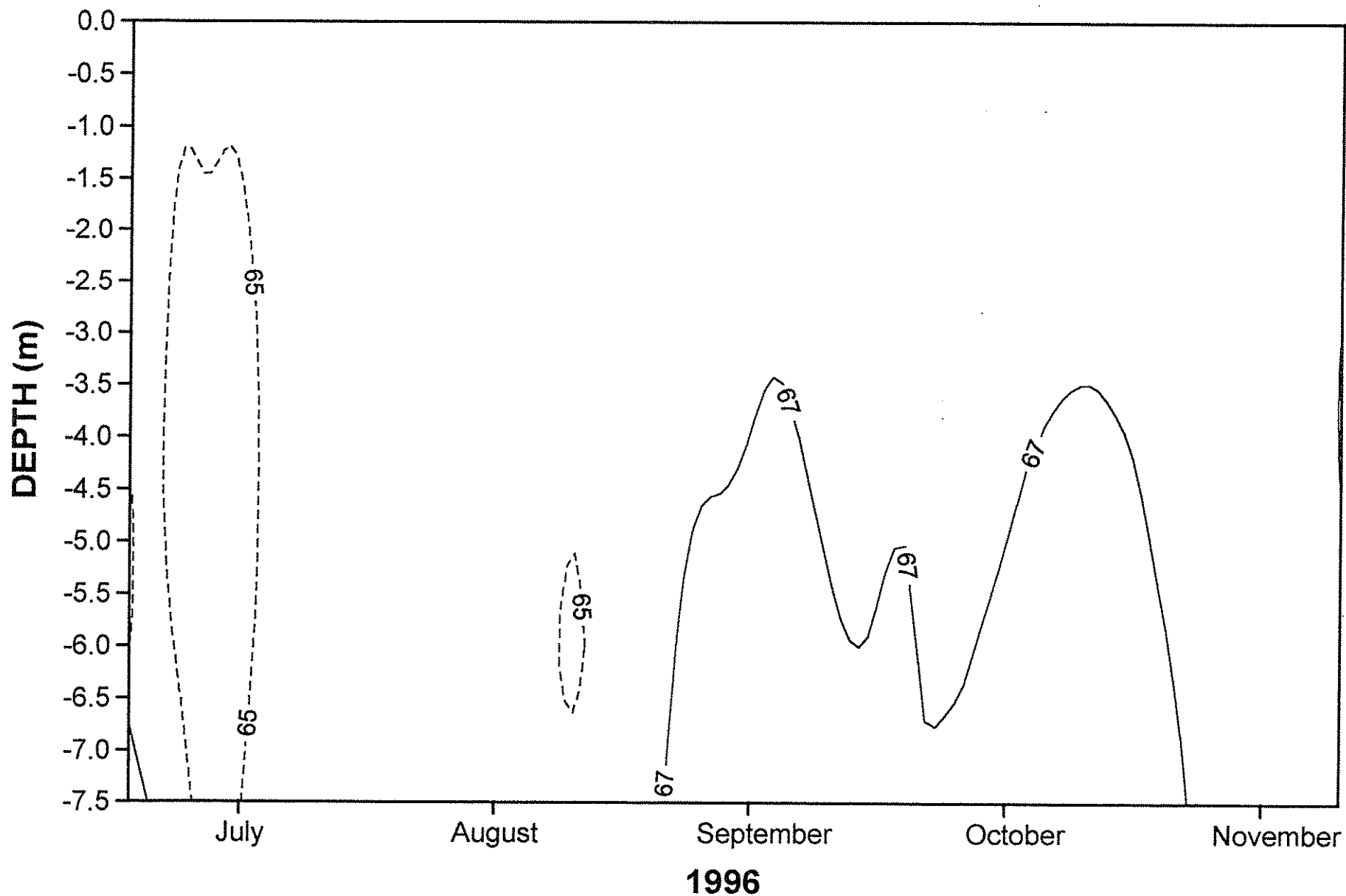

Figure 57

LCO Lake Total Dissolved Solids Isopleths (mg/L) Station H (Northeast Bay)

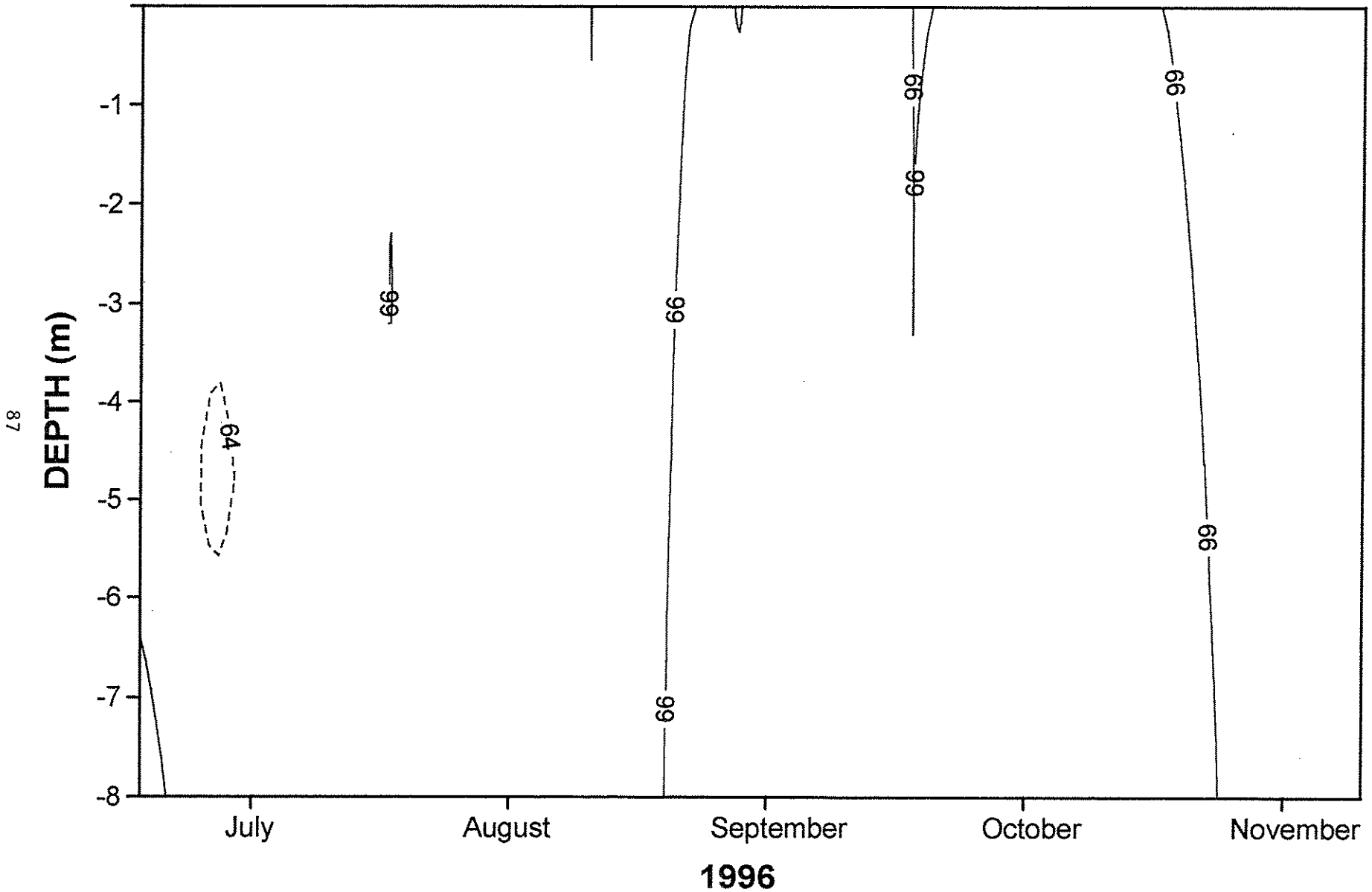

Figure 58

LCO Lake Conductivity Isopleths (Umhos/cm @ 25C) Station B (West Hole)

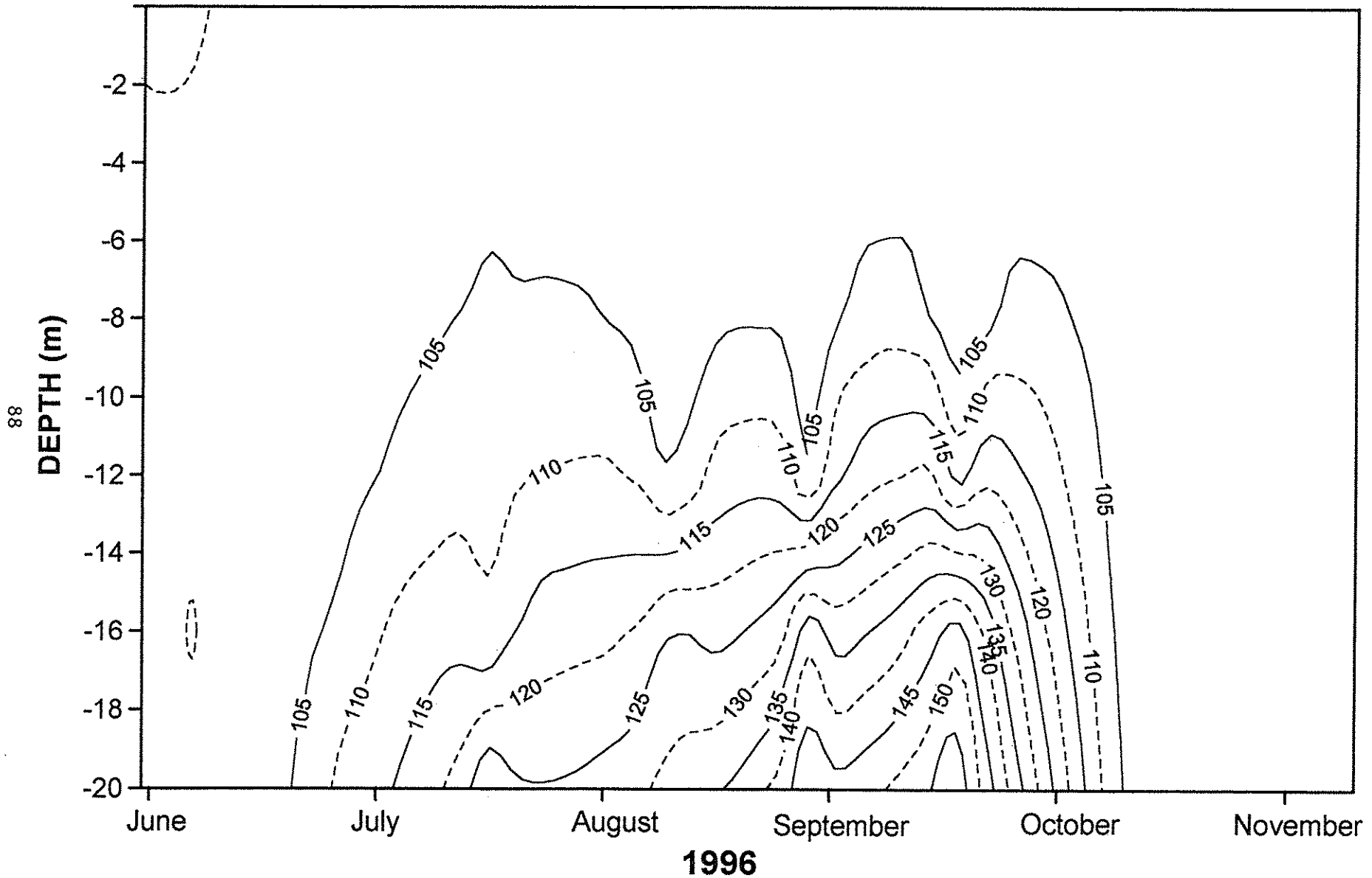

Figure 59

LCO Lake Conductivity Isopleths Umhos/cm @ 25C) Station C (Central Hole)

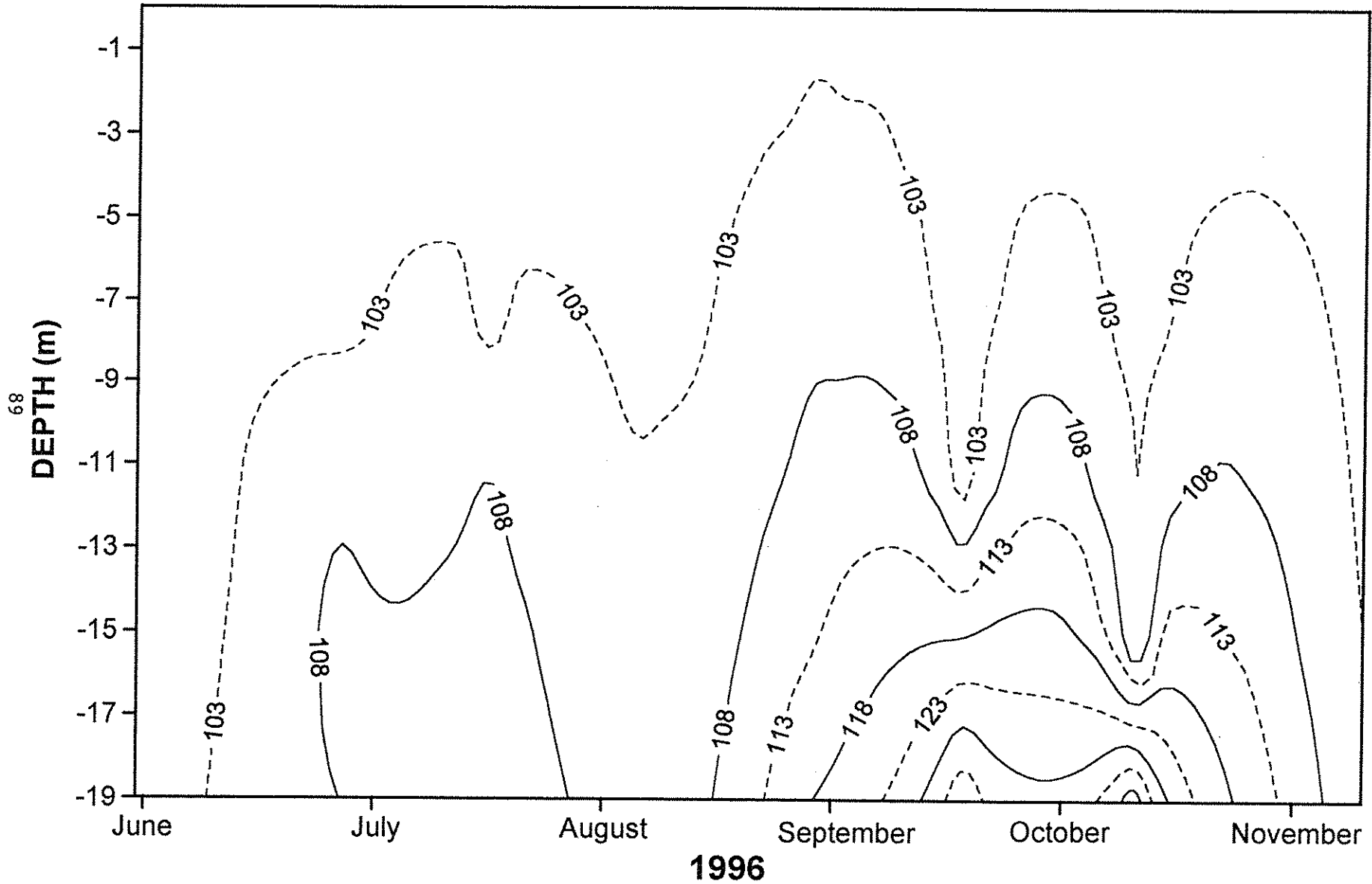

Figure 60

LCO Lake Conductivity Isopleths (Umhos/cm @ 25C) Station D (Musky Bay)

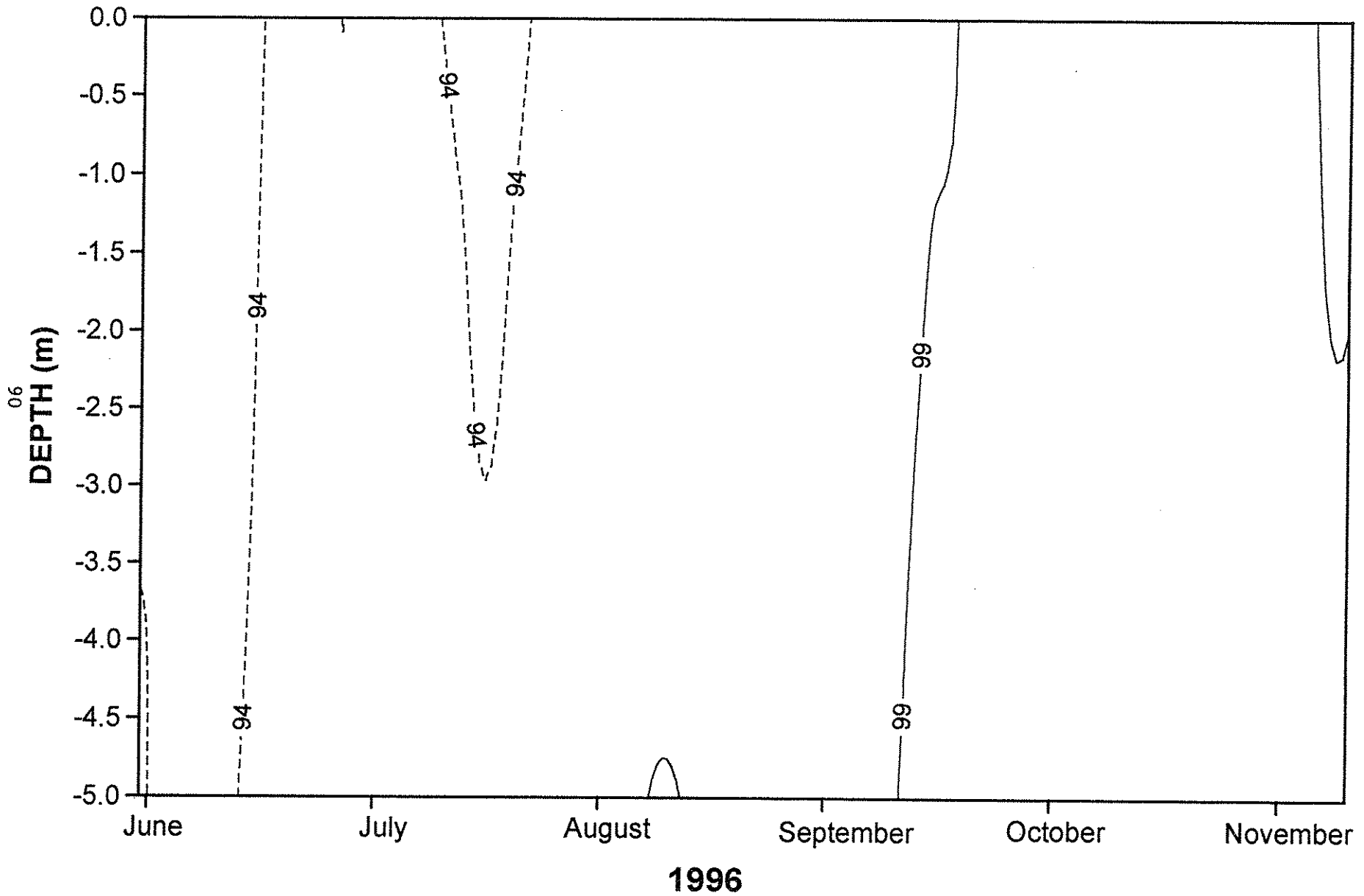

Figure 61

LCO Lake Conductivity Isopleths (Umhos/cm @ 25C) Station E (Stukey Bay)

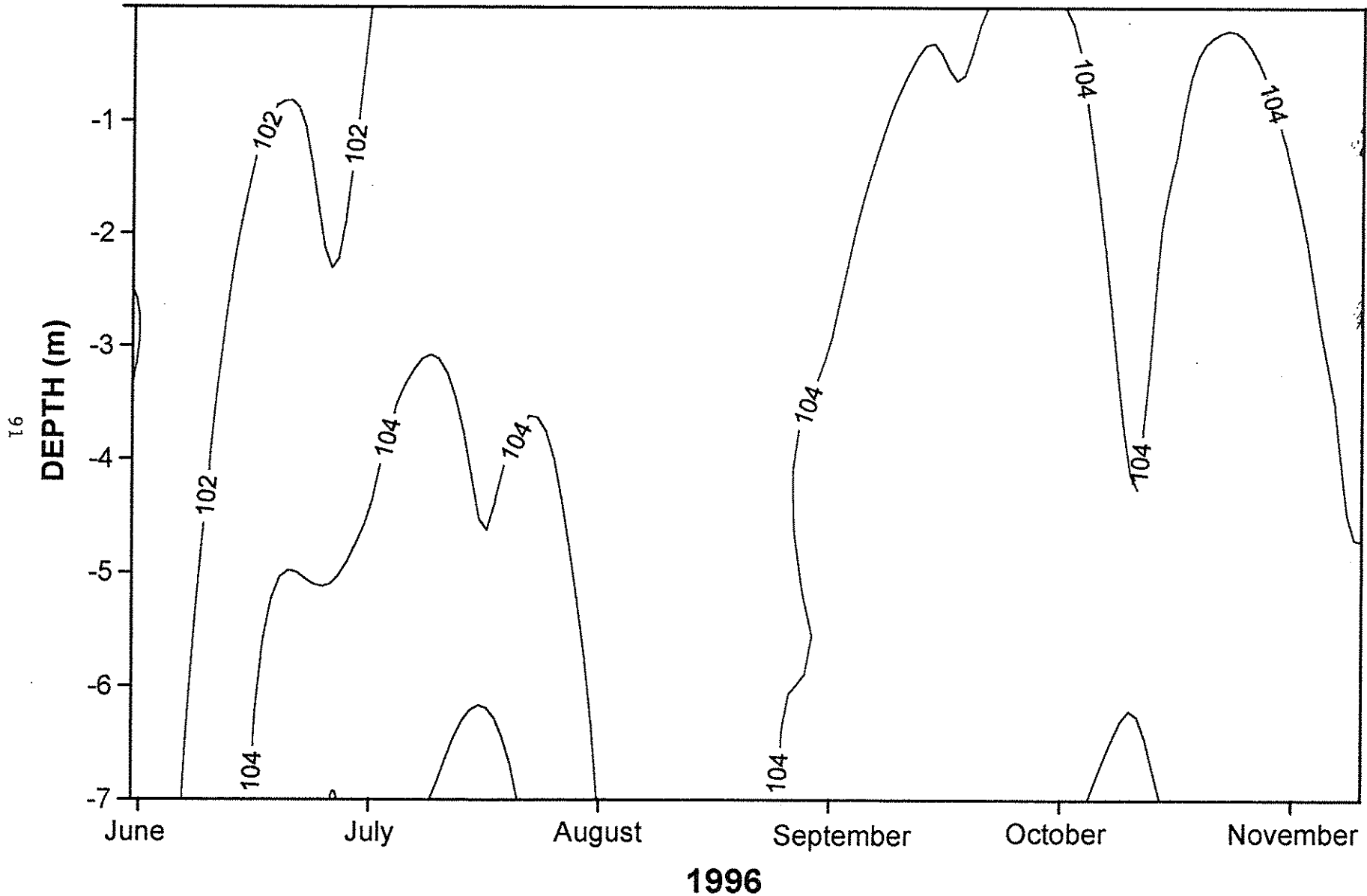

Figure 62

LCO Lake Conductivity Isopleths (Umhos/cm @ 25C) Station F (Chicago Bay)

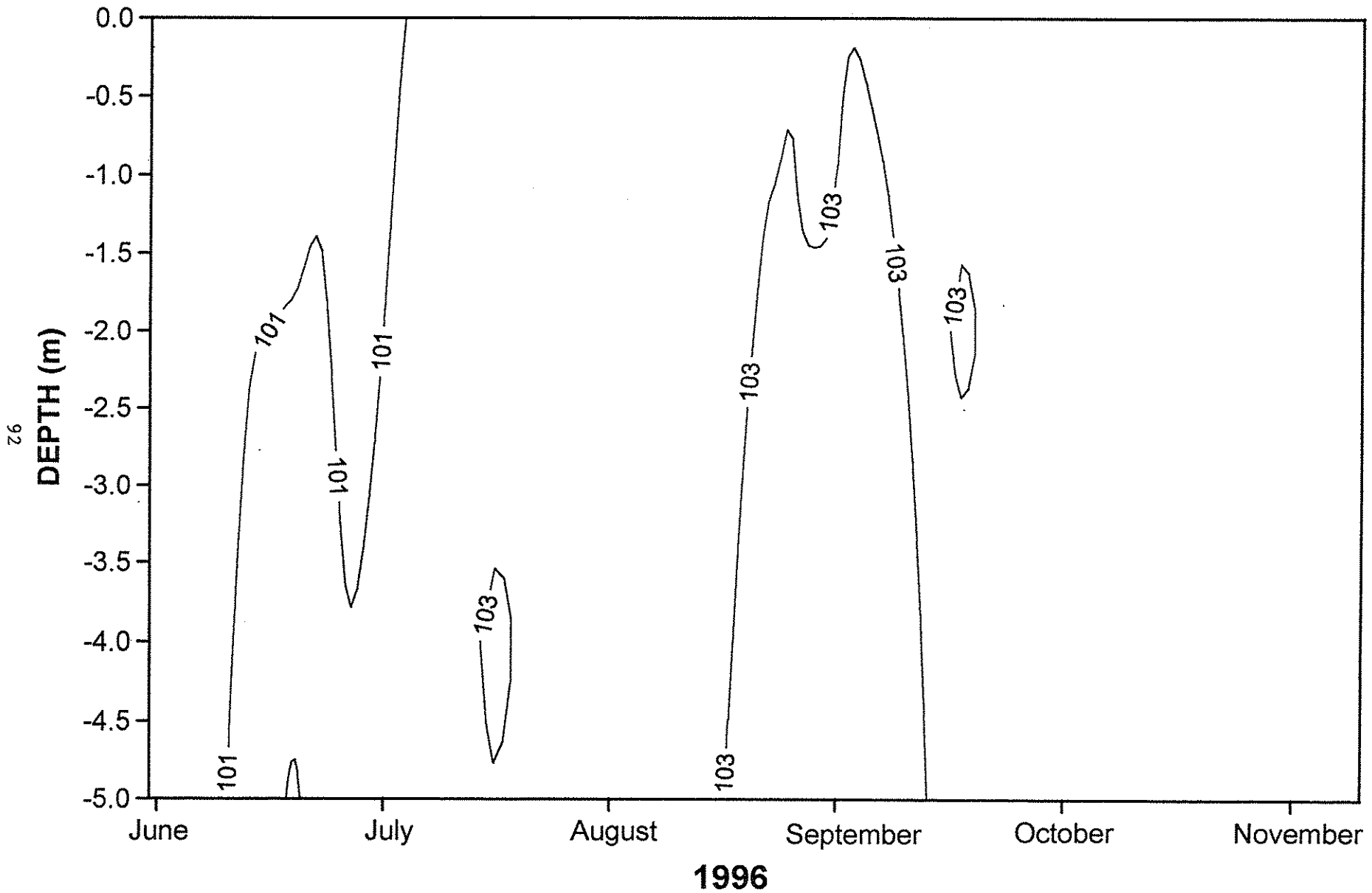

Figure 63

LCO Lake Conductivity Isopleths (Umhos/cm @ 25C) Station G (Grindstone Bay)

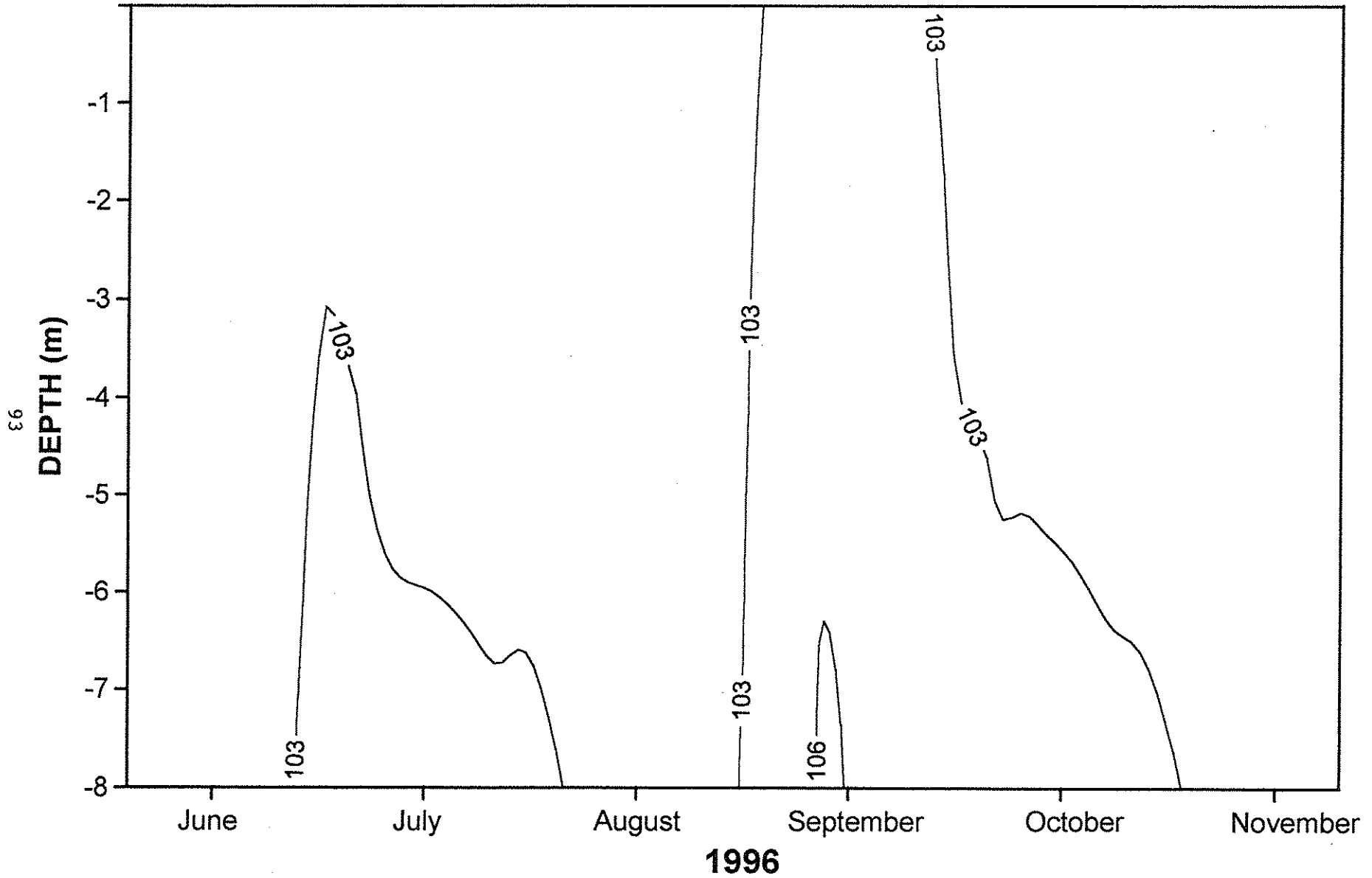

Figure 64

LCO Lake Conductivity Isopleths (Umhos/cm @ 25 C) Station H (Northeast Bay)

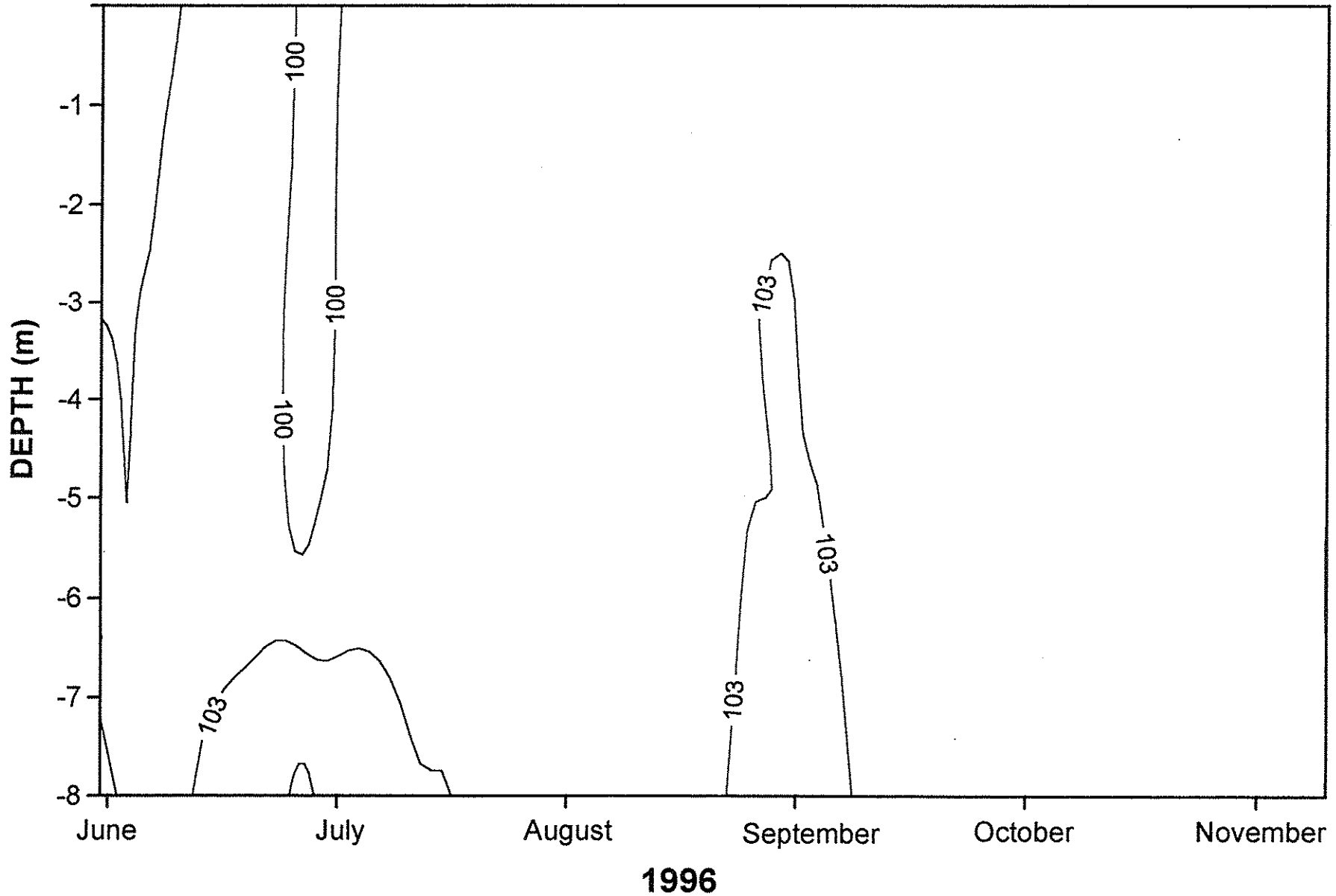

Figure 65

5.2.5 pH Isopleth Diagrams

pH defines the acid or alkaline status of the water. A pH of 7.0 is neutral, while waters above 7.0 are alkaline, and waters below 7.0 are acidic. Rainwater is naturally slightly acidic. Lakes that receive most of their water from precipitation, such as seepage lakes, will be acidic. Drainage lakes, such as Lac Courte Oreilles, receive most of their water from streams and rivers and will tend to be more alkaline.

The acidity or non-acidity of a lake directly influences the aquatic life in the lake. For example, if a lake has a pH of 6.5 or lower (acidic), walleye spawning is inhibited. At a pH of 5.2 or lower, walleyes cannot survive. Acidic conditions may result in higher mercury and aluminum levels and may pose health problems to wildlife and to humans consuming fish.

pH isopleth diagrams (Figures 66-73) indicate alkaline conditions generally occurred throughout Lac Courte Oreilles. An exception occurred in the bottom waters of Basins B and C, which were somewhat acidic. The lake's surface waters were more alkaline than the lake's deeper waters. Photosynthesis causes the addition of hydroxide ions to the water, resulting in higher pH levels. Photosynthesis by algae in the lake's surface waters likely caused increased pH levels, thereby resulting in higher levels than the lake's bottom waters. All pH levels measured in Lac Courte Oreilles are within the range of values considered safe for fish and aquatic animals. Ranges of pH measured in surface waters (i.e., 0-2 meters) of basins/bays include:

- 7.5 through 8.1 in Basin A
- 7.1 through 8.4 in Basin B
- 7.6 through 8.5 in Basin C
- 7.6 through 9.1 in Basin D
- 7.7 through 8.5 in Basin E
- 7.6 through 8.3 in Basin F
- 7.6 through 8.3 in Basin G
- 7.5 through 8.2 in Basin H

Basin D exhibited higher pH measurements than the other lake basins during the summer period. Additional algal growth and macrophyte growth in Basin D and the higher levels of photosynthesis associated with the increased growth are the likely causes of the higher pH levels within Basin D. Other basins noted few macrophytes and lower chlorophyll *a* concentrations (i.e., algal growth) throughout the summer period.

LCO Lake pH Isopleths Station A (Deep Hole - DNR)

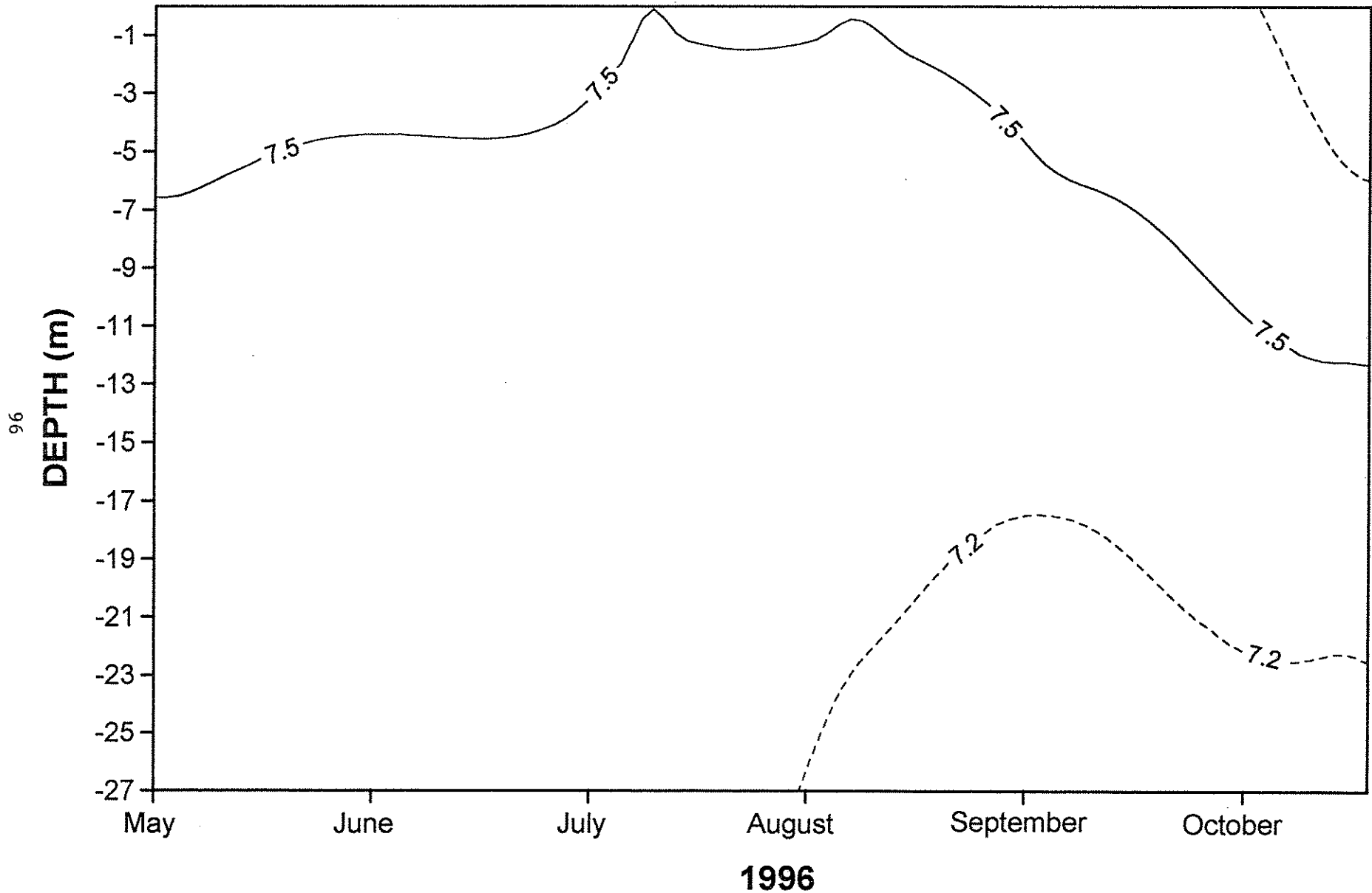

Figure 66

LCO Lake pH Isopleths Station B (West Hole)

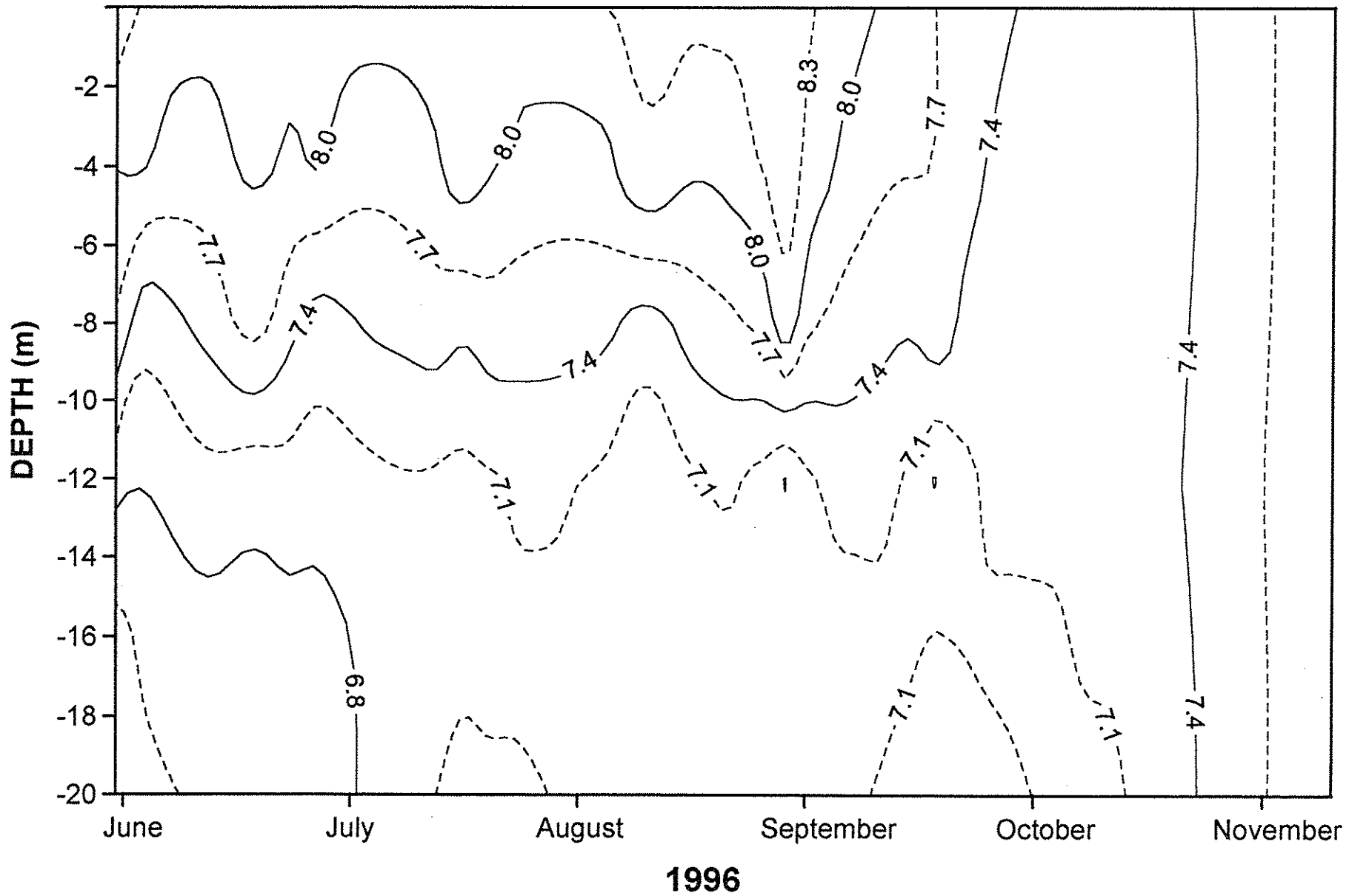

Figure 67

LCO Lake pH Isopleths Station C (Central Hole)

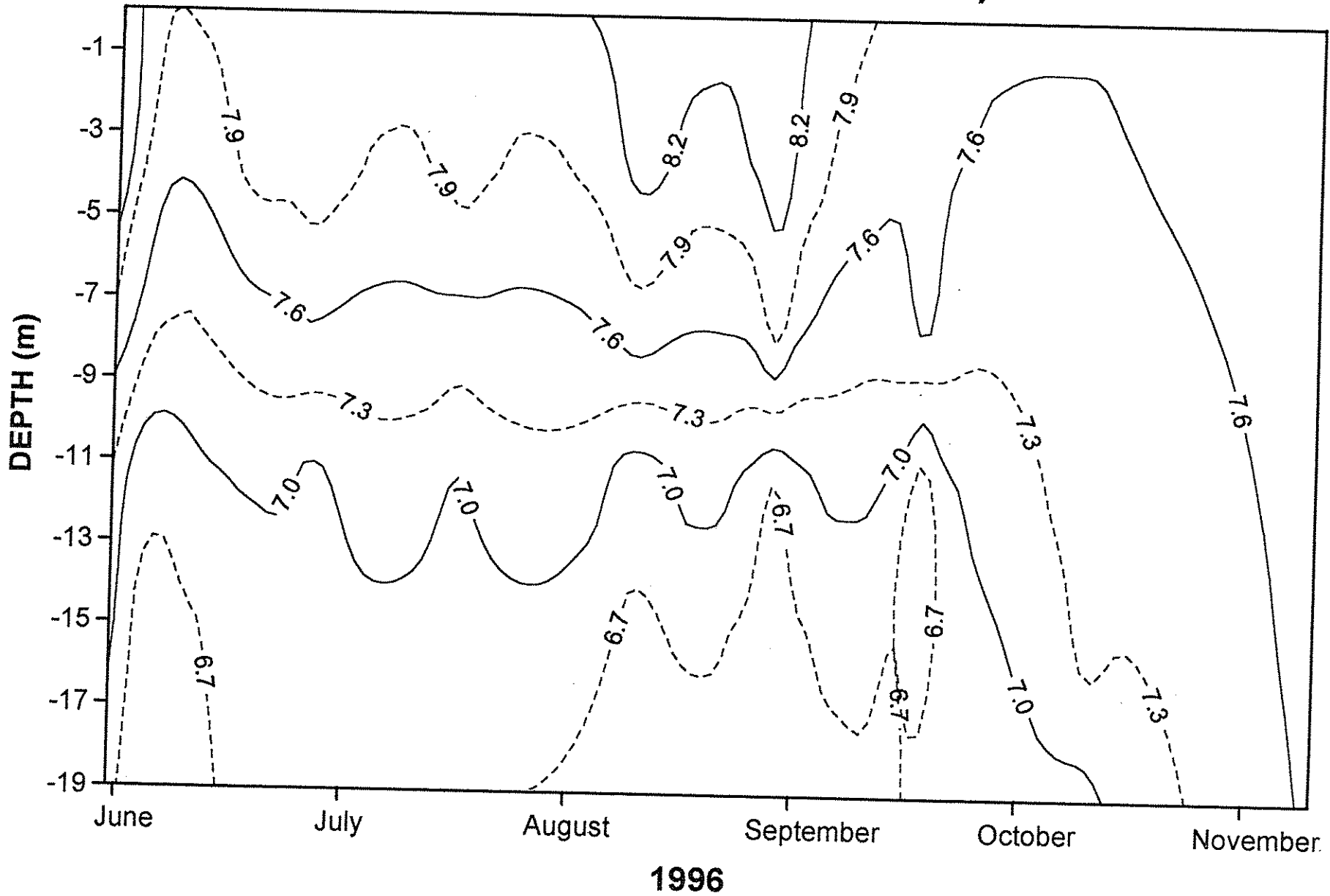

Figure 68

LCO Lake pH Isopleths Station D (Musky Bay)

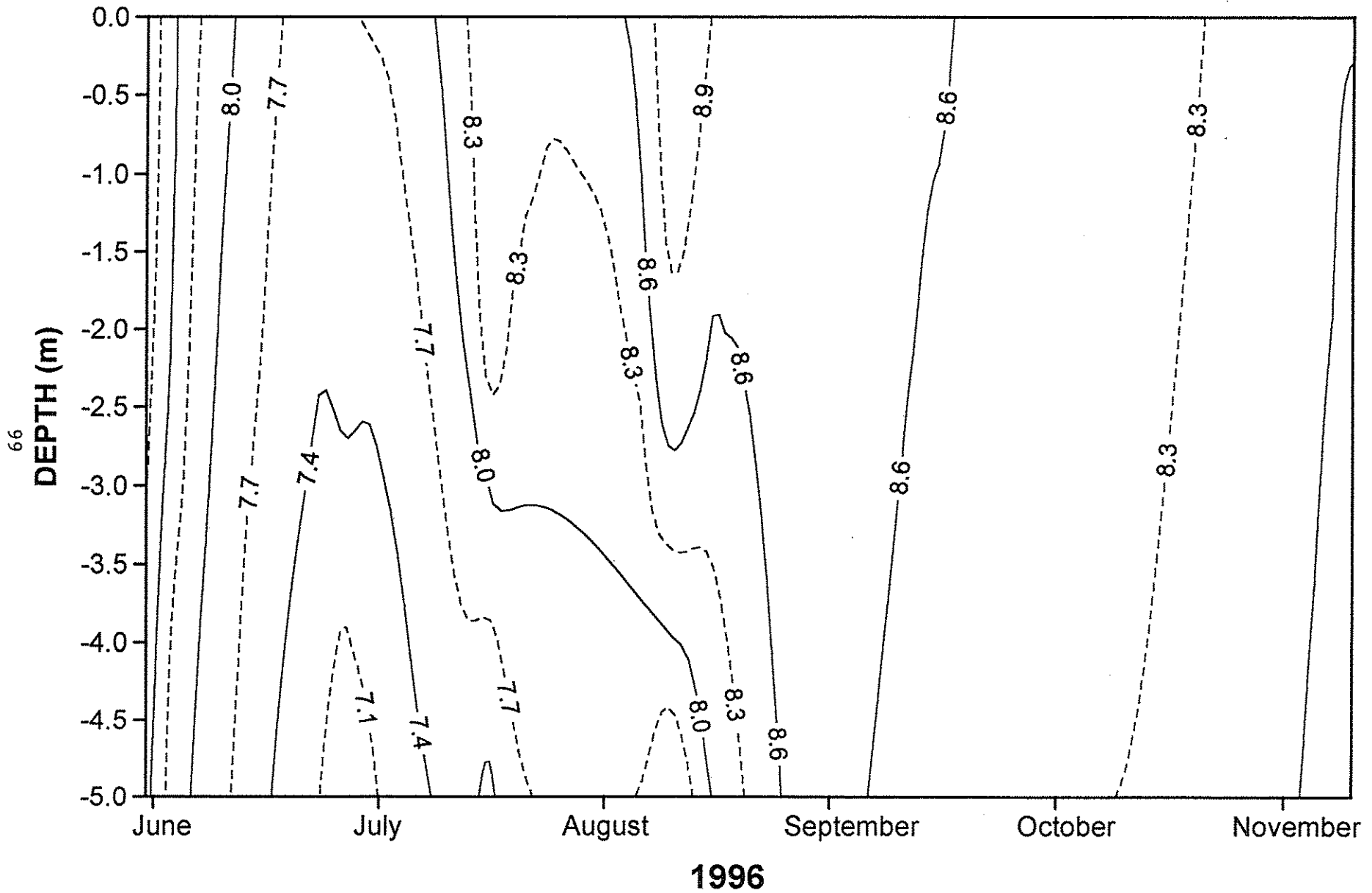

Figure 69

LCO Lake pH Isopleths Station E (Stukey Bay)

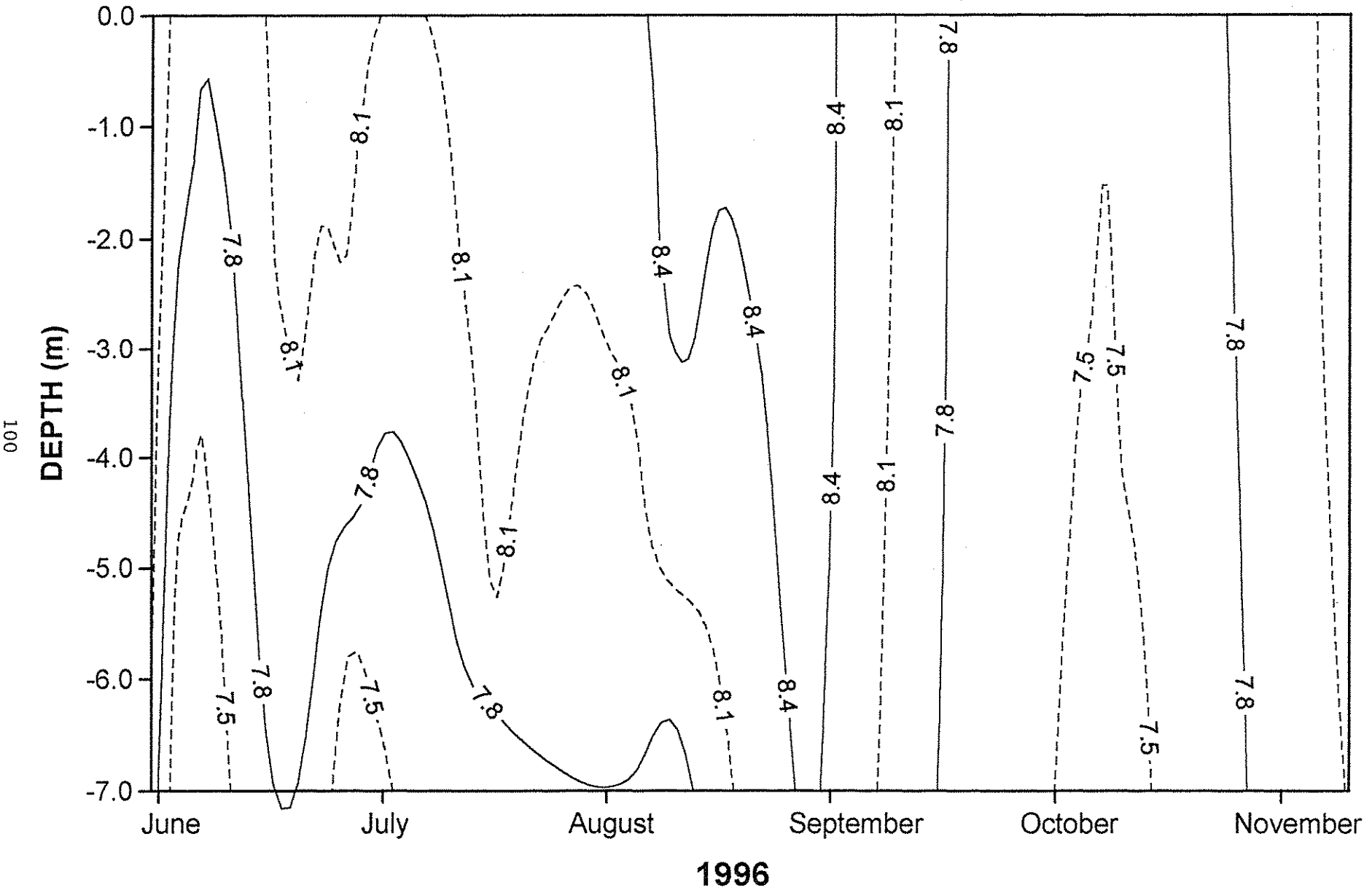

Figure 70

LCO Lake pH Isopleths Station F (Chicago Bay)

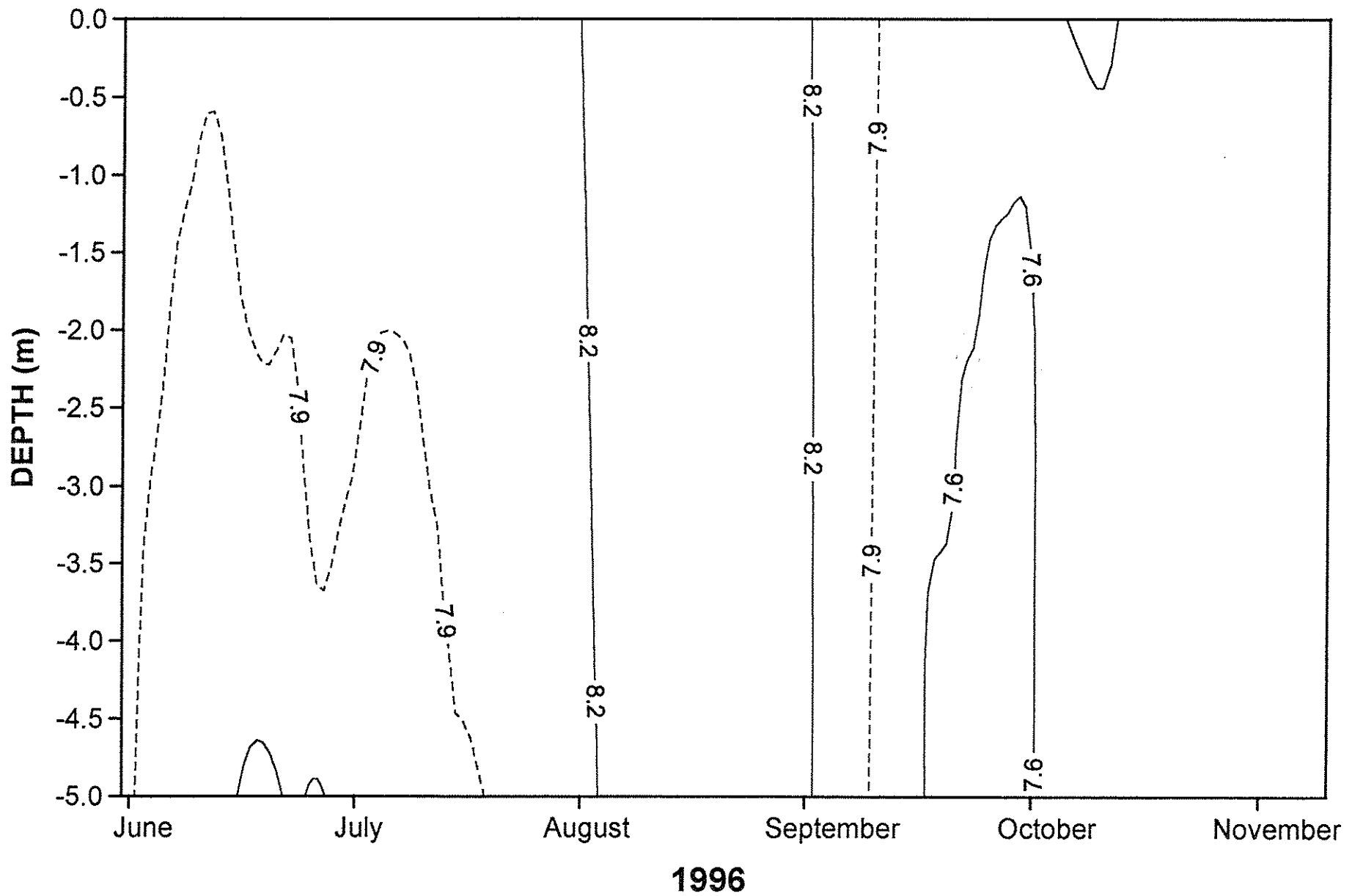

Figure 71

LCO Lake pH Isopleths Station G (Grindstone Bay)

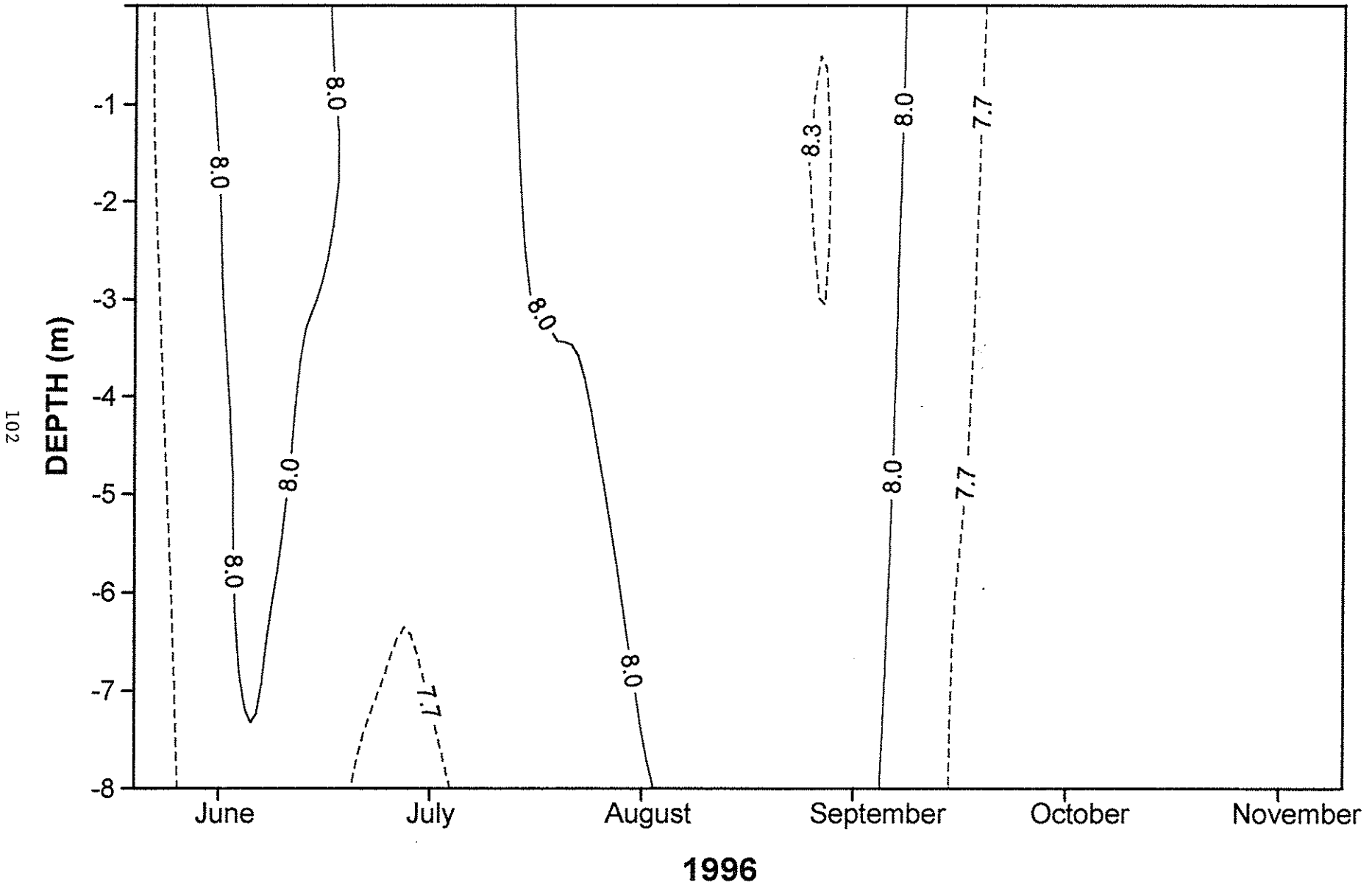

Figure 72

LCO Lake pH Isopleths Station H (Northeast Bay)

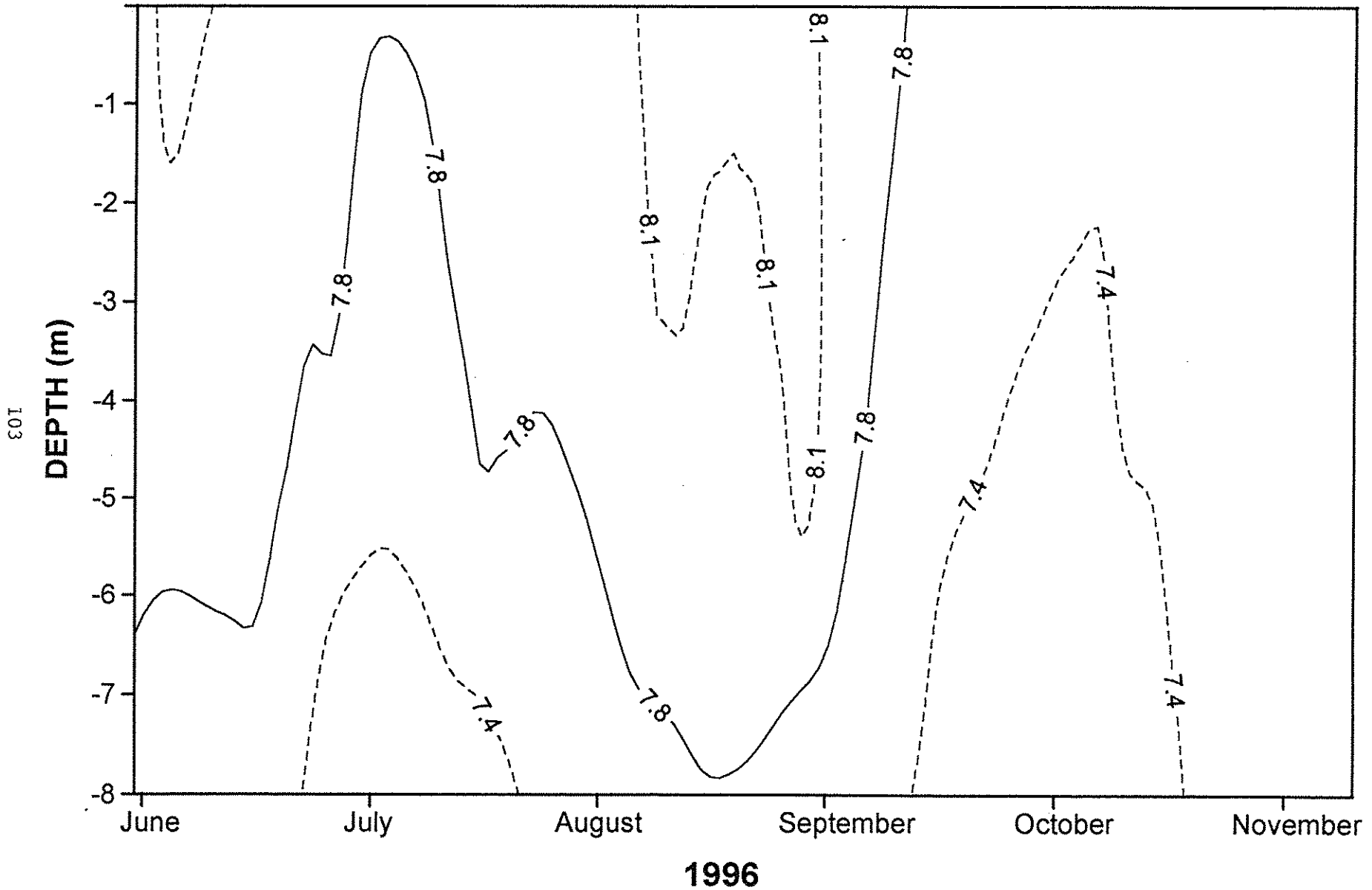

Figure 73

5.2.6 Alkalinity Data

Alkalinity is associated with the carbon system in the lake. Another term used to indicate a lake's alkalinity is hardness. Hard water lakes (greater than 60 mg/L calcium carbonate) tend to be better producers of aquatic life, both plants and animals. Soft water lakes (less than 60 mg/L calcium carbonate) are not as productive. Extremely low alkalinities (less than 5 mg/L calcium carbonate) are more likely to be impacted by acidification resulting from acid rain. Alkalinities above 5 mg/L calcium carbonate have enough buffering to counteract the effects of acid rain.

Alkalinity measurements in Lac Courte Oreilles surface waters ranged from 39 mg/L calcium carbonate to 46 mg/L calcium carbonate during 1996 (See Table 6). Therefore, the lake is a soft water lake. All basins except Basin D exhibited a very narrow range of values for alkalinity measurements made during the May and September sampling periods (i.e., values ranged from 44 mg/L calcium carbonate to 46 mg/L calcium carbonate). Basin D exhibited a wider range of values (i.e., 39 mg/L in May and 43 mg/L in September).

Table 6 1996 Lac Courte Oreilles Surface Water Alkalinity Measurements (mg/L Calcium Carbonate)

Basin	5/21	5/29	9/17
A	45	—	—
B	—	44	45
C	—	45	45
D	—	39	43
E	—	44	46
F	—	44	45
G	—	45	45
H	—	45	45

5.2.7 Water Quality Comparison Between Sample Locations

With few exceptions, Lac Courte Oreilles exhibits a relatively homogeneous water quality. Poorer water quality was observed within Basin D (i.e., Musky Bay, See Figure 5) and better water quality was observed at Basin A (i.e., East Basin, See Figure 5) than deep Basins B and C and all other bay locations.

Basin D noted a summer average phosphorus concentration approximately four times higher than average summer concentrations observed at all locations except Basin A (See Figure 74); a summer average chlorophyll *a* concentration more than double the average summer concentrations observed at all locations except Basin A (See Figure 75); and a summer average Secchi disc transparency

measurement (i.e., from the deep hole sample location of Basin D) approximately 30 percent lower than the summer average measurement observed at all locations except Basin A (See Figure 76). Other indications of relatively poorer water quality in Basin D include a dense macrophyte growth found throughout the bay and large mats of filamentous algae found floating above the macrophyte beds or blown to the near shore areas by prevailing winds (See Figure 26). It should be noted that the floating algal mats were not present at the deep hole sampling location and, therefore, were not included in the study's chlorophyll measurements of Basin D (Tyrolt, Personal Communication, 1997). Secchi disc measurements from near shore areas of Basin D where floating mats of algae were observed ranged from 0.2 meters to 0.4 meters. Comparable measurements from the Basin D deep hole sampling location ranged from 1.8 meters to 4.7 meters (See Figure 35).

Although phosphorus concentrations within the lake's deep east basin (Basin A, See Figure 5) were similar to other basins (except Basin D), a lower algal yield appears to have occurred within Basin A (See Figure 74). Consequently, water transparency was better because fewer algae were found in Basin A. Basin A noted a summer average chlorophyll *a* concentration 30 to 50 percent lower than measurements observed at all locations except Basin D (See Figure 75); and a summer average Secchi disc transparency measurement approximately 20 to 50 percent lower than measurements observed at all locations except Basin D (See Figure 76).

5.3 Inflow Data

Based on the summer average nitrogen to phosphorus ratios for Lac Courte Oreilles (See Table 5), phosphorus appears to be the plant nutrient that limits the growth of algae in Lac Courte Oreilles and, therefore, impacts its water clarity. Phosphorus is conveyed to the lake via several avenues including atmospheric deposition, overland flow, and several inflowing streams. During 1996, discharge and total phosphorus concentration data were collected from five inflowing streams, I-1, I-5, I-8, I-9, and I-11 (See Figure 8). The data were used to determine annual phosphorus inputs from inflows (See Figure 77). Squaw Creek (i.e., Station I-11) contributed the largest annual load (i.e., 278.7 kg/yr), followed closely by the inflow from Whitefish Lake (i.e., Station I-8, 278.7 kg/yr) and the inflow from Grindstone Lake (i.e., I-5, 278.7 kg/yr). Phosphorus inputs from the inflow from Ring Lake (i.e., Station I-5) and Ghost Creek (i.e., Station I-9) were relatively low by comparison (i.e., 5.9 kg/yr and 50.3 kg/yr, respectively).

**LCO LAKE: 1996 AVERAGE SUMMER
EPIIMNETIC TOTAL PHOSPHORUS CONC.**

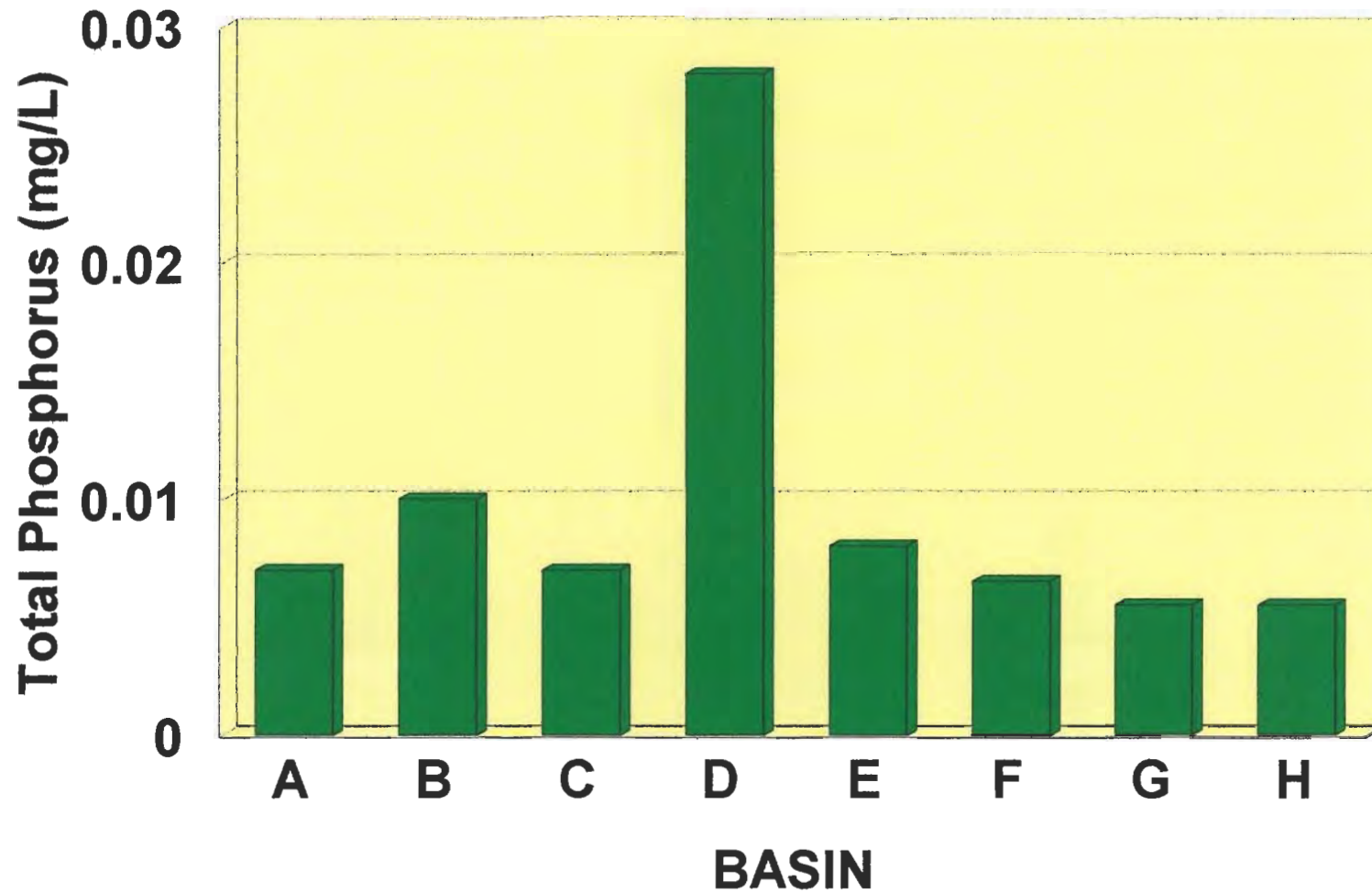

Figure 74

**LCO LAKE: 1996 AVERAGE SUMMER
EPILIMNETIC CHLOROPHYLL CONC.**

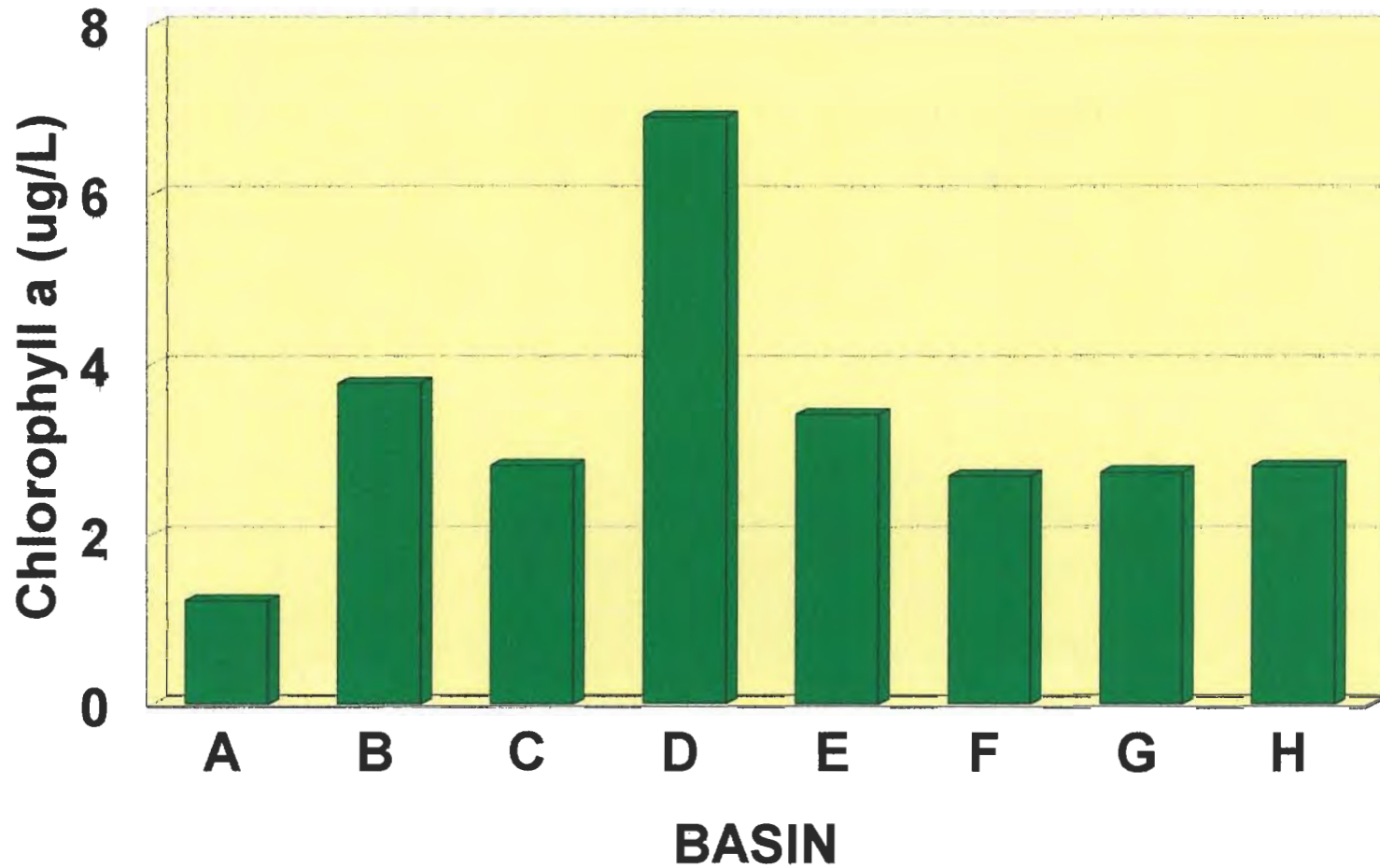

Figure 75

LCO LAKE: 1996 AVERAGE SUMMER SECCHI DISC TRANSPARENCY

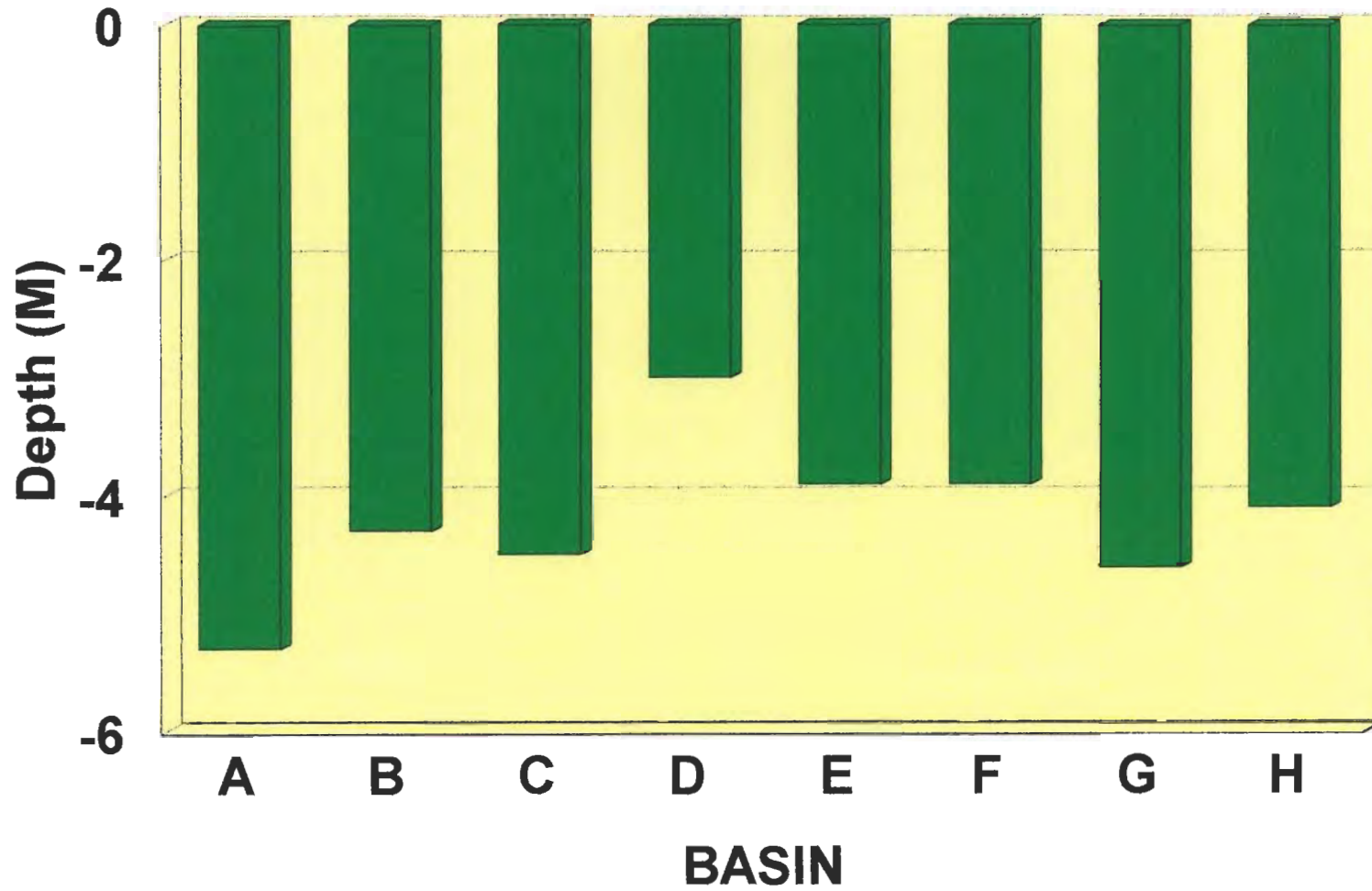

Figure 76

Lac Courte Oreilles: Annual Phosphorus Inputs From Inflows

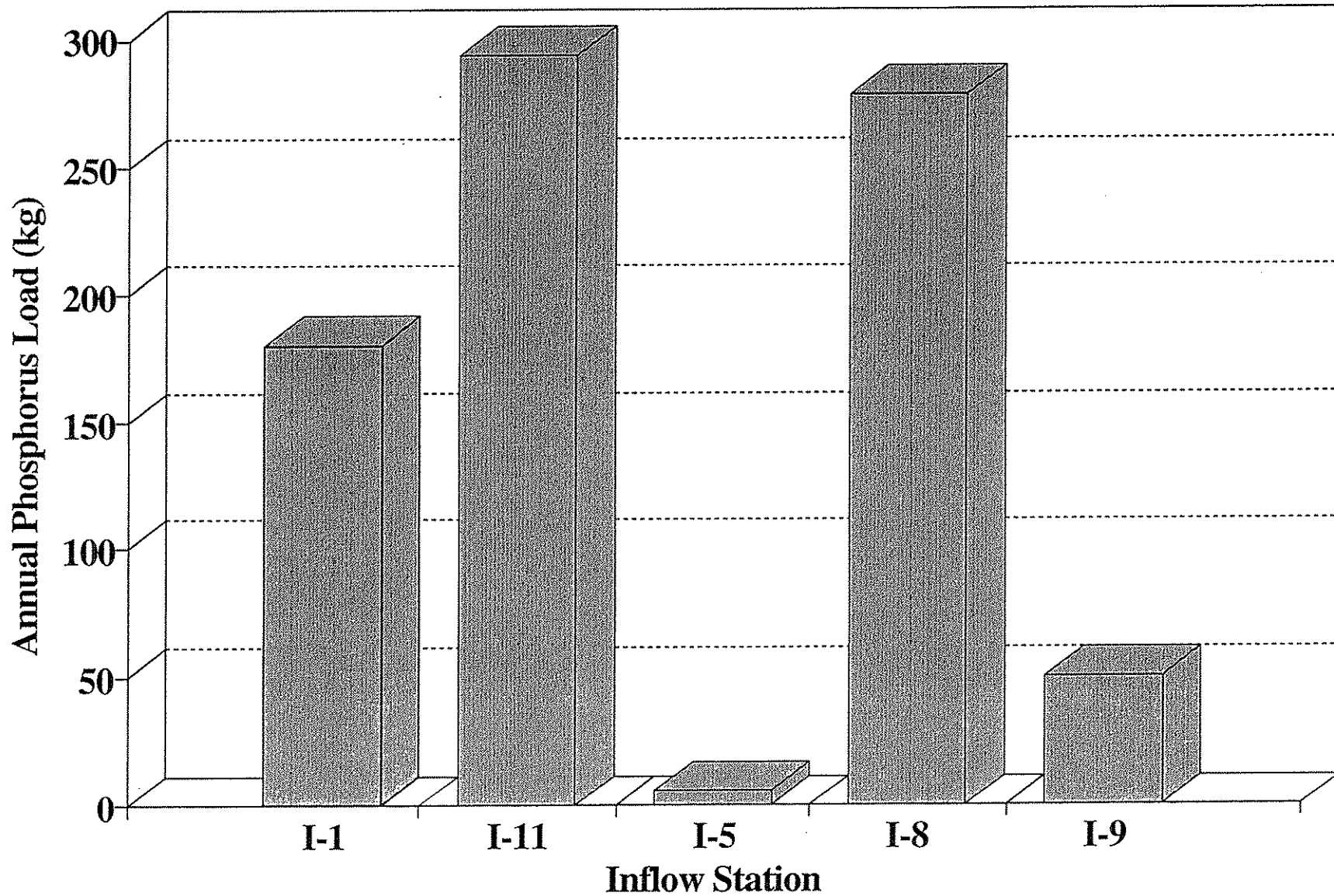

Figure 77

5.4 Periphyton: Estimated Soluble Reactive Phosphorus Concentrations at Inflow Locations

Periphyton are microorganisms that grow or become attached to submerged surfaces. They are comprised of algae and are the primary producers in shallow lakes, ponds, and rivers. Phosphorus is the plant nutrient that most often limits the growth of periphytic algae. The quantity of available phosphorus determines periphyton growth rates in the lake. Phosphorus-rich lake water indicates a lake has the potential for rapid and abundant periphytic algal growth.

Periphyton growth rates were used to estimate soluble reactive phosphorus concentrations at inflow locations during 1996 (See Figure 78). Soluble reactive phosphorus is the phosphorus species that is readily available for algal growth; consequently, algal growth readily depletes it. During the sampling period, the highest estimated soluble reactive phosphorus concentration (i.e., 7 µg/L) occurred at Station P-2 (i.e., See Figure 6), a cranberry marsh inflow location in Basin F. The concentration occurred during May, coincident with the expected discharge of waters from a tributary cranberry farm. The May soluble reactive phosphorus concentration (estimated) from Station P-2 is approximately equal to the average summer total phosphorus concentration for Basin F.

The estimated soluble reactive phosphorus concentrations from other inflow locations were less than the average summer total phosphorus concentrations of adjacent bays. Soluble reactive phosphorus concentrations from other sample locations ranged from 0.2 µg/L (i.e., P-9, Ghost Creek, See Figure 7) to 5.2 µg/L (i.e., P-10, See Figure 7). Vandalism resulted in a loss of periphyton samplers in Basin D (i.e., P-7 and P-8) during the spring and early summer period. Therefore, only late summer data are available from this location.

Lac Courte Oreilles Estimated Soluble Reactive Phosphorus Concentrations at Sample Stations P-1 through P-11 Sorted by Month

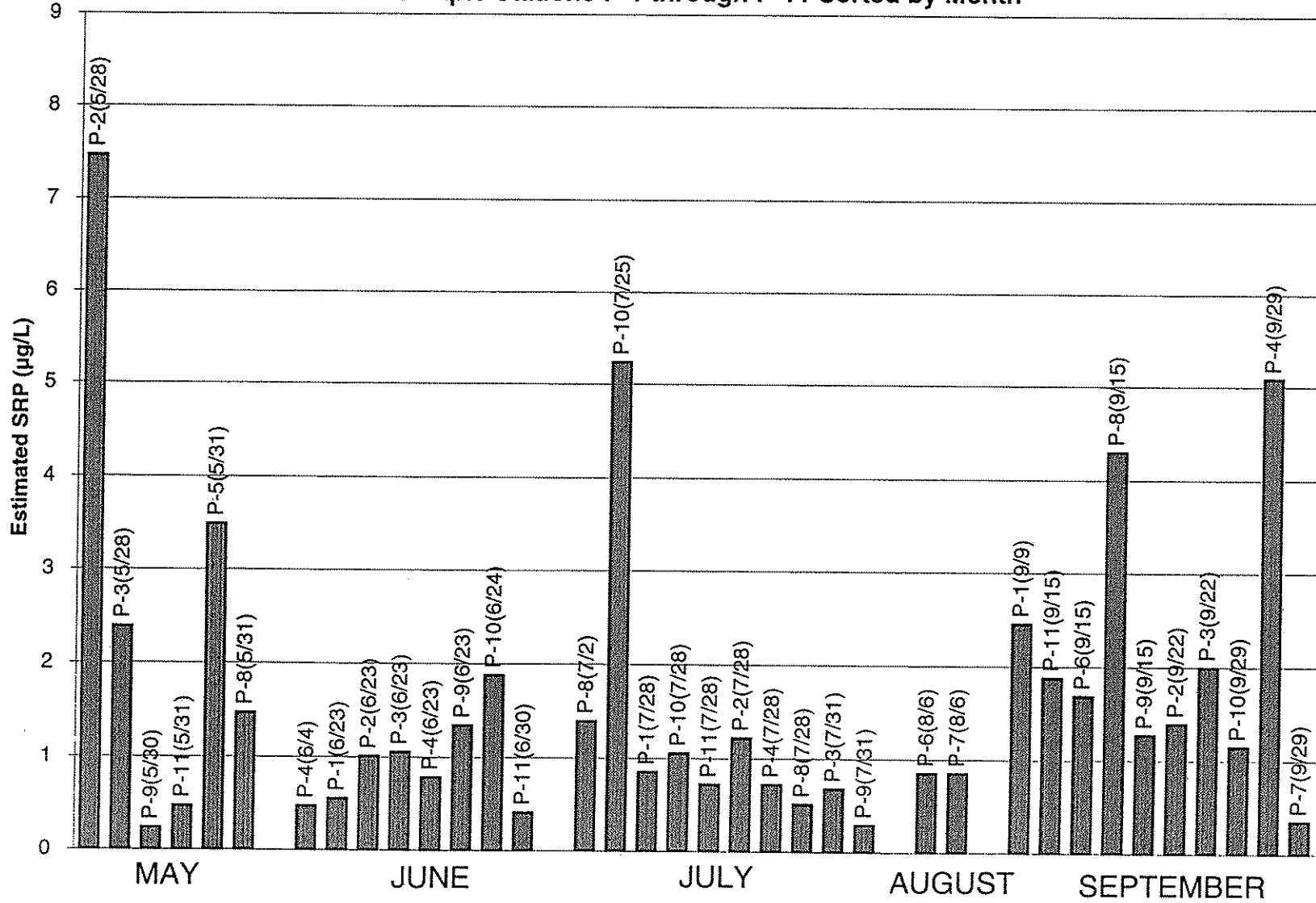

Figure 78

5.5 Evaluation of Historical Secchi Disc Data

An evaluation of average summer Secchi disc data collected from the lake's three deep basins (i.e., A, B, and C, See Figure 5) indicates:

- Secchi disc data were available from 1987 through 1996 at Station A. Average water transparency data at Station A (east basin) during 1987 through 1996 were generally similar and were within the mesotrophic category (see Figure 79). However, average transparencies during 1989 and 1996 were somewhat higher and were within the oligotrophic category. Therefore, the water clarity during 1996 was better than the clarity observed in recent years, based upon Secchi disc data. The data indicate minimal recreational use impairment occurred during 1988 and no recreational use impairment occurred during other years.
- Secchi disc data were available from 1991 through 1993, and 1996 at Station B. Higher average water transparency was observed at Station B (west basin) during 1996 than during 1991 through 1993 (See Figure 80). Therefore, water clarity during 1996 was better than clarity observed in recent years, based upon Secchi disc data. Average transparencies were within the mesotrophic category throughout the period of record. The data indicate minimal recreational use impairment occurred during 1991 through 1993 and no recreational use impairment occurred during 1996.
- Secchi disc data were available from 1991 through 1993 and 1996 at Station C. Higher average water transparency was observed at Station C during 1996 than during 1991 through 1993 (See Figure 81). As was noted for Stations A and B, water clarity during 1996 was better than clarity observed in recent years, based upon Secchi disc data. Average transparencies have been within the mesotrophic category during the period of record. The data indicate minimal recreational use impairment occurred during 1992 and 1993; no recreational use impairment occurred during 1991 and 1996.

LAC COURT OREILLES SUMMER SECCHI DISC TRANSPARENCIES

113

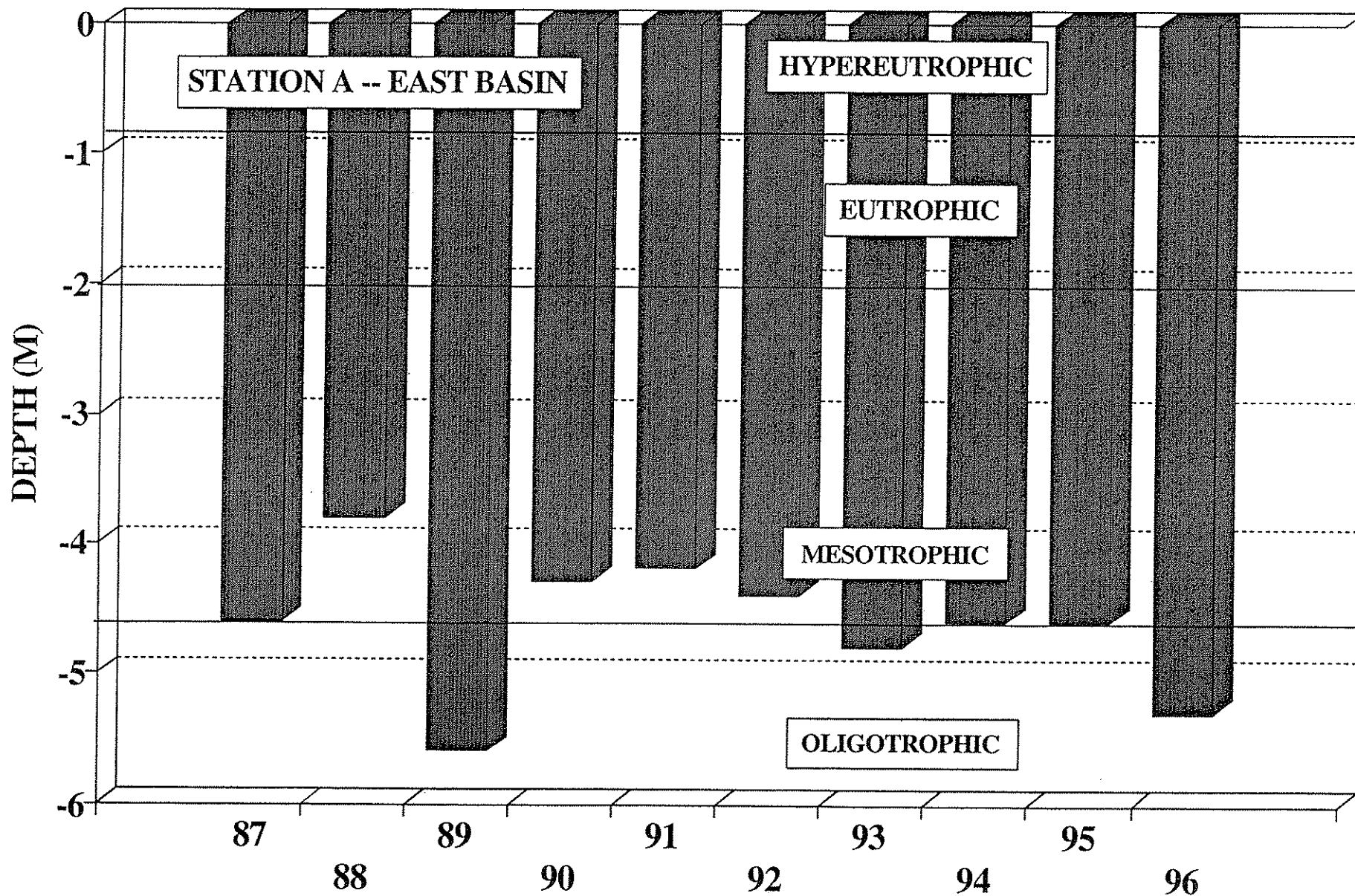

Figure 79

LAC COURT OREILLES SUMMER SECCHI DISC TRANSPARENCIES

114

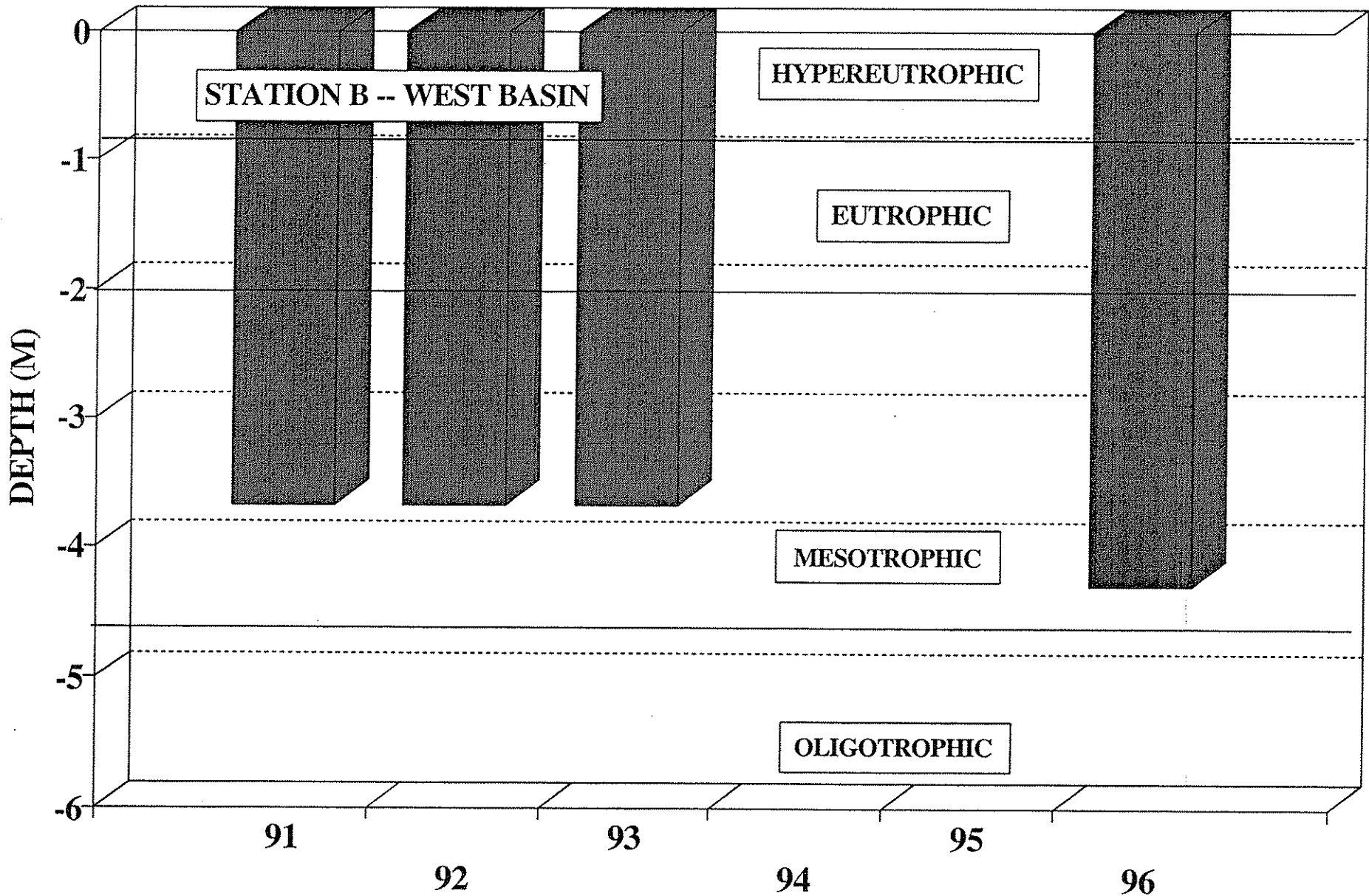

Figure 80

LAC COURT OREILLES SUMMER SECCHI DISC TRANSPARENCIES

115

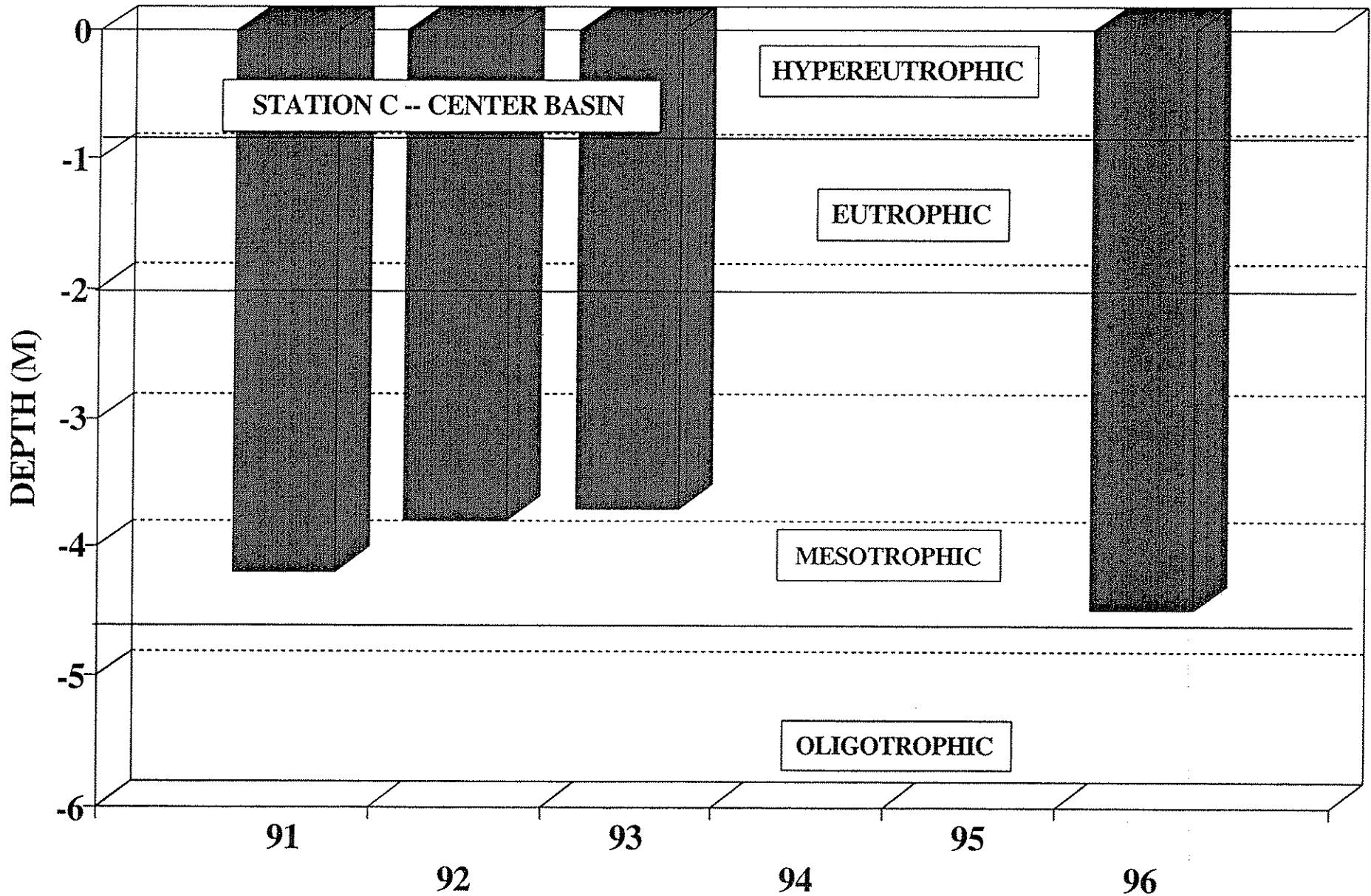

Figure 81

5.6 Rainfall, Evaporation and Lake Outlet Data

As previously mentioned, volunteers during the ice-free period installed rain gages at eight locations within the Lac Courte Oreilles watershed and read them daily to determine daily precipitation amounts. Total average precipitation during the 1995–96 water year (monitored) was 36.58 inches.

The monthly evaporation rates estimated from the Meyer Watershed Model ranged from 0.12 inches (in January) to 4.20 inches (in September). Monthly evaporation rates were translated into daily evaporation rates to allow estimation of the hydrologic budgets on an event basis. The daily evaporation rates were assumed to be the same for each day of each month. Total estimated evaporation during 1995–96 was 23.18 inches.

Two staff gages were installed on the east end of the lake and a stage-storage curve was developed for determining the change in storage within the lake at the various lake levels. The gage was read on a daily basis during the period May 16 through September 30. The monitored lake water surface elevations had a range of approximately 1.25 feet. The low lake surface elevation occurred in late September and the high lake surface elevation resulted from the 2.63-inch storm event from May 17–18, 1996. The large storm event caused the lake level to rise approximately 0.14 foot.

5.7 Hydrologic Budget Calculations

Table 2 shows the watershed areas for each of the lakes and sub-basins that are directly connected to Lac Courte Oreilles. The 1995–96 water year (October 1, 1995 through September 30, 1996) estimated hydrologic budget for Lac Courte Oreilles is presented on Figure 82. As the budget indicates, rainfall runoff from the lake's watershed (i.e., land area that drains into the lake) provided two thirds of the estimated annual water load to the lake. Direct precipitation and snowmelt runoff from the lake's watershed comprised the remaining third of the estimated annual water load. The watershed runoff volume represents an annual water yield of approximately 9.71 inches from the Lac Courte Oreilles watershed. The runoff yield divided by the 36.58 inches of total precipitation for the monitored period results in a runoff coefficient of 0.27 (or 27 percent of the total precipitation is estimated to run off the watershed).

Evaporation (23.18 inches over the water surface area) was slightly less than precipitation (36.58 inches) during 1996. Ordinarily, evaporation would be expected to be approximately the same as the observed annual precipitation amount.

Estimated Lac Courte Oreilles Inflow '95-'96 Water Year

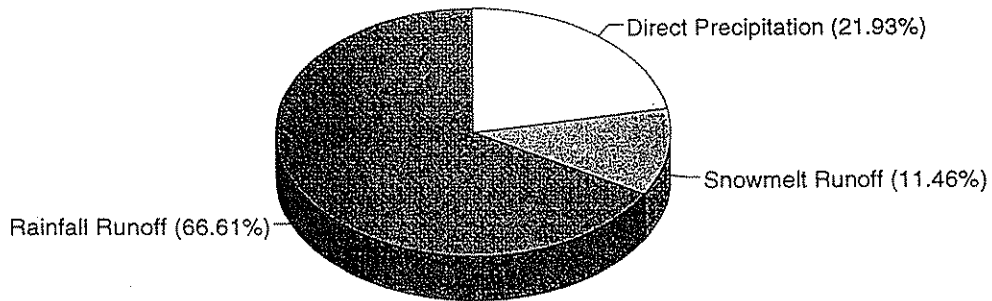

Estimated Lac Courte Oreilles Outflow '95-'96 Water Year

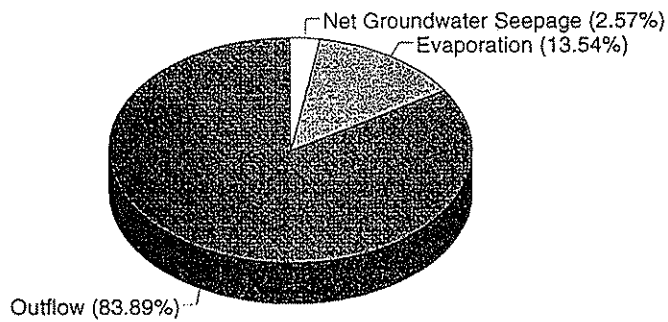

Figure 82

Estimated Lac Courte Oreilles Hydrologic Budget

The large amount of calculated watershed runoff to reach the lake during 1996 indicates that watershed runoff may have a significant impact on the water quality of Lac Courte Oreilles. The hydrologic budget calculations show that the majority of the watershed runoff that reached the lake came from rainfall runoff, however, snowmelt runoff, which occurred during the months of February and March, also represents a significant portion of the total inflow (12 percent of the total). Accordingly, snowmelt runoff can contribute a significant phosphorus load to the lake during the spring period.

The hydrologic budget is an important factor in determining the breakdown of nutrient loads into Lac Courte Oreilles. Because phosphorus appears to be the parameter of most concern, the discussion of nutrient budgets will be limited to phosphorus only.

5.8 Phosphorus Budget and Lake Water Quality Mass Balance Model

As previously mentioned, the tributary water quality data and corresponding watershed runoff volumes combined with the assumed export rates for each of the phosphorus input sources within the direct watersheds were used to estimate the total loads to each of the lake's three basins and five bay areas. The computations revealed that the total annual phosphorus load into Lac Courte Oreilles is estimated to be 4,658 pounds per year, based on 1995-96 data. The results of the overall lake phosphorus loading budget are presented in Figures 83 and 84. Phosphorus export rates, used in the WILMS model and published by the U.S. EPA for septic systems, and the septic system survey information were used to estimate a projected annual load of 123 pounds per year from drain fields or 2.6 percent of the total projected load. An atmospheric wet and dry deposition rate used by the WILMS model of 0.27 lbs/ac/yr was applied to the surface area of Lac Courte Oreilles. The computation indicates that the atmospheric component of the load is approximately 1,384 pounds per year. The watershed runoff component was estimated using the measured inflow concentrations and estimated runoff from each of the tributary watersheds along with assumed phosphorus export coefficients for each of the direct subwatersheds. The result is an estimate of 2,775 pounds per year from the watershed surface runoff, including an estimated 1,783 pounds per year from monitored inflowing streams. The remaining difference of 376 pounds of phosphorus represents internal loading.

Lac Courte Oreilles Estimated Annual Phosphorus Inputs (kg)*

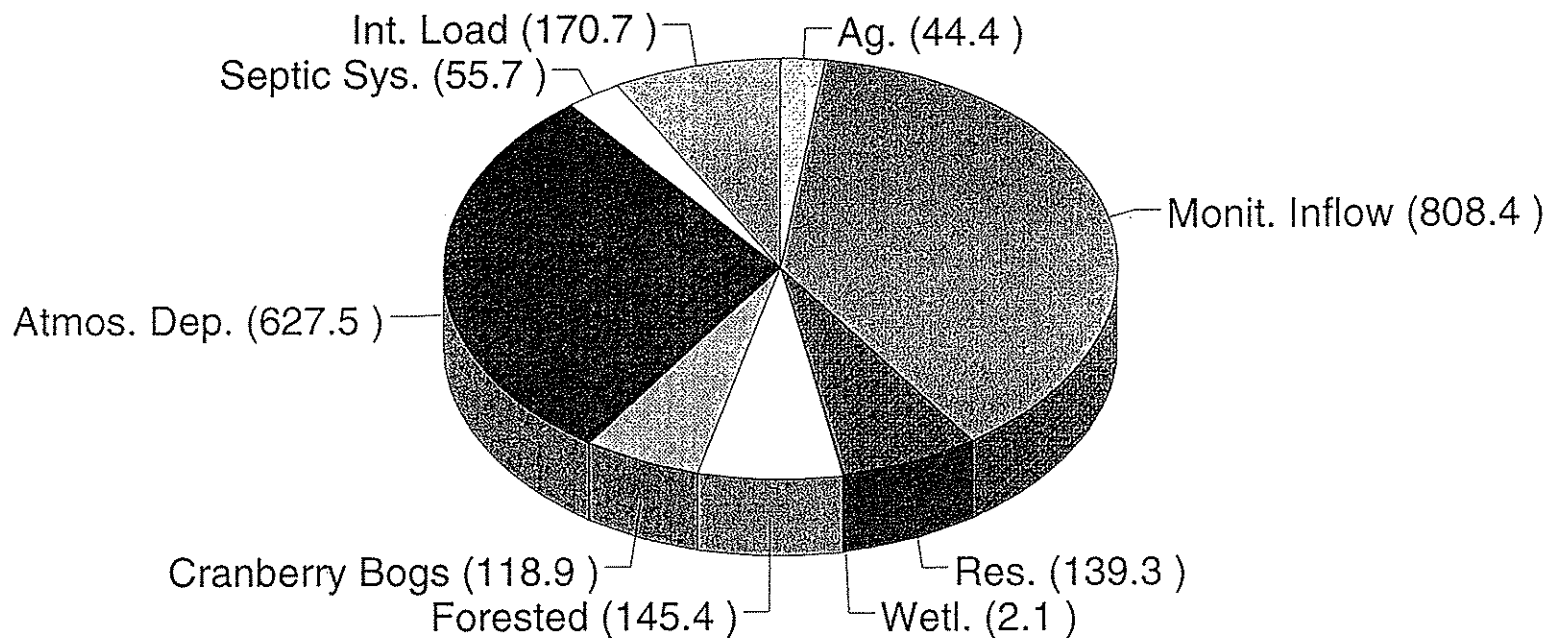

*The total annual phosphorus loading was estimated based on assumed phosphorus export rate coefficients and modeling results

Figure 83

Lac Courte Oreilles Estimated Annual Phosphorus Inputs (%)*

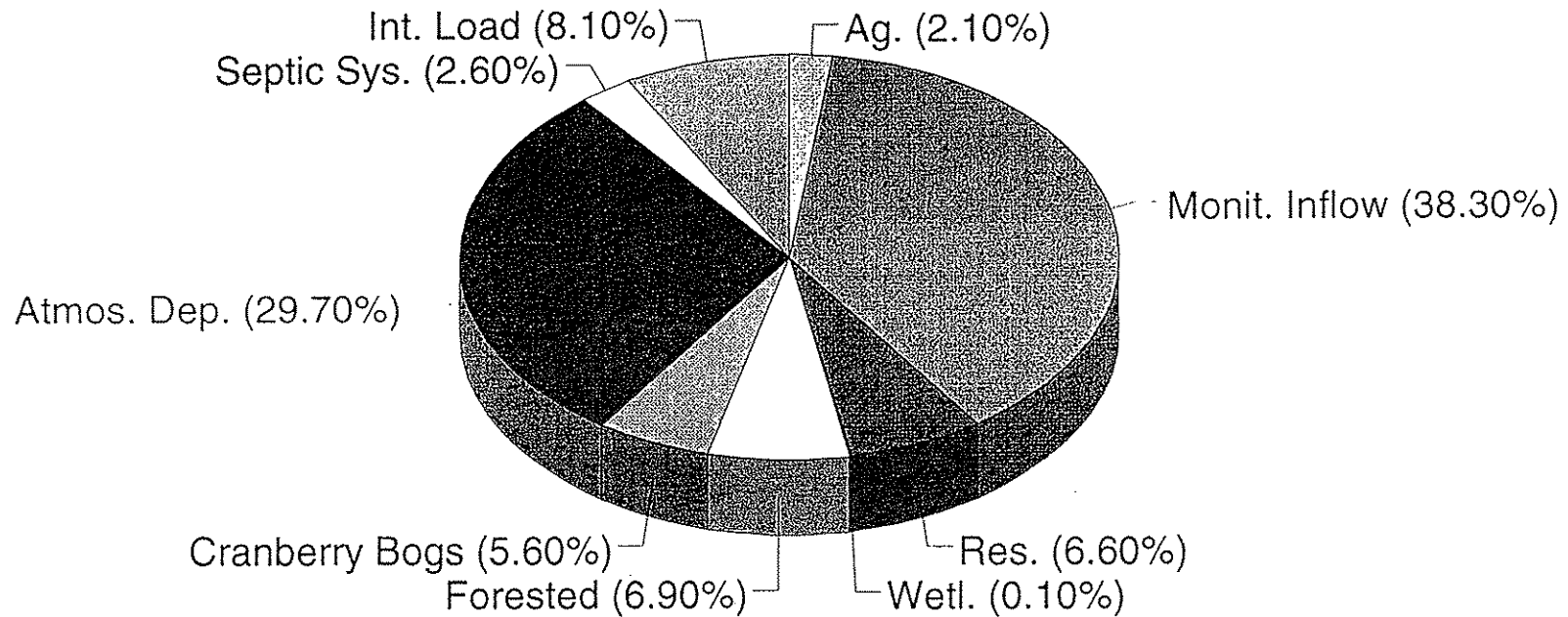

*The percentage contributions of phosphorus loading are estimated based on assumed phosphorus export rate coefficients and modeling results.

Figure 84

5.8.1 Basin A—East Basin—Modeling Results

Land use within the 2,768-acre watershed tributary to Basin A (See Figure 1) includes residential, forested, cranberry bogs, and water (including upstream Basins G and H). Basin A has a volume of 72,882 acre-feet. The annual phosphorus load to the lake basin is estimated to be 2,726 pounds (See Figure 85) or 0.04 pounds per acre-foot. The primary sources of phosphorus are upstream Basins G and H (an estimated 39.8 percent of the annual load) and inflowing streams (an estimated 27.8 percent of the annual load). Atmospheric deposition is estimated to contribute 17.1 percent of the annual load. The remaining watershed land uses collectively comprise approximately 9.3 percent of the annual load. Less than 5 percent of the annual load is calculated to result from internal loading; septic systems are estimated to comprise less than 2 percent of the annual load (See Figure 86).

5.8.2 Basin B—West Basin—Modeling Results

Land use within the 1,672-acre watershed tributary to Basin B (See Figure 1) includes agricultural, residential, forested, cranberry bogs, and water (including upstream Basin E). Basin B has a volume of 33,640 acre-feet. The annual phosphorus load to the lake basin is estimated to be 622.3 pounds (See Figure 87) or 0.02 pounds per acre-foot. The primary sources of phosphorus are atmospheric deposition (an estimated 49 percent of the annual load) and upstream basins (an estimated 18.7 percent of the annual load). The remaining watershed land uses collectively comprise approximately 25.5 percent of the annual load. Less than 3 percent of the annual load is calculated to result from internal loading; septic systems are estimated to comprise less than 5 percent of the annual load (See Figure 88).

5.8.3 Basin C—Central Basin—Modeling Results

Land use within the 2,034-acre watershed tributary to Basin C (See Figure 1) includes agricultural, residential, forested, and water. Basin C has a volume of 48,045 acre-feet. The annual phosphorus load to the lake basin is estimated to be 1,540 pounds (See Figure 89) or 0.03 pounds per acre-foot. The primary sources of phosphorus are the inflow from Grindstone Lake (an estimated 39.9 percent of the annual load), atmospheric deposition (an estimated 27.1 percent of the annual load), and upstream basins (an estimated 18.7 percent of the annual load). Other important sources include the estimated internal load (an estimated 11.7 percent of the annual load) and contributions from Basin F (i.e., an estimated 11.7 percent of the annual load). The remaining watershed land uses collectively comprise approximately 4.1 percent of the annual load. Septic systems are estimated to comprise 2 percent of the annual load (See Figure 90).

Lac Courte Oreilles Estimated Annual Phosphorus Inputs (kg)*

Basin A

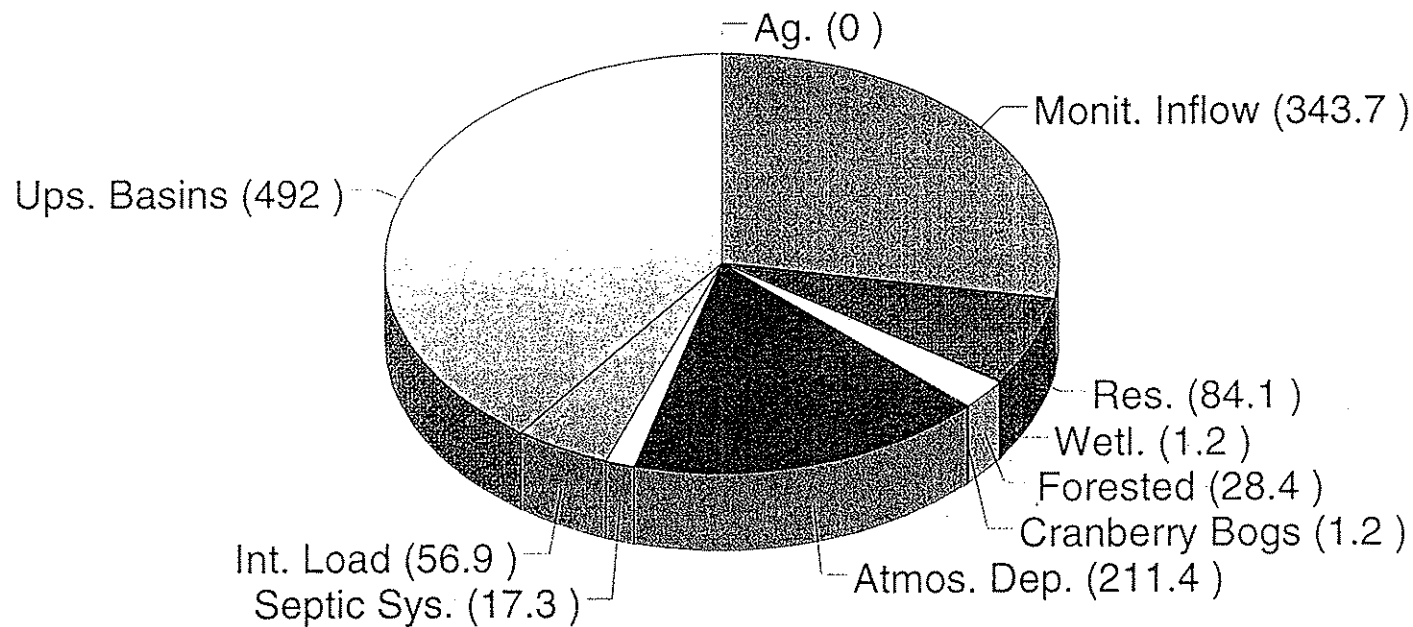

*The total annual phosphorus loading was estimated based on assumed phosphorus export rate coefficients and modeling results

Figure 85

Lac Courte Oreilles Estimated Annual Phosphorus Inputs (%)*

Basin A

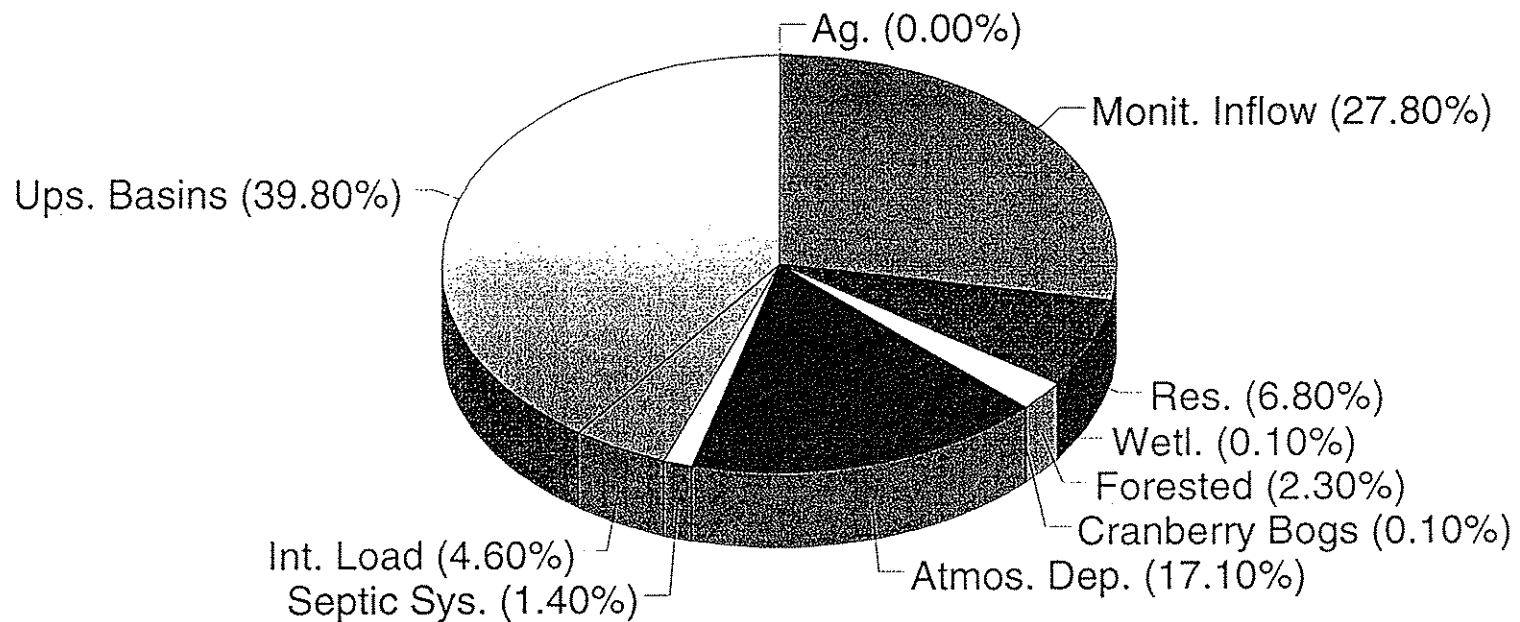

*The percentage contributions of phosphorus loading are estimated based on assumed phosphorus export rate coefficients and modeling results.

Figure 86

Lac Courte Oreilles Estimated Annual Phosphorus Inputs (kg)*

Basin B

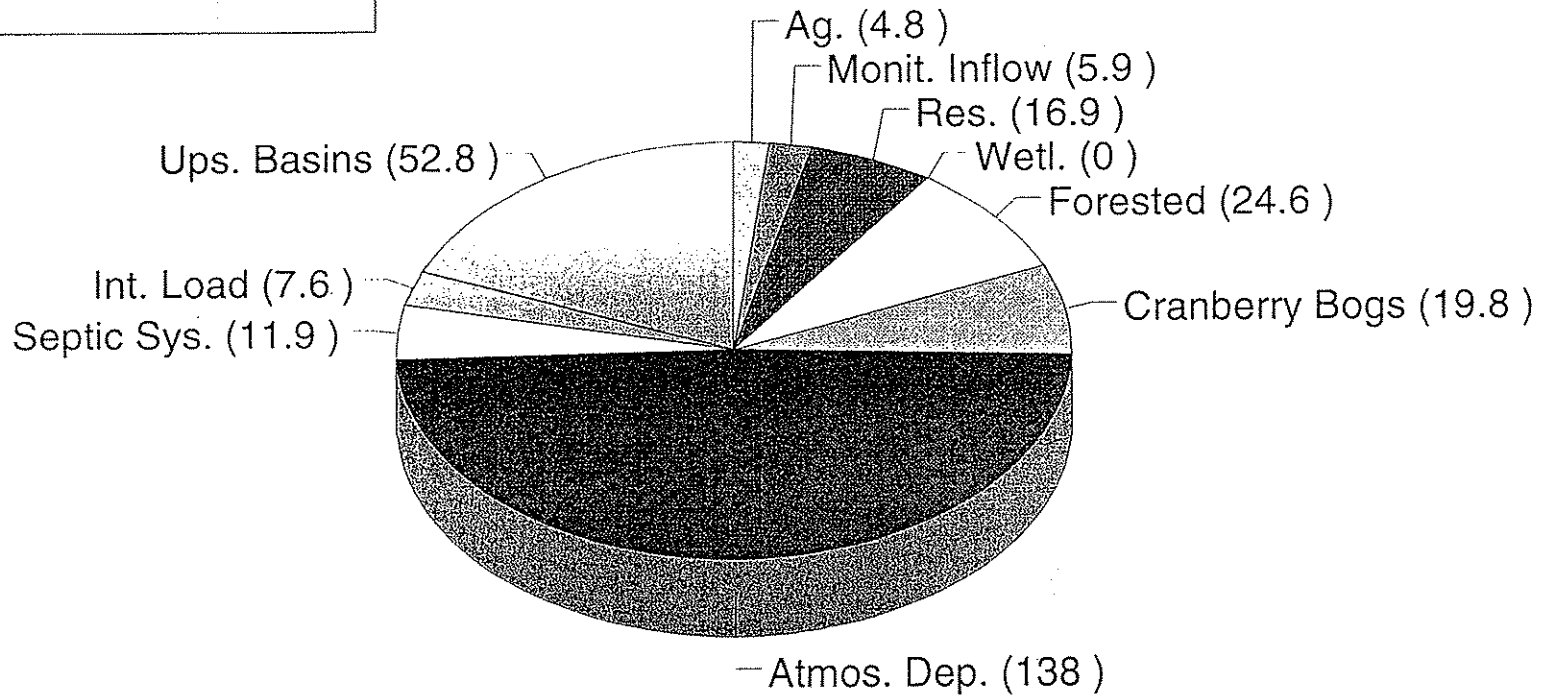

*The total annual contributions of phosphorus loading are estimated based on assumed phosphorus export rate coefficients and modeling results.

Figure 87

Lac Courte Oreilles Estimated Annual Phosphorus Inputs (%)*

Basin B

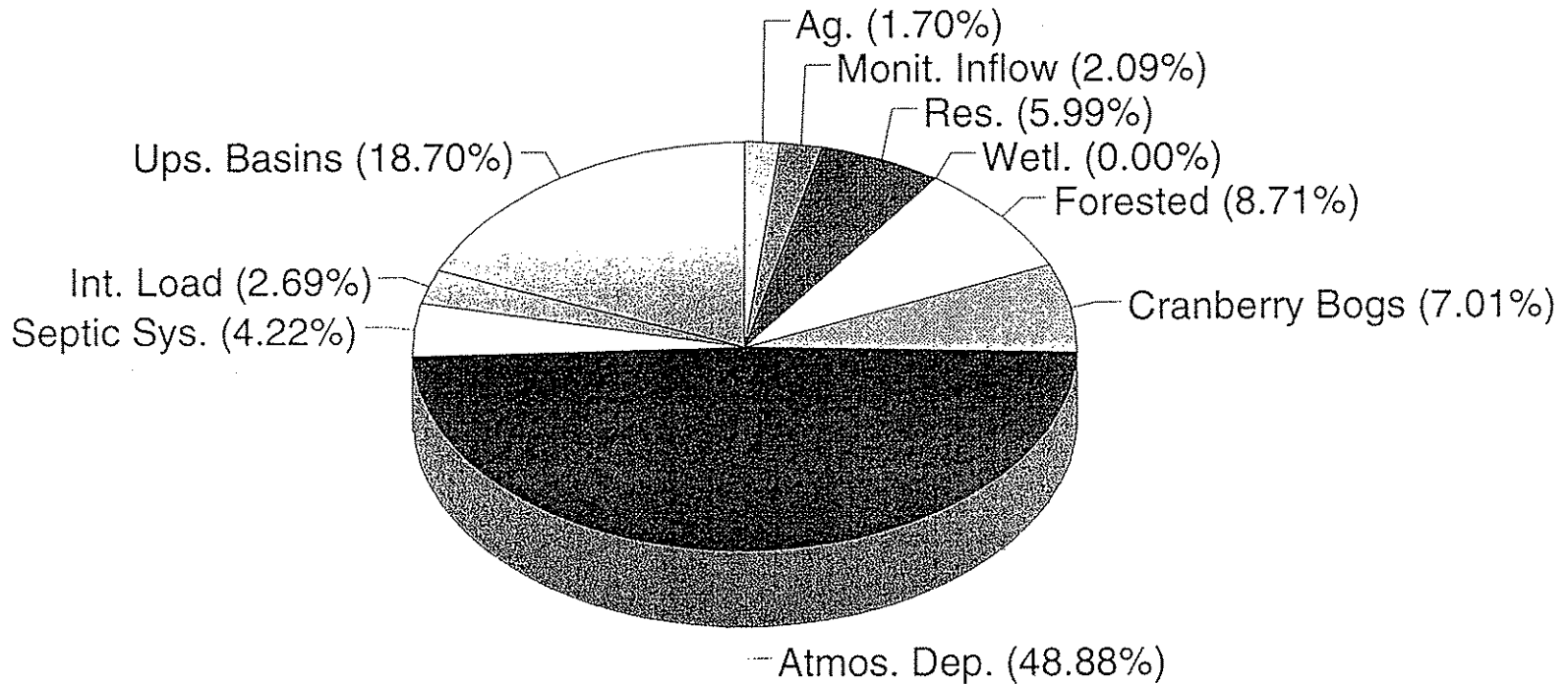

*The percentage contributions of phosphorus loading are estimated based on assumed phosphorus export rate coefficients and modeling results.

Figure 88

Lac Courte Oreilles Estimated Annual Phosphorus Inputs (kg)*

Basin C

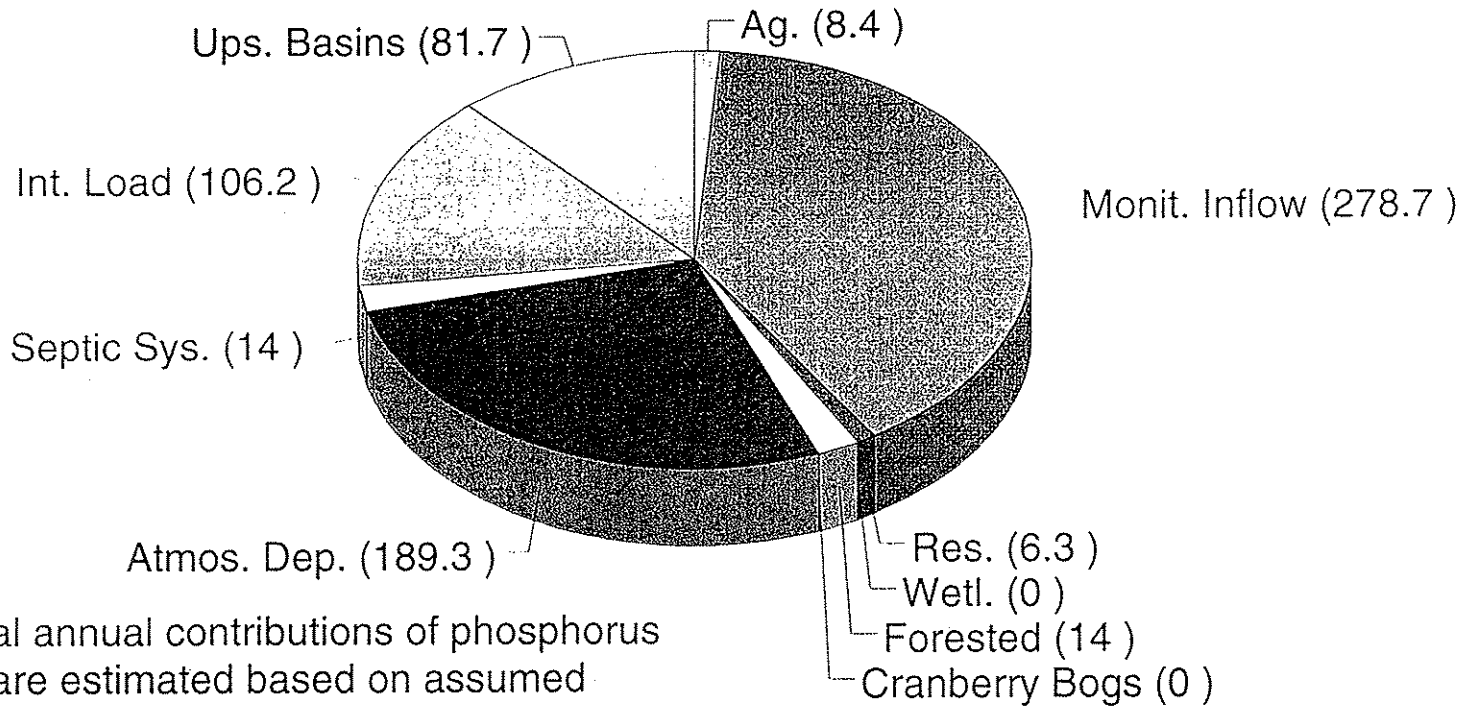

*The total annual contributions of phosphorus loading are estimated based on assumed phosphorus export rate coefficients and modeling results

Figure 89

Lac Courte Oreilles Estimated Annual Phosphorus Inputs (%)*

Basin C

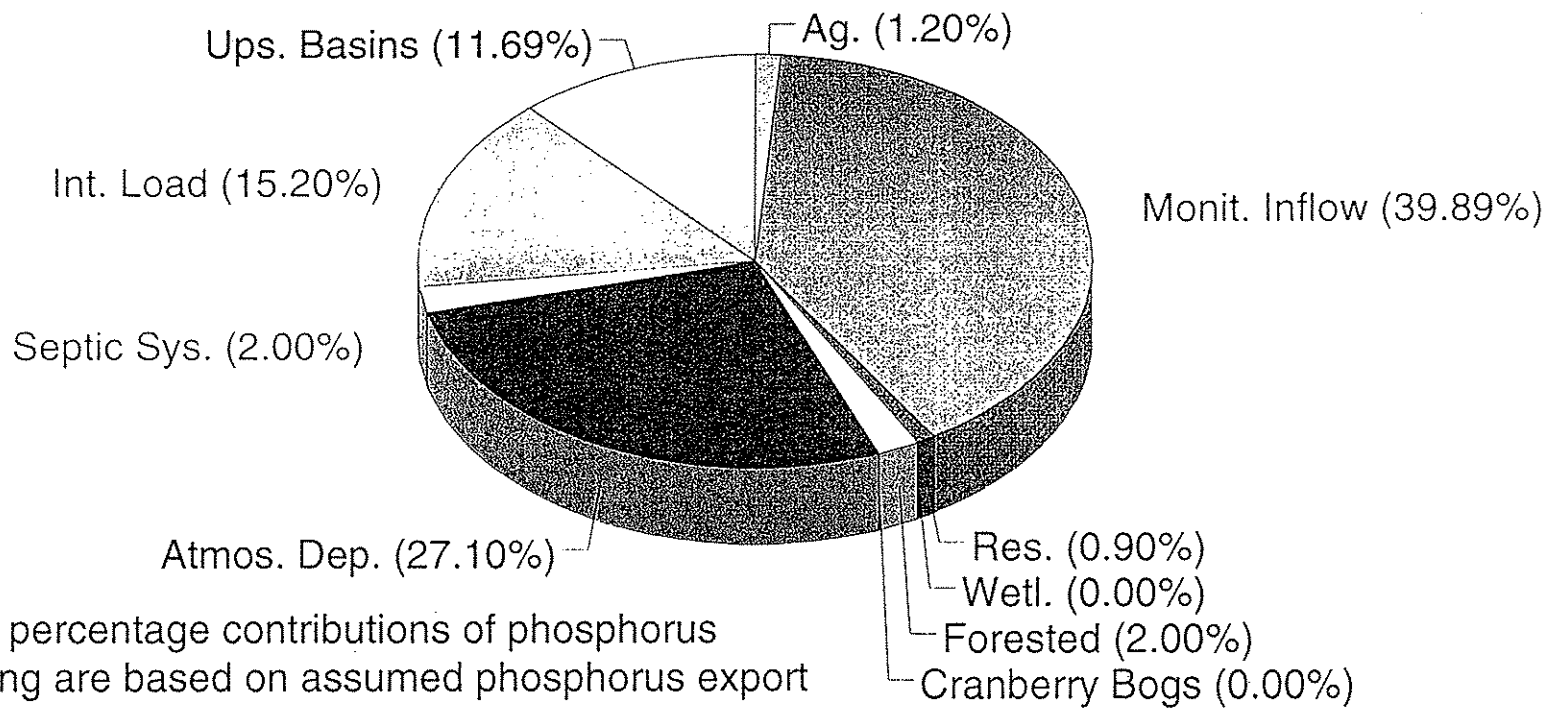

*The percentage contributions of phosphorus loading are based on assumed phosphorus export rate coefficients and modeling results.

Figure 90

5.8.4 Basin D—Musky Bay—Modeling Results

Land use within the 1,127-acre watershed tributary to Basin D (See Figure 1) includes agricultural, residential, wetlands, forested, cranberry bogs, and water. Basin D has a volume of 1,582 acre-feet. The annual phosphorus load to the lake basin is estimated to be 406 pounds (See Figure 91) or 0.26 pounds per acre-foot. Modeling predictions indicate the primary sources of phosphorus are the cranberry bogs (an estimated 43.5 percent of the annual load), forested land (an estimated 14.6 percent of the annual load), wetlands (an estimated 9.2 percent of the annual load) and atmospheric deposition (an estimated 16.8 percent of the annual load). The remaining watershed land uses collectively are estimated to comprise approximately 13.5 percent of the annual load. Waterfowl are estimated to contribute approximately 1 percent of the annual load and septic systems are estimated to comprise less than 2 percent of the annual load (See Figure 92).

An additional analysis of the phosphorus loading to Basin D was completed to further evaluate the modeling results particularly because primary data from the cranberry bogs were not available for this study. The additional analysis was comprised of (1) an evaluation of the non-cranberry farm phosphorus export coefficients used in the study (2) an evaluation of point source (i.e., waterfowl and septic systems) and internal loading estimates used in the study and (3) an evaluation of the cranberry farm phosphorus export coefficients used in the study. The methods section discusses the methods used for the evaluation of export coefficients, point source estimates, and internal loading estimates. Analyses results are discussed in the following paragraphs.

Oxygen measurements were evaluated to determine whether conditions conducive to sediment phosphorus release occurred in Basin D. The measurements indicate that oxygen concentrations within Basin D were greater than 0.5 mg/L throughout the monitoring period. Therefore, the data indicate that internal loading from sediment phosphorus release did not occur.

The conclusion that macrophyte senescence did not result in internal loading was also evaluated. Although a dense macrophyte population was found in Basin D from early summer through ice-in, the bay's thick flocculent sediment layer was believed to retain the macrophytes and prevent phosphorus loading from senescing macrophytes to the overlying waters. The depth of the flocculent sediment layer is estimated to be approximately 5 to 6 feet and the flocculent sediment layer is estimated to occur throughout the bay (Hagen, 1997, Personal Communication). Therefore, senescing macrophytes are believed to sink to the bottom of the flocculent sediment layer and enrich the sediment pore waters rather than enrich the waters overlying the sediment layer.

The results of a number of studies indicate that even if macrophyte senescence were to occur in the waters overlying the sediment layer, phosphorus resulting from senescence would be absorbed by

epiphytic algae, periphyton, and sediments. In laboratory systems, Nichols and Keeney (1973) observed that lake sediment readily absorbed inorganic phosphorus released by plant decomposition. Boston and Perkins (1982) studied the decay of *Myriophyllum spicatum* and, in agreement with Nichols and Keeney (1973), found that phosphorus was retained by the sediment. Experimental studies based on ^{32}P -additions to the water in the littoral zone showed that the larger part of ^{32}P is accumulated in the sediment and in periphyton (Howard-Williams & Allanson 1981). Study results indicated that the phosphorus flow in the *Potamogeton pectinatus* stands of L. Swartvlei was a closed cycle, and any release from decaying macrophytes would rapidly be absorbed by epiphytic algae, periphyton and sediments (Howard-Williams & Allanson 1981). Therefore, if macrophyte senescence were to result in the release of phosphorus to the waters overlying the sediment, it is estimated that the phosphorus would be absorbed by epiphytic algae, periphyton, and sediments. Consequently, it does not appear that additions to the basin's annual phosphorus load would occur from senescing macrophytes. As discussed previously, senescing macrophytes are believed to sink to the bottom of the basin's flocculent sediment layer and enrich the sediment pore waters rather than enrich the waters overlying the sediment layer.

Phosphorus data from Basin D also support the hypothesis that macrophyte senescence is not enriching the basin's waters. An evaluation of 1996 phosphorus data from Basin D indicates that an increase in the lake's epilimnetic in-lake phosphorus concentration occurred during the May through June period (i.e., 0.022 mg/L on May 31 and 0.033 mg/L on June 25). The increase occurred during a period of active plant growth within the basin (i.e., at a time when macrophyte senescence is unlikely to occur). The data indicate phosphorus loading from a source other than macrophyte senescence is enriching the basin. The increase in the basin's phosphorus concentration during the early summer period indicates that phosphorus loading exceeded phosphorus use by plants. During the same period, a decline in epilimnetic in-lake phosphorus concentration occurred in Basins A through C and Basins E through H. The decline is coincident with the use of phosphorus during the early summer period by plants (i.e., primarily algae).

In response to concerns raised by cranberry growers, phosphorus loading estimates from tributary cranberry farms were reevaluated. Specifically, the appropriateness of a higher phosphorus export coefficient from the cranberry bogs tributary to Basin D was reevaluated. First, the lake water quality model was rerun using the lower phosphorus export coefficient used for cranberry bogs tributary to Basins A, B, and E (i.e., 0.62 lbs./ac/yr). The modeling results were examined to determine resultant differences in predicted loading and in-lake phosphorus concentration. Modeling results yielded a predicted annual total phosphorus loading of 55 pounds or approximately 10 percent of the annual phosphorus load to the bay. The lower phosphorus loading by the cranberry bogs yielded a predicted average annual in-lake phosphorus concentration of 0.016 mg/L, which was approximately 30 percent lower than the observed concentration of 0.023 mg/L. To achieve an average annual in-lake phosphorus concentration of 0.023 mg/L, it

would be necessary to double Basin D annual phosphorus loads from residential wetland, and forest land uses and from septic loads, while keeping the annual total phosphorus load from cranberry farms at 55 pounds (i.e., phosphorus export coefficient of 0.62 lbs./ac./yr.). The modeling results indicated the phosphorus export coefficient used for cranberry bogs tributary to Basins A, B, and E was not appropriate to Basin D. Use of a higher phosphorus export coefficient, 2.04 lbs/ac/yr yields a predicted average annual in-lake phosphorus concentration identical with the observed concentration of 0.023 mg/L.

Second, to further evaluate the use of the higher phosphorus export coefficient for the Basin D cranberry farms, the literature data supporting its use were examined. The export rate coefficient is based upon observed phosphorus concentrations in cranberry farm drainage water and an average volume of water drained from a cranberry farm annually. Specifically, the 0.10-0.15 mg/L total phosphorus concentrations observed in cranberry drainage water by Field (1987) was multiplied by the average annual water use of 6 acre-feet per acre of cranberry bog cited by the St. Paul District of the U.S. Army Corps of Engineers (1995) and Hamilton (1971). This results in a range of annual phosphorus export coefficients of 1.63 to 2.44 lbs./ac./yr. The midpoint of the range is 2.04 lbs./ac./yr., and was used for the cranberry farms tributary to Basin D. An evaluation of data collected from the Manitowish Waters cranberry farm area (Konrad and Bryans, 1974) indicated soluble phosphorus concentrations observed during the 1972 discharge from bed discharges were approximately 0.300 mg/L. Data collected from Thunder Lake (Dunst et al. 1982) indicated total phosphorus concentrations in effluent waters from four cranberry beds during the fall of 1980 ranged from 0.061 mg/L to 0.331 mg/L (average effluent concentration from the four beds was 0.142 mg/L). Data collected from Thunder Lake (Dunst et al. 1982) indicated total phosphorus concentrations in effluent waters from six cranberry beds during the spring of 1981 ranged from 0.113 mg/L to 0.234 mg/L (average effluent concentration from the four beds was 0.181 mg/L).

Farming practices of the cranberry farms tributary to Basin D were evaluated to identify differences from other cranberry farms tributary to Basins A, B, and F because different farming practices may result in differences in phosphorus export. The cranberry farms tributary to Basin D apply fertilizer via aerial spraying methodology rather than the ground application methods employed by cranberry farms near Basins A, B, and F. Ground application methods prevent aerial drifting of fertilizer onto non-target areas. The results of an aerial spray study indicate aerial spraying results in surface runoff concentrations roughly 3.5 times greater than applications to the ground (Riekerk, 1989 and Riekerk, 1997, Personal Communication). The assumed phosphorus export rate coefficient for Basin D cranberry farms (i.e., aerial application of fertilizers) is approximately 3.2 times greater than the export coefficients used for other Lac Courte Oreilles cranberry farms (i.e., ground application of fertilizers), consistent with the reported differences in fertilizer application practices.

Lac Courte Oreilles Estimated Annual Phosphorus Inputs (kg)*

Basin D

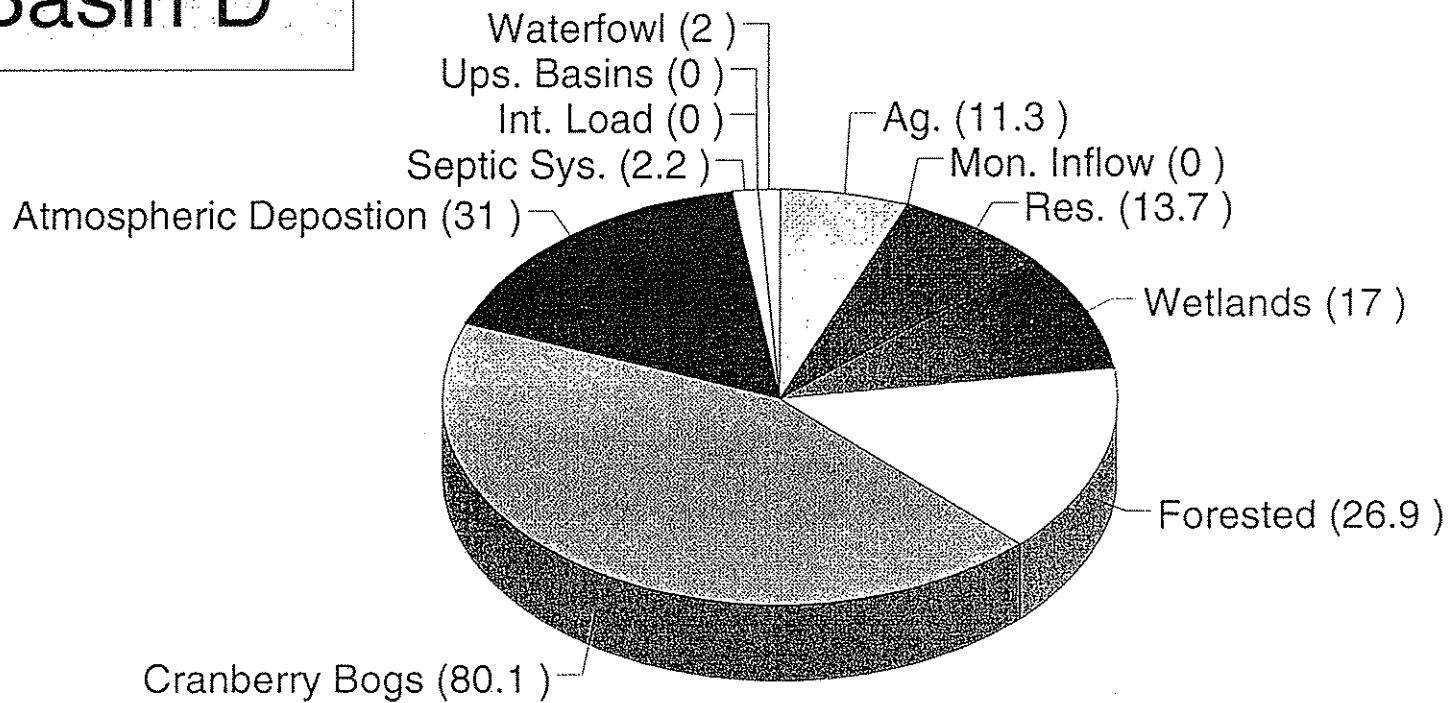

*The total annual contributions of phosphorus loading are estimated based on assumed phosphorus export rate coefficients and modeling results.

Figure 91

Lac Courte Oreilles Estimated Annual Phosphorus Inputs (%)*

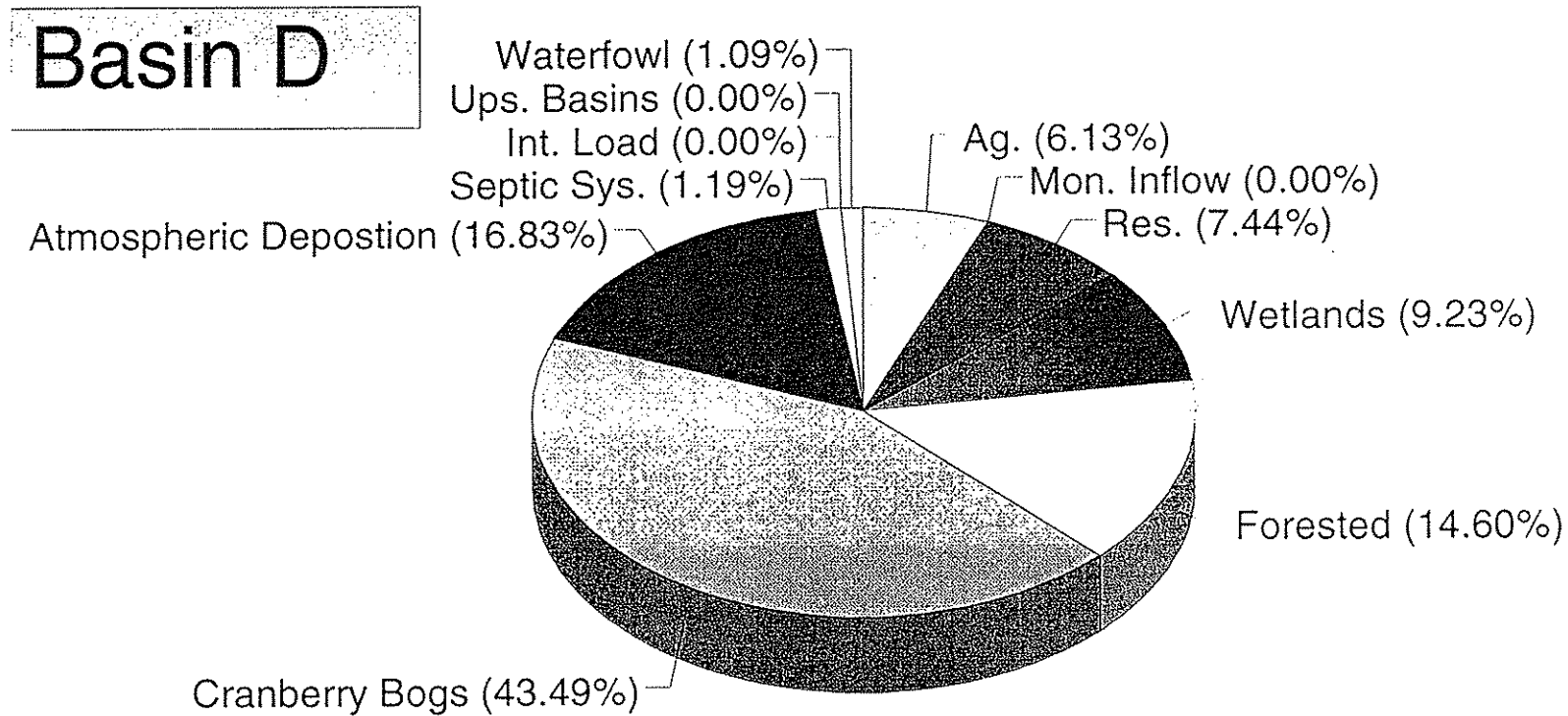

*The percentage contributions of phosphorus loading are estimated based on assumed phosphorus export rate coefficients and modeling results.

Figure 92

5.8.5 Basin E—Stukey Bay—Modeling Results

Land use within the 416-acre watershed tributary to Basin E (See Figure 1) includes agricultural, residential, wetlands, forested, and water. Basin E has a volume of 1,323 acre-feet. The annual phosphorus load to the lake basin is estimated to be 78.7 pounds (See Figure 93) or 0.06 pounds per acre-foot. The primary sources of phosphorus are agricultural (an estimated 38.7 percent of the annual load) and atmospheric deposition (an estimated 31.7 percent of the annual load). Forested land is another important phosphorus source and comprises approximately 18.2 percent of the annual load. The remaining watershed land uses collectively are estimated to comprise approximately 4.5 percent of the annual load. Septic systems are estimated to comprise 7 percent of the annual load (See Figure 94).

5.8.6 Basin F—Chicago Bay—Modeling Results

Land use within the 560-acre watershed tributary to Basin F (See Figure 1) includes agricultural, residential, wetlands, forested, cranberry bogs, and water. Basin F has a volume of 1,636 acre-feet. The annual phosphorus load to the lake basin is estimated to be 151 pounds (See Figure 95) or 0.09 pounds per acre-foot. The primary sources of phosphorus are atmospheric deposition (an estimated 45.3 percent of the annual load) and forested land (an estimated 24.7 percent of the annual load). The remaining watershed land uses collectively comprise approximately 28.0 percent of the annual load. Septic systems are estimated to comprise approximately 2 percent of the annual load (See Figure 96).

Lac Courte Oreilles Estimated Annual Phosphorus Inputs (kg)*

Basin E

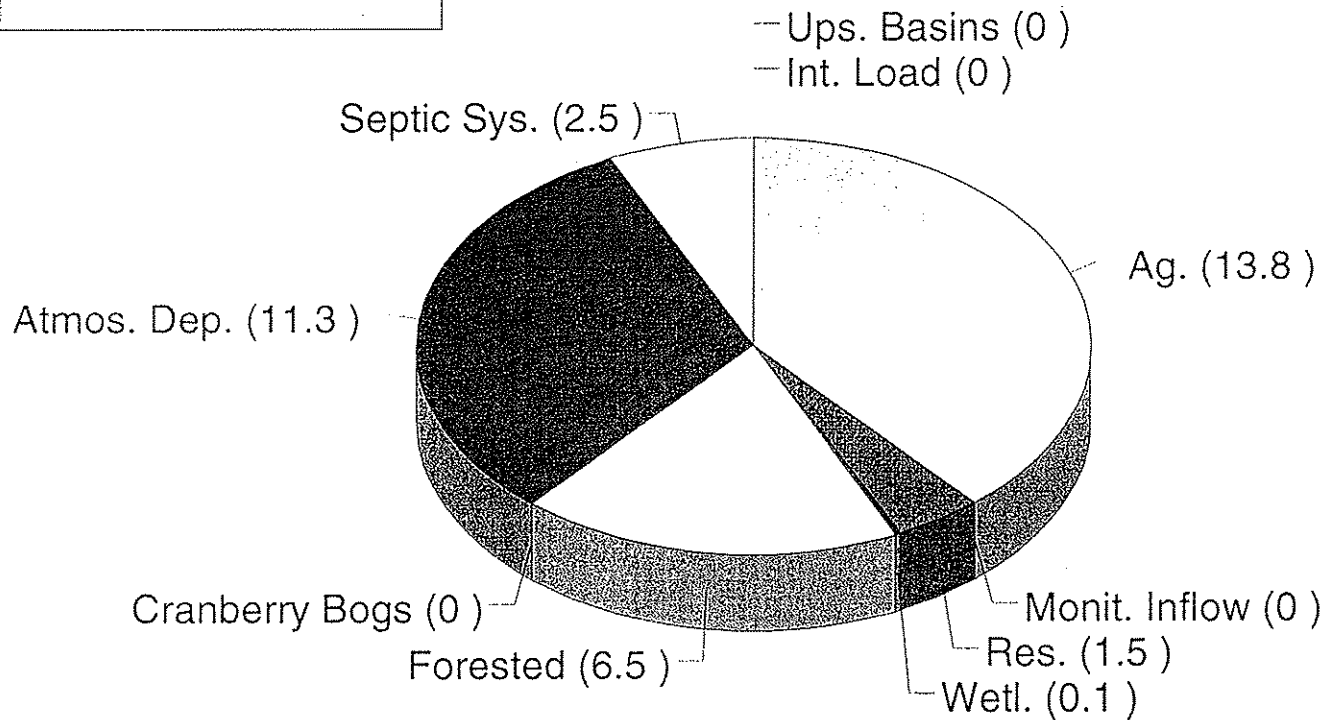

*The total annual contributions of phosphorus loading are based on assumed phosphorus export rate coefficients and modeling results.

Figure 93

Lac Courte Oreilles Estimated Annual Phosphorus Inputs (%)*

Basin E

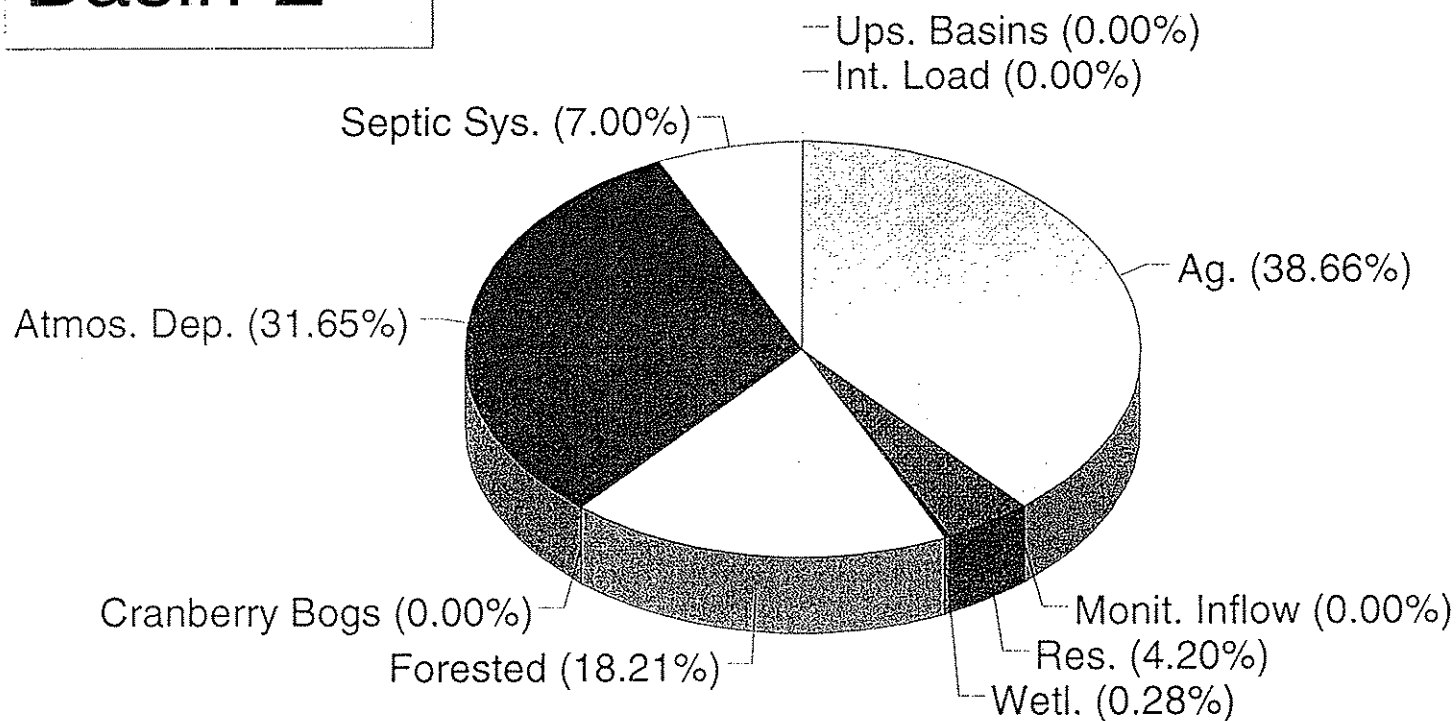

*The percentage contributions of phosphorus loading are based on assumed phosphorus export rate coefficients and modeling results.

Figure 94

Lac Courte Oreilles Estimated Annual Phosphorus Inputs (kg)*

Basin F

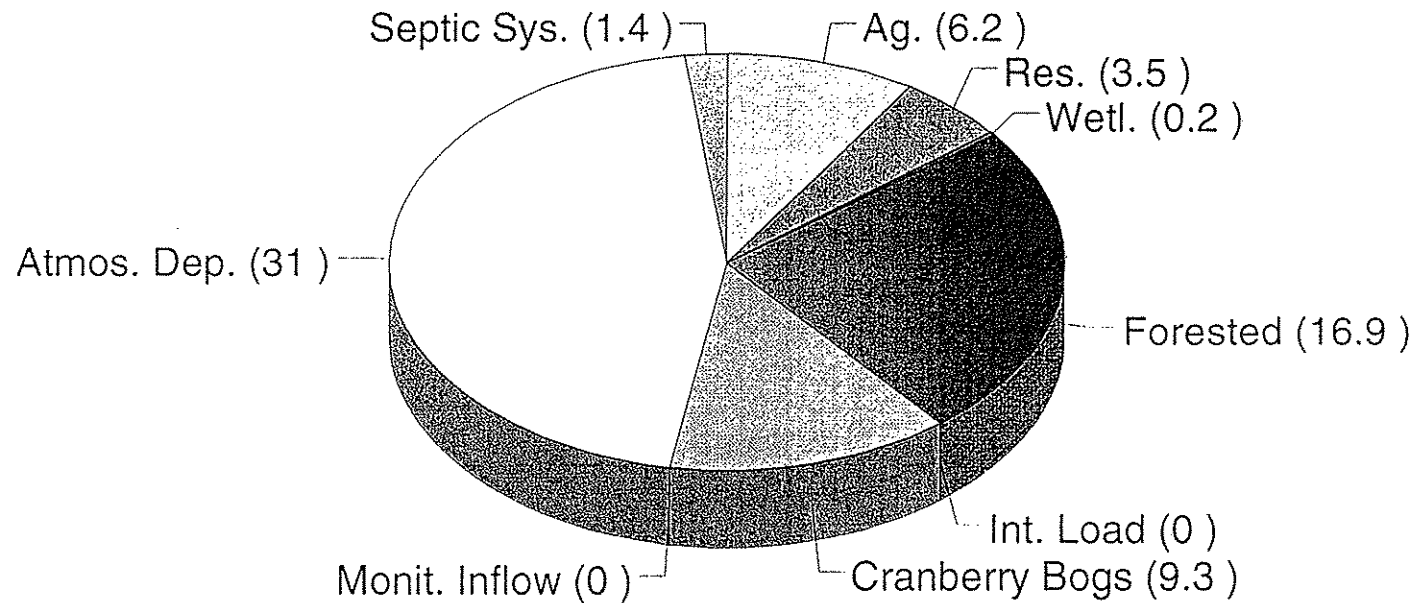

*The total annual contributions of phosphorus loading are estimated based on assumed phosphorus export rate coefficients and modeling results.

Figure 95

Lac Courte Oreilles Estimated Annual Phosphorus Inputs (%)*

Basin F

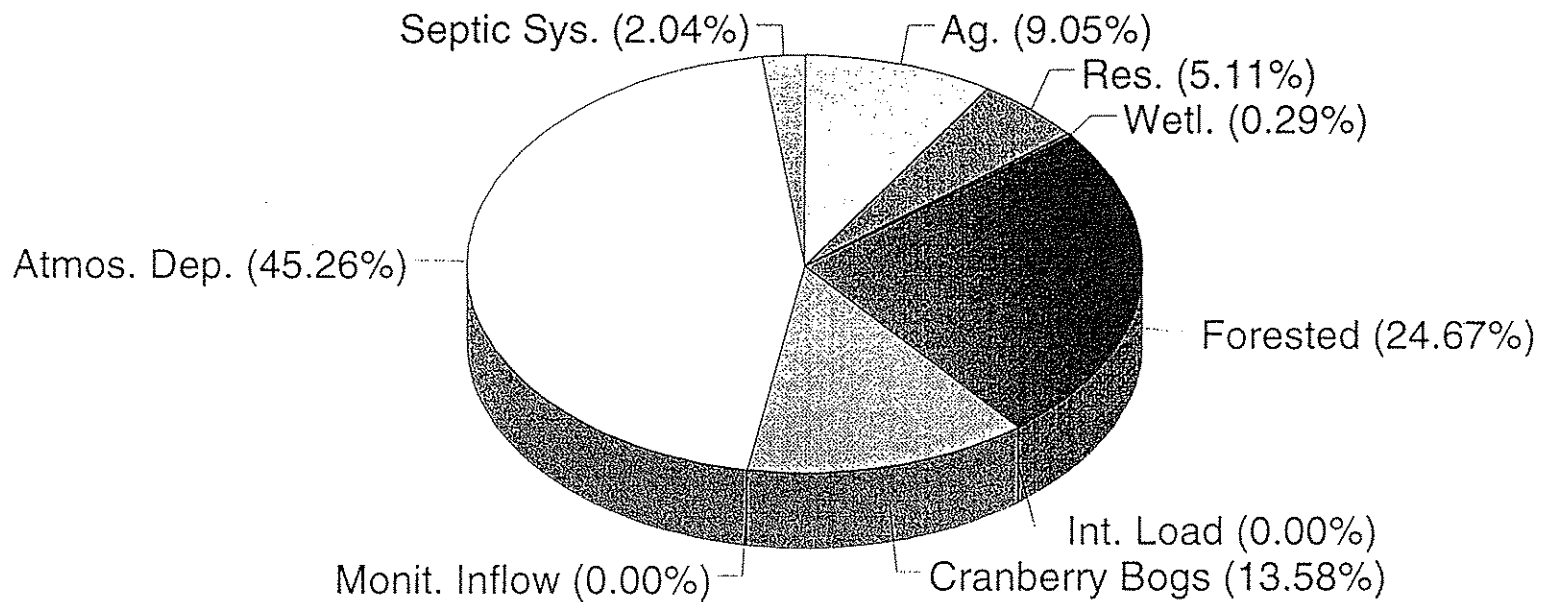

*The percentage contributions of phosphorus loading are estimated based on assumed phosphorus export rate coefficients and modeling results.

Figure 96

5.8.7 Basin G—Grindstone Bay—Modeling Results

Land use within the 283-acre watershed tributary to Basin G (See Figure 1) includes residential, forested, and water, including the inflow from Grindstone Lake. Basin G has a volume of 904 acre-feet. The annual phosphorus load to the lake basin is estimated to be 455 pounds (See Figure 97) or 0.50 pounds per acre-foot. The primary source of phosphorus is the inflow from Grindstone Lake (an estimated 87.3 percent). The remaining watershed land uses collectively are estimated to comprise approximately 6.9 percent of the annual load. Atmospheric deposition is estimated to comprise less than 4 percent of the annual load; septic systems are estimated to comprise less than 2 percent of the annual load (See Figure 98).

5.8.8 Basin H—Northeast Bay—Modeling Results

Land use within the 367-acre watershed tributary to Basin H (See Figure 1) includes residential, forested, and water. Basin H has a volume of 903 acre-feet. The annual phosphorus load to the lake basin is estimated to be 53.1 pounds (See Figure 99) or 0.06 pounds per acre-foot. The primary sources of phosphorus are forested lands (an estimated 38.2 percent of the annual load), atmospheric deposition (an estimated 31.1 percent of the annual load), and residential land use (an estimated 20.3 percent of the annual load). Septic systems are estimated to comprise 10.4 percent of the annual load (See Figure 100).

5.8.9 Model Calibration

Each of the phosphorus input loadings was used to calibrate the lake mass balance model to the water quality observed in each of the lake's basins during 1996. The calibrated model predicts an average total phosphorus concentration that is the same as the observed average epilimnetic (i.e., surface water, upper 6 feet) total phosphorus concentration in Basins A, B, C, and D (See Figure 101). The predicted total phosphorus concentrations in Basins E, F, G, and H were slightly higher than the observed average epilimnetic total phosphorus concentration (See Figure 101).

Lac Courte Oreilles Estimated Annual Phosphorus Inputs (kg)*

Basin G

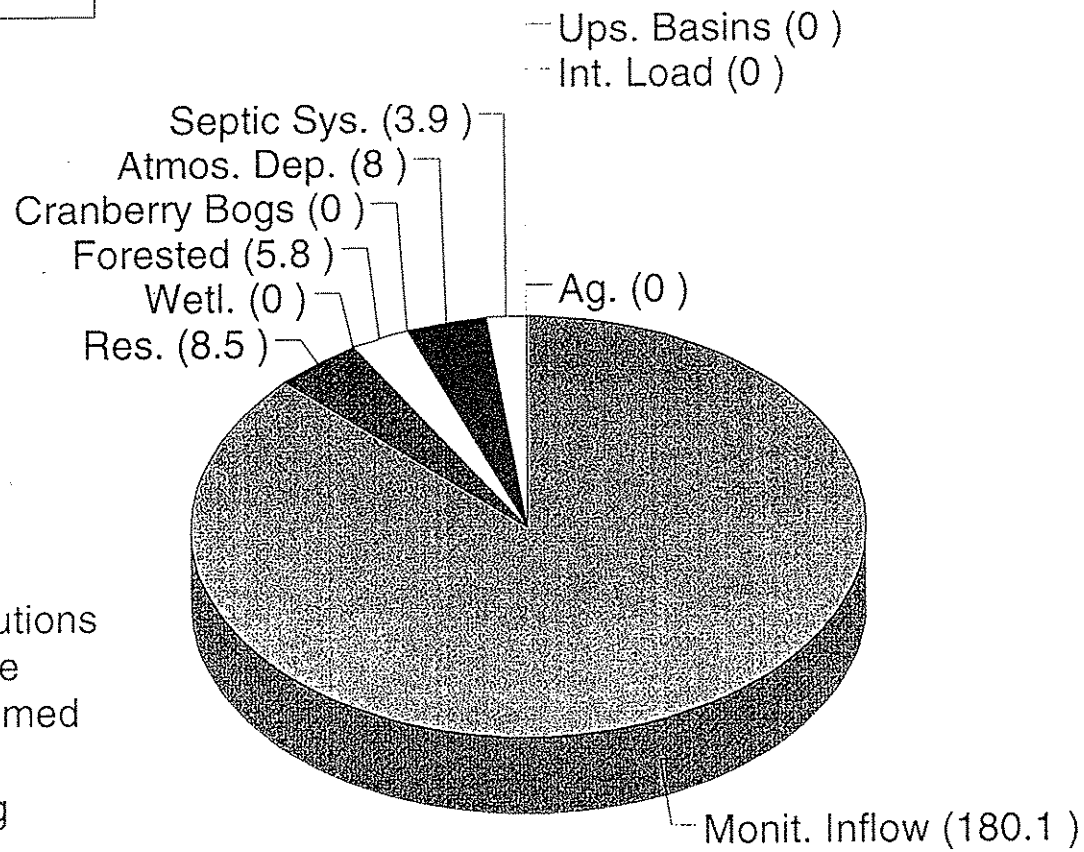

*The total annual contributions of phosphorus loading are estimated based on assumed phosphorus export rate coefficients and modeling results.

Figure 97

Lac Courte Oreilles Estimated Annual Phosphorus Inputs (%)*

Basin G

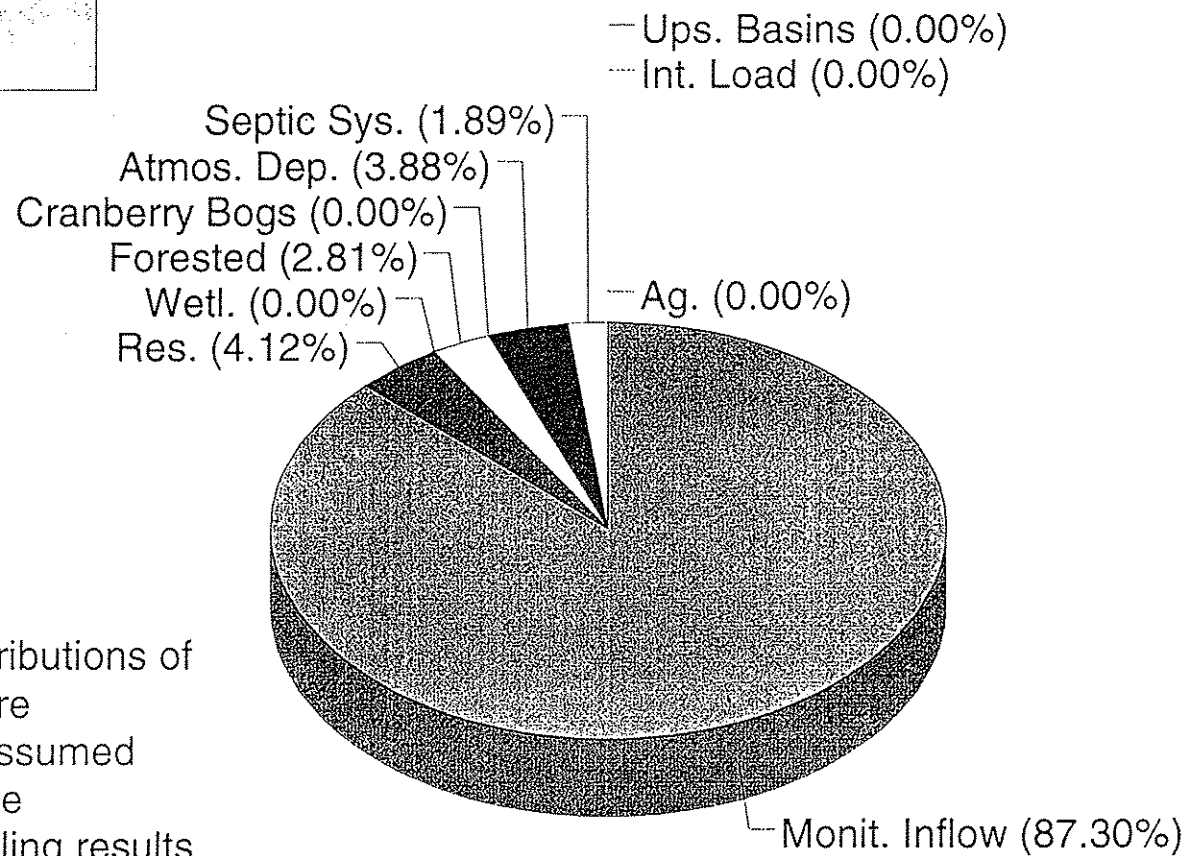

*The percentage contributions of phosphorus loading are estimated based on assumed phosphorus export rate coefficients and modeling results

Figure 98

Lac Courte Oreilles Estimated Annual Phosphorus Inputs (kg)*

Basin H

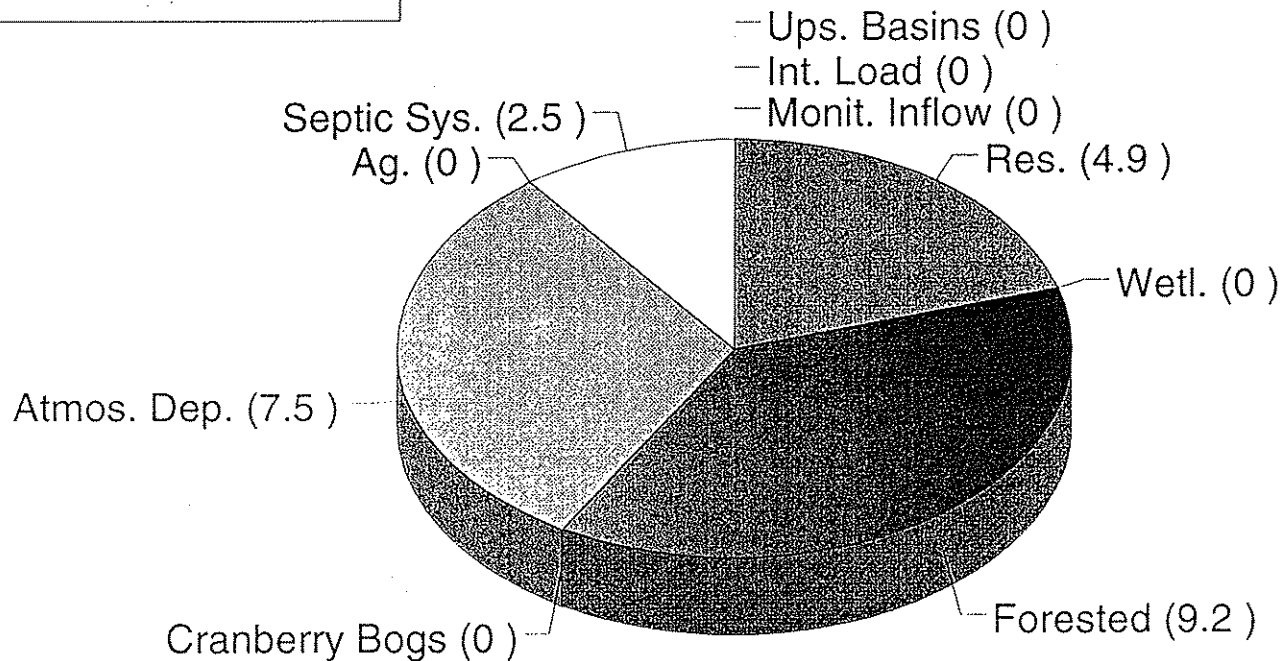

*The total annual contributions of phosphorus loading are estimated based on assumed phosphorus export rate coefficients and modeling results

Figure 99

Lac Courte Oreilles Estimated Annual Phosphorus Inputs (%)*

Basin H

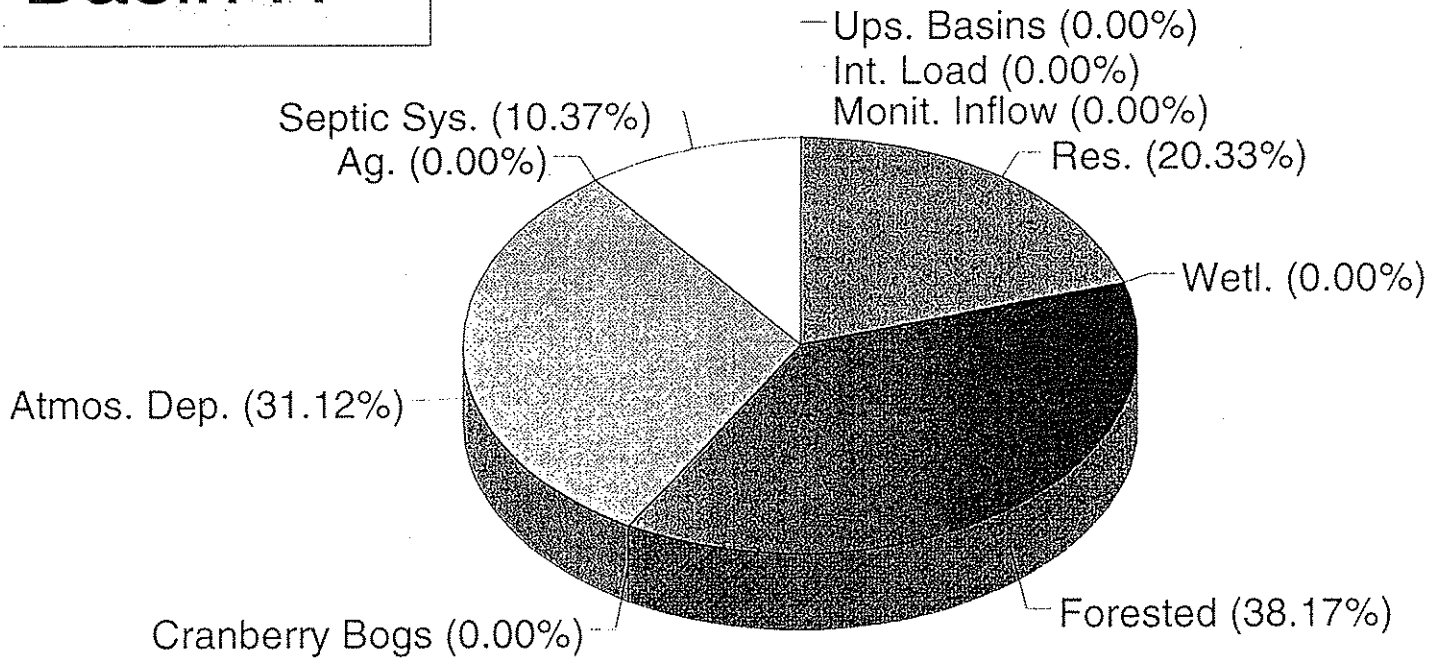

*The percentage contributions of phosphorus loading are estimated based on assumed phosphorus export rate coefficients and modeling results

Figure 100

Lac Courte Oreilles: Predicted* and Observed Total Phosphorus Conc.

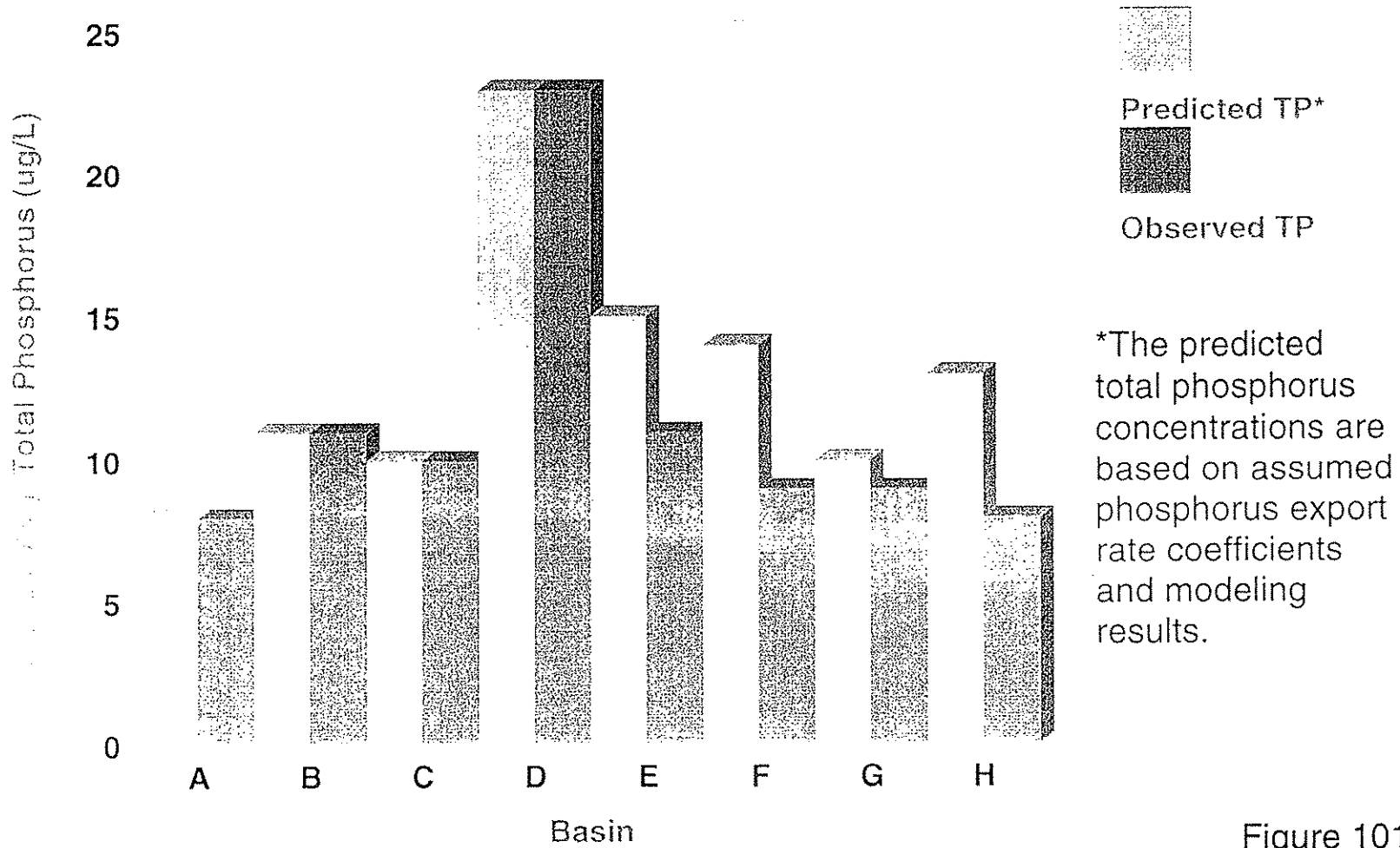

Figure 101

5.9 Cultural Eutrophication Impacts on Lac Courte Oreilles

All land use practices within a lake's watershed impact a lake and determine its water quality. Impacts result from the export of sediment and nutrients, primarily phosphorus, to a lake from its watershed. Each land use contributes a different quantity of phosphorus to the lake, thereby, impacting the lake's water quality differently. Land uses resulting from human activities generally accelerate the natural eutrophication process of a lake. These land uses generally contribute larger quantities of phosphorus to a lake than the natural land uses occurring prior to development. Cultural eutrophication describes the acceleration of the natural eutrophication process caused by human activities. The impacts of cultural eutrophication on Lac Courte Oreilles were evaluated. An assessment of land uses within the lake's tributary watershed indicates three types of land uses are a result of human activities. The land uses and their contributions to the estimated annual total phosphorus loads of lake.bays include:

- **Agriculture**—phosphorus loading from agricultural land use (i.e., does not include cranberry bogs) comprises an estimated 38.7 percent of the annual phosphorus load to Basin E. Annual spring algal blooms within the bay may be correlated with runoff from fertilized farm fields within the tributary watershed. The algal blooms occur in the near shore areas (See Figure 102) and cause the water quality of the basin to be poorer than are indicated from measurements from the basin's central sampling location.

Phosphorus loading from agricultural land use comprises less than 10 percent of the estimated annual phosphorus load to other lake basins. Specifically, estimated phosphorus loads from agricultural land use comprise approximately 1.7 percent of the estimated annual phosphorus load to Basin B, approximately 1.2 percent of the estimated annual phosphorus load to Basin C, approximately 6.1 percent of the estimated annual phosphorus load to Basin D, and approximately 9.1 percent of the estimated annual phosphorus load to Basin F. Contributions from agricultural land use were not noted in the estimated annual phosphorus loads to Basins A, G, and H.

- **Cranberry Bog**—phosphorus loading from cranberry farms tributary to Basin D (Musky Bay) are estimated to comprise approximately 43.5 percent of the bay's estimated annual phosphorus load. Phosphorus loading from cranberry bogs comprises less than 15 percent of the estimated annual phosphorus loads to other lake basins. Specifically, estimated phosphorus loads from cranberry bogs comprise approximately 0.1 percent of the estimated annual phosphorus load to Basin A, approximately 7.0 percent of the estimated annual

phosphorus load to Basin B, and approximately 13.6 percent of the estimated annual phosphorus load to Basin F. Contributions from cranberry bogs were not noted in the estimated annual phosphorus loads to Basins C, E, G, and H.

- **Residential**—residential land use comprises an estimated 20.3 percent of the annual phosphorus load to Basin H. Phosphorus loading from residential land use comprises less than 10 percent of the estimated annual phosphorus loads to other lake basins. Specifically, estimated phosphorus loads from residential land use comprise approximately 6.8 percent of the estimated annual phosphorus load to Basin A, approximately 6.0 percent of the estimated annual phosphorus load to Basin B, approximately 0.9 percent of the estimated annual phosphorus load to Basin C, approximately 7.4 percent of the estimated annual phosphorus load to Basin D, approximately 4.2 percent of the estimated annual phosphorus load to Basin E, approximately 5.1 percent of the estimated annual phosphorus load to Basin F, and approximately 4.1 percent of the estimated annual phosphorus load to Basin G.

The impacts of cultural eutrophication on Lac Courte Oreilles were estimated by modeling pre-development in-lake phosphorus concentrations and comparing estimated pre-development phosphorus concentrations with current phosphorus concentrations (i.e., post-development conditions).

Three modeling scenarios were completed for each lake basin to assess cultural eutrophication impacts:

1. Estimated in-lake phosphorus concentration assuming forest land use (i.e., pre-development condition) instead of residential land use (i.e., current or post-development condition) in the basins' tributary watersheds;
2. Estimated in-lake phosphorus concentration assuming forest land use (i.e., pre-development condition) instead of agricultural land use and (i.e., current or post-development condition) in the basins' tributary watersheds; and
3. Estimated in-lake phosphorus concentration assuming natural wetlands (i.e., pre-development condition) instead of cranberry farm land use (i.e., current or post-development condition) in the basins' tributary watersheds.

The model indicates that the conversion of forest land use to agricultural land use results in the following estimated changes in epilimnetic total phosphorus concentration for the basins (see Figure 103):

- No increase in total phosphorus concentration was estimated for Basin B;
- A 1 µg/L increase in total phosphorus concentration was estimated for Basins C and F;
- A 2 µg/L increase in total phosphorus concentration was estimated for Basin D;
- A 4 µg/L increase in total phosphorus concentration was predicted for Basin E.

Agricultural land use was not found in the watersheds tributary to Basins A, G, and H.

The model indicates that the assumed conversion of forest land use to agricultural land use in the watersheds tributary to Basins B, C, D and F does not result in noticeable water quality changes. The no noticeable change prediction is based upon estimated 0 to 2 µg/L increased in-lake total phosphorus concentrations within Basins B, C, D and F. The estimated 0 to 2 µg/L change in total phosphorus concentrations has resulted in an estimated decrease in the average annual Secchi disc transparency of 0 to 0.2 meters (0.7 feet), using the predicted relationship between phosphorus and chlorophyll and the predicted relationship between chlorophyll and Secchi disc developed by the Minnesota Pollution Control Agency for phosphorus-limited lakes (Heiskary et al. 1990).

The model indicates that the assumed conversion of forest land use to agricultural land use in the watershed tributary to Basin E results in a noticeable water quality change. An estimated 4 µg/L increase in the basin's total phosphorus concentration results from the assumed conversion of forest land use to agricultural land use in the basin's tributary watershed. The estimated change in phosphorus concentration results in an estimated decrease in the average annual Secchi disc transparency of 1.2 meters (3.8 feet), using the predicted relationship between phosphorus and chlorophyll and the predicted relationship between chlorophyll and Secchi disc developed by the Minnesota Pollution Control Agency for phosphorus-limited lakes (Heiskary et al. 1990).

The model indicates that the assumed conversion of natural wetlands to cranberry farm land use results in the following estimated changes in epilimnetic total phosphorus concentration for the basins (see Figure 104):

- No increase in total phosphorus concentration was estimated for Basin A (6 acres of cranberry bogs);
- A 1 µg/L increase in total phosphorus concentration was estimated for Basin B (70 acres of cranberry bogs);
- A 2 µg/L increase in total phosphorus concentration was estimated for Basin F (33 acres of cranberry bogs);
- A 10 µg/L increase in total phosphorus concentration was predicted for Basin D (88 acres of cranberry bogs).

Cranberry farm land use was not found in the watersheds tributary to Basins C, E, G, and H.

The model indicates that the assumed conversion of natural wetland land use to cranberry farm land use in the watersheds tributary to Basins A, B, and F does not result in noticeable water quality changes. The no noticeable change estimate is based upon estimated 0 to 2 µg/L increased in-lake total phosphorus concentrations within Basins A, B, and F. The estimated 0 to 2 µg/L change in total phosphorus concentrations results in an estimated decrease in the average annual Secchi disc transparency of 0 to 0.2 meters (0.7 feet), using the predicted relationship between phosphorus and chlorophyll and the predicted relationship between chlorophyll and Secchi disc developed by the Minnesota Pollution Control Agency for phosphorus-limited lakes (Heiskary et al. 1990).

The model indicates that the assumed conversion of natural wetland land use to cranberry farm land use in the watershed tributary to Basin D results in a noticeable water quality change. An estimated 10 µg/L increase in the basin's total phosphorus concentration results from the assumed conversion of natural wetland land use to cranberry farm land use in the basin's tributary watershed. The estimated change in phosphorus concentration results in an estimated decrease in the average annual Secchi disc transparency of 1.7 meters (5.5 feet), using the predicted relationship between phosphorus and chlorophyll and the predicted relationship between chlorophyll and Secchi disc developed by the Minnesota Pollution Control Agency for phosphorus-limited lakes (Heiskary et al. 1990).

Cultural eutrophication impacts upon Basin D were also modeled per Vighi et al. (1985). Model results support the estimated changes in total phosphorus concentrations from watershed development discussed in the preceding paragraphs.

The model indicates that the assumed conversion of forest land use to residential land use results in the following estimated changes in epilimnetic total phosphorus concentration for the basins (see Figure 105):

- No increase in total phosphorus concentration was estimated for Basin A;
- A 1 µg/L increase in total phosphorus concentration was estimated for Basins B, C, E, F, and G;
- A 2 µg/L increase in total phosphorus concentration was estimated for Basins D and H;

The model indicates that the assumed conversion of forest land use to residential land use in the watersheds tributary to Basins A through H does not result in noticeable water quality changes. The no noticeable change prediction is based upon estimated 0 to 2 µg/L increased in-lake total phosphorus concentrations within Basins A through H. The estimated 0 to 2 µg/L change in total phosphorus concentrations results in an estimated decrease in the average annual Secchi disc transparency of 0 to 0.2 meters (0.7 feet), using the predicted relationship between phosphorus and chlorophyll and the predicted relationship between chlorophyll and Secchi disc developed by the Minnesota Pollution Control Agency for phosphorus-limited lakes (Heiskary et al. 1990).



***Above: Stukey Bay
(Summer 1996)***

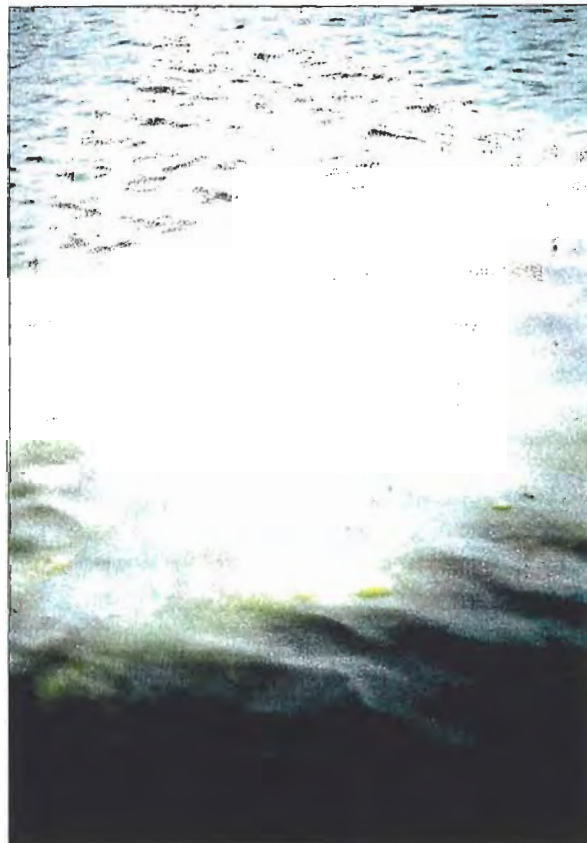

***Right: Stukey Bay
Algal Blooms
(Summer 1996)***

**Figure 102
Stukey Bay Algal Blooms**

Estimated Total Phosphorus Conc.* Forest Vs. Agriculture Land Use

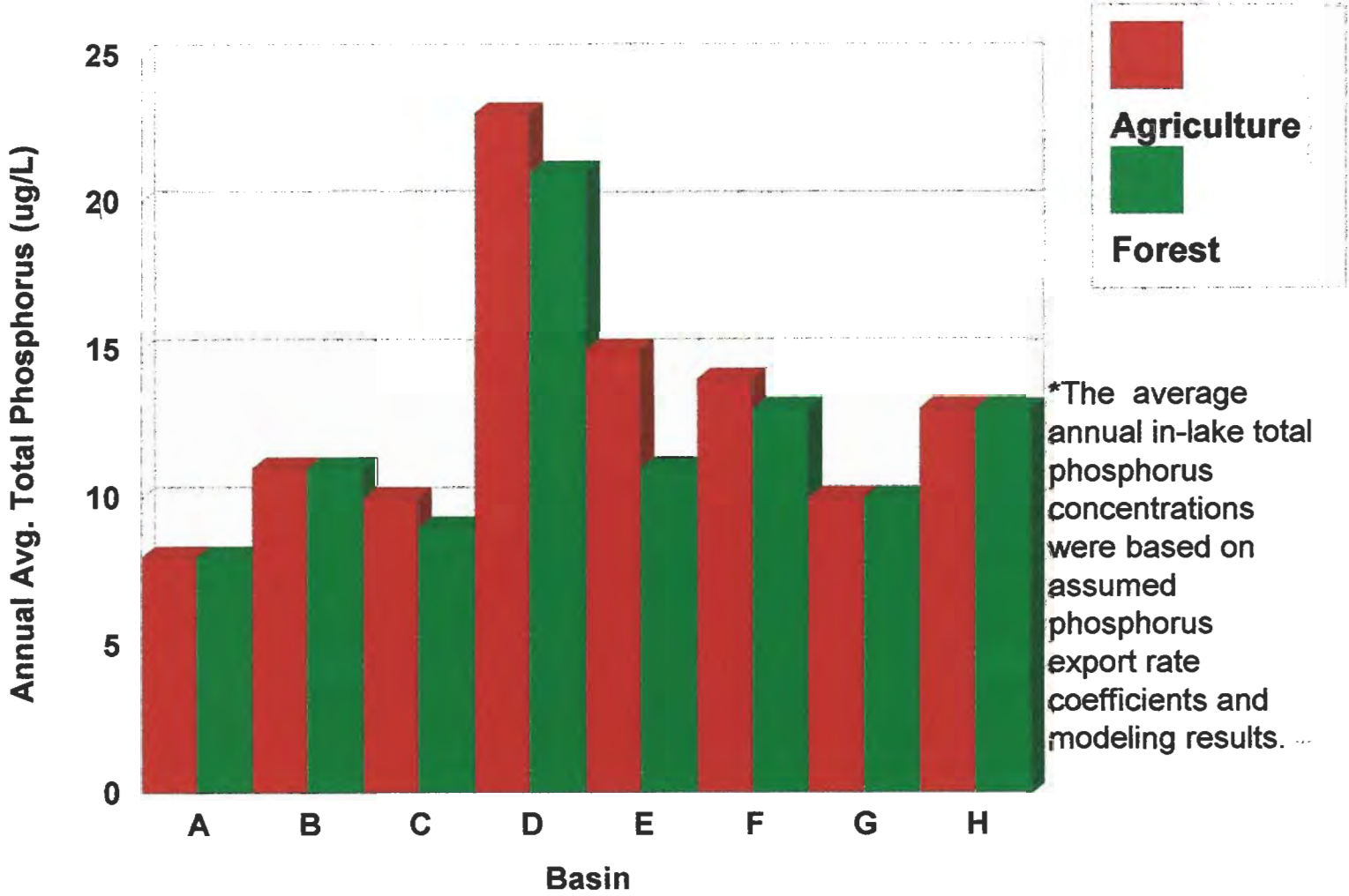
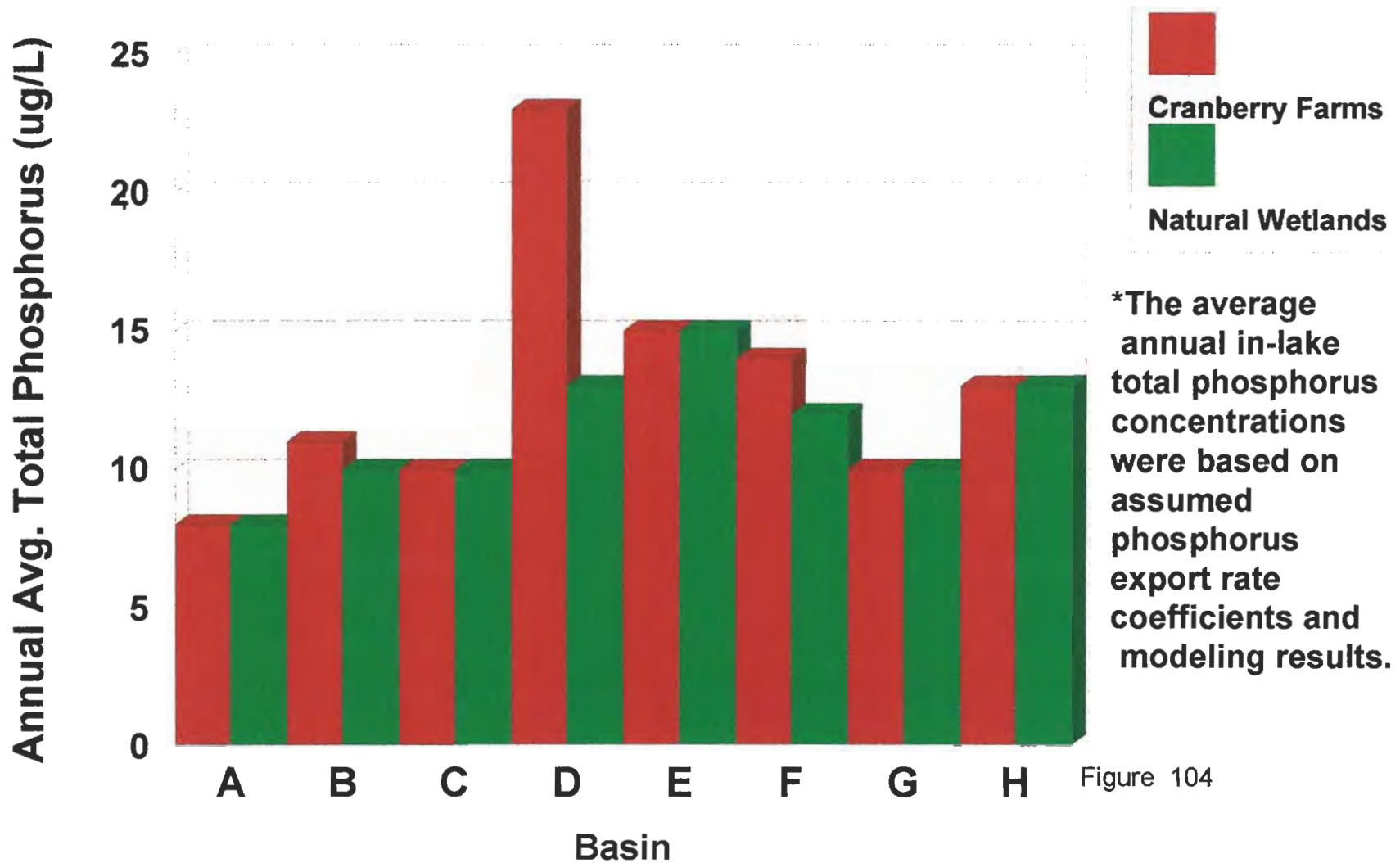

Figure 103

Estimated Total Phosphorus Conc.* Natural Wetlands Vs. Cranberry Farms



*The average annual in-lake total phosphorus concentrations were based on assumed phosphorus export rate coefficients and modeling results.

Figure 104

Estimated Total Phosphorus Conc.* Forest Versus Residential Land Use

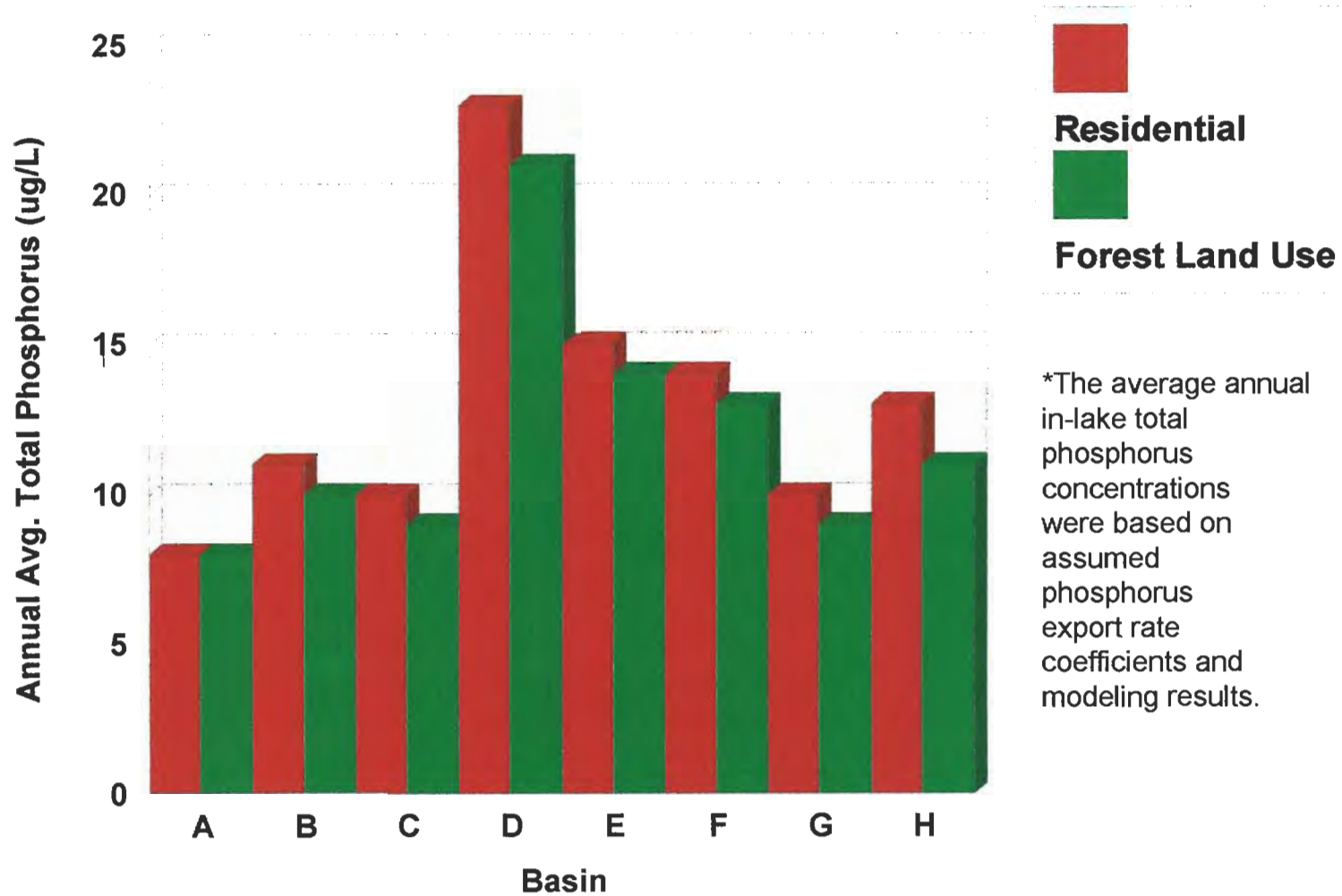

Figure 105

6.0 Recommendations and Management Actions

Completion of a Lake Management Plan for Lac Courte Oreilles is recommended to preserve the existing water quality of the lake and explore water quality improvement options for Basin D. The following project is recommended:

- Additional study of Basin D is recommended to provide additional information for the design of an effective management plan. A water quality and macrophyte study is recommended to provide (1) more detailed information regarding temporal water quality changes during the summer, (2) information regarding spatial changes in water quality during the summer (i.e., collection of samples at several sample locations will help determine the spatial coverage and severity of algal blooms during the summer months), (3) information regarding the coverage, density, and species composition of the macrophyte community, (4) more detailed information regarding waterfowl usage of Basin D, and (5) information regarding the depth of the flocculent sediment layer within Basin D.
- A paleolimnological study of Basin D is recommended to evaluate the rate of accumulation in Basin D over time, back to a time before European settlement of the area. This would be done through the collection and analyses of Basin D sediment cores. Cores would be analyzed by segmenting them into separate strata at various depth intervals; dating each stratum by Lead-210 isotopic techniques; and then subjecting the same samples to testing for organic matter, carbonate, and phosphorus content as indicators of water column fertility. Such a study would provide data on Basin D water quality dating back to the year 1800.
- Development of a management plan for Lac Courte Oreilles is recommended, including (1) the development of a long-term water quality goal for each basin within Lac Courte Oreilles, (2) an evaluation of different watershed development scenarios to determine acceptable (i.e., the water quality of the lake is within the established goal) and unacceptable (i.e., the water quality of the lake fails to meet its goal) development options, (3) the evaluation of watershed best management practices (BMPs) implementation relative to goal achievement under unacceptable development scenarios (i.e., development scenarios that the water quality of the lake fails to meet its goal without BMPs), and (4) the completion of a lake management plan.

References

- Boston, H.L. and H.A. Perkins. 1982. Water Column Impacts of Macrophyte Decomposition Beneath Fiberglass Screens. *Aquat. Bot.* 14:15-27.
- Burwell, R.E., D.R. Timmons and R.F. Holt, 1975. Nutrient Transport in Surface Runoff as Influenced by Soil Cover and Seasonal Periods. *Soil. Sci. Soc. Amer. Proc.* 39: 523-528.
- Carlson, R.E., 1977. A Trophic State Index for Lakes. *Limnology and Oceanography*, 22:2.
- Corsi, S.R., D.J. Graczyk, D.W. Owens, and R.T. Bannerman. 1997. Unit-Area Loads of Suspended Sediment, Suspended Solids, and Total Phosphorus from Small Watersheds in Wisconsin. U.S. Department of the Interior, U.S. Geological Survey, Fact Sheet FS-195-97.
- Dillon, P.J. and F.H. Rigler, 1974. A test of a simple nutrient budget model predicting the phosphorus concentration in lake water. *J. Fish. Res. Bd. Can.* 31: 1771-1778.
- Dunst, R., J. Konrad and L. Maltbey. 1982. Analysis of Thunder Lake study. WDNR. Rhinelander, Wis.
- Field, Stephen J. 1987. Letter to Mr. Harold Kissinger. January 8, 1987, U.S. Geological Survey. Cited in Schreiber, K. 1988. The Impacts of Commercial Cranberry Production on Water Resources. WDNR. Bureau of Water Resources Management.
- Hagen, D. 1997. Personal Communication. Riparian resident of Basin D, Lac Courte Oreilles.
- Hamilton, Louis J. 1971. Water for Cranberry Culture in the Cranmoor Area of Central Wisconsin. U.S. Geological Survey, Water Supply Paper 1999-I. 30 pp.
- Harms, L.L., J.N. Dornbush and J.R. Andersen, 1974. Physical and Chemical Quality of Agricultural Land Runoff. *Journ. Water Poll. Contr. Fed.* 46: 2460-2470.
- Heiskary, S.A. and C.B. Wilson. 1990. Minnesota Lake Water Quality Assessment Report. Minnesota Pollution Control Agency
- Hensler, R.F., R.J. Olsen, S.A. Witzel, O.J. Attoe, W.H. Paulson and R.F. Johannes, 1970. Effect of Method of Manure Handling on Crop Yields, Nutrient Recovery and Runoff Losses. *Trans. ASAE* 13: 726-731.
- Howard-Williams, C. and B.R. Allanson. 1981. Phosphorus cycling in a dense *Potamogeton pectinatus* L. bed. *Oecologia* 49: 56-66.
- Konrad, J.G. and M.A. Bryans. 1974. Analysis of cranberry marsh discharge waters (progress report) WDNR.
- Linsley, R.K., Jr., M.A. Kohler, and J.L.H. Paulhus, 1982. *Hydrology for Engineering*, Third Edition. McGraw-Hill Book Company. New York, New York.
- Masek, L. 1994. Lac Courte Oreilles Pollution Survey -- Septic System Inspection Results. Sawyer County Zoning Administration. Hayward, Wisconsin.
- Mason, E. 1997. Personal Communication. Riparian resident of Basin D, Lac Courte Oreilles

- Meyer, A.F., 1944. Elements of Hydrology, Second Edition. John Wiley and Sons. New York, New York.
- Nichols, D.S. and D.R. Kenney. 1973. Nitrogen and Phosphorus Release from Decaying Water Milfoil. *Hydrobiologia* 42: 509-525.
- North American Lake Management Society (NALMS), 1988. Lake and Reservoir Management: A Guidance Manual. Developed for Office of Research and Development—Corvallis and for Office of Water Criteria and Standards Division. Non-point Source Branch.
- Nurnberg, G.K., 1984. The prediction of internal phosphorus load in lakes with anoxic hypolimnia. *Limnol. Oceanogr.* 29: 111-124.
- Nurnberg, G.K., 1985. Availability of phosphorus upwelling from iron-rich anoxic hypolimnia. *Arch. Hydrobiol.* 104: 459-476.
- Nurnberg, G.K. and R.H. Peters, 1984. The importance of internal phosphorus load to the eutrophication of lakes with anoxic hypolimnia. *Int. Ver. Theor. Angew. Limnol. Verh.* 22: 190-194.
- Nurnberg, G.K., M. Shaw, P.J. Dillon and D.J. McQueen, 1986. Internal phosphorus load in an oligotrophic Precambrian Shield lake with an anoxic hypolimnion. *Can. J. Fish. Aquat. Sci.* 43: 574-580.
- Osgood, R.A., 1989. Assessment of Lake Use – Impairment in the Twin Cities Metropolitan Area. Prepared for the Minnesota Pollution Control Agency. Metropolitan Council Publication 590-89-130. 12 pp.
- Panuska, J.C. and A.D. Wilson, 1994. Wisconsin Lake Model Spreadsheet User's Manual. Wisconsin Department of Natural Resources. Lake Management Program. PUBL-WR-363-94.
- Panuska, J.C. and R.A. Lilly, 1995. Phosphorus Loadings from Wisconsin Watersheds: Recommended Export Coefficients for Agricultural and Forested Watersheds. WDNR Research Management Findings. No. 38, 4 p.
- Riekerk, H. 1989. Forest Fertilizer and Runoff-Water Quality. *In* Soil and Crop Science Society of Florida Proceedings, Riekerk, H., D.G. Neary, and W.J. Swank. 1989. The Magnitude of Upland Silviculture Nonpoint Source Pollution in the South. *In* Proceedings of the Symposium: Forested Wetlands of the Southern United States, July 12-14, Orlando, FL, pp. 8-18.
- Riekerk, H. 1997. Personal Communication.
- Sawyer County Land and Water Conservation Department. 1996. Correspondence to Barr Engineering Company— Land uses within the Lac Courte Oreilles Watershed.
- Scherer, N.M., H.L. Gibbons, K.B. Stoops, and M. Muller. 1994. Nutrient Loading of an Urban Lake by Bird Feces. *Lake and Reserv. Manag.*
- Schreiber, K. 1988. The Impacts of Commercial Cranberry Production on Water Resources. WDNR. Bureau of Water Resources Management.
- Singer, M.J. and R.H. Rust, 1975. Phosphorus in Surface Runoff from a Deciduous Forest. *J. Environ. Quality* 4: 307-311.

U.S. Army Corps of Engineers. 1995. St. Paul District Analysis Regarding Section 404 Review of Commercial Cranberry Operations. St. Paul, MN.

Vighi, M. and G. Chiaudani. 1985. A Simple Method to Estimate Lake Phosphorus Concentrations Resulting from Natural Background Loadings Water Research. 19: 987-991.

Walker, W.W., Jr., 1987. Empirical Methods for Predicting Eutrophication in Impoundments. Report 4. Phase III: Applications Manual. Technical Report E-81-9.

WDNR. 1994. Draft Final Report -- An Appraisal of the Surface Water Resources of the Balsam Branch Priority Watershed. Polk County Land Conservation Department.

Appendix A

In-Lake Water Quality Data

LAC COURTE OREILLES WATER QUALITY DATA

1996 Lake Water Quality Data
 Station: COR-B

Date	Max. Depth (meters)	Secchi Disc (meters)	Depth (meters)	Chl. a (ug/L)	Temp. (C)	D.O. (mg/L)	Cond. (Umhos/cm @ 25 C)	pH (S.U.)	TDS (mg/L)	Total P (mg P/L)	Sol. React. P (mg P/L)	NH3 (mg N/L)	N03 + N02 (mg N/L)	TKN (mg N/L)	Alk. (mg/L)	
05/29/96	20.5	3.3	0-2	6.32	--	--	101	7.91	--	0.016	ND	ND	ND	0.3	44	
			6.0	--	--	--	--	--	--	0.014	--	--	--	--	--	
			10.0	--	--	--	--	--	--	--	0.012	--	--	--	--	--
			14.0	--	--	--	--	--	--	--	0.021	--	--	--	--	--
			16.0	--	--	--	--	--	--	--	0.020	--	--	--	--	--
			18.0	--	--	--	--	--	--	--	0.032	--	--	--	--	--
			BOTTOM	19.0	--	--	--	--	--	--	--	0.037	--	--	--	--
05/31/96	19.1	3.6	0	--	14.52	11.73	99	8.47	--	--	--	--	--	--	--	
			1	--	14.48	11.73	99	8.37	--	--	--	--	--	--	--	
			2	--	14.21	11.77	99	8.29	--	--	--	--	--	--	--	
			3	--	13.33	11.96	99	8.19	--	--	--	--	--	--	--	
			4	--	12.53	11.77	101	8.01	--	--	--	--	--	--	--	
			5	--	12.34	11.77	101	7.92	--	--	--	--	--	--	--	
			6	--	12.14	11.72	100	7.88	--	--	--	--	--	--	--	
			7	--	11.99	11.41	102	7.61	--	--	--	--	--	--	--	
			8	--	11.86	11.40	100	7.66	--	--	--	--	--	--	--	
			9	--	11.59	11.20	102	7.65	--	--	--	--	--	--	--	
			10	--	11.27	10.80	101	7.36	--	--	--	--	--	--	--	
			11	--	10.66	10.01	102	7.03	--	--	--	--	--	--	--	
			12	--	10.26	9.69	103	6.90	--	--	--	--	--	--	--	
			13	--	9.94	9.12	104	6.82	--	--	--	--	--	--	--	
			14	--	9.30	8.21	102	6.60	--	--	--	--	--	--	--	
			15	--	8.89	7.66	103	6.50	--	--	--	--	--	--	--	
			16	--	8.49	6.42	102	6.40	--	--	--	--	--	--	--	
			17	--	8.43	5.74	102	6.36	--	--	--	--	--	--	--	
			18	--	8.27	5.43	103	6.34	--	--	--	--	--	--	--	
BOTTOM	19	--	8.19	4.46	104	6.28	--	--	--	--	--	--				

LAC COURTE OREILLES WATER QUALITY DATA

1996 Lake Water Quality Data
 Station: COR-B

Date	Max. Depth (meters)	Secchi Disc (meters)	Depth (meters)	Chl. a (ug/L)	Temp. (C)	D.O. (mg/L)	Cond. (Umhos/cm @ 25 C)	pH (S.U.)	TDS (mg/L)	Total P (mg P/L)	Sol. React. P (mg P/L)	NH3 (mg N/L)	N03 + N02 (mg N/L)	TKN (mg N/L)	Alk. (mg/L)
06/18/96	18.0	4.5	0	--	20.22	9.49	101	8.11	66	--	--	--	--	--	--
			1	--	20.33	9.43	101	8.09	65	--	--	--	--	--	--
			2	--	20.23	9.42	101	8.08	66	--	--	--	--	--	--
			3	--	20.24	9.43	101	8.07	66	--	--	--	--	--	--
			4	--	20.20	9.43	101	8.05	63	--	--	--	--	--	--
			5	--	20.16	9.45	101	8.04	65	--	--	--	--	--	--
			6	--	19.08	9.55	101	8.02	66	--	--	--	--	--	--
			7	--	18.80	10.96	101	8.17	68	--	--	--	--	--	--
			8	--	18.55	10.19	101	7.98	68	--	--	--	--	--	--
			9	--	18.55	10.19	101	7.45	68	--	--	--	--	--	--
			10	--	11.53	9.71	101	7.22	60	--	--	--	--	--	--
			11	--	10.47	9.06	102	7.02	70	--	--	--	--	--	--
			12	--	10.18	7.02	102	6.88	70	--	--	--	--	--	--
			13	--	10.15	6.02	102	6.83	70	--	--	--	--	--	--
			14	--	9.41	2.34	101	6.64	62	--	--	--	--	--	--
			15	--	9.30	1.37	103	6.60	68	--	--	--	--	--	--
			16	--	9.25	0.84	102	6.68	67	--	--	--	--	--	--
BOTTOM			17	--	9.23	0.68	102	6.62	70	--	--	--	--	--	

LAC COURTE OREILLES WATER QUALITY DATA

1996 Lake Water Quality Data
 Station: COR-B

Date	Max. Depth (meters)	Secchi Disc (meters)	Depth (meters)	Chl. a (ug/L)	Temp. (C)	D.O. (mg/L)	Cond. (Umhos/cm @ 25 C)	pH (S.U.)	TDS (mg/L)	Total P (mg P/L)	Sol. React. P (mg P/L)	NH3 (mg N/L)	N03 + N02 (mg N/L)	TKN (mg N/L)	Alk. (mg/L)		
08/09/96	20.0	4.0	0	--	22.46	9.92	102	8.38	66	--	--	--	--	--	--		
			1	--	22.39	9.87	101	8.39	65	--	--	--	--	--	--	--	
			2	--	22.26	9.79	102	8.35	66	--	--	--	--	--	--	--	
			3	--	21.82	9.85	102	8.39	66	--	--	--	--	--	--	--	
			4	--	21.61	9.82	101	8.38	65	--	--	--	--	--	--	--	
			5	--	21.51	9.75	102	8.35	66	--	--	--	--	--	--	--	
			6	--	20.29	9.20	101	7.85	66	--	--	--	--	--	--	--	
			7	--	19.35	8.27	100	7.48	64	--	--	--	--	--	--	--	
			8	--	18.37	7.03	101	7.22	65	--	--	--	--	--	--	--	
			9	--	15.77	5.00	102	6.98	66	--	--	--	--	--	--	--	
			10	--	14.25	3.65	101	6.88	65	--	--	--	--	--	--	--	
			11	--	13.28	2.67	103	6.81	67	--	--	--	--	--	--	--	
			12	--	12.59	2.09	103	6.79	65	--	--	--	--	--	--	--	
			13	--	11.99	1.33	103	6.75	68	--	--	--	--	--	--	--	
			14	--	10.83	0.17	121	6.88	76	--	--	--	--	--	--	--	
			15	--	10.64	0.08	122	6.94	76	--	--	--	--	--	--	--	
			16	--	10.54	0.08	127	6.97	81	--	--	--	--	--	--	--	
			17	--	10.42	0.07	129	6.97	83	--	--	--	--	--	--	--	
			18	--	10.33	0.07	130	7.00	85	--	--	--	--	--	--	--	
	BOTTOM		19	--	10.22	0.06	131	7.02	85	--	--	--	--	--			
08/12/96	--	2.5	--	--	--	--	--	--	--	--	--	--	--	--	--		
08/13/96	20.0	4.1	0-2	2.54	--	--	--	--	--	0.010	0	ND	ND	0.3	--		
			6	--	--	--	--	--	--	0.010	--	--	--	--	--	--	
			10	--	--	--	--	--	--	--	0.011	--	--	--	--	--	--
			14	--	--	--	--	--	--	--	0.017	--	--	--	--	--	--
			16	--	--	--	--	--	--	--	0.016	--	--	--	--	--	--
			18	--	--	--	--	--	--	--	0.016	--	--	--	--	--	--
				BOTTOM		19	--	--	--	--	--	0.017	--	--	--	--	--

LAC COURTE OREILLES WATER QUALITY DATA

1996 Lake Water Quality Data
 Station: COR-B

Date	Max. Depth (meters)	Secchi Disc (meters)	Depth (meters)	Chl. a (ug/L)	Temp. (C)	D.O. (mg/L)	Cond. (Umhos/cm @ 25 C)	pH (S.U.)	TDS (mg/L)	Total P (mg P/L)	Sol. React. P (mg P/L)	NH3 (mg N/L)	N03 + N02 (mg N/L)	TKN (mg N/L)	Alk. (mg/L)
08/27/96	20.3	4.2	0	--	21.57	9.66	102	8.42	66	--	--	--	--	--	--
			1	--	21.59	9.53	102	8.44	66	--	--	--	--	--	--
			2	--	21.60	9.48	102	8.43	66	--	--	--	--	--	--
			3	--	21.60	9.46	102	8.43	67	--	--	--	--	--	--
			4	--	21.60	9.45	102	8.43	66	--	--	--	--	--	--
			5	--	21.59	9.44	102	8.41	67	--	--	--	--	--	--
			6	--	21.59	9.42	103	8.41	67	--	--	--	--	--	--
			7	--	21.52	9.35	102	8.35	66	--	--	--	--	--	--
			8	--	21.39	9.22	102	8.28	66	--	--	--	--	--	--
			9	--	19.28	6.00	102	7.28	67	--	--	--	--	--	--
			10	--	15.69	2.90	105	6.97	67	--	--	--	--	--	--
			11	--	14.03	1.50	105	6.85	68	--	--	--	--	--	--
			12	--	12.74	0.77	105	6.78	69	--	--	--	--	--	--
			13	--	11.82	0.34	110	6.83	74	--	--	--	--	--	--
			14	--	11.27	0.20	122	6.91	82	--	--	--	--	--	--
			15	--	11.92	0.20	130	6.98	95	--	--	--	--	--	--
			16	--	10.90	0.21	139	6.93	96	--	--	--	--	--	--
			17	--	10.81	0.25	139	6.90	87	--	--	--	--	--	--
			18	--	10.71	0.17	138	6.90	94	--	--	--	--	--	--
			19	--	10.68	0.16	141	6.90	94	--	--	--	--	--	--
	BOTTOM		20	--	10.64	0.13	150	6.91	94	--	--	--	--	--	--

LAC COURTE OREILLES WATER QUALITY DATA

1996 Lake Water Quality Data
 Station: COR-B

Date	Max. Depth (meters)	Secchi Disc (meters)	Depth (meters)	Chl. a (ug/L)	Temp. (C)	D.O. (mg/L)	Cond. (Umhos/cm @ 25 C)	pH (S.U.)	TDS (mg/L)	Total P (mg P/L)	Sol. React. P (mg P/L)	NH3 (mg N/L)	N03 + N02 (mg N/L)	TKN (mg N/L)	Alk. (mg/L)
09/16/96	20.3	3.5	0	--	18.53	9.06	102	7.69	67	--	--	--	--	--	--
			1	--	18.53	9.04	103	7.69	67	--	--	--	--	--	--
			2	--	18.51	9.03	103	7.69	67	--	--	--	--	--	--
			3	--	18.49	9.02	103	7.69	67	--	--	--	--	--	--
			4	--	18.49	9.00	101	7.69	66	--	--	--	--	--	--
			5	--	18.48	8.98	102	7.69	67	--	--	--	--	--	--
			6	--	18.47	8.96	101	7.68	66	--	--	--	--	--	--
			7	--	18.39	8.86	100	7.62	66	--	--	--	--	--	--
			8	--	18.45	8.82	101	7.65	66	--	--	--	--	--	--
			9	--	17.95	8.40	102	7.39	67	--	--	--	--	--	--
			10	--	17.48	3.41	103	6.82	69	--	--	--	--	--	--
			11	--	14.77	0.06	108	6.70	70	--	--	--	--	--	--
			12	--	12.86	0.06	111	6.77	71	--	--	--	--	--	--
			13	--	11.68	0.06	134	6.93	84	--	--	--	--	--	--
			14	--	11.23	0.06	140	7.05	95	--	--	--	--	--	--
			15	--	10.97	0.07	147	7.10	99	--	--	--	--	--	--
			16	--	10.89	0.07	147	7.11	98	--	--	--	--	--	--
			17	--	10.85	0.08	151	7.14	100	--	--	--	--	--	--
			18	--	10.77	0.09	152	7.16	101	--	--	--	--	--	--
			19	--	10.64	0.10	151	7.26	101	--	--	--	--	--	--
	BOTTOM		20	--	10.54	0.09	160	7.30	100	--	--	--	--	--	--

LAC COURTE OREILLES WATER QUALITY DATA

1996 Lake Water Quality Data
 Station: COR-B

Date	Max. Depth (meters)	Secchi Disc (meters)	Depth (meters)	Chl. a (ug/L)	Temp. (C)	D.O. (mg/L)	Cond. (Umhos/cm @ 25 C)	pH (S.U.)	TDS (mg/L)	Total P (mg P/L)	Sol. React. P (mg P/L)	NH3 (mg N/L)	N03 + N02 (mg N/L)	TKN (mg N/L)	Alk. (mg/L)
09/17/96	20.0	3.2	0-2	3.64	--	--	--	--	--	0.009	0.003	ND	ND	0.29	45
			6	--	--	--	--	--	--	0.011	--	--	--	--	--
			10	--	--	--	--	--	--	0.011	--	--	--	--	--
			14	--	--	--	--	--	--	0.100	--	--	--	--	--
			16	--	--	--	--	--	--	0.112	--	--	--	--	--
			18	--	--	--	--	--	--	0.111	--	--	--	--	--
	BOTTOM		19	--	--	--	--	--	0.125	--	--	--	--	--	
09/19/96	--	3.1	--	--	--	--	--	--	--	--	--	--	--	--	
10/02/96	--	3.5	--	--	--	--	--	--	--	--	--	--	--	--	
10/08/96	20.0	3.2	0	--	13.66	9.75	103	7.13	67	--	--	--	--	--	--
			1	--	13.32	9.79	103	7.16	67	--	--	--	--	--	--
			2	--	13.17	9.57	102	7.15	67	--	--	--	--	--	--
			3	--	13.12	9.57	102	7.11	67	--	--	--	--	--	--
			4	--	13.10	9.54	102	7.10	67	--	--	--	--	--	--
			5	--	13.09	9.54	102	7.11	67	--	--	--	--	--	--
			6	--	13.09	9.55	101	7.11	67	--	--	--	--	--	--
			7	--	13.08	9.57	102	7.12	67	--	--	--	--	--	--
			8	--	13.07	9.61	102	7.13	67	--	--	--	--	--	--
			9	--	13.06	9.57	102	7.13	67	--	--	--	--	--	--
			10	--	13.06	9.54	102	7.13	67	--	--	--	--	--	--
			11	--	13.04	9.55	102	7.13	67	--	--	--	--	--	--
			12	--	12.99	9.56	102	7.14	68	--	--	--	--	--	--
			13	--	12.98	9.61	103	7.14	69	--	--	--	--	--	--
			14	--	12.97	9.62	103	7.15	69	--	--	--	--	--	--
			15	--	12.97	9.76	103	7.18	69	--	--	--	--	--	--
			16	--	12.96	9.78	103	7.19	69	--	--	--	--	--	--
17	--	12.98	9.81	103	7.19	68	--	--	--	--	--	--			
18	--	12.87	9.91	103	7.22	69	--	--	--	--	--	--			
19	--	12.76	9.54	103	7.21	69	--	--	--	--	--	--			
	BOTTOM		20	--	12.76	1.56	104	6.91	69	--	--	--	--	--	

LAC COURTE OREILLES WATER QUALITY DATA

1996 Lake Water Quality Data

Station: COR-B

Date	Max. Depth (meters)	Secchi Disc (meters)	Depth (meters)	Chl. a (ug/L)	Temp. (C)	D.O. (mg/L)	Cond. (Umhos/cm @ 25 C)	pH (S.U.)	TDS (mg/L)	Total P (mg P/L)	Sol. React. P (mg P/L)	NH3 (mg N/L)	N03 + N02 (mg N/L)	TKN (mg N/L)	Alk. (mg/L)		
11/07/96	20.3	3.6	0	--	6.23	12.47	102	7.91	66	--	--	--	--	--	--		
			1	--	6.23	12.46	102	7.89	66	--	--	--	--	--	--	--	
			2	--	6.24	12.45	102	7.90	66	--	--	--	--	--	--	--	--
			3	--	6.24	12.45	102	7.89	66	--	--	--	--	--	--	--	--
			4	--	6.25	12.45	102	7.90	67	--	--	--	--	--	--	--	--
			5	--	6.24	12.46	103	7.89	67	--	--	--	--	--	--	--	--
			6	--	6.24	12.45	103	7.89	67	--	--	--	--	--	--	--	--
			7	--	6.24	12.45	103	7.90	67	--	--	--	--	--	--	--	--
			8	--	6.24	12.45	102	7.90	66	--	--	--	--	--	--	--	--
			9	--	6.24	12.46	102	7.89	66	--	--	--	--	--	--	--	--
			10	--	6.24	12.45	103	7.90	67	--	--	--	--	--	--	--	--
			11	--	6.24	12.46	103	7.90	67	--	--	--	--	--	--	--	--
			12	--	6.23	12.45	103	7.90	67	--	--	--	--	--	--	--	--
			13	--	6.24	12.45	103	7.90	67	--	--	--	--	--	--	--	--
			14	--	6.24	12.46	103	7.89	67	--	--	--	--	--	--	--	--
			15	--	6.24	12.46	103	7.90	68	--	--	--	--	--	--	--	--
			16	--	6.21	12.46	104	7.92	67	--	--	--	--	--	--	--	--
			17	--	6.21	12.48	105	7.93	68	--	--	--	--	--	--	--	--
			18	--	6.20	12.60	105	7.94	68	--	--	--	--	--	--	--	--
			19	--	6.20	12.52	105	7.97	69	--	--	--	--	--	--	--	--
	BOTTOM		20	--	6.20	12.53	104	7.98	68	--	--	--	--	--	--		

LAC COURTE OREILLES WATER QUALITY DATA

1996 Lake Water Quality Data
Station: COR-C

Date	Max. Depth (meters)	Secchi Disc (meters)	Depth (meters)	Chl. a (ug/L)	Temp. (C)	D.O. (mg/L)	Cond. (Umhos/cm @ 25 C)	pH (S.U.)	TDS (mg/L)	Total P (mg P/L)	Sol. React. (mg P/L)	NH3 (mg N/L)	N03 + N02 (mg N/L)	TKN (mg N/L)	Alk. (mg/L)
05/27/96	--	3.0	--	--	--	--	--	--	--	--	--	--	--	--	--
05/29/96	16.7	2.8	0-2	6.70	--	--	--	--	--	0.016	0.002	ND	ND	0.50	45
			4	--	--	--	--	--	--	0.026	--	--	--	--	--
			6	--	--	--	--	--	--	0.013	--	--	--	--	--
			10	--	--	--	--	--	--	0.013	--	--	--	--	--
			14	--	--	--	--	--	--	0.017	--	--	--	--	--
	BOTTOM		16	--	--	--	--	--	--	0.021	--	--	--	--	--
05/31/96	18.2	3.4	0	--	13.91	11.76	98	8.52	--	--	--	--	--	--	--
			1	--	13.90	11.67	98	8.53	--	--	--	--	--	--	--
			2	--	13.82	11.72	98	8.52	--	--	--	--	--	--	--
			3	--	13.64	11.72	98	8.49	--	--	--	--	--	--	--
			4	--	13.35	11.78	99	8.47	--	--	--	--	--	--	--
			5	--	12.86	11.79	100	8.40	--	--	--	--	--	--	--
			6	--	11.55	11.83	100	8.13	--	--	--	--	--	--	--
			7	--	11.36	11.79	101	8.12	--	--	--	--	--	--	--
			8	--	10.16	11.06	100	7.55	--	--	--	--	--	--	--
			9	--	10.03	10.86	100	7.46	--	--	--	--	--	--	--
			10	--	10.01	10.59	101	7.41	--	--	--	--	--	--	--
			11	--	9.49	10.30	101	7.31	--	--	--	--	--	--	--
			12	--	9.11	9.85	101	7.19	--	--	--	--	--	--	--
			13	--	9.02	9.63	102	7.14	--	--	--	--	--	--	--
			14	--	8.89	9.41	102	7.12	--	--	--	--	--	--	--
			15	--	8.75	9.21	102	7.08	--	--	--	--	--	--	--
			16	--	8.67	8.95	102	7.02	--	--	--	--	--	--	--
			17	--	8.62	8.72	102	7.02	--	--	--	--	--	--	--
	BOTTOM		18	--	8.34	6.84	102	6.85	--	--	--	--	--	--	--

LAC COURTE OREILLES WATER QUALITY DATA

1996 Lake Water Quality Data
 Station: COR-C

Date	Max. Depth (meters)	Secchi Disc (meters)	Depth (meters)	Chl. a (ug/L)	Temp. (C)	D.O. (mg/L)	Cond. (Umhos/cm @ 25 C)	pH (S.U.)	TDS (mg/L)	Total P (mg P/L)	Sol. React. (mg P/L)	NH3 (mg N/L)	N03 + N02 (mg N/L)	TKN (mg N/L)	Alk. (mg/L)		
06/18/96	19.0	5.9	0	--	19.28	9.54	101	8.12	66	--	--	--	--	--	--		
			1	--	19.28	9.53	101	8.11	66	--	--	--	--	--	--	--	
			2	--	19.28	9.53	101	8.07	66	--	--	--	--	--	--	--	
			3	--	19.24	9.53	101	8.05	66	--	--	--	--	--	--	--	
			4	--	17.13	10.16	103	8.01	66	--	--	--	--	--	--	--	
			5	--	15.95	10.55	101	7.97	67	--	--	--	--	--	--	--	
			6	--	14.91	10.70	101	7.85	65	--	--	--	--	--	--	--	
			7	--	13.25	10.34	100	7.51	65	--	--	--	--	--	--	--	
			8	--	12.15	10.21	103	7.40	66	--	--	--	--	--	--	--	
			9	--	11.76	9.87	104	7.28	66	--	--	--	--	--	--	--	
			10	--	10.33	9.09	104	7.07	68	--	--	--	--	--	--	--	
			11	--	10.05	8.75	106	7.07	66	--	--	--	--	--	--	--	
			12	--	9.75	8.58	104	7.02	66	--	--	--	--	--	--	--	
			13	--	9.59	8.00	104	6.94	68	--	--	--	--	--	--	--	
			14	--	9.23	7.42	103	6.86	68	--	--	--	--	--	--	--	
			15	--	8.96	6.00	105	6.77	69	--	--	--	--	--	--	--	
			16	--	8.81	5.00	106	6.71	69	--	--	--	--	--	--	--	
			17	--	8.71	3.51	107	6.67	65	--	--	--	--	--	--	--	
			18	--	8.66	3.15	107	6.66	70	--	--	--	--	--	--	--	
	BOTTOM		19	--	8.63	0.70	105	6.91	72	--	--	--	--	--	--		
06/25/96	18.5	5.5	0-2	3.00	--	--	--	--	--	0.007	0.002	ND	ND	0.20	--		
			6	--	--	--	--	--	--	--	0.008	--	--	--	--	--	
			10	--	--	--	--	--	--	--	--	0.011	--	--	--	--	--
			14	--	--	--	--	--	--	--	--	0.014	--	--	--	--	--
			16	--	--	--	--	--	--	--	--	0.014	--	--	--	--	--
				BOTTOM		18	--	--	--	--	--	--	0.016	--	--	--	--

LAC COURTE OREILLES WATER QUALITY DATA

1996 Lake Water Quality Data
 Station: COR-C

Date	Max. Depth (meters)	Secchi Disc (meters)	Depth (meters)	Chl. a (ug/L)	Temp. (C)	D.O. (mg/L)	Cond. (Umhos/cm @ 25 C)	pH (S.U.)	TDS (mg/L)	Total P (mg P/L)	Sol. React. (mg P/L)	NH3 (mg N/L)	N03 + N02 (mg N/L)	TKN (mg N/L)	Alk. (mg/L)
10/08/96	18.2	3.8	0	--	13.03	10.43	102	7.63	66	--	--	--	--	--	--
			1	--	12.96	10.10	102	7.60	66	--	--	--	--	--	--
			2	--	12.91	9.99	102	7.59	67	--	--	--	--	--	--
			3	--	12.89	9.96	102	7.58	67	--	--	--	--	--	--
			4	--	12.89	9.82	102	7.53	67	--	--	--	--	--	--
			5	--	12.88	9.74	102	7.52	68	--	--	--	--	--	--
			6	--	12.88	9.72	102	7.51	68	--	--	--	--	--	--
			7	--	12.87	9.68	102	7.48	68	--	--	--	--	--	--
			8	--	12.87	9.59	102	7.46	67	--	--	--	--	--	--
			9	--	12.87	9.56	102	7.45	67	--	--	--	--	--	--
			10	--	12.86	9.59	103	7.43	69	--	--	--	--	--	--
			11	--	12.83	9.59	103	7.45	69	--	--	--	--	--	--
			12	--	12.79	9.66	103	7.46	69	--	--	--	--	--	--
			13	--	12.78	9.74	103	7.47	68	--	--	--	--	--	--
			14	--	12.75	9.80	102	7.47	68	--	--	--	--	--	--
			15	--	12.55	9.75	102	7.45	68	--	--	--	--	--	--
			16	--	12.53	9.53	102	7.42	66	--	--	--	--	--	--
			17	--	10.00	0.93	130	6.90	81	--	--	--	--	--	--
	BOTTOM		18	--	10.43	0.23	142	6.90	89	--	--	--	--	--	--

LAC COURTE OREILLES WATER QUALITY DATA

1996 Lake Water Quality Data
 Station: COR-C

Date	Max. Depth (meters)	Secchi Disc (meters)	Depth (meters)	Chl. a (ug/L)	Temp. (C)	D.O. (mg/L)	Cond. (Umhos/cm @ 25 C)	pH (S.U.)	TDS (mg/L)	Total P (mg P/L)	Sol. React. (mg P/L)	NH3 (mg N/L)	N03 + N02 (mg N/L)	TKN (mg N/L)	Alk. (mg/L)
11/07/96	18.2	3.0	0	--	6.46	12.33	101	7.74	66	--	--	--	--	--	--
			1	--	6.46	12.32	101	7.75	66	--	--	--	--	--	--
			2	--	6.47	12.32	102	7.74	65	--	--	--	--	--	--
			3	--	6.47	12.32	102	7.74	66	--	--	--	--	--	--
			4	--	6.47	12.31	102	7.73	66	--	--	--	--	--	--
			5	--	6.48	12.30	103	7.73	67	--	--	--	--	--	--
			6	--	6.48	12.31	102	7.72	66	--	--	--	--	--	--
			7	--	6.48	12.31	102	7.72	66	--	--	--	--	--	--
			8	--	6.50	12.29	102	7.70	67	--	--	--	--	--	--
			9	--	6.50	12.30	102	7.68	66	--	--	--	--	--	--
			10	--	6.49	12.31	102	7.68	67	--	--	--	--	--	--
			11	--	6.49	12.32	102	7.68	66	--	--	--	--	--	--
			12	--	6.49	12.32	103	7.67	67	--	--	--	--	--	--
			13	--	6.50	12.32	103	7.67	66	--	--	--	--	--	--
			14	--	6.50	12.32	103	7.67	66	--	--	--	--	--	--
			15	--	6.50	12.34	103	7.67	67	--	--	--	--	--	--
			16	--	6.49	12.35	103	7.67	67	--	--	--	--	--	--
			17	--	6.49	12.36	103	7.67	68	--	--	--	--	--	--
	BOTTOM		18	--	6.49	12.43	103	7.66	67	--	--	--	--	--	--

LAC COURTE OREILLES WATER QUALITY DATA

1996 Lake Water Quality Data
 Station: COR-D

Date	Max. Depth (meters)	Secchi Disc (meters)	Depth (meters)	Chl. a (ug/L)	Temp. (C)	D.O. (mg/L)	Cond. (Umhos/cm @ 25 C)	pH (S.U.)	TDS (mg/L)	Total P (mg P/L)	Sol. React. (mg P/L)	NH3 (mg N/L)	N03 + N02 (mg N/L)	TKN (mg N/L)	Alk. (mg/L)
05/27/96	--	4.4	--	--	--	--	--	--	--	--	--	--	--	--	--
05/29/96	5.0	4.7	0-2	2.49	--	--	--	--	--	0.022	ND	ND	ND	0.40	39
	BOTTOM		4.5	--	--	--	--	--	--	0.017	--	--	--	--	--
05/31/96	4.9	4.2	0	--	17.81	10.98	92	9.14	--	--	--	--	--	--	--
			1	--	17.82	11.04	92	9.10	--	--	--	--	--	--	--
			2	--	17.83	11.08	93	9.02	--	--	--	--	--	--	--
			3	--	16.17	11.30	92	8.91	--	--	--	--	--	--	--
			BOTTOM	4	--	15.74	10.91	95	8.82	--	--	--	--	--	--
06/04/96	5.1	3.3	0	--	15.76	8.36	89	8.54	--	--	--	--	--	--	--
			1	--	15.79	8.36	89	8.55	--	--	--	--	--	--	
			2	--	15.79	8.34	90	8.52	--	--	--	--	--	--	
			3	--	15.73	8.28	90	8.40	--	--	--	--	--	--	
			BOTTOM	4	--	15.58	8.08	91	8.12	--	--	--	--	--	--
06/10/96	--	4.7	--	--	--	--	--	--	--	--	--	--	--	--	
06/18/96	3.7	3.0	0	--	20.40	7.20	95	7.64	--	--	--	--	--	--	--
			1	--	20.43	7.05	95	7.64	--	--	--	--	--	--	
			2	--	20.43	7.04	95	7.65	--	--	--	--	--	--	
			3	--	20.29	7.01	95	7.63	--	--	--	--	--	--	
			BOTTOM	3.5	--	17.71	6.60	95	7.41	--	--	--	--	--	
06/25/96	4.7	3.3	0-2	7.00	--	--	--	--	--	0.033	0.003	ND	ND	0.60	--
	BOTTOM		4.5	--	--	--	--	--	--	0.025	--	--	--	--	--

LAC COURTE OREILLES WATER QUALITY DATA

1996 Lake Water Quality Data
Station: COR-D

Date	Max. Depth (meters)	Secchi Disc (meters)	Depth (meters)	Chl. a (ug/L)	Temp. (C)	D.O. (mg/L)	Cond. (Umhos/cm @ 25 C)	pH (S.U.)	TDS (mg/L)	Total P (mg P/L)	Sol. React. (mg P/L)	NH3 (mg N/L)	N03 + N02 (mg N/L)	TKN (mg N/L)	Alk. (mg/L)
06/27/96	4.7	3.1	0	--	20.12	9.25	94	7.67	61	--	--	--	--	--	--
			1	--	20.12	9.10	94	7.68	61	--	--	--	--	--	--
			2	--	20.05	9.02	94	7.64	61	--	--	--	--	--	--
			3	--	19.63	7.96	94	7.36	61	--	--	--	--	--	--
			4	--	18.63	6.00	94	7.06	63	--	--	--	--	--	--
	BOTTOM		4.5	--	17.41	2.93	100	6.81	65	--	--	--	--	--	--
07/01/96	--	2.3	--	--	--	--	--	--	--	--	--	--	--	--	--
07/15/96	--	2.1	--	--	--	--	--	--	--	--	--	--	--	--	--
07/16/96	4.5	3.3	0	--	21.04	10.78	93	8.58	60	--	--	--	--	--	--
			1	--	21.04	10.40	94	8.60	60	--	--	--	--	--	--
			2	--	21.01	10.22	93	8.56	60	--	--	--	--	--	--
			3	--	20.45	9.39	94	8.02	61	--	--	--	--	--	--
			4	--	19.81	8.36	95	7.67	62	--	--	--	--	--	--
	BOTTOM		4.5	--	19.68	6.27	96	7.36	64	--	--	--	--	--	--
07/25/96	5.4	3.1	--	--	--	--	--	--	--	--	--	--	--	--	--
07/29/96	--	1.8	--	--	--	--	--	--	--	--	--	--	--	--	--
08/09/96	5.4	3.4	0	--	24.08	10.29	95	9.12	62	--	--	--	--	--	--
			1	--	23.61	9.92	96	9.04	62	--	--	--	--	--	--
			2	--	23.08	9.59	95	9.00	62	--	--	--	--	--	--
			3	--	22.46	9.72	95	9.02	62	--	--	--	--	--	--
			4	--	21.41	6.77	97	7.92	63	--	--	--	--	--	--
	BOTTOM		5	--	18.65	0.25	101	6.95	67	--	--	--	--	--	--

Lac Courte Oreilles Water Quality Data
1996 Secchi Disc Measurements (Meters)
Stations: COR D (Deep Hole Sample Location) and COR D--NS (Near
Shore Sample Location)*

Date	COR D (Deep Hole Sample Location) -- Secchi Disc Transparency (M)*	COR D--NS (Near Shore Sample Location) -- Secchi Disc Transparency (M)*
06/10/96	4.7	0.4
07/01/96	2.2	0.3
08/12/96	1.8	0.2
09/30/96	3.3	0.3

*See Figure 5 for sample locations.

LAC COURTE OREILLES WATER QUALITY DATA

1996 Lake Water Quality Data
 Station: COR-E

Date	Max. Depth (meters)	Secchi Disc (meters)	Depth (meters)	Chl. a (ug/L)	Temp. (C)	D.O. (mg/L)	Cond. (Umhos/cm @ 25 C)	pH (S.U.)	TDS (mg/L)	Total P (mg P/L)	Sol. React. (mg P/L)	NH3 (mg N/L)	N03 + N02 (mg N/L)	TKN (mg N/L)	Alk. (mg/L)
07/16/96	7.3	4.4	0	--	20.91	9.74	102	8.26	66	--	--	--	--	--	--
			1	--	20.90	9.68	102	8.29	66	--	--	--	--	--	--
			2	--	20.91	9.66	102	8.29	66	--	--	--	--	--	--
			3	--	20.86	9.66	102	8.28	67	--	--	--	--	--	--
			4	--	20.59	9.62	103	8.22	66	--	--	--	--	--	--
			5	--	20.43	9.52	104	8.20	67	--	--	--	--	--	--
			6	--	20.22	9.20	104	8.00	66	--	--	--	--	--	--
			7	--	18.59	7.62	108	7.47	68	--	--	--	--	--	--
07/24/96	--	3.6	--	--	--	--	--	--	--	--	--	--	--	--	--
07/25/96	7.9	4.0	--	--	--	--	--	--	--	--	--	--	--	--	--
08/03/96	--	3.8	--	--	--	--	--	--	--	--	--	--	--	--	--
08/09/96	7.6	3.7	0	--	21.95	9.96	102	8.48	66	--	--	--	--	--	--
			1	--	21.92	9.88	102	8.49	66	--	--	--	--	--	--
			2	--	21.51	9.86	103	8.48	67	--	--	--	--	--	--
			3	--	21.37	9.84	101	8.47	65	--	--	--	--	--	--
			4	--	21.25	9.73	101	8.43	64	--	--	--	--	--	--
			5	--	21.02	9.55	103	8.39	67	--	--	--	--	--	--
			6	--	20.16	8.77	100	7.80	65	--	--	--	--	--	--
			7	--	19.32	7.81	102	7.47	66	--	--	--	--	--	--
08/13/96	7.6	3.7	0-2	2.79	--	--	--	--	--	0.007	0.001	ND	ND	ND	--
	BOTTOM		7	--	--	--	--	--	--	0.028	--	--	--	--	--

LAC COURTE OREILLES WATER QUALITY DATA

1996 Lake Water Quality Data
 Station: COR-E

Date	Max. Depth (meters)	Secchi Disc (meters)	Depth (meters)	Chl. a (ug/L)	Temp. (C)	D.O. (mg/L)	Cond. (Umhos/cm @ 25 C)	pH (S.U.)	TDS (mg/L)	Total P (mg P/L)	Sol. React. (mg P/L)	NH3 (mg N/L)	N03 + N02 (mg N/L)	TKN (mg N/L)	Alk. (mg/L)
10/08/96	7.6	3.0	0	--	13.61	10.31	103	7.49	67	--	--	--	--	--	--
			1	--	13.58	10.31	103	7.49	67	--	--	--	--	--	--
			2	--	13.50	10.33	103	7.50	67	--	--	--	--	--	--
			3	--	13.39	10.38	103	7.51	67	--	--	--	--	--	--
			4	--	13.12	10.39	103	7.52	68	--	--	--	--	--	--
			5	--	12.90	10.22	104	7.47	69	--	--	--	--	--	--
			6	--	12.89	10.17	105	7.47	69	--	--	--	--	--	--
			7	--	12.43	9.87	107	7.41	71	--	--	--	--	--	--
11/07/96	7.6	3.6	0	--	6.13	12.88	103	8.19	67	--	--	--	--	--	--
			1	--	6.09	12.88	103	8.22	67	--	--	--	--	--	--
			2	--	6.06	12.78	103	8.20	67	--	--	--	--	--	--
			3	--	6.00	12.71	103	8.17	67	--	--	--	--	--	--
			4	--	5.98	12.67	103	8.16	67	--	--	--	--	--	--
			5	--	5.98	12.65	104	8.14	68	--	--	--	--	--	--
			6	--	5.97	12.62	104	8.14	68	--	--	--	--	--	--
			7	--	5.96	12.60	104	8.11	69	--	--	--	--	--	--

LAC COURTE OREILLES WATER QUALITY DATA

1996 Lake Water Quality Data
 Station: COR-F

Date	Max. Depth (meters)	Secchi Disc (meters)	Depth (meters)	Chl. a (ug/L)	Temp. (C)	D.O. (mg/L)	Cond. (Umhos/cm @ 25 C)	pH (S.U.)	TDS (mg/L)	Total P (mg P/L)	Sol. React. (mg P/L)	NH3 (mg N/L)	N03 + N02 (mg N/L)	TKN (mg N/L)	Alk. (mg/L)
05/29/96	--	2.9	--	--	--	--	--	--	--	--	--	--	--	--	--
05/29/96	5.3	3.6	0-2	5.73	--	--	--	--	--	0.013	ND	ND	ND	0.40	44
	BOTTOM		4.6	--	--	--	--	--	--	0.014	--	--	--	--	--
05/31/96	5.3	3.0	0	--	14.12	11.72	99	8.15	--	--	--	--	--	--	--
			1	--	14.13	11.71	99	8.17	--	--	--	--	--	--	--
			2	--	14.13	11.70	99	8.13	--	--	--	--	--	--	--
			3	--	14.13	11.72	99	8.11	--	--	--	--	--	--	--
			4	--	14.12	11.68	100	8.08	--	--	--	--	--	--	--
			5	--	14.14	11.67	100	8.02	--	--	--	--	--	--	--
06/04/96	5.3	4.0	0	--	13.66	10.92	99	8.05	--	--	--	--	--	--	--
			1	--	13.67	10.96	99	8.04	--	--	--	--	--	--	
			2	--	13.65	10.97	99	7.97	--	--	--	--	--	--	
			3	--	13.25	11.07	99	7.87	--	--	--	--	--	--	
			4	--	13.00	11.03	99	7.75	--	--	--	--	--	--	
06/10/96	--	3.0	--	--	--	--	--	--	--	--	--	--	--	--	
06/18/96	5.3	5.1	0	--	19.26	9.51	100	7.98	66	--	--	--	--	--	--
			1	--	19.26	9.51	100	7.99	65	--	--	--	--	--	
			2	--	19.24	9.51	100	7.96	65	--	--	--	--	--	
			3	--	19.21	9.51	101	7.94	65	--	--	--	--	--	
			4	--	16.55	9.95	103	7.62	66	--	--	--	--	--	
			5	--	15.55	9.82	103	7.48	66	--	--	--	--	--	

LAC COURTE OREILLES WATER QUALITY DATA

1996 Lake Water Quality Data
 Station: COR-F

Date	Max. Depth (meters)	Secchi Disc (meters)	Depth (meters)	Chl. a (ug/L)	Temp. (C)	D.O. (mg/L)	Cond. (Umhos/cm @ 25 C)	pH (S.U.)	TDS (mg/L)	Total P (mg P/L)	Sol. React. (mg P/L)	NH3 (mg N/L)	N03 + N02 (mg N/L)	TKN (mg N/L)	Alk. (mg/L)
06/25/96	6.0	5.9	0-2	3.00	--	--	--	--	--	0.009	ND	ND	ND	0.20	--
	BOTTOM		4.35	--	--	--	--	--	--	0.010	--	--	--	--	--
06/27/96	5.3	5.1	0	--	19.84	9.90	100	8.08	65	--	--	--	--	--	--
			1	--	19.77	9.82	100	8.08	65	--	--	--	--	--	
			2	--	19.70	9.78	100	8.07	65	--	--	--	--	--	
			3	--	19.65	9.76	100	8.04	65	--	--	--	--	--	
			4	--	19.55	9.71	100	8.02	64	--	--	--	--	--	
			5	--	16.69	9.04	102	7.42	65	--	--	--	--	--	
06/30/96	--	3.0	--	--	--	--	--	--	--	--	--	--	--	--	--
07/15/96	--	2.9	--	--	--	--	--	--	--	--	--	--	--	--	--
07/16/96	4.8	4.3	0	--	20.85	9.50	101	8.01	65	--	--	--	--	--	--
			1	--	20.83	9.42	101	8.03	65	--	--	--	--	--	
			2	--	20.68	9.41	102	8.04	66	--	--	--	--	--	
			3	--	20.57	9.40	101	8.05	66	--	--	--	--	--	
			4	--	20.42	9.34	104	8.03	66	--	--	--	--	--	
			5	--	20.24	8.53	102	7.79	66	--	--	--	--	--	
07/25/96	4.8	3.8	--	--	--	--	--	--	--	--	--	--	--	--	--
07/29/96	--	2.9	--	--	--	--	--	--	--	--	--	--	--	--	--
08/09/96	4.8	3.8	0	--	22.65	9.74	102	8.30	66	--	--	--	--	--	--
			1	--	22.59	9.72	102	8.33	66	--	--	--	--	--	
			2	--	22.09	9.69	101	8.34	66	--	--	--	--	--	
			3	--	22.01	9.85	101	8.38	66	--	--	--	--	--	
			4	--	21.89	9.79	102	8.35	66	--	--	--	--	--	

LAC COURTE OREILLES WATER QUALITY DATA

1996 Lake Water Quality Data
Station: COR-F

Date	Max. Depth (meters)	Secchi Disc (meters)	Depth (meters)	Chl. a (ug/L)	Temp. (C)	D.O. (mg/L)	Cond. (Umhos/cm @ 25 C)	pH (S.U.)	TDS (mg/L)	Total P (mg P/L)	Sol. React. (mg P/L)	NH3 (mg N/L)	N03 + N02 (mg N/L)	TKN (mg N/L)	Alk. (mg/L)
08/12/96	--	2.8	--	--	--	--	--	--	--	--	--	--	--	--	--
08/13/96	4.6	4.0	0-2	2.38	--	--	--	--	--	ND	0.001	ND	ND	0.20	--
	BOTTOM		4.25	--	--	--	--	--	--	0.009	--	--	--	--	--
08/27/96	3.6	3.5	0	--	23.08	9.51	102	8.28	67	--	--	--	--	--	--
			1	--	22.86	9.52	102	8.31	67	--	--	--	--	--	--
			2	--	22.42	9.53	103	8.32	67	--	--	--	--	--	--
			3	--	21.84	9.49	104	8.24	67	--	--	--	--	--	--
			4	--	21.35	9.57	104	8.39	67	--	--	--	--	--	--
09/03/96	--	2.7	--	--	--	--	--	--	--	--	--	--	--	--	--
09/16/96	--	2.7	--	--	--	--	--	--	--	--	--	--	--	--	--
09/16/96	4.6	3.2	0	--	18.52	9.46	102	7.67	66	--	--	--	--	--	--
			1	--	18.54	9.34	102	7.68	66	--	--	--	--	--	--
			2	--	18.55	9.32	103	7.67	67	--	--	--	--	--	--
			3	--	18.50	9.25	102	7.65	66	--	--	--	--	--	--
			4	--	18.42	8.88	102	7.54	67	--	--	--	--	--	--
09/17/96	4.6	3.7	0-2	3.29	--	--	--	--	--	0.008	ND	ND	ND	0.25	45
	BOTTOM		4	--	--	--	--	--	--	0.010	--	--	--	--	--

LAC COURTE OREILLES WATER QUALITY DATA

1996 Lake Water Quality Data
 Station: COR-F

Date	Max. Depth (meters)	Secchi Disc (meters)	Depth (meters)	Chl. a (ug/L)	Temp. (C)	D.O. (mg/L)	Cond. (Umhos/cm @ 25 C)	pH (S.U.)	TDS (mg/L)	Total P (mg P/L)	Sol. React. (mg P/L)	NH3 (mg N/L)	N03 + N02 (mg N/L)	TKN (mg N/L)	Alk. (mg/L)
09/30/96	--	2.7	--	--	--	--	--	--	--	--	--	--	--	--	--
10/08/96	4.6	3.4	0	--	12.51	10.42	102	7.56	66	--	--	--	--	--	--
			1	--	12.52	10.34	102	7.64	67	--	--	--	--	--	--
			2	--	12.50	10.32	102	7.65	67	--	--	--	--	--	--
			3	--	12.49	10.30	102	7.66	67	--	--	--	--	--	--
			4	--	12.49	10.24	102	7.65	67	--	--	--	--	--	--
11/07/96	4.6	3.0	0	--	6.00	12.79	101	7.73	66	--	--	--	--	--	--
			1	--	5.99	12.76	101	7.78	66	--	--	--	--	--	--
			2	--	5.99	12.74	101	7.80	66	--	--	--	--	--	--
			3	--	6.01	12.72	102	7.81	67	--	--	--	--	--	--
			4	--	6.02	12.68	102	7.82	67	--	--	--	--	--	--

LAC COURTE OREILLES WATER QUALITY DATA

1996 Lake Water Quality Data
 Station: COR-G

Date	Max. Depth (meters)	Secchi Disc (meters)	Depth (meters)	Chl. a (ug/L)	Temp. (C)	D.O. (mg/L)	Cond. (Umhos/cm @ 25 C)	pH (S.U.)	TDS (mg/L)	Total P (mg P/L)	Sol. React. (mg P/L)	NH3 (mg N/L)	N03 + N02 (mg N/L)	TKN (mg N/L)	Alk. (mg/L)
05/20/96	8.9	2.20	0-2	4.64	--	--	--	--	--	0.016	0.002	ND	0.012	0.40	45
	BOTTOM		8.4	--	--	--	--	--	--	0.012	--	--	--	--	--
05/20/96	8.9	2.2	0	--	10.30	11.20	102	7.60	--	--	--	--	--	--	--
			1	--	9.78	11.31	102	--	--	--	--	--	--	--	
			2	--	9.37	11.24	102	7.64	--	--	--	--	--	--	
			3	--	9.28	11.15	101	7.63	--	--	--	--	--	--	
			4	--	9.13	11.10	101	7.62	--	--	--	--	--	--	
			5	--	8.99	11.10	100	7.59	--	--	--	--	--	--	
			6	--	8.95	10.98	102	7.55	--	--	--	--	--	--	
			7	--	8.89	10.90	102	7.52	--	--	--	--	--	--	
			8	--	8.89	10.88	102	7.50	--	--	--	--	--	--	
05/29/96	8.5	3.3	--	--	--	--	--	--	--	--	--	--	--	--	--
05/29/96	--	2.8	--	--	--	--	--	--	--	--	--	--	--	--	--
05/31/96	6.7	3.0	0	--	14.30	11.89	100	8.08	--	--	--	--	--	--	--
			1	--	14.30	11.79	100	7.90	--	--	--	--	--	--	
			2	--	14.30	11.75	100	7.95	--	--	--	--	--	--	
			3	--	14.14	11.77	101	7.95	--	--	--	--	--	--	
			4	--	14.13	11.78	102	7.97	--	--	--	--	--	--	
			5	--	14.12	11.71	102	7.84	--	--	--	--	--	--	
			6	--	14.21	11.79	101	7.90	--	--	--	--	--	--	

LAC COURTE OREILLES WATER QUALITY DATA

1996 Lake Water Quality Data
 Station: COR-G

Date	Max. Depth (meters)	Secchi Disc (meters)	Depth (meters)	Chl. a (ug/L)	Temp. (C)	D.O. (mg/L)	Cond. (Umhos/cm @ 25 C)	pH (S.U.)	TDS (mg/L)	Total P (mg P/L)	Sol. React. (mg P/L)	NH3 (mg N/L)	N03 + N02 (mg N/L)	TKN (mg N/L)	Alk. (mg/L)
06/04/96	7.3	4.0	0	--	14.77	11.12	100	8.28	--	--	--	--	--	--	--
			1	--	14.75	11.13	100	8.22	--	--	--	--	--	--	--
			2	--	14.74	11.13	100	8.13	--	--	--	--	--	--	--
			3	--	14.74	11.12	100	8.07	--	--	--	--	--	--	--
			4	--	14.73	11.12	100	8.03	--	--	--	--	--	--	--
			5	--	14.72	11.13	100	8.02	--	--	--	--	--	--	--
			6	--	14.73	11.15	100	8.02	--	--	--	--	--	--	--
			7	--	14.72	11.13	100	8.04	--	--	--	--	--	--	
06/10/96	--	4.0	--	--	--	--	--	--	--	--	--	--	--	--	--
06/18/96	7.6	5.5	0	--	18.24	9.96	100	7.94	65	--	--	--	--	--	--
			1	--	18.11	9.91	100	8.04	65	--	--	--	--	--	
			2	--	17.21	10.11	102	8.00	66	--	--	--	--	--	
			3	--	16.75	10.27	103	8.00	67	--	--	--	--	--	
			4	--	15.95	10.53	103	7.96	66	--	--	--	--	--	
			5	--	15.52	10.56	104	7.79	64	--	--	--	--	--	
			6	--	14.85	10.60	104	7.79	65	--	--	--	--	--	
			7	--	14.62	10.62	103	7.76	65	--	--	--	--	--	
			7.5	--	14.57	10.32	104	7.72	69	--	--	--	--	--	
06/25/96	8.3	6.2	0-2	3.00	--	--	--	--	--	0.007	0.002	ND	ND	0.30	--
	BOTTOM		7.5	--	--	--	--	--	--	0.012	--	--	--	--	--
06/27/96	7.6	5.2	0	--	20.52	9.90	100	7.95	66	--	--	--	--	--	--
			1	--	20.45	9.84	100	7.93	65	--	--	--	--	--	
			2	--	20.32	9.83	101	7.91	65	--	--	--	--	--	
			3	--	19.90	10.09	100	8.02	63	--	--	--	--	--	
			4	--	19.34	10.05	100	7.97	64	--	--	--	--	--	
			5	--	18.86	10.02	100	7.97	64	--	--	--	--	--	
			6	--	18.08	9.95	105	7.78	64	--	--	--	--	--	
			7	--	14.69	10.41	102	7.55	63	--	--	--	--	--	
						7.5	--	14.34	10.20	105	7.53	65	--	--	--

LAC COURTE OREILLES WATER QUALITY DATA

1996 Lake Water Quality Data
 Station: COR-G

Date	Max. Depth (meters)	Secchi Disc (meters)	Depth (meters)	Chl. a (ug/L)	Temp. (C)	D.O. (mg/L)	Cond. (Umhos/cm @ 25 C)	pH (S.U.)	TDS (mg/L)	Total P (mg P/L)	Sol. React. (mg P/L)	NH3 (mg N/L)	N03 + N02 (mg N/L)	TKN (mg N/L)	Alk. (mg/L)
07/01/96	--	4.8	--	--	--	--	--	--	--	--	--	--	--	--	--
07/15/96	--	4.6	--	--	--	--	--	--	--	--	--	--	--	--	--
07/16/96	7.6	4.9	0	--	21.88	9.58	101	8.01	66	--	--	--	--	--	--
			1	--	21.35	9.59	101	8.06	66	--	--	--	--	--	--
			2	--	21.01	9.57	100	8.05	66	--	--	--	--	--	--
			3	--	20.94	9.50	102	8.02	66	--	--	--	--	--	--
			4	--	20.71	9.46	100	7.99	66	--	--	--	--	--	--
			5	--	20.67	9.41	102	7.95	65	--	--	--	--	--	--
			6	--	20.42	9.35	102	7.86	66	--	--	--	--	--	--
			7	--	20.04	9.31	103	7.79	67	--	--	--	--	--	--
07/25/96	7.4	4.4	--	--	--	--	--	--	--	--	--	--	--	--	--
07/29/96	--	4.1	--	--	--	--	--	--	--	--	--	--	--	--	--
08/09/96	7.7	4.3	0	--	23.35	9.84	102	8.28	66	--	--	--	--	--	--
			1	--	23.27	9.73	102	8.27	66	--	--	--	--	--	--
			2	--	22.89	9.78	102	8.29	66	--	--	--	--	--	--
			3	--	22.62	9.75	101	8.25	66	--	--	--	--	--	--
			4	--	22.45	9.71	102	8.21	66	--	--	--	--	--	--
			5	--	22.41	9.65	101	8.19	65	--	--	--	--	--	--
			6	--	22.37	9.64	100	8.19	64	--	--	--	--	--	--
			7	--	22.16	9.38	101	8.02	66	--	--	--	--	--	--
08/13/96	7.6	4.3	0-2	2.45	--	--	--	--	--	ND	0.000	ND	ND	0.30	--
	BOTTOM		7	--	--	--	--	--	--	0.007	--	--	--	--	--

LAC COURTE OREILLES WATER QUALITY DATA

1996 Lake Water Quality Data
 Station: COR-G

Date	Max. Depth (meters)	Secchi Disc (meters)	Depth (meters)	Chl. a (ug/L)	Temp. (C)	D.O. (mg/L)	Cond. (Umhos/cm @ 25 C)	pH (S.U.)	TDS (mg/L)	Total P (mg P/L)	Sol. React. (mg P/L)	NH3 (mg N/L)	N03 + N02 (mg N/L)	TKN (mg N/L)	Alk. (mg/L)
08/15/96	--	4.5	--	--	--	--	--	--	--	--	--	--	--	--	--
08/26/96	--	3.7	--	--	--	--	--	--	--	--	--	--	--	--	--
08/27/96	6.9	4.6	0	--	23.07	9.69	103	8.27	67	--	--	--	--	--	--
			1	--	23.07	9.63	103	8.29	67	--	--	--	--	--	--
			2	--	22.50	9.73	103	8.34	66	--	--	--	--	--	--
			3	--	22.13	9.76	103	8.35	66	--	--	--	--	--	--
			4	--	21.93	9.63	105	8.21	67	--	--	--	--	--	--
			5	--	21.81	9.50	105	8.21	67	--	--	--	--	--	--
			6	--	21.78	9.41	106	8.22	68	--	--	--	--	--	--
09/08/96	--	4.2	--	--	--	--	--	--	--	--	--	--	--	--	--
09/16/96	7.6	3.8	0	--	18.58	9.38	102	7.72	66	--	--	--	--	--	--
			1	--	18.60	9.36	102	7.71	66	--	--	--	--	--	--
			2	--	18.59	9.36	102	7.71	66	--	--	--	--	--	--
			3	--	18.60	9.34	102	7.70	66	--	--	--	--	--	--
			4	--	18.59	9.31	102	7.69	66	--	--	--	--	--	--
			5	--	18.58	9.29	103	7.68	67	--	--	--	--	--	--
			6	--	18.49	9.03	103	7.58	68	--	--	--	--	--	--
			7	--	18.45	9.03	103	7.59	67	--	--	--	--	--	--
09/17/96	7.6	4.3	0-2	3.19	--	--	--	--	--	0.007	--	ND	ND	0.21	45
	BOTTOM		7	--	--	--	--	--	--	0.008	--	--	--	--	--

LAC COURTE OREILLES WATER QUALITY DATA

1996 Lake Water Quality Data
 Station: COR-G

Date	Max.	Secchi	Depth (meters)	Chl. a (ug/L)	Temp. (C)	D.O. (mg/L)	Cond. (Umhos/cm @ 25 C)	pH (S.U.)	TDS (mg/L)	Total P (mg P/L)	Sol. React. (mg P/L)	NH3 (mg N/L)	N03 + N02 (mg N/L)	TKN (mg N/L)	Alk. (mg/L)
	Depth (meters)	Disc (meters)													
10/08/96	7.6	3.8	0	--	13.49	10.40	102	7.48	66	--	--	--	--	--	--
			1	--	13.49	10.40	102	7.48	66	--	--	--	--	--	--
			2	--	13.49	10.40	101	7.48	66	--	--	--	--	--	--
			3	--	13.47	10.39	102	7.48	67	--	--	--	--	--	--
			4	--	13.44	10.35	102	7.47	67	--	--	--	--	--	--
			5	--	13.30	10.32	102	7.46	68	--	--	--	--	--	--
			6	--	13.26	10.19	102	7.42	68	--	--	--	--	--	--
			7	--	13.22	10.24	103	7.41	68	--	--	--	--	--	--
11/07/96	7.6	3.0	0	--	6.79	12.25	101	7.70	66	--	--	--	--	--	--
			1	--	6.81	12.23	101	7.70	66	--	--	--	--	--	--
			2	--	6.82	12.24	102	7.69	66	--	--	--	--	--	--
			3	--	6.81	12.24	102	7.68	67	--	--	--	--	--	--
			4	--	6.81	12.24	101	7.68	67	--	--	--	--	--	--
			5	--	6.82	12.24	101	7.67	67	--	--	--	--	--	--
			6	--	6.82	12.23	101	7.66	66	--	--	--	--	--	--
			7	--	6.82	12.31	102	7.63	66	--	--	--	--	--	--

LAC COURTE OREILLES WATER QUALITY DATA

1996 Lake Water Quality Data
 Station: COR-H

Date	Max.	Secchi		Chl. a (ug/L)	Temp. (C)	D.O. (mg/L)	Cond. (Umhos/cm @ 25 C)	pH (S.U.)	TDS (mg/L)	Total P (mg P/L)	Sol. React. (mg P/L)	NH3 (mg N/L)	N03 + N02 (mg N/L)	TKN (mg N/L)	Alk. (mg/L)
	Depth (meters)	Disc (meters)	Depth (meters)												
07/16/96	7.6	4.3	0	--	21.77	9.59	101	7.94	66	--	--	--	--	--	--
			1	--	21.52	9.57	101	7.92	66	--	--	--	--	--	--
			2	--	21.09	9.57	101	7.94	66	--	--	--	--	--	--
			3	--	21.01	9.51	102	7.96	66	--	--	--	--	--	--
			4	--	20.75	9.37	100	7.83	67	--	--	--	--	--	--
			5	--	20.65	9.20	101	7.74	63	--	--	--	--	--	--
			6	--	20.47	9.02	102	7.64	64	--	--	--	--	--	--
			7	--	20.29	9.00	103	7.61	64	--	--	--	--	--	--
			8	--	16.18	7.63	103	7.17	66	--	--	--	--	--	
07/25/96	7.9	3.8	--	--	--	--	--	--	--	--	--	--	--	--	--
07/29/96	--	3.8	--	--	--	--	--	--	--	--	--	--	--	--	--
08/09/96	7.9	4.1	0	--	23.32	9.58	101	8.07	66	--	--	--	--	--	--
			1	--	23.34	9.54	102	8.12	66	--	--	--	--	--	--
			2	--	23.19	9.57	102	8.17	66	--	--	--	--	--	--
			3	--	22.81	9.57	101	8.11	65	--	--	--	--	--	--
			4	--	22.73	9.36	101	8.03	65	--	--	--	--	--	--
			5	--	22.57	9.23	100	7.92	64	--	--	--	--	--	--
			6	--	22.39	9.14	101	7.88	65	--	--	--	--	--	--
			7	--	22.11	8.84	101	7.71	65	--	--	--	--	--	
08/13/96	7.6	3.7	0-2	2.58	--	--	--	--	--	ND	0.001	ND	ND	0.30	--
	BOTTOM		7	--	--	--	--	--	--	0.015	--	--	--	--	--

LAC COURTE OREILLES WATER QUALITY DATA

1996 Lake Water Quality Data
 Station: COR-H

Date	Max. Depth (meters)	Secchi Disc (meters)	Depth (meters)	Chl. a (ug/L)	Temp. (C)	D.O. (mg/L)	Cond. (Umhos/cm @ 25 C)	pH (S.U.)	TDS (mg/L)	Total P (mg P/L)	Sol. React. (mg P/L)	NH3 (mg N/L)	N03 + N02 (mg N/L)	TKN (mg N/L)	Alk. (mg/L)
10/08/96	7.6	3.9	0	--	13.49	10.28	101	7.45	66	--	--	--	--	--	--
			1	--	13.50	10.27	101	7.45	66	--	--	--	--	--	--
			2	--	13.48	10.26	102	7.46	67	--	--	--	--	--	--
			3	--	13.39	10.26	102	7.47	66	--	--	--	--	--	--
			4	--	13.24	10.28	101	7.48	66	--	--	--	--	--	--
			5	--	13.17	10.26	102	7.44	67	--	--	--	--	--	--
			6	--	13.13	10.13	102	7.40	67	--	--	--	--	--	--
			7	--	12.95	10.40	103	7.43	67	--	--	--	--	--	--
11/07/96	7.6	3.1	0	--	6.34	12.56	100	7.74	65	--	--	--	--	--	--
			1	--	6.34	12.50	100	7.73	65	--	--	--	--	--	--
			2	--	6.36	12.46	100	7.72	65	--	--	--	--	--	--
			3	--	6.36	12.45	100	7.72	65	--	--	--	--	--	--
			4	--	6.36	12.42	100	7.71	65	--	--	--	--	--	--
			5	--	6.36	12.41	100	7.70	65	--	--	--	--	--	--
			6	--	6.37	12.39	100	7.70	65	--	--	--	--	--	--
			7	--	6.36	12.39	100	7.69	65	--	--	--	--	--	--

Appendix B

Periphyton Data

[Faint, illegible text and table structure visible in the lower-left quadrant of the page.]

Lac Courte Oreilles Estimated Soluble Reactive Phosphorus Concentrations
at Sample Stations P-1 through P-11

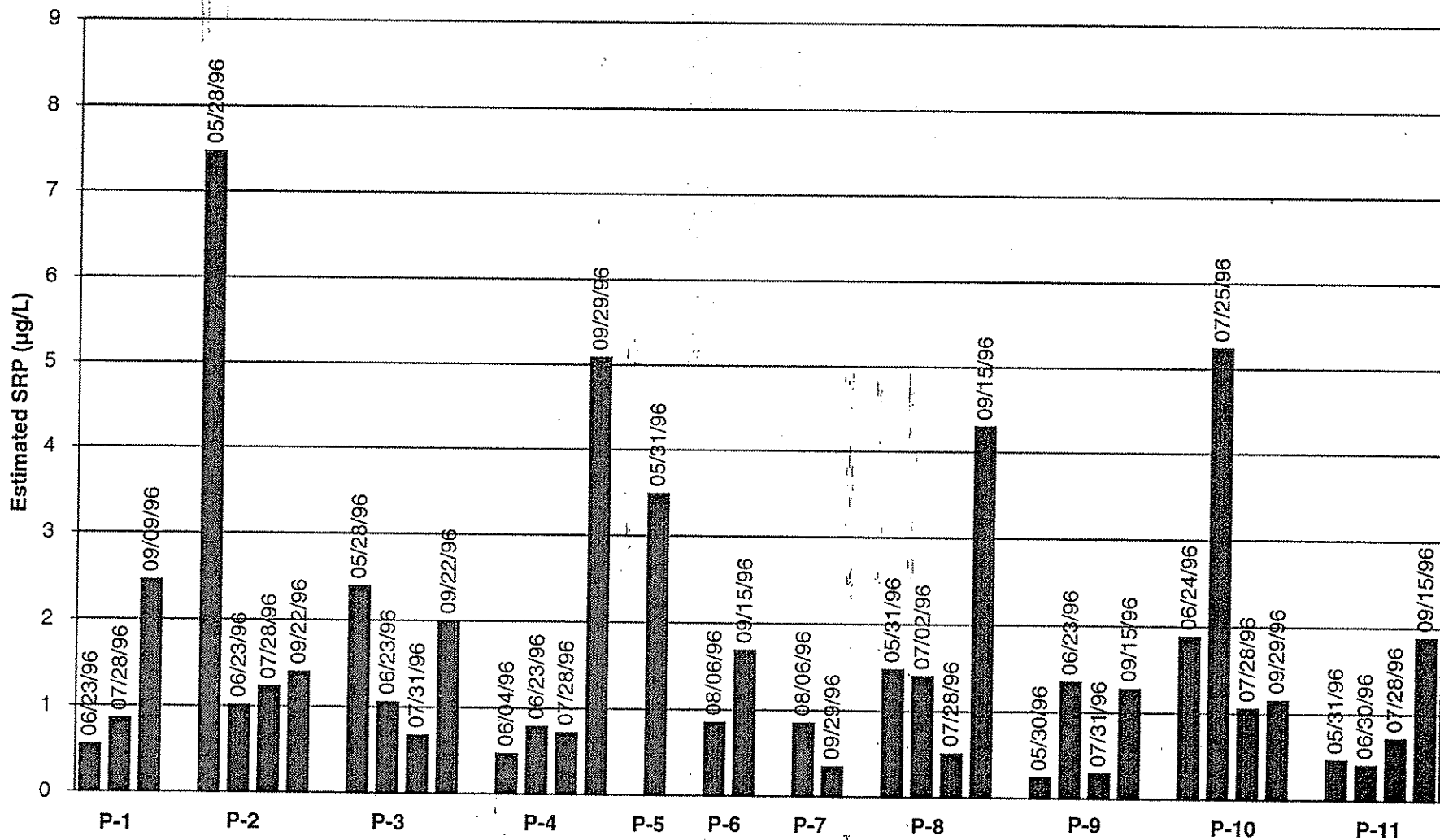

Lac Courte Oreilles Growth Rate (per day) at Sample Stations P-1 through P-11
Sorted by Month

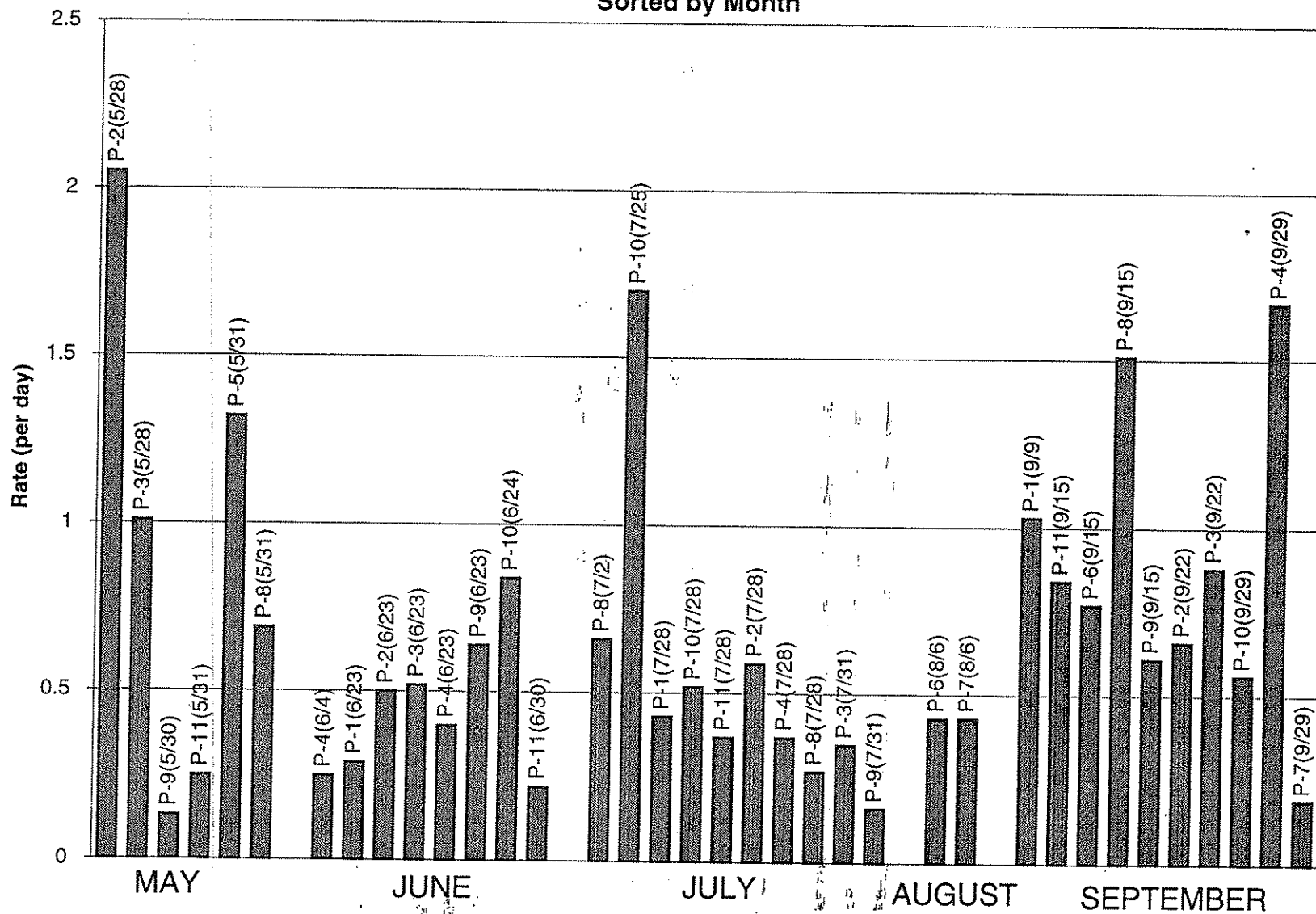

Lac Courte Oreilles Growth Rate (per day)
at Sample Stations P-1 through P-11

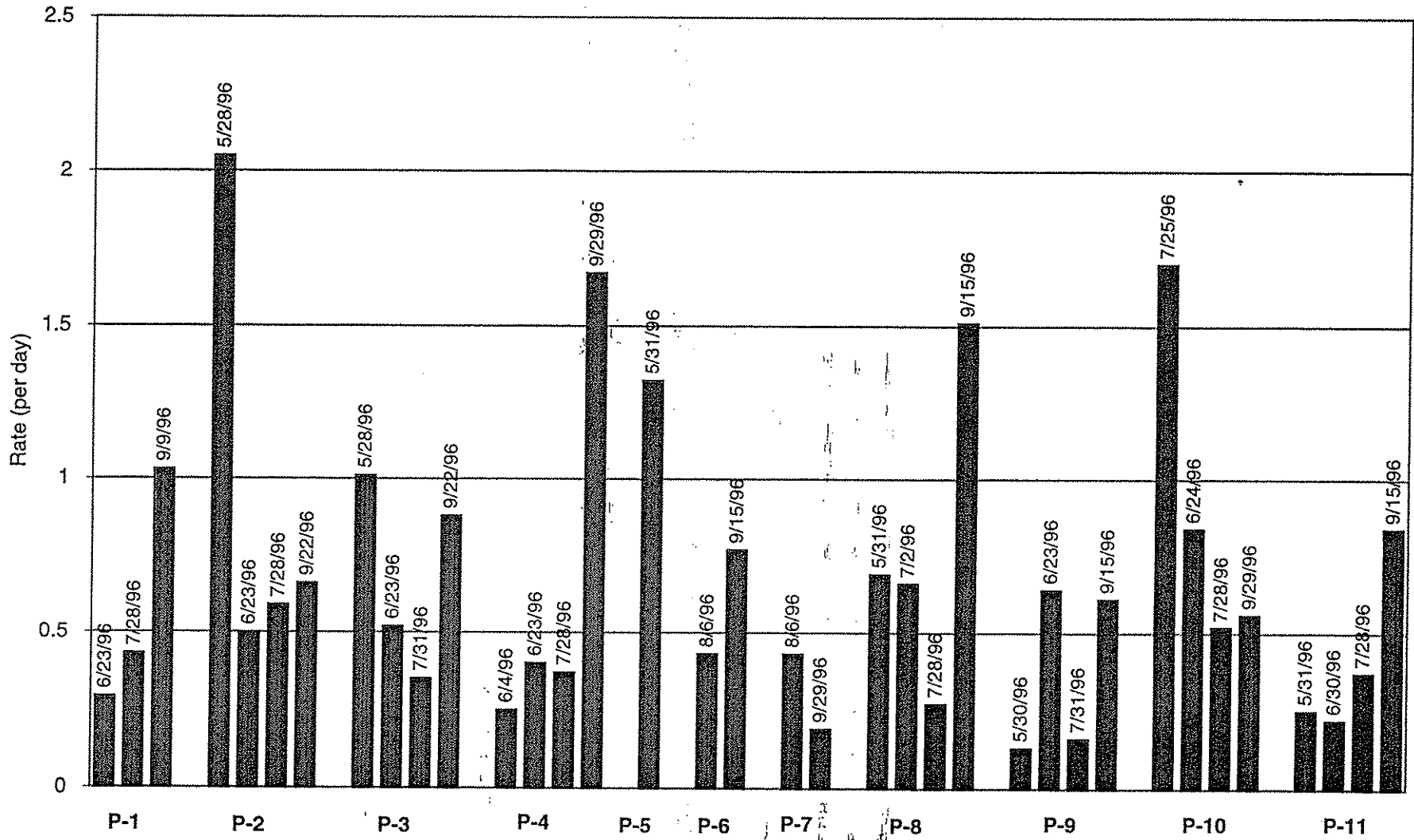

(Charts)

Corrected Periphyton Growth Rates Station P-1

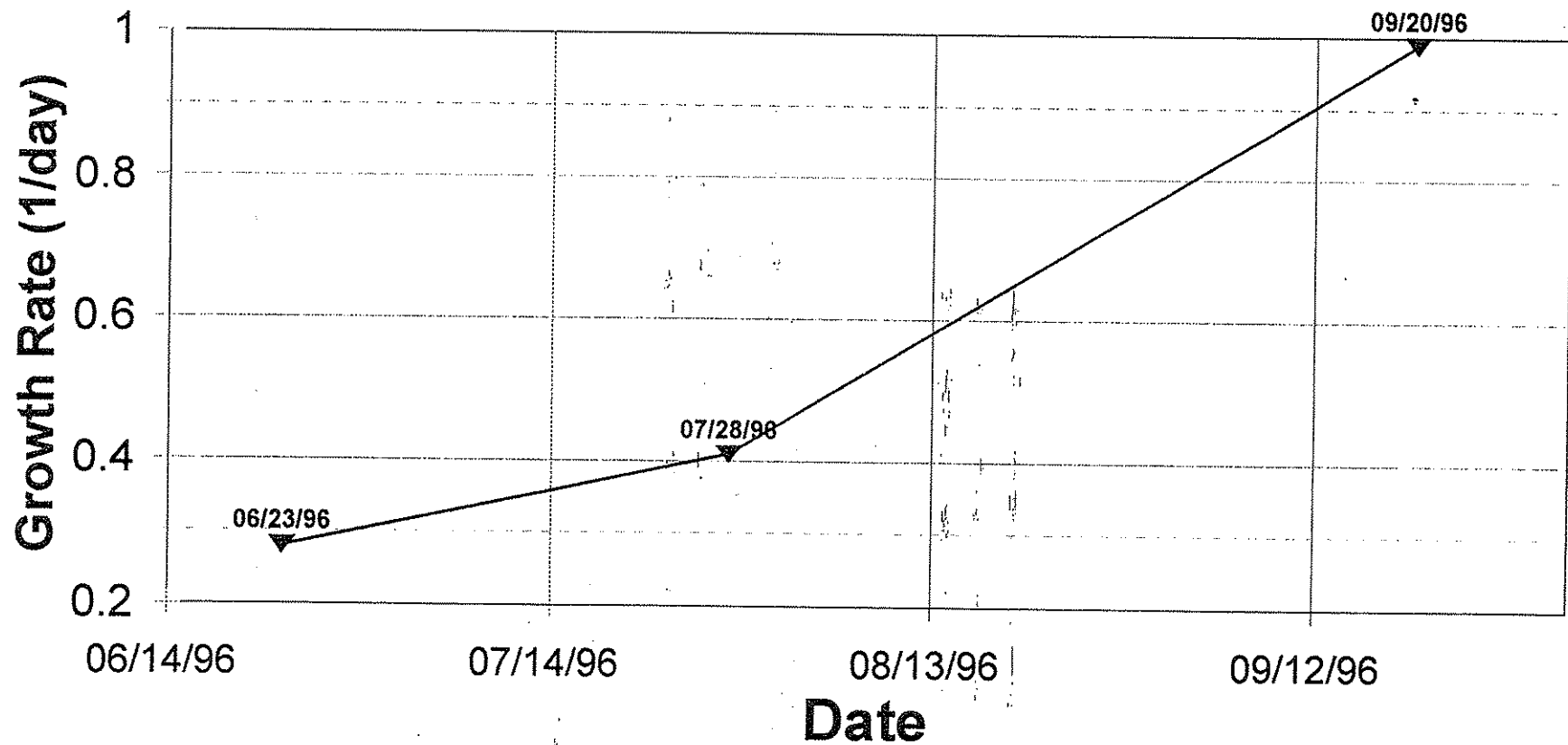

Corrected Periphyton Growth Rates Station P-2

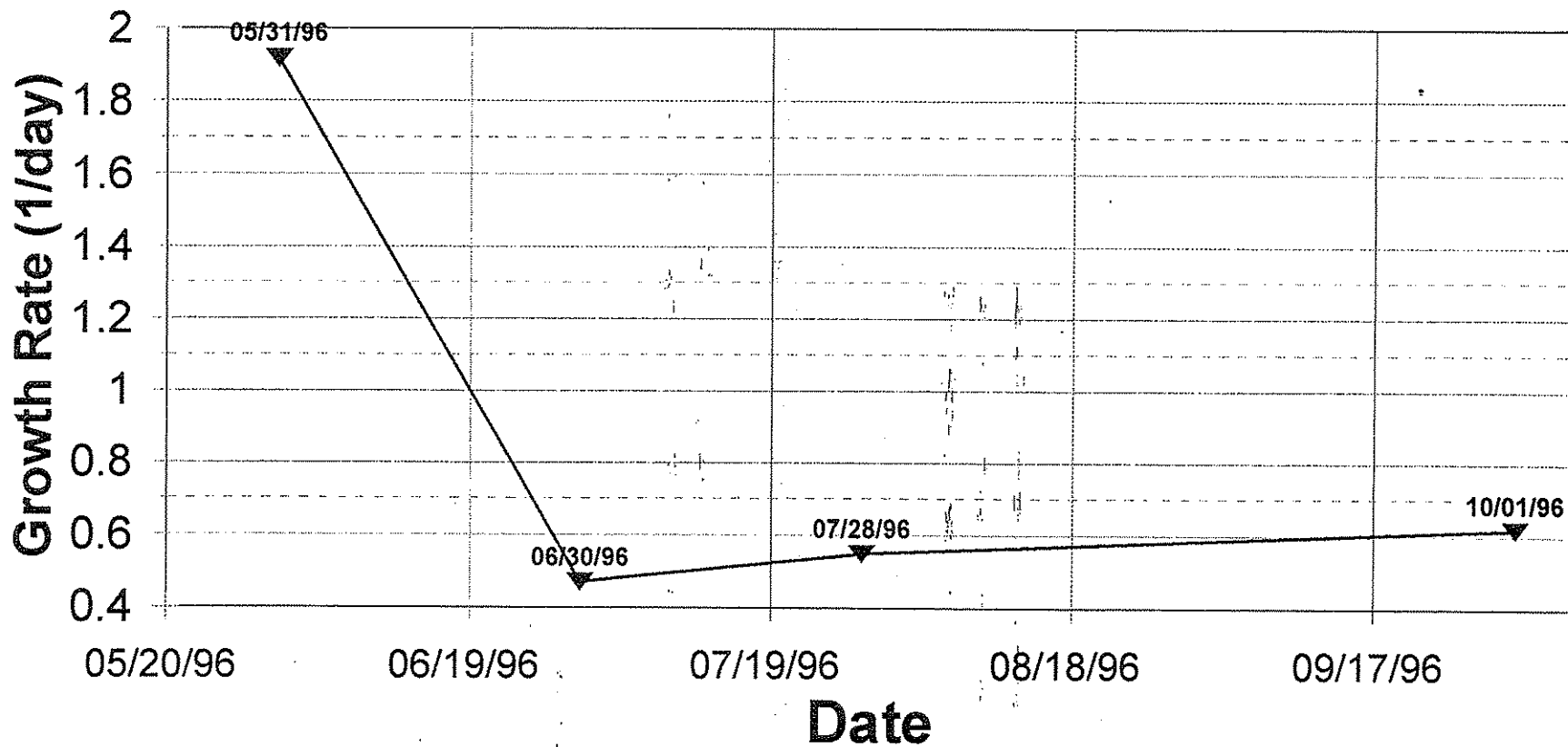

Corrected Periphyton Growth Rates Station P-3

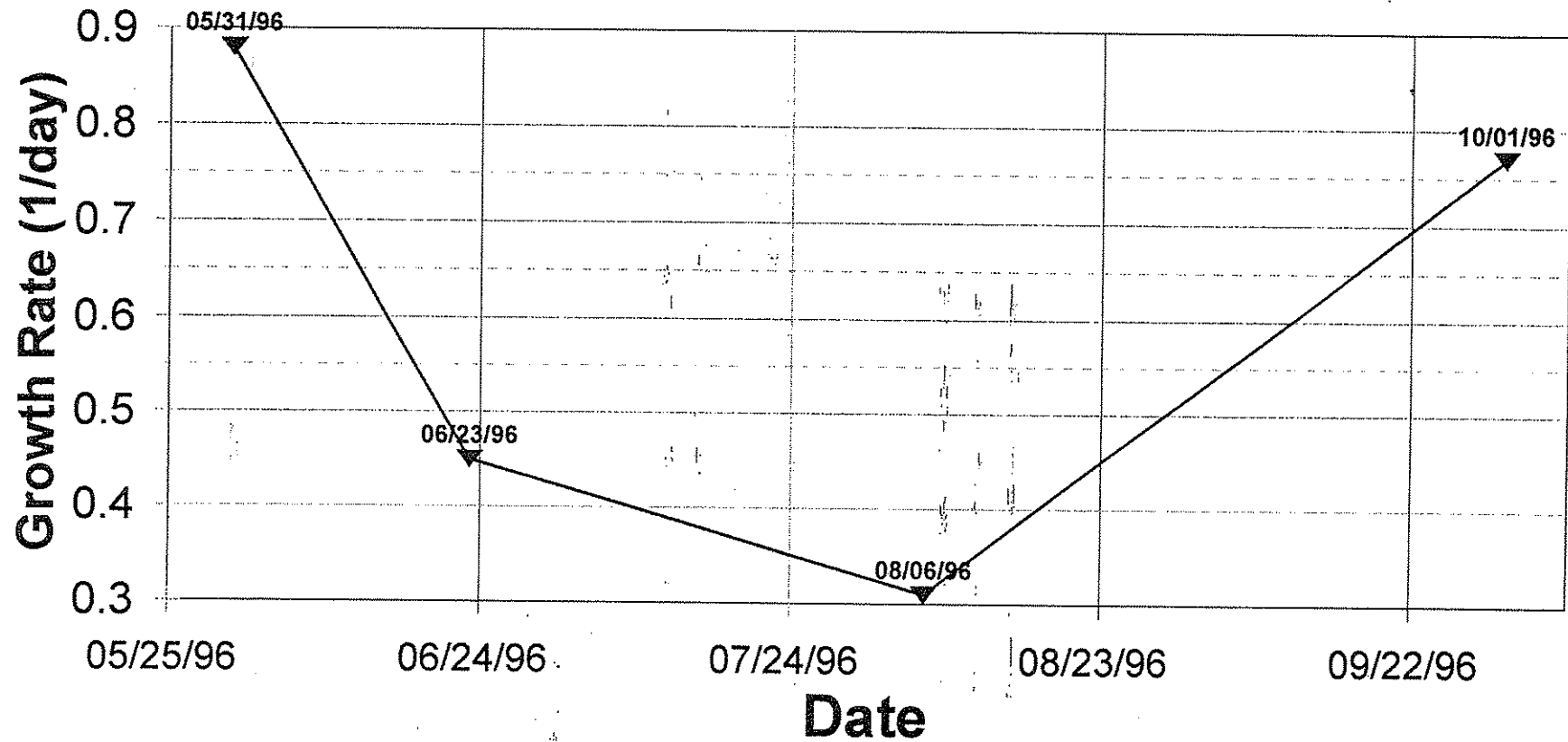

Corrected Periphyton Growth Rates Station P-4

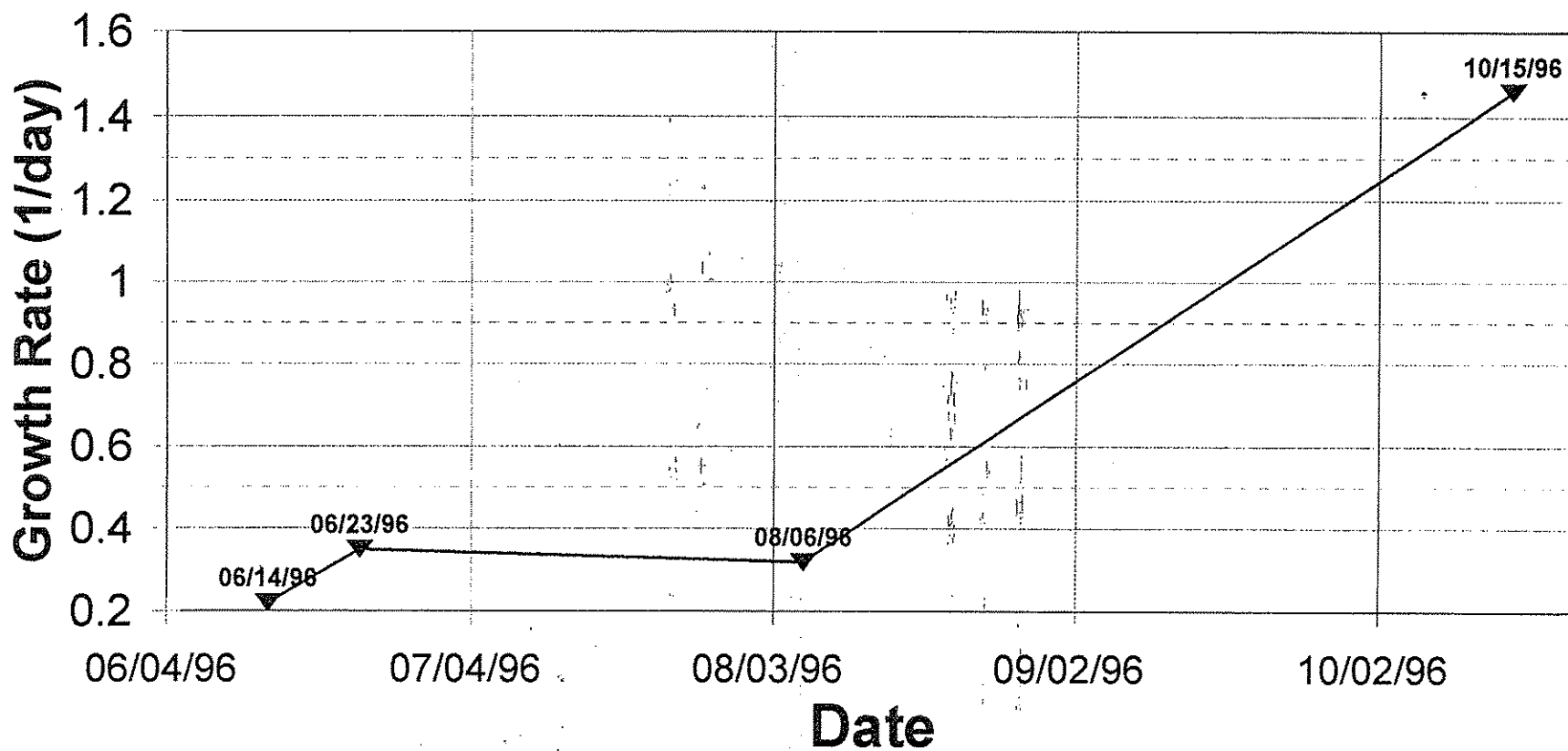

Corrected Periphyton Growth Rates Station P-5

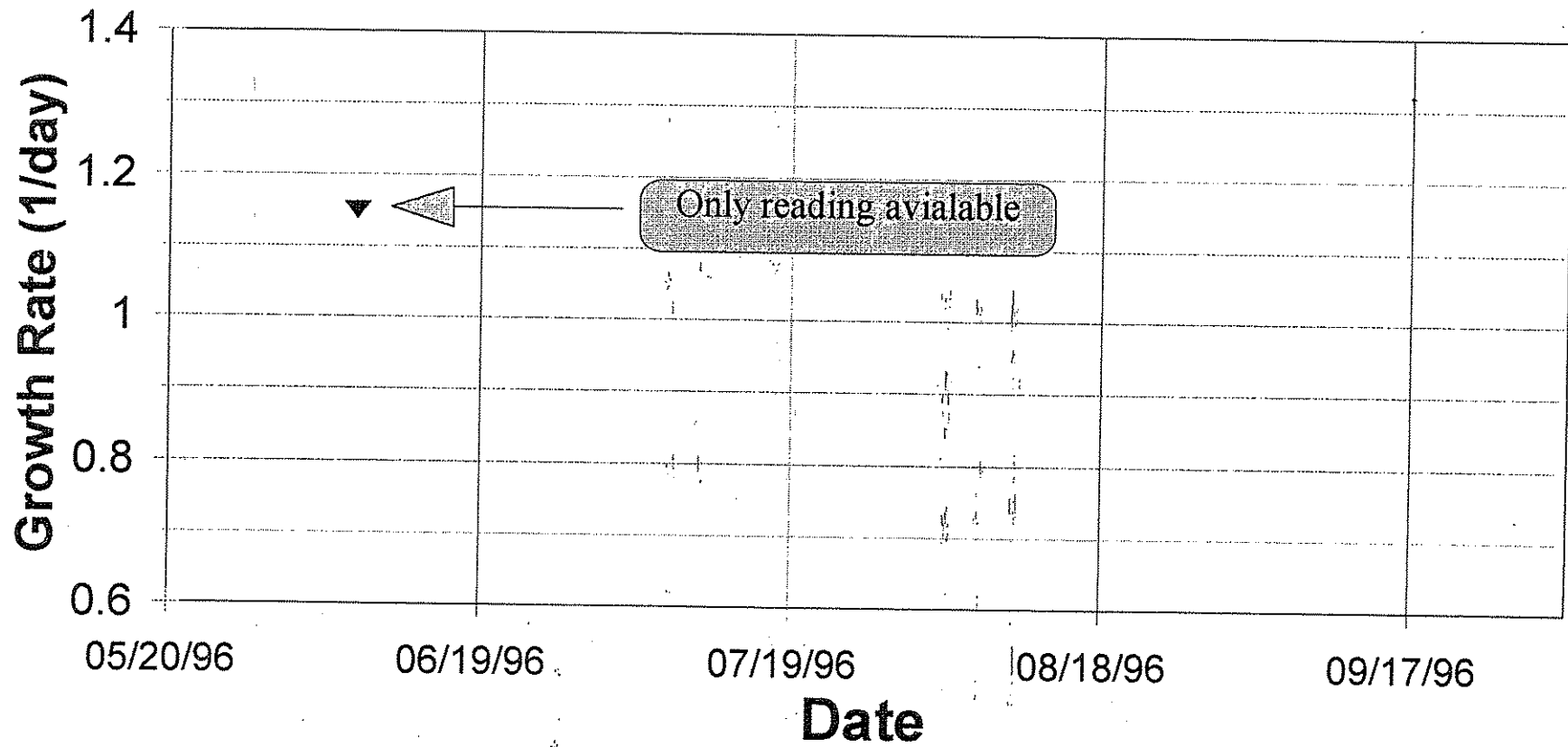

Corrected Periphyton Growth Rates Station P-6

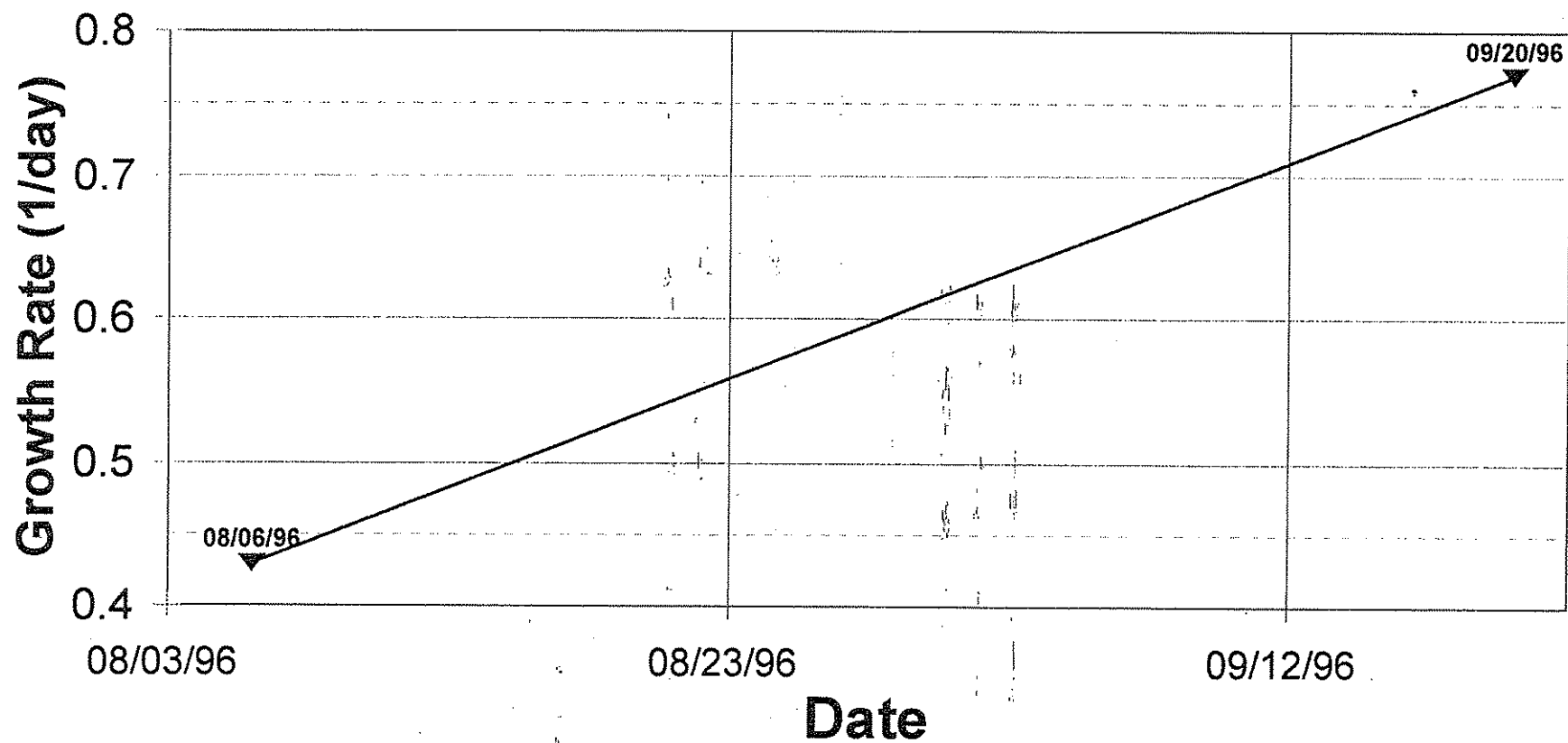

Corrected Periphyton Growth Rates Station P-7

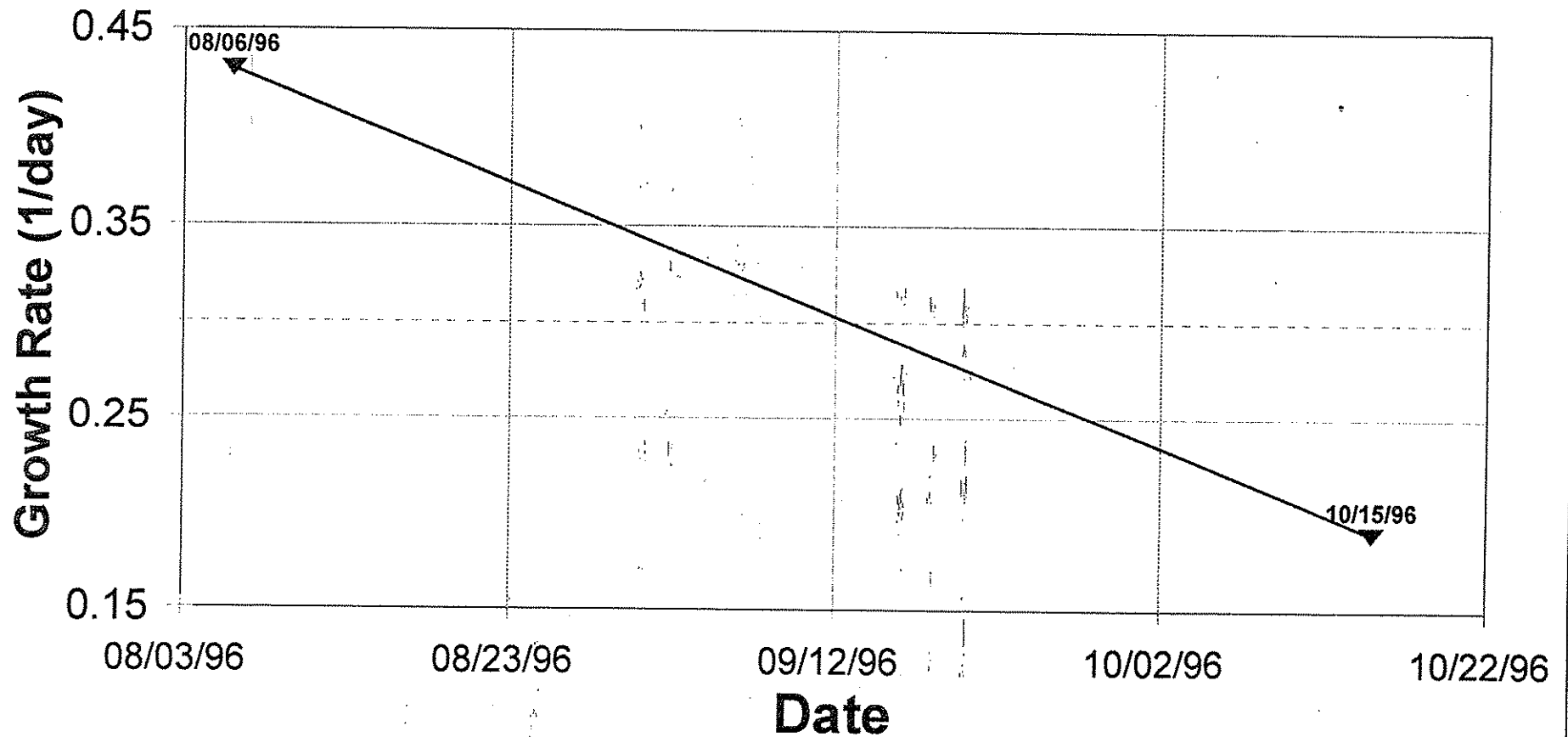

Corrected Periphyton Growth Rates Station P-8

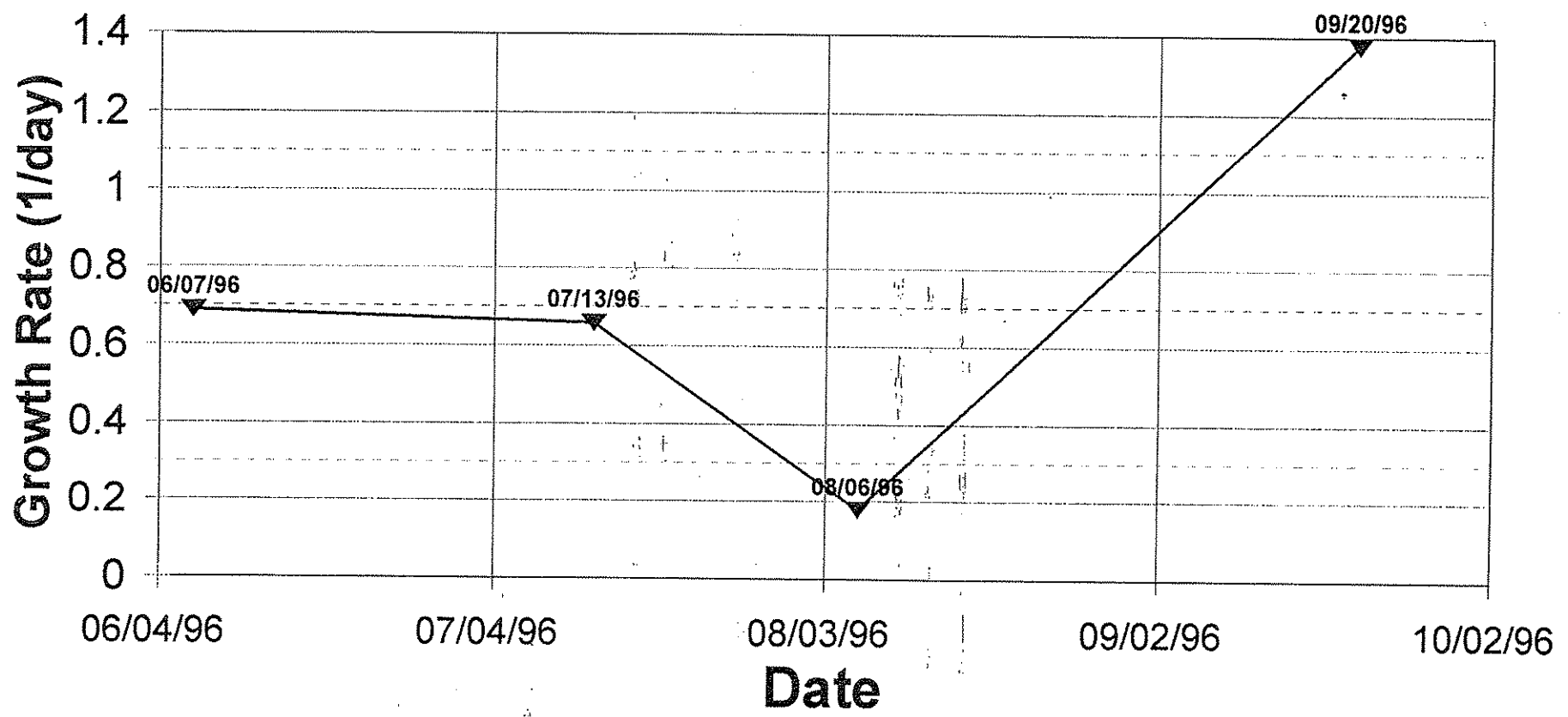

Corrected Periphyton Growth Rates Station P-9

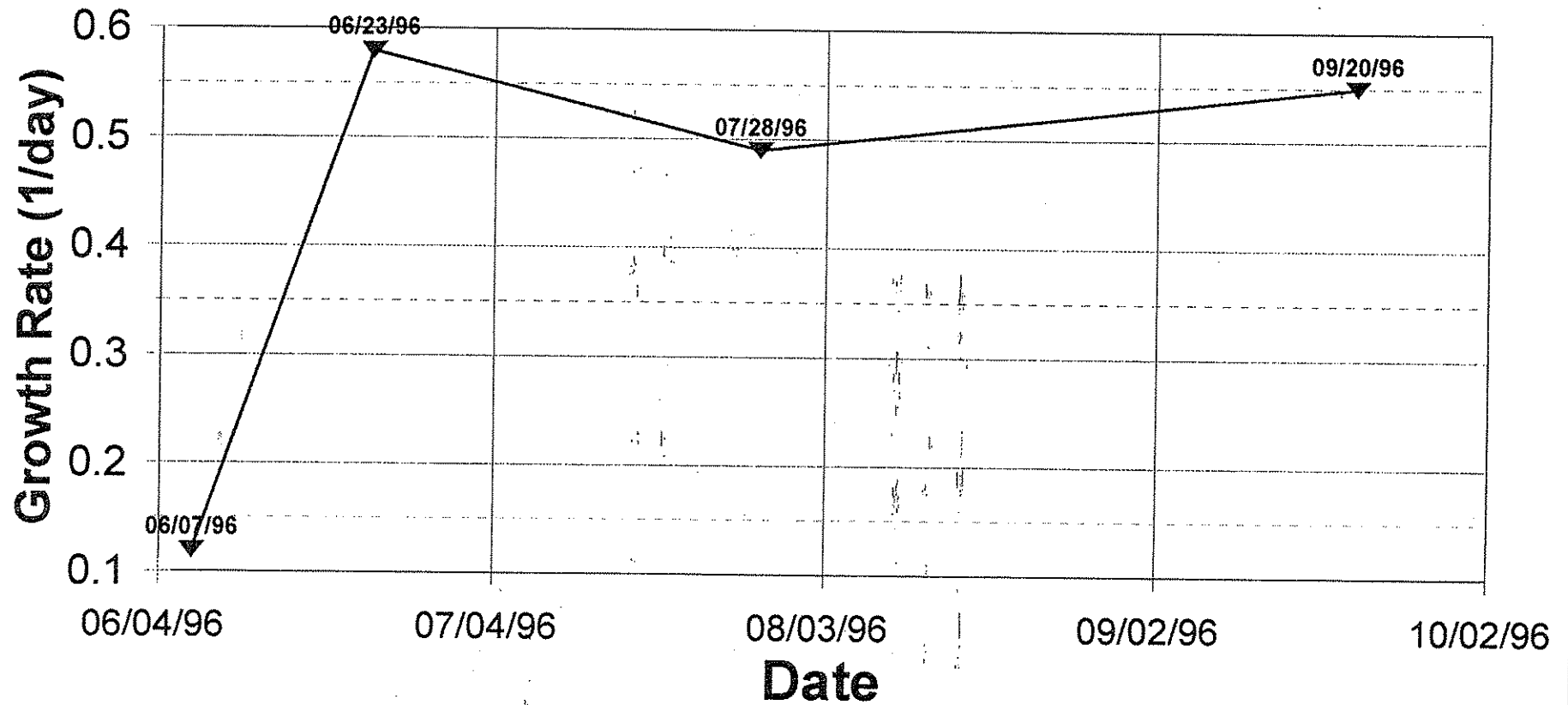

Corrected Periphyton Growth Rates Station P-10

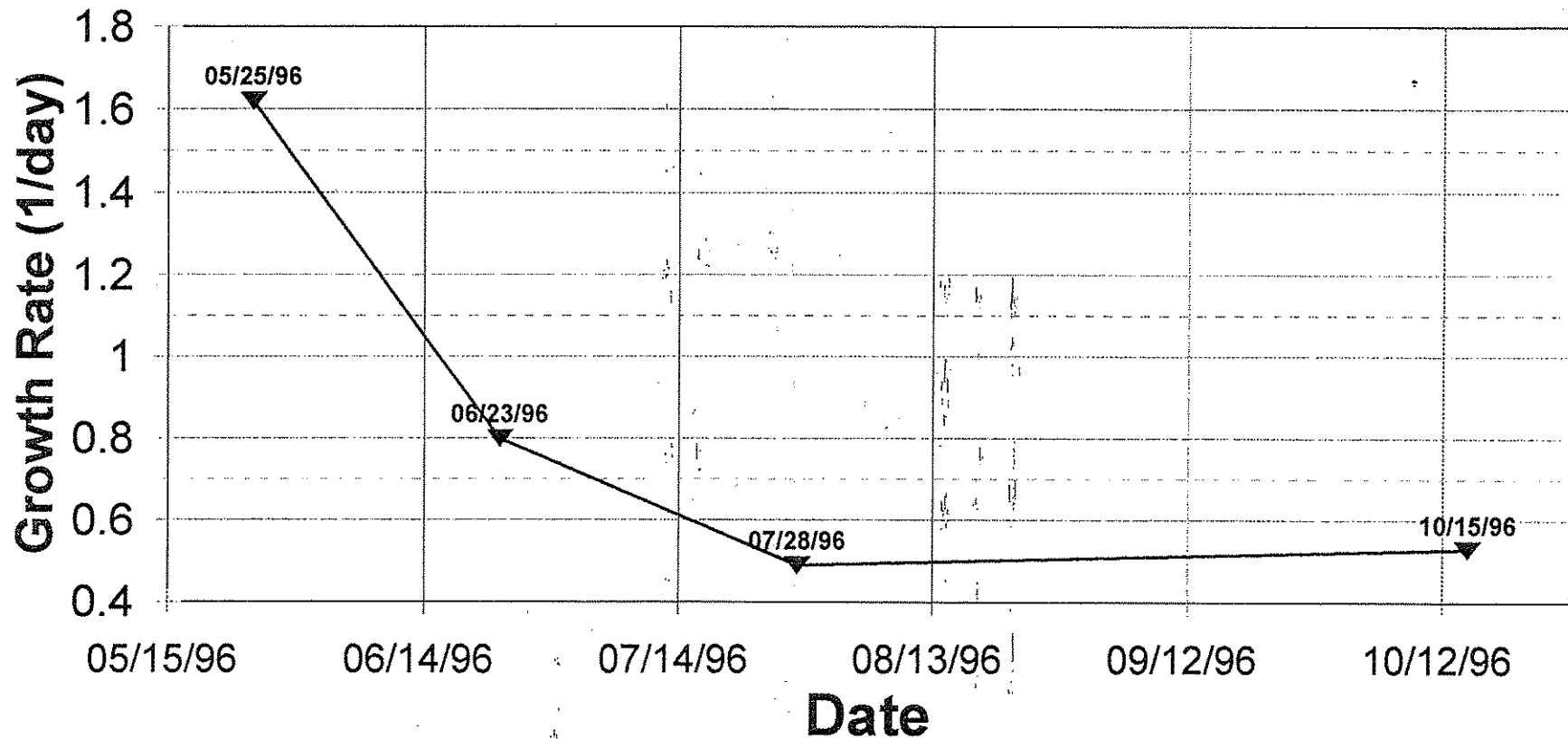

Corrected Periphyton Growth Rates Station P-11

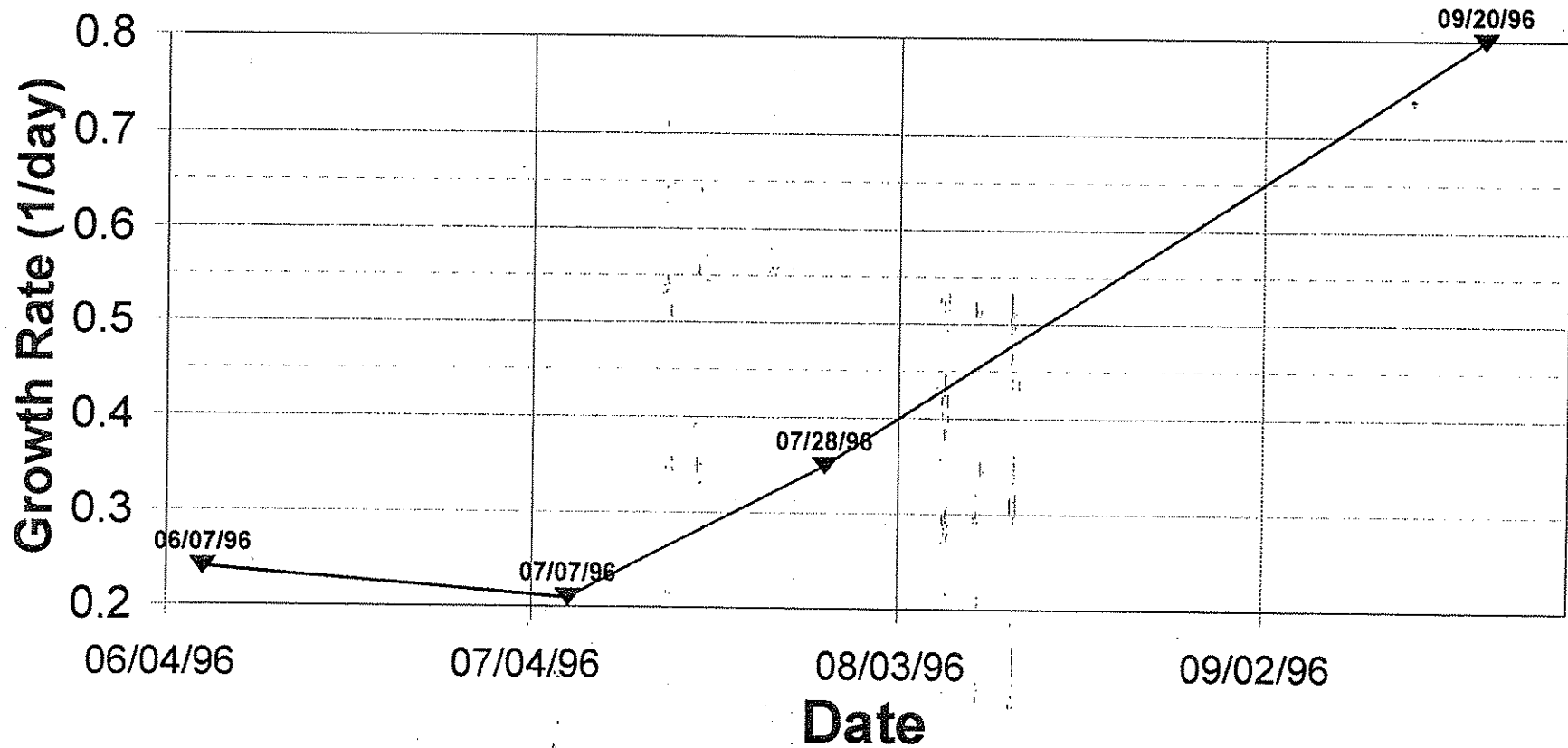

Periphyton Growth: STATION P-1

6/18/96 - 7/16/96

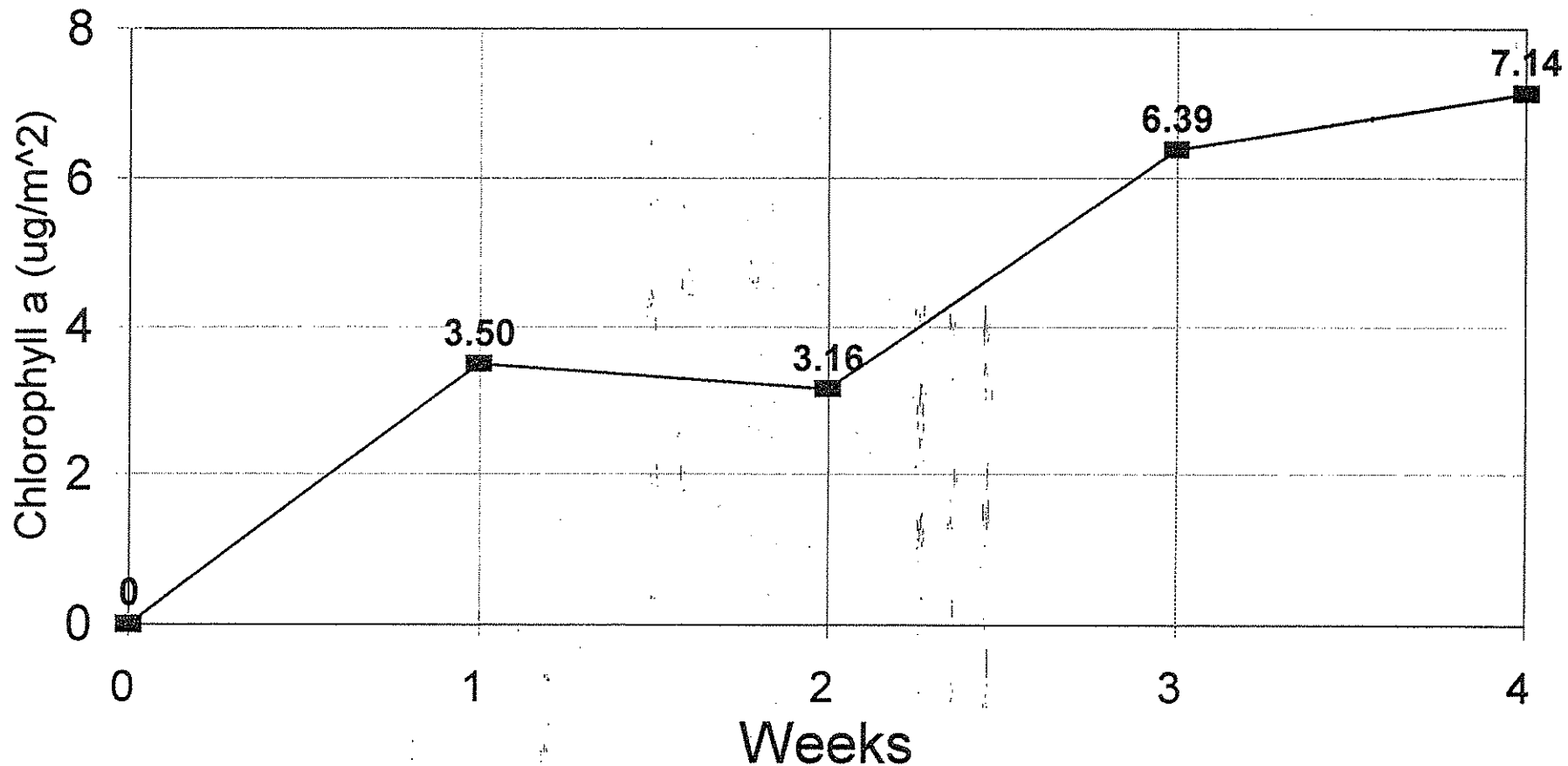

Periphyton Growth: STATION P-1

7/23/96 - 8/26/96

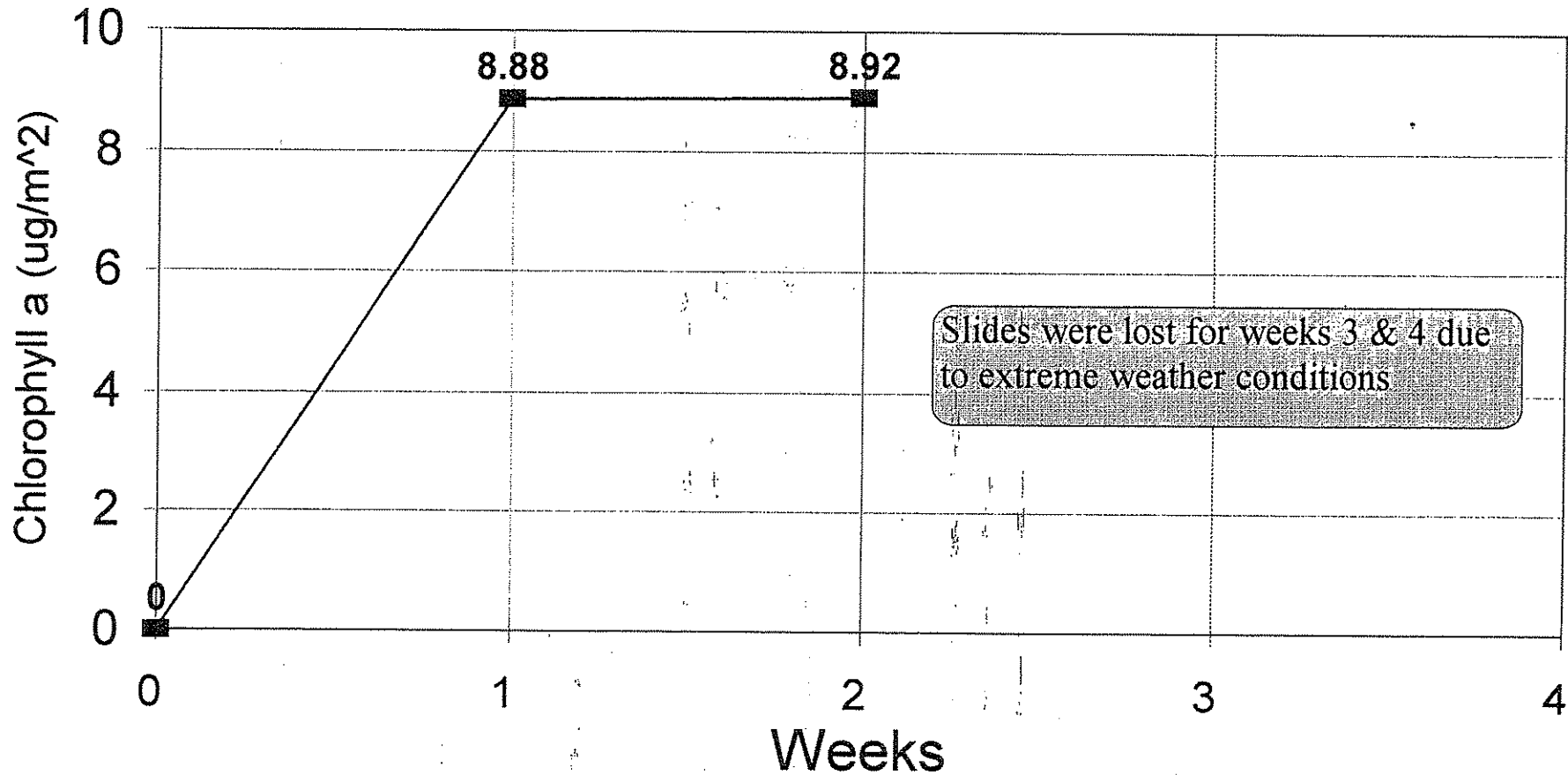

Chlorophyll a: STATION P-1

9/6/96 - 10/22/96

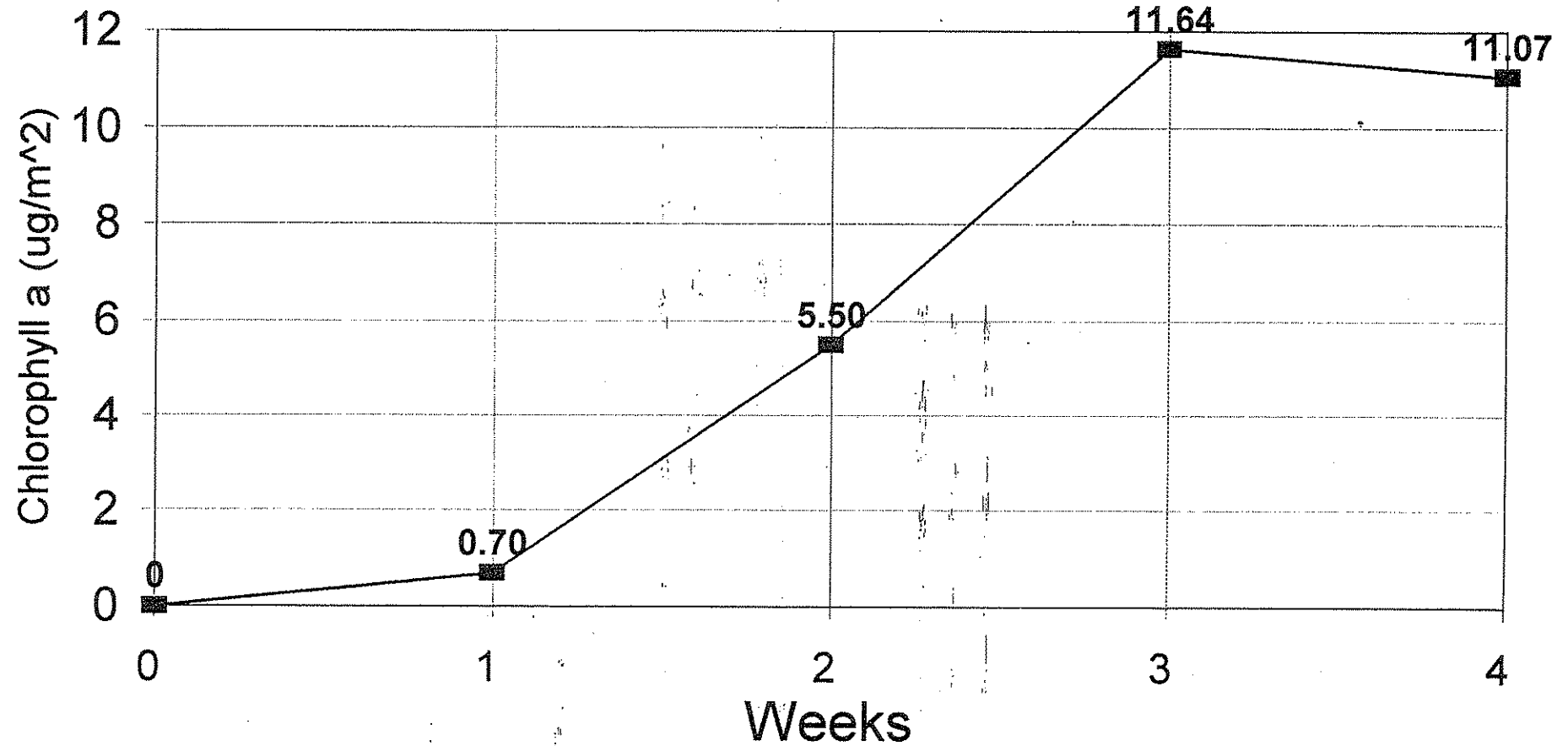

Chlorophyll a: STATION P-2

5/21/96 - 6/17/96

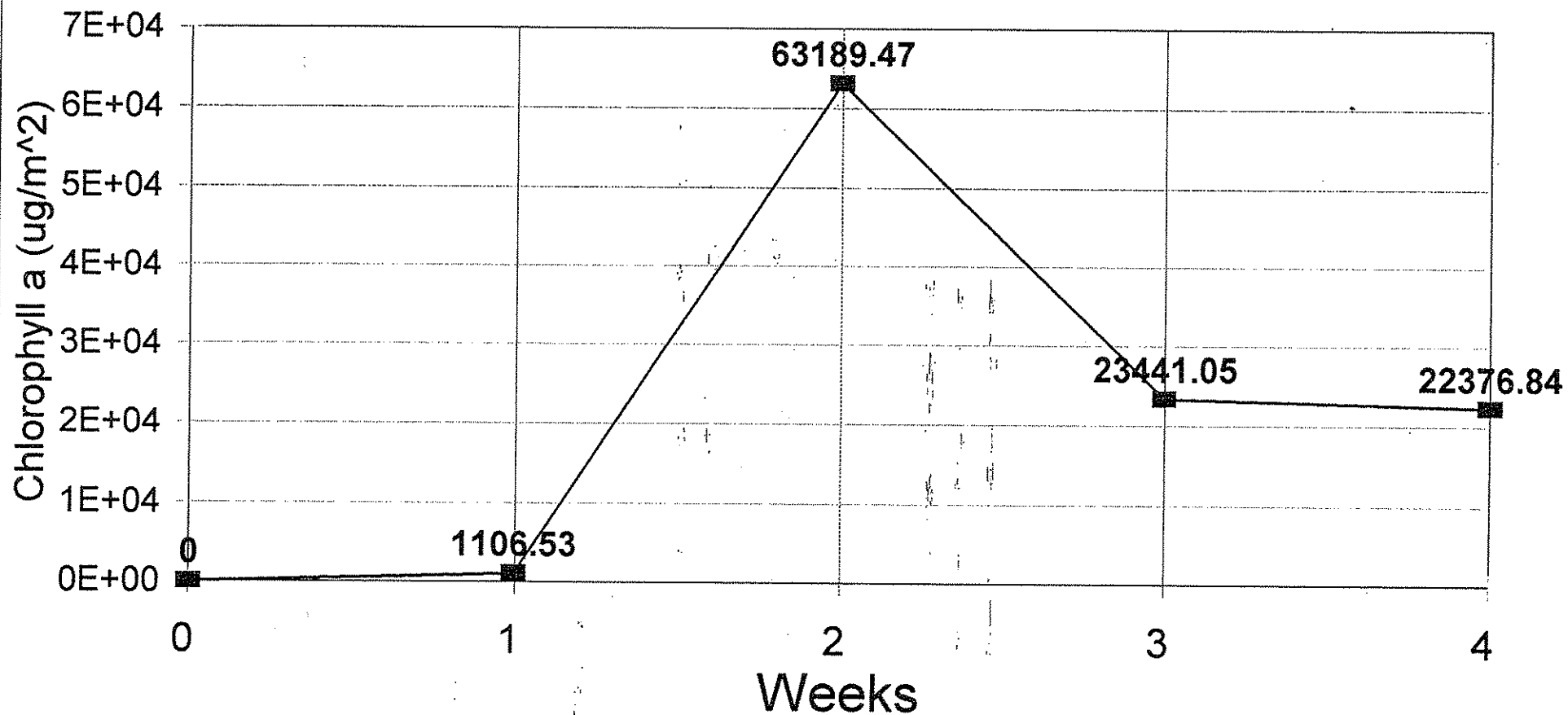

Chlorophyll a: STATION P-2

6/18/96 - 7/16/96

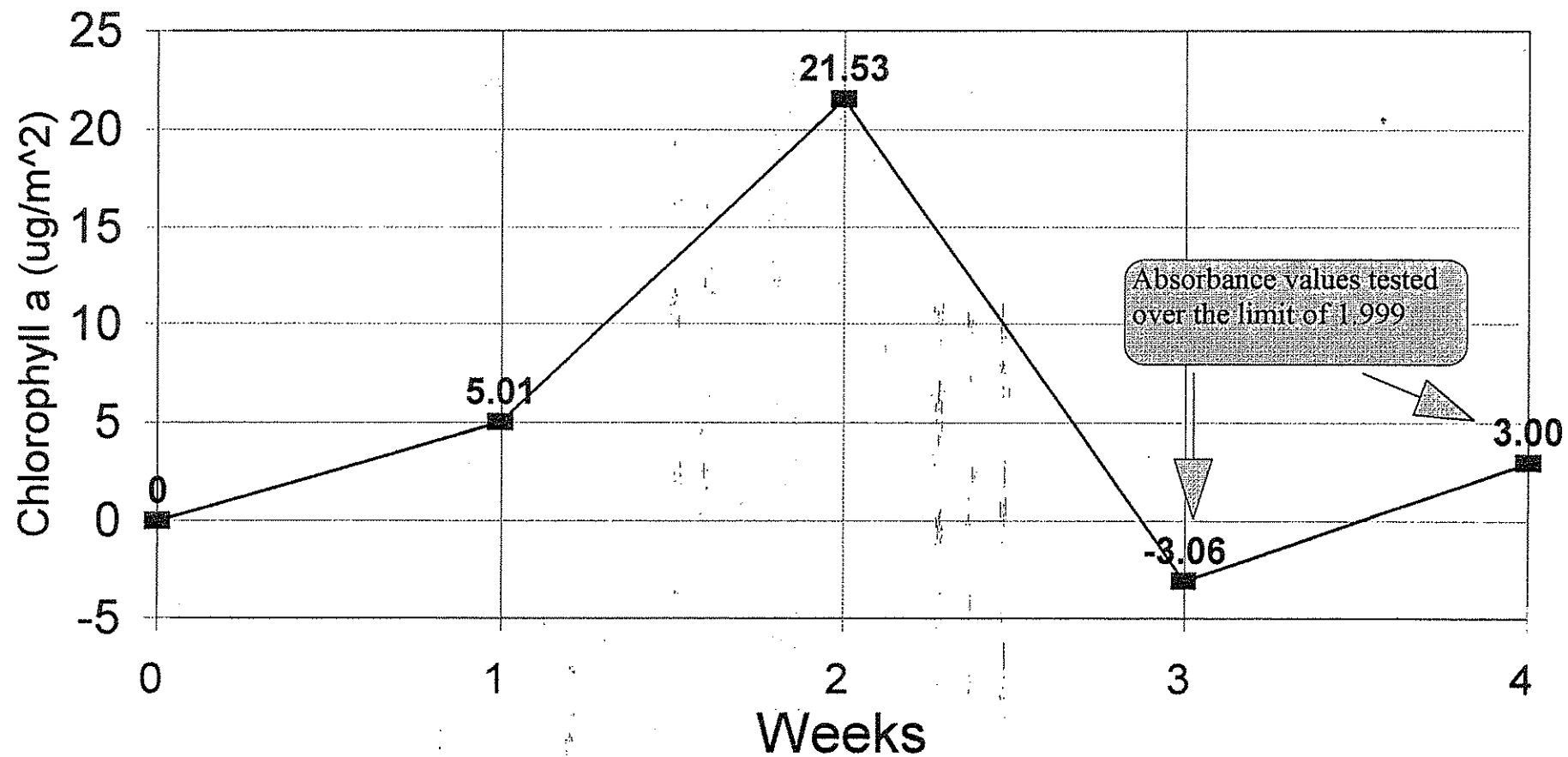

Chlorophyll a: STATION P-2

7/23/96 - 8/26/96

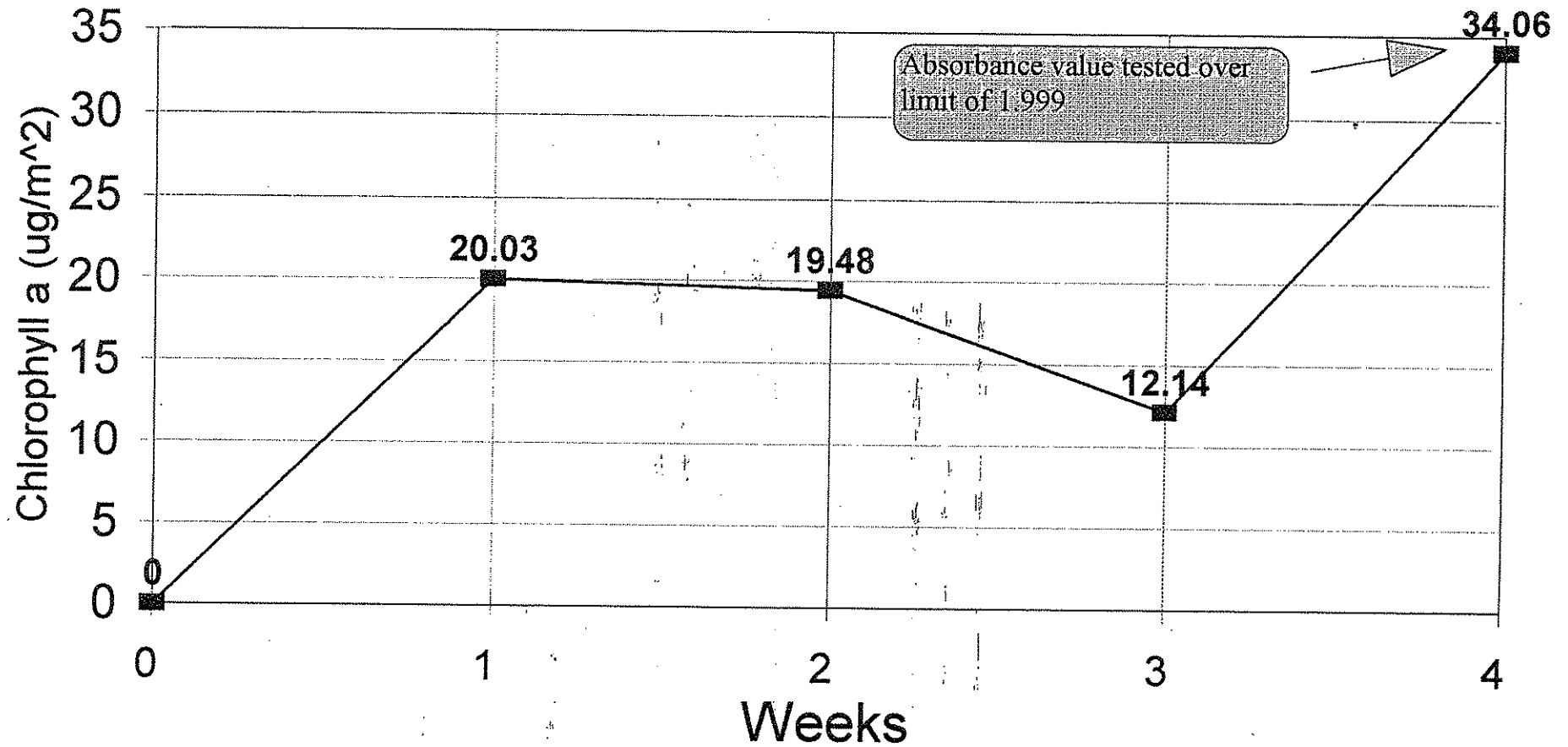

Chlorophyll a: STATION P-2

9/6/96/96 - 10/22/96

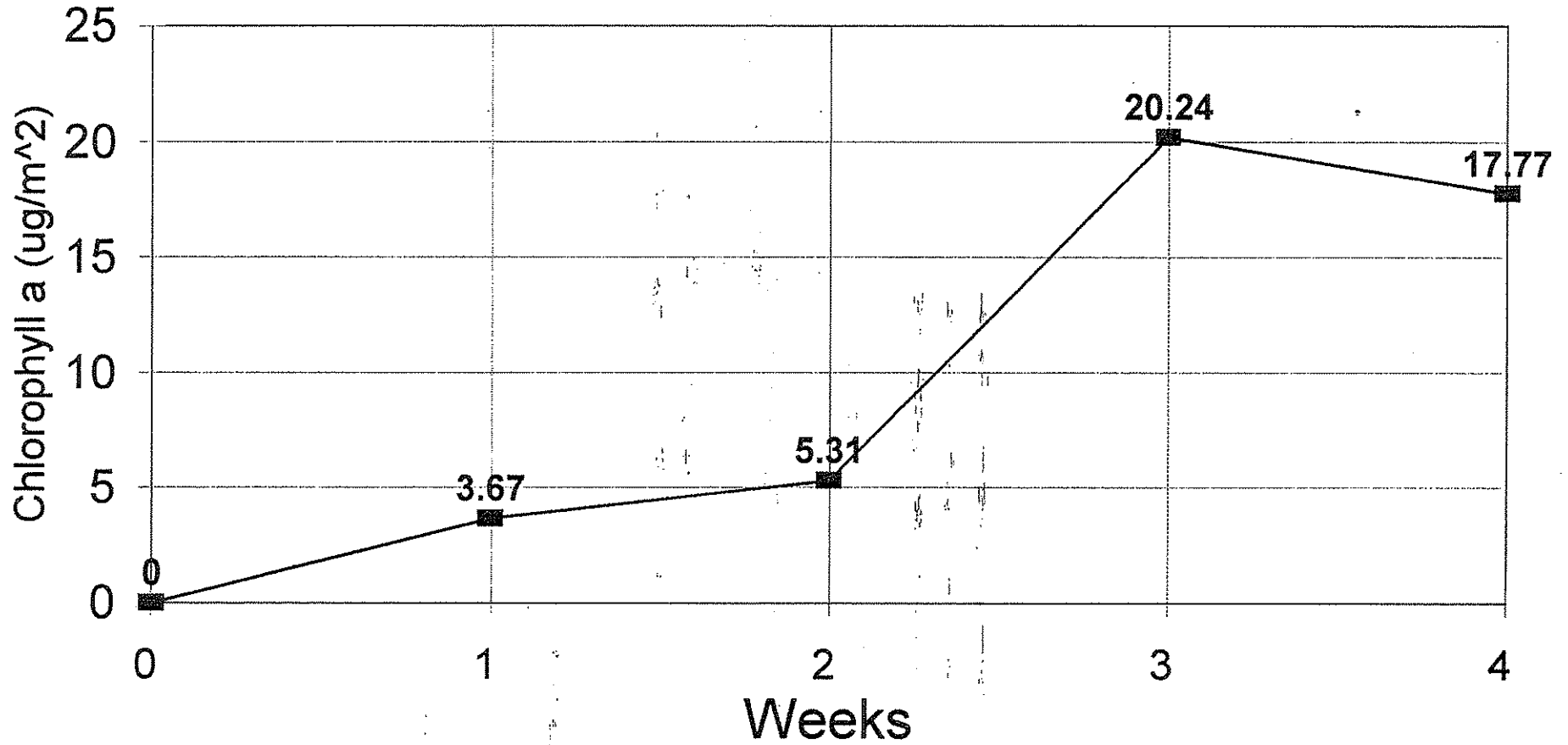

Chlorophyll a: STATION P-3

5/21/96 - 6/17/96

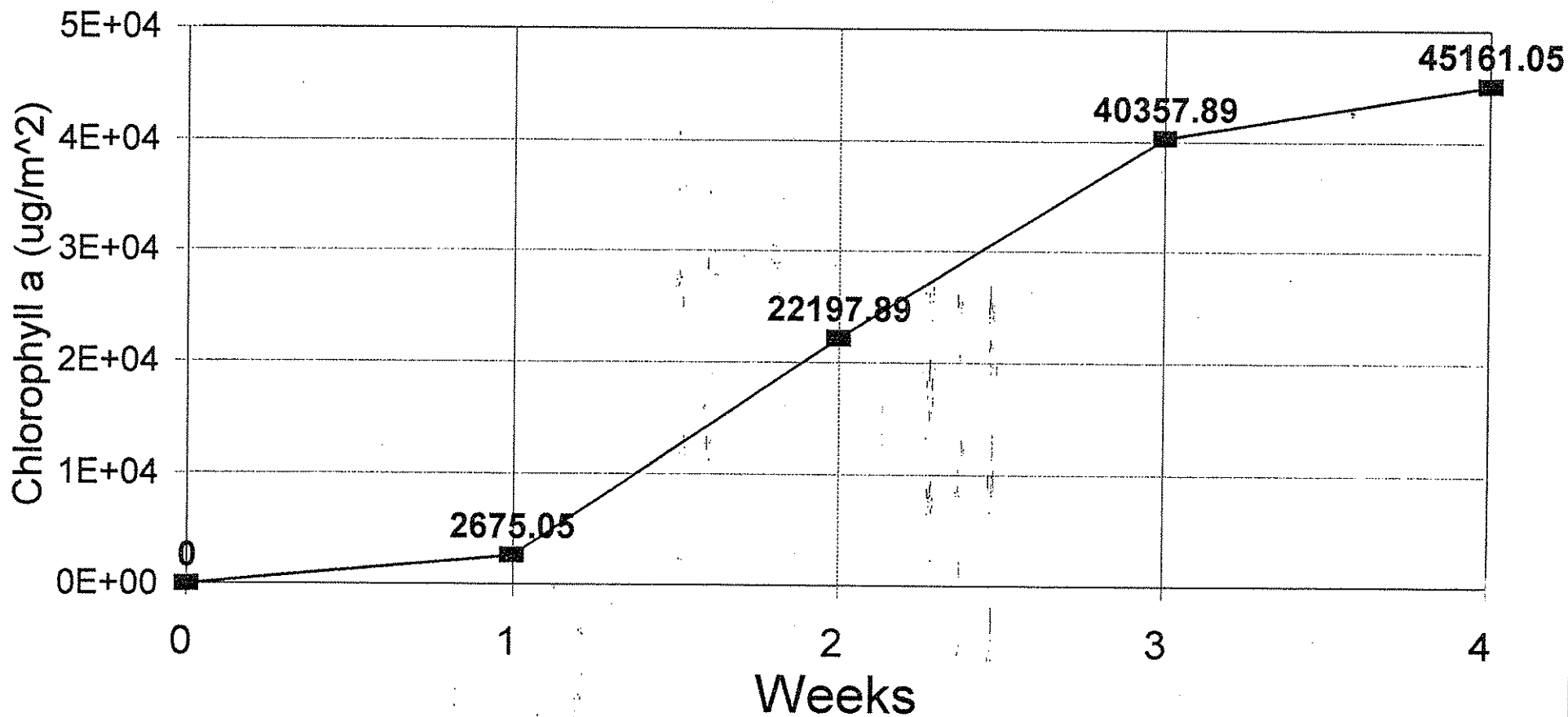

Chlorophyll a: STATION P-3

6/18/96 - 7/16/96

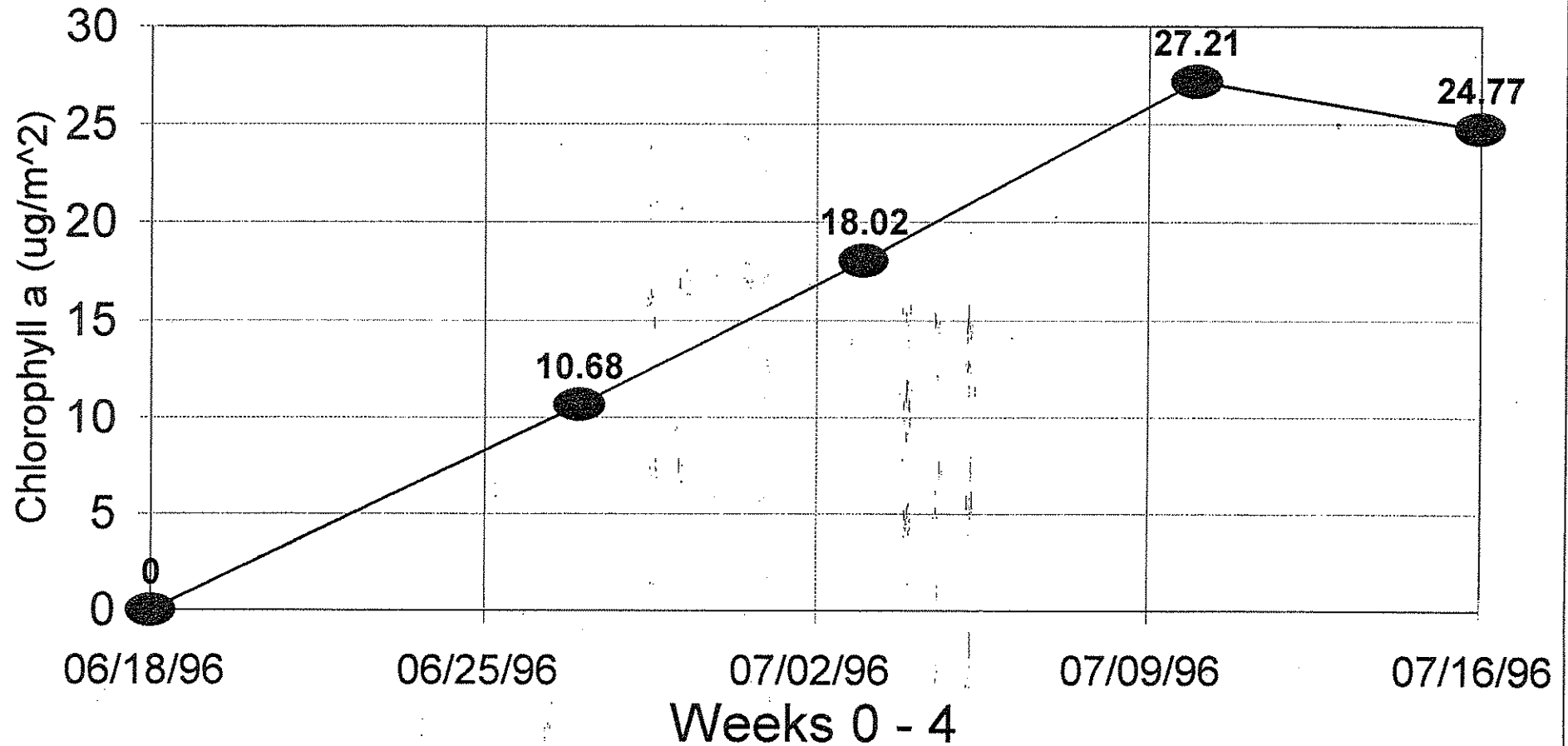

Chlorophyll a: STATION P-3

7/23/96 - 8/26/96

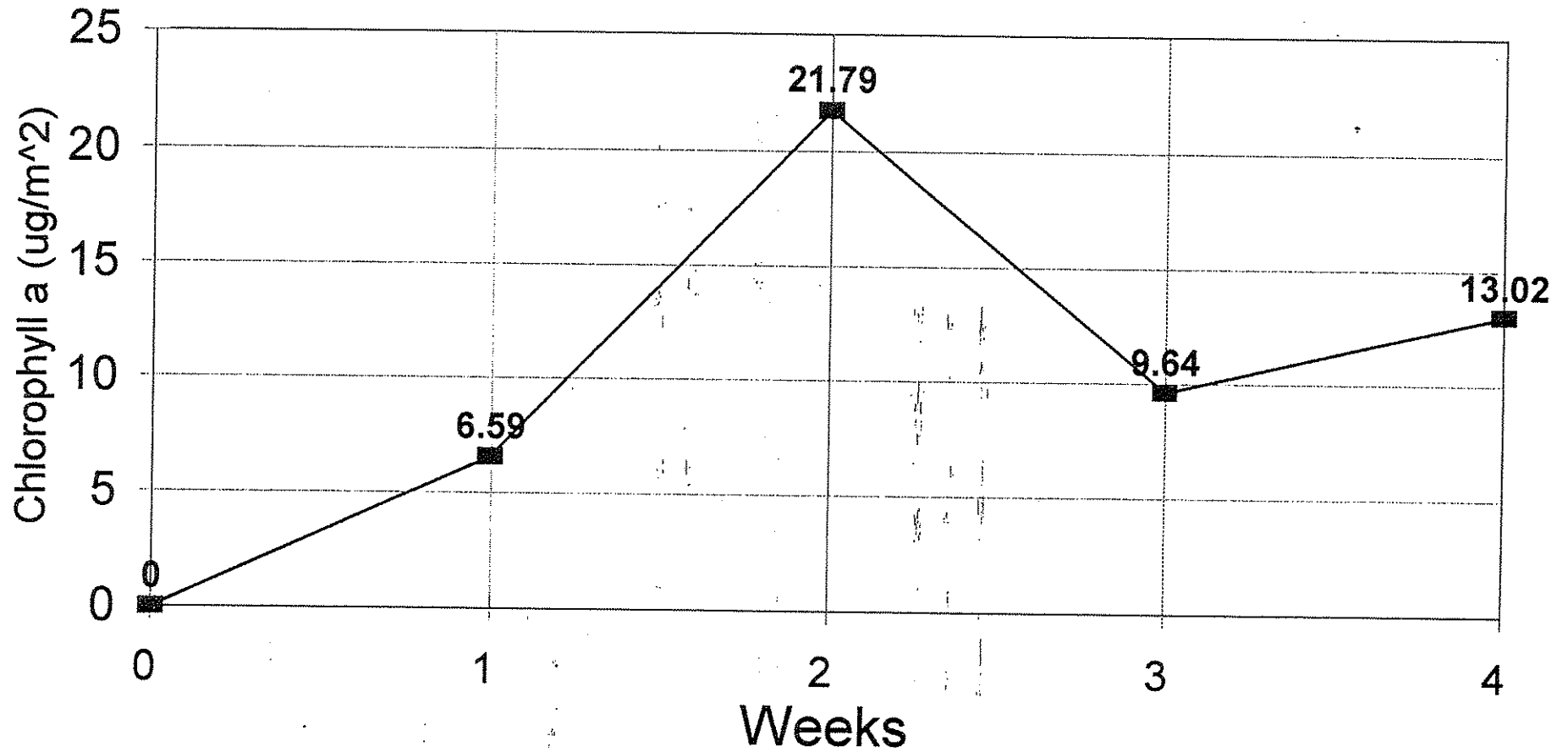

Chlorophyll a: STATION P-3

9/6/96/96 - 10/22/96

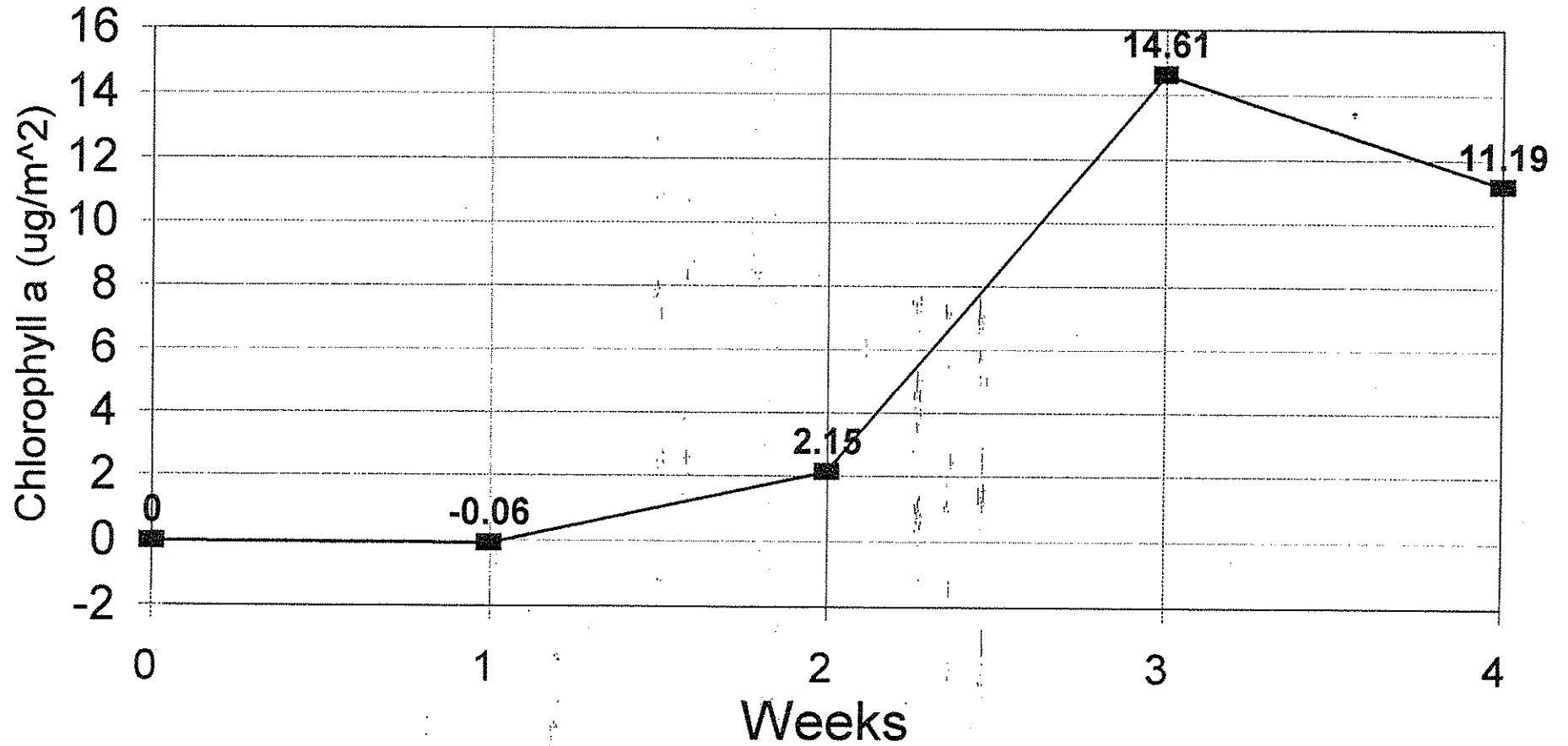

Chlorophyll a: STATION P-4

5/21/96 - 6/17/96

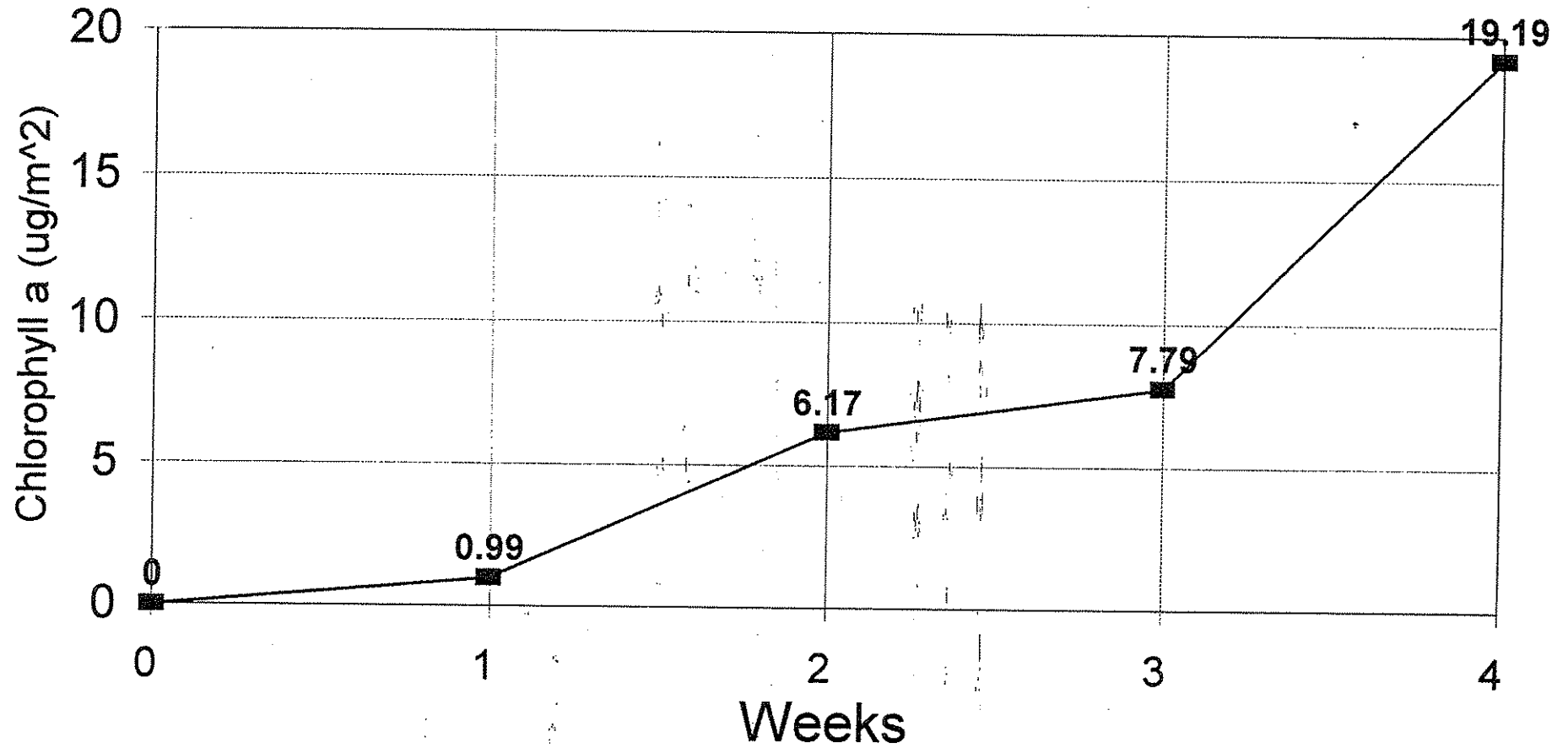

Chlorophyll a: STATION P-4

6/18/96 - 7/16/96

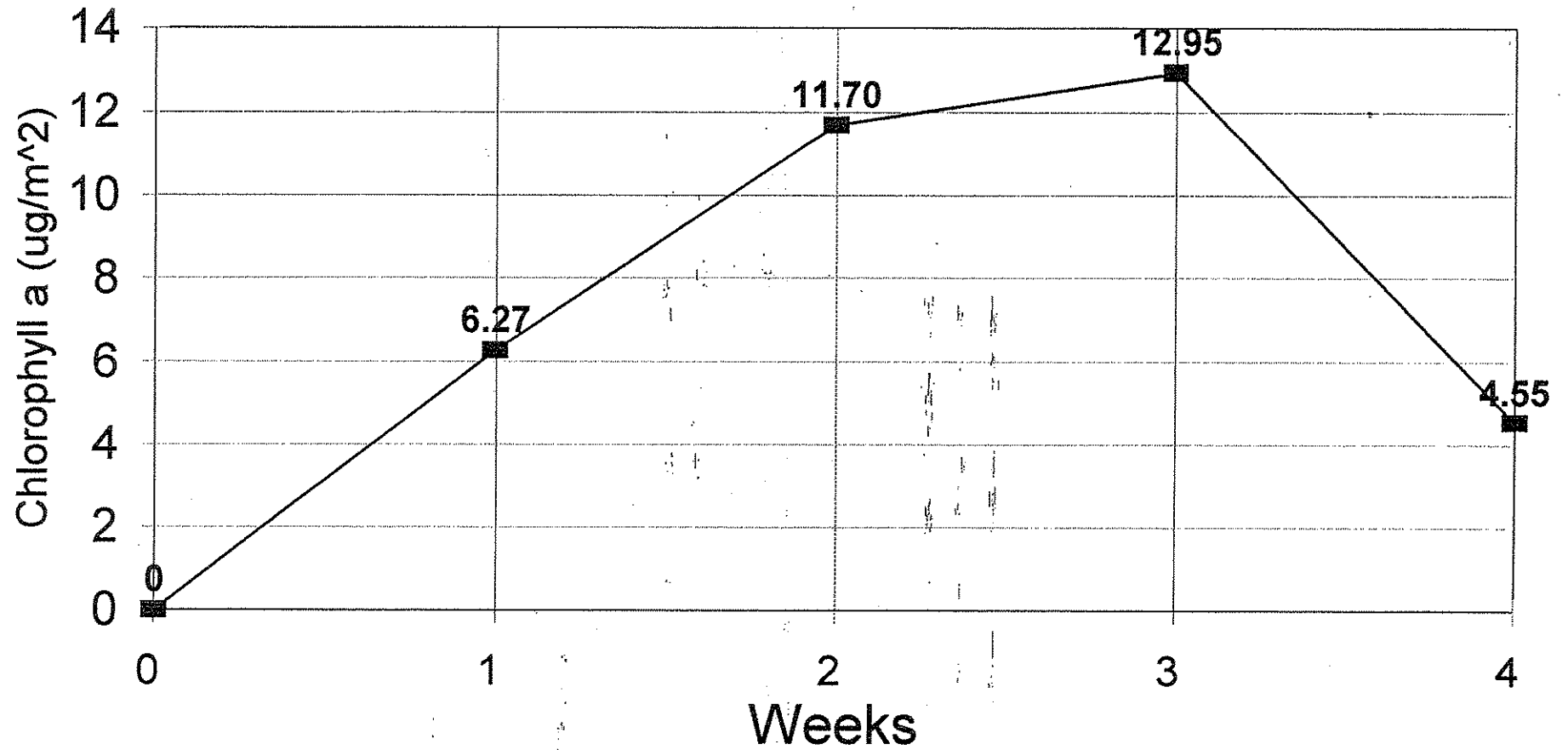

Chlorophyll a: STATION P-4

7/23/96 - 8/26/96

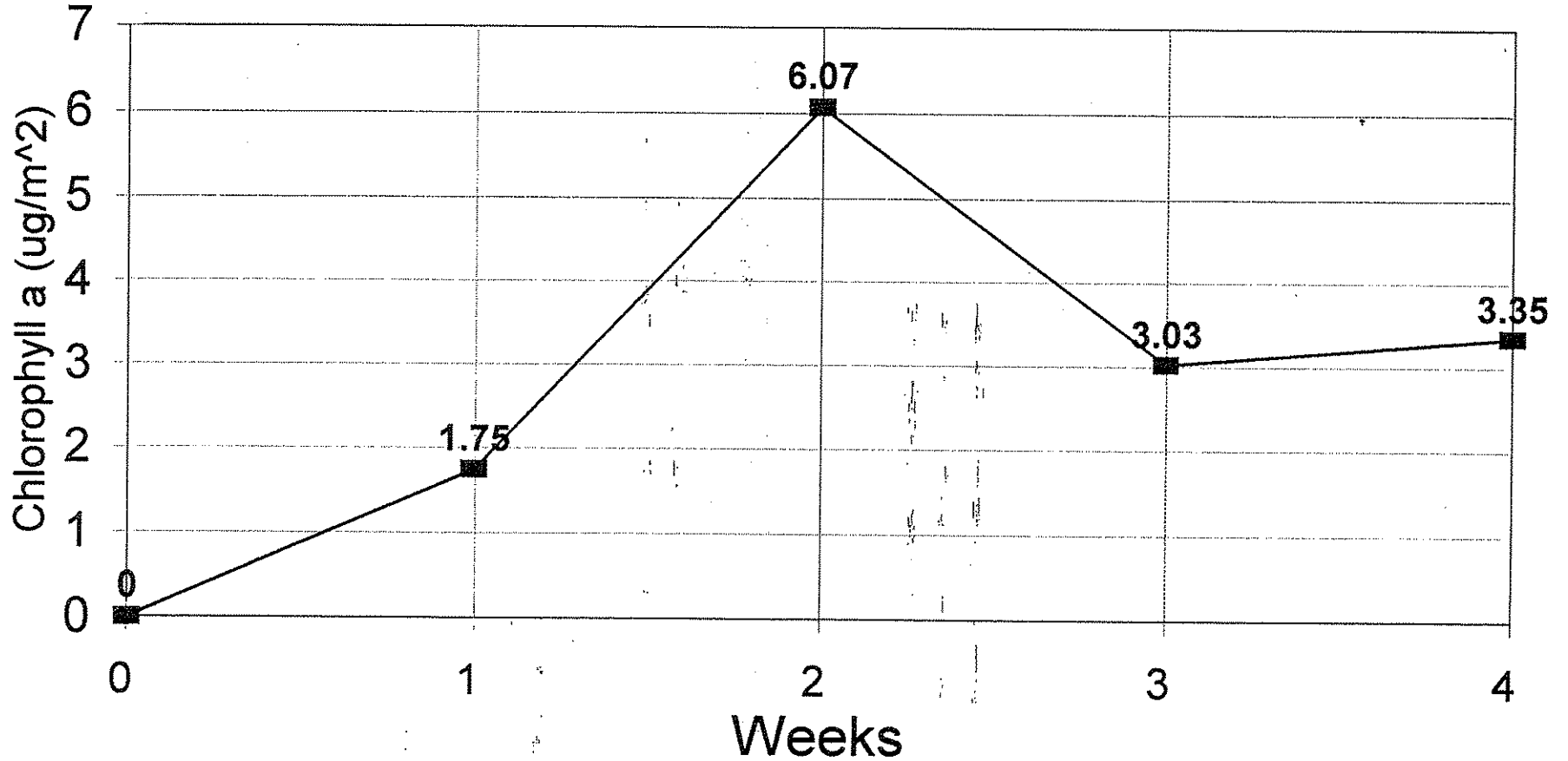

Chlorophyll a: STATION P-4

9/6/96 - 10/22/96

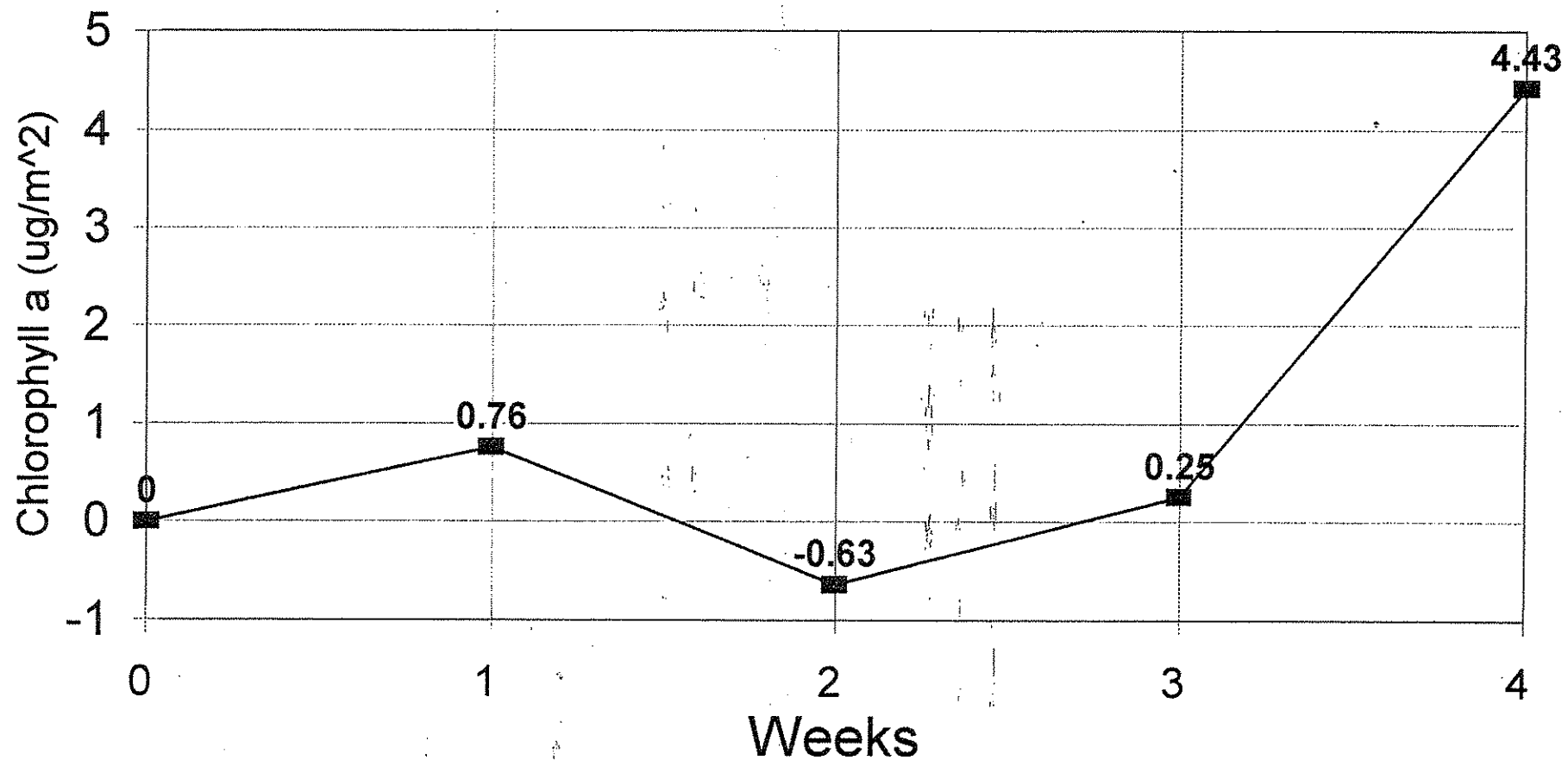

Chlorophyll a: STATION P-5

5/21/96 - 6/17/96

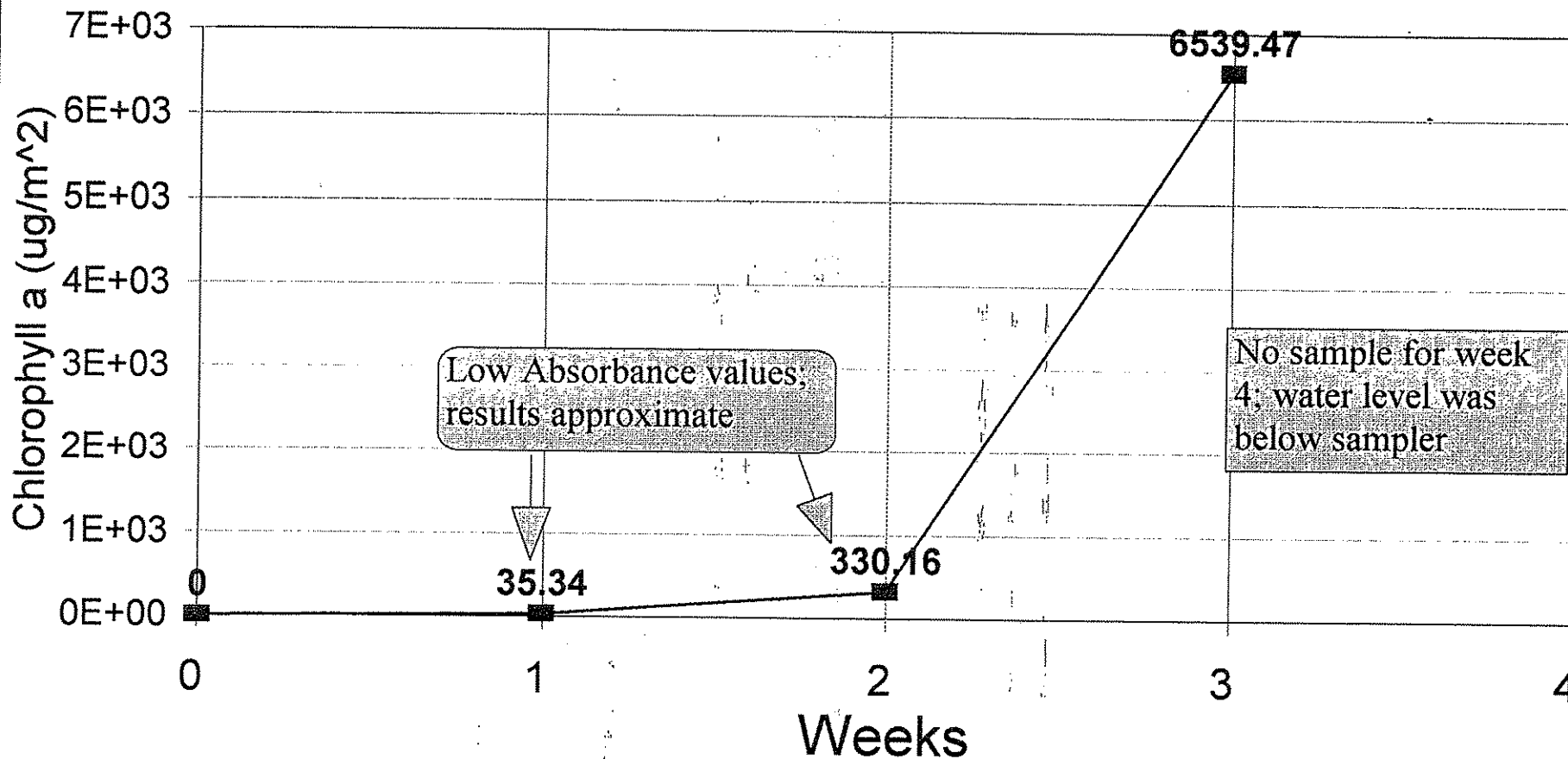

Chlorophyll a: STATION P-6

8/2/96 - 9/6/96

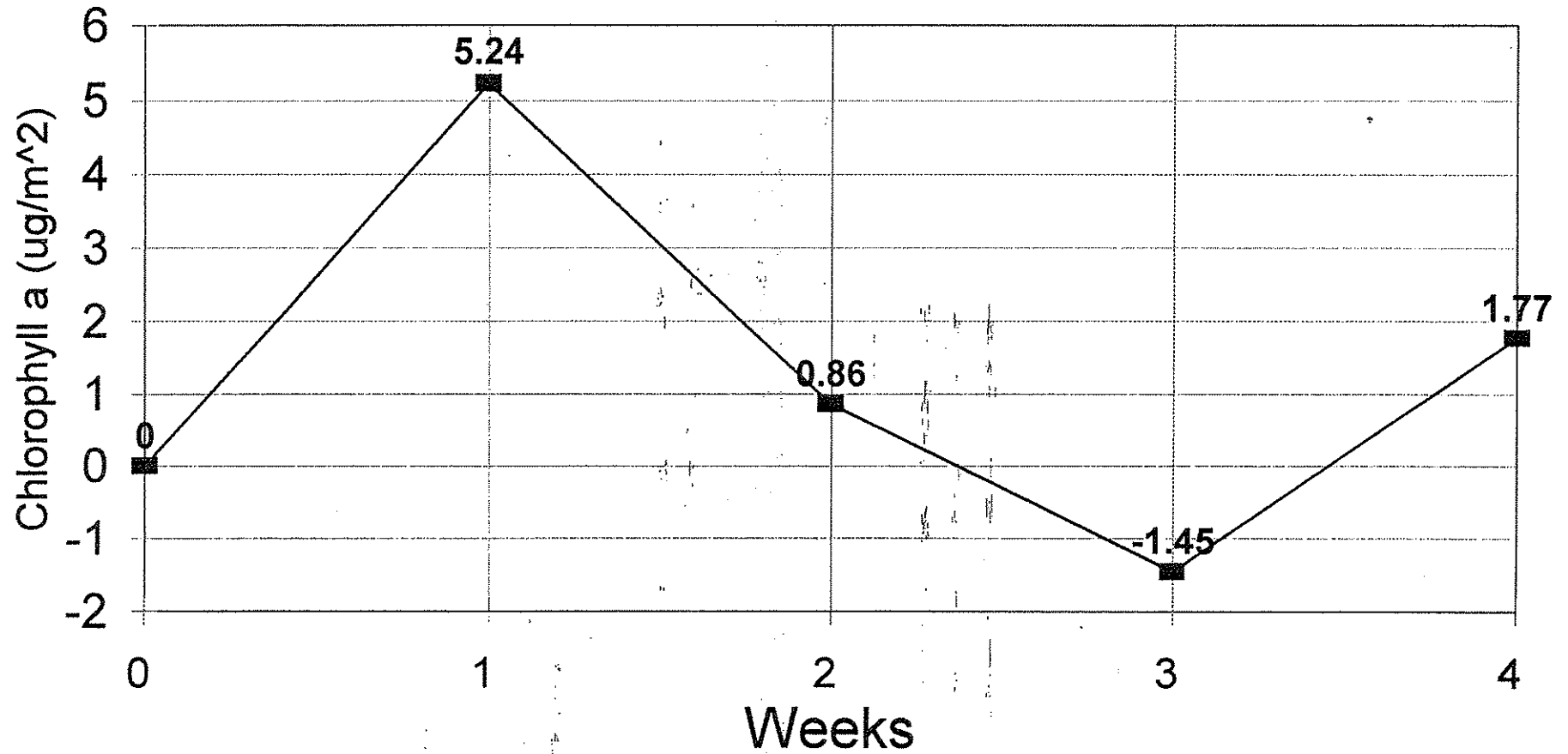

Chlorophyll a: STATION P-6

9/6/96 - 10/22/96

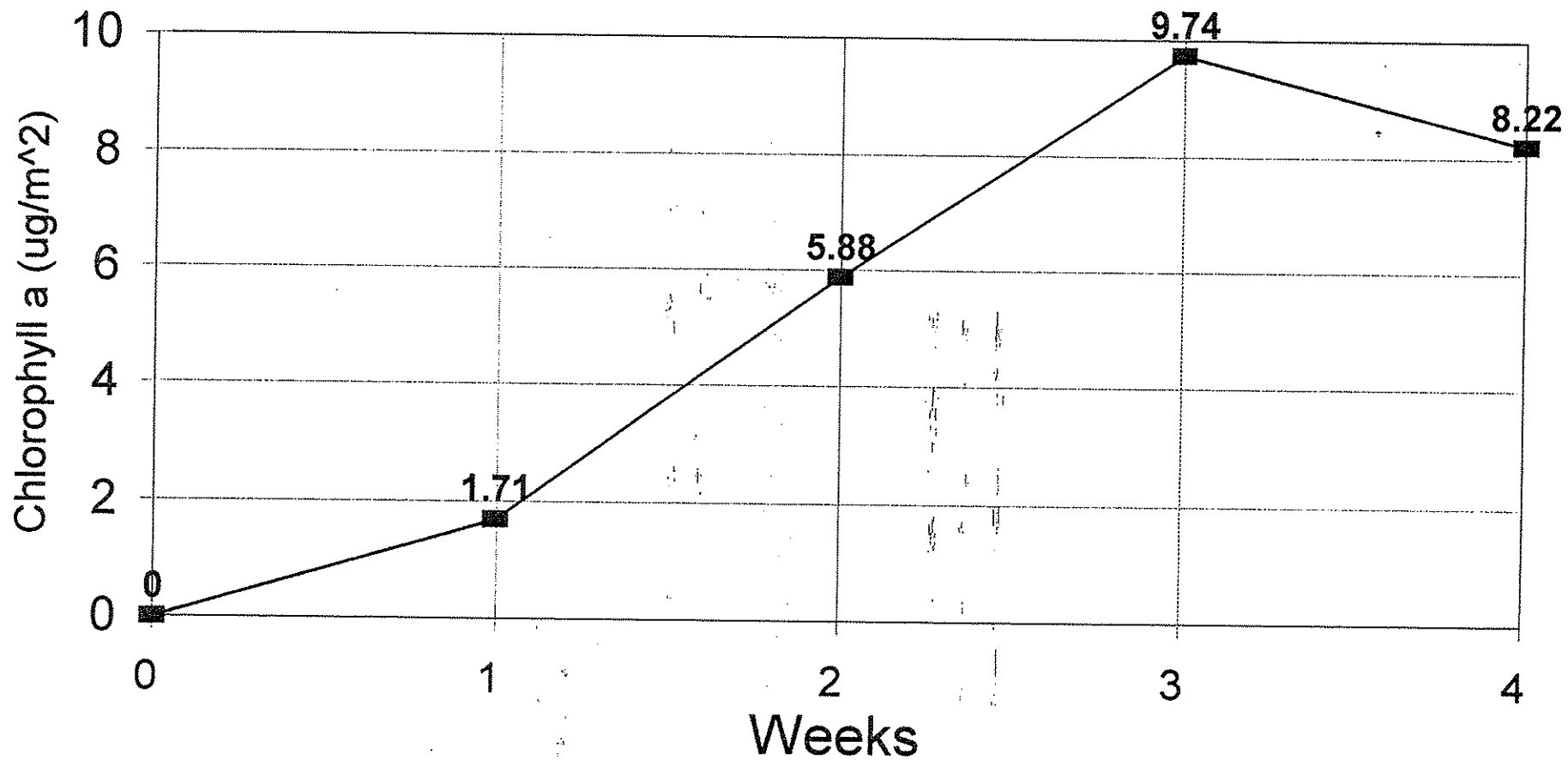

Chlorophyll a: STATION P-7

8/2/96 - 9/6/96

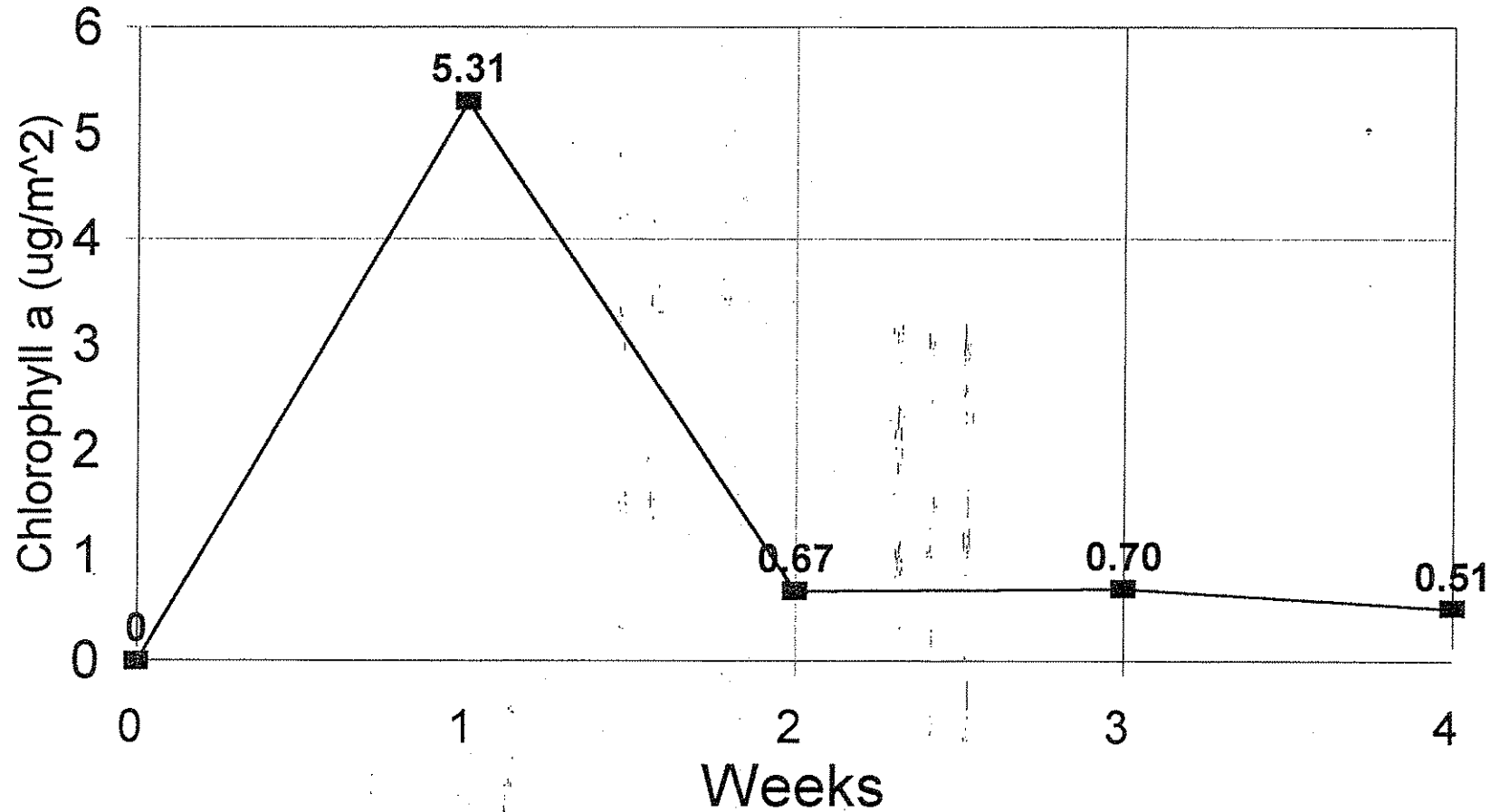

Chlorophyll a: STATION P-7

9/6/96 - 10/22/96

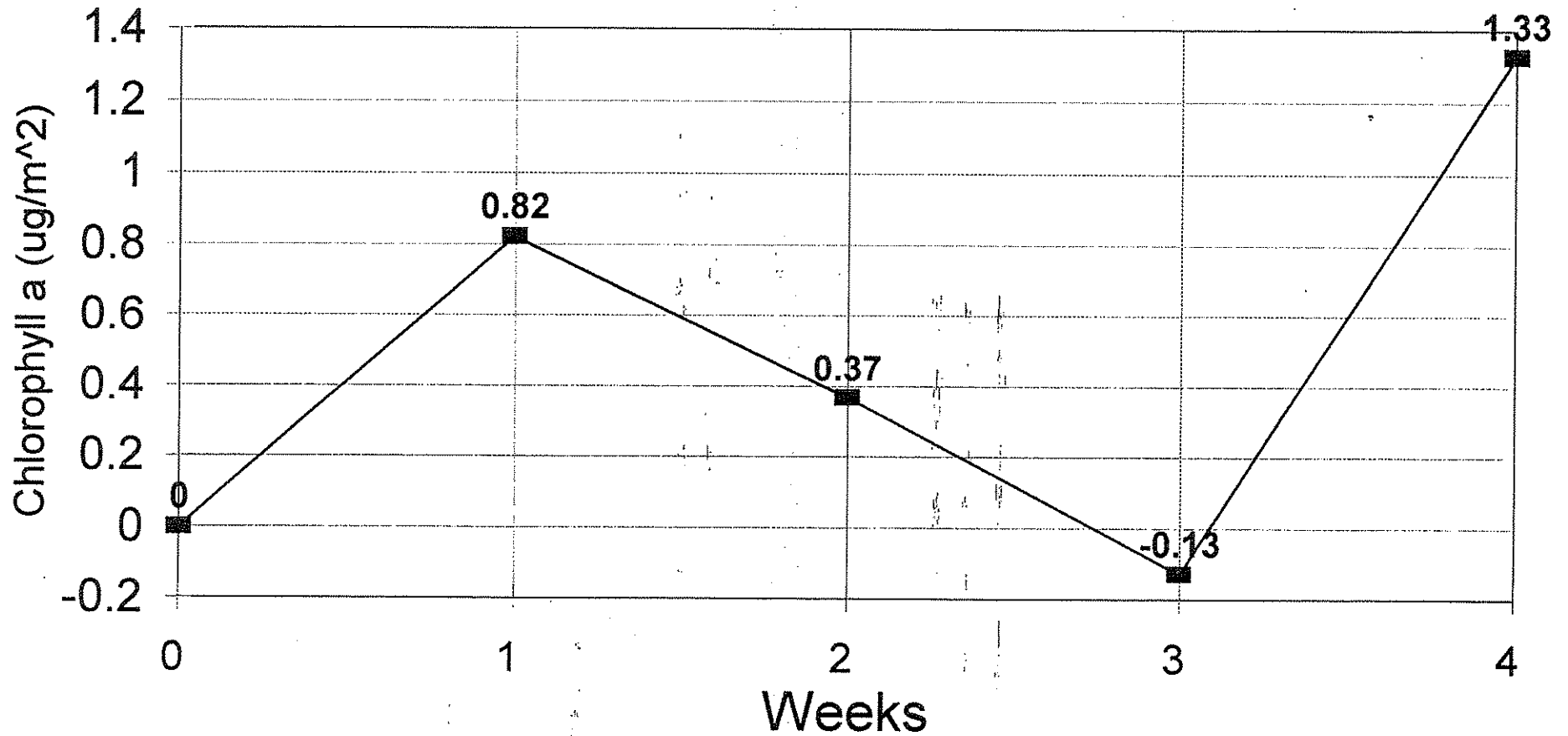

Chlorophyll a: STATION P-8

5/21/96 - 6/17/96

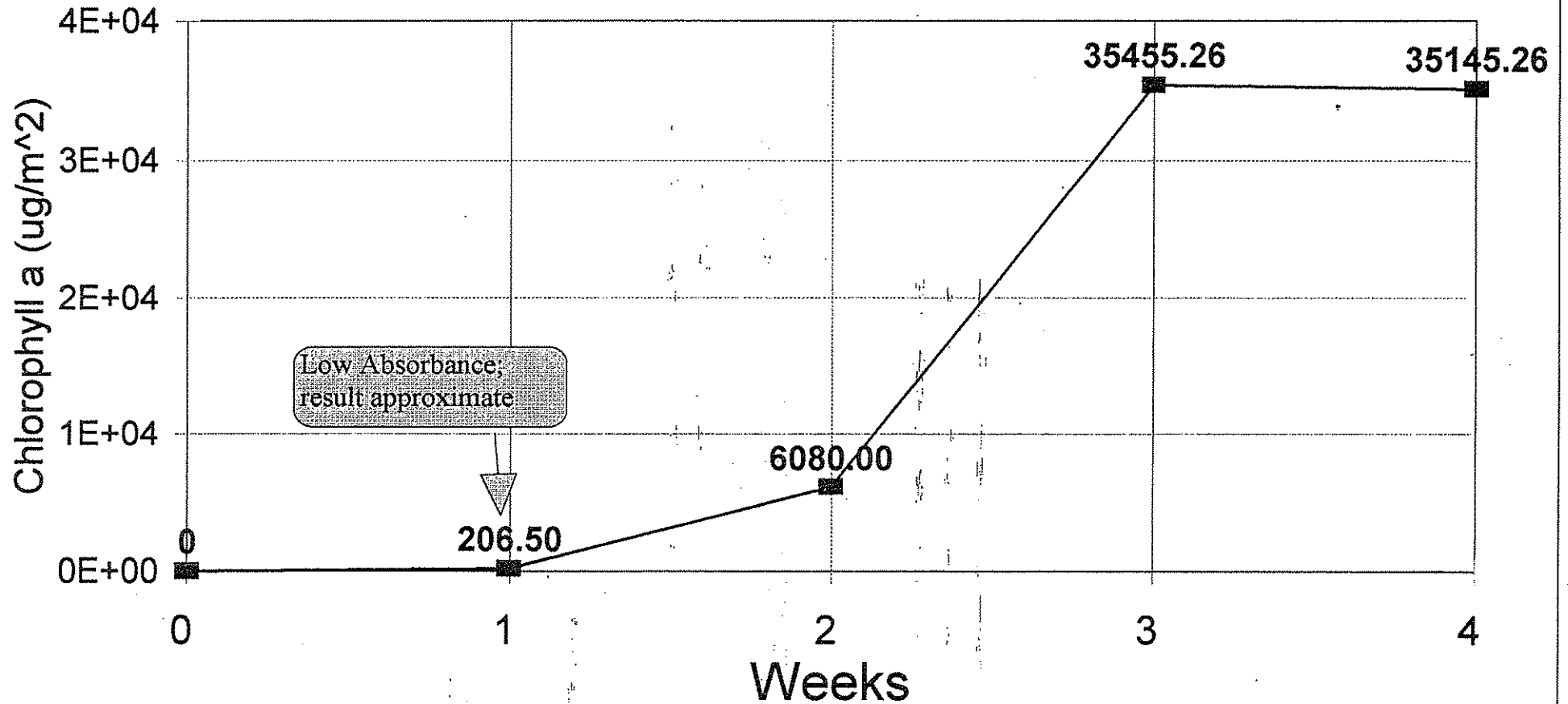

Chlorophyll a: STATION P-8

6/18/96 - 7/16/96

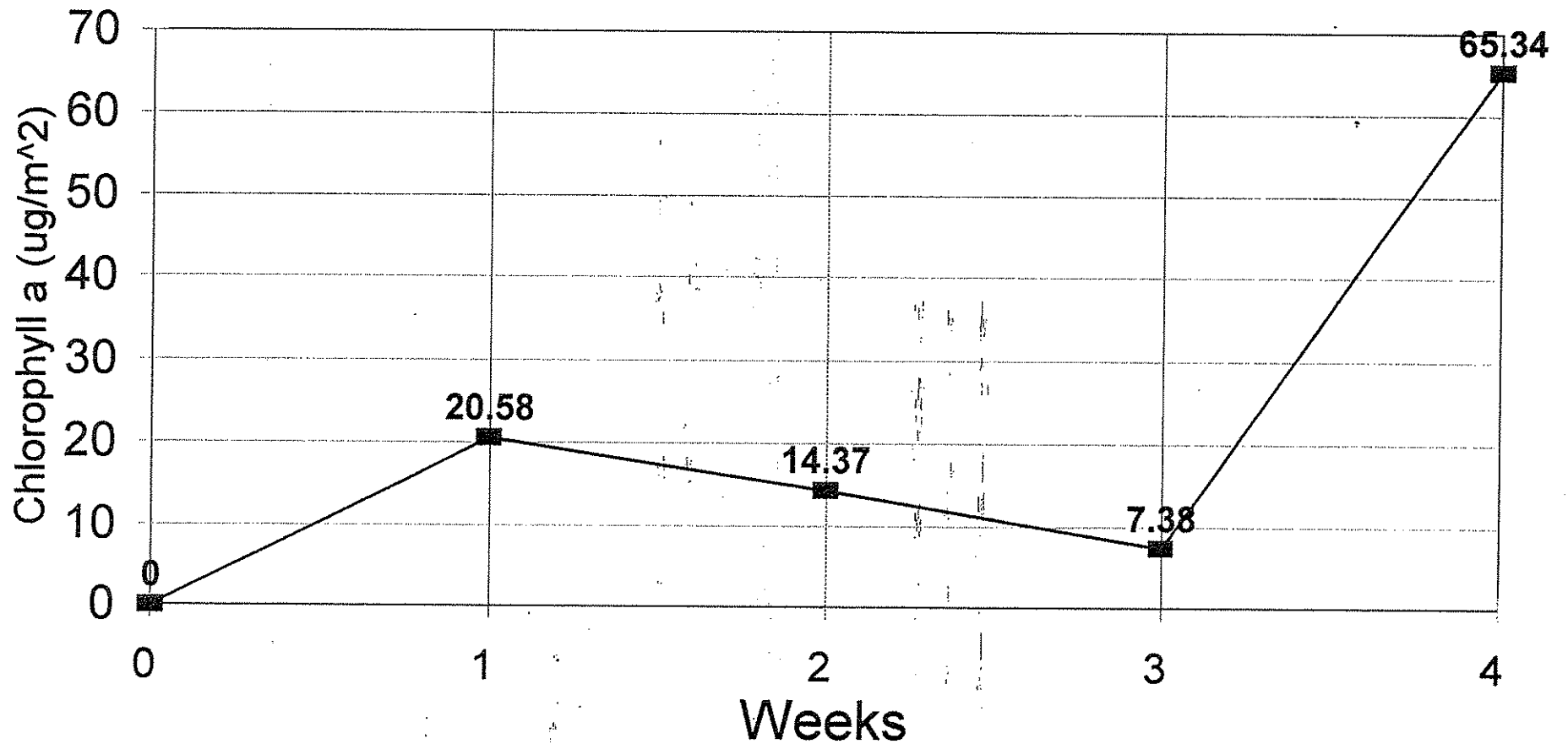

Chlorophyll a: STATION P-8

7/23/96 - 8/26/96

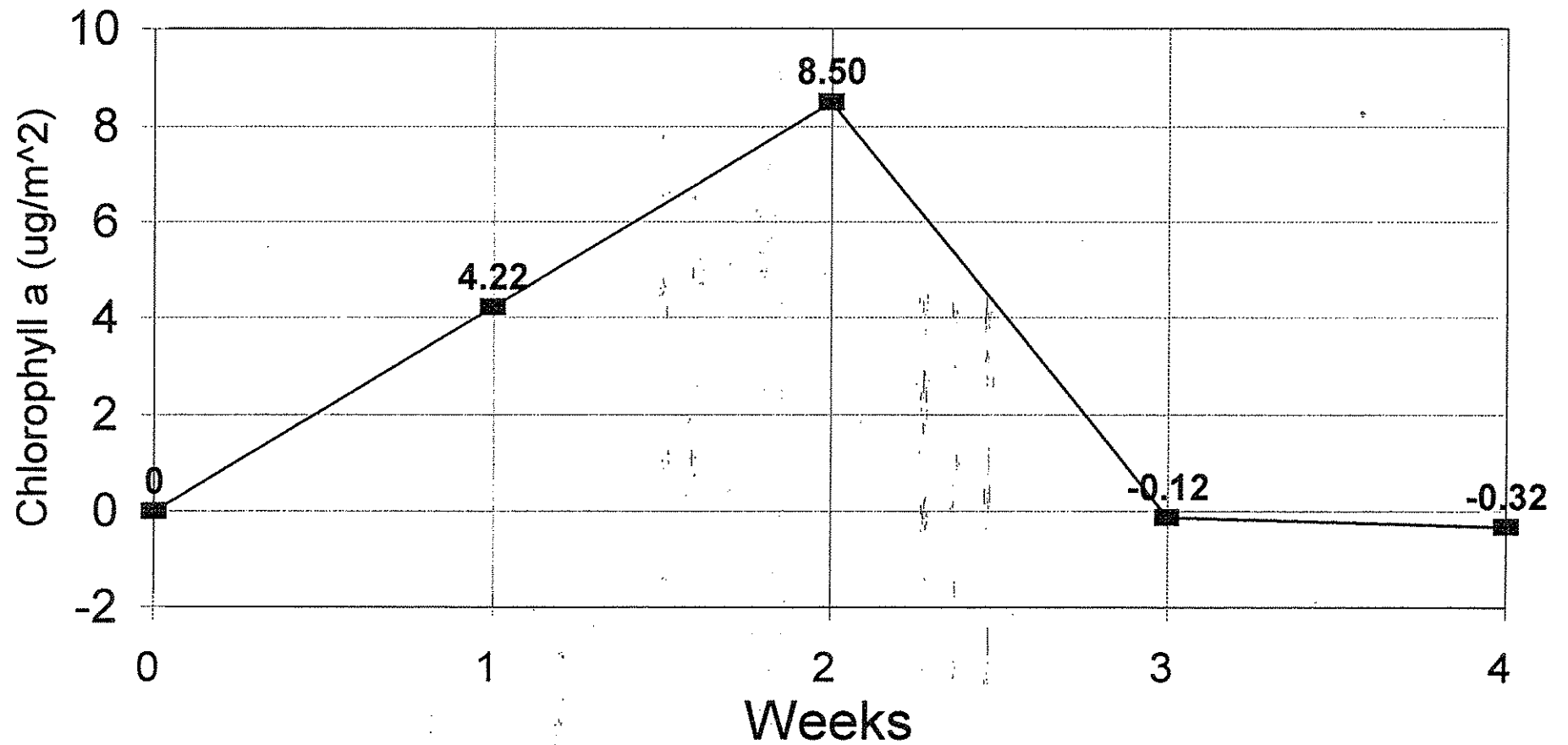

Chlorophyll a: STATION P-8

9/6/96 - 10/22/96

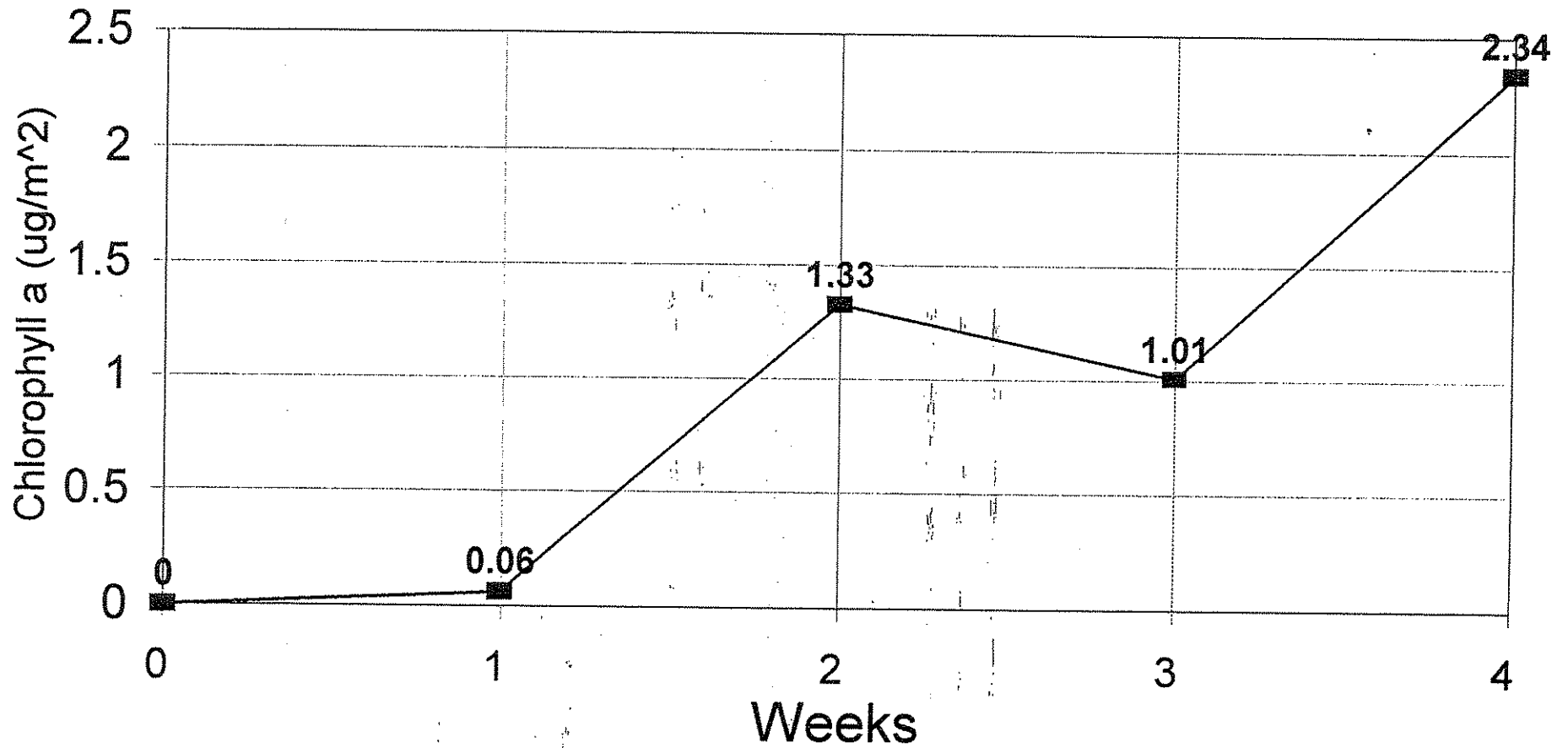

Chlorophyll a: STATION P-9

5/21/96 - 6/17/96

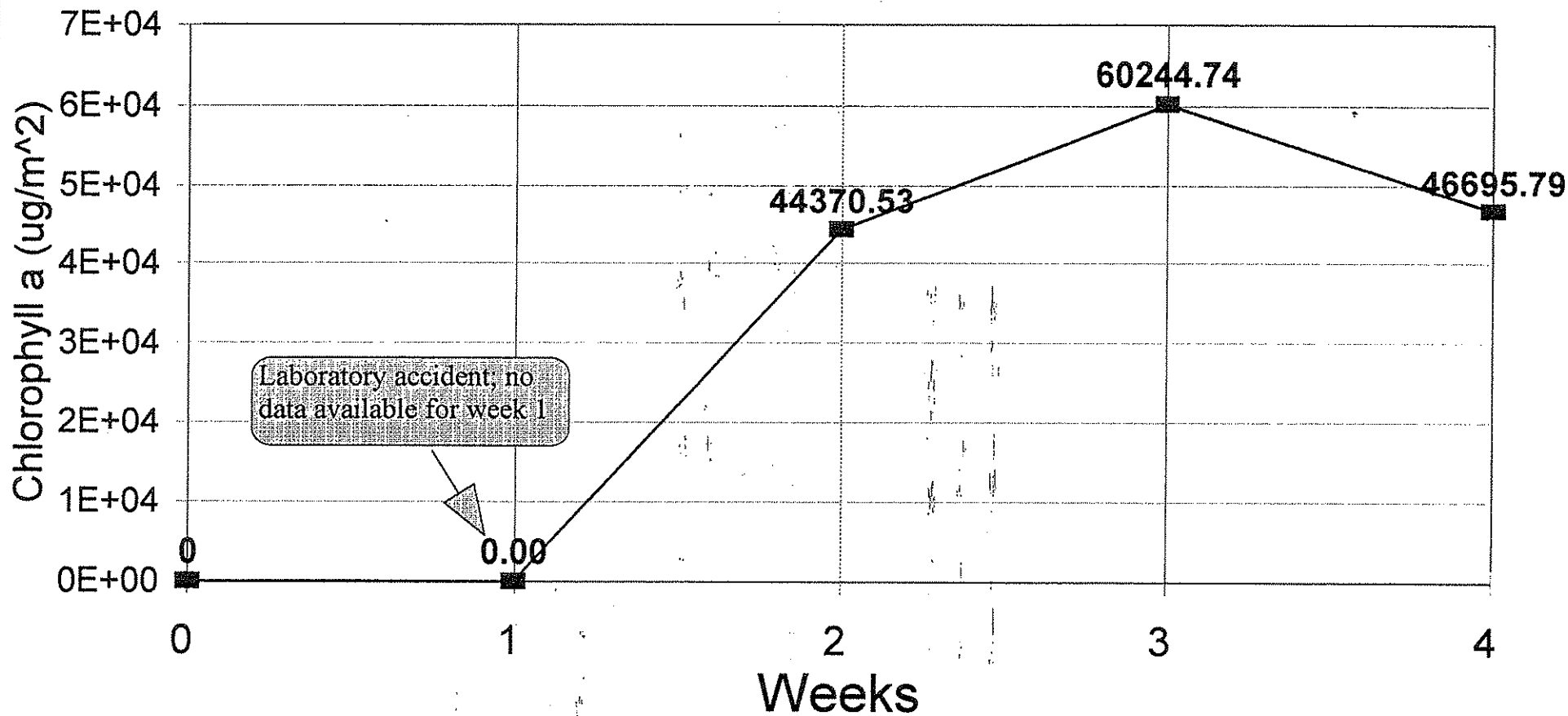

Chlorophyll a: STATION P-9

6/18/96 - 7/16/96

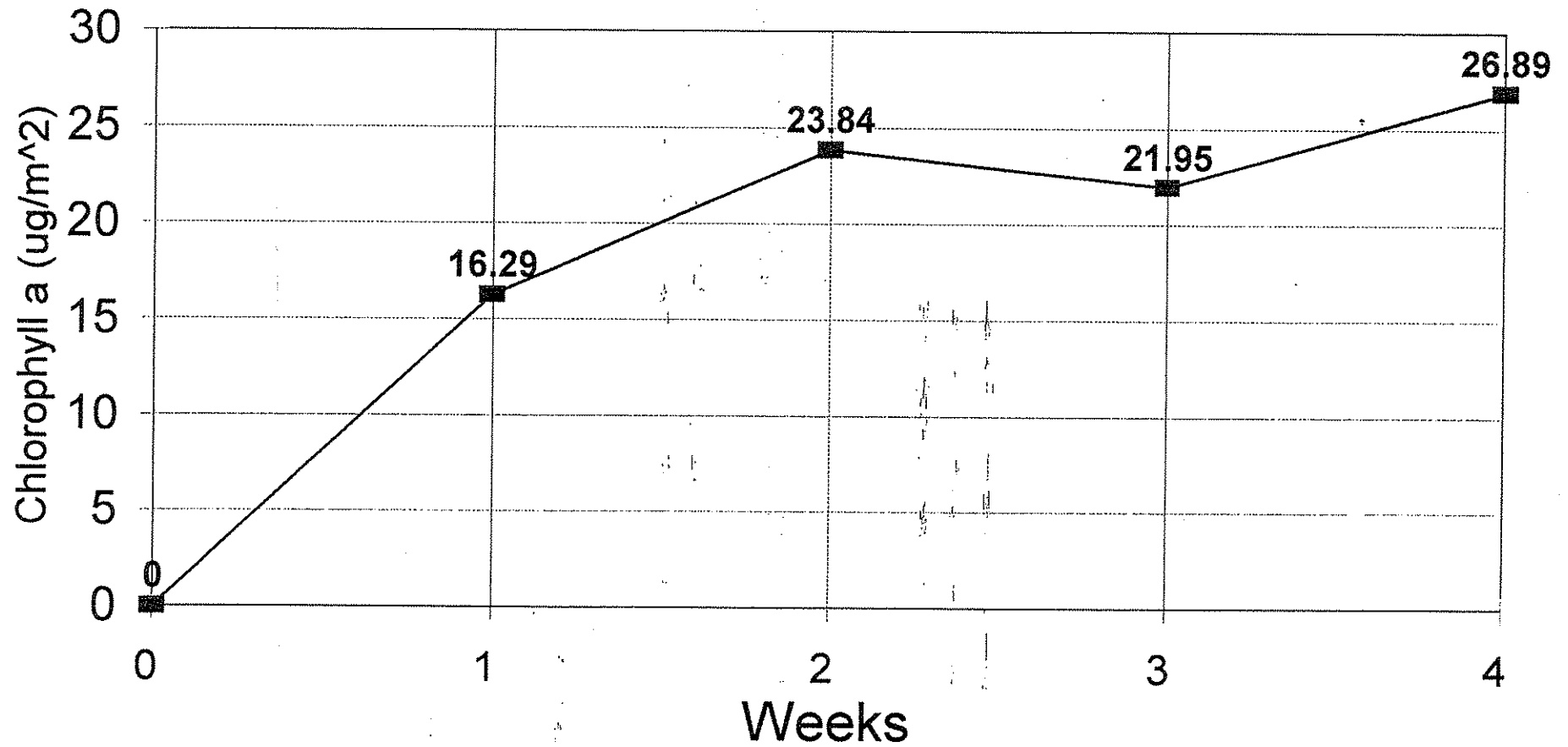

Chlorophyll a: STATION P-9

7/23/96 - 8/26/96

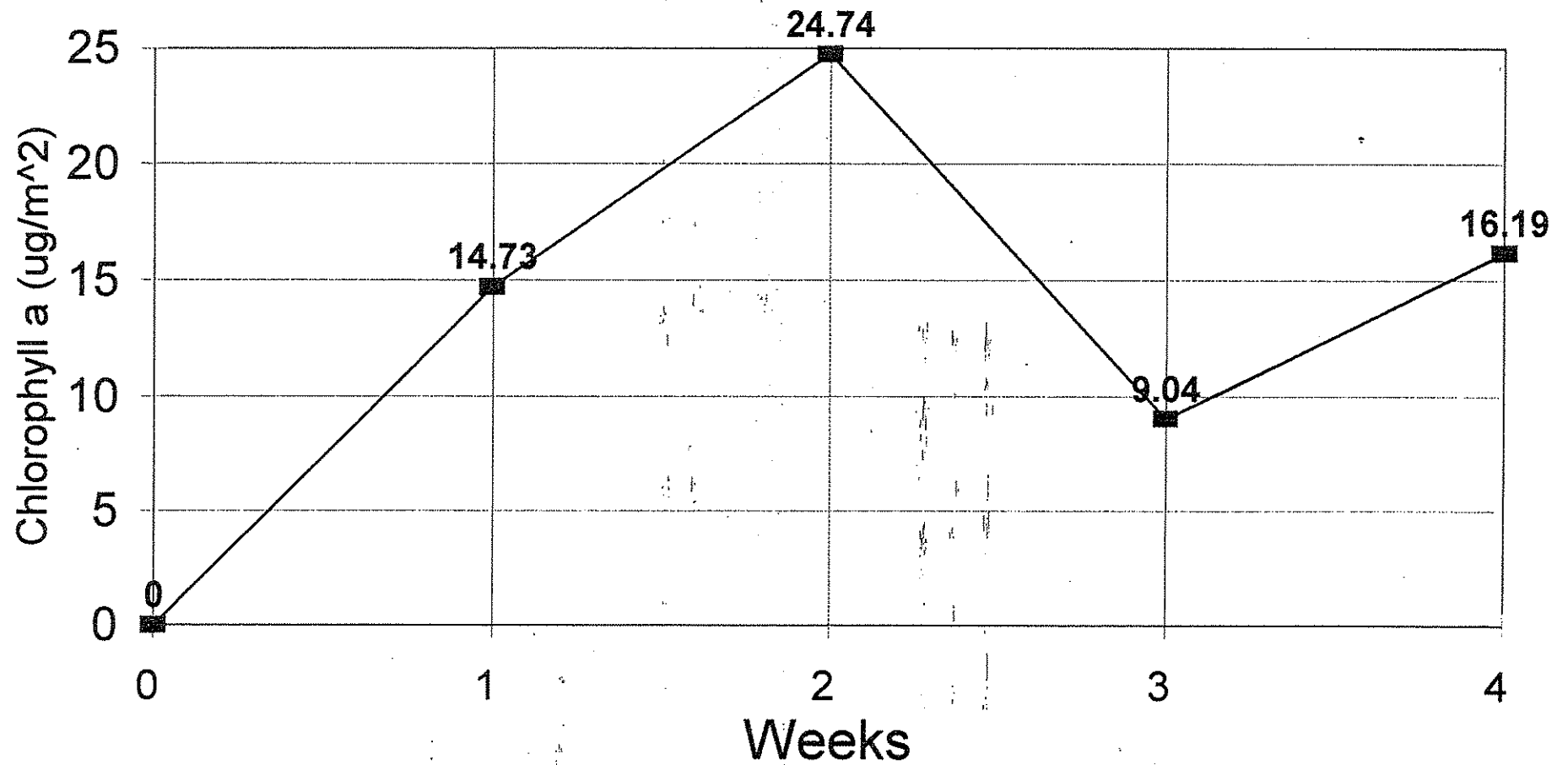

Chlorophyll a: STATION P-9

9/6/96 - 10/22/96

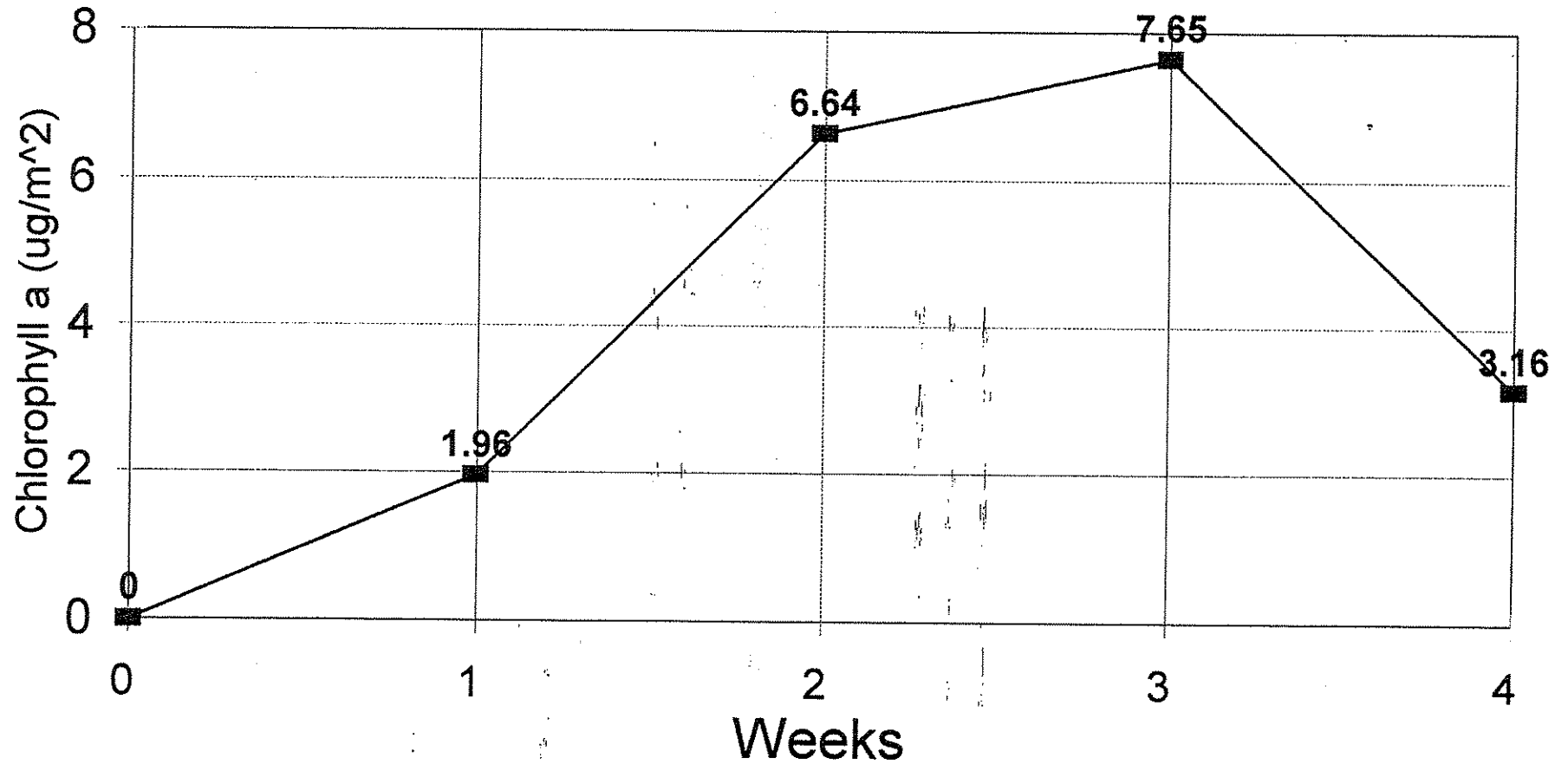

Chlorophyll a: STATION P-10

5/21/96 - 6/17/96

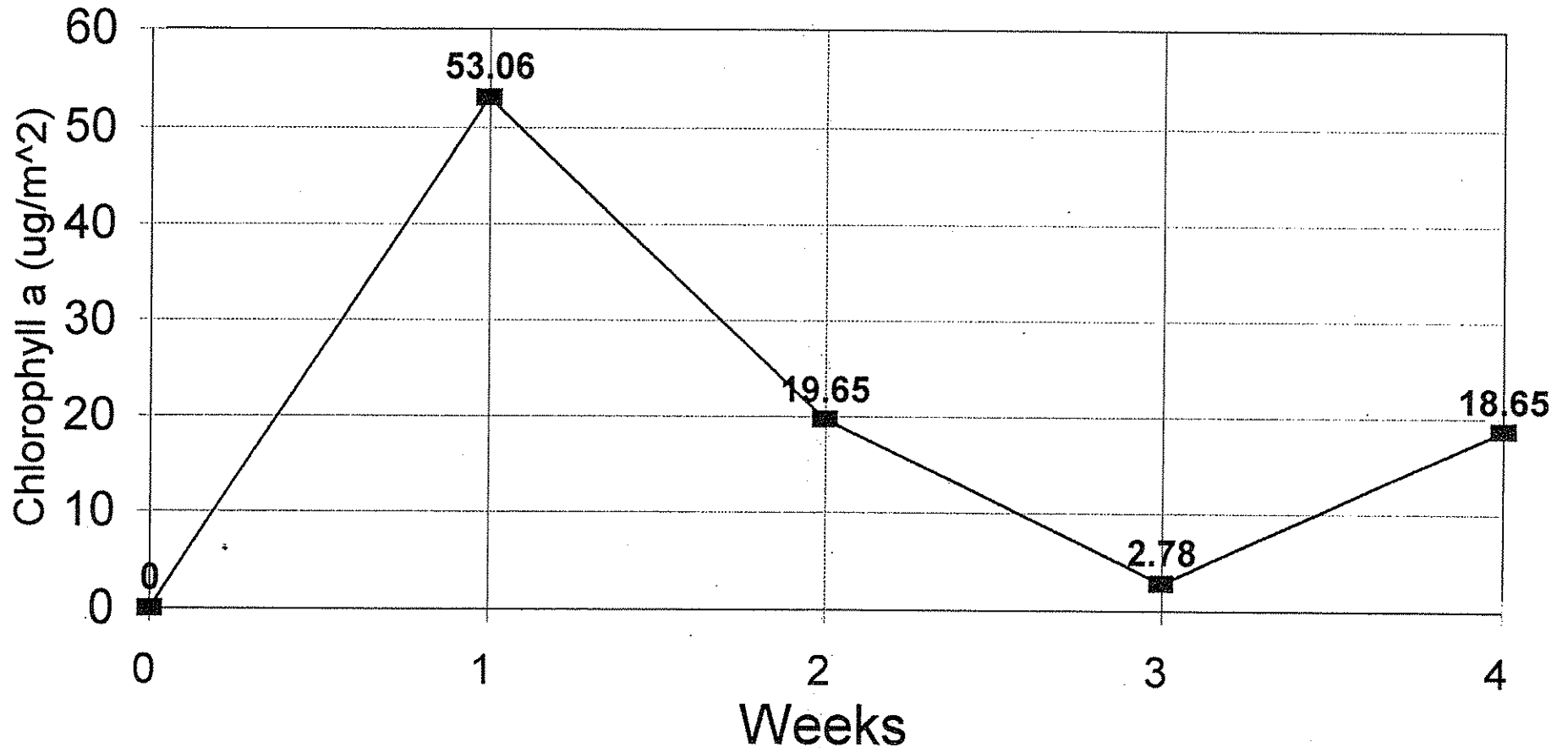

Chlorophyll a: STATION P-10

6/19/96 - 7/16/96

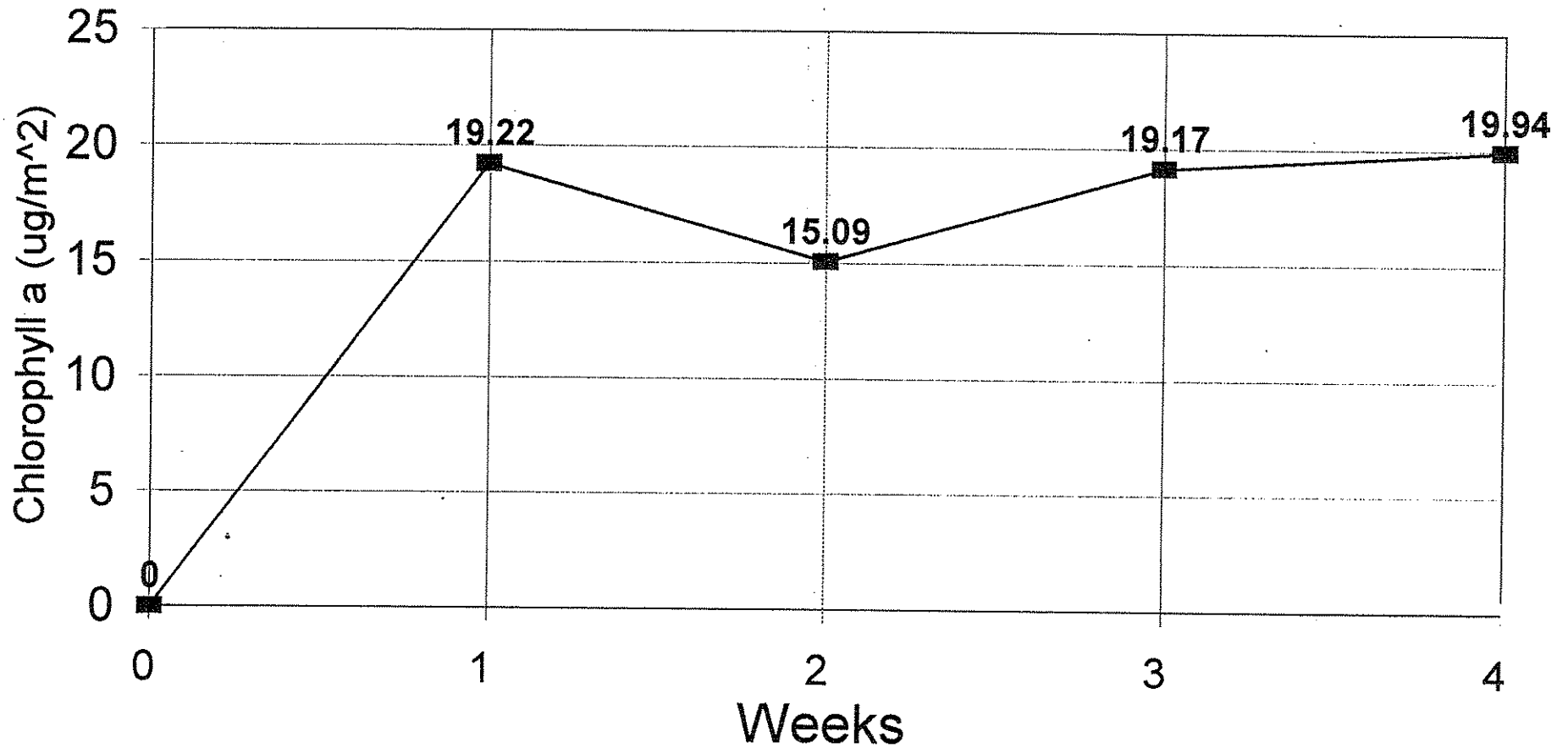

Chlorophyll a: STATION P-10

7/23/96 - 8/26/96

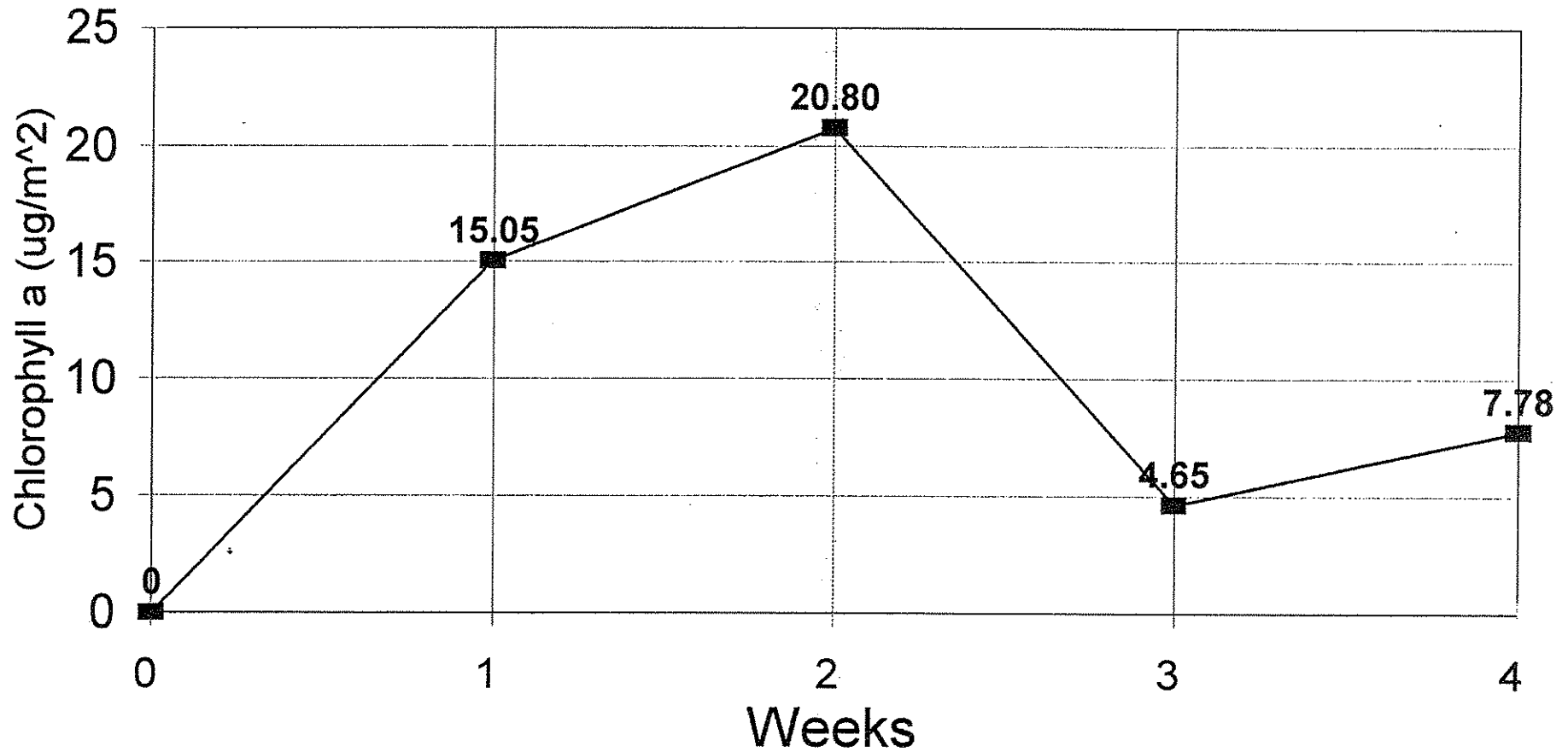

Chlorophyll a: STATION P-10

9/6/96 - 10/22/96

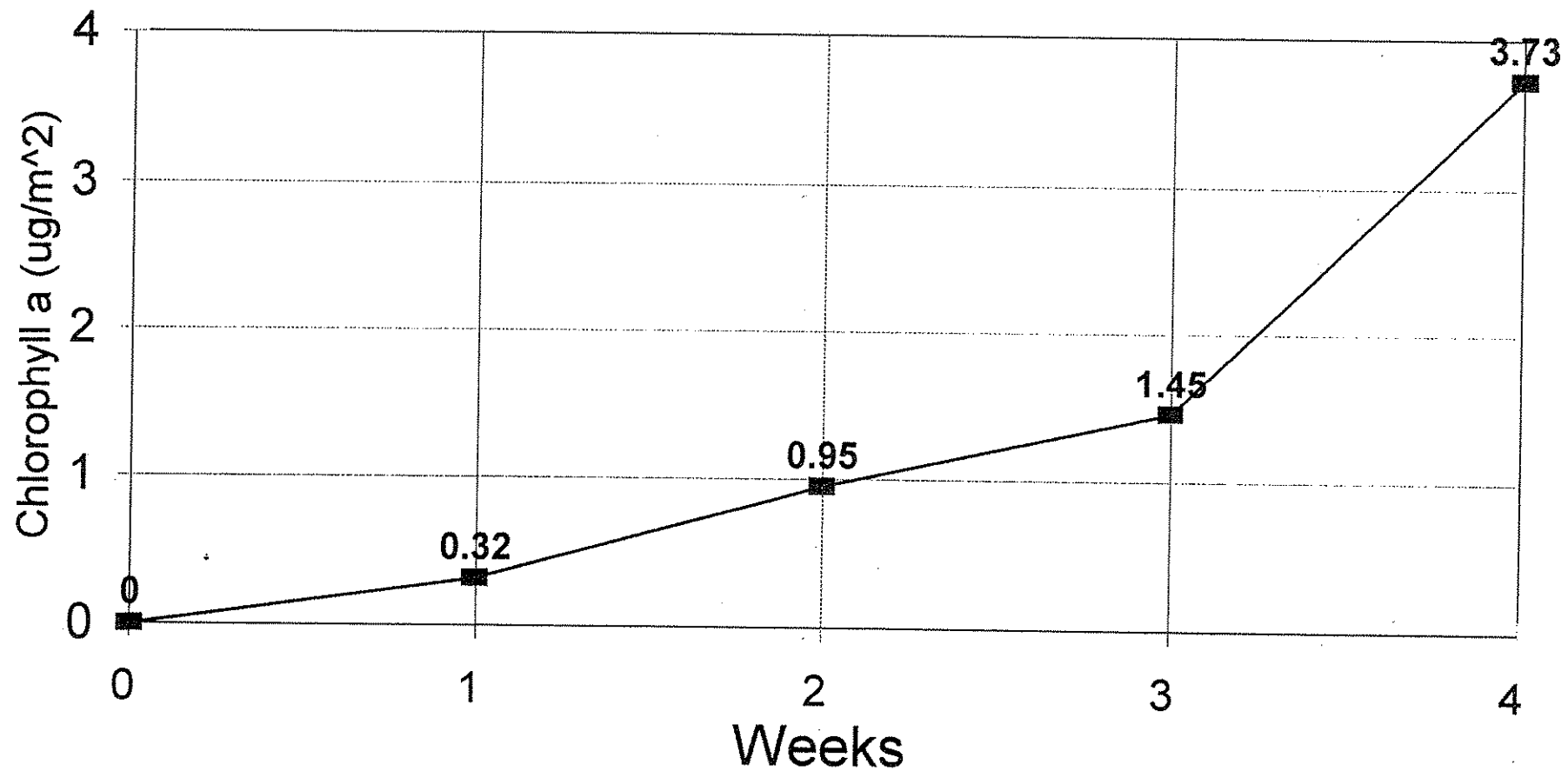

Chlorophyll a: STATION P-11

5/21/96 - 6/17/96

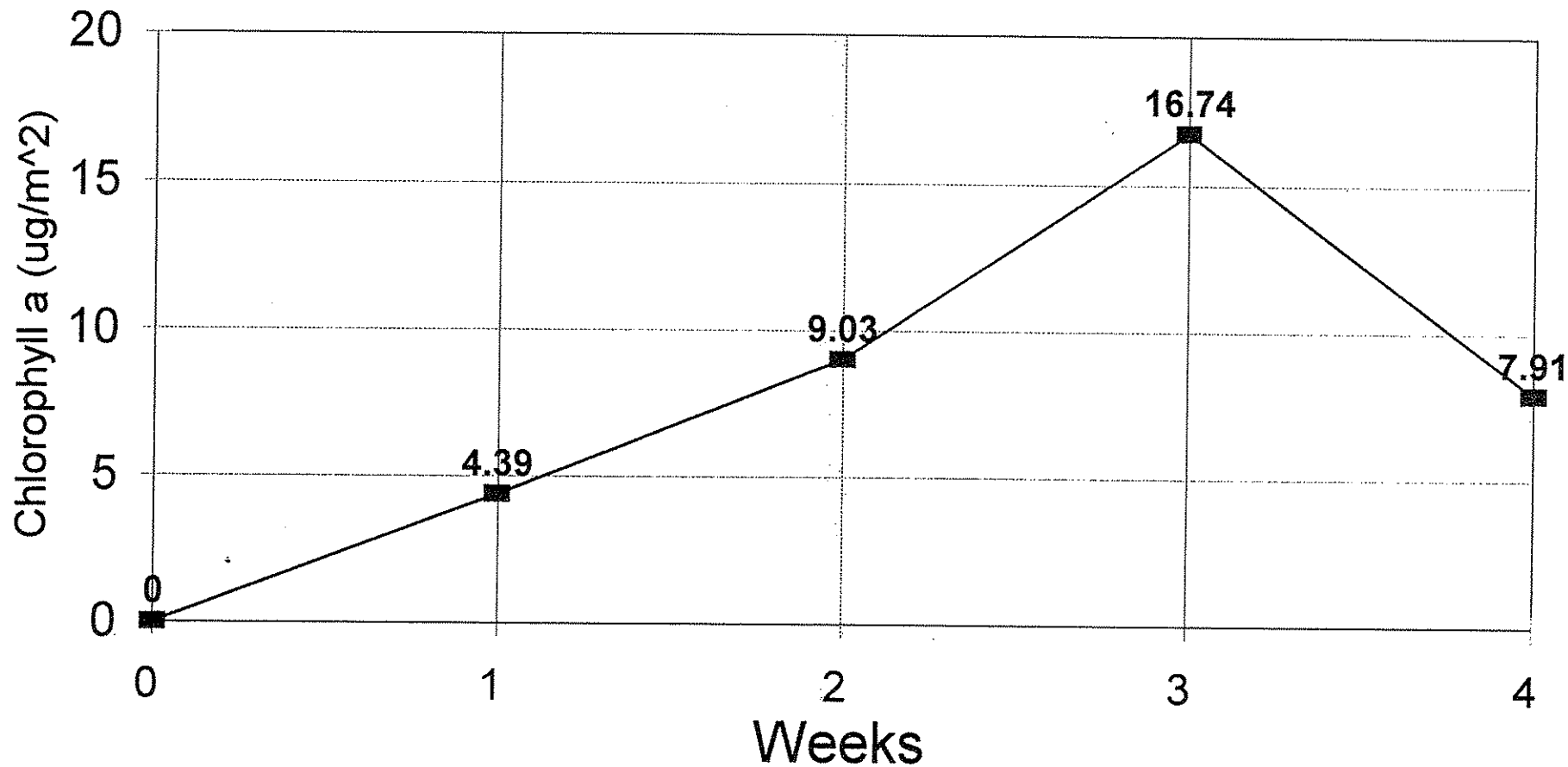

Chlorophyll a: STATION P-11

6/19/96 - 7/16/96

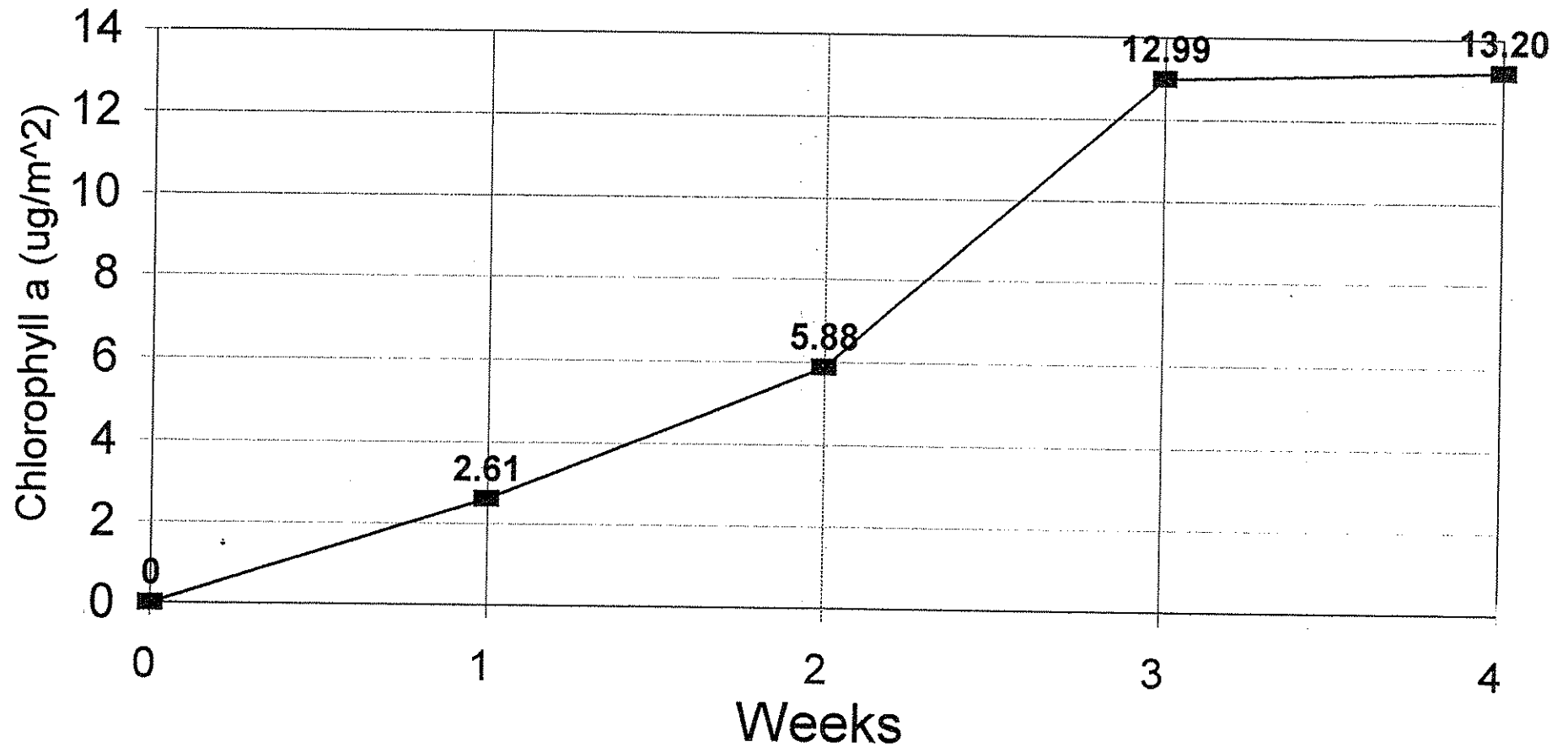

Chlorophyll a: STATION P-11

9/6/96 - 10/22/96

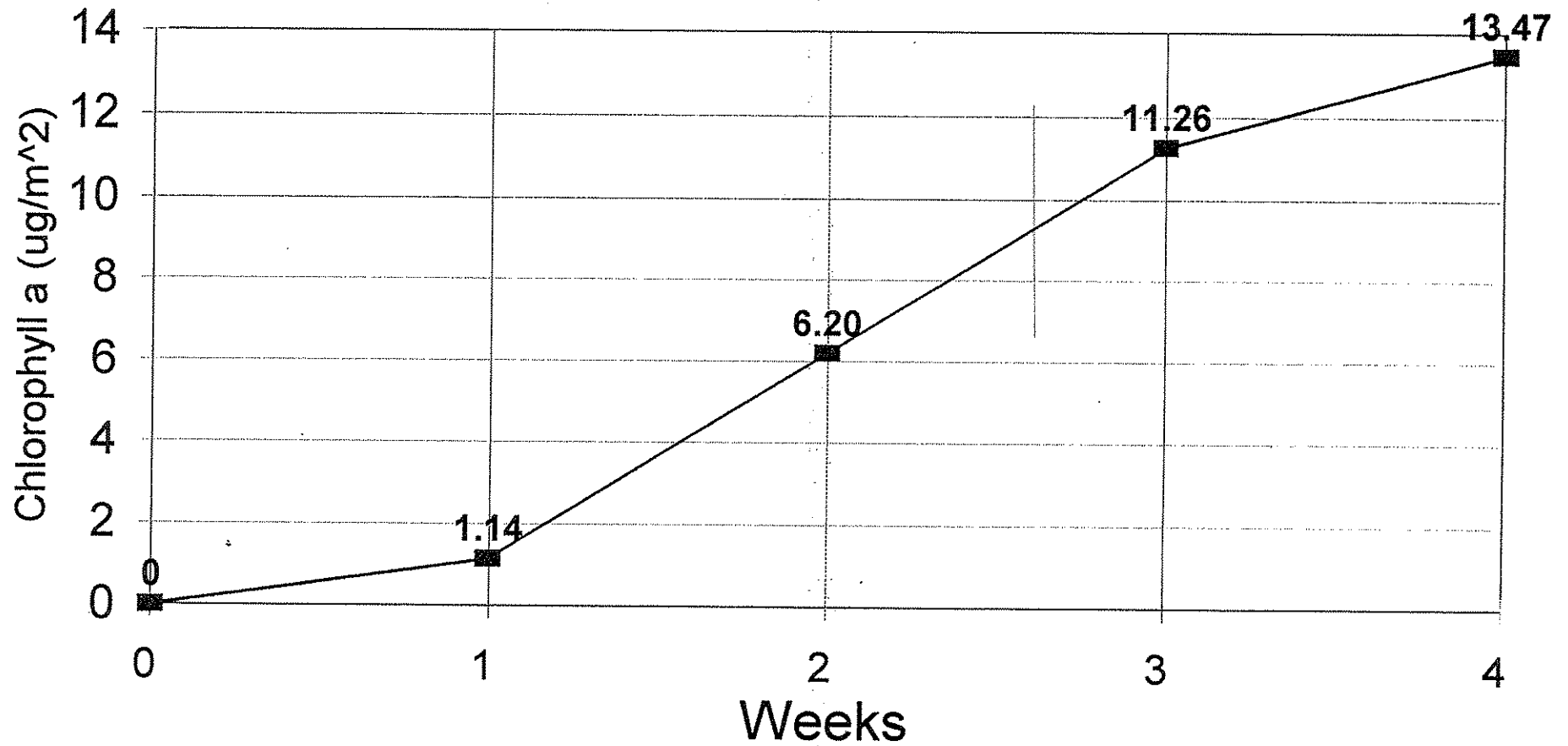

Chlorophyll a: STATION P-11

7/23/96 - 8/26/96

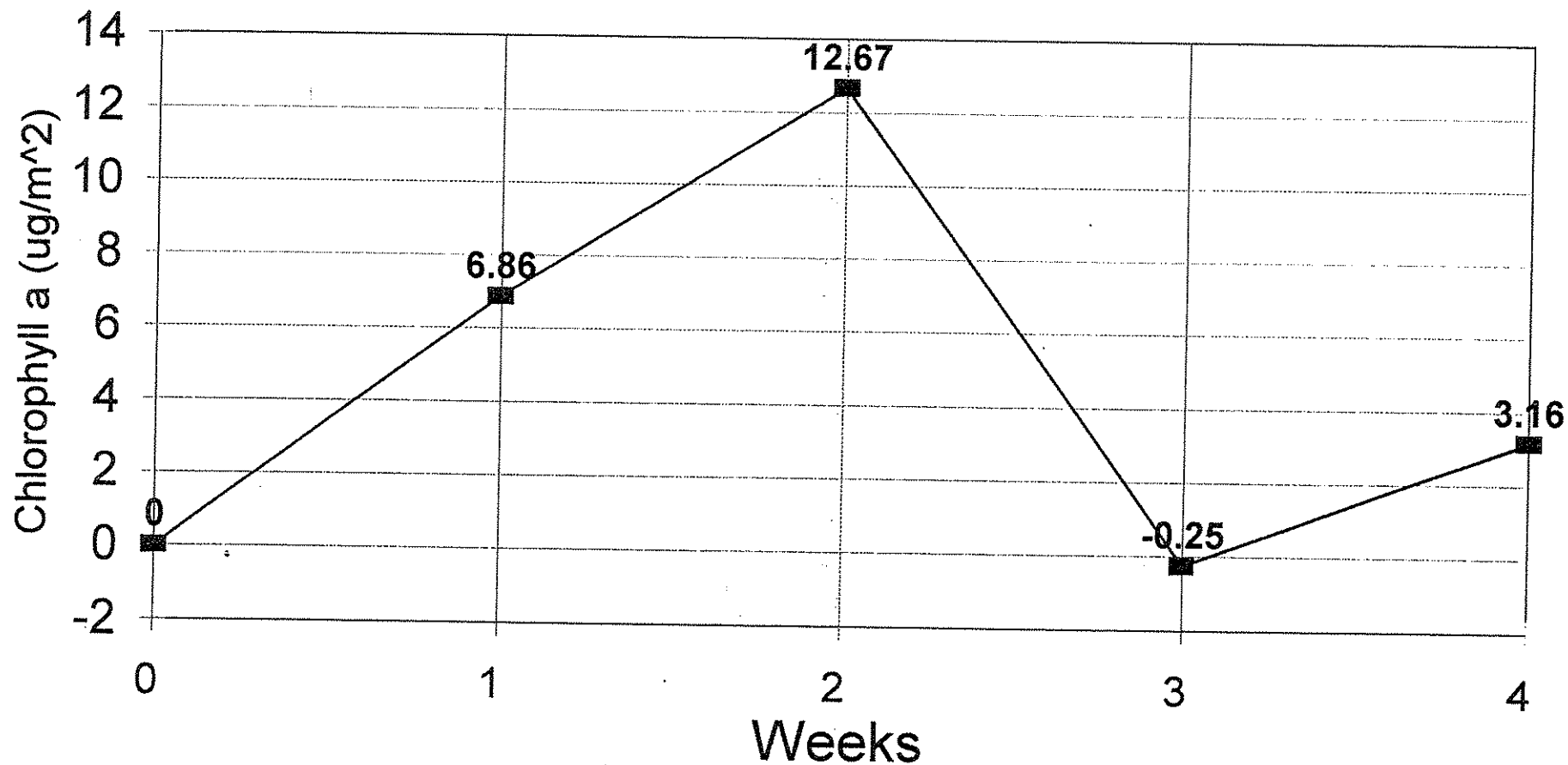

Lac Court Oreilles Periphyton Computations

Sampler Location: P-1

Week # **1** Julian Day
 Date of Installation: 06/18/96 170
 Date of Collection: 06/27/96 179
 Photoperiod 0.64

Spectrophotometer Data:
 ABS. @ 750NM 0.086
 ABS @ 664NM 0.216
 ABS @ 750NM + ACID 0.109
 ABS @ 664NM + ACID 0.186

Volume of Extract--V1 (L): 0.0094
 Vol. of water filtered -- V2 (L): 0.046
 Light Path Length--L (cm): 1

Chlorophyll a in ug: 0.01
 Number of Slides: 2
 Area of Slides in m^2: 0.0038
 Chlorophyll a in ug/m^2: 3.50

Growth rate (1/day): 0.14
 Growth corrected for photoper: 0.22

Water Temperature 19.4
 Max Water Temperature 24.1
 WTCF 0.74
 Growth corrected for Temp 0.29
 Max Growth Rate

Chl a (ug) = (26.7(664BA-665AA)*V1)/L
 Where:
 664BA = Before Acid Absorbancy at 664 NM - Before Acid Absorbancy at 750 NM
 665 AA = After Acid Absorbancy at 665 NM - After Acid Absorbancy at 750 NM
 V1 = Volume of Extract in L
 V2 = Volume of water filtered (L)
 L = Light Path Length (cm)

Lac Court Oreilles Periphyton Computations

Sampler Location: P-1

Week # **2** Julian Day
 Date of Installation: 06/18/96 170
 Date of Collection: 07/03/96 185
 Photoperiod 0.64

Spectrophotometer Data:
 ABS. @ 750NM 0.096
 ABS @ 664NM 0.223
 ABS @ 750NM + ACID 0.121
 ABS @ 664NM + ACID 0.198

Volume of Extract--V1 (L): 0.009
 Vol. of water filtered -- V2 (L): 0.05
 Light Path Length--L (cm): 1

Chlorophyll a in ug: 0.01
 Number of Slides: 2
 Area of Slides in m^2: 0.0038
 Chlorophyll a in ug/m^2: 3.16

Growth rate (1/day): -0.02
 Growth corrected for photoper: -0.03

Water Temperature
 Max Water Temperature
 WTCF 1.00
 Growth corrected for Temp -0.03

Lac Court Oreilles Periphyton Computations

Sampler Location: P-1

Week # **3** Julian Day
 Date of Installation: 06/18/96 170
 Date of Collection: 07/10/96 192
 Photoperiod 0.63

Spectrophotometer Data:
 ABS. @ 750NM 0.21
 ABS @ 664NM 0.518
 ABS @ 750NM + ACID 0.259
 ABS @ 664NM + ACID 0.466

Volume of Extract--V1 (L): 0.009
 Vol. of water filtered -- V2 (L): 0.113
 Light Path Length--L (cm): 1

Chlorophyll a in ug: 0.02
 Number of Slides: 2
 Area of Slides in m^2: 0.0038
 Chlorophyll a in ug/m^2: 6.39

Growth rate (1/day): 0.10
 Growth corrected for photoper: 0.16

Water Temperature
 Max Water Temperature
 WTCF 1.00
 Growth corrected for Temp 0.16

Lac Court Oreilles Periphyton Computations

Sampler Location: P-1

Week # **4** Julian Day
 Date of Installation: 06/18/96 170
 Date of Collection: 07/16/96 198
 Photoperiod 0.62

Spectrophotometer Data:
 ABS. @ 750NM 0.634
 ABS @ 664NM 1.11
 ABS @ 750NM + ACID 0.325
 ABS @ 664NM + ACID 0.68

Volume of Extract--V1 (L): 0.0084
 Vol. of water filtered -- V2 (L): 0.063
 Light Path Length--L (cm): 1

Chlorophyll a in ug: 0.03
 Number of Slides: 2
 Area of Slides in m^2: 0.0038
 Chlorophyll a in ug/m^2: 7.14

Growth rate (1/day): 0.02
 Growth corrected for photoper: 0.03

Water Temperature
 Max Water Temperature
 WTCF 1.00
 Growth corrected for Temp 0.03

Lac Court Oreilles Periphyton Computations

Sampler Location: P-1

Week # 1 Julian Day
 Date of Installation: 07/23/96 205
 Date of Collection: 08/02/96 215
 Photoperiod 0.58

Spectrophotometer Data:
 ABS. @ 750NM 0.334
 ABS @ 664NM 0.546
 ABS @ 750NM + ACID 0.129
 ABS @ 664NM + ACID 0.208

Volume of Extract--V1 (L): 0.0095
 Vol. of water filtered -- V2 (L): 0.057
 Light Path Length--L (cm): 1

Chlorophyll a in ug: 0.03
 Number of Slides: 2
 Area of Slides in m^2: 0.0038
 Chlorophyll a in ug/m^2: 8.88

Growth rate (1/day): 0.22
 Growth corrected for photoper: 0.38

Water Temperature 22
 Max Water Temperature 24.1
 WTCF 0.87
 Growth corrected for Temp 0.43
 Max Growth Rate

Chl a (ug) = (26.7(664BA-665AA)*V1)/L
 Where:
 664BA = Before Acid Absorbancy at 664 NM - Before Acid Absorbancy at 750 NM
 665 AA = After Acid Absorbancy at 665 NM - After Acid Absorbancy at 750 NM
 V1 = Volume of Extract in L
 V2 = Volume of water filtered (L)
 L = Light Path Length (cm)

Lac Court Oreilles Periphyton Computations

Sampler Location: P-1

Week # 2 Julian Day
 Date of Installation: 07/23/96 205
 Date of Collection: 08/09/96 222
 Photoperiod 0.55

Spectrophotometer Data:
 ABS. @ 750NM 0.995
 ABS @ 664NM 1.36
 ABS @ 750NM + ACID 0.584
 ABS @ 664NM + ACID 0.88

Volume of Extract--V1 (L): 0.0092
 Vol. of water filtered -- V2 (L): 0.048
 Light Path Length--L (cm): 1

Chlorophyll a in ug: 0.02
 Number of Slides: 1
 Area of Slides in m^2: 0.0019
 Chlorophyll a in ug/m^2: 8.92

Growth rate (1/day): 0.00
 Growth corrected for photoper: 0.00

Water Temperature
 Max Water Temperature
 WTCF 1.00
 Growth corrected for Temp 0.00

Lac Court Oreilles Periphyton Computations

Sampler Location: P-1

Week # 3 Julian Day
 Date of Installation: 07/23/96 205
 Date of Collection: 08/16/96 229
 Photoperiod 0.53

Spectrophotometer Data:
 ABS. @ 750NM
 ABS @ 664NM
 ABS @ 750NM + ACID
 ABS @ 664NM + ACID

Volume of Extract--V1 (L):
 Vol. of water filtered -- V2 (L):
 Light Path Length--L (cm): 1

Chlorophyll a in ug: 0.00
 Number of Slides:
 Area of Slides in m^2: 0
 Chlorophyll a in ug/m^2: ERR

Growth rate (1/day): ERR
 Growth corrected for photoper: ERR

Water Temperature
 Max Water Temperature
 WTCF ERR
 Growth corrected for Temp ERR

Lac Court Oreilles Periphyton Computations

Sampler Location: P-1

Week # 4 Julian Day
 Date of Installation: 07/23/96 205
 Date of Collection: 08/26/96 239
 Photoperiod 0.50

Spectrophotometer Data:
 ABS. @ 750NM
 ABS @ 664NM
 ABS @ 750NM + ACID
 ABS @ 664NM + ACID

Volume of Extract--V1 (L):
 Vol. of water filtered -- V2 (L):
 Light Path Length--L (cm): 1

Chlorophyll a in ug: 0.00
 Number of Slides:
 Area of Slides in m^2: 0
 Chlorophyll a in ug/m^2: ERR

Growth rate (1/day): ERR
 Growth corrected for photoper: ERR

Water Temperature
 Max Water Temperature
 WTCF ERR
 Growth corrected for Temp ERR

**Slides lost due to extreme weather condtions
 No data available**

Lac Court Oreilles Periphyton Computations

Sampler Location: P-1
 Week # 1 Julian Day
 Date of Installation: 09/06/96 250
 Date of Collection: 09/16/96 260
 Photoperiod 0.40

Spectrophotometer Data:
 ABS. @ 750NM 0.023
 ABS @ 664NM 0.097
 ABS @ 750NM + ACID 0.079
 ABS @ 664NM + ACID 0.142

Volume of Extract--V1 (L): 0.009
 Vol. of water filtered -- V2 (L): 0.023
 Light Path Length--L (cm): 1

Chlorophyll a in ug: 2.64E-03
 Number of Slides: 2
 Area of Slides in m^2: 0.0038
 Chlorophyll a in ug/m^2: 0.70

Growth rate (1/day): -0.04
 Growth corrected for photoper: -0.09

Water Temperature
 Max Water Temperature
 WTCF 1.00
 Growth corrected for Temp -0.09

Chl a (ug) = (26.7(664BA-665AA)*V1)/L
 Where:
 664BA = Before Acid Absorbancy at 664 NM - Before Acid Absorbancy at 750 NM
 665 AA = After Acid Absorbancy at 665 NM - After Acid Absorbancy at 750 NM
 V1 = Volume of Extract in L
 V2 = Volume of water filtered (L)
 L = Light Path Length (cm)

Lac Court Oreilles Periphyton Computations

Sampler Location: P-1
 Week # 2 Julian Day
 Date of Installation: 09/06/96 250
 Date of Collection: 09/24/96 268
 Photoperiod 0.36

Spectrophotometer Data:
 ABS. @ 750NM 0.042
 ABS @ 664NM 0.345
 ABS @ 750NM + ACID 0.067
 ABS @ 664NM + ACID 0.283

Volume of Extract--V1 (L): 0.009
 Vol. of water filtered -- V2 (L): 0.028
 Light Path Length--L (cm): 1

Chlorophyll a in ug: 2.09E-02
 Number of Slides: 2
 Area of Slides in m^2: 0.0038
 Chlorophyll a in ug/m^2: 5.50

Growth rate (1/day): 0.26
 Growth corrected for photoper: 0.73

Water Temperature 18.6
 Max Water Temperature 24.1
 WTCF 0.70
 Growth corrected for Temp 1.03
 Max Growth Rate

Lac Court Oreilles Periphyton Computations

Sampler Location: P-1
 Week # 3 Julian Day
 Date of Installation: 09/06/96 250
 Date of Collection: 10/08/96 282
 Photoperiod 0.30

Spectrophotometer Data:
 ABS. @ 750NM 0.018
 ABS @ 664NM 0.762
 ABS @ 750NM + ACID 0.024
 ABS @ 664NM + ACID 0.584

Volume of Extract--V1 (L): 0.009
 Vol. of water filtered -- V2 (L): 0.04
 Light Path Length--L (cm): 1

Chlorophyll a in ug: 4.42E-02
 Number of Slides: 2
 Area of Slides in m^2: 0.0038
 Chlorophyll a in ug/m^2: 11.64

Growth rate (1/day): 0.05
 Growth corrected for photoper: 0.18

Water Temperature 13.5
 Max Water Temperature 23.4
 WTCF 0.53
 Growth corrected for Temp 0.33

Lac Court Oreilles Periphyton Computations

Sampler Location: P-1
 Week # 4 Julian Day
 Date of Installation: 09/06/96 250
 Date of Collection: 10/22/96 296
 Photoperiod 0.24

Spectrophotometer Data:
 ABS. @ 750NM 0.025
 ABS @ 664NM 0.81
 ABS @ 750NM + ACID 0.11
 ABS @ 664NM + ACID 0.72

Volume of Extract--V1 (L): 0.009
 Vol. of water filtered -- V2 (L): 0.045
 Light Path Length--L (cm): 1

Chlorophyll a in ug: 4.21E-02
 Number of Slides: 2
 Area of Slides in m^2: 0.0038
 Chlorophyll a in ug/m^2: 11.07

Growth rate (1/day): -0.00
 Growth corrected for photoper: -0.01

Water Temperature
 Max Water Temperature
 WTCF 1.00
 Growth corrected for Temp -0.01

Lac Court Oreilles Periphyton Computations

Sampler Location: P-2

Week #	1	Julian Day
Date of Installation:	05/21/96	142
Date of Collection:	05/28/96	149
Photoperiod	0.61	
Vol. of water filtered -- V2 (L):	0.096	
Chlorophyll a in ug/L:	43.8	
Chlorophyll a in ug:	4.20	
Number of Slides:	2	
Area of Slides in m ² :	0.0038	
Chlorophyll a in ug/m ² :	1106.53	
Growth rate (1/day):	1.00	
Growth corrected for photoper:	1.64	
Water Temperature		
Max Water Temperature		
WTCF	1.00	
Growth corrected for Temp	1.64	

Lac Court Oreilles Periphyton Computations

Sampler Location: P-2

Week #	2	Julian Day
Date of Installation:	05/21/96	142
Date of Collection:	06/03/96	155
Photoperiod	0.62	
Vol. of water filtered -- V2 (L):	0.138	
Chlorophyll a in ug/L:	1740	
Chlorophyll a in ug:	240.12	
Number of Slides:	2	
Area of Slides in m ² :	0.0038	
Chlorophyll a in ug/m ² :	63189.47	
Growth rate (1/day):	0.67	
Growth corrected for photoper:	1.08	
Water Temperature	14.1	
Max Water Temperature	24.1	
WTCF	0.53	
Growth corrected for Temp	2.05	
Max Growth Rate		

Lac Court Oreilles Periphyton Computations

Sampler Location: P-2

Week #	3	Julian Day
Date of Installation:	05/21/96	142
Date of Collection:	06/10/96	162
Photoperiod	0.63	
Vol. of water filtered -- V2 (L):	0.156	
Chlorophyll a in ug/L:	571	
Chlorophyll a in ug:	89.08	
Number of Slides:	2	
Area of Slides in m ² :	0.0038	
Chlorophyll a in ug/m ² :	23441.05	
Growth rate (1/day):	-0.14	
Growth corrected for photoper:	-0.22	
Water Temperature		
Max Water Temperature		
WTCF	1.00	
Growth corrected for Temp	-0.22	

Lac Court Oreilles Periphyton Computations

Sampler Location: P-2

Week #	4	Julian Day
Date of Installation:	05/21/96	142
Date of Collection:	06/17/96	169
Photoperiod	0.64	
Vol. of water filtered -- V2 (L):	0.072	
Chlorophyll a in ug/L:	1181	
Chlorophyll a in ug:	85.03	
Number of Slides:	2	
Area of Slides in m ² :	0.0038	
Chlorophyll a in ug/m ² :	22376.84	
Growth rate (1/day):	-0.01	
Growth corrected for photoper:	-0.01	
Water Temperature		
Max Water Temperature		
WTCF	1.00	
Growth corrected for Temp	-0.01	

Lac Court Oreilles Periphyton Computations

Sampler Location: P-2
Week # 1 **Julian Day**
 Date of Installation: 06/18/96 170
 Date of Collection: 06/27/96 179
 Photoperiod 0.64
Spectrophotometer Data:
 ABS. @ 750NM 0.095
 ABS @ 664NM 0.231
 ABS @ 750NM + ACID 0.132
 ABS @ 664NM + ACID 0.193
 Volume of Extract--V1 (L): 0.0095
 Vol. of water filtered -- V2 (L): 0.047
 Light Path Length--L (cm): 1
 Chlorophyll a in ug: 1.9E-02
 Number of Slides: 2
 Area of Slides in m^2: 0.0038
 Chlorophyll a in ug/m^2: 5.01
 Growth rate (1/day): 0.18
 Growth corrected for photoper: 0.28
 Water Temperature
 Max Water Temperature
 WTCF 1.00
 Growth corrected for Temp 0.28

Lac Court Oreilles Periphyton Computations

Sampler Location: P-2
Week # 2 **Julian Day**
 Date of Installation: 06/18/96 170
 Date of Collection: 07/03/96 185
 Photoperiod 0.64
Spectrophotometer Data:
 ABS. @ 750NM 0.592
 ABS @ 664NM 1.23
 ABS @ 750NM + ACID 0.79
 ABS @ 664NM + ACID 1.095
 Volume of Extract--V1 (L): 0.0092
 Vol. of water filtered -- V2 (L): 0.032
 Light Path Length--L (cm): 1
 Chlorophyll a in ug: 8.2E-02
 Number of Slides: 2
 Area of Slides in m^2: 0.0038
 Chlorophyll a in ug/m^2: 21.53
 Growth rate (1/day): 0.24
 Growth corrected for photoper: 0.38
 Water Temperature 19.8
 Max Water Temperature 24.1
 WTCF 0.76
 Growth corrected for Temp 0.50

Lac Court Oreilles Periphyton Computations

Sampler Location: P-2
Week # 3 **Julian Day**
 Date of Installation: 06/18/96 170
 Date of Collection: 07/10/96 192
 Photoperiod 0.63
Spectrophotometer Data:
 ABS. @ 750NM 1.95
 ABS @ 664NM 1.999
 ABS @ 750NM + ACID 1.9
 ABS @ 664NM + ACID 1.999
 Volume of Extract--V1 (L): 0.0087
 Vol. of water filtered -- V2 (L): 0.063
 Light Path Length--L (cm): 1
 Chlorophyll a in ug: -1.2E-02
 Number of Slides: 2
 Area of Slides in m^2: 0.0038
 Chlorophyll a in ug/m^2: -3.06
 Growth rate (1/day): ERR
 Growth corrected for photoper: ERR
 Water Temperature
 Max Water Temperature
 WTCF ERR
 Growth corrected for Temp ERR

Lac Court Oreilles Periphyton Computations

Sampler Location: P-2
Week # 4 **Julian Day**
 Date of Installation: 06/18/96 170
 Date of Collection: 07/16/96 198
 Photoperiod 0.62
Spectrophotometer Data:
 ABS. @ 750NM 1.999
 ABS @ 664NM 1.999
 ABS @ 750NM + ACID 1.999
 ABS @ 664NM + ACID 1.95
 Volume of Extract--V1 (L): 0.0087
 Vol. of water filtered -- V2 (L): 0.063
 Light Path Length--L (cm): 1
 Chlorophyll a in ug: 1.1E-02
 Number of Slides: 2
 Area of Slides in m^2: 0.0038
 Chlorophyll a in ug/m^2: 3.00
 Growth rate (1/day): ERR
 Growth corrected for photoper: ERR
 Water Temperature
 Max Water Temperature
 WTCF ERR
 Growth corrected for Temp ERR

Lac Court Oreilles Periphyton Computations

Sampler Location: P-2
 Week # 1 Julian Day
 Date of Installation: 07/23/96 205
 Date of Collection: 08/02/96 215
 Photoperiod 0.58

Spectrophotometer Data:
 ABS. @ 750NM 0.594
 ABS @ 664NM 1.16
 ABS @ 750NM + ACID 0.492
 ABS @ 664NM + ACID 0.734

Volume of Extract--V1 (L): 0.0088
 Vol. of water filtered -- V2 (L): 0.086
 Light Path Length--L (cm): 1

Chlorophyll a in ug: 7.6E-02
 Number of Slides: 2
 Area of Slides in m^2: 0.0038
 Chlorophyll a in ug/m^2: 20.03

Growth rate (1/day): 0.30
 Growth corrected for photoper: 0.51

Water Temperature 22
 Max Water Temperature 24.1
 WTCF 0.87
 Growth corrected for Temp 0.59

Chl a (ug) = (26.7(664BA-665AA)*V1)/L
 Where:
 664BA = Before Acid Absorbancy at 664 NM - Before Acid Absorbancy at 750 NM
 665 AA = After Acid Absorbancy at 665 NM - After Acid Absorbancy at 750 NM
 V1 = Volume of Extract in L
 V2 = Volume of water filtered (L)
 L = Light Path Length (cm)

Lac Court Oreilles Periphyton Computations

Sampler Location: P-2
 Week # 2 Julian Day
 Date of Installation: 07/23/96 205
 Date of Collection: 08/09/96 222
 Photoperiod 0.55

Spectrophotometer Data:
 ABS. @ 750NM 0.855
 ABS @ 664NM 1.62
 ABS @ 750NM + ACID 0.825
 ABS @ 664NM + ACID 1.26

Volume of Extract--V1 (L): 0.0084
 Vol. of water filtered -- V2 (L): 0.09
 Light Path Length--L (cm): 1

Chlorophyll a in ug: 7.4E-02
 Number of Slides: 2
 Area of Slides in m^2: 0.0038
 Chlorophyll a in ug/m^2: 19.48

Growth rate (1/day): -0.00
 Growth corrected for photoper: -0.01

Water Temperature
 Max Water Temperature
 WTCF 1.00
 Growth corrected for Temp -0.01

Lac Court Oreilles Periphyton Computations

Sampler Location: P-2
 Week # 3 Julian Day
 Date of Installation: 07/23/96 205
 Date of Collection: 08/16/96 229
 Photoperiod 0.53

Spectrophotometer Data:
 ABS. @ 750NM 0.028
 ABS @ 664NM 0.598
 ABS @ 750NM + ACID 0.08
 ABS @ 664NM + ACID 0.53

Volume of Extract--V1 (L): 0.0072
 Vol. of water filtered -- V2 (L): 0.06
 Light Path Length--L (cm): 1

Chlorophyll a in ug: 2.3E-02
 Number of Slides: 1
 Area of Slides in m^2: 0.0019
 Chlorophyll a in ug/m^2: 12.14

Growth rate (1/day): -0.07
 Growth corrected for photoper: -0.13

Water Temperature
 Max Water Temperature
 WTCF 1.00
 Growth corrected for Temp -0.13

Lac Court Oreilles Periphyton Computations

Sampler Location: P-2
 Week # 4 Julian Day
 Date of Installation: 07/23/96 205
 Date of Collection: 08/26/96 239
 Photoperiod 0.50

Spectrophotometer Data:
 ABS. @ 750NM 0.038
 ABS @ 664NM 1.999
 ABS @ 750NM + ACID 0.082
 ABS @ 664NM + ACID 1.74

Volume of Extract--V1 (L): 0.008
 Vol. of water filtered -- V2 (L): 0.045
 Light Path Length--L (cm): 1

Chlorophyll a in ug: 6.5E-02
 Number of Slides: 1
 Area of Slides in m^2: 0.0019
 Chlorophyll a in ug/m^2: 34.06

Growth rate (1/day): 0.10
 Growth corrected for photoper: 0.21

Water Temperature 23
 Max Water Temperature 23.1
 WTCF 0.99
 Growth corrected for Temp 0.21

Lac Court Oreilles Periphyton Computations

Sampler Location: P-2

Week # 1 Julian Day
 Date of Installation: 09/06/96 250
 Date of Collection: 09/16/96 260
 Photoperiod 0.40

Spectrophotometer Data:
 ABS. @ 750NM 0.038
 ABS @ 664NM 0.275
 ABS @ 750NM + ACID 0.161
 ABS @ 664NM + ACID 0.34

Volume of Extract--V1 (L): 0.009
 Vol. of water filtered -- V2 (L): 0.035
 Light Path Length--L (cm): 1

Chlorophyll a in ug: 1.4E-02
 Number of Slides: 2
 Area of Slides in m^2: 0.0038
 Chlorophyll a in ug/m^2: 3.67

Growth rate (1/day): 0.13
 Growth corrected for photoper: 0.33

Water Temperature
 Max Water Temperature
 WTCF 1.00
 Growth corrected for Temp 0.33

Chl a (ug) = (26.7(664BA-665AA)*V1)/L
 Where:
 664BA = Before Acid Absorbancy at 664 NM - Before Acid Absorbancy at 750 NM
 665 AA = After Acid Absorbancy at 665 NM - After Acid Absorbancy at 750 NM
 V1 = Volume of Extract in L
 V2 = Volume of water filtered (L)
 L = Light Path Length (cm)

Lac Court Oreilles Periphyton Computations

Sampler Location: P-2

Week # 2 Julian Day
 Date of Installation: 09/06/96 250
 Date of Collection: 09/24/96 268
 Photoperiod 0.36

Spectrophotometer Data:
 ABS. @ 750NM 0.069
 ABS @ 664NM 0.406
 ABS @ 750NM + ACID 0.116
 ABS @ 664NM + ACID 0.369

Volume of Extract--V1 (L): 0.009
 Vol. of water filtered -- V2 (L): 0.037
 Light Path Length--L (cm): 1

Chlorophyll a in ug: 2.0E-02
 Number of Slides: 2
 Area of Slides in m^2: 0.0038
 Chlorophyll a in ug/m^2: 5.31

Growth rate (1/day): 0.05
 Growth corrected for photoper: 0.13

Water Temperature
 Max Water Temperature
 WTCF 1.00
 Growth corrected for Temp 0.13

Lac Court Oreilles Periphyton Computations

Sampler Location: P-2

Week # 3 Julian Day
 Date of Installation: 09/06/96 250
 Date of Collection: 10/08/96 282
 Photoperiod 0.30

Spectrophotometer Data:
 ABS. @ 750NM 0.02
 ABS @ 664NM 1.4
 ABS @ 750NM + ACID 0.03
 ABS @ 664NM + ACID 1.09

Volume of Extract--V1 (L): 0.009
 Vol. of water filtered -- V2 (L): 0.041
 Light Path Length--L (cm): 1

Chlorophyll a in ug: 7.7E-02
 Number of Slides: 2
 Area of Slides in m^2: 0.0038
 Chlorophyll a in ug/m^2: 20.24

Growth rate (1/day): 0.10
 Growth corrected for photoper: 0.31

Water Temperature
 Max Water Temperature
 WTCF 0.48
 Growth corrected for Temp 0.66

Lac Court Oreilles Periphyton Computations

Sampler Location: P-2

Week # 4 Julian Day
 Date of Installation: 09/06/96 250
 Date of Collection: 10/22/96 296
 Photoperiod 0.24

Spectrophotometer Data:
 ABS. @ 750NM 0.071
 ABS @ 664NM 1.6
 ABS @ 750NM + ACID 0.172
 ABS @ 664NM + ACID 1.42

Volume of Extract--V1 (L): 0.009
 Vol. of water filtered -- V2 (L): 0.045
 Light Path Length--L (cm): 1

Chlorophyll a in ug: 6.8E-02
 Number of Slides: 2
 Area of Slides in m^2: 0.0038
 Chlorophyll a in ug/m^2: 17.77

Growth rate (1/day): -0.01
 Growth corrected for photoper: -0.04

Water Temperature
 Max Water Temperature
 WTCF 1.00
 Growth corrected for Temp -0.04

Lac Court Oreilles Periphyton Computations

Sampler Location: P-3

Week #	1	Julian Day
Date of Installation:	05/21/96	142
Date of Collection:	05/28/96	149
Photoperiod	0.61	
Vol. of water filtered -- V2 (L):	0.172	
Chlorophyll a in ug/L:	59.1	
Chlorophyll a in ug:	10.17	
Number of Slides:	2	
Area of Slides in m ² :	0.0038	
Chlorophyll a in ug/m ² :	2675.05	
Growth rate (1/day):	1.13	
Growth corrected for photoper:	1.84	
Water Temperature		
Max Water Temperature		
WTCF	1.00	
Growth corrected for Temp	1.84	

Lac Court Oreilles Periphyton Computations

Sampler Location: P-3

Week #	2	Julian Day
Date of Installation:	05/21/96	142
Date of Collection:	06/03/96	155
Photoperiod	0.62	
Vol. of water filtered -- V2 (L):	0.128	
Chlorophyll a in ug/L:	659	
Chlorophyll a in ug:	84.35	
Number of Slides:	2	
Area of Slides in m ² :	0.0038	
Chlorophyll a in ug/m ² :	22197.89	
Growth rate (1/day):	0.35	
Growth corrected for photoper:	0.57	
Water Temperature	15.1	
Max Water Temperature	24.1	
WTCF	0.56	
Growth corrected for Temp	1.01	

Lac Court Oreilles Periphyton Computations

Sampler Location: P-3

Week #	3	Julian Day
Date of Installation:	05/21/96	142
Date of Collection:	06/10/96	162
Photoperiod	0.63	
Vol. of water filtered -- V2 (L):	0.06	
Chlorophyll a in ug/L:	2556	
Chlorophyll a in ug:	153.36	
Number of Slides:	2	
Area of Slides in m ² :	0.0038	
Chlorophyll a in ug/m ² :	40357.89	
Growth rate (1/day):	0.09	
Growth corrected for photoper:	0.14	
Water Temperature		
Max Water Temperature		
WTCF	1.00	
Growth corrected for Temp	0.14	

Lac Court Oreilles Periphyton Computations

Sampler Location: P-3

Week #	4	Julian Day
Date of Installation:	05/21/96	142
Date of Collection:	06/17/96	169
Photoperiod	0.64	
Vol. of water filtered -- V2 (L):	0.108	
Chlorophyll a in ug/L:	1589	
Chlorophyll a in ug:	171.61	
Number of Slides:	2	
Area of Slides in m ² :	0.0038	
Chlorophyll a in ug/m ² :	45161.05	
Growth rate (1/day):	0.02	
Growth corrected for photoper:	0.03	
Water Temperature		
Max Water Temperature		
WTCF	1.00	
Growth corrected for Temp	0.03	

Lac Court Oreilles Periphyton Computations

Sampler Location: P-3

Week # 1 Julian Day
 Date of Installation: 06/18/96 170
 Date of Collection: 06/27/96 179
 Photoperiod 0.64

Spectrophotometer Data:
 ABS. @ 750NM 0.218
 ABS @ 664NM 0.554
 ABS @ 750NM + ACID 0.298
 ABS @ 664NM + ACID 0.474

Volume of Extract--V1 (L): 0.0095
 Vol. of water filtered -- V2 (L): 0.048
 Light Path Length--L (cm): 1

Chlorophyll a in ug: 4.1E-02
 Number of Slides: 2
 Area of Slides in m^2: 0.0038
 Chlorophyll a in ug/m^2: 10.68

Growth rate (1/day): 0.26
 Growth corrected for photoper: 0.41

Water Temperature 20.5
 Max Water Temperature 24.1
 WTCF 0.79
 Growth corrected for Temp 0.52

Chl a (ug) = (26.7(664BA-665AA)*V1)/L
 Where:
 664BA = Before Acid Absorbancy at 664 NM - Before Acid Absorbancy at 750 NM
 665 AA = After Acid Absorbancy at 665 NM - After Acid Absorbancy at 750 NM
 V1 = Volume of Extract in L
 V2 = Volume of water filtered (L)
 L = Light Path Length (cm)

Lac Court Oreilles Periphyton Computations

Sampler Location: P-3

Week # 2 Julian Day
 Date of Installation: 06/18/96 170
 Date of Collection: 07/03/96 185
 Photoperiod 0.64

Spectrophotometer Data:
 ABS. @ 750NM 0.6
 ABS @ 664NM 1.2
 ABS @ 750NM + ACID 0.69
 ABS @ 664NM + ACID 1.005

Volume of Extract--V1 (L): 0.009
 Vol. of water filtered -- V2 (L): 0.135
 Light Path Length--L (cm): 1

Chlorophyll a in ug: 6.8E-02
 Number of Slides: 2
 Area of Slides in m^2: 0.0038
 Chlorophyll a in ug/m^2: 18.02

Growth rate (1/day): 0.09
 Growth corrected for photoper: 0.14

Water Temperature
 Max Water Temperature
 WTCF 1.00
 Growth corrected for Temp 0.14

Lac Court Oreilles Periphyton Computations

Sampler Location: P-3

Week # 3 Julian Day
 Date of Installation: 06/18/96 170
 Date of Collection: 07/10/96 192
 Photoperiod 0.63

Spectrophotometer Data:
 ABS. @ 750NM 1.19
 ABS @ 664NM 1.8
 ABS @ 750NM + ACID 1.35
 ABS @ 664NM + ACID 1.52

Volume of Extract--V1 (L): 0.0088
 Vol. of water filtered -- V2 (L): 0.08
 Light Path Length--L (cm): 1

Chlorophyll a in ug: 1.0E-01
 Number of Slides: 2
 Area of Slides in m^2: 0.0038
 Chlorophyll a in ug/m^2: 27.21

Growth rate (1/day): 0.06
 Growth corrected for photoper: 0.09

Water Temperature
 Max Water Temperature
 WTCF 1.00
 Growth corrected for Temp 0.09

Lac Court Oreilles Periphyton Computations

Sampler Location: P-3

Week # 4 Julian Day
 Date of Installation: 06/18/96 170
 Date of Collection: 07/16/96 198
 Photoperiod 0.62

Spectrophotometer Data:
 ABS. @ 750NM 1.11
 ABS @ 664NM 1.7
 ABS @ 750NM + ACID 1.48
 ABS @ 664NM + ACID 1.64

Volume of Extract--V1 (L): 0.0082
 Vol. of water filtered -- V2 (L): 0.04
 Light Path Length--L (cm): 1

Chlorophyll a in ug: 9.4E-02
 Number of Slides: 2
 Area of Slides in m^2: 0.0038
 Chlorophyll a in ug/m^2: 24.77

Growth rate (1/day): -0.02
 Growth corrected for photoper: -0.03

Water Temperature
 Max Water Temperature
 WTCF 1.00
 Growth corrected for Temp -0.03

Lac Court Orelles Periphyton Computations

Sampler Location: P-3
 Week # 1 Julian Day
 Date of Installation: 07/23/96 205
 Date of Collection: 08/02/96 215
 Photoperiod 0.58

Spectrophotometer Data:
 ABS. @ 750NM 0.13
 ABS @ 664NM 0.313
 ABS @ 750NM + ACID 0.139
 ABS @ 664NM + ACID 0.219

Volume of Extract--V1 (L): 0.0091
 Vol. of water filtered -- V2 (L): 0.048
 Light Path Length--L (cm): 1

Chlorophyll a in ug: 2.5E-02
 Number of Slides: 2
 Area of Slides in m^2: 0.0038
 Chlorophyll a in ug/m^2: 6.59

Growth rate (1/day): 0.19
 Growth corrected for photoper: 0.32

Water Temperature
 Max Water Temperature
 WTCF 1.00
 Growth corrected for Temp 0.32

Chl a (ug) = (26.7(664BA-665AA)*V1)/L
 Where:
 664BA = Before Acid Absorbancy at 664 NM - Before Acid Absorbancy at 750 NM
 665 AA = After Acid Absorbancy at 665 NM - After Acid Absorbancy at 750 NM
 V1 = Volume of Extract in L
 V2 = Volume of water filtered (L)
 L = Light Path Length (cm)

Lac Court Orelles Periphyton Computations

Sampler Location: P-3
 Week # 2 Julian Day
 Date of Installation: 07/23/96 205
 Date of Collection: 08/09/96 222
 Photoperiod 0.55

Spectrophotometer Data:
 ABS. @ 750NM 0.92
 ABS @ 664NM 1.66
 ABS @ 750NM + ACID 0.738
 ABS @ 664NM + ACID 1.07

Volume of Extract--V1 (L): 0.0076
 Vol. of water filtered -- V2 (L): 0.098
 Light Path Length--L (cm): 1

Chlorophyll a in ug: 8.3E-02
 Number of Slides: 2
 Area of Slides in m^2: 0.0038
 Chlorophyll a in ug/m^2: 21.79

Growth rate (1/day): 0.17
 Growth corrected for photoper: 0.31

Water Temperature 22
 Max Water Temperature 24.1
 WTCF 0.87
 Growth corrected for Temp 0.35

Lac Court Orelles Periphyton Computations

Sampler Location: P-3
 Week # 3 Julian Day
 Date of Installation: 07/29/96 205
 Date of Collection: 08/16/96 229
 Photoperiod 0.53

Spectrophotometer Data:
 ABS. @ 750NM 0.153
 ABS @ 664NM 0.855
 ABS @ 750NM + ACID 0.309
 ABS @ 664NM + ACID 0.815

Volume of Extract--V1 (L): 0.007
 Vol. of water filtered -- V2 (L): 0.096
 Light Path Length--L (cm): 1

Chlorophyll a in ug: 3.7E-02
 Number of Slides: 2
 Area of Slides in m^2: 0.0038
 Chlorophyll a in ug/m^2: 9.64

Growth rate (1/day): -0.12
 Growth corrected for photoper: -0.22

Water Temperature
 Max Water Temperature
 WTCF 1.00
 Growth corrected for Temp -0.22

Lac Court Orelles Periphyton Computations

Sampler Location: P-3
 Week # 4 Julian Day
 Date of Installation: 07/23/96 205
 Date of Collection: 08/26/96 239
 Photoperiod 0.50

Spectrophotometer Data:
 ABS. @ 750NM 0.02
 ABS @ 664NM 0.85
 ABS @ 750NM + ACID 0.062
 ABS @ 664NM + ACID 0.674

Volume of Extract--V1 (L): 0.0085
 Vol. of water filtered -- V2 (L): 0.133
 Light Path Length--L (cm): 1

Chlorophyll a in ug: 4.9E-02
 Number of Slides: 2
 Area of Slides in m^2: 0.0038
 Chlorophyll a in ug/m^2: 13.02

Growth rate (1/day): 0.03
 Growth corrected for photoper: 0.06

Water Temperature
 Max Water Temperature
 WTCF 1.00
 Growth corrected for Temp 0.06

Lac Court Oreilles Periphyton Computations

Sampler Location: P-3
 Week # 1 Julian Day
 Date of Installation: 09/06/96 250
 Date of Collection: 09/16/96 260
 Photoperiod 0.40

Spectrophotometer Data:
 ABS. @ 750NM 0.025
 ABS @ 664NM 0.049
 ABS @ 750NM + ACID 0.072
 ABS @ 664NM + ACID 0.097

Volume of Extract--V1 (L): 0.009
 Vol. of water filtered -- V2 (L): 0.022
 Light Path Length--L (cm): 1

Chlorophyll a in ug: -2.4E-04
 Number of Slides: 2
 Area of Slides in m^2: 0.0038
 Chlorophyll a in ug/m^2: 0.06

Growth rate (1/day): ERR
 Growth corrected for photoper: ERR

Water Temperature
 Max Water Temperature
 WTCF ERR
 Growth corrected for Temp ERR

Chl a (ug) = (26.7(664BA-665AA)*V1)/L
 Where:
 664BA = Before Acid Absorbancy at 664 NM - Before Acid Absorbancy at 750 NM
 665 AA = After Acid Absorbancy at 665 NM - After Acid Absorbancy at 750 NM
 V1 = Volume of Extract in L
 V2 = Volume of water filtered (L)
 L = Light Path Length (cm)

Lac Court Oreilles Periphyton Computations

Sampler Location: P-3
 Week # 2 Julian Day
 Date of Installation: 09/06/96 250
 Date of Collection: 09/24/96 268
 Photoperiod 0.36

Spectrophotometer Data:
 ABS. @ 750NM 0.079
 ABS @ 664NM 0.197
 ABS @ 750NM + ACID 0.183
 ABS @ 664NM + ACID 0.267

Volume of Extract--V1 (L): 0.009
 Vol. of water filtered -- V2 (L): 0.027
 Light Path Length--L (cm): 1

Chlorophyll a in ug: 8.2E-03
 Number of Slides: 2
 Area of Slides in m^2: 0.0038
 Chlorophyll a in ug/m^2: 2.15

Growth rate (1/day): ERR
 Growth corrected for photoper: ERR

Water Temperature
 Max Water Temperature
 WTCF ERR
 Growth corrected for Temp ERR

Lac Court Oreilles Periphyton Computations

Sampler Location: P-3
 Week # 3 Julian Day
 Date of Installation: 09/06/96 250
 Date of Collection: 10/08/96 282
 Photoperiod 0.30

Spectrophotometer Data:
 ABS. @ 750NM 0.017
 ABS @ 664NM 0.74
 ABS @ 750NM + ACID 0.03
 ABS @ 664NM + ACID 0.522

Volume of Extract--V1 (L): 0.009
 Vol. of water filtered -- V2 (L): 0.039
 Light Path Length--L (cm): 1

Chlorophyll a in ug: 5.6E-02
 Number of Slides: 2
 Area of Slides in m^2: 0.0038
 Chlorophyll a in ug/m^2: 14.61

Growth rate (1/day): 0.14
 Growth corrected for photoper: 0.45

Water Temperature 13.6
 Max Water Temperature 24.1
 WTCF 0.51
 Growth corrected for Temp 0.88

Lac Court Oreilles Periphyton Computations

Sampler Location: P-3
 Week # 4 Julian Day
 Date of Installation: 09/06/96 250
 Date of Collection: 10/22/96 296
 Photoperiod 0.24

Spectrophotometer Data:
 ABS. @ 750NM 0.011
 ABS @ 664NM 0.59
 ABS @ 750NM + ACID 0.066
 ABS @ 664NM + ACID 0.468

Volume of Extract--V1 (L): 0.009
 Vol. of water filtered -- V2 (L): 0.045
 Light Path Length--L (cm): 1

Chlorophyll a in ug: 4.3E-02
 Number of Slides: 2
 Area of Slides in m^2: 0.0038
 Chlorophyll a in ug/m^2: 11.19

Growth rate (1/day): -0.02
 Growth corrected for photoper: -0.08

Water Temperature
 Max Water Temperature
 WTCF 1.00
 Growth corrected for Temp -0.08

Lac Court Oreilles Periphyton Computations

Sampler Location: P-4
 Week # 1 Julian Day
 Date of Installation: 05/21/96 142
 Date of Collection: 05/28/96 149
 Photoperiod 0.61

Spectrophotometer Data:
 ABS. @ 750NM 0.039
 ABS @ 664NM 0.135
 ABS @ 750NM + ACID 0.057
 ABS @ 664NM + ACID 0.137

Volume of Extract--V1 (L): 0.0088
 Vol. of water filtered -- V2 (L): 0.2
 Light Path Length--L (cm): 1

Chlorophyll a in ug: 3.8E-03
 Number of Slides: 2
 Area of Slides in m^2: 0.0038
 Chlorophyll a in ug/m^2: 0.99

Growth rate (1/day): -0.00
 Growth corrected for photoper: -0.00

Water Temperature
 Max Water Temperature
 WTCF 1.00
 Growth corrected for Temp -0.00

Chl a (ug) = (26.7(664BA-665AA)*V1)/L
 Where:
 664BA = Before Acid Absorbancy at 664 NM - Before Acid Absorbancy at 750 NM
 665 AA = After Acid Absorbancy at 665 NM - After Acid Absorbancy at 750 NM
 V1 = Volume of Extract in L
 V2 = Volume of water filtered (L)
 L = Light Path Length (cm)

Lac Court Oreilles Periphyton Computations

Sampler Location: P-4
 Week # 2 Julian Day
 Date of Installation: 05/21/96 142
 Date of Collection: 06/03/96 155
 Photoperiod 0.62

Spectrophotometer Data:
 ABS. @ 750NM 0.248
 ABS @ 664NM 0.586
 ABS @ 750NM + ACID 0.297
 ABS @ 664NM + ACID 0.534

Volume of Extract--V1 (L): 0.0087
 Vol. of water filtered -- V2 (L): 0.148
 Light Path Length--L (cm): 1

Chlorophyll a in ug: 2.3E-02
 Number of Slides: 2
 Area of Slides in m^2: 0.0038
 Chlorophyll a in ug/m^2: 6.17

Growth rate (1/day): 0.31
 Growth corrected for photoper: 0.49

Water Temperature
 Max Water Temperature
 WTCF 1.00
 Growth corrected for Temp 0.49

Lac Court Oreilles Periphyton Computations

Sampler Location: P-4
 Week # 3 Julian Day
 Date of Installation: 05/21/96 142
 Date of Collection: 06/10/96 162
 Photoperiod 0.63

Spectrophotometer Data:
 ABS. @ 750NM 0.334
 ABS @ 664NM 0.678
 ABS @ 750NM + ACID 0.408
 ABS @ 664NM + ACID 0.626

Volume of Extract--V1 (L): 0.0088
 Vol. of water filtered -- V2 (L): 0.1
 Light Path Length--L (cm): 1

Chlorophyll a in ug: 3.0E-02
 Number of Slides: 2
 Area of Slides in m^2: 0.0038
 Chlorophyll a in ug/m^2: 7.79

Growth rate (1/day): 0.03
 Growth corrected for photoper: 0.05

Water Temperature
 Max Water Temperature
 WTCF 1.00
 Growth corrected for Temp 0.05

Lac Court Oreilles Periphyton Computations

Sampler Location: P-4
 Week # 4 Julian Day
 Date of Installation: 05/21/96 142
 Date of Collection: 06/17/96 169
 Photoperiod 0.64

Spectrophotometer Data:
 ABS. @ 750NM 0.466
 ABS @ 664NM 1.04
 ABS @ 750NM + ACID 0.66
 ABS @ 664NM + ACID 0.92

Volume of Extract--V1 (L): 0.0087
 Vol. of water filtered -- V2 (L): 0.092
 Light Path Length--L (cm): 1

Chlorophyll a in ug: 7.3E-02
 Number of Slides: 2
 Area of Slides in m^2: 0.0038
 Chlorophyll a in ug/m^2: 19.19

Growth rate (1/day): 0.13
 Growth corrected for photoper: 0.20

Water Temperature
 Max Water Temperature
 WTCF 0.80
 Growth corrected for Temp 0.25

Lac Court Oreilles Periphyton Computations

Sampler Location: P-4

Week # **1** Julian Day
 Date of Installation: 06/18/96 170
 Date of Collection: 06/27/96 179
 Photoperiod 0.64

Spectrophotometer Data:
 ABS. @ 750NM 0.129
 ABS @ 664NM 0.341
 ABS @ 750NM + ACID 0.14
 ABS @ 664NM + ACID 0.257

Volume of Extract--V1 (L): 0.0094
 Vol. of water filtered -- V2 (L): 0.048
 Light Path Length--L (cm): 1

Chlorophyll a in ug: 2.4E-02
 Number of Slides: 2
 Area of Slides in m^2: 0.0038
 Chlorophyll a in ug/m^2: 6.27

Growth rate (1/day): 0.20
 Growth corrected for photoper: 0.32

Water Temperature 20.5
 Max Water Temperature 24.1
 WTCF 0.79
 Growth corrected for Temp 0.40

Chi a (ug) = (26.7(664BA-665AA)*V1)/L
 Where:
 664BA = Before Acid Absorbancy at 664 NM - Before Acid Absorbancy at 750 NM
 665 AA = After Acid Absorbancy at 665 NM - After Acid Absorbancy at 750 NM
 V1 = Volume of Extract in L
 V2 = Volume of water filtered (L)
 L = Light Path Length (cm)

Lac Court Oreilles Periphyton Computations

Sampler Location: P-4

Week # **2** Julian Day
 Date of Installation: 06/18/96 170
 Date of Collection: 07/03/96 185
 Photoperiod 0.64

Spectrophotometer Data:
 ABS. @ 750NM 0.313
 ABS @ 664NM 0.67
 ABS @ 750NM + ACID 0.362
 ABS @ 664NM + ACID 0.54

Volume of Extract--V1 (L): 0.0093
 Vol. of water filtered -- V2 (L): 0.072
 Light Path Length--L (cm): 1

Chlorophyll a in ug: 4.4E-02
 Number of Slides: 2
 Area of Slides in m^2: 0.0038
 Chlorophyll a in ug/m^2: 11.70

Growth rate (1/day): 0.10
 Growth corrected for photoper: 0.16

Water Temperature
 Max Water Temperature
 WTCF 1.00
 Growth corrected for Temp 0.16

Lac Court Oreilles Periphyton Computations

Sampler Location: P-4

Week # **3** Julian Day
 Date of Installation: 06/18/96 170
 Date of Collection: 07/10/96 192
 Photoperiod 0.63

Spectrophotometer Data:
 ABS. @ 750NM 0.955
 ABS @ 664NM 1.34
 ABS @ 750NM + ACID 0.855
 ABS @ 664NM + ACID 1.05

Volume of Extract--V1 (L): 0.0097
 Vol. of water filtered -- V2 (L): 0.087
 Light Path Length--L (cm): 1

Chlorophyll a in ug: 4.9E-02
 Number of Slides: 2
 Area of Slides in m^2: 0.0038
 Chlorophyll a in ug/m^2: 12.95

Growth rate (1/day): 0.01
 Growth corrected for photoper: 0.02

Water Temperature
 Max Water Temperature
 WTCF 1.00
 Growth corrected for Temp 0.02

Lac Court Oreilles Periphyton Computations

Sampler Location: P-4

Week # **4** Julian Day
 Date of Installation: 06/18/96 170
 Date of Collection: 07/16/96 198
 Photoperiod 0.62

Spectrophotometer Data:
 ABS. @ 750NM 0.125
 ABS @ 664NM 0.28
 ABS @ 750NM + ACID 0.173
 ABS @ 664NM + ACID 0.256

Volume of Extract--V1 (L): 0.009
 Vol. of water filtered -- V2 (L): 0.052
 Light Path Length--L (cm): 1

Chlorophyll a in ug: 1.7E-02
 Number of Slides: 2
 Area of Slides in m^2: 0.0038
 Chlorophyll a in ug/m^2: 4.55

Growth rate (1/day): -0.17
 Growth corrected for photoper: -0.28

Water Temperature
 Max Water Temperature
 WTCF 1.00
 Growth corrected for Temp -0.28

Lac Court Oreilles Periphyton Computations

Sampler Location: P4
 Week # 1 Julian Day
 Date of Installation: 07/23/96 205
 Date of Collection: 08/02/96 215
 Photoperiod 0.58

Spectrophotometer Data:
 ABS. @ 750NM 0.027
 ABS @ 664NM 0.088
 ABS @ 750NM + ACID 0.039
 ABS @ 664NM + ACID 0.073

Volume of Extract--V1 (L): 0.0092
 Vol. of water filtered -- V2 (L): 0.047
 Light Path Length--L (cm): 1

Chlorophyll a in ug: 6.6E-03
 Number of Slides: 2
 Area of Slides in m^2: 0.0038
 Chlorophyll a in ug/m^2: 1.75

Growth rate (1/day): 0.06
 Growth corrected for photoper: 0.10

Water Temperature
 Max Water Temperature
 WTCF 1.00
 Growth corrected for Temp 0.10

Chl a (ug) = (26.7(664BA-665AA)*V1)/L
 Where:
 664BA = Before Acid Absorbancy at 664 NM - Before Acid Absorbancy at 750 NM
 665 AA = After Acid Absorbancy at 665 NM - After Acid Absorbancy at 750 NM
 V1 = Volume of Extract in L
 V2 = Volume of water filtered (L)
 L = Light Path Length (cm)

Lac Court Oreilles Periphyton Computations

Sampler Location: P4
 Week # 2 Julian Day
 Date of Installation: 07/23/96 205
 Date of Collection: 08/09/96 222
 Photoperiod 0.55

Spectrophotometer Data:
 ABS. @ 750NM 0.358
 ABS @ 664NM 0.538
 ABS @ 750NM + ACID 0.155
 ABS @ 664NM + ACID 0.239

Volume of Extract--V1 (L): 0.009
 Vol. of water filtered -- V2 (L): 0.074
 Light Path Length--L (cm): 1

Chlorophyll a in ug: 2.3E-02
 Number of Slides: 2
 Area of Slides in m^2: 0.0038
 Chlorophyll a in ug/m^2: 6.07

Growth rate (1/day): 0.18
 Growth corrected for photoper: 0.32

Water Temperature 22
 Max Water Temperature 24.1
 WTCF 0.87
 Growth corrected for Temp 0.37

Lac Court Oreilles Periphyton Computations

Sampler Location: P4
 Week # 3 Julian Day
 Date of Installation: 07/23/96 205
 Date of Collection: 08/16/96 229
 Photoperiod 0.53

Spectrophotometer Data:
 ABS. @ 750NM 0.083
 ABS @ 664NM 0.354
 ABS @ 750NM + ACID 0.162
 ABS @ 664NM + ACID 0.374

Volume of Extract--V1 (L): 0.0073
 Vol. of water filtered -- V2 (L): 0.081
 Light Path Length--L (cm): 1

Chlorophyll a in ug: 1.1E-02
 Number of Slides: 2
 Area of Slides in m^2: 0.0038
 Chlorophyll a in ug/m^2: 3.03

Growth rate (1/day): -0.10
 Growth corrected for photoper: -0.19

Water Temperature
 Max Water Temperature
 WTCF 1.00
 Growth corrected for Temp -0.19

Lac Court Oreilles Periphyton Computations

Sampler Location: P4
 Week # 4 Julian Day
 Date of Installation: 07/23/96 205
 Date of Collection: 08/26/96 239
 Photoperiod 0.50

Spectrophotometer Data:
 ABS. @ 750NM 0.01
 ABS @ 664NM 0.279
 ABS @ 750NM + ACID 0.103
 ABS @ 664NM + ACID 0.319

Volume of Extract--V1 (L): 0.009
 Vol. of water filtered -- V2 (L): 0.095
 Light Path Length--L (cm): 1

Chlorophyll a in ug: 1.3E-02
 Number of Slides: 2
 Area of Slides in m^2: 0.0038
 Chlorophyll a in ug/m^2: 3.35

Growth rate (1/day): 0.01
 Growth corrected for photoper: 0.02

Water Temperature
 Max Water Temperature
 WTCF 1.00
 Growth corrected for Temp 0.02

Lac Court Oeilles Periphyton Computations

Sampler Location: P-4
 Week # 1 Julian Day
 Date of Installation: 09/06/96 250
 Date of Collection: 09/16/96 260
 Photoperiod 0.40

Spectrophotometer Data:
 ABS. @ 750NM 0.03
 ABS @ 664NM 0.062
 ABS @ 750NM + ACID 0.07
 ABS @ 664NM + ACID 0.09

Volume of Extract--V1 (L): 0.009
 Vol. of water filtered -- V2 (L): 0.027
 Light Path Length--L (cm): 1

Chlorophyll a in ug: 2.9E-03
 Number of Slides: 2
 Area of Slides in m^2: 0.0038
 Chlorophyll a in ug/m^2: 0.76

Growth rate (1/day): -0.03
 Growth corrected for photoper: -0.07

Water Temperature
 Max Water Temperature
 WTCF 1.00
 Growth corrected for Temp -0.07

Chl a (ug) = (26.7(664BA-665AA)*V1)/L

Where:

664BA = Before Acid Absorbancy at 664 NM - Before Acid Absorbancy at 750 NM

665 AA = After Acid Absorbancy at 665 NM - After Acid Absorbancy at 750 NM

V1 = Volume of Extract in L

V2 = Volume of water filtered (L)

L = Light Path Length (cm)

Lac Court Oeilles Periphyton Computations

Sampler Location: P-4
 Week # 2 Julian Day
 Date of Installation: 09/06/96 250
 Date of Collection: 09/24/96 268
 Photoperiod 0.36

Spectrophotometer Data:
 ABS. @ 750NM 0.088
 ABS @ 664NM 0.076
 ABS @ 750NM + ACID 0.231
 ABS @ 664NM + ACID 0.229

Volume of Extract--V1 (L): 0.009
 Vol. of water filtered -- V2 (L): 0.017
 Light Path Length--L (cm): 1

Chlorophyll a in ug: -2.4E-03
 Number of Slides: 2
 Area of Slides in m^2: 0.0038
 Chlorophyll a in ug/m^2: -0.63

Growth rate (1/day): ERR
 Growth corrected for photoper: ERR

Water Temperature
 Max Water Temperature
 WTCF ERR
 Growth corrected for Temp ERR

Lac Court Oeilles Periphyton Computations

Sampler Location: P-4
 Week # 3 Julian Day
 Date of Installation: 09/06/96 250
 Date of Collection: 10/08/96 282
 Photoperiod 0.30

Spectrophotometer Data:
 ABS. @ 750NM 0.023
 ABS @ 664NM 0.078
 ABS @ 750NM + ACID 0.036
 ABS @ 664NM + ACID 0.087

Volume of Extract--V1 (L): 0.009
 Vol. of water filtered -- V2 (L): 0.034
 Light Path Length--L (cm): 1

Chlorophyll a in ug: 9.6E-04
 Number of Slides: 2
 Area of Slides in m^2: 0.0038
 Chlorophyll a in ug/m^2: 0.25

Growth rate (1/day): ERR
 Growth corrected for photoper: ERR

Water Temperature
 Max Water Temperature
 WTCF ERR
 Growth corrected for Temp ERR

Lac Court Oeilles Periphyton Computations

Sampler Location: P-4
 Week # 4 Julian Day
 Date of Installation: 09/06/96 250
 Date of Collection: 10/22/96 296
 Photoperiod 0.24

Spectrophotometer Data:
 ABS. @ 750NM 0.013
 ABS @ 664NM 0.318
 ABS @ 750NM + ACID 0.085
 ABS @ 664NM + ACID 0.32

Volume of Extract--V1 (L): 0.009
 Vol. of water filtered -- V2 (L): 0.04
 Light Path Length--L (cm): 1

Chlorophyll a in ug: 1.7E-02
 Number of Slides: 2
 Area of Slides in m^2: 0.0038
 Chlorophyll a in ug/m^2: 4.43

Growth rate (1/day): 0.20
 Growth corrected for photoper: 0.85

Water Temperature 13.6
 Max Water Temperature 24.1
 WTCF 0.51
 Growth corrected for Temp 1.67

Lac Court Oreilles Periphyton Computations

Sampler Location: P-5

Week #	1	Julian Day
Date of Installation:	05/21/96	142
Date of Collection:	05/28/96	149
Photoperiod	0.61	
Vol. of water filtered -- V2 (L):	0.079	
Chlorophyll a in ug/L:	1.7	
Chlorophyll a in ug:	0.13	
Number of Slides:	2	
Area of Slides in m ² :	0.0038	
Chlorophyll a in ug/m ² :	35.34	
Growth rate (1/day):	0.51	
Growth corrected for photoper:	0.83	
Water Temperature		
Max Water Temperature		
WTCF	1.00	
Growth corrected for Temp	0.83	

Lac Court Oreilles Periphyton Computations

Sampler Location: P-5

Week #	2	Julian Day
Date of Installation:	05/21/96	142
Date of Collection:	06/03/96	155
Photoperiod	0.62	
Vol. of water filtered -- V2 (L):	0.102	
Chlorophyll a in ug/L:	12.3	
Chlorophyll a in ug:	1.25	
Number of Slides:	2	
Area of Slides in m ² :	0.0038	
Chlorophyll a in ug/m ² :	330.16	
Growth rate (1/day):	0.37	
Growth corrected for photoper:	0.60	
Water Temperature		
Max Water Temperature		
WTCF	1.00	
Growth corrected for Temp	0.60	

Lac Court Oreilles Periphyton Computations

Sampler Location: P-5

Week #	3	Julian Day
Date of Installation:	05/21/96	142
Date of Collection:	06/10/96	162
Photoperiod	0.63	
Vol. of water filtered -- V2 (L):	0.07	
Chlorophyll a in ug/L:	355	
Chlorophyll a in ug:	24.85	
Number of Slides:	2	
Area of Slides in m ² :	0.0038	
Chlorophyll a in ug/m ² :	6539.47	
Growth rate (1/day):	0.43	
Growth corrected for photoper:	0.67	
Water Temperature	13.6	
Max Water Temperature	24.1	
WTCF	0.51	
Growth corrected for Temp	1.32	

Lac Court Oreilles Periphyton Computations

Sampler Location: P-5

Week #	4	Julian Day
Date of Installation:	05/21/96	142
Date of Collection:	06/17/96	169
Photoperiod	0.64	
Vol. of water filtered -- V2 (L):		
Chlorophyll a in ug/L:		
Chlorophyll a in ug:	0.00	
Number of Slides:		
Area of Slides in m ² :	0	
Chlorophyll a in ug/m ² :	ERR	
Growth rate (1/day):	ERR	
Growth corrected for photoper:	ERR	
Water Temperature		
Max Water Temperature		
WTCF	ERR	
Growth corrected for Temp	ERR	

Lac Court Oreilles Periphyton Computations

Sampler Location: P-6

Week # 1 Julian Day
 Date of Installation: 08/02/96 215
 Date of Collection: 08/09/96 222
 Photoperiod 0.55

Spectrophotometer Data:

ABS. @ 750NM 0.278
 ABS @ 664NM 0.396
 ABS @ 750NM + ACID 0.089
 ABS @ 664NM + ACID 0.126

Volume of Extract--V1 (L): 0.0092
 Vol. of water filtered -- V2 (L): 0.036
 Light Path Length--L (cm): 1

Chlorophyll a in ug: 2.0E-02
 Number of Slides: 2
 Area of Slides in m^2: 0.0038
 Chlorophyll a in ug/m^2: 5.24

Growth rate (1/day): 0.24
 Growth corrected for photoper: 0.43

Water Temperature 24.1
 Max Water Temperature 24.1
 WTCF 1.00
 Growth corrected for Temp 0.43

Chl a (ug) = (26.7(664BA-665AA)*V1)/L

Where:

664BA = Before Acid Absorbancy at 664 NM - Before Acid Absorbancy at 750 NM

665 AA = After Acid Absorbancy at 665 NM - After Acid Absorbancy at 750 NM

V1 = Volume of Extract in L

V2 = Volume of water filtered (L)

L = Light Path Length (cm)

Lac Court Oreilles Periphyton Computations

Sampler Location: P-6

Week # 2 Julian Day
 Date of Installation: 08/02/96 215
 Date of Collection: 08/16/96 229
 Photoperiod 0.53

Spectrophotometer Data:

ABS. @ 750NM 0.034
 ABS @ 664NM 0.127
 ABS @ 750NM + ACID 0.044
 ABS @ 664NM + ACID 0.123

Volume of Extract--V1 (L): 0.0087
 Vol. of water filtered -- V2 (L): 0.033
 Light Path Length--L (cm): 1

Chlorophyll a in ug: 3.3E-03
 Number of Slides: 2
 Area of Slides in m^2: 0.0038
 Chlorophyll a in ug/m^2: 0.86

Growth rate (1/day): -0.26
 Growth corrected for photoper: -0.49

Water Temperature
 Max Water Temperature
 WTCF 1.00
 Growth corrected for Temp -0.49

Lac Court Oreilles Periphyton Computations

Sampler Location: P-6

Week # 3 Julian Day
 Date of Installation: 08/02/96 215
 Date of Collection: 08/26/96 239
 Photoperiod 0.50

Spectrophotometer Data:

ABS. @ 750NM 0.018
 ABS @ 664NM 0.013
 ABS @ 750NM + ACID 0.095
 ABS @ 664NM + ACID 0.113

Volume of Extract--V1 (L): 0.009
 Vol. of water filtered -- V2 (L): 0.068
 Light Path Length--L (cm): 1

Chlorophyll a in ug: -5.5E-03
 Number of Slides: 2
 Area of Slides in m^2: 0.0038
 Chlorophyll a in ug/m^2: -1.45

Growth rate (1/day): ERR
 Growth corrected for photoper: ERR

Water Temperature
 Max Water Temperature
 WTCF ERR
 Growth corrected for Temp ERR

Lac Court Oreilles Periphyton Computations

Sampler Location: P-6

Week # 4 Julian Day
 Date of Installation: 08/02/96 215
 Date of Collection: 09/06/96 250
 Photoperiod 0.45

Spectrophotometer Data:

ABS. @ 750NM 0.014
 ABS @ 664NM 0.146
 ABS @ 750NM + ACID 0.101
 ABS @ 664NM + ACID 0.205

Volume of Extract--V1 (L): 0.009
 Vol. of water filtered -- V2 (L): 0.028
 Light Path Length--L (cm): 1

Chlorophyll a in ug: 6.7E-03
 Number of Slides: 2
 Area of Slides in m^2: 0.0038
 Chlorophyll a in ug/m^2: 1.77

Growth rate (1/day): ERR
 Growth corrected for photoper: ERR

Water Temperature
 Max Water Temperature
 WTCF ERR
 Growth corrected for Temp ERR

Lac Court Oreilles Periphyton Computations

Sampler Location: P-6
 Week # 1 Julian Day
 Date of Installation: 09/06/96 250
 Date of Collection: 09/16/96 260
 Photoperiod 0.40

Spectrophotometer Data:
 ABS. @ 750NM 0.006
 ABS @ 664NM 0.138
 ABS @ 750NM + ACID 0.058
 ABS @ 664NM + ACID 0.163

Volume of Extract--V1 (L): 0.009
 Vol. of water filtered -- V2 (L): 0.028
 Light Path Length--L (cm): 1

Chlorophyll a in ug: 6.5E-03
 Number of Slides: 2
 Area of Slides in m^2: 0.0038
 Chlorophyll a in ug/m^2: 1.71

Growth rate (1/day): 0.05
 Growth corrected for photoper: 0.13

Water Temperature
 Max Water Temperature
 WTCF 1.00
 Growth corrected for Temp 0.13

Chl a (ug) = (26.7(664BA-665AA)*V1)/L

Where:

664BA = Before Acid Absorbancy at 664 NM - Before Acid Absorbancy at 750 NM

665 AA = After Acid Absorbancy at 665 NM - After Acid Absorbancy at 750 NM

V1 = Volume of Extract in L

V2 = Volume of water filtered (L)

L = Light Path Length (cm)

Lac Court Oreilles Periphyton Computations

Sampler Location: P-6
 Week # 2 Julian Day
 Date of Installation: 09/06/96 250
 Date of Collection: 09/24/96 268
 Photoperiod 0.36

Spectrophotometer Data:
 ABS. @ 750NM 0.101
 ABS @ 664NM 0.468
 ABS @ 750NM + ACID 0.2
 ABS @ 664NM + ACID 0.474

Volume of Extract--V1 (L): 0.009
 Vol. of water filtered -- V2 (L): 0.036
 Light Path Length--L (cm): 1

Chlorophyll a in ug: 2.2E-02
 Number of Slides: 2
 Area of Slides in m^2: 0.0038
 Chlorophyll a in ug/m^2: 5.88

Growth rate (1/day): 0.15
 Growth corrected for photoper: 0.43

Water Temperature 15.2
 Max Water Temperature 24.1
 WTCF 0.57
 Growth corrected for Temp 0.77

Lac Court Oreilles Periphyton Computations

Sampler Location: P-6
 Week # 3 Julian Day
 Date of Installation: 09/06/96 250
 Date of Collection: 10/08/96 282
 Photoperiod 0.30

Spectrophotometer Data:
 ABS. @ 750NM 0.017
 ABS @ 664NM 0.546
 ABS @ 750NM + ACID 0.035
 ABS @ 664NM + ACID 0.41

Volume of Extract--V1 (L): 0.009
 Vol. of water filtered -- V2 (L): 0.045
 Light Path Length--L (cm): 1

Chlorophyll a in ug: 3.7E-02
 Number of Slides: 2
 Area of Slides in m^2: 0.0038
 Chlorophyll a in ug/m^2: 9.74

Growth rate (1/day): 0.04
 Growth corrected for photoper: 0.12

Water Temperature
 Max Water Temperature
 WTCF 1.00
 Growth corrected for Temp 0.12

Lac Court Oreilles Periphyton Computations

Sampler Location: P-6
 Week # 4 Julian Day
 Date of Installation: 09/06/96 250
 Date of Collection: 10/22/96 296
 Photoperiod 0.24

Spectrophotometer Data:
 ABS. @ 750NM 0.015
 ABS @ 664NM 0.72
 ABS @ 750NM + ACID 0.117
 ABS @ 664NM + ACID 0.692

Volume of Extract--V1 (L): 0.009
 Vol. of water filtered -- V2 (L): 0.035
 Light Path Length--L (cm): 1

Chlorophyll a in ug: 3.1E-02
 Number of Slides: 2
 Area of Slides in m^2: 0.0038
 Chlorophyll a in ug/m^2: 8.22

Growth rate (1/day): -0.01
 Growth corrected for photoper: -0.05

Water Temperature
 Max Water Temperature
 WTCF 1.00
 Growth corrected for Temp -0.05

Lac Court Oreilles Periphyton Computations

Sampler Location: P-7
 Week # 1 Julian Day
 Date of Installation: 08/02/96 215
 Date of Collection: 08/09/96 222
 Photoperiod 0.55

Spectrophotometer Data:

ABS. @ 750NM 0.122
 ABS @ 664NM 0.285
 ABS @ 750NM + ACID 0.144
 ABS @ 664NM + ACID 0.224

Volume of Extract--V1 (L): 0.0091
 Vol. of water filtered -- V2 (L): 0.054
 Light Path Length--L (cm): 1

Chlorophyll a in ug: 2.0E-02
 Number of Slides: 2
 Area of Slides in m^2: 0.0038
 Chlorophyll a in ug/m^2: 5.31

Growth rate (1/day): 0.24
 Growth corrected for photoper: 0.43

Water Temperature 24.1
 Max Water Temperature 24.1
 WTCF 1.00
 Growth corrected for Temp 0.43

Chl a (ug) = (26.7(664BA-665AA)*V1)/L

Where:

664BA = Before Acid Absorbancy at 664 NM - Before Acid Absorbancy at 750 NM

665 AA = After Acid Absorbancy at 665 NM - After Acid Absorbancy at 750 NM

V1 = Volume of Extract in L

V2 = Volume of water filtered (L)

L = Light Path Length (cm)

Lac Court Oreilles Periphyton Computations

Sampler Location: P-7
 Week # 2 Julian Day
 Date of Installation: 08/02/96 215
 Date of Collection: 08/16/96 229
 Photoperiod 0.53

Spectrophotometer Data:

ABS. @ 750NM 0.015
 ABS @ 664NM 0.045
 ABS @ 750NM + ACID 0.021
 ABS @ 664NM + ACID 0.04

Volume of Extract--V1 (L): 0.0087
 Vol. of water filtered -- V2 (L):
 Light Path Length--L (cm): 1

Chlorophyll a in ug: 2.6E-03
 Number of Slides: 2
 Area of Slides in m^2: 0.0038
 Chlorophyll a in ug/m^2: 0.67

Growth rate (1/day): -0.30
 Growth corrected for photoper: -0.56

Water Temperature
 Max Water Temperature
 WTCF 1.00
 Growth corrected for Temp -0.56

Lac Court Oreilles Periphyton Computations

Sampler Location: P-7
 Week # 3 Julian Day
 Date of Installation: 08/02/96 215
 Date of Collection: 08/26/96 239
 Photoperiod 0.50

Spectrophotometer Data:

ABS. @ 750NM 0.005
 ABS @ 664NM 0.096
 ABS @ 750NM + ACID 0.118
 ABS @ 664NM + ACID 0.198

Volume of Extract--V1 (L): 0.009
 Vol. of water filtered -- V2 (L): 0.071
 Light Path Length--L (cm): 1

Chlorophyll a in ug: 2.6E-03
 Number of Slides: 2
 Area of Slides in m^2: 0.0038
 Chlorophyll a in ug/m^2: 0.70

Growth rate (1/day): 0.00
 Growth corrected for photoper: 0.01

Water Temperature
 Max Water Temperature
 WTCF 1.00
 Growth corrected for Temp 0.01

Lac Court Oreilles Periphyton Computations

Sampler Location: P-7
 Week # 4 Julian Day
 Date of Installation: 08/02/96 215
 Date of Collection: 09/06/96 250
 Photoperiod 0.45

Spectrophotometer Data:

ABS. @ 750NM 0.018
 ABS @ 664NM 0.087
 ABS @ 750NM + ACID 0.147
 ABS @ 664NM + ACID 0.208

Volume of Extract--V1 (L): 0.009
 Vol. of water filtered -- V2 (L): 0.032
 Light Path Length--L (cm): 1

Chlorophyll a in ug: 1.9E-03
 Number of Slides: 2
 Area of Slides in m^2: 0.0038
 Chlorophyll a in ug/m^2: 0.51

Growth rate (1/day): -0.03
 Growth corrected for photoper: -0.06

Water Temperature
 Max Water Temperature
 WTCF 1.00
 Growth corrected for Temp -0.06

Lac Court Oreilles Periphyton Computations

Sampler Location: P-7

Week # 1 Julian Day
 Date of Installation: 09/06/97 615
 Date of Collection: 09/16/96 260
 Photoperiod 0.32

Spectrophotometer Data:

ABS. @ 750NM 0.019
 ABS @ 664NM 0.06
 ABS @ 750NM + ACID 0.042
 ABS @ 664NM + ACID 0.07

Volume of Extract--V1 (L): 0.009
 Vol. of water filtered -- V2 (L): 0.02
 Light Path Length--L (cm): 1

Chlorophyll a in ug: 3.1E-03
 Number of Slides: 2
 Area of Slides in m^2: 0.0038
 Chlorophyll a in ug/m^2: 0.82

Growth rate (1/day): 0.00
 Growth corrected for photoper.: 0.00

Water Temperature
 Max Water Temperature
 WTCF 1.00
 Growth corrected for Temp 0.00

Chl a (ug) = (26.7(664BA-665AA)*V1)/L

Where:

664BA = Before Acid Absorbancy at 664 NM - Before Acid Absorbancy at 750 NM

665 AA = After Acid Absorbancy at 665 NM - After Acid Absorbancy at 750 NM

V1 = Volume of Extract in L

V2 = Volume of water filtered (L)

L = Light Path Length (cm)

Lac Court Oreilles Periphyton Computations

Sampler Location: P-7

Week # 2 Julian Day
 Date of Installation: 09/06/97 615
 Date of Collection: 09/24/96 268
 Photoperiod 0.36

Spectrophotometer Data:

ABS. @ 750NM 0.037
 ABS @ 664NM 0.059
 ABS @ 750NM + ACID 0.051
 ABS @ 664NM + ACID 0.067

Volume of Extract--V1 (L): 0.0087
 Vol. of water filtered -- V2 (L): 0.022
 Light Path Length--L (cm): 1

Chlorophyll a in ug: 1.4E-03
 Number of Slides: 2
 Area of Slides in m^2: 0.0038
 Chlorophyll a in ug/m^2: 0.37

Growth rate (1/day): -0.10
 Growth corrected for photoper.: -0.28

Water Temperature
 Max Water Temperature
 WTCF 1.00
 Growth corrected for Temp -0.28

Lac Court Oreilles Periphyton Computations

Sampler Location: P-7

Week # 3 Julian Day
 Date of Installation: 09/06/97 615
 Date of Collection: 10/08/96 282
 Photoperiod 0.30

Spectrophotometer Data:

ABS. @ 750NM 0.027
 ABS @ 664NM 0.058
 ABS @ 750NM + ACID 0.061
 ABS @ 664NM + ACID 0.094

Volume of Extract--V1 (L): 0.009
 Vol. of water filtered -- V2 (L): 0.038
 Light Path Length--L (cm): 1

Chlorophyll a in ug: -4.8E-04
 Number of Slides: 2
 Area of Slides in m^2: 0.0038
 Chlorophyll a in ug/m^2: -0.13

Growth rate (1/day): ERR
 Growth corrected for photoper.: ERR

Water Temperature
 Max Water Temperature
 WTCF ERR
 Growth corrected for Temp ERR

Lac Court Oreilles Periphyton Computations

Sampler Location: P-7

Week # 4 Julian Day
 Date of Installation: 09/06/97 615
 Date of Collection: 10/22/96 296
 Photoperiod 0.24

Spectrophotometer Data:

ABS. @ 750NM 0.022
 ABS @ 664NM 0.159
 ABS @ 750NM + ACID 0.115
 ABS @ 664NM + ACID 0.231

Volume of Extract--V1 (L): 0.009
 Vol. of water filtered -- V2 (L): 0.032
 Light Path Length--L (cm): 1

Chlorophyll a in ug: 5.0E-03
 Number of Slides: 2
 Area of Slides in m^2: 0.0038
 Chlorophyll a in ug/m^2: 1.33

Growth rate (1/day): 0.02
 Growth corrected for photoper.: 0.08

Water Temperature 11.6
 Max Water Temperature 24.1
 WTCF 0.45
 Growth corrected for Temp 0.19

Lac Court Oreilles Periphyton Computations

Sampler Location:		P-8	
Week #	1	Julian Day	
Date of Installation:	05/21/96	142	
Date of Collection:	05/28/96	149	
Photoperiod	0.61		
Vol. of water filtered -- V2 (L):	0.095		
Chlorophyll a in ug/L:	8.26		
Chlorophyll a in ug:	0.78		
Number of Slides:	2		
Area of Slides in m ² :	0.0038		
Chlorophyll a in ug/m ² :	206.50		
Growth rate (1/day):	0.76		
Growth corrected for photoper:	1.25		
Water Temperature			
Max Water Temperature			
WTCF	1.00		
Growth corrected for Temp	1.25		

Lac Court Oreilles Periphyton Computations

Sampler Location:		P-8	
Week #	2	Julian Day	
Date of Installation:	05/21/96	142	
Date of Collection:	06/03/96	155	
Photoperiod	0.62		
Vol. of water filtered -- V2 (L):	0.152		
Chlorophyll a in ug/L:	152		
Chlorophyll a in ug:	23.10		
Number of Slides:	2		
Area of Slides in m ² :	0.0038		
Chlorophyll a in ug/m ² :	6080.00		
Growth rate (1/day):	0.56		
Growth corrected for photoper:	0.90		
Water Temperature			
Max Water Temperature			
WTCF	1.00		
Growth corrected for Temp	0.90		

Lac Court Oreilles Periphyton Computations

Sampler Location:		P-8	
Week #	3	Julian Day	
Date of Installation:	05/21/96	142	
Date of Collection:	06/10/96	162	
Photoperiod	0.63		
Vol. of water filtered -- V2 (L):	0.135		
Chlorophyll a in ug/L:	998		
Chlorophyll a in ug:	134.73		
Number of Slides:	2		
Area of Slides in m ² :	0.0038		
Chlorophyll a in ug/m ² :	35455.26		
Growth rate (1/day):	0.25		
Growth corrected for photoper:	0.40		
Water Temperature	13.8		
Max Water Temperature	22.5		
WTCF	0.57		
Growth corrected for Temp	0.69		

Lac Court Oreilles Periphyton Computations

Sampler Location:		P-8	
Week #	4	Julian Day	
Date of Installation:	05/21/96	142	
Date of Collection:	06/17/96	169	
Photoperiod	0.64		
Vol. of water filtered -- V2 (L):	0.068		
Chlorophyll a in ug/L:	1964		
Chlorophyll a in ug:	133.55		
Number of Slides:	2		
Area of Slides in m ² :	0.0038		
Chlorophyll a in ug/m ² :	35145.26		
Growth rate (1/day):	-0.00		
Growth corrected for photoper:	-0.00		
Water Temperature			
Max Water Temperature			
WTCF	1.00		
Growth corrected for Temp	-0.00		

Lac Court Oreilles Periphyton Computations

Sampler Location: P-8
Week # 1 Julian Day
 Date of Installation: 06/18/96 170
 Date of Collection: 06/27/96 179
 Photoperiod 0.64

Spectrophotometer Data:
 ABS. @ 750NM 0.77
 ABS @ 664NM 1.58
 ABS @ 750NM + ACID 0.945
 ABS @ 664NM + ACID 1.44

 Volume of Extract--V1 (L): 0.0093
 Vol. of water filtered -- V2 (L): 0.076
 Light Path Length--L (cm): 1

 Chlorophyll a in ug: 7.8E-02
 Number of Slides: 2
 Area of Slides in m^2: 0.0038
 Chlorophyll a in ug/m^2: 20.58

 Growth rate (1/day): 0.34
 Growth corrected for photoper: 0.53

 Water Temperature
 Max Water Temperature
 WTCF 1.00
 Growth corrected for Temp 0.53

Chl a (ug) = (26.7(664BA-665AA)*V1)/L

Where:

664BA = Before Acid Absorbancy at 664 NM - Before Acid Absorbancy at 750 NM

665 AA = After Acid Absorbancy at 665 NM - After Acid Absorbancy at 750 NM

V1 = Volume of Extract in L

V2 = Volume of water filtered (L)

L = Light Path Length (cm)

Lac Court Oreilles Periphyton Computations

Sampler Location: P-8
Week # 2 Julian Day
 Date of Installation: 06/18/96 170
 Date of Collection: 07/03/96 185
 Photoperiod 0.64

Spectrophotometer Data:
 ABS. @ 750NM 0.448
 ABS @ 664NM 1.15
 ABS @ 750NM + ACID 0.478
 ABS @ 664NM + ACID 0.945

 Volume of Extract--V1 (L): 0.0087
 Vol. of water filtered -- V2 (L): 0.103
 Light Path Length--L (cm): 1

 Chlorophyll a in ug: 5.5E-02
 Number of Slides: 2
 Area of Slides in m^2: 0.0038
 Chlorophyll a in ug/m^2: 14.37

 Growth rate (1/day): -0.06
 Growth corrected for photoper: -0.09

 Water Temperature
 Max Water Temperature
 WTCF 1.00
 Growth corrected for Temp -0.09

Lac Court Oreilles Periphyton Computations

Sampler Location: P-8
Week # 3 Julian Day
 Date of Installation: 06/18/96 170
 Date of Collection: 07/10/96 192
 Photoperiod 0.63

Spectrophotometer Data:
 ABS. @ 750NM 0.49
 ABS @ 664NM 0.73
 ABS @ 750NM + ACID 0.197
 ABS @ 664NM + ACID 0.324

 Volume of Extract--V1 (L): 0.0093
 Vol. of water filtered -- V2 (L): 0.088
 Light Path Length--L (cm): 1

 Chlorophyll a in ug: 2.8E-02
 Number of Slides: 2
 Area of Slides in m^2: 0.0038
 Chlorophyll a in ug/m^2: 7.38

 Growth rate (1/day): -0.10
 Growth corrected for photoper: -0.15

 Water Temperature
 Max Water Temperature
 WTCF 1.00
 Growth corrected for Temp -0.15

Lac Court Oreilles Periphyton Computations

Sampler Location: P-8
Week # 4 Julian Day
 Date of Installation: 06/18/96 170
 Date of Collection: 07/16/96 198
 Photoperiod 0.62

Spectrophotometer Data:
 ABS. @ 750NM 0.295
 ABS @ 664NM 0.684
 ABS @ 750NM + ACID 0.351
 ABS @ 664NM + ACID 0.59

 Volume of Extract--V1 (L): 0.0083
 Vol. of water filtered -- V2 (L): 0.062
 Light Path Length--L (cm): 1

 Chlorophyll a in ug: 2.5E-01
 Number of Slides: 2
 Area of Slides in m^2: 0.0038
 Chlorophyll a in ug/m^2: 65.34

 Growth rate (1/day): 0.36
 Growth corrected for photoper: 0.59

 Water Temperature 20.7
 Max Water Temperature 22.5
 WTCF 0.89
 Growth corrected for Temp 0.66

Lac Court Oreilles Periphyton Computations

Sampler Location: P-8
Week # 1 Julian Day
 Date of Installation: 07/23/96 205
 Date of Collection: 08/02/96 215
 Photoperiod 0.58
Spectrophotometer Data:
 ABS. @ 750NM 0.165
 ABS @ 664NM 0.374
 ABS @ 750NM + ACID 0.106
 ABS @ 664NM + ACID 0.24
 Volume of Extract--V1 (L): 0.008
 Vol. of water filtered -- V2 (L): 0.084
 Light Path Length--L (cm): 1
 Chlorophyll a in ug: 1.6E-02
 Number of Slides: 2
 Area of Slides in m^2: 0.0038
Chlorophyll a in ug/m^2: 4.22
 Growth rate (1/day): 0.14
 Growth corrected for photoper: 0.25
 Water Temperature 22.5
 Max Water Temperature 24.1
 WTCF 0.90
 Growth corrected for Temp 0.27

$Chl\ a\ (ug) = (26.7(664BA-665AA) \cdot V1) / L$
 Where:
 664BA = Before Acid Absorbancy at 664 NM - Before Acid Absorbancy at 750 NM
 665 AA = After Acid Absorbancy at 665 NM - After Acid Absorbancy at 750 NM
 V1 = Volume of Extract in L
 V2 = Volume of water filtered (L)
 L = Light Path Length (cm)

Lac Court Oreilles Periphyton Computations

Sampler Location: P-8
Week # 2 Julian Day
 Date of Installation: 07/23/96 205
 Date of Collection: 08/09/96 222
 Photoperiod 0.55
Spectrophotometer Data:
 ABS. @ 750NM 0.666
 ABS @ 664NM 1.06
 ABS @ 750NM + ACID 0.347
 ABS @ 664NM + ACID 0.608
 Volume of Extract--V1 (L): 0.0091
 Vol. of water filtered -- V2 (L): 0.058
 Light Path Length--L (cm): 1
 Chlorophyll a in ug: 3.2E-02
 Number of Slides: 2
 Area of Slides in m^2: 0.0038
Chlorophyll a in ug/m^2: 8.50
 Growth rate (1/day): 0.10
 Growth corrected for photoper: 0.18
 Water Temperature 22.5
 Max Water Temperature 24.1
 WTCF 0.90
Growth corrected for Temp 0.20

Lac Court Oreilles Periphyton Computations

Sampler Location: P-8
Week # 3 Julian Day
 Date of Installation: 07/23/96 205
 Date of Collection: 08/16/96 229
 Photoperiod 0.53
Spectrophotometer Data:
 ABS. @ 750NM 0.157
 ABS @ 664NM 0.211
 ABS @ 750NM + ACID 0.372
 ABS @ 664NM + ACID 0.428
 Volume of Extract--V1 (L): 0.0086
 Vol. of water filtered -- V2 (L): 0.04
 Light Path Length--L (cm): 1
 Chlorophyll a in ug: -4.6E-04
 Number of Slides: 2
 Area of Slides in m^2: 0.0038
Chlorophyll a in ug/m^2: -0.12
 Growth rate (1/day): ERR
 Growth corrected for photoper: ERR
 Water Temperature
 Max Water Temperature
 WTCF ERR
 Growth corrected for Temp ERR

Lac Court Oreilles Periphyton Computations

Sampler Location: P-8
Week # 4 Julian Day
 Date of Installation: 07/23/96 205
 Date of Collection: 08/26/96 239
 Photoperiod 0.50
Spectrophotometer Data:
 ABS. @ 750NM 0.009
 ABS @ 664NM 0.071
 ABS @ 750NM + ACID 0.154
 ABS @ 664NM + ACID 0.221
 Volume of Extract--V1 (L): 0.009
 Vol. of water filtered -- V2 (L): 0.077
 Light Path Length--L (cm): 1
 Chlorophyll a in ug: -1.2E-03
 Number of Slides: 2
 Area of Slides in m^2: 0.0038
Chlorophyll a in ug/m^2: -0.32
 Growth rate (1/day): ERR
 Growth corrected for photoper: ERR
 Water Temperature
 Max Water Temperature
 WTCF ERR
 Growth corrected for Temp ERR

Lac Court Oreilles Periphyton Computations

Sampler Location: P-8
 Week # 1 Julian Day
 Date of Installation: 09/06/96 250
 Date of Collection: 09/16/96 260
 Photoperiod 0.40

Spectrophotometer Data:
 ABS. @ 750NM 0.024
 ABS @ 664NM 0.036
 ABS @ 750NM + ACID 0.036
 ABS @ 664NM + ACID 0.047

Volume of Extract--V1 (L): 0.009
 Vol. of water filtered -- V2 (L): 0.028
 Light Path Length--L (cm): 1

Chlorophyll a in ug: 2.4E-04
 Number of Slides: 2
 Area of Slides in m^2: 0.0038
 Chlorophyll a in ug/m^2: 0.06

Growth rate (1/day): -0.28
 Growth corrected for photoper: -0.69

Water Temperature
 Max Water Temperature
 WTCF 1.00
 Growth corrected for Temp -0.69

Chl a (ug) = (26.7(664BA-665AA)*V1)/L
 Where:
 664BA = Before Acid Absorbancy at 664 NM - Before Acid Absorbancy at 750 NM
 665 AA = After Acid Absorbancy at 665 NM - After Acid Absorbancy at 750 NM
 V1 = Volume of Extract in L
 V2 = Volume of water filtered (L)
 L = Light Path Length (cm)

Lac Court Oreilles Periphyton Computations

Sampler Location: P-8
 Week # 2 Julian Day
 Date of Installation: 09/06/96 250
 Date of Collection: 09/24/96 268
 Photoperiod 0.36

Spectrophotometer Data:
 ABS. @ 750NM 0.109
 ABS @ 664NM 0.18
 ABS @ 750NM + ACID 0.122
 ABS @ 664NM + ACID 0.172

Volume of Extract--V1 (L): 0.009
 Vol. of water filtered -- V2 (L): 0.039
 Light Path Length--L (cm): 1

Chlorophyll a in ug: 5.0E-03
 Number of Slides: 2
 Area of Slides in m^2: 0.0038
 Chlorophyll a in ug/m^2: 1.33

Growth rate (1/day): 0.38
 Growth corrected for photoper: 1.07

Water Temperature 18.7
 Max Water Temperature 24.1
 WTCF 0.71
 Growth corrected for Temp 1.51

Lac Court Oreilles Periphyton Computations

Sampler Location: P-8
 Week # 3 Julian Day
 Date of Installation: 09/06/96 250
 Date of Collection: 10/08/96 282
 Photoperiod 0.30

Spectrophotometer Data:
 ABS. @ 750NM 0.014
 ABS @ 664NM 0.105
 ABS @ 750NM + ACID 0.035
 ABS @ 664NM + ACID 0.11

Volume of Extract--V1 (L): 0.009
 Vol. of water filtered -- V2 (L): 0.04
 Light Path Length--L (cm): 1

Chlorophyll a in ug: 3.8E-03
 Number of Slides: 2
 Area of Slides in m^2: 0.0038
 Chlorophyll a in ug/m^2: 1.01

Growth rate (1/day): -0.02
 Growth corrected for photoper: -0.06

Water Temperature
 Max Water Temperature
 WTCF 1.00
 Growth corrected for Temp -0.06

Lac Court Oreilles Periphyton Computations

Sampler Location: P-8
 Week # 4 Julian Day
 Date of Installation: 09/06/96 250
 Date of Collection: 10/22/96 296
 Photoperiod 0.24

Spectrophotometer Data:
 ABS. @ 750NM 0.011
 ABS @ 664NM 0.145
 ABS @ 750NM + ACID 0.099
 ABS @ 664NM + ACID 0.196

Volume of Extract--V1 (L): 0.009
 Vol. of water filtered -- V2 (L): 0.023
 Light Path Length--L (cm): 1

Chlorophyll a in ug: 8.9E-03
 Number of Slides: 2
 Area of Slides in m^2: 0.0038
 Chlorophyll a in ug/m^2: 2.34

Growth rate (1/day): 0.06
 Growth corrected for photoper: 0.25

Water Temperature 13.7
 Max Water Temperature 24.1
 WTCF 0.51
 Growth corrected for Temp 0.49

Lac Court Oreilles Periphyton Computations

Sampler Location: P-9
Week # 1 Julian Day
 Date of Installation: 05/20/96 141
 Date of Collection: 05/28/96 149
 Photoperiod 0.61

 Vol. of water filtered -- V2 (L): 0.189
 Chlorophyll a in ug/L: [REDACTED]
 Chlorophyll a in ug: 0.00
 Number of Slides: 2
 Area of Slides in m²: 0.0038
 Chlorophyll a in ug/m²: 0.00

 Growth rate (1/day): ERR
 Growth corrected for photoper: ERR

 Water Temperature [REDACTED]
 Max Water Temperature [REDACTED]
 WTCF ERR
 Growth corrected for Temp ERR

Lac Court Oreilles Periphyton Computations

Sampler Location: P-9
Week # 2 Julian Day
 Date of Installation: 05/20/96 141
 Date of Collection: 06/03/96 155
 Photoperiod 0.62

 Vol. of water filtered -- V2 (L): 0.176
 Chlorophyll a in ug/L: 958
 Chlorophyll a in ug: 168.61
 Number of Slides: 2
 Area of Slides in m²: 0.0038
 Chlorophyll a in ug/m²: 44370.53

 Growth rate (1/day): ERR
 Growth corrected for photoper: ERR

 Water Temperature [REDACTED]
 Max Water Temperature [REDACTED]
 WTCF ERR
 Growth corrected for Temp ERR

Lac Court Oreilles Periphyton Computations

Sampler Location: P-9
Week # 3 Julian Day
 Date of Installation: 05/20/96 141
 Date of Collection: 06/10/96 162
 Photoperiod 0.63

 Vol. of water filtered -- V2 (L): 0.13
 Chlorophyll a in ug/L: 1761
 Chlorophyll a in ug: 228.93
 Number of Slides: 2
 Area of Slides in m²: 0.0038
 Chlorophyll a in ug/m²: 60244.74

 Growth rate (1/day): 0.04
 Growth corrected for photoper: 0.07

 Water Temperature 13.8
 Max Water Temperature 24.1
 WTCF 0.52
 Growth corrected for Temp 0.13

Lac Court Oreilles Periphyton Computations

Sampler Location: P-9
Week # 4 Julian Day
 Date of Installation: 05/20/96 141
 Date of Collection: 06/17/96 169
 Photoperiod 0.64

 Vol. of water filtered -- V2 (L): 0.062
 Chlorophyll a in ug/L: 2862
 Chlorophyll a in ug: 177.44
 Number of Slides: 2
 Area of Slides in m²: 0.0038
 Chlorophyll a in ug/m²: 46695.79

 Growth rate (1/day): -0.04
 Growth corrected for photoper: -0.06

 Water Temperature [REDACTED]
 Max Water Temperature [REDACTED]
 WTCF 1.00
 Growth corrected for Temp -0.06

Lac Court Oreilles Periphyton Computations

Lac Court Oreilles Periphyton Computations

Lac Court Oreilles Periphyton Computations

Lac Court Oreilles Periphyton Computations

Sampler Location: P-9

Week # **1** Julian Day
 Date of Installation: 06/18/96 170
 Date of Collection: 06/27/96 179
 Photoperiod 0.64

Spectrophotometer Data:
 ABS. @ 750NM 0.915
 ABS @ 664NM 1.46
 ABS @ 750NM + ACID 0.614
 ABS @ 664NM + ACID 0.915

Volume of Extract--V1 (L): 0.0095
 Vol. of water filtered -- V2 (L): 0.077
 Light Path Length--L (cm): 1

Chlorophyll a in ug: 6.2E-02
 Number of Slides: 2
 Area of Slides in m^2: 0.0038
 Chlorophyll a in ug/m^2: 16.29

Growth rate (1/day): 0.31
 Growth corrected for photoper: 0.48

Water Temperature 19.8
 Max Water Temperature 24.1
 WTCF 0.76
 Growth corrected for Temp 0.64

Sampler Location: P-9

Week # **2** Julian Day
 Date of Installation: 06/18/96 170
 Date of Collection: 07/03/96 185
 Photoperiod 0.64

Spectrophotometer Data:
 ABS. @ 750NM 0.698
 ABS @ 664NM 1.44
 ABS @ 750NM + ACID 0.835
 ABS @ 664NM + ACID 1.2

Volume of Extract--V1 (L): 0.009
 Vol. of water filtered -- V2 (L): 0.143
 Light Path Length--L (cm): 1

Chlorophyll a in ug: 9.1E-02
 Number of Slides: 2
 Area of Slides in m^2: 0.0038
 Chlorophyll a in ug/m^2: 23.84

Growth rate (1/day): 0.06
 Growth corrected for photoper: 0.10

Water Temperature
 Max Water Temperature
 WTCF 1.00
 Growth corrected for Temp 0.10

Sampler Location: P-9

Week # **3** Julian Day
 Date of Installation: 06/18/96 170
 Date of Collection: 07/10/96 192
 Photoperiod 0.63

Spectrophotometer Data:
 ABS. @ 750NM 0.985
 ABS @ 664NM 1.66
 ABS @ 750NM + ACID 1.18
 ABS @ 664NM + ACID 1.5

Volume of Extract--V1 (L): 0.0088
 Vol. of water filtered -- V2 (L): 0.094
 Light Path Length--L (cm): 1

Chlorophyll a in ug: 8.3E-02
 Number of Slides: 2
 Area of Slides in m^2: 0.0038
 Chlorophyll a in ug/m^2: 21.95

Growth rate (1/day): -0.01
 Growth corrected for photoper: -0.02

Water Temperature
 Max Water Temperature
 WTCF 1.00
 Growth corrected for Temp -0.02

Sampler Location: P-9

Week # **4** Julian Day
 Date of Installation: 06/18/96 170
 Date of Collection: 07/16/96 198
 Photoperiod 0.62

Spectrophotometer Data:
 ABS. @ 750NM 1.83
 ABS @ 664NM 1.8
 ABS @ 750NM + ACID 1.56
 ABS @ 664NM + ACID 1.6

Volume of Extract--V1 (L): 0.0089
 Vol. of water filtered -- V2 (L): 0.068
 Light Path Length--L (cm): 1

Chlorophyll a in ug: 1.0E-01
 Number of Slides: 2
 Area of Slides in m^2: 0.0038
 Chlorophyll a in ug/m^2: 26.89

Growth rate (1/day): 0.03
 Growth corrected for photoper: 0.05

Water Temperature 19
 Max Water Temperature 24.1
 WTCF 0.72
 Growth corrected for Temp 0.08

Chl a (ug) = (26.7(664BA-665AA)*V1)/L
 Where:
 664BA = Before Acid Absorbancy at 664 NM - Before Acid Absorbancy at 750 NM
 665 AA = After Acid Absorbancy at 665 NM - After Acid Absorbancy at 750 NM
 V1 = Volume of Extract in L
 V2 = Volume of water filtered (L)
 L = Light Path Length (cm)

Lac Court Oreilles Periphyton Computations

Sampler Location: P-9

Week # 1 Julian Day
 Date of Installation: 07/23/96 205
 Date of Collection: 08/02/96 215
 Photoperiod 0.58

Spectrophotometer Data:
 ABS. @ 750NM 0.464
 ABS @ 664NM 0.845
 ABS @ 750NM + ACID 0.302
 ABS @ 664NM + ACID 0.45

Volume of Extract--V1 (L): 0.009
 Vol. of water filtered -- V2 (L): 0.063
 Light Path Length--L (cm): 1

Chlorophyll a in ug: 5.6E-02
 Number of Slides: 2
 Area of Slides in m^2: 0.0038
 Chlorophyll a in ug/m^2: 14.73

Growth rate (1/day): 0.27
 Growth corrected for photoper: 0.46

Water Temperature 21.6
 Max Water Temperature 22.5
 WTCF 0.94
 Growth corrected for Temp 0.49

Chl a (ug) = (26.7(664BA-665AA)*V1)/L
 Where:
 664BA = Before Acid Absorbancy at 664 NM - Before Acid Absorbancy at 750 NM
 665 AA = After Acid Absorbancy at 665 NM - After Acid Absorbancy at 750 NM
 V1 = Volume of Extract in L
 V2 = Volume of water filtered (L)
 L = Light Path Length (cm)

Lac Court Oreilles Periphyton Computations

Sampler Location: P-9

Week # 2 Julian Day
 Date of Installation: 07/23/96 205
 Date of Collection: 08/09/96 222
 Photoperiod 0.55

Spectrophotometer Data:
 ABS. @ 750NM 0.638
 ABS @ 664NM 1.38
 ABS @ 750NM + ACID 0.875
 ABS @ 664NM + ACID 1.23

Volume of Extract--V1 (L): 0.0091
 Vol. of water filtered -- V2 (L): 0.09
 Light Path Length--L (cm): 1

Chlorophyll a in ug: 9.4E-02
 Number of Slides: 2
 Area of Slides in m^2: 0.0038
 Chlorophyll a in ug/m^2: 24.74

Growth rate (1/day): 0.07
 Growth corrected for photoper: 0.13

Water Temperature 21
 Max Water Temperature 24.1
 WTCF 0.82
 Growth corrected for Temp 0.16

Lac Court Oreilles Periphyton Computations

Sampler Location: P-9

Week # 3 Julian Day
 Date of Installation: 07/23/96 205
 Date of Collection: 08/16/96 229
 Photoperiod 0.53

Spectrophotometer Data:
 ABS. @ 750NM 0.004
 ABS @ 664NM 0.59
 ABS @ 750NM + ACID 0.087
 ABS @ 664NM + ACID 0.53

Volume of Extract--V1 (L): 0.009
 Vol. of water filtered -- V2 (L): 0.051
 Light Path Length--L (cm): 1

Chlorophyll a in ug: 3.4E-02
 Number of Slides: 2
 Area of Slides in m^2: 0.0038
 Chlorophyll a in ug/m^2: 9.04

Growth rate (1/day): -0.14
 Growth corrected for photoper: -0.27

Water Temperature
 Max Water Temperature
 WTCF 1.00
 Growth corrected for Temp -0.27

Lac Court Oreilles Periphyton Computations

Sampler Location: P-9

Week # 4 Julian Day
 Date of Installation: 07/23/96 205
 Date of Collection: 08/26/96 239
 Photoperiod 0.50

Spectrophotometer Data:
 ABS. @ 750NM 0.026
 ABS @ 664NM 1.015
 ABS @ 750NM + ACID 0.092
 ABS @ 664NM + ACID 0.825

Volume of Extract--V1 (L): 0.009
 Vol. of water filtered -- V2 (L): 0.108
 Light Path Length--L (cm): 1

Chlorophyll a in ug: 6.2E-02
 Number of Slides: 2
 Area of Slides in m^2: 0.0038
 Chlorophyll a in ug/m^2: 16.19

Growth rate (1/day): 0.06
 Growth corrected for photoper: 0.12

Water Temperature 22.5
 Max Water Temperature 24.1
 WTCF 0.90
 Growth corrected for Temp 0.13

Lac Court Oreilles Periphyton Computations

Sampler Location: P-9
Week # 1 Julian Day
 Date of Installation: 09/06/96 250
 Date of Collection: 09/16/96 260
 Photoperiod 0.40
Spectrophotometer Data:
 ABS. @ 750NM 0.025
 ABS @ 664NM 0.125
 ABS @ 750NM + ACID 0.043
 ABS @ 664NM + ACID 0.112
 Volume of Extract--V1 (L): 0.009
 Vol. of water filtered -- V2 (L): 0.024
 Light Path Length--L (cm): 1
 Chlorophyll a in ug: 7.4E-03
 Number of Slides: 2
 Area of Slides in m^2: 0.0038
Chlorophyll a in ug/m^2: 1.96
 Growth rate (1/day): 0.07
 Growth corrected for photoper: 0.17
 Water Temperature
 Max Water Temperature
 WTCF 1.00
 Growth corrected for Temp 0.17

$Chl\ a\ (ug) = (26.7(664BA-665AA) * V1) / L$
 Where:
 664BA = Before Acid Absorbancy at 664 NM - Before Acid Absorbancy at 750 NM
 665 AA = After Acid Absorbancy at 665 NM - After Acid Absorbancy at 750 NM
 V1 = Volume of Extract in L
 V2 = Volume of water filtered (L)
 L = Light Path Length (cm)

Lac Court Oreilles Periphyton Computations

Sampler Location: P-9
Week # 2 Julian Day
 Date of Installation: 09/06/96 250
 Date of Collection: 09/24/96 268
 Photoperiod 0.36
Spectrophotometer Data:
 ABS. @ 750NM 0.006
 ABS @ 664NM 0.373
 ABS @ 750NM + ACID 0.017
 ABS @ 664NM + ACID 0.279
 Volume of Extract--V1 (L): 0.009
 Vol. of water filtered -- V2 (L): 0.036
 Light Path Length--L (cm): 1
 Chlorophyll a in ug: 2.5E-02
 Number of Slides: 2
 Area of Slides in m^2: 0.0038
Chlorophyll a in ug/m^2: 6.64
 Growth rate (1/day): 0.15
 Growth corrected for photoper: 0.43
 Water Temperature 18.5
 Max Water Temperature 24.1
 WTCF 0.70
Growth corrected for Temp 0.61

Lac Court Oreilles Periphyton Computations

Sampler Location: P-9
Week # 3 Julian Day
 Date of Installation: 09/06/96 250
 Date of Collection: 10/08/96 282
 Photoperiod 0.30
Spectrophotometer Data:
 ABS. @ 750NM 0.166
 ABS @ 664NM 0.59
 ABS @ 750NM + ACID 0.175
 ABS @ 664NM + ACID 0.478
 Volume of Extract--V1 (L): 0.009
 Vol. of water filtered -- V2 (L): 0.039
 Light Path Length--L (cm): 1
 Chlorophyll a in ug: 2.9E-02
 Number of Slides: 2
 Area of Slides in m^2: 0.0038
Chlorophyll a in ug/m^2: 7.65
 Growth rate (1/day): 0.01
 Growth corrected for photoper: 0.03
 Water Temperature
 Max Water Temperature
 WTCF 1.00
 Growth corrected for Temp 0.03

Lac Court Oreilles Periphyton Computations

Sampler Location: P-9
Week # 4 Julian Day
 Date of Installation: 09/06/96 250
 Date of Collection: 10/22/96 296
 Photoperiod 0.24
Spectrophotometer Data:
 ABS. @ 750NM 0.024
 ABS @ 664NM 0.256
 ABS @ 750NM + ACID 0.087
 ABS @ 664NM + ACID 0.269
 Volume of Extract--V1 (L): 0.009
 Vol. of water filtered -- V2 (L): 0.026
 Light Path Length--L (cm): 1
 Chlorophyll a in ug: 1.2E-02
 Number of Slides: 2
 Area of Slides in m^2: 0.0038
Chlorophyll a in ug/m^2: 3.16
 Growth rate (1/day): -0.06
 Growth corrected for photoper: -0.26
 Water Temperature
 Max Water Temperature
 WTCF 1.00
 Growth corrected for Temp -0.26

Lac Court Oreilles Periphyton Computations

Sampler Location: P-10
Week # 1 Julian Day
 Date of Installation: 05/21/96 142
 Date of Collection: 05/28/96 149
 Photoperiod 0.61

Spectrophotometer Data:
 ABS. @ 750NM 0.121
 ABS @ 664NM 0.766
 ABS @ 750NM + ACID 0.38
 ABS @ 664NM + ACID 0.186

Volume of Extract--V1 (L): 0.009
 Vol. of water filtered -- V2 (L): 0.168
 Light Path Length--L (cm): 1

Chlorophyll a in ug: 2.0E-01
 Number of Slides: 2
 Area of Slides in m^2: 0.0038
 Chlorophyll a in ug/m^2: 53.06

Growth rate (1/day): 0.57
 Growth corrected for photoper: 0.93

Water Temperature 14.6
 Max Water Temperature 24.1
 WTCF 0.54
 Growth corrected for Temp 1.70

Chl a (ug) = (26.7(664BA-665AA)*V1)/L
 Where:
 664BA = Before Acid Absorbancy at 664 NM - Before Acid Absorbancy at 750 NM
 665 AA = After Acid Absorbancy at 665 NM - After Acid Absorbancy at 750 NM
 V1 = Volume of Extract in L
 V2 = Volume of water filtered (L)
 L = Light Path Length (cm)

Lac Court Oreilles Periphyton Computations

Sampler Location: P-10
Week # 2 Julian Day
 Date of Installation: 05/21/96 142
 Date of Collection: 06/03/96 155
 Photoperiod 0.62

Spectrophotometer Data:
 ABS. @ 750NM 0.498
 ABS @ 664NM 1.15
 ABS @ 750NM + ACID 0.636
 ABS @ 664NM + ACID 0.955

Volume of Extract--V1 (L): 0.0084
 Vol. of water filtered -- V2 (L): 0.186
 Light Path Length--L (cm): 1

Chlorophyll a in ug: 7.5E-02
 Number of Slides: 2
 Area of Slides in m^2: 0.0038
 Chlorophyll a in ug/m^2: 19.65

Growth rate (1/day): -0.17
 Growth corrected for photoper: -0.27

Water Temperature
 Max Water Temperature
 WTCF 1.00
 Growth corrected for Temp -0.27

Lac Court Oreilles Periphyton Computations

Sampler Location: P-10
Week # 3 Julian Day
 Date of Installation: 05/21/96 142
 Date of Collection: 06/10/96 162
 Photoperiod 0.63

Spectrophotometer Data:
 ABS. @ 750NM 1.85
 ABS @ 664NM 1.999
 ABS @ 750NM + ACID 1.9
 ABS @ 664NM + ACID 1.999

Volume of Extract--V1 (L): 0.0079
 Vol. of water filtered -- V2 (L): 0.2
 Light Path Length--L (cm): 1

Chlorophyll a in ug: 1.1E-02
 Number of Slides: 2
 Area of Slides in m^2: 0.0038
 Chlorophyll a in ug/m^2: 2.78

Growth rate (1/day): -0.28
 Growth corrected for photoper: -0.44

Water Temperature
 Max Water Temperature
 WTCF 1.00
 Growth corrected for Temp -0.44

Lac Court Oreilles Periphyton Computations

Sampler Location: P-10
Week # 4 Julian Day
 Date of Installation: 05/21/96 142
 Date of Collection: 06/17/96 169
 Photoperiod 0.64

Spectrophotometer Data:
 ABS. @ 750NM 0.614
 ABS @ 664NM 1.29
 ABS @ 750NM + ACID 0.81
 ABS @ 664NM + ACID 1.17

Volume of Extract--V1 (L): 0.0084
 Vol. of water filtered -- V2 (L): 0.086
 Light Path Length--L (cm): 1

Chlorophyll a in ug: 7.1E-02
 Number of Slides: 2
 Area of Slides in m^2: 0.0038
 Chlorophyll a in ug/m^2: 18.65

Growth rate (1/day): 0.27
 Growth corrected for photoper: 0.43

Water Temperature
 Max Water Temperature
 WTCF 1.00
 Growth corrected for Temp 0.43

Lac Court Oreilles Periphyton Computations

Lac Court Oreilles Periphyton Computations

Lac Court Oreilles Periphyton Computations

Lac Court Oreilles Periphyton Computations

Sampler Location: P-10

Sampler Location: P-10

Sampler Location: P-10

Sampler Location: P-10

Week # 1 Julian Day
 Date of Installation: 06/19/96 171
 Date of Collection: 06/27/96 179
 Photoperiod 0.64

Week # 2 Julian Day
 Date of Installation: 06/19/96 171
 Date of Collection: 07/03/96 185
 Photoperiod 0.64

Week # 3 Julian Day
 Date of Installation: 06/19/96 171
 Date of Collection: 07/10/96 192
 Photoperiod 0.63

Week # 4 Julian Day
 Date of Installation: 06/19/96 171
 Date of Collection: 07/16/97 563
 Photoperiod 0.10

Spectrophotometer Data:
 ABS. @ 750NM 0.121
 ABS @ 664NM 0.598
 ABS @ 750NM + ACID 0.152
 ABS @ 664NM + ACID 0.341

Spectrophotometer Data:
 ABS. @ 750NM 0.444
 ABS @ 664NM 0.875
 ABS @ 750NM + ACID 0.273
 ABS @ 664NM + ACID 0.46

Spectrophotometer Data:
 ABS. @ 750NM 0.53
 ABS @ 664NM 1.12
 ABS @ 750NM + ACID 0.55
 ABS @ 664NM + ACID 0.83

Spectrophotometer Data:
 ABS. @ 750NM 0.486
 ABS @ 664NM 1.12
 ABS @ 750NM + ACID 0.506
 ABS @ 664NM + ACID 0.794

Volume of Extract--V1 (L): 0.0095
 Vol. of water filtered -- V2 (L): 0.114
 Light Path Length--L (cm): 1

Volume of Extract--V1 (L): 0.0088
 Vol. of water filtered -- V2 (L): 0.15
 Light Path Length--L (cm): 1

Volume of Extract--V1 (L): 0.0088
 Vol. of water filtered -- V2 (L): 0.107
 Light Path Length--L (cm): 1

Volume of Extract--V1 (L): 0.0082
 Vol. of water filtered -- V2 (L): 0.156
 Light Path Length--L (cm): 1

Chlorophyll a in ug: 7.3E-02
 Number of Slides: 2
 Area of Slides in m^2: 0.0038
 Chlorophyll a in ug/m^2: 19.22

Chlorophyll a in ug: 5.7E-02
 Number of Slides: 2
 Area of Slides in m^2: 0.0038
 Chlorophyll a in ug/m^2: 15.09

Chlorophyll a in ug: 7.3E-02
 Number of Slides: 2
 Area of Slides in m^2: 0.0038
 Chlorophyll a in ug/m^2: 19.17

Chlorophyll a in ug: 7.6E-02
 Number of Slides: 2
 Area of Slides in m^2: 0.0038
 Chlorophyll a in ug/m^2: 19.94

Growth rate (1/day): 0.37
 Growth corrected for photoper: 0.58

Growth rate (1/day): -0.04
 Growth corrected for photoper: -0.06

Growth rate (1/day): 0.03
 Growth corrected for photoper: 0.05

Growth rate (1/day): 0.00
 Growth corrected for photoper: 0.00

Water Temperature 18.3
 Max Water Temperature 24.1
 WTCF 0.69
 Growth corrected for Temp 0.84

Water Temperature
 Max Water Temperature
 WTCF 1.00
 Growth corrected for Temp -0.06

Water Temperature
 Max Water Temperature
 WTCF 1.00
 Growth corrected for Temp 0.05

Water Temperature
 Max Water Temperature
 WTCF 1.00
 Growth corrected for Temp 0.00

Chl a (ug) = (26.7(664BA-665AA)*V1)/L
 Where:
 664BA = Before Acid Absorbancy at 664 NM - Before Acid Absorbancy at 750 NM
 665 AA = After Acid Absorbancy at 665 NM - After Acid Absorbancy at 750 NM
 V1 = Volume of Extract in L
 V2 = Volume of water filtered (L)
 L = Light Path Length (cm)

Lac Court Oreilles Periphyton Computations

Sampler Location: P-10

Week # **1** Julian Day
 Date of Installation: **07/23/96** 205
 Date of Collection: **08/02/96** 215
 Photoperiod 0.58

Spectrophotometer Data:
 ABS. @ 750NM 0.364
 ABS @ 664NM 0.815
 ABS @ 750NM + ACID 0.289
 ABS @ 664NM + ACID 0.502

Volume of Extract--V1 (L): 0.009
 Vol. of water filtered -- V2 (L): 0.131
 Light Path Length--L (cm): 1

Chlorophyll a in ug: 5.7E-02
 Number of Slides: 2
 Area of Slides in m^2: 0.0038
 Chlorophyll a in ug/m^2: 15.05

Growth rate (1/day): 0.27
 Growth corrected for photoper: 0.47

Water Temperature 22.5
 Max Water Temperature 24.1
 WTCF 0.90
 Growth corrected for Temp 0.52

Chi a (ug) = (26.7(664BA-665AA)*V1)/L
 Where:
 664BA = Before Acid Absorbancy at 664 NM - Before Acid Absorbancy at 750 NM
 665 AA = After Acid Absorbancy at 665 NM - After Acid Absorbancy at 750 NM
 V1 = Volume of Extract in L
 V2 = Volume of water filtered (L)
 L = Light Path Length (cm)

Lac Court Oreilles Periphyton Computations

Sampler Location: P-10

Week # **2** Julian Day
 Date of Installation: **07/23/96** 205
 Date of Collection: **08/09/96** 222
 Photoperiod 0.55

Spectrophotometer Data:
 ABS. @ 750NM 0.355
 ABS @ 664NM 0.905
 ABS @ 750NM + ACID 0.402
 ABS @ 664NM + ACID 0.65

Volume of Extract--V1 (L): 0.0098
 Vol. of water filtered -- V2 (L): 0.102
 Light Path Length--L (cm): 1

Chlorophyll a in ug: 7.9E-02
 Number of Slides: 2
 Area of Slides in m^2: 0.0038
 Chlorophyll a in ug/m^2: 20.80

Growth rate (1/day): 0.05
 Growth corrected for photoper: 0.08

Water Temperature
 Max Water Temperature
 WTCF 1.00
 Growth corrected for Temp 0.08

Lac Court Oreilles Periphyton Computations

Sampler Location: P-10

Week # **3** Julian Day
 Date of Installation: **07/23/96** 205
 Date of Collection: **08/16/96** 229
 Photoperiod 0.53

Spectrophotometer Data:
 ABS. @ 750NM 0.014
 ABS @ 664NM 0.336
 ABS @ 750NM + ACID 0.046
 ABS @ 664NM + ACID 0.292

Volume of Extract--V1 (L): 0.0087
 Vol. of water filtered -- V2 (L): 0.073
 Light Path Length--L (cm): 1

Chlorophyll a in ug: 1.8E-02
 Number of Slides: 2
 Area of Slides in m^2: 0.0038
 Chlorophyll a in ug/m^2: 4.65

Growth rate (1/day): -0.21
 Growth corrected for photoper: -0.40

Water Temperature
 Max Water Temperature
 WTCF 1.00
 Growth corrected for Temp -0.40

Lac Court Oreilles Periphyton Computations

Sampler Location: P-10

Week # **4** Julian Day
 Date of Installation: **07/23/96** 205
 Date of Collection: **08/26/96** 239
 Photoperiod 0.50

Spectrophotometer Data:
 ABS. @ 750NM 0.043
 ABS @ 664NM 0.58
 ABS @ 750NM + ACID 0.106
 ABS @ 664NM + ACID 0.52

Volume of Extract--V1 (L): 0.009
 Vol. of water filtered -- V2 (L): 0.049
 Light Path Length--L (cm): 1

Chlorophyll a in ug: 3.0E-02
 Number of Slides: 2
 Area of Slides in m^2: 0.0038
 Chlorophyll a in ug/m^2: 7.78

Growth rate (1/day): 0.05
 Growth corrected for photoper: 0.10

Water Temperature
 Max Water Temperature
 WTCF 1.00
 Growth corrected for Temp 0.10

Lac Court Oreilles Periphyton Computations

Sampler Location: P-10
 Week # 1 Julian Day
 Date of Installation: 09/06/96 250
 Date of Collection: 09/16/96 260
 Photoperiod 0.40

Spectrophotometer Data:
 ABS. @ 750NM 0.014
 ABS @ 664NM 0.045
 ABS @ 750NM + ACID 0.037
 ABS @ 664NM + ACID 0.063

Volume of Extract--V1 (L): 0.009
 Vol. of water filtered -- V2 (L): 0.029
 Light Path Length--L (cm): 1

Chlorophyll a in ug: 1.2E-03
 Number of Slides: 2
 Area of Slides in m^2: 0.0038
 Chlorophyll a in ug/m^2: 0.32

Growth rate (1/day): -0.12
 Growth corrected for photoper: -0.29

Water Temperature
 Max Water Temperature
 WTCF 1.00
 Growth corrected for Temp -0.29

Chl a (ug) = (26.7(664BA-665AA)*V1)/L
 Where:
 664BA = Before Acid Absorbancy at 664 NM - Before Acid Absorbancy at 750 NM
 665 AA = After Acid Absorbancy at 665 NM - After Acid Absorbancy at 750 NM
 V1 = Volume of Extract in L
 V2 = Volume of water filtered (L)
 L = Light Path Length (cm)

Lac Court Oreilles Periphyton Computations

Sampler Location: P-10
 Week # 2 Julian Day
 Date of Installation: 09/06/96 250
 Date of Collection: 09/24/96 268
 Photoperiod 0.36

Spectrophotometer Data:
 ABS. @ 750NM 0.018
 ABS @ 664NM 0.095
 ABS @ 750NM + ACID 0.019
 ABS @ 664NM + ACID 0.081

Volume of Extract--V1 (L): 0.009
 Vol. of water filtered -- V2 (L): 0.056
 Light Path Length--L (cm): 1

Chlorophyll a in ug: 3.6E-03
 Number of Slides: 2
 Area of Slides in m^2: 0.0038
 Chlorophyll a in ug/m^2: 0.95

Growth rate (1/day): 0.14
 Growth corrected for photoper: 0.39

Water Temperature
 Max Water Temperature
 WTCF 1.00
 Growth corrected for Temp 0.39

Lac Court Oreilles Periphyton Computations

Sampler Location: P-10
 Week # 3 Julian Day
 Date of Installation: 09/06/96 250
 Date of Collection: 10/08/96 282
 Photoperiod 0.30

Spectrophotometer Data:
 ABS. @ 750NM 0.009
 ABS @ 664NM 0.115
 ABS @ 750NM + ACID 0.033
 ABS @ 664NM + ACID 0.116

Volume of Extract--V1 (L): 0.009
 Vol. of water filtered -- V2 (L): 0.066
 Light Path Length--L (cm): 1

Chlorophyll a in ug: 5.5E-03
 Number of Slides: 2
 Area of Slides in m^2: 0.0038
 Chlorophyll a in ug/m^2: 1.45

Growth rate (1/day): 0.03
 Growth corrected for photoper: 0.10

Water Temperature
 Max Water Temperature
 WTCF 1.00
 Growth corrected for Temp 0.10

Lac Court Oreilles Periphyton Computations

Sampler Location: P-10
 Week # 4 Julian Day
 Date of Installation: 09/06/96 250
 Date of Collection: 10/22/96 296
 Photoperiod 0.24

Spectrophotometer Data:
 ABS. @ 750NM 0.022
 ABS @ 664NM 0.279
 ABS @ 750NM + ACID 0.098
 ABS @ 664NM + ACID 0.296

Volume of Extract--V1 (L): 0.009
 Vol. of water filtered -- V2 (L): 0.029
 Light Path Length--L (cm): 1

Chlorophyll a in ug: 1.4E-02
 Number of Slides: 2
 Area of Slides in m^2: 0.0038
 Chlorophyll a in ug/m^2: 3.73

Growth rate (1/day): 0.07
 Growth corrected for photoper: 0.28

Water Temperature 13.4
 Max Water Temperature 24.1
 WTCF 0.50
 Growth corrected for Temp 0.56

Lac Court Oreilles Periphyton Computations

Sampler Location: P-11
 Week # 1 Julian Day
 Date of Installation: 05/21/96 142
 Date of Collection: 05/28/96 149
 Photoperiod 0.61

Spectrophotometer Data:
 ABS. @ 750NM 0.031
 ABS @ 664NM 0.13
 ABS @ 750NM + ACID 0.039
 ABS @ 664NM + ACID 0.067

Volume of Extract--V1 (L): 0.0088
 Vol. of water filtered -- V2 (L): 0.162
 Light Path Length--L (cm): 1

Chlorophyll a in ug: 1.7E-02
 Number of Slides: 2
 Area of Slides in m^2: 0.0038
 Chlorophyll a in ug/m^2: 4.39

Growth rate (1/day): 0.21
 Growth corrected for photoper: 0.35

Water Temperature
 Max Water Temperature
 WTCF 1.00
 Growth corrected for Temp 0.35

Chl a (ug) = (26.7(664BA-665AA)*V1)/L
 Where:
 664BA = Before Acid Absorancy at 664 NM - Before Acid Absorbancy at 750 NM
 665 AA = After Acid Absorbancy at 665 NM - After Acid Absorbancy at 750 NM
 V1 = Volume of Extract in L
 V2 = Volume of water filtered (L)
 L = Light Path Length (cm)

Lac Court Oreilles Periphyton Computations

Sampler Location: P-11
 Week # 2 Julian Day
 Date of Installation: 05/21/96 142
 Date of Collection: 06/03/96 155
 Photoperiod 0.62

Spectrophotometer Data:
 ABS. @ 750NM 0.248
 ABS @ 664NM 0.552
 ABS @ 750NM + ACID 0.314
 ABS @ 664NM + ACID 0.472

Volume of Extract--V1 (L): 0.0088
 Vol. of water filtered -- V2 (L): 0.098
 Light Path Length--L (cm): 1

Chlorophyll a in ug: 3.4E-02
 Number of Slides: 2
 Area of Slides in m^2: 0.0038
 Chlorophyll a in ug/m^2: 9.03

Growth rate (1/day): 0.12
 Growth corrected for photoper: 0.19

Water Temperature
 Max Water Temperature
 WTCF 1.00
 Growth corrected for Temp 0.19

Lac Court Oreilles Periphyton Computations

Sampler Location: P-11
 Week # 3 Julian Day
 Date of Installation: 05/21/96 142
 Date of Collection: 06/10/96 162
 Photoperiod 0.63

Spectrophotometer Data:
 ABS. @ 750NM 0.472
 ABS @ 664NM 1.07
 ABS @ 750NM + ACID 0.614
 ABS @ 664NM + ACID 0.935

Volume of Extract--V1 (L): 0.0088
 Vol. of water filtered -- V2 (L): 0.11
 Light Path Length--L (cm): 1

Chlorophyll a in ug: 6.4E-02
 Number of Slides: 2
 Area of Slides in m^2: 0.0038
 Chlorophyll a in ug/m^2: 16.74

Growth rate (1/day): 0.09
 Growth corrected for photoper: 0.14

Water Temperature 14.9
 Max Water Temperature 24.1
 WTCF 0.56
 Growth corrected for Temp 0.25

Lac Court Oreilles Periphyton Computations

Sampler Location: P-11
 Week # 4 Julian Day
 Date of Installation: 05/21/96 142
 Date of Collection: 06/17/96 169
 Photoperiod 0.64

Spectrophotometer Data:
 ABS. @ 750NM 0.177
 ABS @ 664NM 0.402
 ABS @ 750NM + ACID 0.244
 ABS @ 664NM + ACID 0.341

Volume of Extract--V1 (L): 0.0088
 Vol. of water filtered -- V2 (L): 0.096
 Light Path Length--L (cm): 1

Chlorophyll a in ug: 3.0E-02
 Number of Slides: 2
 Area of Slides in m^2: 0.0038
 Chlorophyll a in ug/m^2: 7.91

Growth rate (1/day): -0.11
 Growth corrected for photoper: -0.17

Water Temperature
 Max Water Temperature
 WTCF 1.00
 Growth corrected for Temp -0.17

Lac Court Oreilles Periphyton Computations

Sampler Location: P-11
 Week # 1 Julian Day
 Date of Installation: 06/19/96 171
 Date of Collection: 06/27/96 179
 Photoperiod 0.64

Spectrophotometer Data:
 ABS. @ 750NM 0.044
 ABS @ 664NM 0.119
 ABS @ 750NM + ACID 0.052
 ABS @ 664NM + ACID 0.087

Volume of Extract--V1 (L): 0.0093
 Vol. of water filtered -- V2 (L): 0.033
 Light Path Length--L (cm): 1

Chlorophyll a in ug: 9.9E-03
 Number of Slides: 2
 Area of Slides in m^2: 0.0038
 Chlorophyll a in ug/m^2: 2.61

Growth rate (1/day): 0.12
 Growth corrected for photoper: 0.19

Water Temperature
 Max Water Temperature
 WTCF 1.00
 Growth corrected for Temp 0.19

Chl a (ug) = (26.7(664BA-665AA)*V1)/L
 Where:
 664BA = Before Acid Absorancy at 664 NM - Before Acid Absorbancy at 750 NM
 665 AA = After Acid Absorbancy at 665 NM - After Acid Absorbancy at 750 NM
 V1 = Volume of Extract in L
 V2 = Volume of water filtered (L)
 L = Light Path Length (cm)

Lac Court Oreilles Periphyton Computations

Sampler Location: P-11
 Week # 2 Julian Day
 Date of Installation: 06/19/96 171
 Date of Collection: 07/03/96 185
 Photoperiod 0.64

Spectrophotometer Data:
 ABS. @ 750NM 0.193
 ABS @ 664NM 0.488
 ABS @ 750NM + ACID 0.278
 ABS @ 664NM + ACID 0.482

Volume of Extract--V1 (L): 0.0092
 Vol. of water filtered -- V2 (L): 0.07
 Light Path Length--L (cm): 1

Chlorophyll a in ug: 2.2E-02
 Number of Slides: 2
 Area of Slides in m^2: 0.0038
 Chlorophyll a in ug/m^2: 5.88

Growth rate (1/day): 0.14
 Growth corrected for photoper: 0.21

Water Temperature
 Max Water Temperature
 WTCF 1.00
 Growth corrected for Temp 0.21

Lac Court Oreilles Periphyton Computations

Sampler Location: P-11
 Week # 3 Julian Day
 Date of Installation: 06/19/96 171
 Date of Collection: 07/10/96 192
 Photoperiod 0.63

Spectrophotometer Data:
 ABS. @ 750NM 0.334
 ABS @ 664NM 0.825
 ABS @ 750NM + ACID 0.452
 ABS @ 664NM + ACID 0.742

Volume of Extract--V1 (L): 0.0092
 Vol. of water filtered -- V2 (L): 0.103
 Light Path Length--L (cm): 1

Chlorophyll a in ug: 4.9E-02
 Number of Slides: 2
 Area of Slides in m^2: 0.0038
 Chlorophyll a in ug/m^2: 12.99

Growth rate (1/day): 0.11
 Growth corrected for photoper: 0.18

Water Temperature 21.2
 Max Water Temperature 24.1
 WTCF 0.83
 Growth corrected for Temp 0.22

Lac Court Oreilles Periphyton Computations

Sampler Location: P-11
 Week # 4 Julian Day
 Date of Installation: 06/19/96 171
 Date of Collection: 07/16/96 198
 Photoperiod 0.62

Spectrophotometer Data:
 ABS. @ 750NM 0.284
 ABS @ 664NM 0.702
 ABS @ 750NM + ACID 0.398
 ABS @ 664NM + ACID 0.6

Volume of Extract--V1 (L): 0.0087
 Vol. of water filtered -- V2 (L): 0.056
 Light Path Length--L (cm): 1

Chlorophyll a in ug: 5.0E-02
 Number of Slides: 2
 Area of Slides in m^2: 0.0038
 Chlorophyll a in ug/m^2: 13.20

Growth rate (1/day): 0.00
 Growth corrected for photoper: 0.00

Water Temperature
 Max Water Temperature
 WTCF 1.00
 Growth corrected for Temp 0.00

Lac Court Oreilles Periphyton Computations

Sampler Location: P-11

Week # 1 Julian Day
 Date of Installation: 07/23/96 205
 Date of Collection: 08/02/96 215
 Photoperiod 0.58

Spectrophotometer Data:
 ABS. @ 750NM 0.412
 ABS @ 664NM 0.586
 ABS @ 750NM + ACID 0.091
 ABS @ 664NM + ACID 0.16

Volume of Extract--V1 (L): 0.0093
 Vol. of water filtered -- V2 (L): 0.057
 Light Path Length--L (cm): 1

Chlorophyll a in ug: 2.6E-02
 Number of Slides: 2
 Area of Slides in m^2: 0.0038
 Chlorophyll a in ug/m^2: 6.86

Growth rate (1/day): 0.19
 Growth corrected for photoper: 0.33

Water Temperature 22.5
 Max Water Temperature 24.1
 WTCF 0.90
 Growth corrected for Temp 0.37

Chl a (ug) = (26.7(664BA-665AA)*V1)/L
 Where:
 664BA = Before Acid Absorbancy at 664 NM - Before Acid Absorbancy at 750 NM
 665 AA = After Acid Absorbancy at 665 NM - After Acid Absorbancy at 750 NM
 V1 = Volume of Extract in L
 V2 = Volume of water filtered (L)
 L = Light Path Length (cm)

Lac Court Oreilles Periphyton Computations

Sampler Location: P-11

Week # 2 Julian Day
 Date of Installation: 07/23/96 205
 Date of Collection: 08/09/96 222
 Photoperiod 0.55

Spectrophotometer Data:
 ABS. @ 750NM 0.518
 ABS @ 664NM 0.708
 ABS @ 750NM + ACID 0.142
 ABS @ 664NM + ACID 0.234

Volume of Extract--V1 (L): 0.0092
 Vol. of water filtered -- V2 (L): 0.054
 Light Path Length--L (cm): 1

Chlorophyll a in ug: 2.4E-02
 Number of Slides: 1
 Area of Slides in m^2: 0.0019
 Chlorophyll a in ug/m^2: 12.67

Growth rate (1/day): 0.09
 Growth corrected for photoper: 0.16

Water Temperature
 Max Water Temperature
 WTCF 1.00
 Growth corrected for Temp 0.16

Lac Court Oreilles Periphyton Computations

Sampler Location: P-11

Week # 3 Julian Day
 Date of Installation: 07/23/96 205
 Date of Collection: 08/16/96 229
 Photoperiod 0.53

Spectrophotometer Data:
 ABS. @ 750NM 0.006
 ABS @ 664NM 0.083
 ABS @ 750NM + ACID 0.09
 ABS @ 664NM + ACID 0.169

Volume of Extract--V1 (L): 0.009
 Vol. of water filtered -- V2 (L): 0.018
 Light Path Length--L (cm): 1

Chlorophyll a in ug: -4.8E-04
 Number of Slides: 1
 Area of Slides in m^2: 0.0019
 Chlorophyll a in ug/m^2: -0.25

Growth rate (1/day): ERR
 Growth corrected for photoper: ERR

Water Temperature
 Max Water Temperature
 WTCF ERR
 Growth corrected for Temp ERR

Lac Court Oreilles Periphyton Computations

Sampler Location: P-11

Week # 4 Julian Day
 Date of Installation: 07/23/96 205
 Date of Collection: 08/26/96 239
 Photoperiod 0.50

Spectrophotometer Data:
 ABS. @ 750NM 0.08
 ABS @ 664NM 0.241
 ABS @ 750NM + ACID 0.22
 ABS @ 664NM + ACID 0.356

Volume of Extract--V1 (L): 0.009
 Vol. of water filtered -- V2 (L): 0.025
 Light Path Length--L (cm): 1

Chlorophyll a in ug: 6.0E-03
 Number of Slides: 1
 Area of Slides in m^2: 0.0019
 Chlorophyll a in ug/m^2: 3.16

Growth rate (1/day): ERR
 Growth corrected for photoper: ERR

Water Temperature
 Max Water Temperature
 WTCF ERR
 Growth corrected for Temp ERR

Lac Court Oreilles Periphyton Computations

Sampler Location: P-11
 Week # 1 Julian Day
 Date of Installation: 09/06/96 250
 Date of Collection: 09/16/96 260
 Photoperiod 0.40

Spectrophotometer Data:
 ABS. @ 750NM 0.013
 ABS @ 664NM 0.095
 ABS @ 750NM + ACID 0.034
 ABS @ 664NM + ACID 0.098

Volume of Extract--V1 (L): 0.009
 Vol. of water filtered -- V2 (L): 0.027
 Light Path Length--L (cm): 1

Chlorophyll a in ug: 4.3E-03
 Number of Slides: 2
 Area of Slides in m^2: 0.0038
 Chlorophyll a in ug/m^2: 1.14

Growth rate (1/day): 0.01
 Growth corrected for photoper: 0.03

Water Temperature
 Max Water Temperature
 WTCF 1.00
 Growth corrected for Temp 0.03

Chl a (ug) = (26.7(664BA-665AA)*V1)/L
 Where:
 664BA = Before Acid Absorancy at 664 NM - Before Acid Absorbancy at 750 NM
 665 AA = After Acid Absorbancy at 665 NM - After Acid Absorbancy at 750 NM
 V1 = Volume of Extract in L
 V2 = Volume of water filtered (L)
 L = Light Path Length (cm)

Lac Court Oreilles Periphyton Computations

Sampler Location: P-11
 Week # 2 Julian Day
 Date of Installation: 09/06/96 250
 Date of Collection: 09/24/96 268
 Photoperiod 0.36

Spectrophotometer Data:
 ABS. @ 750NM 0.015
 ABS @ 664NM 0.426
 ABS @ 750NM + ACID 0.027
 ABS @ 664NM + ACID 0.34

Volume of Extract--V1 (L): 0.009
 Vol. of water filtered -- V2 (L): 0.036
 Light Path Length--L (cm): 1

Chlorophyll a in ug: 2.4E-02
 Number of Slides: 2
 Area of Slides in m^2: 0.0038
 Chlorophyll a in ug/m^2: 6.20

Growth rate (1/day): 0.21
 Growth corrected for photoper: 0.59

Water Temperature 18.7
 Max Water Temperature 24.1
 WTCF 0.71
 Growth corrected for Temp 0.84

Lac Court Oreilles Periphyton Computations

Sampler Location: P-11
 Week # 3 Julian Day
 Date of Installation: 09/06/96 250
 Date of Collection: 10/08/96 282
 Photoperiod 0.30

Spectrophotometer Data:
 ABS. @ 750NM 0.019
 ABS @ 664NM 1.42
 ABS @ 750NM + ACID 0.037
 ABS @ 664NM + ACID 1.26

Volume of Extract--V1 (L): 0.009
 Vol. of water filtered -- V2 (L): 0.029
 Light Path Length--L (cm): 1

Chlorophyll a in ug: 4.3E-02
 Number of Slides: 2
 Area of Slides in m^2: 0.0038
 Chlorophyll a in ug/m^2: 11.26

Growth rate (1/day): 0.04
 Growth corrected for photoper: 0.14

Water Temperature
 Max Water Temperature
 WTCF 1.00
 Growth corrected for Temp 0.14

Lac Court Oreilles Periphyton Computations

Sampler Location: P-11
 Week # 4 Julian Day
 Date of Installation: 09/06/96 250
 Date of Collection: 10/22/96 296
 Photoperiod 0.24

Spectrophotometer Data:
 ABS. @ 750NM 0.044
 ABS @ 664NM 1.44
 ABS @ 750NM + ACID 0.127
 ABS @ 664NM + ACID 1.31

Volume of Extract--V1 (L): 0.009
 Vol. of water filtered -- V2 (L): 0.029
 Light Path Length--L (cm): 1

Chlorophyll a in ug: 5.1E-02
 Number of Slides: 2
 Area of Slides in m^2: 0.0038
 Chlorophyll a in ug/m^2: 13.47

Growth rate (1/day): 0.01
 Growth corrected for photoper: 0.05

Water Temperature
 Max Water Temperature
 WTCF 1.00
 Growth corrected for Temp 0.05

Periphyton Data Summary -- Lac Courte Oreilles -- 1996

Maximum Growth Rate for each monthly period (day -1)

Station	Date	Photoperiod	Corrected Growth Rate (day -1)	u max @24.1 C	u/umax	Estimated SRP
P-1	6/18-6/27	0.64	0.29	3.97	0.07	0.55
	7/23-8/2	0.58	0.43	3.97	0.11	0.85
	9/6-9/24	0.36	1.03	3.97	0.26	2.45
P-2	5/21-6/3	0.62	2.05	3.97	0.52	7.47
	6/18-7/3	0.64	0.50	3.97	0.13	1.01
	7/23-8/2	0.58	0.59	3.97	0.15	1.22
P-3	9/6-10/8	0.3	0.66	3.97	0.17	1.40
	5/21-6/3	0.62	1.01	3.97	0.25	2.39
	6/18-6/27	0.64	0.52	3.97	0.13	1.05
P-4	7/23-8/9	0.55	0.35	3.97	0.09	0.68
	9/6-10/8	0.3	0.88	3.97	0.22	1.99
	5/21-6/17	0.64	0.25	3.97	0.06	0.47
P-5	6/18-6/27	0.64	0.40	3.97	0.10	0.78
	7/23-8/3	0.55	0.37	3.97	0.09	0.72
	9/6-10/22	0.24	1.67	3.97	0.42	5.08
P-6	5/21-6/10	0.63	1.32	3.97	0.33	3.49
P-7	8/2-8/9	0.55	0.43	3.97	0.11	0.85
	9/6-9/24	0.36	0.77	3.97	0.19	1.68
P-8	8/2-8/9	0.55	0.43	3.97	0.11	0.85
	9/6-10/22	0.24	0.19	3.97	0.05	0.35
	5/21-6/10	0.63	0.69	3.97	0.17	1.47
P-9	6/18-7/16	0.62	0.66	3.97	0.17	1.40
	7/23-8/2	0.58	0.27	3.97	0.07	0.51
	9/6-9/24	0.36	1.51	3.97	0.38	4.30
P-10	5/20-6/10	0.63	0.13	3.97	0.03	0.24
	6/18-6/27	0.62	0.64	3.97	0.16	1.35
	7/23-8/9	0.5	0.16	3.97	0.04	0.29
P-11	9/6-9/24	0.36	0.61	3.97	0.15	1.27
	5/21-5/28	0.61	1.70	3.97	0.43	5.24
	6/19-6/27	0.64	0.84	3.97	0.21	1.88
P-11	7/23-8/2	0.58	0.52	3.97	0.13	1.05
	9/6-10/22	0.24	0.56	3.97	0.14	1.15
	5/21-6/10	0.63	0.25	3.97	0.06	0.47
P-11	6/19-7/10	0.63	0.22	3.97	0.06	0.41
	7/23-8/2	0.58	0.37	3.97	0.09	0.72
	9/6-9/24	0.36	0.84	3.97	0.21	1.88

*Corrected for Photoperiod and Temperature

Appendix C

Inflow and Outflow Data

Lac Court Oreilles Inflow/Outflow Data Summary
Total Phosphorus (mg/L)

Location	05/20/96	05/28/96	06/04/96	06/19/96	07/03/96	07/18/96	08/02/96	08/26/96	09/16/96	09/24/96	10/08/96	10/24/96	11/04/96
INFLOW:													
I-1, Grindstone Creek	n/a	0.012	0.010	0.009	0.011	n/a	n/a	0.010	0.011	0.010	0.012		
I-5, Ring Lake Creek	n/a	0.044	0.024	0.030	n/a	0.030	n/a	0.023	n/a	n/a	n/a	n/a	n/a
I-8, Whitefish Creek	n/a	0.014	0.027	0.010	0.014	n/a	n/a	0.010	0.009	0.010	0.010		
I-9, Ghost Creek	0.045	n/a	0.034	0.060	0.048	n/a	0.050	0.044	0.042	n/a	0.026		
I-11, Squaw Lake Creek	n/a	n/a	n/a	n/a	0.020	0.025	0.013	n/a	0.011	n/a	0.010		
OUTFLOW:													
COR-OUT,													
Lac Courte Oreilles Outlet	n/a	0.013	n/a	n/a	< 0.007	n/a	0.008	n/a	0.008	n/a	0.010		

Appendix D

Stream Staff Gage Measurements

1996 Inflow Level Staff Gauge, and Total Phosphorus Data

	SITE: I-1			SITE: I-5			SITE: I-8			SITE: I-9		
	Staff			Staff			Staff			Staff		
06/29/96										2.35		
06/30/96										2.36		
07/01/96				0.96						2.31		
07/02/96				1.08						2.32		
07/03/96	1.04	38.660	0.011	1.08	n/a	n/a	1.24	44.154	0.014	2.34	ND	0.048
07/04/96				0.82						2.30		
07/05/96				0.68						2.31		
07/06/96				0.67						2.33		
07/07/96				0.98						2.38		
07/08/96				0.98						2.33		
07/09/96				0.96						2.30		
07/10/96				0.88								
07/11/96				0.88								
07/12/96				0.89						2.26		
07/13/96				0.87						2.26		
07/14/96										2.25		
07/15/96				0.81						2.24		
07/16/96	0.90			0.85			1.14			2.23		
07/17/96				0.76						2.21		
07/18/96	0.95	59.956	n/a	0.88	ND	0.030	1.18	44.074	n/a	2.30	ND	n/a
07/19/96				0.77						2.29		
07/20/96				0.76						2.29		
07/21/96				0.78						2.28		
07/22/96				0.68						2.30		
07/23/96				0.71						2.30		
07/24/96				0.81						2.30		
07/25/96				0.78						2.30		
07/26/96				0.75						2.29		
07/27/96				0.75						2.28		
07/28/96				0.79						2.34		
07/29/96				0.80						2.30		
07/30/96				0.79								
07/31/96				0.78						2.28		
08/01/96				0.76						2.27		
08/02/96	0.95	45.365	n/a	0.73	n/a	n/a	1.12	29.053	n/a	2.27	ND	0.050
08/03/96				0.75						2.25		
08/04/96				0.75						2.24		
08/05/96				0.75						2.26		
08/06/96				0.75						2.24		
08/07/96				0.78								
08/08/96				0.75						2.26		
08/09/96				0.75						2.22		

LAC COURTE OREILLES WATER QUALITY DATA

1996 Inflow Level Staff Gauge, and Total Phosphorus Data

SITE: I-1				SITE: I-5			SITE: I-8			SITE: I-9		
Staff				Staff			Staff			Staff		
08/10/96				0.74								
08/11/96				0.74						2.22		
08/12/96				0.74						2.22		
08/13/96				0.72								
08/14/96				0.72								
08/15/96				0.71								
08/16/96												
08/17/96				0.66								
08/18/96				0.66								
08/19/96				0.66								
08/20/96				0.72								
08/21/96				0.72								
08/22/96				0.75						2.25		
08/23/96				0.75						2.26		
08/24/96				0.75						2.26		
08/25/96				0.75						2.26		
08/26/96	0.82	46.155	0.010	0.76	0.340	0.023	0.96	17.282	0.010	2.15	0.577	0.044
08/27/96				0.76						2.25		
08/28/96				0.76						2.24		
08/29/96				0.76						2.23		
08/30/96				0.76						2.22		
08/31/96				0.75						2.21		
09/01/96				0.73						2.21		
09/02/96				0.73						2.21		
09/03/96				0.74						2.22		
09/04/96				0.75						2.24		
09/05/96				0.71						2.22		
09/06/96				0.72						2.20		
09/07/96				0.72						2.16		
09/08/96				0.80						2.16		
09/09/96				0.82						2.10		
09/10/96				0.78						2.06		
09/11/96				0.75						2.04		
09/12/96				0.75						2.01		
09/13/96				0.75						2.00		
09/14/96				0.75								
09/15/96				0.76						2.08		
09/16/96	0.67	34.126	0.011	0.76	n/a	n/a	0.80	10.875	0.009	2.08	0.570	0.042
09/17/96				0.76						2.04		
09/18/96				0.77						2.04		
09/19/96												
09/20/96										2.03		

LAC COURTE OREILLES WATER QUALITY DATA

1996 Inflow Level Staff Gauge, and Total Phosphorus Data

	SITE: I-1			SITE: I-5			SITE: I-8			SITE: I-9		
	Staff			Staff			Staff			Staff		
09/21/96										2.01		
09/22/96										2.02		
09/23/96										2.02		
09/24/96	0.57	26.741	0.010	n/a	n/a		0.90	10.931	0.010			n/a
09/25/96												
09/26/96												
09/27/96												
09/28/96				0.70								
09/29/96				0.64								
09/30/96				0.64						2.06		
10/01/96												
10/02/96												
10/03/96												
10/04/96												
10/05/96												
10/06/96												
10/07/96										2.02		
10/08/96	0.37	23.244	0.012	n/a	n/a		0.87	6.970	0.010	2.01	0.381	0.026
10/09/96										2.02		
10/10/96										2.02		
10/11/96										2.02		
10/12/96										2.02		
10/13/96										2.02		
10/14/96										2.01		
10/15/96										2.01		
10/16/96										2.00		
10/17/96										1.90		
10/18/96												
10/19/96												
10/20/96												
10/21/96												
10/22/96												
10/23/96												
10/24/96	0.55	32.951	n/a	n/a	n/a		0.76	16.203	n/a	2.09	2.275	n/a
10/25/96										2.09		
10/26/96										2.10		
10/27/96												
10/28/96										2.14		
10/29/96												
10/30/96										2.19		
10/31/96												
11/01/96												

LAC COURTE OUELLES WATER QUALITY DATA

1996 Inflow Level Staff Gauge, and Total Phosphorus Data

	SITE: I-1			SITE: I-5			SITE: I-8			SITE: I-9		
	Staff			Staff			Staff			Staff		
11/02/96												
11/03/96												
11/04/96	0.55	28.721	n/a	n/a	n/a		0.86	21.741	n/a	2.08	0.984	n/a
11/05/96												
11/06/96												
11/07/96												
11/08/96												
11/09/96												
11/10/96												
11/11/96												
11/12/96												
11/13/96												
11/14/96												
11/15/96												
11/16/96												
11/17/96												
11/18/96												
11/19/96												
11/20/96												
11/21/96												
11/22/96												
11/23/96												
11/24/96												
11/25/96												
11/26/96												
11/27/96												
11/28/96												
11/29/96												
11/30/96												
12/01/96												
12/02/96												
12/03/96												
12/04/96												
12/05/96												
12/06/96												
12/07/96												
12/08/96												
12/09/96												
12/10/96												
12/11/96												
12/12/96												
12/13/96												

MAC COURTE OREILL'S WATER QUALITY DATA

1996 Inflow Level Staff Gauge, and Total Phosphorus Data

	SITE: I-1	SITE: I-5	SITE: I-8	SITE: I-9
	Staff	Staff	Staff	Staff
12/14/96				
12/15/96				
12/16/96				
12/17/96				
12/18/96				
12/19/96				
12/20/96				
12/21/96				
12/22/96				
12/23/96				
12/24/96				
12/25/96				
12/26/96				
12/27/96				
12/28/96				
12/29/96				
12/30/96				
12/31/96				

LAC COURTE OREILLES WATER QUALITY DATA

1996 Outflow Level Staff Gauge, and Total Phosphorus Data

SITE: COR-OUT

Date	Staff Gauge (M)	Outflow (cfs)	TP (mg/L)
05/20/96			
05/21/96			
05/22/96			
05/23/96			
05/24/96			
05/25/96			
05/26/96			
05/27/96			
05/28/96	0.54	209.469	0.013
05/29/96			
05/30/96			
05/31/96	0.52		
06/01/96			
06/02/96			
06/03/96			
06/04/96	0.53		
06/05/96	0.53		
06/06/96	0.53		
06/07/96			
06/08/96			
06/09/96			
06/10/96	0.49		
06/11/96	0.49		
06/12/96			
06/13/96			
06/14/96			
06/15/96			
06/16/96			
06/17/96	0.49		
06/18/96			
06/19/96	0.49	217.519	n/a
06/20/96			
06/21/96			
06/22/96			
06/23/96			
06/24/96			
06/25/96	0.47		
06/26/96			
06/27/96	0.51		
06/28/96			

1996 Outflow Level Staff Gauge, and Total Phosphorus Data

SITE: COR-OUT			
	Staff		
06/29/96			
06/30/96			
07/01/96			
07/02/96			
07/03/96	0.52	142.753	<.007
07/04/96			
07/05/96			
07/06/96			
07/07/96			
07/08/96			
07/09/96			
07/10/96			
07/11/96			
07/12/96			
07/13/96			
07/14/96			
07/15/96			
07/16/96			
07/17/96			
07/18/96	0.52	156.185	n/a
07/19/96			
07/20/96			
07/21/96			
07/22/96			
07/23/96			
07/24/96			
07/25/96			
07/26/96			
07/27/96			
07/28/96			
07/29/96			
07/30/96			
07/31/96			
08/01/96			
08/02/96	0.49	118.626	0.008
08/03/96			
08/04/96			
08/05/96			
08/06/96			
08/07/96			
08/08/96			
08/09/96			

LAC COURTE OREILLES WATER QUALITY DATA

1996 Outflow Level Staff Gauge, and Total Phosphorus Data

SITE: COR-OUT

	Staff		
08/10/96			
08/11/96			
08/12/96			
08/13/96			
08/14/96			
08/15/96			
08/16/96			
08/17/96			
08/18/96			
08/19/96			
08/20/96			
08/21/96			
08/22/96			
08/23/96			
08/24/96			
08/25/96			
08/26/96			
08/27/96			
08/28/96			
08/29/96			
08/30/96			
08/31/96			
09/01/96			
09/02/96			
09/03/96			
09/04/96			
09/05/96			
09/06/96			
09/07/96			
09/08/96			
09/09/96			
09/10/96			
09/11/96			
09/12/96			
09/13/96			
09/14/96			
09/15/96			
09/16/96	0.40	119.714	0.008
09/17/96			
09/18/96			
09/19/96			
09/20/96			

1996 Outflow Level Staff Gauge, and Total Phosphorus Data

SITE: COR-OUT

	Staff		
09/21/96			
09/22/96			
09/23/96			
09/24/96			
09/25/96			
09/26/96			
09/27/96			
09/28/96			
09/29/96			
09/30/96			
10/01/96			
10/02/96			
10/03/96			
10/04/96			
10/05/96			
10/06/96			
10/07/96			
10/08/96	0.33	88.788	0.01
10/09/96			
10/10/96			
10/11/96			
10/12/96			
10/13/96			
10/14/96			
10/15/96			
10/16/96			
10/17/96			
10/18/96			
10/19/96			
10/20/96			
10/21/96			
10/22/96			
10/23/96			
10/24/96			
10/25/96			
10/26/96			
10/27/96			
10/28/96			
10/29/96			
10/30/96			
10/31/96			
11/01/96			

LAC COURTE OREILLES WATER QUALITY DATA

1996 Outflow Level Staff Gauge, and Total Phosphorus Data

SITE: COR-OUT

	Staff		
11/02/96			
11/03/96			
11/04/96	0.38	86.514	n/a
11/05/96			
11/06/96			
11/07/96			
11/08/96			
11/09/96			
11/10/96			
11/11/96			
11/12/96			
11/13/96			
11/14/96			
11/15/96			
11/16/96			
11/17/96			
11/18/96			
11/19/96			
11/20/96			
11/21/96			
11/22/96			
11/23/96			
11/24/96			
11/25/96			
11/26/96			
11/27/96			
11/28/96			
11/29/96			
11/30/96			
12/01/96			
12/02/96			
12/03/96			
12/04/96			
12/05/96			
12/06/96			
12/07/96			
12/08/96			
12/09/96			
12/10/96			
12/11/96			
12/12/96			
12/13/96			

1996 Outflow Level Staff Gauge, and Total Phosphorus Data

SITE: COR-OUT

	Staff
12/14/96	
12/15/96	
12/16/96	
12/17/96	
12/18/96	
12/19/96	
12/20/96	
12/21/96	
12/22/96	
12/23/96	
12/24/96	
12/25/96	
12/26/96	
12/27/96	
12/28/96	
12/29/96	
12/30/96	
12/31/96	

GAGE LOCATION:

I-10, PHILLIP J. NIES

MONTH: May	No gauge in place
Day	Gage Level (Ft.)
1	
2	
3	
4	
5	
6	
7	
8	
9	
10	
11	
12	
13	
14	
15	
16	
17	
18	
19	
20	
21	
22	
23	
24	
25	
26	
27	
28	
29	
30	
31	

1996 INFLOW STAFF GAGE READINGS--
LAC COURT OREILLES
WISCONSIN LAKE MANAGEMENT PROJECT

GAGE LOCATION: I-10, PHILLIP J. NIES

MONTH: June	No gauge in place
Day	Gage Level (Ft.)
1	
2	
3	
4	
5	
6	
7	
8	
9	
10	
11	
12	
13	
14	
15	
16	
17	
18	
19	
20	
21	
22	
23	
24	
25	
26	
27	
28	
29	
30	
31	

1996 INFLOW STAFF GAGE READINGS--
LAC COURT OREILLES
WISCONSIN LAKE MANAGEMENT PROJECT

GAGE LOCATION: I-10, PHILLIP J. NIES

MONTH: July	
Day	Gage Level (Ft.)
1	
2	
3	
4	
5	
6	
7	
8	
9	
10	7.20 2.18
11	7.23 2.19
12	7.21 2.18
13	7.18 2.18
14	7.19 2.18
15	7.18 2.18
16	7.18 2.18
17	7.16 2.17
18	7.22 2.19
19	7.22 2.19
20	7.22 2.19
21	7.20 2.18
22	7.23 2.19
23	7.23 2.19
24	7.25 2.20
25	7.28 2.21
26	7.23 2.19
27	7.20 2.18
28	7.22 2.19
29	7.34 2.22
30	7.24 2.19
31	7.19 2.18

1996 INFLOW STAFF GAGE READINGS--
 LAC COURT OREILLES
 WISCONSIN LAKE MANAGEMENT PROJECT

GAGE LOCATION: I-10, PHILLIP J. NIES

MONTH: August	
Day	Gage Level (Ft.) M
1	7.18 2.18
2	7.17 2.17
3	7.16 2.17
4	7.14 2.16
5	7.21 2.18
6	7.19 2.18
7	7.21 2.18
8	7.20 2.18
9	7.18 2.18
10	7.16 2.17
11	7.12 2.16
12	7.13 2.16
13	7.12 2.16
14	7.11 2.15
15	7.10 2.15
16	7.06 2.14
17	7.02 2.13
18	7.03 2.13
19	7.06 2.14
20	7.08 2.15
21	7.07 2.14
22	7.10 2.15
23	7.09 2.15
24	7.08 2.15
25	7.06 2.14
26	7.02 2.13
27	7.01 2.12
28	7.00 2.12
29	6.98 2.12
30	6.98 2.12
31	6.98 2.12

1996 INFLOW STAFF GAGE READINGS--
LAC COURT OREILLES
WISCONSIN LAKE MANAGEMENT PROJECT

GAGE LOCATION: I-10, PHILLIP J. NIES

MONTH: September	
Day	Gage Level (Ft.)
1	6.98
2	6.96
3	6.95
4	7.08
5	7.06
6	7.06
7	7.06
8	7.04
9	7.04
10	7.02
11	7.02
12	7.00
13	6.97
14	6.95
15	6.90
16	6.87
17	6.84
18	6.83
19	6.82
20	6.80
21	6.78
22	6.81
23	6.90
24	6.78
25	6.76
26	6.80
27	6.82
28	6.81
29	6.81
30	6.77

1996 INFLOW STAFF GAGE READINGS--
LAC COURT OREILLES
WISCONSIN LAKE MANAGEMENT PROJECT

GAGE LOCATION: I-10, PHILLIP J. NIES

MONTH: October	
Day	Gage Level (Ft.) <i>M</i>
1	6.76 2.05
2	6.76 2.05
3	6.74 2.04
4	6.72 2.04
5	6.71 2.03
6	6.69 2.03
7	6.67 2.03
8	6.65 2.02
9	6.64 2.01
10	6.61 2.00
11	6.58 1.99
12	6.57 1.99
13	6.57 1.99
14	6.57 1.99
15	6.58 1.99
16	6.58 1.99
17	6.69 2.03
18	6.70 2.03
19	
20	
21	
22	
23	
24	6.77 2.05
25	6.75 2.05
26	6.75 2.05
27	6.76 2.05
28	6.75 2.05
29	6.75 2.05
30	6.76 2.05
31	6.78 2.05

1996 INFLOW STAFF GAGE READINGS--
LAC COURT OREILLES
WISCONSIN LAKE MANAGEMENT PROJECT

GAGE LOCATION: I-10, PHILLIP J. NIES

MONTH: November	No readings taken
Day	Gage Level (Ft.)
1	
2	
3	
4	
5	
6	
7	
8	
9	
10	
11	
12	
13	
14	
15	
16	
17	
18	
19	
20	
21	
22	
23	
24	
25	
26	
27	
28	
29	
30	
31	

1996 OUTFLOW STAFF GAGE READINGS--
LAC COURT OREILLES
WISCONSIN LAKE MANAGEMENT PROJECT

Appendix E

Lake Level Data

Staffgagi Wb2

1996 LAKE LEVEL READINGS—
 LAC COURT OREILLES
 WISCONSIN LAKE MANAGEMENT PROJECT

MONTH: May		
Day	Gage 1 Lake Level (Ft.) M	Gage 2 Lake Level (Ft.) M
1		
2		
3		
4		
5		
6		
7		
8		
9		
10		
11		
12		
13		
14		
15		
16	1.26 .38	1.44 .44
17	1.27 .39	1.45 .44
18		
19	1.50 .45	1.68 .51
20	1.51 .46	1.69 .51
21	1.51 .46	1.69 .51
22	1.50 .45	1.68 .51
23		
24		
25	1.45 .44	1.63 .49
26	1.42 .43	1.60 .48
27	1.39 .42	1.57 .48
28	1.37 .42	1.55 .47
29	1.35 .41	1.53 .46
30	1.31 .40	1.49 .45
31		

Meter
 Conversions
 Entered only
 on STAFPREC

1996 LAKE LEVEL READINGS—
 LAC COURT OREILLES
 WISCONSIN LAKE MANAGEMENT PROJECT

MONTH: June		
Day	Gage 1	Gage 2
	Lake Level (Ft.) M	Lake Level (Ft.) M
1		
2	1.35 .41	1.54 .47
3	1.32 .40	1.51 .46
4	1.32 .40	1.51 .46
5		
6	1.29 .39	1.48 .45
7	1.27 .38	1.46 .44
8		
9	1.25 .38	1.44 .44
10	1.23 .37	1.42 .43
11	1.21 .37	1.40 .42
12		
13	1.20 .36	1.39 .42
14	1.20 .36	1.39 .42
15	1.12 .34	1.31 .40
16	1.12 .34	1.31 .40
17	1.15 .34	1.34 .41
18	1.17 .35	1.36 .41
19		
20	1.17 .35	1.36 .41
21	1.18 .35	1.37 .42
22	1.18 .35	1.37 .42
23		
24	1.17 .35	1.36 .41
25		
26	1.20 .36	1.39 .42
27		
28	1.26 .38	1.45 .44
29		
30	1.25 .38	1.44 .44
31		

1996 LAKE LEVEL READINGS--
 LAC COURT OREILLES
 WISCONSIN LAKE MANAGEMENT PROJECT

MONTH: July		
Day	Gage 1 Lake Level (Ft.) M	Gage 2 Lake Level (Ft.) M
1		
2	1.21 .37	1.39 .42
3		
4	1.20 .36	1.38 .42
5		
6	0.80 .24	0.90 .27
7		
8		
9	0.82 .25	0.92 .29
10		
11	0.80 .24	0.90 .27
12	0.75 .23	0.85 .26
13		
14	0.70 .21	0.80 .24
15		
16	0.69 .21	0.79 .24
17		
18		
19	0.79 .24	0.89 .27
20		
21	0.81 .25	0.91 .28
22		
23	0.80 .24	0.90 .27
24		
25		
26	0.79 .24	0.89 .27
27	0.78 .24	0.88 .27
28	0.80 .24	0.90 .27
29		
30	0.78 .24	0.88 .27
31		

1996 LAKE LEVEL READINGS--
 LAC COURT OREILLES
 WISCONSIN LAKE MANAGEMENT PROJECT

MONTH: August		
Day	Gage 1 Lake Level (Ft.) M	Gage 2 Lake Level (Ft.) M
1	0.77 .23	0.87 .26
2		
3	0.74 .22	0.84 .25
4		
5		
6	0.72 .22	0.82 .25
7		
8	0.70 .21	0.80 .24
9	0.69 .21	0.79 .24
10		
11	0.66 .20	0.76 .23
12		
13	0.64 .19	0.74 .22
14		
15	0.62 .19	0.72 .22
16		
17	0.60 .18	0.70 .21
18		
19	0.58 .18	0.68 .21
20		
21	0.62 .19	0.72 .22
22	0.65 .20	0.75 .23
23		
24	0.63 .19	0.63 .19
25		
26	0.59 .18	0.69 .21
27		
28	0.57 .17	0.67 .20
29	0.56 .17	0.66 .20
30	0.55 .17	0.65 .20
31		

1996 LAKE LEVEL READINGS--
 LAC COURT OREILLES
 WISCONSIN LAKE MANAGEMENT PROJECT

MONTH: September		
Day	Gage 1 Lake Level (Ft.)	Gage 2 Lake Level (Ft.)
1		
2		
3	0.58	0.68
4	0.66	0.76
5		
6		
7	0.63	0.73
8		
9	0.59	0.69
10		
11	0.56	0.66
12	0.56	0.66
13		
14	0.52	0.62
15		
16	0.45	0.55
17		
18	0.40	0.50
19		
20	0.36	0.46
21	0.35	0.45
22		
23	0.35	0.45
24		
25		
26	0.33	0.43
27		
28	0.31	0.41
29		
30	0.26	0.36

1996 LAKE LEVEL READINGS—
LAC COURT OREILLES
WISCONSIN LAKE MANAGEMENT PROJECT

MONTH: October		
Day	Gage 1 Lake Level (Ft.)	Gage 2 Lake Level (Ft.)
1		
2		
3		
4		
5		
6		
7		
8		
9		
10		
11		
12		
13		
14		
15		
16		
17		
18		
19		
20		
21		
22		
23		
24		
25		
26		
27		
28		
29		
30		
31		

1996 LAKE LEVEL READINGS--
 LAC COURT OREILLES
 WISCONSIN LAKE MANAGEMENT PROJECT

MONTH: November		
Day	Gage 1 Lake Level (Ft.)	Gage 2 Lake Level (Ft.)
1		
2		
3		
4		
5		
6		
7		
8		
9		
10		
11		
12		
13		
14		
15		
16		
17		
18		
19		
20		
21		
22		
23		
24		
25		
26		
27		
28		
29		
30		
31		

1996 INFLOW STAFF GAGE READINGS--
 LAC COURT OREILLES
 WISCONSIN LAKE MANAGEMENT PROJECT

Appendix F
Precipitation Data

**1996 PRECIPITATION DATA--
LAC COURT OREILLES
WISCONSIN LAKE MANAGEMENT PROJECT**

GAGE LOCATION:

Chicago Bay, Schroeder

MONTH: May		No readings taken
Day	Precipitation (Inches)	
1		
2		
3		
4		
5		
6		
7		
8		
9		
10		
11		
12		
13		
14		
15		
16		
17		
18		
19		
20		
21		
22		
23		
24		
25		
26		
27		
28		
29		
30		
31		

**1996 PRECIPITATION DATA--
LAC COURT OREILLES
WISCONSIN LAKE MANAGEMENT PROJECT**

GAGE LOCATION:

Chicago Bay, Schroeder

MONTH: June

Day	Precipitation (Inches)
1	1.00
2	0.10
3	0.10
4	0.00
5	0.00
6	
7	
8	
9	
10	
11	
12	0.00
13	0.00
14	0.00
15	0.15
16	1.60
17	
18	
19	
20	
21	
22	
23	
24	
25	0.00
26	1.50
27	0.00
28	0.00
29	0.10
30	0.00

**1996 PRECIPITATION DATA--
LAC COURT OREILLES
WISCONSIN LAKE MANAGEMENT PROJECT**

GAGE LOCATION: Chicago Bay, Schroeder

MONTH: July		No readings taken
Day	Precipitation (Inches)	
1		
2		
3		
4		
5		
6		
7		
8		
9		
10		
11		
12		
13		
14		
15		
16		
17		
18		
19		
20		
21		
22		
23		
24		
25		
26		
27		
28		
29		
30		
31		

**1996 PRECIPITATION DATA--
LAC COURT OREILLES
WISCONSIN LAKE MANAGEMENT PROJECT**

GAGE LOCATION:

Chicago Bay, Schroeder

MONTH: August		No readings taken
Day	Precipitation (Inches)	
1		
2		
3		
4		
5		
6		
7		
8		
9		
10		
11		
12		
13		
14		
15		
16		
17		
18		
19		
20		
21		
22		
23		
24		
25		
26		
27		
28		
29		
30		
31		

**1996 PRECIPITATION DATA--
LAC COURT OREILLES
WISCONSIN LAKE MANAGEMENT PROJECT**

GAGE LOCATION:

Chicago Bay, Schroeder

MONTH: September		No readings taken
Day	Precipitation (Inches)	
1		
2		
3		
4		
5		
6		
7		
8		
9		
10		
11		
12		
13		
14		
15		
16		
17		
18		
19		
20		
21		
22		
23		
24		
25		
26		
27		
28		
29		
30		

**1996 PRECIPITATION DATA--
LAC COURT OREILLES
WISCONSIN LAKE MANAGEMENT PROJECT**

GAGE LOCATION:

Chicago Bay, Schroeder

MONTH: October		No readings taken
Day	Precipitation (Inches)	
1		
2		
3		
4		
5		
6		
7		
8		
9		
10		
11		
12		
13		
14		
15		
16		
17		
18		
19		
20		
21		
22		
23		
24		
25		
26		
27		
28		
29		
30		
31		

**1996 PRECIPITATION DATA--
LAC COURT OREILLES
WISCONSIN LAKE MANAGEMENT PROJECT**

GAGE LOCATION: Chicago Bay, Schroeder

MONTH: November	No readings taken
Day	Precipitation (Inches)
1	
2	
3	
4	
5	
6	
7	
8	
9	
10	
11	
12	
13	
14	
15	
16	
17	
18	
19	
20	
21	
22	
23	
24	
25	
26	
27	
28	
29	
30	

**1996 PRECIPITATION DATA--
LAC COURT OREILLES
WISCONSIN LAKE MANAGEMENT PROJECT**

GAGE LOCATION:

Chicago Bay, Schroeder

MONTH: December	No readings taken
Day	Precipitation (Inches)
1	
2	
3	
4	
5	
6	
7	
8	
9	
10	
11	
12	
13	
14	
15	
16	
17	
18	
19	
20	
21	
22	
23	
24	
25	
26	
27	
28	
29	
30	
31	

1996 PRECIPITATION DATA--

LAC COURT OREILLES WISCONSIN LAKE MANAGEMENT PROJECT

GAGE LOCATION:

Musky Bay, Ormsby

MONTH: May	
Day	Precipitation (Inches)
1	0.00
2	0.00
3	0.00
4	0.00
5	0.00
6	0.00
7	0.00
8	0.00
9	0.00
10	0.00
11	0.00
12	0.00
13	0.00
14	0.00
15	0.00
16	0.00
17	0.00
18	0.00
19	0.00
20	0.00
21	0.00
22	0.00
23	0.00
24	0.00
25	0.00
26	0.00
27	0.00
28	0.00
29	0.00
30	0.00
31	0.00

**1996 PRECIPITATION DATA--
LAC COURT OREILLES
WISCONSIN LAKE MANAGEMENT PROJECT**

GAGE LOCATION:

Musky Bay, Ormsby

MONTH: June	
Day	Precipitation (Inches)
1	0.80
2	0.10
3	0.30
4	0.00
5	0.00
6	0.15
7	0.00
8	0.00
9	0.00
10	0.00
11	0.00
12	0.10
13	0.00
14	0.00
15	0.10
16	1.50
17	0.50
18	0.15
19	0.00
20	0.00
21	0.34
22	0.02
23	0.16
24	0.00
25	0.00
26	1.45
27	0.00
28	0.00
29	0.00
30	0.00

**1996 PRECIPITATION DATA--
LAC COURT OREILLES
WISCONSIN LAKE MANAGEMENT PROJECT**

GAGE LOCATION:

Musky Bay, Ormsby

MONTH: July	
Day	Precipitation (Inches)
1	0.00
2	0.00
3	0.00
4	0.00
5	0.00
6	0.00
7	0.88
8	0.11
9	0.00
10	0.00
11	0.14
12	0.26
13	0.00
14	0.06
15	0.20
16	0.00
17	0.00
18	1.05
19	0.00
20	0.03
21	0.00
22	0.00
23	0.38
24	0.54
25	0.02
26	0.00
27	0.42
28	0.00
29	0.04
30	0.02
31	0.00

**1996 PRECIPITATION DATA--
LAC COURT OREILLES
WISCONSIN LAKE MANAGEMENT PROJECT**

GAGE LOCATION: Musky Bay, Ormsby

MONTH: August

Day	Precipitation (Inches)
1	0.00
2	0.00
3	0.00
4	0.00
5	0.20
6	0.22
7	0.00
8	0.00
9	0.00
10	0.00
11	0.00
12	0.00
13	0.00
14	0.00
15	0.00
16	0.00
17	0.00
18	0.00
19	0.80
20	0.00
21	0.00
22	0.51
23	0.00
24	0.00
25	0.06
26	0.00
27	0.00
28	0.00
29	0.00
30	0.00
31	

**1996 PRECIPITATION DATA--
LAC COURT OREILLES
WISCONSIN LAKE MANAGEMENT PROJECT**

GAGE LOCATION:

Musky Bay, Ormsby

MONTH: September	
Day	Precipitation (Inches)
1	0.00
2	0.08
3	1.55
4	0.00
5	0.00
6	0.00
7	0.02
8	0.02
9	0.00
10	0.00
11	0.00
12	0.00
13	0.00
14	0.00
15	0.00
16	0.00
17	0.00
18	0.00
19	0.00
20	0.18
21	0.17
22	0.00
23	0.18
24	0.00
25	0.00
26	1.10
27	0.02
28	0.00
29	0.00
30	0.00

**1996 PRECIPITATION DATA--
LAC COURT OREILLES
WISCONSIN LAKE MANAGEMENT PROJECT**

GAGE LOCATION:

Musky Bay, Ormsby

MONTH: October	
Day	Precipitation (Inches)
1	0.00
2	0.00
3	0.00
4	0.00
5	0.00
6	0.00
7	0.00
8	0.00
9	0.00
10	0.00
11	0.00
12	0.00
13	0.00
14	0.00
15	0.12
16	1.25
17	0.22
18	0.00
19	0.00
20	0.06
21	0.00
22	1.20
23	0.42
24	0.00
25	0.00
26	0.00
27	0.00
28	0.00
29	0.00
30	1.00
31	0.00

**1996 PRECIPITATION DATA--
LAC COURT OREILLES
WISCONSIN LAKE MANAGEMENT PROJECT**

GAGE LOCATION:

Musky Bay, Ormsby

MONTH: November		No readings taken
Day	Precipitation (Inches)	
1		
2		
3		
4		
5		
6		
7		
8		
9		
10		
11		
12		
13		
14		
15		
16		
17		
18		
19		
20		
21		
22		
23		
24		
25		
26		
27		
28		
29		
30		

**1996 PRECIPITATION DATA--
LAC COURT OREILLES
WISCONSIN LAKE MANAGEMENT PROJECT**

GAGE LOCATION: Musky Bay, Ormsby

MONTH: December		No readings taken
Day	Precipitation (Inches)	
1		
2		
3		
4		
5		
6		
7		
8		
9		
10		
11		
12		
13		
14		
15		
16		
17		
18		
19		
20		
21		
22		
23		
24		
25		
26		
27		
28		
29		
30		
31		

1996 PRECIPITATION DATA--

LAC COURT OREILLES WISCONSIN LAKE MANAGEMENT PROJECT

GAGE LOCATION:

Ghost Creek, Pollock

MONTH: May	
Day	Precipitation (Inches)
1	
2	
3	
4	
5	
6	
7	
8	
9	0.00
10	0.00
11	0.00
12	0.00
13	0.00
14	0.22
15	0.00
16	0.00
17	0.23
18	2.40
19	
20	0.09
21	0.14
22	0.00
23	0.00
24	0.00
25	0.00
26	0.00
27	0.00
28	0.00
29	0.00
30	0.00
31	0.00

**1996 PRECIPITATION DATA--
LAC COURT OREILLES
WISCONSIN LAKE MANAGEMENT PROJECT**

GAGE LOCATION:

Ghost Creek, Pollock

MONTH: June	
Day	Precipitation (Inches)
1	0.88
2	0.03
3	0.10
4	0.00
5	0.16
6	0.00
7	0.00
8	0.00
9	0.00
10	0.00
11	0.00
12	0.00
13	0.00
14	0.00
15	0.08
16	1.25
17	1.04
18	
19	
20	0.00
21	0.28
22	0.00
23	0.16
24	0.00
25	1.51
26	0.00
27	0.00
28	
29	0.16
30	0.00

**1996 PRECIPITATION DATA--
LAC COURT OREILLES
WISCONSIN LAKE MANAGEMENT PROJECT**

GAGE LOCATION:

Ghost Creek, Pollock

MONTH: July	
Day	Precipitation (Inches)
1	0.00
2	0.00
3	0.00
4	0.00
5	0.00
6	0.00
7	1.25
8	0.03
9	0.01
10	0.00
11	0.30
12	0.10
13	0.03
14	0.02
15	0.00
16	0.00
17	1.20
18	0.21
19	0.00
20	0.00
21	0.26
22	0.00
23	0.12
24	0.00
25	0.01
26	0.02
27	0.61
28	0.00
29	0.00
30	0.00
31	0.00

**1996 PRECIPITATION DATA--
LAC COURT OREILLES
WISCONSIN LAKE MANAGEMENT PROJECT**

GAGE LOCATION:

Ghost Creek, Pollock

MONTH: August	
Day	Precipitation (Inches)
1	0.00
2	0.00
3	0.00
4	0.00
5	0.26
6	0.00
7	0.20
8	0.00
9	0.00
10	0.00
11	0.00
12	0.00
13	0.00
14	0.00
15	0.00
16	0.00
17	0.00
18	0.00
19	0.90
20	0.00
21	0.49
22	0.00
23	0.00
24	0.00
25	0.00
26	0.00
27	0.00
28	0.00
29	0.00
30	0.00
31	0.00

**1996 PRECIPITATION DATA--
LAC COURT OREILLES
WISCONSIN LAKE MANAGEMENT PROJECT**

GAGE LOCATION:

Ghost Creek, Pollock

MONTH: September	
Day	Precipitation (Inches)
1	0.00
2	0.00
3	0.70
4	2.02
5	0.00
6	0.00
7	0.02
8	0.00
9	0.00
10	0.00
11	0.02
12	0.03
13	0.00
14	0.00
15	0.00
16	0.00
17	0.00
18	0.00
19	0.05
20	0.02
21	0.00
22	0.12
23	0.19
24	
25	
26	1.01
27	
28	0.17
29	0.00
30	0.00

**1996 PRECIPITATION DATA--
LAC COURT OREILLES
WISCONSIN LAKE MANAGEMENT PROJECT**

GAGE LOCATION:

Ghost Creek, Pollock

MONTH: October	
Day	Precipitation (Inches)
1	0.00
2	0.00
3	0.00
4	0.00
5	0.00
6	0.02
7	0.00
8	0.00
9	0.00
10	0.00
11	0.00
12	0.00
13	0.00
14	0.00
15	0.00
16	0.00
17	1.26
18	0.19
19	
20	
21	
22	
23	
24	1.49
25	0.00
26	0.00
27	0.00
28	0.00
29	0.90
30	0.00
31	0.00

**1996 PRECIPITATION DATA--
LAC COURT OREILLES
WISCONSIN LAKE MANAGEMENT PROJECT**

GAGE LOCATION:

Ghost Creek, Pollock

MONTH: November	No readings taken
Day	Precipitation (Inches)
1	
2	
3	
4	
5	
6	
7	
8	
9	
10	
11	
12	
13	
14	
15	
16	
17	
18	
19	
20	
21	
22	
23	
24	
25	
26	
27	
28	
29	
30	

**1996 PRECIPITATION DATA--
LAC COURT OREILLES
WISCONSIN LAKE MANAGEMENT PROJECT**

GAGE LOCATION:

Ghost Creek, Pollock

MONTH: December		No readings taken
Day	Precipitation (Inches)	
1		
2		
3		
4		
5		
6		
7		
8		
9		
10		
11		
12		
13		
14		
15		
16		
17		
18		
19		
20		
21		
22		
23		
24		
25		
26		
27		
28		
29		
30		
31		

1996 PRECIPITATION DATA--

LAC COURT OREILLES WISCONSIN LAKE MANAGEMENT PROJECT

GAGE LOCATION:

Stukey Bay, Paine

MONTH: May		No readings taken
Day	Precipitation (Inches)	
1		
2		
3		
4		
5		
6		
7		
8		
9		
10		
11		
12		
13		
14		
15		
16		
17		
18		
19		
20		
21		
22		
23		
24		
25		
26		
27		
28		
29		
30		
31		

**1996 PRECIPITATION DATA--
LAC COURT OREILLES
WISCONSIN LAKE MANAGEMENT PROJECT**

GAGE LOCATION:

Stukey Bay, Paine

MONTH: June		No readings taken
Day	Precipitation (Inches)	
1		
2		
3		
4		
5		
6		
7		
8		
9		
10		
11		
12		
13		
14		
15		
16		
17		
18		
19		
20		
21		
22		
23		
24		
25		
26		
27		
28		
29		
30		

**1996 PRECIPITATION DATA--
LAC COURT OREILLES
WISCONSIN LAKE MANAGEMENT PROJECT**

GAGE LOCATION:

Stukey Bay, Paine

MONTH: July	
Day	Precipitation (Inches)
1	0.27
2	0.00
3	0.00
4	0.00
5	0.00
6	0.68
7	0.00
8	0.70
9	0.00
10	0.00
11	0.32
12	0.00
13	0.07
14	0.00
15	0.06
16	0.00
17	0.00
18	1.40
19	0.36
20	0.00
21	0.00
22	0.35
23	0.94
24	0.00
25	0.00
26	0.00
27	0.65
28	0.00
29	0.01
30	0.01
31	0.02

1996 PRECIPITATION DATA--
LAC COURT OREILLES
WISCONSIN LAKE MANAGEMENT PROJECT

GAGE LOCATION:

Stukey Bay, Paine

MONTH: August

Day	Precipitation (Inches)
1	0.00
2	0.00
3	0.00
4	0.00
5	0.28
6	0.00
7	0.68
8	0.00
9	0.00
10	0.00
11	0.02
12	0.00
13	0.00
14	0.00
15	0.00
16	0.00
17	0.00
18	0.00
19	0.83
20	0.00
21	0.00
22	0.62
23	0.00
24	0.00
25	0.01
26	0.00
27	0.00
28	0.00
29	0.00
30	0.00
31	0.00

1996 PRECIPITATION DATA-- LAC COURT OREILLES WISCONSIN LAKE MANAGEMENT PROJECT

GAGE LOCATION: Stukey Bay, Paine

MONTH: September	
Day	Precipitation (Inches)
1	0.00
2	0.00
3	
4	1.85
5	0.00
6	0.00
7	0.00
8	0.07
9	0.00
10	0.00
11	
12	0.14
13	0.00
14	0.00
15	0.00
16	0.00
17	0.00
18	0.00
19	0.00
20	0.09
21	0.08
22	0.03
23	0.22
24	0.00
25	
26	0.94
27	
28	0.02
29	0.10
30	0.02

**1996 PRECIPITATION DATA--
LAC COURT OREILLES
WISCONSIN LAKE MANAGEMENT PROJECT**

GAGE LOCATION:

Stukey Bay, Paine

MONTH: October	
Day	Precipitation (Inches)
1	0.00
2	0.00
3	0.00
4	0.00
5	0.00
6	
7	0.06
8	0.00
9	
10	0.01
11	
12	
13	
14	
15	
16	
17	
18	
19	
20	
21	
22	
23	
24	
25	
26	
27	
28	
29	
30	
31	

**1996 PRECIPITATION DATA--
LAC COURT OREILLES
WISCONSIN LAKE MANAGEMENT PROJECT**

GAGE LOCATION:

Stukey Bay, Paine

MONTH: November		No readings taken
Day	Precipitation (Inches)	
1		
2		
3		
4		
5		
6		
7		
8		
9		
10		
11		
12		
13		
14		
15		
16		
17		
18		
19		
20		
21		
22		
23		
24		
25		
26		
27		
28		
29		
30		

**1996 PRECIPITATION DATA--
LAC COURT OREILLES
WISCONSIN LAKE MANAGEMENT PROJECT**

GAGE LOCATION:

Stukey Bay, Paine

MONTH: December		No readings taken
Day	Precipitation (Inches)	
1		
2		
3		
4		
5		
6		
7		
8		
9		
10		
11		
12		
13		
14		
15		
16		
17		
18		
19		
20		
21		
22		
23		
24		
25		
26		
27		
28		
29		
30		
31		

1996 PRECIPITATION DATA--

LAC COURT OREILLES WISCONSIN LAKE MANAGEMENT PROJECT

GAGE LOCATION:

Victory Heights, Shannen

MONTH: May		No readings taken
Day	Precipitation (Inches)	
1		
2		
3		
4		
5		
6		
7		
8		
9		
10		
11		
12		
13		
14		
15		
16		
17		
18		
19		
20		
21		
22		
23		
24		
25		
26		
27		
28		
29		
30		
31		

**1996 PRECIPITATION DATA--
LAC COURT OREILLES
WISCONSIN LAKE MANAGEMENT PROJECT**

GAGE LOCATION: Victory Heights, Shannen

MONTH: June	
Day	Precipitation (Inches)
1	1.00
2	0.03
3	0.18
4	
5	0.08
6	0.07
7	0.06
8	
9	
10	
11	
12	
13	
14	
15	0.09
16	
17	2.25
18	
19	0.05
20	
21	
22	
23	0.18
24	
25	
26	1.50
27	
28	
29	
30	

**1996 PRECIPITATION DATA--
LAC COURT OREILLES
WISCONSIN LAKE MANAGEMENT PROJECT**

GAGE LOCATION:

Victory Heights, Shannen

MONTH: July	
Day	Precipitation (Inches)
1	
2	
3	
4	
5	
6	
7	
8	1.20
9	0.05
10	
11	0.10
12	0.23
13	
14	0.05
15	0.13
16	
17	
18	1.10
19	
20	
21	
22	
23	0.58
24	0.55
25	
26	
27	0.45
28	
29	
30	
31	0.04

**1996 PRECIPITATION DATA--
LAC COURT OREILLES
WISCONSIN LAKE MANAGEMENT PROJECT**

GAGE LOCATION: Victory Heights, Shannen

MONTH: August	
Day	Precipitation (Inches)
1	
2	
3	
4	
5	0.21
6	
7	0.27
8	
9	
10	
11	
12	
13	
14	
15	
16	
17	
18	0.05
19	1.13
20	
21	
22	0.50
23	
24	
25	
26	
27	
28	
29	0.04
30	
31	

**1996 PRECIPITATION DATA--
LAC COURT OREILLES
WISCONSIN LAKE MANAGEMENT PROJECT**

GAGE LOCATION: Victory Heights, Shannen

MONTH: September	
Day	Precipitation (Inches)
1	
2	
3	1.50
4	
5	
6	
7	
8	
9	
10	
11	
12	
13	
14	0.45
15	
16	
17	
18	
19	
20	0.04
21	
22	0.20
23	
24	
25	
26	
27	
28	
29	
30	1.25

**1996 PRECIPITATION DATA--
LAC COURT OREILLES
WISCONSIN LAKE MANAGEMENT PROJECT**

GAGE LOCATION:

Victory Heights, Shannen

MONTH: October		No readings taken
Day	Precipitation (Inches)	
1		
2		
3		
4		
5		
6		
7		
8		
9		
10		
11		
12		
13		
14		
15		
16		
17		
18		
19		
20		
21		
22		
23		
24		
25		
26		
27		
28		
29		
30		
31		

**1996 PRECIPITATION DATA--
LAC COURT OREILLES
WISCONSIN LAKE MANAGEMENT PROJECT**

GAGE LOCATION: Victory Heights, Shannen

MONTH: November		No readings taken
Day	Precipitation (Inches)	
1		
2		
3		
4		
5		
6		
7		
8		
9		
10		
11		
12		
13		
14		
15		
16		
17		
18		
19		
20		
21		
22		
23		
24		
25		
26		
27		
28		
29		
30		

1996 PRECIPITATION DATA--
 LAC COURT OREILLES
 WISCONSIN LAKE MANAGEMENT PROJECT

40

GAGE LOCATION: Victory Heights, Shannen

MONTH: December		No readings taken
Day	Precipitation (Inches)	
1		
2		
3		
4		
5		
6		
7		
8		
9		
10		
11		
12		
13		
14		
15		
16		
17		
18		
19		
20		
21		
22		
23		
24		
25		
26		
27		
28		
29		
30		
31		

1996 PRECIPITATION DATA--

LAC COURT OREILLES WISCONSIN LAKE MANAGEMENT PROJECT

GAGE LOCATION: Whitefish Creek, Kremer

MONTH: May	
Day	Precipitation (Inches)
1	
2	
3	
4	
5	
6	
7	
8	
9	
10	
11	
12	
13	
14	0.01
15	
16	
17	
18	0.05
19	0.90
20	
21	0.01
22	0.01
23	
24	
25	
26	
27	
28	
29	
30	
31	

1996 PRECIPITATION DATA--
LAC COURT OREILLES
WISCONSIN LAKE MANAGEMENT PROJECT

GAGE LOCATION:

Whitefish Creek, Kremer

MONTH: June	
Day	Precipitation (Inches)
1	0.80
2	0.03
3	0.04
4	
5	0.05
6	0.12
7	
8	
9	
10	
11	
12	
13	
14	
15	0.03
16	0.40
17	0.43
18	0.41
19	0.03
20	
21	0.42
22	
23	0.17
24	
25	
26	1.51
27	
28	
29	
30	

**1996 PRECIPITATION DATA--
LAC COURT OREILLES
WISCONSIN LAKE MANAGEMENT PROJECT**

GAGE LOCATION: Whitefish Creek, Kremer

MONTH: July	
Day	Precipitation (Inches)
1	
2	0.30
3	
4	
5	
6	0.90
7	0.04
8	0.05
9	
10	
11	0.12
12	0.21
13	
14	
15	0.05
16	0.10
17	0.90
18	0.12
19	0.14
20	
21	
22	0.15
23	0.28
24	0.46
25	0.04
26	
27	
28	0.43
29	0.04
30	
31	

1996 PRECIPITATION DATA--
LAC COURT OREILLES
WISCONSIN LAKE MANAGEMENT PROJECT

GAGE LOCATION: Whitefish Creek, Kremer

MONTH: August	
Day	Precipitation (Inches)
1	
2	
3	
4	0.02
5	0.31
6	
7	0.22
8	
9	
10	
11	
12	
13	
14	0.05
15	0.04
16	
17	
18	
19	1.25
20	0.14
21	
22	0.42
23	0.02
24	0.03
25	
26	
27	
28	
29	
30	
31	

**1996 PRECIPITATION DATA--
LAC COURT OREILLES
WISCONSIN LAKE MANAGEMENT PROJECT**

GAGE LOCATION: Whitefish Creek, Kremer

MONTH: September	
Day	Precipitation (Inches)
1	
2	
3	0.15
4	1.55
5	
6	
7	0.03
8	0.04
9	
10	0.05
11	0.30
12	0.06
13	0.03
14	
15	
16	
17	
18	
19	
20	0.07
21	0.02
22	0.04
23	0.14
24	
25	0.02
26	0.40
27	0.85
28	0.06
29	0.04
30	

**1996 PRECIPITATION DATA--
LAC COURT OREILLES
WISCONSIN LAKE MANAGEMENT PROJECT**

GAGE LOCATION: Whitefish Creek, Kremer

MONTH: October		No readings taken
Day	Precipitation (Inches)	
1		
2		
3		
4		
5		
6		
7		
8		
9		
10		
11		
12		
13		
14		
15		
16		
17		
18		
19		
20		
21		
22		
23		
24		
25		
26		
27		
28		
29		
30		
31		

**1996 PRECIPITATION DATA--
LAC COURT OREILLES
WISCONSIN LAKE MANAGEMENT PROJECT**

GAGE LOCATION: Whitefish Creek, Kremer

MONTH: November	No readings taken
Day	Precipitation (Inches)
1	
2	
3	
4	
5	
6	
7	
8	
9	
10	
11	
12	
13	
14	
15	
16	
17	
18	
19	
20	
21	
22	
23	
24	
25	
26	
27	
28	
29	
30	

**1996 PRECIPITATION DATA--
LAC COURT OREILLES
WISCONSIN LAKE MANAGEMENT PROJECT**

GAGE LOCATION:

Whitefish Creek, Kremer

MONTH: December		No readings taken
Day	Precipitation (Inches)	
1		
2		
3		
4		
5		
6		
7		
8		
9		
10		
11		
12		
13		
14		
15		
16		
17		
18		
19		
20		
21		
22		
23		
24		
25		
26		
27		
28		
29		
30		
31		

1996 PRECIPITATION DATA--

LAC COURT OREILLES WISCONSIN LAKE MANAGEMENT PROJECT

GAGE LOCATION:

Ashland Point, Hawley

MONTH: May		No readings taken
Day	Precipitation (Inches)	
1		
2		
3		
4		
5		
6		
7		
8		
9		
10		
11		
12		
13		
14		
15		
16		
17		
18		
19		
20		
21		
22		
23		
24		
25		
26		
27		
28		
29		
30		
31		

**1996 PRECIPITATION DATA--
LAC COURT OREILLES
WISCONSIN LAKE MANAGEMENT PROJECT**

GAGE LOCATION:

Ashland Point, Hawley

MONTH: June	
Day	Precipitation (Inches)
1	0.98
2	0.05
3	0.15
4	
5	
6	0.05
7	
8	
9	
10	
11	
12	
13	
14	
15	0.20
16	0.12
17	0.15
18	
19	0.10
20	0.40
21	0.20
22	
23	0.12
24	
25	
26	1.25
27	
28	
29	0.20
30	

**1996 PRECIPITATION DATA--
LAC COURT OREILLES
WISCONSIN LAKE MANAGEMENT PROJECT**

GAGE LOCATION: Ashland Point, Hawley

MONTH: July	
Day	Precipitation (Inches)
1	
2	0.30
3	
4	
5	
6	0.70
7	
8	0.10
9	0.02
10	
11	0.40
12	
13	
14	0.20
15	0.03
16	
17	0.90
18	0.30
19	
20	
21	0.30
22	
23	0.25
24	0.45
25	
26	
27	0.35
28	
29	
30	
31	

**1996 PRECIPITATION DATA--
LAC COURT OREILLES
WISCONSIN LAKE MANAGEMENT PROJECT**

GAGE LOCATION:

Ashland Point, Hawley

MONTH: August

Day	Precipitation (Inches)
1	
2	
3	
4	0.25
5	
6	0.40
7	
8	
9	
10	
11	
12	
13	
14	0.15
15	
16	
17	
18	
19	1.03
20	
21	0.55
22	
23	
24	
25	
26	
27	
28	
29	
30	
31	

**1996 PRECIPITATION DATA--
LAC COURT OREILLES
WISCONSIN LAKE MANAGEMENT PROJECT**

GAGE LOCATION:

Ashland Point, Hawley

MONTH: September	
Day	Precipitation (Inches)
1	
2	0.35
3	1.90
4	
5	
6	
7	0.15
8	
9	
10	0.25
11	
12	
13	
14	
15	
16	
17	
18	
19	
20	
21	
22	0.20
23	
24	
25	
26	
27	
28	
29	1.20
30	

1996 PRECIPITATION DATA--
LAC COURT OREILLES
WISCONSIN LAKE MANAGEMENT PROJECT

GAGE LOCATION:

Ashland Point, Hawley

MONTH: October		No readings taken
Day	Precipitation (Inches)	
1		
2		
3		
4		
5		
6		
7		
8		
9		
10		
11		
12		
13		
14		
15		
16		
17		
18		
19		
20		
21		
22		
23		
24		
25		
26		
27		
28		
29		
30		
31		

**1996 PRECIPITATION DATA--
LAC COURT OREILLES
WISCONSIN LAKE MANAGEMENT PROJECT**

GAGE LOCATION: Ashland Point, Hawley

MONTH: November		No readings taken
Day	Precipitation (Inches)	
1		
2		
3		
4		
5		
6		
7		
8		
9		
10		
11		
12		
13		
14		
15		
16		
17		
18		
19		
20		
21		
22		
23		
24		
25		
26		
27		
28		
29		
30		

**1996 PRECIPITATION DATA--
LAC COURT OREILLES
WISCONSIN LAKE MANAGEMENT PROJECT**

GAGE LOCATION:

Ashland Point, Hawley

MONTH: December		No readings taken
Day	Precipitation (Inches)	
1		
2		
3		
4		
5		
6		
7		
8		
9		
10		
11		
12		
13		
14		
15		
16		
17		
18		
19		
20		
21		
22		
23		
24		
25		
26		
27		
28		
29		
30		
31		

1996 PRECIPITATION DATA--

LAC COURT OREILLES WISCONSIN LAKE MANAGEMENT PROJECT

GAGE LOCATION:

Northeast Bay, Degan

MONTH: May	
Day	Precipitation (Inches)
1	
2	
3	
4	
5	
6	
7	
8	
9	
10	
11	
12	
13	
14	
15	
16	
17	
18	
19	
20	
21	0.16
22	
23	
24	
25	
26	
27	
28	
29	
30	
31	

**1996 PRECIPITATION DATA--
LAC COURT OREILLES
WISCONSIN LAKE MANAGEMENT PROJECT**

GAGE LOCATION:

Northeast Bay, Degan

MONTH: June	
Day	Precipitation (Inches)
1	0.90
2	0.01
3	0.11
4	
5	0.10
6	
7	
8	
9	
10	
11	
12	
13	
14	
15	0.10
16	1.45
17	0.20
18	0.51
19	0.16
20	0.02
21	0.70
22	
23	0.20
24	
25	
26	1.35
27	
28	
29	0.38
30	

**1996 PRECIPITATION DATA--
LAC COURT OREILLES
WISCONSIN LAKE MANAGEMENT PROJECT**

GAGE LOCATION:

Northeast Bay, Degan

MONTH: July	
Day	Precipitation (Inches)
1	
2	
3	
4	
5	1.25
6	
7	0.07
8	
9	
10	0.40
11	
12	
13	0.02
14	
15	
16	
17	1.30
18	0.40
19	
20	
21	0.50
22	
23	
24	0.10
25	
26	
27	0.80
28	
29	
30	0.07
31	

**1996 PRECIPITATION DATA--
LAC COURT OREILLES
WISCONSIN LAKE MANAGEMENT PROJECT**

GAGE LOCATION:

Northeast Bay, Degan

MONTH: August	
Day	Precipitation (Inches)
1	
2	
3	
4	
5	
6	0.60
7	0.25
8	
9	
10	
11	
12	
13	
14	0.03
15	
16	
17	
18	
19	1.40
20	
21	
22	0.60
23	
24	0.02
25	
26	
27	
28	
29	
30	
31	

**1996 PRECIPITATION DATA--
LAC COURT OREILLES
WISCONSIN LAKE MANAGEMENT PROJECT**

GAGE LOCATION:

Northeast Bay, Degan

MONTH: September	
Day	Precipitation (Inches)
1	
2	0.05
3	2.75
4	
5	
6	
7	
8	0.04
9	
10	
11	0.07
12	0.04
13	
14	
15	
16	
17	
18	
19	
20	0.10
21	
22	0.60
23	
24	
25	
26	
27	
28	
29	1.25
30	

**1996 PRECIPITATION DATA--
LAC COURT OREILLES
WISCONSIN LAKE MANAGEMENT PROJECT**

GAGE LOCATION: Northeast Bay, Degan

MONTH: October		No readings taken
Day	Precipitation (Inches)	
1		
2		
3		
4		
5		
6		
7		
8		
9		
10		
11		
12		
13		
14		
15		
16		
17		
18		
19		
20		
21		
22		
23		
24		
25		
26		
27		
28		
29		
30		
31		

**1996 PRECIPITATION DATA--
LAC COURT OREILLES
WISCONSIN LAKE MANAGEMENT PROJECT**

GAGE LOCATION: Northeast Bay, Degan

MONTH: November	No readings taken
Day	Precipitation (Inches)
1	
2	
3	
4	
5	
6	
7	
8	
9	
10	
11	
12	
13	
14	
15	
16	
17	
18	
19	
20	
21	
22	
23	
24	
25	
26	
27	
28	
29	
30	

**1996 PRECIPITATION DATA--
LAC COURT OREILLES
WISCONSIN LAKE MANAGEMENT PROJECT**

GAGE LOCATION:

Northeast Bay, Degan

MONTH: December		No readings taken
Day	Precipitation (Inches)	
1		
2		
3		
4		
5		
6		
7		
8		
9		
10		
11		
12		
13		
14		
15		
16		
17		
18		
19		
20		
21		
22		
23		
24		
25		
26		
27		
28		
29		
30		
31		