

# FC8000 SERIES

## CUTTING PRO

### User's Manual

---

MANUAL NO.FC8000-UM-151



# GRAPHTEC

## TO ENSURE SAFE AND CORRECT USE

- To ensure the safe and correct use of your plotter, read this manual thoroughly prior to use.
- After reading this manual, keep it in a handy location for quick reference as necessary.
- Do not allow small children to touch the plotter.
- The following describes important points for safe operation. Be sure to observe them strictly.

### Conventions Used in This Manual

To ensure the safe and accurate use of the plotter as well as to prevent human injury and property damage, the safety precautions provided in this manual are ranked in the three categories described below. Their display and meaning is as following. Be sure to gain a full understanding of the meaning of them before reading the Manual.



This category provides information that, if ignored, is highly likely to cause fatal or serious injury to the operator.





This category provides information that, if ignored, is likely to cause fatal or serious injury to the operator.





This category provides information that, if ignored, could cause injury to the operator or damage to the plotter.

### Description of Safety Symbols





The  symbol indicates information that requires careful attention (including warnings). The specific point requiring attention is described by an illustration or text within or next to the  symbol.



The  symbol indicates an action that is prohibited. Such prohibited action is described by an illustration or text within or next to the  symbol.



The  symbol indicates an action that must be performed. Such imperative action is described by an illustration or text within or next to the  symbol.

# Safety Precautions

## ⚠ WARNING

**Do not touch the rollers or moving parts such as the carriage while cutting or plotting is in progress.**

- Such action may result in injury.



Do not touch

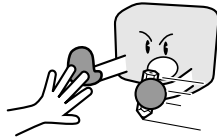

**Be sure to ground the earth terminal.**

- If the plotter is not grounded, the operator could suffer an electric shock in the event of current leakage.



Ground the plotter

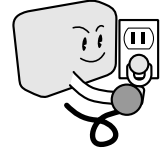

**Keep your hands, hair, etc., away from the rollers or moving parts such as the carriage even if the plotter is stopped, as it may suddenly start moving when data is received.**

- Such action may result in injury.



Keep your distance

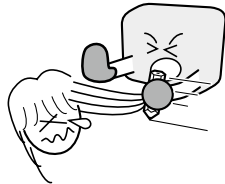

**Do not disassemble, repair, or remodel the plotter.**

- Such action may cause electric shock or a fire hazard due to current leakage.
- Contact with the high-voltage parts within the plotter may cause electric shock.
- If the plotter requires repairs, contact your sales representative or nearest Graphtec vendor.



No disassembly



**Do not connect the plotter to a non-rated power supply.**

- Such action may cause electric shock or a fire hazard due to current leakage.



Prohibited

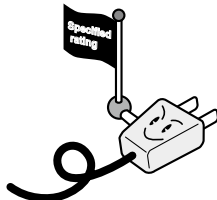

**Do not use the plotter in a location where it will be exposed to water, rain, or snow.**

- Such action may cause electric shock or a fire hazard due to current leakage.



Avoid water



Beware of electric shock

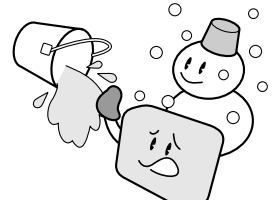

**If the plotter generates smoke, overheats, emits a strange odor, or otherwise functions abnormally, do not continue using it. Turn off the power and unplug the power cord from the electrical socket.**

- Use of the plotter in such a condition may result in a fire hazard or electric shock.
- After confirming that smoke is no longer being emitted, contact your sales representative or nearest Graphtec vendor for repairs.
- Never attempt to perform repairs yourself. Repair work by inexperienced personnel is extremely dangerous.



Prohibited

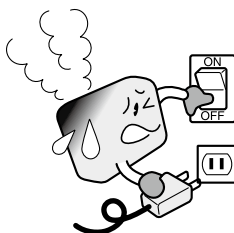

**Do not allow dust or metal scraps to adhere to the power plug.**

- Such action may cause electric shock or a fire hazard due to current leakage.



Prohibited



Beware of electric shock

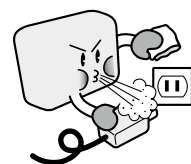

# Safety Precautions

## ⚠ WARNING

### Do not use the power cord if it is damaged.

- Use of a damaged cord may result in electric shock or a fire hazard due to current leakage.
- Replace the power cord with a new one.



Unplug the power cord from the socket

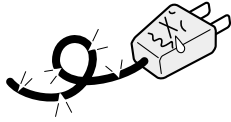

### Be careful when handling the cutter blade.

- Touching the blade with your bare hand may cause injury.
- Do not touch the cutter blade while cutting is in progress.



Do not touch

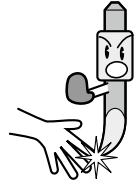

# Safety Precautions

## ⚠ CAUTION

### Do not use or store the plotter in a location exposed to direct sunlight or the direct draft of an air conditioner or heater.

- Such locations may impair the performance of the plotter.



Prohibited

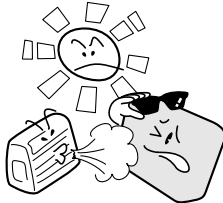

### Do not use the plotter in an excessively dusty or humid location.

- Such locations may impair the performance of the plotter.



Prohibited

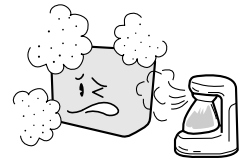

### Do not place any receptacle containing water or other fluid on top of the plotter.

- Fluid falling inside the plotter may cause electric shock or a fire hazard due to current leakage.



Avoid water



Beware of electric shock



### Do not use the plotter in a location subject to excessive mechanical vibration or electrical noise.

- Such locations may impair the performance of the plotter.



Prohibited

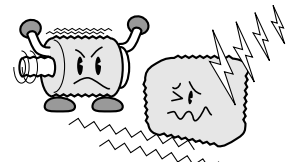

### When disconnecting the power cord or interface cable, do not pull on the cord/cable.

- Such action will damage the cord/cable, resulting in a fire hazard or electric shock.



Prohibited

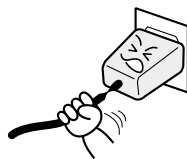

### If water or foreign matter enters the plotter, discontinue use. Turn off the power and unplug the power cord from the electrical socket.

- Use of a damaged cord may result in electric shock or a fire hazard due to current leakage.
- Contact your sales representative or nearest Graphtec vendor for repairs.



Unplug the power cord from the socket

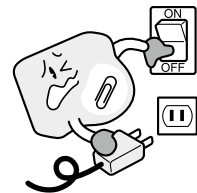



# Safety Precautions

## ! CAUTION

### Do not attempt to lubricate the cutting-plotter mechanisms.

- Such action may cause it to break down.



Prohibited

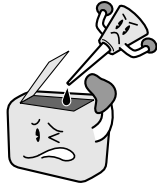

### Do not clean the plotter using volatile solvents such as thinner or benzene.

- Such locations may impair the performance of the plotter.



Prohibited

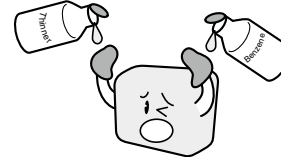

### Provide sufficient space around the plotter so that it does not strike any objects in its vicinity during cutting.

- Such contact may cause misalignment in cutting or plotting.



Do not touch

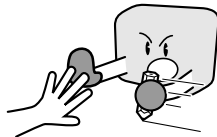

### When using indoor lighting such as fluorescent or other electrical lamps, provide a distance of at least one meter between the plotter and the light source.

- Close proximity of such a light source may cause the sensor to malfunction and prevent proper size detection of the media.



### When using the cutter, take care not to extend the blade more than necessary.

- An overly extended blade will damage the cutting mat and adversely affect the cutting quality.

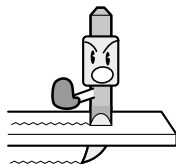

### Move the tool carriage slowly when moving it manually in order to load the medium or for other reasons.

- Moving it quickly may damage the plotter.

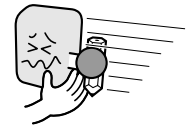

## Special Precautions on Handling Blades

Sharp cutter blades are used with this plotter. Handle the cutter blades and holders with care to prevent bodily injury.

### Cutter Blades

Cutter blades are very sharp. While handling a cutter blade or cutter pen, be careful to avoid cutting your fingers or other parts of your body. Promptly return used blades to the cutter case provided. When the case is completely filled, discard the used blades together with the case.

### Cutter Pens

The tip consists of a sharp blade. Be sure not to extend it too far. Moreover, when you are not using the cutter pen, make sure that the blade is fully retracted.

## After Turning on the Plotter

During the course of turning on the plotter, be sure to observe the following precautions. The tool carriage and loaded media may suddenly move during the cutting operation, immediately afterward and when setting the plotter's functions. Keep hands, hair, clothing and other objects out of the vicinity of the tool carriage, grit rollers and loaded media. To prevent operator injury and poor cutting results, be careful not to allow hands, hair, clothing or other foreign objects to become entangled with the tool carriage or loaded media while the plotter is operating.

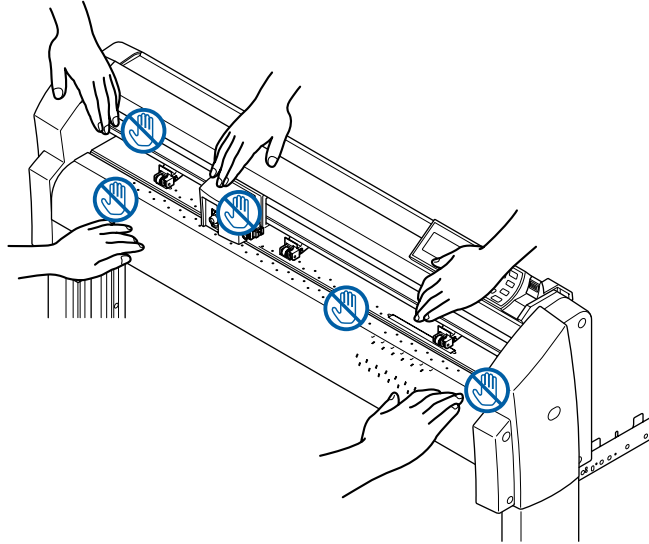

## Machine Caution Label

The machine's Caution Label is located on the top cover. Be sure to observe all the cautions on the label.

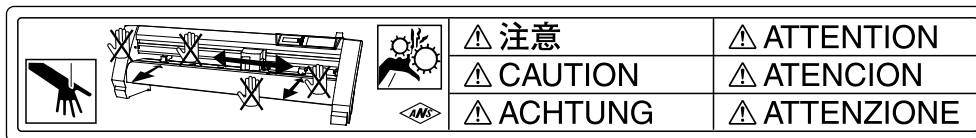

## Notes on the Stand

Be sure to use only the stand designed for the FC8000 Series with your FC8000 Series plotter. The use of a different stand may cause a plotter malfunction or bodily injury.

# Preface

**Thank you for choosing a Graphtec FC8000 Series plotter. The FC8000 Series plotters employ a digital servo drive system to achieve high-speed and high-precision cutting. In addition to cutting marking film and other media, an FC8000 series plotter can also be used as a pen plotter. To ensure high cutting quality and optimal productivity, be sure to read this User's Manual thoroughly prior to use.**

## Notes on this Manual

- (1) No part of this publication may be reproduced, stored in a retrieval system, or transmitted, in any form or by any means, without the prior written permission of Graphtec Corporation.
- (2) The product specifications and other information in this manual are subject to change without notice.
- (3) While every effort has been made to provide complete and accurate information, please contact your sales representative or nearest Graphtec vendor if you find any unclear or erroneous information or wish to make other comments or suggestions.
- (4) Notwithstanding the stipulations in the preceding paragraph, Graphtec Corporation assumes no liability for damages resulting from either the use of the information contained herein or the use of the product.

## Registered Trademarks

All names of companies, brands, logotypes, and products appearing in this manual are the trademarks or registered trademarks of their respective companies.

## Copyright

This User's Manual is copyrighted by Graphtec Corporation.

# Contents

TO ENSURE SAFE AND CORRECT USE .....	i
Conventions Used in This Manual .....	i
Description of Safety Symbols .....	i
Safety Precautions .....	ii
Special Precautions on Handling Blades.....	iv
Cutter Blades.....	iv
Cutter Pens.....	iv
After Turning on the Plotter .....	v
Machine Caution Label.....	v
Notes on the Stand .....	v
Preface .....	vi
Notes on this Manual.....	vi
Registered Trademarks.....	vi
Copyright .....	vi
Contents.....	vii

## Chapter 1: Assembling and Connection..... 1-1

1-1	Checking the Contents.....	1-2
1-2	Nomenclature .....	1-3
	Front View.....	1-3
	Rear View.....	1-4
1-3	Assembling .....	1-5
	Front Loading and Rear Loading.....	1-5
	Assembling the Stand.....	1-6
	Mounting the stock rollers .....	1-9
	Attaching the FC8000 Basket .....	1-9
1-4	Connecting to the Computer .....	1-12

## Chapter 2: Preparing to Cut..... 2-1

2-1	Preparation of Cutter Pen .....	2-2
	Cutter Pen Nomenclature.....	2-2
	Structure of Cutter Pen .....	2-2
	Adjusting the Blade Length.....	2-2
	Blade Application and Features.....	2-3
2-2	Attaching a Tool .....	2-4
	Attaching a Tool .....	2-4
2-3	Loading Media (Paper or Marking Film).....	2-6
	Loading Roll Media (Rear Loading "REAR SET").....	2-6
	When the Media Width is 160 to 540 mm.....	2-7
	When the Media Width Exceeds 540 mm .....	2-8
	Loading Roll Media (Front Loading "FRONT SET") .....	2-9
	Loading Sheet Media.....	2-11
	When the Media Width is 100 to 160mm.....	2-12
	When the Media Width is 160 to 540 mm or Exceeds 540 mm.....	2-12
2-4	Aligning the Push Rollers .....	2-13
	Standby of the Push Roller.....	2-13
	Aligning the Push Roller .....	2-13
	When Feeding Long-axis Media (at least 2 meters) .....	2-14
	Changing the Hold-down Force .....	2-14
	Switching Between the Strong and Weak Settings.....	2-14
	Hold-down Force Assignments .....	2-15
2-5	Turning on the Power .....	2-16

2-6	How to Use Control Panel.....	2-17
	Control Keys.....	2-17
	Menu Keys.....	2-17
	Indicator Lamp.....	2-17
	Reading the Screen (LCD).....	2-18
	Contents of Operation from Menu Screen.....	2-19
	Contents of Operation from CONDITION Key.....	2-19
2-7	Setting Feeding Method.....	2-20
	When Selecting ROLL-1 REAR SET (ROLL-1 FRONT SET) by Pressing the [1] Key.....	2-20
	When Selecting ROLL-2 REAR SET (ROLL-2 FRONT SET) by Pressing the [2] Key.....	2-21
	When pressing the [3] key to select SHEET.....	2-21
	To Change the Loading Method.....	2-21
2-8	Pre Feed of Media (Paper or Marking Film).....	2-23
2-9	Selecting Tool Condition.....	2-24
	Setting the Tool Condition.....	2-24
	Setting the Tool.....	2-26
	Setting the Speed.....	2-28
	Setting the Force.....	2-29
	Setting the Acceleration.....	2-30
	Adjust the Blade Length Manually.....	2-31
	Setting the Tool Number.....	2-32
2-10	Running Cutting Tests.....	2-34
	Cutting Test.....	2-34
	To make 1 cut with set value.....	2-34
	To make 3 cuts with set value and $\pm 1$ of set value.....	2-35
	Confirm the Results of the Cutting Test.....	2-36
	Adjustment of Offset.....	2-36
	Adjustment for Half Cutting.....	2-36
	Adjustment for Cutting Out.....	2-36
	Adjustment When Using Plotting Pen.....	2-36
	Adjust the Blade Length (Automatic Height Adjust).....	2-36

## Chapter 3: Basic Operations.....3-1

3-1	Raise or Lower the Tool.....	3-2
3-2	Move the Tool Carriage and Media.....	3-3
	Continuously Move Manually.....	3-3
	Move in Steps Manually.....	3-3
	Setting of Step Movement Distance.....	3-4
	Move Away the Tool Carriage.....	3-5
	Changing CONDITION No.....	3-6
	Setting to Default.....	3-6
3-3	Setting the Origin Point.....	3-7
	When Coordinate Axes Rotation are Set.....	3-8
	When Coordinate Axes are Rotated After Origin Point is Set.....	3-8
	Setting Origin Point When HP-GL is Set.....	3-9
3-4	Setting the Cutting Direction.....	3-10
3-5	Stop Cutting.....	3-12
	Pause and Resume Cutting.....	3-12
	Stop Cutting.....	3-13
3-6	Cut off the Roll Sheet (Cross Cut).....	3-14
	Cut Width.....	3-14
	Cross Cut Manually.....	3-15
	Automatically Cross Cut.....	3-16
	Setting of the Cross Cut Force.....	3-17

<b>Chapter 4: Convenient Functions.....</b>	<b>4-1</b>
4-1 Settings for Cutting.....	4-2
Setting Cutting Area .....	4-2
Setting Cutting Width .....	4-4
Setting Length of the Page .....	4-5
Setting Mirror .....	4-6
Setting Enlarge/Shrink Scale .....	4-8
4-2 Copy (Duplicate Cutting) .....	4-9
4-3 Dual Configuration.....	4-12
Selection of the User .....	4-12
Setting User Priority.....	4-13
4-4 Apparel (AP) Mode .....	4-14
Switching Apparel Mode .....	4-14
Setting Timeout.....	4-15
Setting the Separator .....	4-16
Setting the Space Rear.....	4-17
 <b>Chapter 5: ARMS (Advanced Registration Mark Sensing System) .....</b>	 <b>5-1</b>
5-1 Outline of ARMS.....	5-2
Shape (Pattern) of Registration Mark .....	5-2
MARK TYPE 1.....	5-2
MARK TYPE 2.....	5-3
Scan Range Necessary to Detect the Registration Mark .....	5-3
Positioning of the Media and the Registration Mark .....	5-4
Position of the Origin Point and the Registration Mark .....	5-5
Media That Registration Mark Cannot be Detected.....	5-5
5-2 Setting and Adjustment of ARMS.....	5-6
Setting MARK SCAN Mode and Numbers .....	5-6
Setting Shape (Pattern) of Registration Mark .....	5-9
Setting Registration Mark Size .....	5-11
Setting Mark Distance .....	5-12
Setting Distance Adjustment Between the Registration Mark.....	5-14
When USER or STANDARD modes are selected.....	5-15
When CUSTOM mode is selected .....	5-15
Setting Offset Between the Registration Mark and Cutting Origin Points.....	5-16
Adjusting the Sensor Level .....	5-18
Manually Adjusting the Sensor Level (Threshold Value) .....	5-19
Test the Registration Mark Sensor .....	5-21
Setting Speed of the Registration Mark Scan.....	5-23
Adjusting for the Registration Mark Scan Position .....	5-24
Adjust After Plotting the Adjustment Registration Mark .....	5-24
Detect the Registration Mark for Adjustment on the Media and Enter the Value .....	5-27
5-3 Setting the Position Using ARMS .....	5-30
Adjust with 2POINTS .....	5-30
Adjust with 3POINTS .....	5-32
Adjust with 4POINTS .....	5-33
Automatically Adjust .....	5-34
Adjust Manually.....	5-36
 <b>Chapter 6: Manual Position Adjust.....</b>	 <b>6-1</b>
6-1 Outline of Manual Position Adjust.....	6-2
Setting of Mark Scan Mode and Number of Adjustment Marks .....	6-2
6-2 Manual Position Adjust.....	6-3

<b>Chapter 7: Setting Regarding Cutting Quality.....</b>	<b>7-1</b>
7-1    To cut the corner of thick media sharply.....	7-2
Outline of Tangential Emulation .....	7-2
Setting the Tangential Emulation .....	7-3
Setting Length of the Overcut.....	7-4
Setting of the Initial Down Force .....	7-6
Setting the TOOL UP HEIGHT .....	7-7
7-2    Setting the Step Pass .....	7-9
7-3    Setting the Reference Angle .....	7-11
7-4    Setting the Distance Adjust .....	7-13
7-5    Setting Cut Line Pattern .....	7-15
7-6    Setting Initial Blade Direction Adjust .....	7-18
7-7    Settings for OFFSET FORCE.....	7-20
7-8    Setting Paper-Weight .....	7-21
 <b>Chapter 8: Settings Regarding Cutting Time .....</b>	 <b>8-1</b>
8-1    Sorting the Cutting Data.....	8-2
8-2    Perform Automatic Pre Feed When Cut Data is Received.....	8-4
8-3    Perform Automatic Pre Feed When Media is Set (Initial Feed).....	8-6
8-4    Setting Feed Speed for Pre Feed.....	8-7
8-5    Setting the Tool Up Speed .....	8-9
8-6    Setting the Tool Up Move.....	8-11
 <b>Chapter 9: Setting Regarding Interface.....</b>	 <b>9-1</b>
9-1    Setting Interface.....	9-2
USB Interface .....	9-2
RS-232C Interface.....	9-2
Network (LAN) Interface.....	9-2
Interface Setting Menu .....	9-3
Connecting with Network (LAN) .....	9-3
When DHCP Setting is Turned Off.....	9-4
Connecting with RS-232C .....	9-6
Switching Setting Numbers .....	9-6
Changing and Storing RS-232C Settings.....	9-7
 <b>Chapter 10: Settings Regarding Operation Environment .....</b>	 <b>10-1</b>
Related to Menu Display .....	10-2
Display Language Setting (LANGUAGE SELECTION) .....	10-2
Setting the Display Length Unit (LENGTH UNIT) .....	10-3
Related to Sensor .....	10-4
Enabling/Disabling the Media Sensors (MEDIA SENSOR).....	10-4
Enabling/Disabling the Push Roller Sensors (PUSH ROLLER SENSOR).....	10-5
Related to Plotter Environment .....	10-6
Fan Suction Setting (FAN POWER).....	10-6
Enabling/Disabling the Beep Setting (BEEP FOR KEY OPERATION) .....	10-7
 <b>Chapter 11: Settings of Controls from Computer.....</b>	 <b>11-1</b>
Related to Command Processing .....	11-2
Setting the Command (COMMAND).....	11-2
Priority of Tool Condition Selection (CONDITION PRIORITY) .....	11-3
Enabling/Disabling the Pen Select Command (PEN SELECT) .....	11-4

Related to GP-GL Command .....	11-5
Setting the Step Size (STEP SIZE) .....	11-5
Enabling/Disabling the ":" and ";" Commands (COMMAND ":", ";") .....	11-6
Moving the Pen While Raised or Lowered in Response to the "W" Command (COMMAND "W") .....	11-7
Related to HP-GL Command .....	11-8
Model ID Response (MODEL EMULATED) .....	11-8
Circle-Command Resolution Setting (CIRCLE RESOLUTION) .....	11-9

## **Chapter 12: Maintenance ..... 12-1**

12-1 Daily Maintenance .....	12-2
Daily Maintenance .....	12-2
Storing the Plotter .....	12-2
12-2 Replacing Cutter Blade .....	12-3
12-3 Replacing the Cross Cut Unit .....	12-4

## **Chapter 13: Troubleshooting ..... 13-1**

13-1 Troubleshooting .....	13-2
When the Plotter Does Not Operate After Turning the Power On.....	13-2
When It Does Not Work Right.....	13-3
When the Cutting Result is Not Good .....	13-5
Error Messages in GP-GL Command Mode.....	13-6
Error Messages in HP-GL Command Mode.....	13-7
Error Messages for ARMS.....	13-9
Other Error Messages .....	13-12
Caution Message .....	13-14
13-2 Printing the Setting of the Plotter.....	13-15
13-3 Creating Test Pattern .....	13-17
13-4 Confirm the Cutting Data .....	13-19
13-5 Self Diagnostic Test.....	13-21
Reading the Error Message .....	13-22

## **Chapter 14: Option..... 14-1**

14-1 Loupe (Adjusting the Position).....	14-2
Axis Alignment, Cut Area Positioning .....	14-2
Attaching the Loupe .....	14-2
Using the Loupe .....	14-3
14-2 Pouncing (Punch Continuous Holes) .....	14-4
Attaching the Pouncing Tool .....	14-4
Setting the Pouncing Tool.....	14-5
14-3 2-Pen Assignment (Switching the Tools) .....	14-7
Attaching to Tool Holder .....	14-7
Attaching to the Pen Station.....	14-8
Assigning Tool Number .....	14-9
Tool Offset Adjustment .....	14-10
For between tool 1 and 2.....	14-10
For between tool 1 and 3.....	14-12
Enabling/Disabling 1/2 Pen Check (CHECK TOOL) .....	14-16

## **Chapter 15: Specifications..... 15-1**

15-1 Menu Tree.....	15-2
15-2 Main Specifications .....	15-6



15-3 Options.....15-8  
15-4 Supplies .....15-9

**INDEX..... 16-1**

# Chapter 1: Assembling and Connection

**This chapter describes how to assemble the plotter and connect to the computer.**

# Checking the Contents

Check that all of the standard accessories shown below are present. If any accessory is missing, contact your sales representative or the nearest Graphtec dealer.

### AC power cord

1

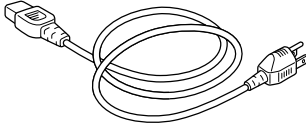

### USB cable (3-meter length)

1

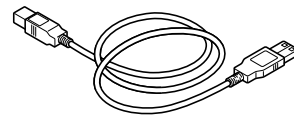

### User Guide CD-ROM

1

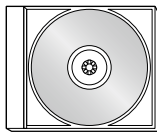

- User's Manual (pdf)
- Windows driver/Macintosh plug-in software

### Setup Manual, TO ENSURE SAFE AND CORRECT USE

1 of each

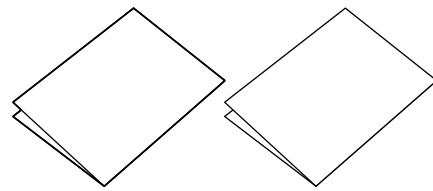

### Cutter holder (PHP32-CB09N)

1

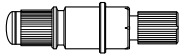

### Cutter blades (CB09UA-1)

1

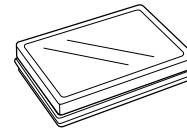

### Water-based fibertip pen

1

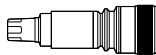

### Media bracket

1

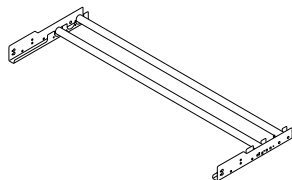

- Media stocker x 2
- Stock roller x 2
- M4 binding head screws x 4

### Stand

1

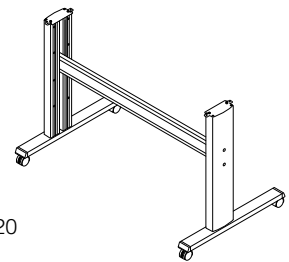

- Base assembly x 2
- Stand side bar x 2
- Center bar x 1
- Socket head cap screws (M5) x 20
- Allen wrench (for M5) x 1

### Cloth basket

1

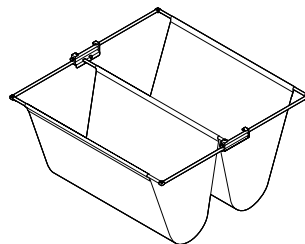

- Cloth basket
- Mounts x 2
- Basket tubes (short) x 4
- Basket tubes (long) x 3
- Socket head cap screws (M5) x 4
- Joints x 4

# 1-2 Nomenclature

## Front View

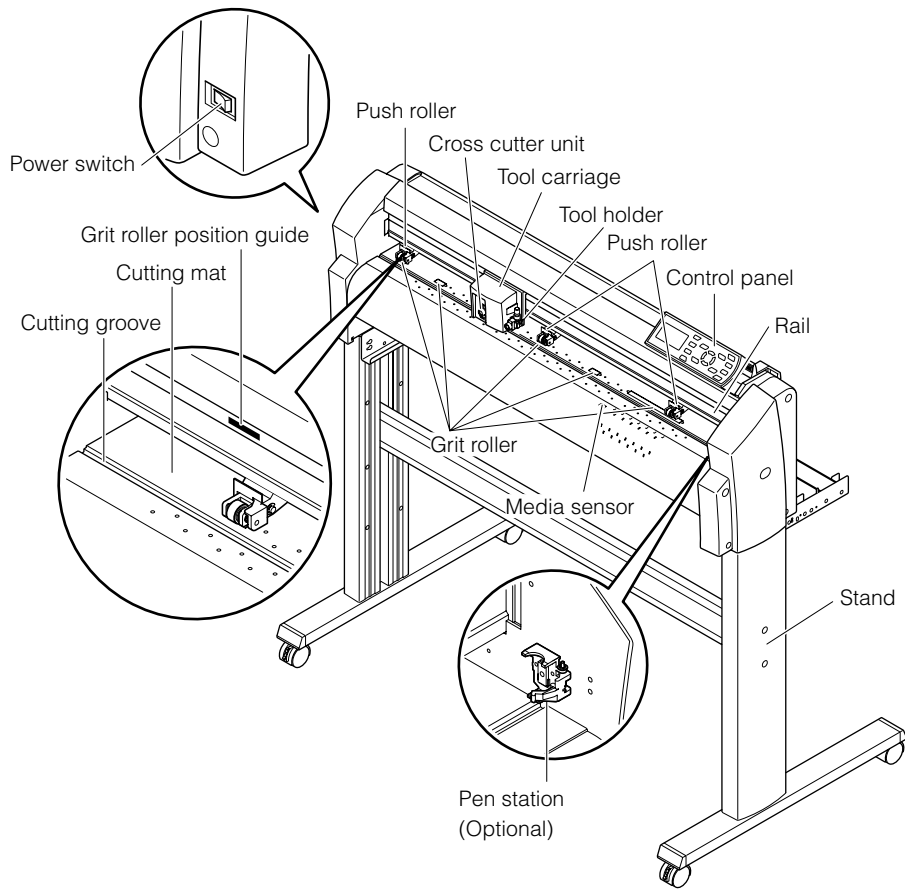

- Power switch .....Used to turn the plotter on and off.
- Control panel.....Used to access various plotter functions.
- Push rollers.....Rollers that push the media against the grit rollers. (Number may vary depending on the model)
- Grit rollers.....Metallic rollers with a file-like surface that feed the media back and forth.
- Media sensors.....The front sensor is used to sense the leading edge of the media. The rear sensor is used to sense the trailing edge of the media.
- Tool carriage.....Moves the cutter-pen or plotting pen across the media during cutting or plotting.
- Tool holder.....Holds the cutter-pen or plotting pen and moves it up or down.
- Pen station (installed on 2-pen models only)  
.....The second pen is mounted here. (Factory-installed option)
- Stand.....Used to make the plotter more portable and to free up counter space.
- Grit roller position guide.....Stickers on the front of the Y rail and the rear side of the top cover that show the position of each grit roller. Use these alignment marks as an aid in locating the Push rollers.
- Cutting mat.....Cutter blade moved on this mat, preventing wears of the blade.
- Cutting groove.....Used when cross cutting is performed.
- Cross cutter unit.....Used to perform cross cutting of media so that the cut length can be removed from the roll.

## Rear View

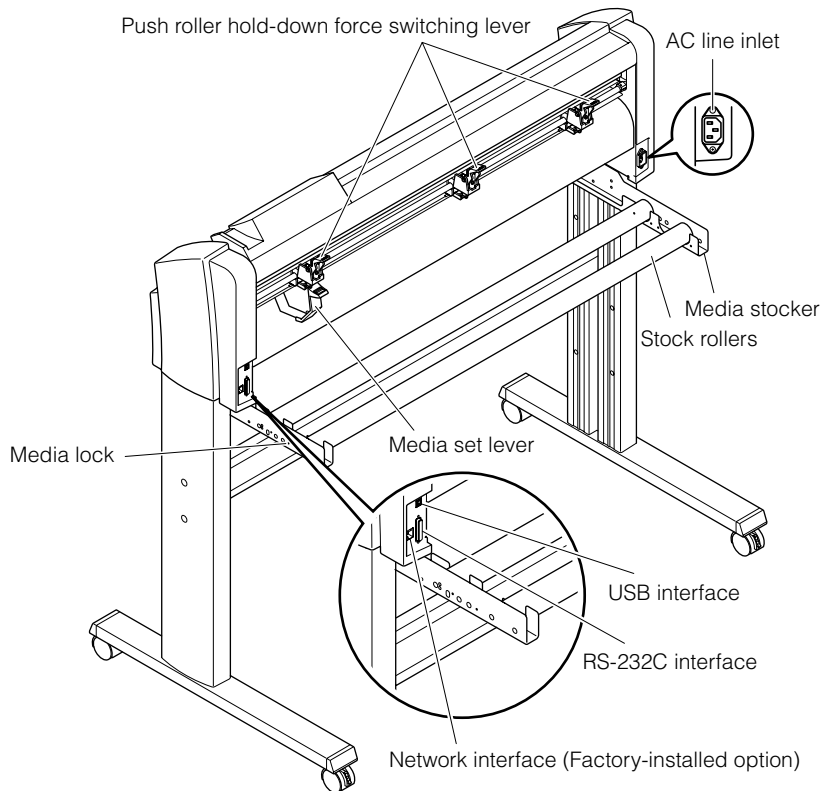

- Media set lever .....Used to raise or lower the Push rollers during the loading or unloading of media.
- Push roller hold-down force switching lever  
 .....Used to switch between the three push roller forces (outside push rollers only has 2 forces of strong and medium).
- AC line inlet .....Inlet where the power cord is connected.
- Media stocker.....Used to carry roll media and ensure its proper rotation.
- Stock rollers.....A media roll is placed on these rollers.
- Media lock.....Used to prevent the stock rollers from rotating when the media roll has been placed on top of them. The media lock ensures that the media is pulled straight out from the roll.
- USB interface connector .....Used to connect the plotter to the computer with a USB interface cable.
- Network interface connector ....Used to connect the plotter to the computer with a network interface cable.  
 (Factory-installed option)
- RS-232C interface connector  
 .....Used to connect the plotter to the computer with a RS-232C interface cable.

# 7-3 Assembling

## Assemble the stand.

The stand is made up of the following parts.

Stand side bar x 2

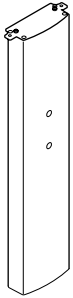

Base assembly x 2

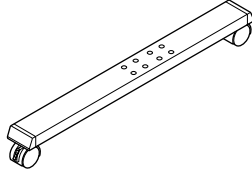

Media stocker x 2

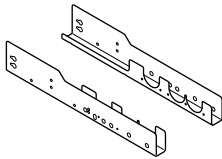

Center bar x 1

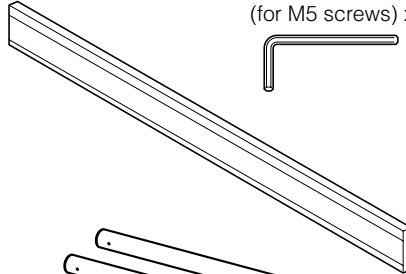

Allen wrench  
(for M5 screws) x 1



Socket head cap screw  
(M5) x 20



Stock roller x 2

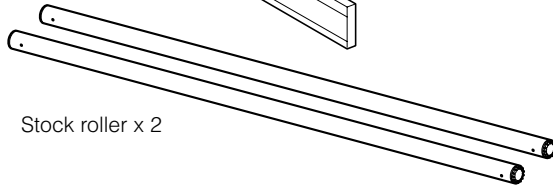

## Front Loading and Rear Loading

It is necessary to set the loading settings from the plotter control panel depending on the attachment direction. Default factory setup is set as rear loading.

It is recommended to use as rear loading.

If you desire to load the material from the front, it is also possible to use the front loading.

Use the plotter with enough space behind in this case.

Also, be aware that continuous cutting with cross cut is not possible.

## Assembling the Stand

The mounting direction is different for the front loading and the rear loading models.

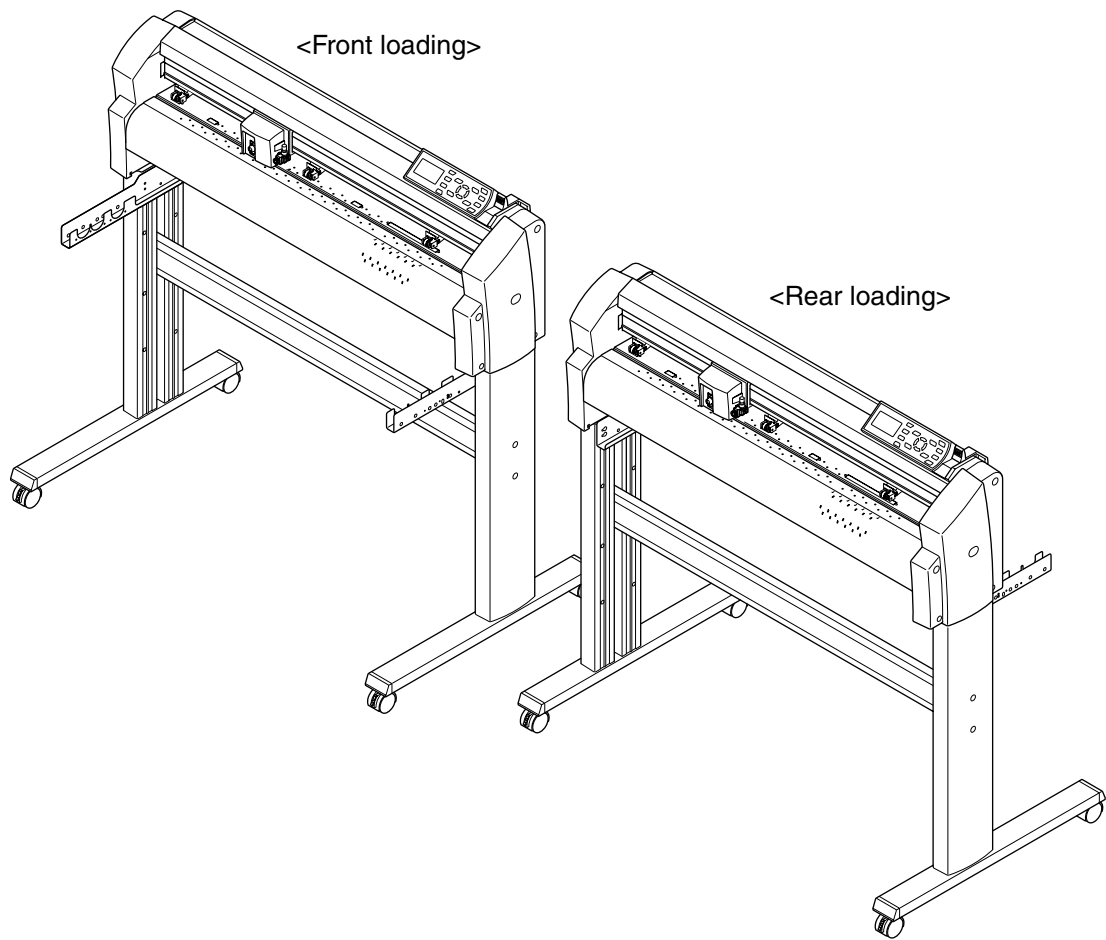

# Assembly

1 Assemble the left and right stand sides. Fasten a base assembly to each of the stand side bars with four socket head cap screws using the Allen wrench.

**Supplement**  
Assemble the stand so that the front and rear lengths of the base assembly are the same for both the left and right stand sides.

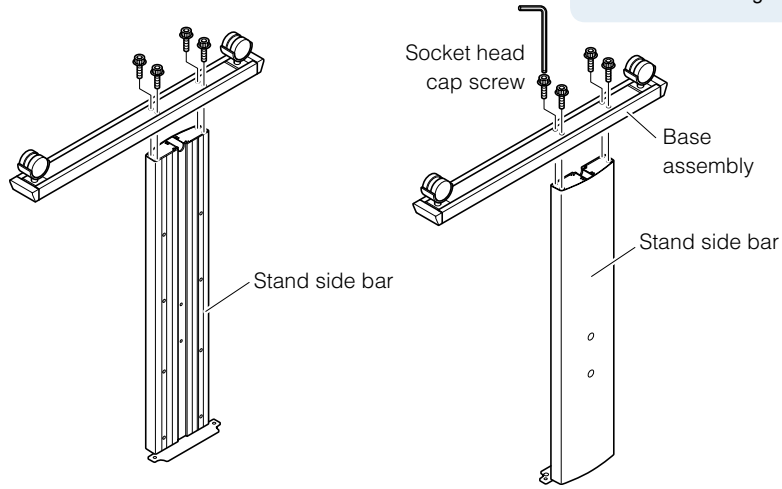

2 Loosely fasten the center bar to the left and right stand sides with four socket head cap screws (two on each side), using the Allen wrench.

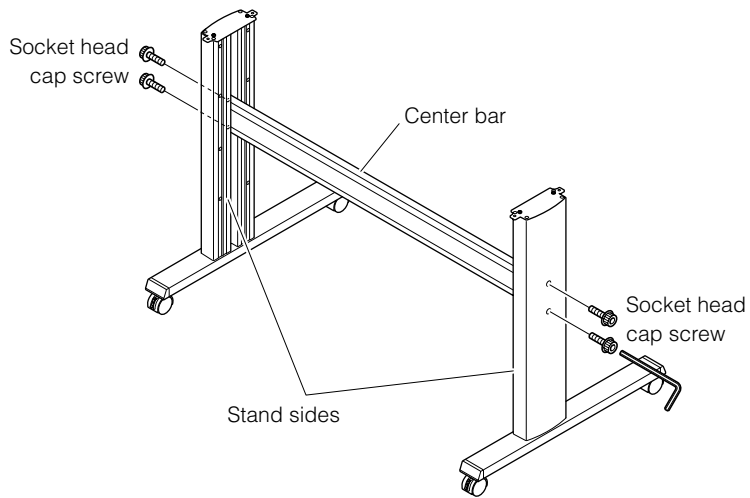



3

Attach a media stocker to each of the left and right stand sides with two socket head cap screws, using the Allen wrench. Mount the media stockers so that each one protrudes directly above the longer of the two base assembly lengths.

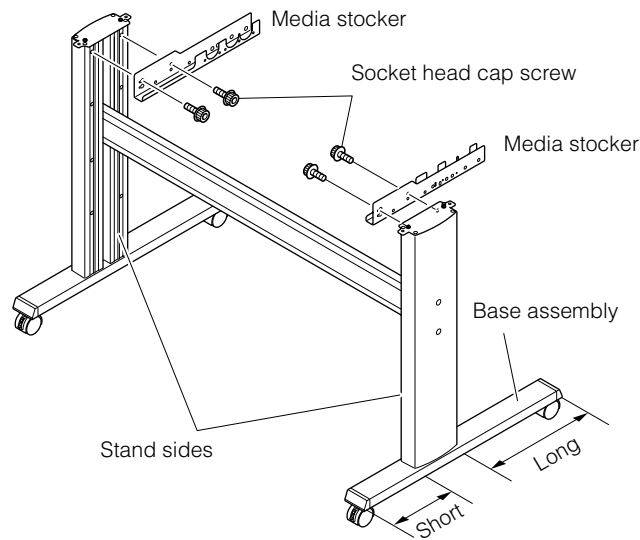

4

Mount the plotter on the stand by inserting the positioning pins on the stand into the positioning holes on the underside of the plotter. Fasten with four socket head cap screws (two on each side), using the Allen wrench. The cutting plotter mounting direction is different for the front loading and the rear loading models.

#### Supplement

- Check that all of the screws used for fastening have been tightened. The media may not be fed correctly if even one of the screws is loose.
- When installing the plotter, make sure that there are no objects in its vicinity. Leave a clear space of at least 300 mm around the plotter.

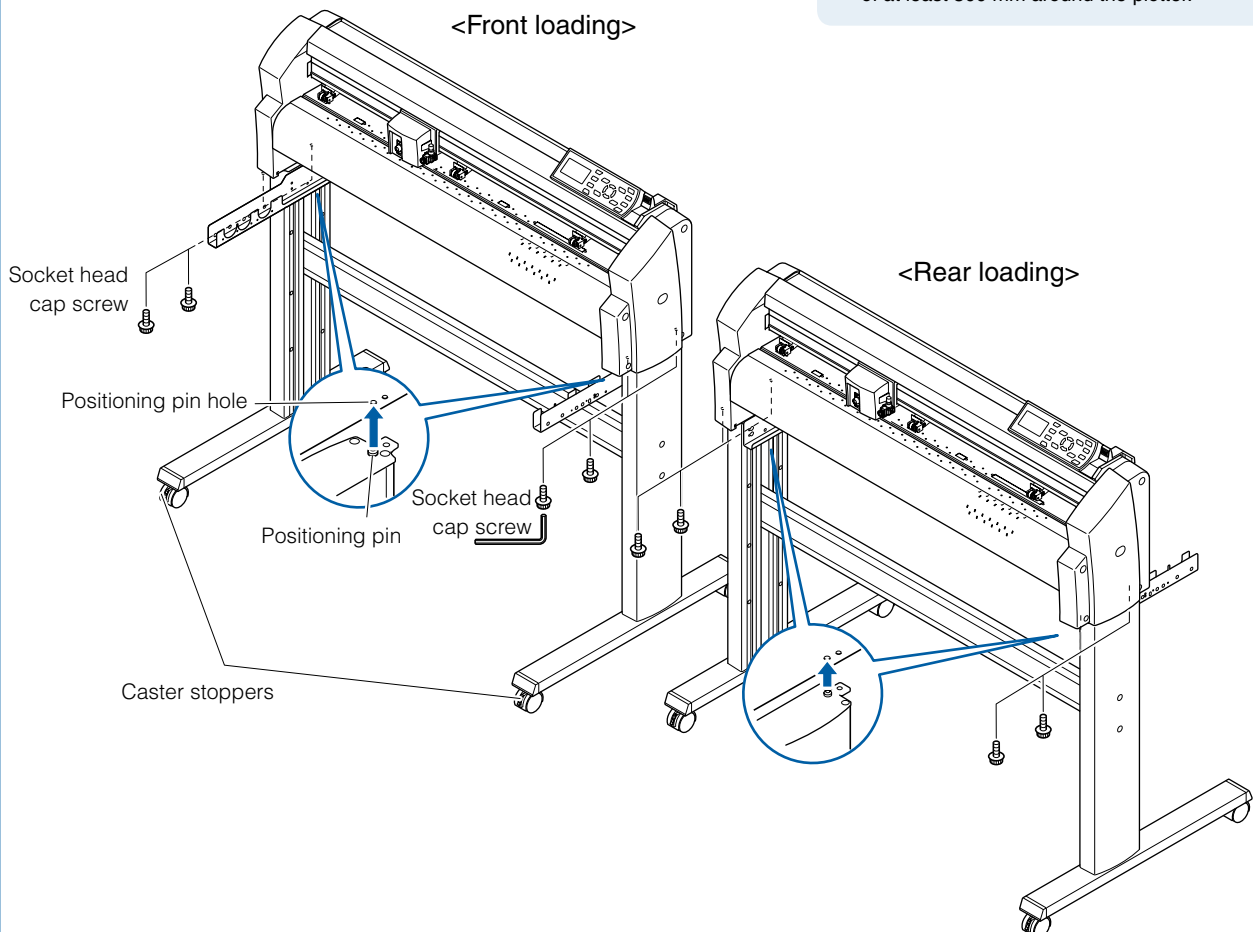

5

Tighten the socket head cap screws loosely fastened in Step 2.

## Mounting the stock rollers

Insert the stock rollers into the slots on the media stocker.

<Front loading>

<Rear loading>

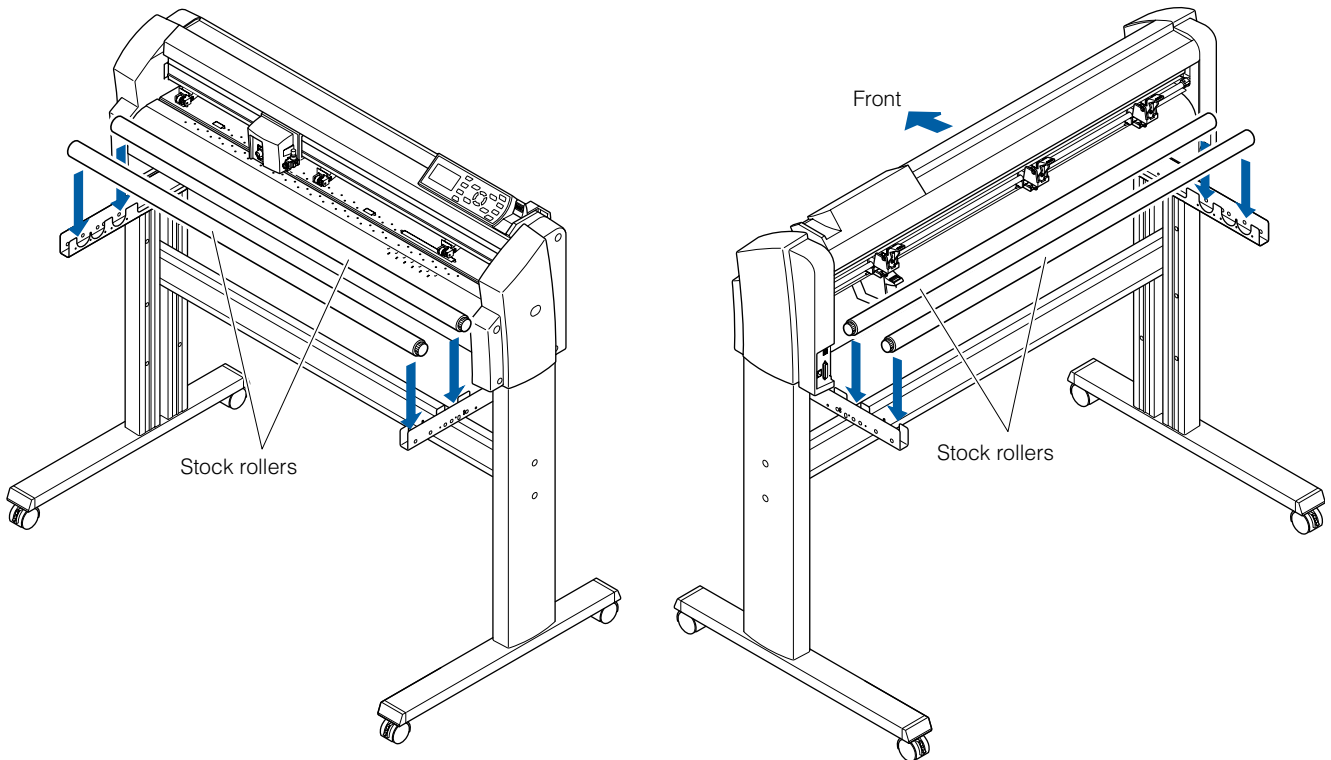

## Attaching the FC8000 Basket

The basket is attached directly to the plotter.  
The basket is made up of the following parts.

Basket x 1, basket tubes (long) x 3, basket tubes (short) x 4, joints x 4, mounts x 2, socket cap head screws x 4, use Allen wrench to assemble the basket.

Be sure to use the basket when cutting long-axis media of more than 1 meter is to be produced.

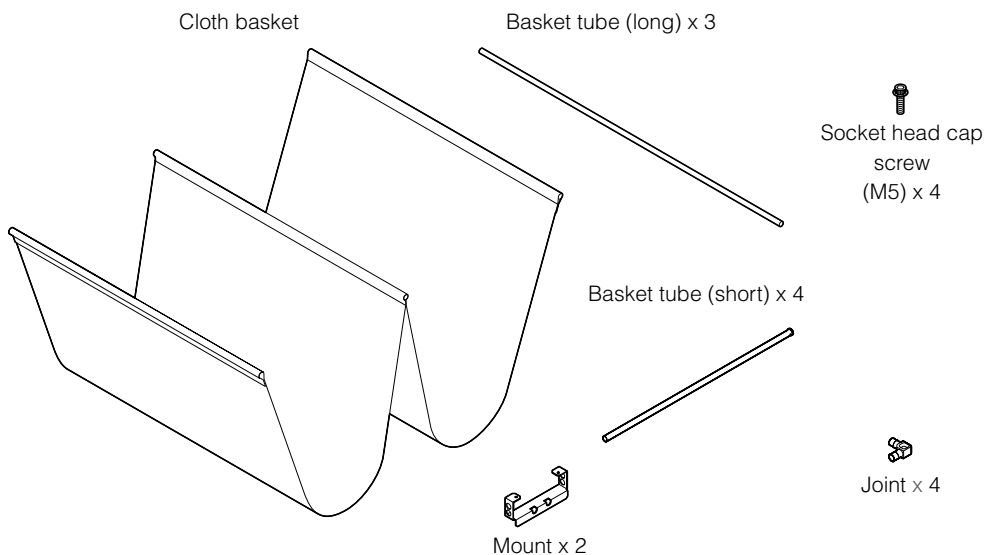

# Assembly

- 1 Insert the basket tubes (long) into both ends and center of the basket. Attach the joints to the end of the 2 outside basket tubes.

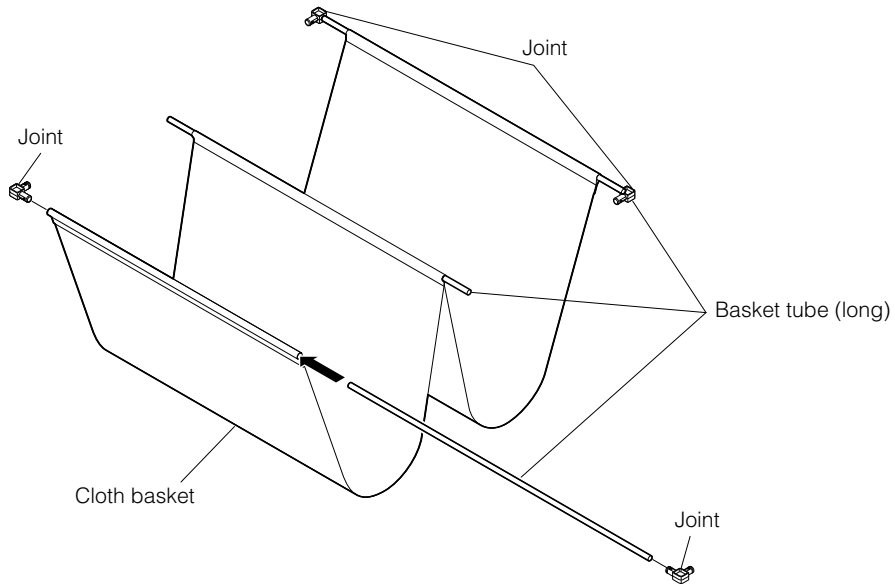

- 2 Insert 2 basket tubes (short) into the mount from the side without the cap. Assemble 2 sets as shown below.

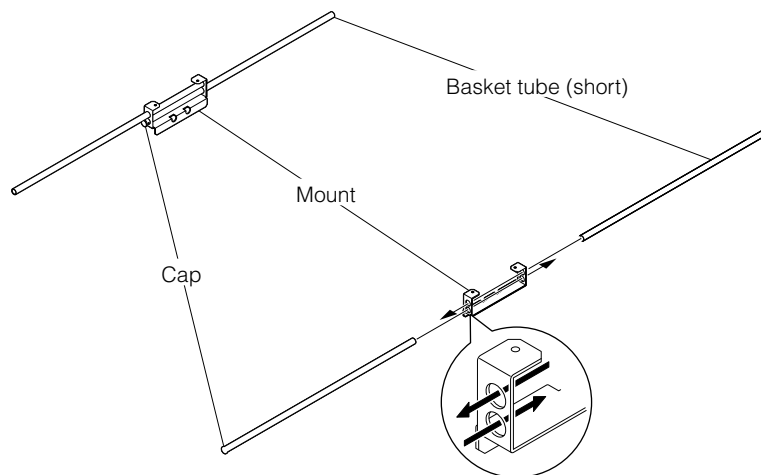

Next page

**3**

Connect the basket tubes (short) to the joints inserted on the basket tubes (long) at the end of the basket attached in step 1. Mounting position of the center basket pipe (long) depends on the loading direction.

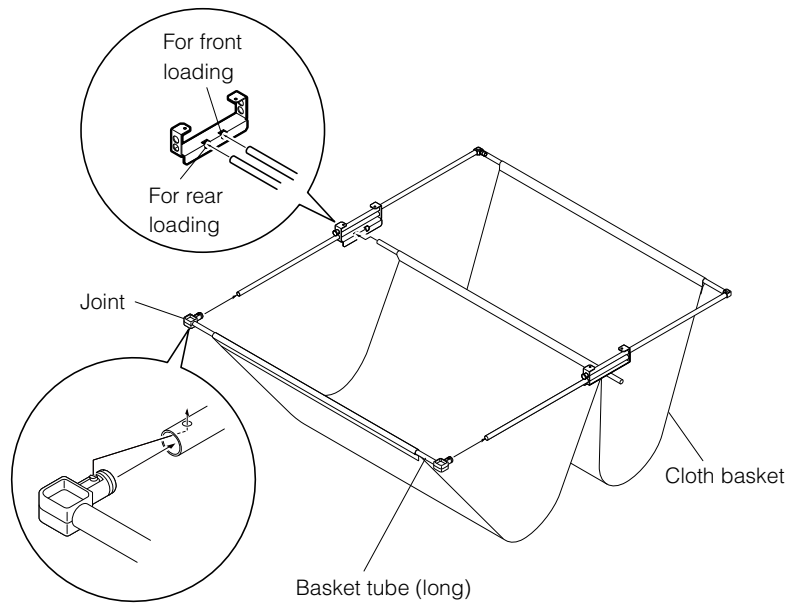
**4**

Fix the part assembled in 3 to the stand using the socket head cap screws. Assembly is completed by separating basket to front and back of the center bar.

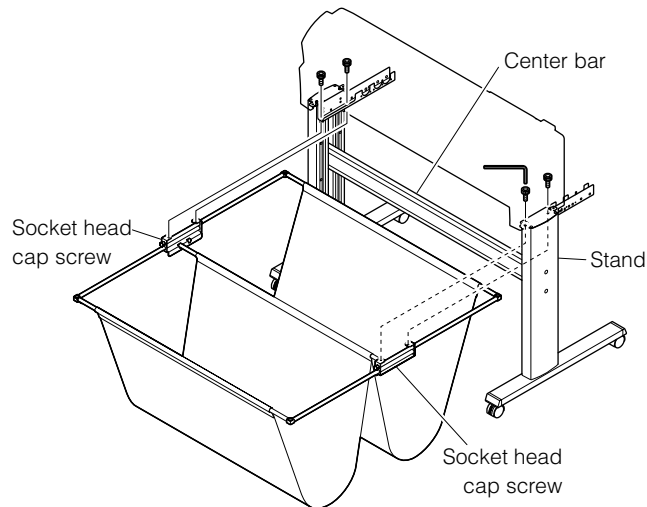

# 1-4 Connecting to the Computer

Connect the plotter to the computer using the interface cable. Use either the USB port, the network (LAN) port, or the RS-232C port to connect the plotter to the computer. Select the port depending on the specification of the software to be used and the availability of the interface port on the computer. Depending on the port used, use either the USB cable, the network (LAN) cable (sold separately), or the RS-232C cable (sold separately) to connect. Use the cables specified by Graphtec, matching the computer that is to be connected.

The network (LAN) interface is a factory-installed option. It cannot be retrofitted.

## Connection

- 1 Check that the power switch is turned off (the "O" side is pressed down).

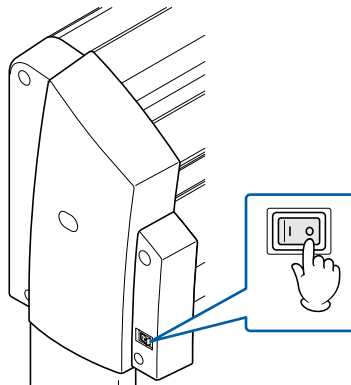

- 2 Connect the plotter to the computer using the interface cable.

Connection via USB interface

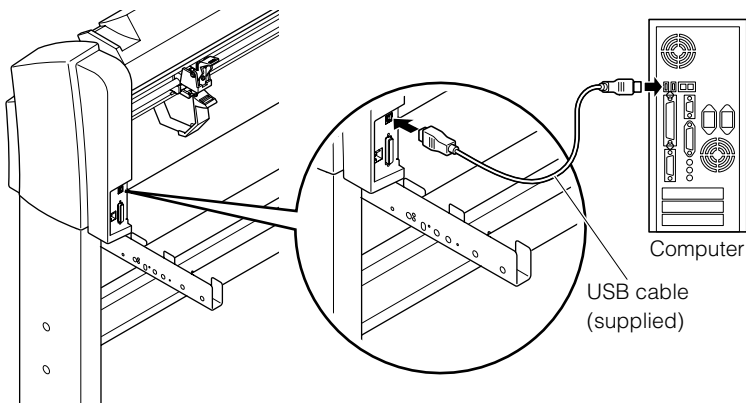

### Supplement

See the "Setting Interface" [P.9-2](#) about setting the interface.

Connection via LAN interface

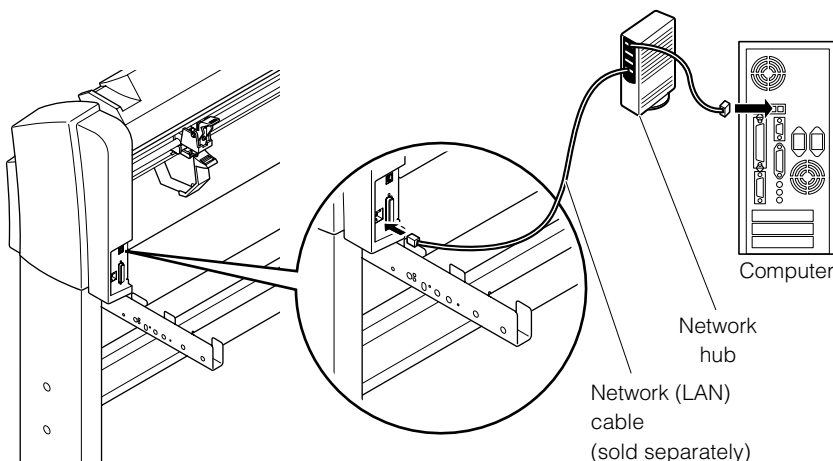

Next page

Connection via RS-232C interface

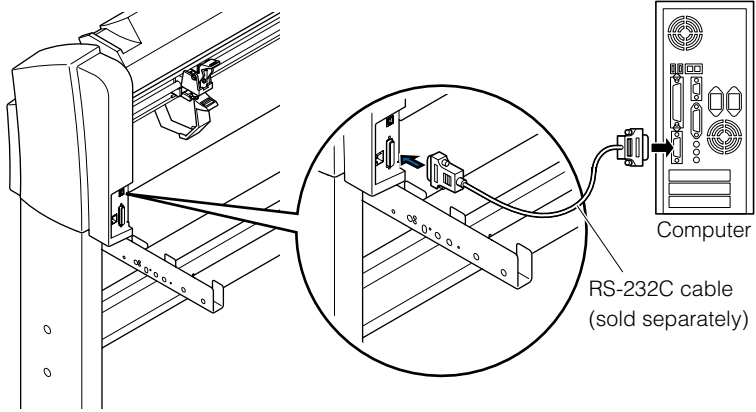



# Chapter 2: Preparing to Cut

**This chapter describes how to prepare to start the cutting.**



This chapter describes the structures and types of the cutter pens.

## Cutter Pen Nomenclature

The plotter cuts using a cutter blade mounted in a cutter plunger. There are two different cutter plunger s to suit the diameter of the cutter blade to be mounted (the 0.9 mm cutter plunger is provided as a standard accessory). Be sure to mount the cutter blade in the corresponding cutter plunger.

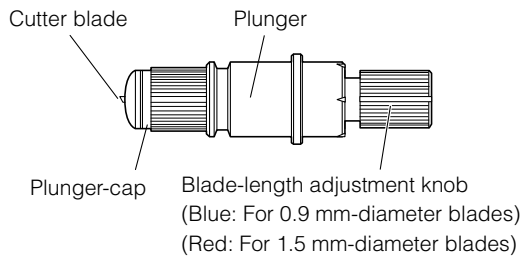

### CAUTION

To avoid bodily injury, handle cutter blades with care.

## Structure of Cutter Pen

1.5 mm diameter cutter pen

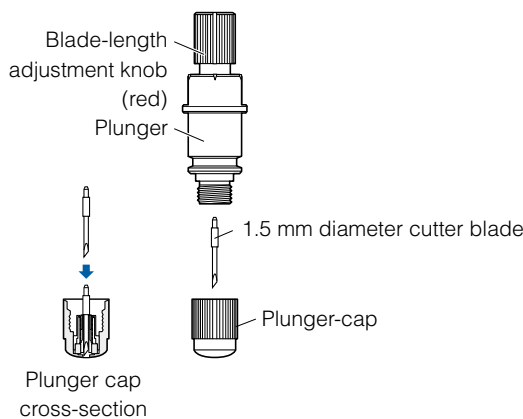

0.9 mm diameter cutter pen

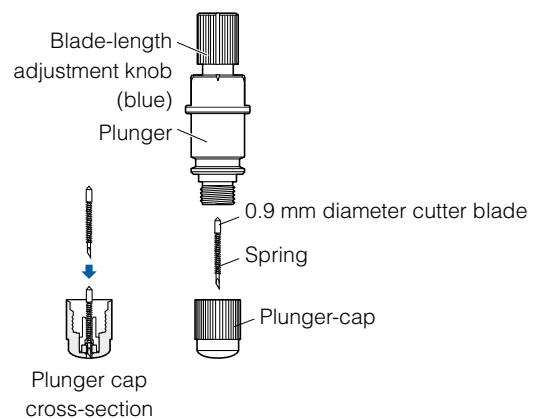

## Adjusting the Blade Length

Blade length needs to be adjusted to perform optimal cut. Perform few test cuts and set the optimal blade length.

### CAUTION

To avoid bodily injury, handle cutter blades with care.

### Supplement

- See "Running Cutting Tests" [P.2-34](#) for cutting tests.
- See "Adjust the Blade Length Manually" [P.2-31](#) for method to manually adjust the blade length.
- See "Adjust the Blade Length (Automatic Height Adjust)" [P.2-36](#) for method to automatically adjust the blade length.



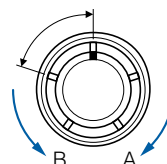

Adjust the blade length by turning the blade-length adjustment knob. Turn the knob in direction "A" to extend the blade, or in direction "B" to retract the blade. When the knob is turned by one scale unit, the blade moves approximately 0.1 mm. One full turn of the knob moves the blade approximately 0.5 mm.

Cutter blade moves approximately 0.1 mm turning one scale unit

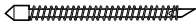

## Blade Application and Features

Individual cutter blades have a variety of features. Select the optimal cutter blade to suit the medium to be cut.

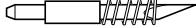
Blade part no. and type	Diameter	Plunger part no.	Applications and features
CB09UA 	0.9 mm	PHP32-CB09N-HS	Standard blade for cutting color adhesive media. Suitable for cutting media up to 0.25 mm thick. Maximum cutting distance of approximately 4000 m.
CB15U 	1.5 mm	PHP32-CB15N-HS	For cutting media which is too thick for the CB09UA blade to handle. Suitable for cutting media from 0.25 mm to 0.5 mm thick.
CB15UA 	1.5 mm	PHP32-CB15N-HS	For cutting high intensity reflective media.
CB15UB 	1.5 mm	PHP32-CB15N-HS	For cutting small characters on mono-vinyl chloride media. Suitable for cutting small size characters that are less than 10 mm.
CB15U-K30 	1.5 mm	PHP32-CB15N-HS	For thick media. The sharply angled point provides a longer cutting edge. Suitable for cutting material from 0.5 mm to 1.5 mm thick.
CB15U-K20-SP 	1.5 mm	PHP31-CB15B-HS	For cutting sandblast rubber.

### CAUTION

To avoid bodily injury, handle cutter blades with care.

# 2-2 Attaching a Tool

Attach a tool (cutter pen, plotter pen) to the plotter.

## Attaching a Tool

When mounting the tool in the tool holder, push the tool all the way into the holder until its flange contacts the upper part of the holder and then tighten the screw firmly. To prevent injury, avoid touching the tool immediately after the cutting plotter is turned on or whenever the tool is moving. It is explained here using cutter pen as an example.

### Operation

- 1 Loosen the tool holder screw.

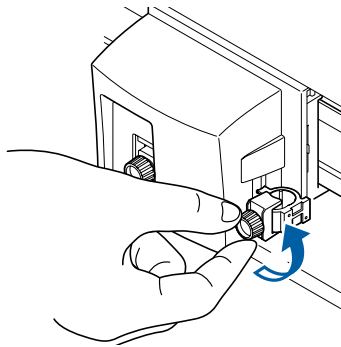

- 2 While pushing the tool holder in the upward direction, push the tool all the way into the holder until its flange contacts the upper part of the holder.

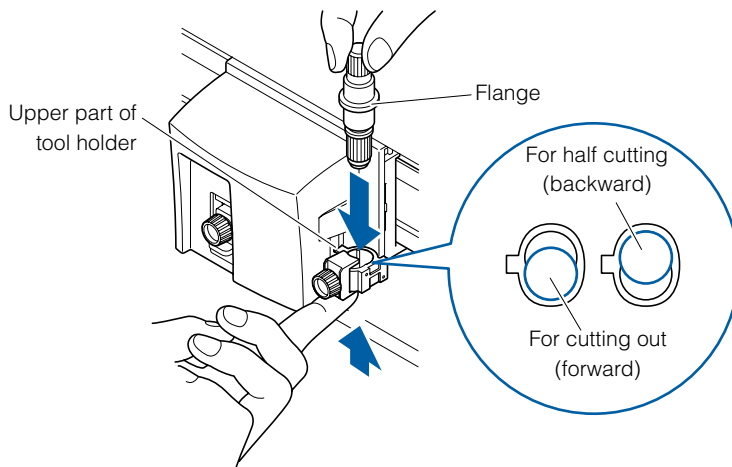

### CAUTION

When pushing the tool holder with your fingers, the blade tip may be protruding. Take care not to cut your fingers.

### Supplement

- The forward position of the tool is used for the cutting out mainly, and the backward position is used for the half cutting mainly.
- Cutting out means that the media is cut out completely.
- Half cutting means that only the marking film is cut out, leaving the backing sheet uncut.
- See "What is Cutting Plotter?" in Setup Manual for structure of the marking film.

Next page

3

Make sure that the tool bracket is engaged on the tool's flange, and then tighten the screw.

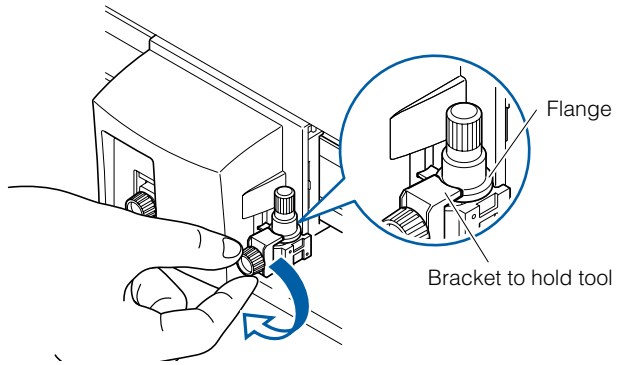

Both roll media and sheet media can be used with the FC8000. Load the media according to the instructions given for each type.

-  P.2-6 Loading Roll Media (Rear Loading)
-  P.2-9 Loading Roll Media (Front Loading)
-  P.2-11 Loading Sheet Media

## Loading Roll Media (Rear Loading "REAR SET")

### Operation

- 1 Lower the media set lever to raise the push rollers.

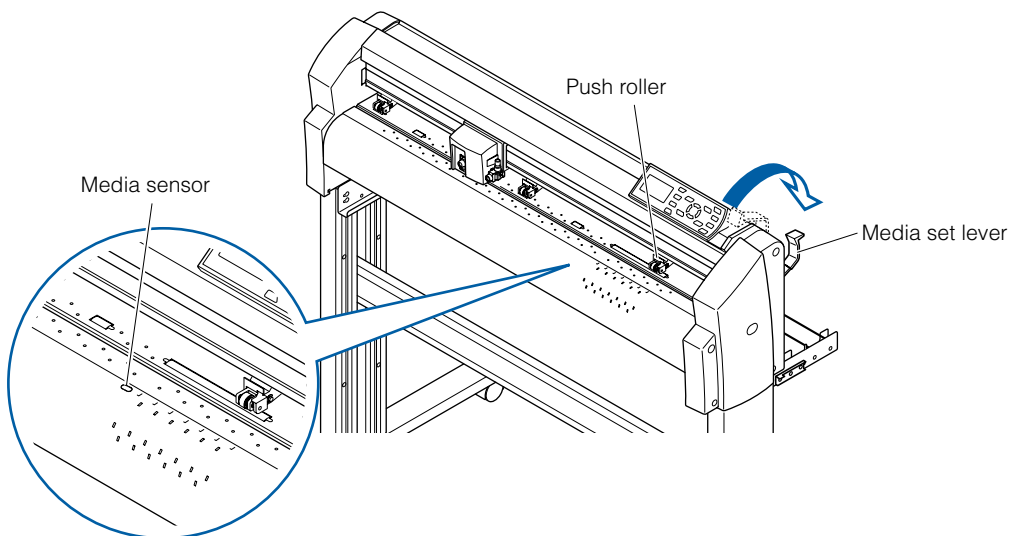

- 2 Place the media roll on the roll media stocker. Load the media in the plotter as shown. Pass the leading edge from the back of the plotter so it emerges from the front.

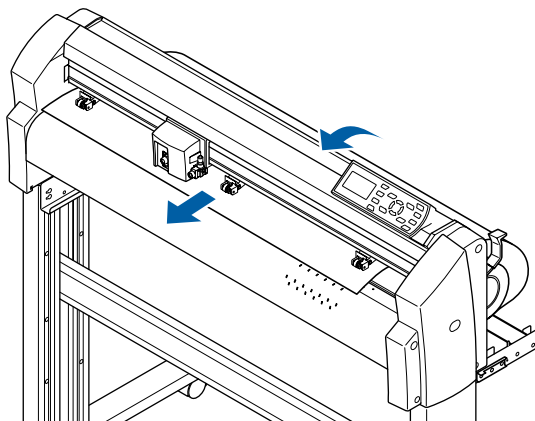

Next page

**3**

Press the media lock to engage it, and then pull the leading edge out of the front of the plotter so that it **completely covers the media sensor**.

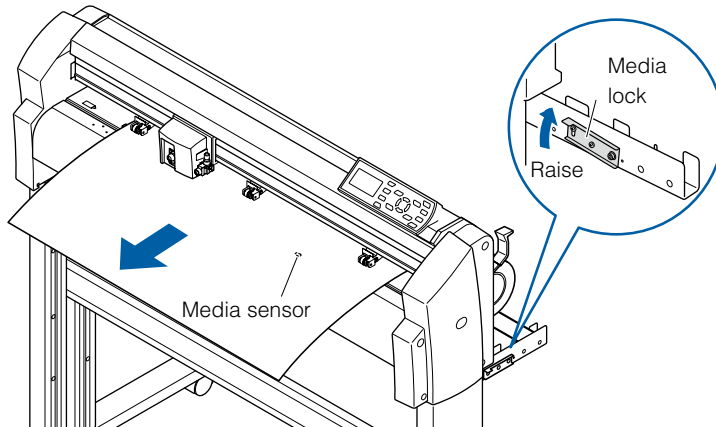
**4**

Position the media and the push rollers to correspond with the width of the media.

### When the Media Width is 160 to 540 mm

Position the two right-hand push rollers when the plotter is viewed from the front so that they are at the edges of the media. Make sure that the push rollers are both positioned over grit rollers. Move any push rollers that are not used to the standby position.

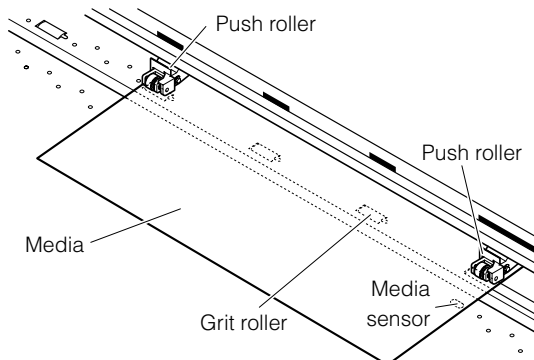

#### **Supplement**

- The media must always be positioned over the media sensor.
- See "Aligning the Push Rollers" [P-2-13](#) about the position of the push rollers.
- See "Standby the Push Roller" [P-2-13](#) about the standby position.

## When the Media Width Exceeds 540 mm

Position the three right-hand push rollers when the plotter is viewed from the front so that the left and right push rollers are at the edges and the middle push roller in the center of the media. Make sure that the push rollers are both positioned over grit rollers. Move any push rollers that are not used to the standby position.

If you wish to use all four of the FC8000-160 push rollers, position the two outermost push rollers at the edges of the media and the other two push rollers in between, making sure that the push rollers are all spaced equally, and that each push roller is positioned over a grit roller.

### Supplement

- The media must always be positioned over the media sensor.
- See "Aligning the Push Rollers" [P.2-13](#) about the position of the push rollers.
- See "Standby the Push Roller" [P.2-13](#) about the standby position.

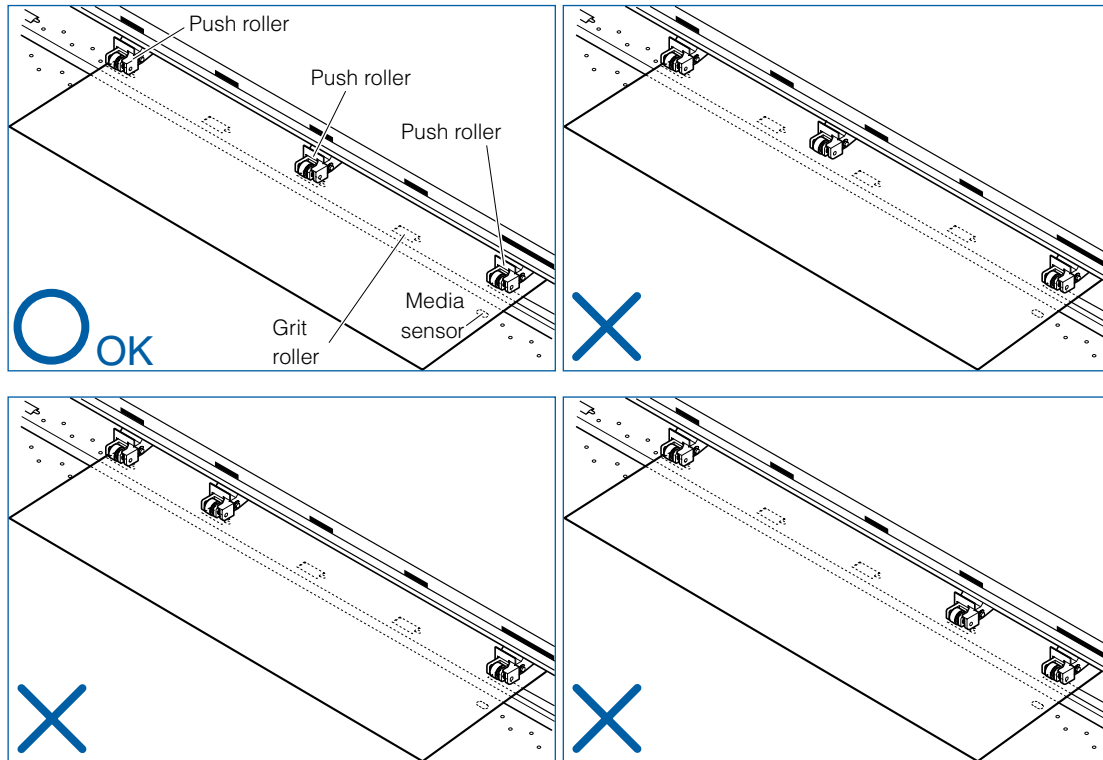

5

Pull the media taut to make sure that there is no slack in the conveyance path, and then raise the media set lever to lower the push rollers. Release (lower) the media lock.

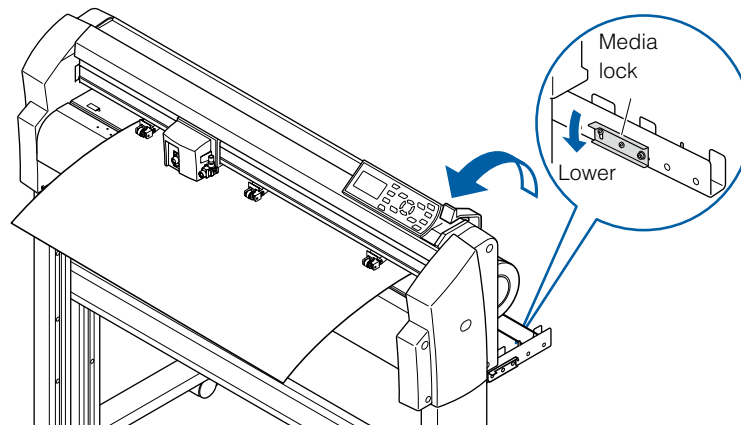

## Loading Roll Media (Front Loading "FRONT SET")

### Operation

- 1 Lower the media set lever to raise the push rollers.

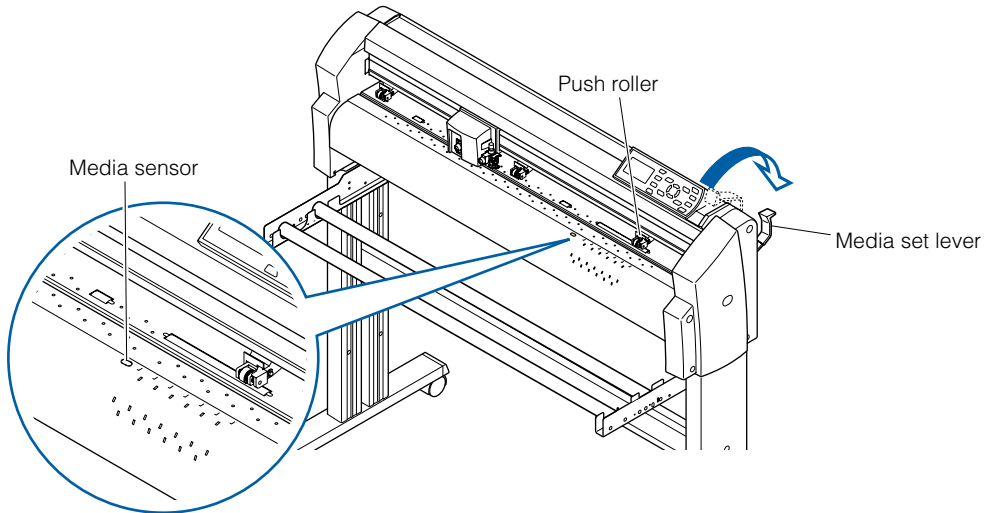

- 2 Place the media roll on the roll media stocker. Load the media in the plotter as shown. Pass the leading edge from the front of the plotter so it emerges from the back.

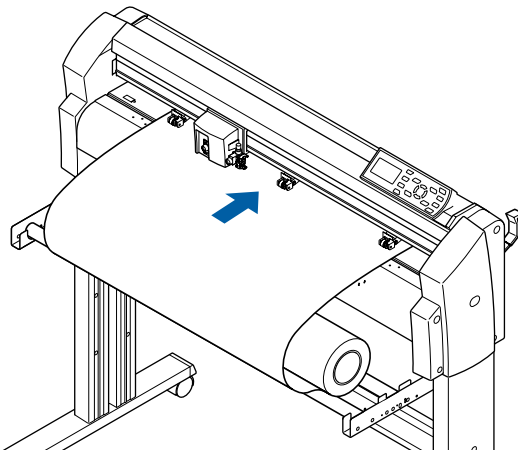

Next page



3

Press the media lock to engage it, and then pull the leading edge out of the front of the plotter so that it **completely covers the media sensor**.

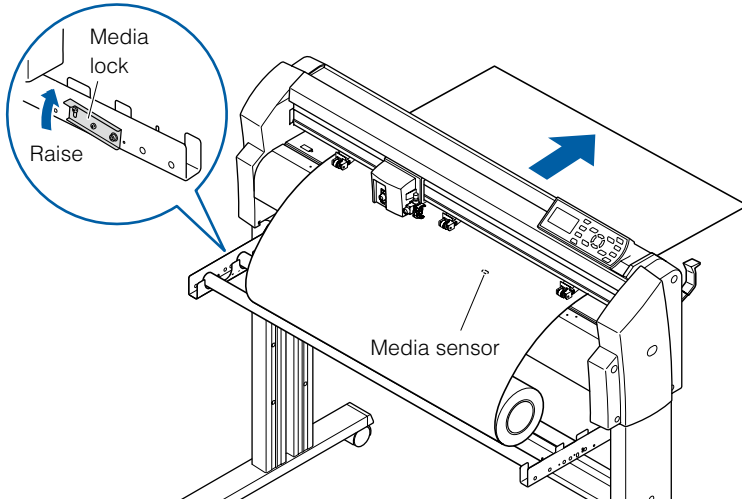

4

Position the media and the push rollers to correspond with the width of the media. (See step 4 of rear loading)

5

Pull the media taut to make sure that there is no slack in the conveyance path, and then raise the media set lever to lower the push rollers. Release (lower) the media lock.

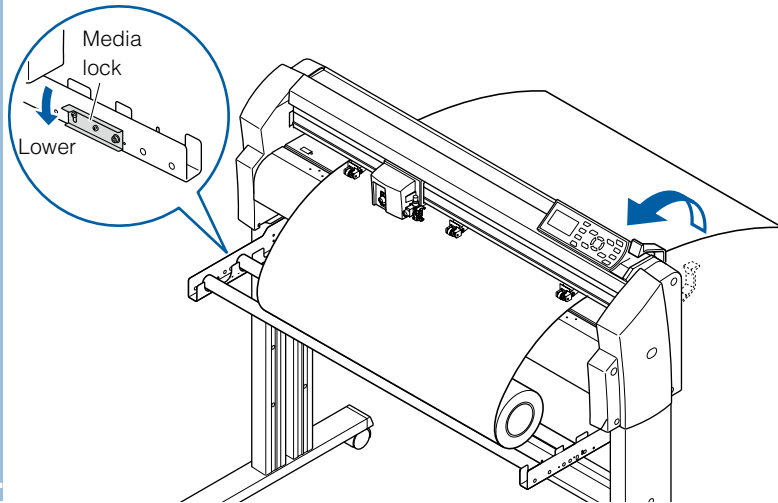

## Loading Sheet Media

### Operation

- 1 Lower the media set lever to raise the push rollers.

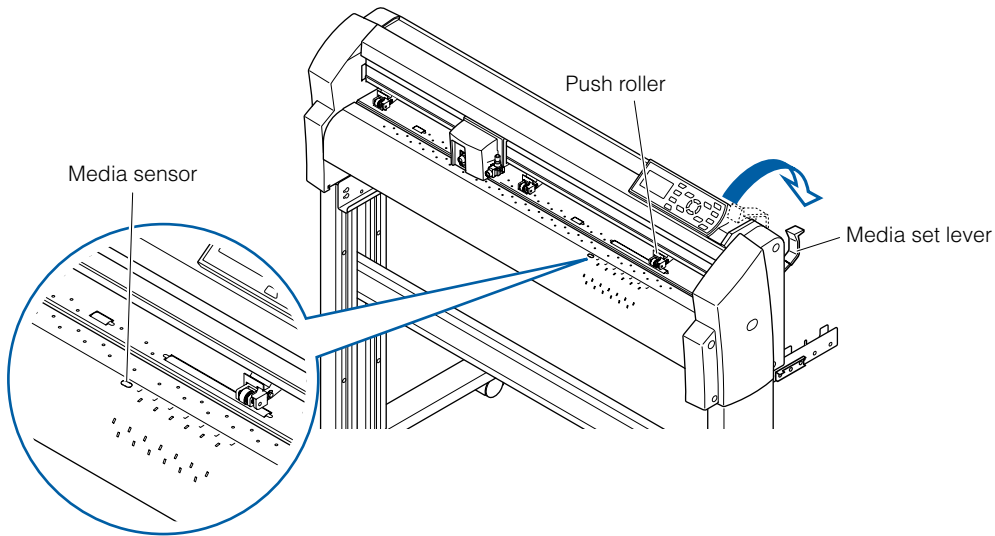

- 2 Pass the leading edge of the sheet from the rear of the plotter so that it emerges from the front, making sure that it **completely covers the media sensor**.

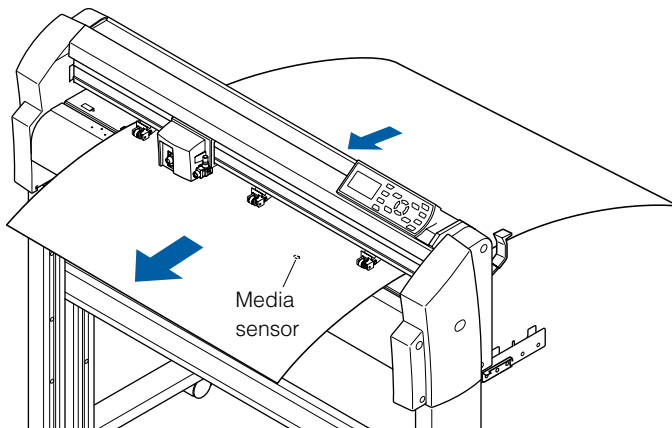

Next page

**3**

Position the media and the push rollers to correspond with the width of the media.

### When the Media Width is 100 to 160mm

Position the two right-hand push rollers so that they are above the long grit roller at the right edge of the plotter when the plotter is viewed from the front. Position the media so that its left edge is aligned with the left edge of the grit roller, and then position the push rollers over both edges. Move any push rollers that are not used to the standby position.

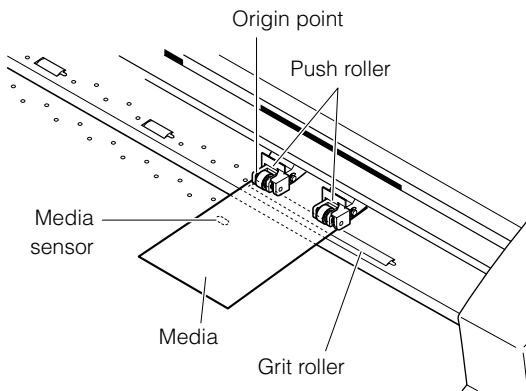

#### **Supplement**

- The media must be at least 125 mm in length.
- The media must always be positioned over the media sensor.
- See "Aligning the Push Rollers" [P.2-13](#) about the position of the push rollers.
- See "Standby the Push Roller" [P.2-13](#) about the standby position.

### When the Media Width is 160 to 540 mm or Exceeds 540 mm

See step 4 of rear loading.

**4**

Pull the media taut to make sure that there is no slack in the conveyance path, and then raise the media set lever to lower the push rollers. If you align the right edge of the sheet with the guides on the platen, the sheet can be loaded so that it is straight.

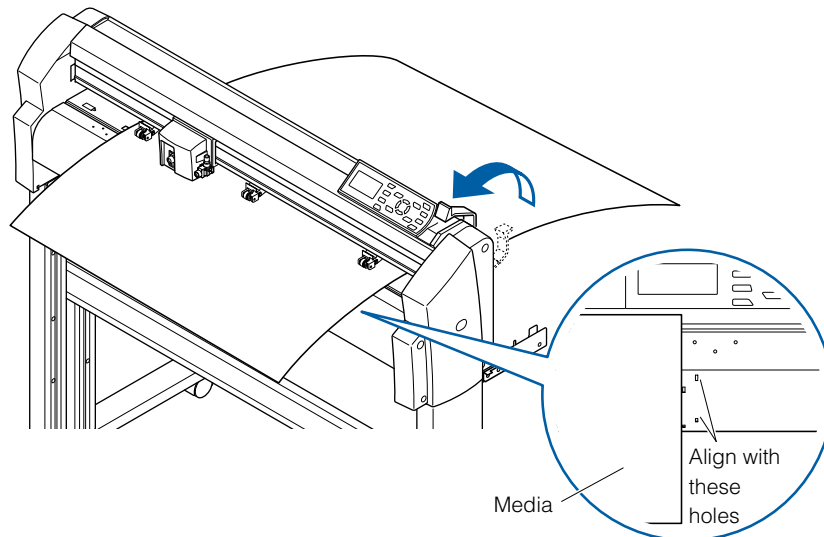

# 2-4 Aligning the Push Rollers

This section describes how to alignment of the push rollers.

## Standby of the Push Roller

With the FC8000-100/130/160 models, the number of push rollers required to hold down the media varies according to the width of the loaded media. Be sure to move a push roller that is not used to the standby position so that it does not affect the cutting or plotting operation.

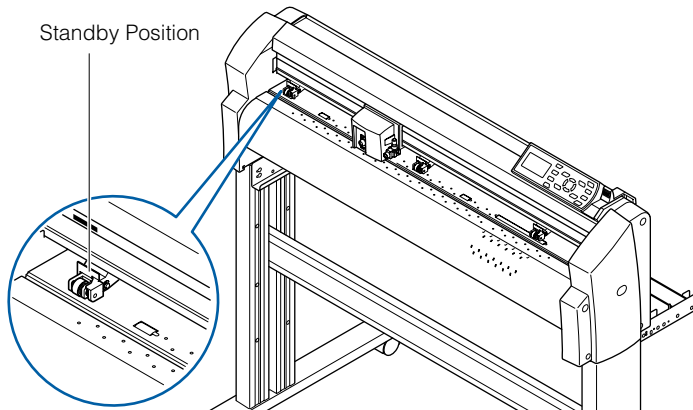

## Aligning the Push Roller

Position the left and right push rollers to correspond with the width of the media. Adjust the push rollers so that they are positioned above both the media and the grit rollers. Position the push rollers within the grit roller position stickers ensures that they are above the grit rollers.

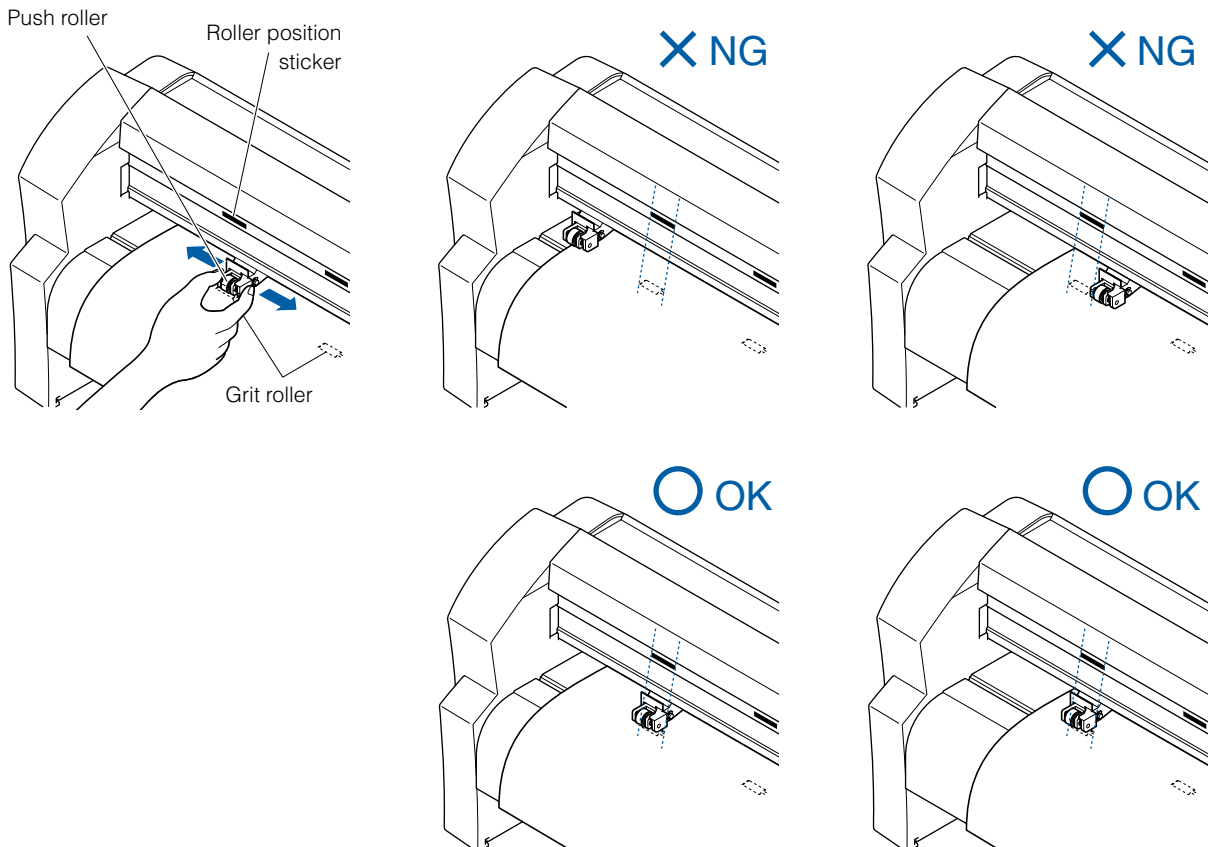

### CAUTION

To move the push rollers, the media set lever must be in the lowered position.

## When Feeding Long-axis Media (at least 2 meters)

Position the push rollers at least 15 mm inside the edges of the media.

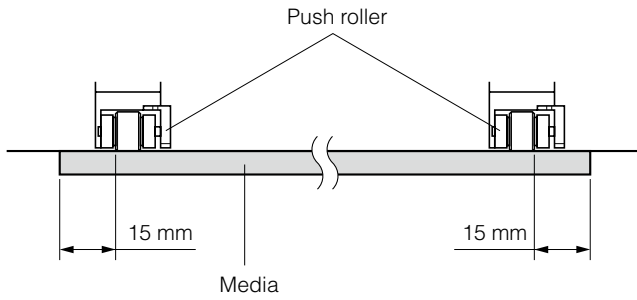

## **Changing the Hold-down Force**

The push roller hold-down force must be set to suit the width and type of the loaded media.

## Switching Between the Strong and Weak Settings

Use the hold-down force switching lever located at the back of each push roller to change the hold-down force. Raise the lever to decrease the hold-down force (Weak), and lower the lever to increase the hold-down force (Strong).

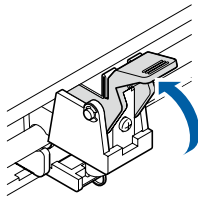

Hold-down force  
Weak

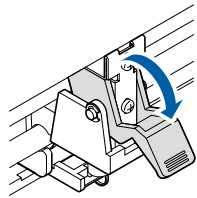

Hold-down force  
Medium

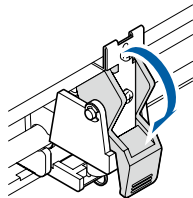

Hold-down force  
Strong

### **Supplement**

Weak hold-down force is the setting for holding the inside when cutting a very thin films, such as car film, using 3 or more push rollers.

### **CAUTION**

Weak hold-down force cannot be set to the push rollers at the end.

## Hold-down Force Assignments

Use the Strong or Medium setting for the push rollers used to hold down the edges of the media. Always use the weaker setting for the push roller(s) between the two outside rollers.

### When two push rollers are used

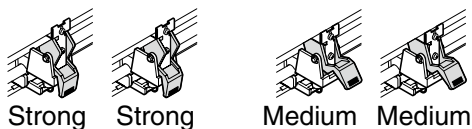

For right and left  
vice versa too

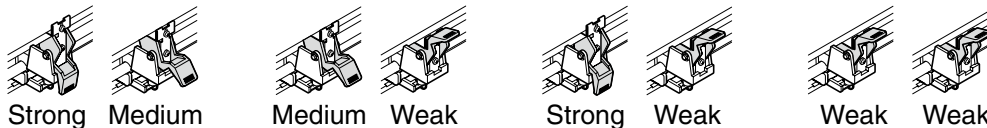

### When three push rollers are used

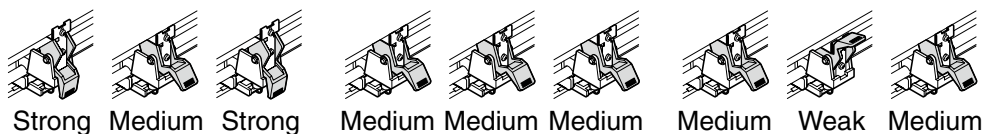

All others

### When four push rollers are used

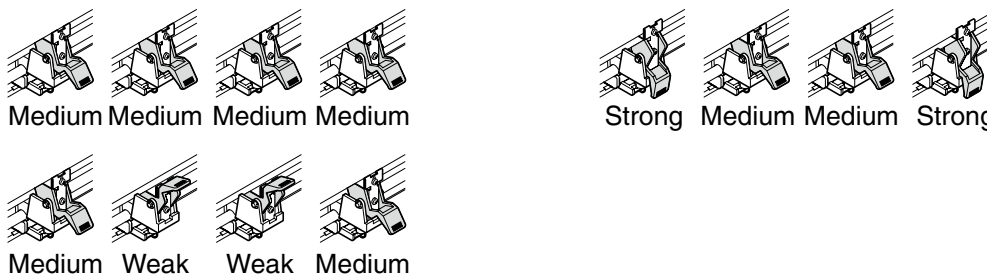

All others

# 2-5 Turning on the Power

Turning on the power of the plotter.

## Operation

- 1 Check that the power switch is turned off (the "○" side is pressed down).

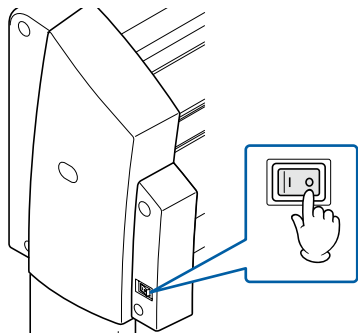

- 2 Connect one end of the provided power cord to the FC8000 AC line inlet and the other end to an electrical socket of the rated supply voltage. Make sure that the FC8000 is grounded using the 2/3 prong adapter for the outlet that is not 2 pin socket.

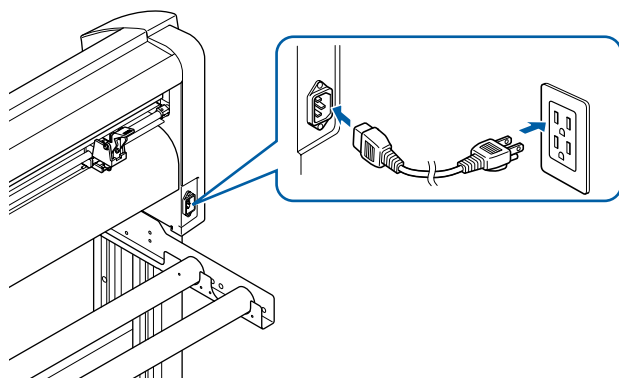

- 3 Turn on the FC8000 by pressing the "|" side of the switch. The control panel POWER lamp lights.

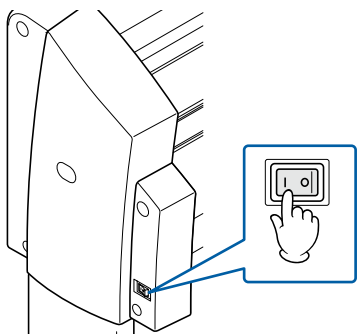

- 4 If media has not been loaded, the firmware version number is displayed, followed by a prompt to load media.

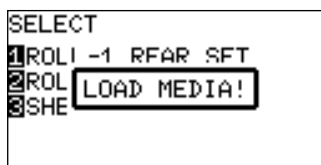

Media set lever raised

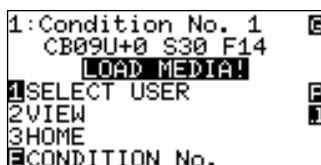

Media set lever lowered

### Supplement

- This screen is described as "default screen" in this document.
- Settings such as initial media feed speed and communication conditions can be performed.

# 2-6 How to Use Control Panel

This section explains the function of lamps and keys on the control panel.

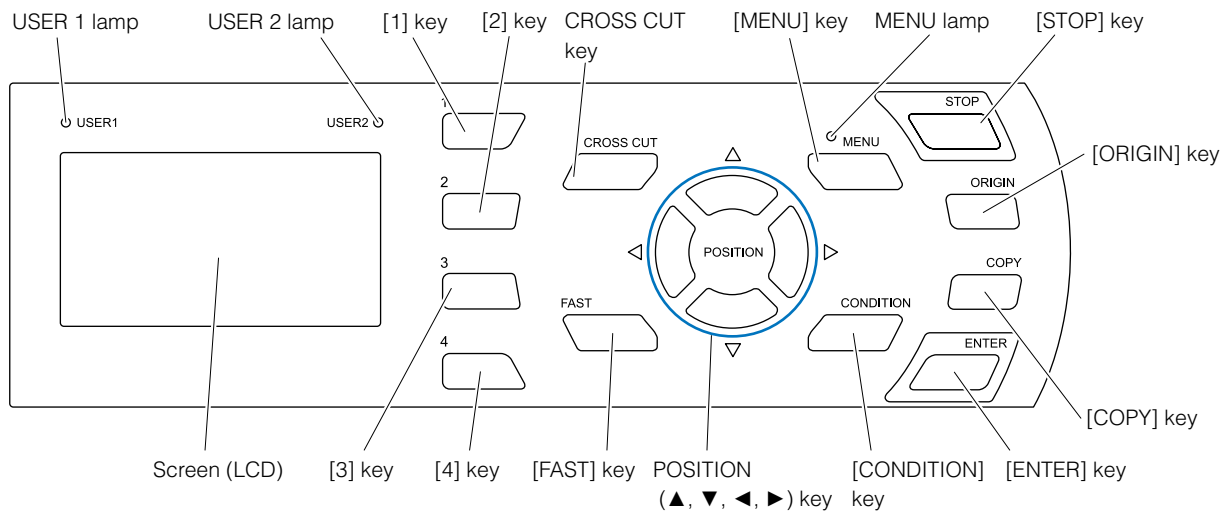

## Control Keys

- POSITION (▲, ▼, ◀, ▶) keys..... There are following functions depending on the operation.  
 Move the tool carriage and media. It will move specified distance (see "Setting of Step Movement Distance" [P.3-4](#)) when it is pressed once, and continuously move when it is pressed down. It will select the menu when ▲, ▼, ◀, or ▶ are displayed in the menu on the screen.
- FAST ..... The tool carriage or the media will move faster when it is pressed simultaneously with POSITION key. It will work as a menu key when it is displaying "F" on the screen.
- CROSS CUT ..... It will cut off the media that has finished cutting.
- STOP ..... Cutting operation will stop immediately when the [STOP] key is pressed while cutting. You can reset the media by pressing the [STOP] key while cutting when the media has shifted.
- ORIGIN ..... It will set the current position as an origin point.  
 The plotter is reset by pressing the [ENTER] key and the [ORIGIN] key simultaneously in the first screen of the MENU mode (MENU screen).
- COPY ..... Copy of data in the buffer memory is output.

## Menu Keys

- MENU ..... It will switch to the MENU mode. MENU lamp is lit in the MENU mode.  
 It will go into MENU mode if it is pressed once, and MENU mode will be turned off when it is pressed again.  
 Different function are set in the MENU mode.  
 Data received while in the MENU mode will be stored in the data buffer.
- CONDITION ..... It will display the screen to set the tool conditions.
- 1, 2, 3, 4 ..... Select the menu number displayed in the screen.
- ENTER ..... It will define the settings.  
 The plotter is reset by pressing the [ORIGIN] key and this key simultaneously in the first screen of the MENU mode (MENU screen).  
 It will display current cutting area when the [ENTER] key is pressed in READY status.

## Indicator Lamp

- MENU lamp ..... Green lamp is lit while in MENU mode.
- USER 1, 2 lamp ..... The lamp for selected user will lit.  
 The lamp is lit when the user priority is set to "Key, Controller". It will flash when it is set to "Key only".



## Reading the Screen (LCD)

Information reflecting the status will be displayed in the screen of the control panel.

Name of the button and corresponding function is displayed on the screen when a function is allocated to the button on the control panel. Button name will be displayed in reverse when the button is enabled.

Following items are displayed in the default screen.

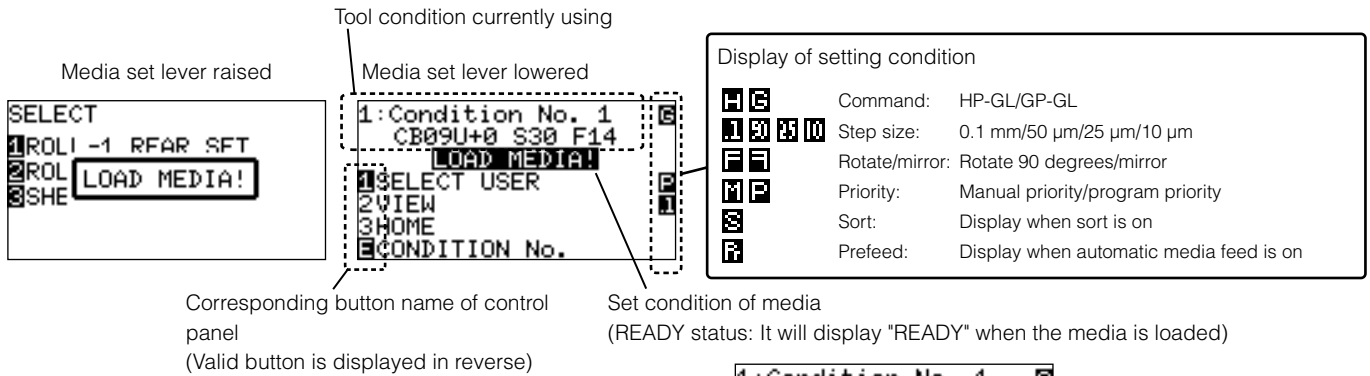

### Display of Default Screen

Screen to set the corresponding conditions is displayed when the [MENU] key or [CONDITION] key are pressed.

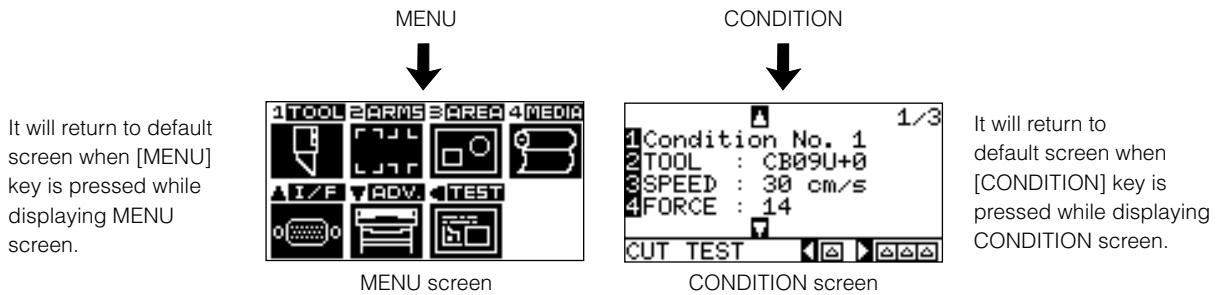

### MENU screen displayed by button operation

Page number is displayed in the upper right corner of the screen if there are too many settings or selection that will need multiple pages to display.

Press the **POSITION (▲▼)** key to move to different page.

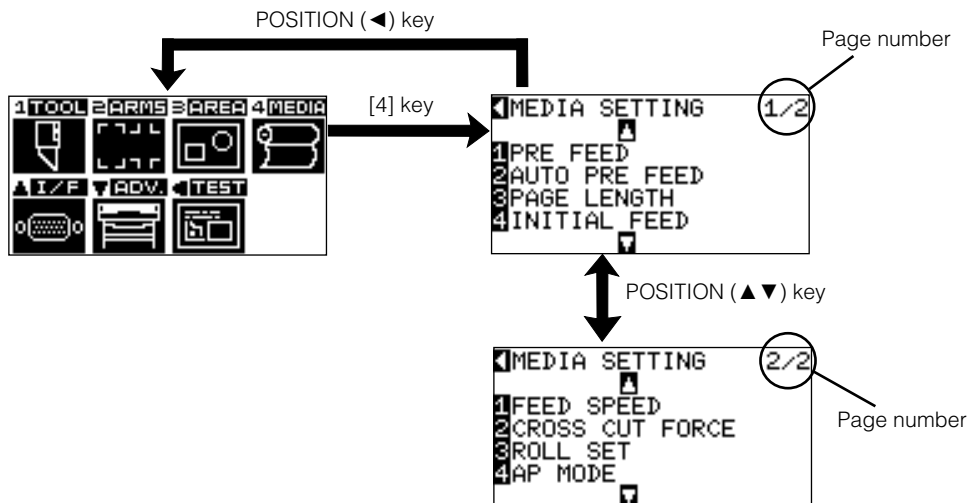

### Example of moving page and operation button

Icon of the corresponding operation button is displayed in the screen to change the setting values.



Increase or decrease the setting value using POSITION (▲▼) key. Select the change unit by [FAST] key.



Select the setting by number keys (1, 2, 3, 4) or POSITION (▲▼◀▶) keys.

Example of screen to change the settings value

## Contents of Operation from Menu Screen



MENU screen

Contents of the operation and settings that is displayed in MENU screen with [MENU] key is as following:

[1] (TOOL): Make the setting for the operation of the tool.

[2] (ARMS): Make the settings and operation to position the tool and media, such as automatic scanning of the registration marks by the ARMS.

[3] (AREA): Make the settings for area, magnification, rotation, reverse, etc., of the cutting.

[4] (MEDIA): Make the setting of the condition for the media.

[▲] (I/F): Make the settings of the condition for the interfacing with the control computer.

[▼] (ADV): Make the settings of the conditions for the basic operation of the plotter, such as display language, unit of the measurements, sensor, etc.

[◀] (TEST): Does the operation necessary for maintenance, such as self diagnostic test or printout of the condition settings list.

MENU: It will close the MENU screen and return to default screen.

**P.15-2** See the "Menu Tree" for list of the descriptions about each settings.

## Contents of Operation from CONDITION Key

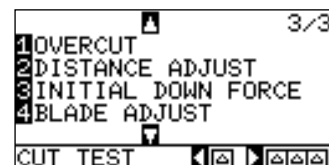
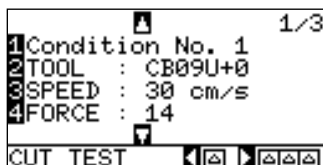

CONDITION screen (1-3)

Tool conditions are set in the setting screens displayed by the [CONDITION] key.

Up to 8 CONDITION settings can be saved with different settings in numbers 1 through 8.

CONDITION: It will clear the CONDITION screen and return to default screen.

**P.15-2** See the "Menu Tree" for list of the descriptions about each settings.

# 2-7 Setting Feeding Method

Feeding method for the loaded media is set.

 **P.2-6 Loading Roll Media (Rear Loading "REAR SET")**

 **P.2-9 Loading Roll Media (Front Loading "FRONT SET")**

## Operation

1 If you have already loaded the media, the MEDIA TYPE menu appears. Select the media type to suit the loaded media.

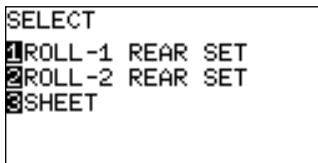

<Rear loading>

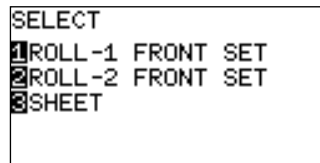

<Front loading>

Confirm the media lock is not locked, and press the SELECT.

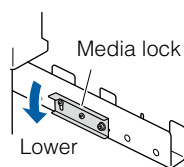
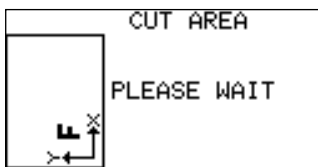

### CAUTION

Release the media lock before selecting SELECT.

### Supplement

- Previously used loading information is displayed first in the selection screen of rear loading or front loading.
- It is set to rear loading in the initial setting.
- The CONTINUE menu parameter appears when the media set lever is raised and then lowered again after media was previously loaded, making it possible to select the previous settings.

### When CONTINUE is selected by pressing the [4] key

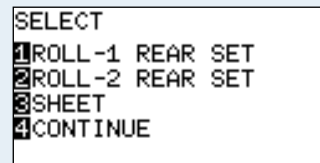

The CONTINUE function enables the continued use of the plotting area, pen position and origin position that were specified before the media set lever was lowered. If the current media is the same size as the last media that was loaded, the plotter does not detect the media's edges.

### When Selecting ROLL-1 REAR SET (ROLL-1 FRONT SET) by Pressing the [1] Key

Select this when you have loaded a roll of media and you wish to start cutting or plotting from the leading edge. The width and leading edge of the roll media are detected. The tool carriage moves to the origin point after the initialization routine has been executed.

Next page

## When Selecting ROLL-2 REAR SET (ROLL-2 FRONT SET) by Pressing the [2] Key

Select this when you have loaded a roll of media and you wish to start cutting or plotting from a point beyond the leading edge. Only the width of the roll media is detected.

## When pressing the [3] key to select SHEET

Select this when a cut sheet has been loaded. The leading edge, trailing edge, and width of the sheet are detected.

2

After the media is detected, the plotter is ready to receive data for cutting or plotting. This status is called "READY status" of the default screen. If the interface or command settings have not been made, make these settings before sending the data. If the settings have been made, tool adjustment is performed. When the pen adjustments have been made, the plotter is ready to start cutting. Send the cutting or plotting data from the application software.



## To Change the Loading Method

Direction to set the roll media is changed to change the loading method.

Default is rear loading.

3

Press the [MENU] key in the default screen.

►MENU screen is displayed.



4

Press the [4] key (MEDIA).

►MEDIA setting screen (1/2) is displayed.

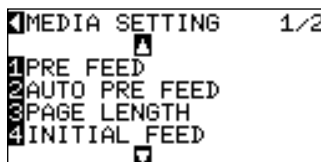

5

Press the **POSITION** (▼) key.

► MEDIA setting screen (2/2) is displayed.

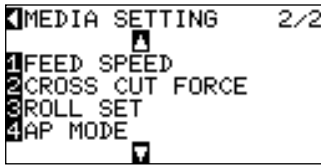
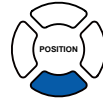

6

Press the **[3]** key (ROLL SET).

► ROLL SET change screen is displayed.



7

Press the **[1]** key (FRONT) or the **[2]** key (REAR).

8

Confirm the setting and press the **[ENTER]** key (SET).

► Setting will be set, and it will return to MEDIA setting screen (2/2).

9

Press the **[MENU]** key.

► It will return to the default screen.

**Supplement**

It will return to MEDIA setting screen (2/2) without changing the settings when you press the POSITION (◀) key (CANCEL).

The **PRE FEED** function is used to prevent the loaded media from slipping by automatically advancing the media the specified length and imprinting it with grit roller marks. This function can also be used to acclimate long media lengths to the operating environment in order to minimize media expansion and contraction, and to ensure stable media feed operations.

-  P.8-4 Perform Automatic Pre Feed When Cut Data is Received
-  P.8-6 Perform Automatic Pre Feed When Media is Set (Initial Feed)
-  P.8-7 Setting Feed Speed for the Pre Feed

## Operation

1 Press the **[MENU]** key in READY status.

►MENU screen is displayed.



2 Press the **[4]** key (MEDIA).

►MEDIA SETTING screen (1/2) is displayed.

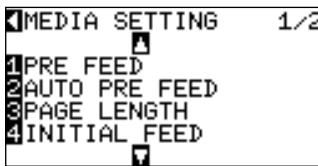

3 Press the **[1]** key (PRE FEED).

►FEED LENGTH setting screen is displayed.

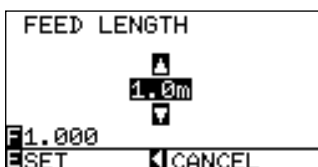

4 Press the **POSITION (▲▼)** key and increase or decrease the setting value.



5 Confirm the setting and press the **[ENTER]** key.

►Pre feed will start, and it will return to MEDIA setting screen (1/2).

6 Press the **[MENU]** key.

►It will return to default screen.

### Supplement

It will return to MEDIA setting screen (1/2) without changing the settings when you press the **POSITION (◀)** key (CANCEL).

# 2-9 Selecting Tool Condition

Tool conditions can be set in 8 settings from 1 to 8. Then, you can switch between 8 predefined different setting for different media by switching the settings.

## Operation

1 Press the **[CONDITION]** key in the default screen.

►CONDITION setting screen (1/3) is displayed.

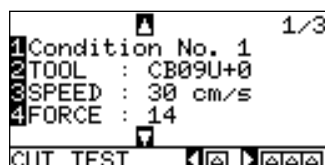

2 Press the **[1]** key.

►CONDITION No. selection screen is displayed.

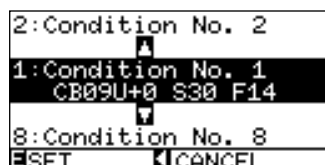

3 Press the **POSITION** (**▲▼**) key and select the setting (CONDITION No.).

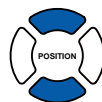

4 Confirm the setting and press the **[ENTER]** key (SET).

►Setting will be set, and it will return to CONDITION screen (1/3).

5 Press the **[CONDITION]** key.

►It will return to the default screen.

### Supplement

- Name of the media assigned in "Cutting Plotter controller" is displayed as the CONDITION No. name.
- CONDITION No. can also be changed from READY status. See "Changing CONDITION No." [P.3-6](#).

### Supplement

It will return to CONDITION screen without changing the settings when you press the POSITION (**◀**) key (CANCEL).

## Setting the Tool Condition

This section describes how to make the tool, speed, force, acceleration, and tool number settings.

Before cutting media, the following five cutter-pen conditions must be specified.

- (1) Cutter-blade length .....Adjust the blade length by referring to the media thickness table below.
- (2) FORCE .....Set the FORCE by referring to the table below.
- (3) SPEED:.....Set the SPEED by referring to the table below.
- (4) QUALITY .....Set the QUALITY by referring to the table below.
- (5) OFFSET .....Set to suit the cutter blade being used.

### Supplement

- See the appropriate references for details about the "Setting Cut Line Pattern" [P.7-15](#), "Setting the Tangential Emulation" [P.7-3](#), "Setting Length of the Overcut" [P.7-4](#), "Setting the Distance Adjust" [P.7-13](#), and "Setting of the Initial Down Force" [P.7-6](#).
- See "Adjust the Blade Length Manually" [P.2-31](#) and "Adjust the Blade Length (Automatic Height Adjust)" [P.2-36](#) for blade length adjustment methods.

## Optimal Cutting Conditions for Each Media Type

Media type	Thickness (mm)	Blade used	Force	Speed	QUALITY
Film for outdoor use	0.05 ~ 0.08	CB09UA	10 ~ 14	30 or under	3 ~ 4
Film for decorative use	0.08 ~ 0.1	CB09UA	14 ~ 17	30 or under	3 ~ 4
Film for outdoor use	0.05 ~ 0.08	CB15UB	10 ~ 14	20 or under	1
Transparent or semitransparent film	0.08 ~ 0.1	CB09UA	14 ~ 20	30 or under	3 ~ 4
Reflective film	0.08 ~ 0.1	CB09UA	14 ~ 20	30 or under	3 ~ 4
Fluorescent film	0.20 ~ 0.25	CB09UA, CB15U	20 ~ 24	10 ~ 20	2 ~ 3
Thick materials	0.5 ~ 0.1	CB15U-K30	17 ~ 24	5 ~ 15	2 ~ 3
High-intensity reflective film	0.25 ~ 0.3	CB15UA	24 ~ 35	5 ~ 40	1
Paint protection film		CB09UA	14 ~ 35	30	4

## Blade Part Nos., Displayed Blade Types, and CUTTER OFFSET Values

Blade material/tool	Blade type	LCD panel indication		Setting range	Setting value for OTHER
		Blade (tool) type	Default value		
Ultra-hard blade	CB09UA	CB09U	0	±5	18
	CB15U-K20-SP	CB15-10U	0	±5	28
	CB15U	CB15U	0	±5	28
	CB15UA	CB15U	0	±5	28
	CB15UB	CB15UB	0	±5	5
	CB15U-K30	CB15U-K30	0	±5	28
Other		OTHER	1	1 ~ 45	–
Pen		PEN	N/A	N/A	0
Pouncing		POUNCE	0.0 mm (between the holes)	1 ~ 99	–
Light Pointer		LIGHT POINTER	N/A	N/A	0

When a blade type has been selected, the OFFSET is automatically adjusted by ±5 with respect to the default cutter offset value for that blade type.

Select OTHER to use settings other than those displayed for hard-to-cut media. Select PEN when a plotting pen has been mounted in the plotter. Select POUNCE when a pouncing tool has been mounted in the plotter.

## Reference Pen Conditions for Plotting Pens

Pen type	Part no.	FORCE	SPEED (cm/s)	QUALITY
Water-based fiber-tip pen	KF550 Series	10 ~ 12	30	4
Disposable ink pen	SD pens (PHP33-INK)	7 ~ 8	20	2
Oil-based ballpoint pen	KB140 Series (PHP31-BALL)	21 • 22	60	4

To prolong the pen life, set the FORCE to the lowest setting, and set the SPEED after checking to confirm that there are no faint lines or other problems during plotting.



## CAUTION

### When cutting high intensity reflective media

The backing sheet used for the high intensity reflective media is very soft, so it will need a reinforcement. Reinforce by affixing a media on the back side of the backing sheet, where the grit roller will be.

(Recommended affixing media stiffness: As cutting sheet from Nakagawa Chemical, Inc.)

### How to Improve Weedability

We recommend that you observe the following points to improve the weedability of color marking film.

- Select the correct blade for the application  
CB09UA: Use this blade for general color marking film applications.  
CB15UB: Use this blade for cutting small text (with a height that is less than 10 mm) on color marking film.
- Use blades that are not worn.  
If the blade is worn, it will not cleanly and the cut results will be difficult to weed.
- Adjust the blade-length and FORCE settings until only traces of the blade are left on the backing sheet.  
Specify a FORCE value that is as low as possible, but that still leaves faint traces on the backing sheet.
- Set the SPEED and QUALITY values as low as possible.
- Weed the cut results right after cutting has been completed.  
If time is allowed to elapse, adhesive along the cut edges will cause the edges to stick together.
- Select media with good weedability.  
Recommended film types: 3M Scotchcal Electro Cut, 3M Scotchcal Master Cut  
Weeding refers to the removal of un wanted areas of vinyl from the background after the media has been cut.

### Supplement

- Quality will become coarser, but the cut time is decreased when the settings for the speed and acceleration is set higher. Especially with the large media, good cut quality might not be achieved by rumbling media. Decrease the values for the speed and quality settings in that case.
- Quality will become good, but the cut time will increase when the settings for the speed and acceleration is set smaller.

## Setting the Tool

Set the type and offset value of the tool that is used in each of the tool condition numbers.

### Operation

1 Press the **[CONDITION]** key in the default screen.

▶CONDITION setting screen (1/3) is displayed.

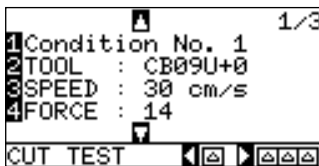

2 Press the **[2]** key (TOOL).

▶TOOL setting screen is displayed.

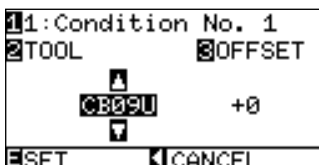

### Supplement

It will return to CONDITION screen without changing the settings when you press the POSITION () key (CANCEL).

 Next page

3

Press the [1] key.

►CONDITION No. selection screen is displayed.

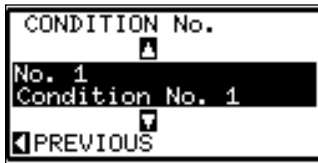

\* Display may vary depending on the selected condition number.

4

Press the **POSITION** (▲▼) key and select the condition number (CONDITION No.).



5

Confirm the setting and press the **POSITION** (◀) key (PREVIOUS).

►CONDITION No. will get set and return to TOOL setting screen.

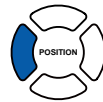

6

Press the **POSITION** (▲▼) key, and set the tool.

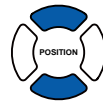
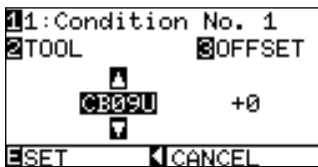

7

Press the [3] key (OFFSET).

►OFFSET setting screen is displayed.

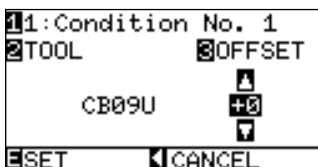

\* Display may vary depending on the selected condition number.

### Supplement

- It will return to CONDITION screen without changing the settings when you press the POSITION (◀) key (CANCEL).
- Tools that can be selected are as following: CB09U, CB15U-K20-SP, CB15U, CB15UB, CB15U-K30, OTHER, POUNCE, LIGHT POINTER, PEN

### Supplement

- What is Offset

It will adjust the difference between the tip of the blade in the plunger and the center of the plunger. There are standard adjustment values for each cutter blades. Fine adjustment will be made to that standard values here. (Adjustment will be made with standard value as 0.)

It is not necessary to set the offset if "Pen", "Pouncing", or "Light Pointer" was selected in the tool settings.

- Guideline to Set Offset

Blade material/tool	Blade type	Setting range	Setting value for OTHER
Ultra-hard blade	CB09U	± 5	18
	CB15U-K20-SP	± 5	28
	CB15U	± 5	28
	CB15UB	± 5	5
	CB15U-K30	± 5	28
Other*	—	1 ~ 45	1

\*Set for the setting values not displayed in the cutter blade type when cutting the media that is hard to cut.

- Guideline to Set Pouncing

Blade material/tool	Setting range (intervals)	Setting value for OTHER
Pouncing	1 ~ 99	1

- To return to continue the settings of other tool condition number, return to step 3 by pressing the [1] key.

Next page

8 Press the **POSITION** (**▲▼**) key and increase or decrease the setting value.



9 Confirm the setting and press the **[ENTER]** key (SET).

▶ Setting will be set, and it will return to CONDITION screen (1/3).

10 Press the **[CONDITION]** key.

▶ It will return to default screen.

## Setting the Speed

Set the speed of the tool that is used in each of the condition numbers. (Setting range: 1 to 10 (in 1 cm/s increment), 10 to 105 (in 5 cm/s increment))

### Operation

1 Press the **[CONDITION]** key in the default screen.

▶ CONDITION setting screen (1/3) is displayed.

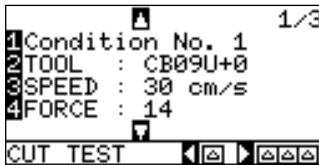

2 Press the **[3]** key (SPEED).

▶ SPEED setting screen is displayed.

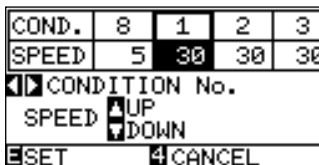

\* Display may vary depending on the selected tool condition number.

3 Press the **POSITION** (**◀▶**) key and select the tool condition number (CONDITION No.).



4 Press the **POSITION** (**▲▼**) key and increase or decrease the setting value.

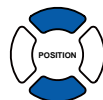

5 Confirm the setting and press the **[ENTER]** key (SET).

▶ Setting will be set, and it will return to CONDITION screen (1/3).

6 Press the **[CONDITION]** key.

▶ It will return to the default screen.

#### Supplement

It will return to CONDITION screen (1/3) without changing the settings when you press the [4] key (CANCEL).

#### Supplement

Guideline to set speed

See "Setting the Tool Condition" P.2-24 .

# Setting the Force

Set the cutting force that is used in each of the condition numbers. (Setting range: 1 to 48)

## Operation

1 Press the [CONDITION] key in the default screen.

▶ CONDITION setting screen (1/3) is displayed.

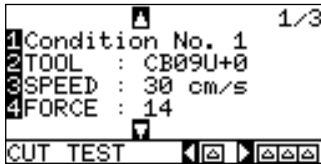

2 Press the [4] key (FORCE).

▶ FORCE setting screen is displayed.

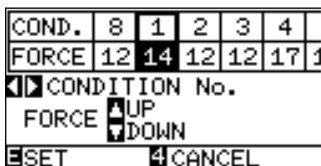

\* Display may vary depending on the selected condition number.

3 Press the POSITION (◀▶) key and select the condition number (CONDITION No.).

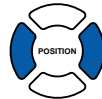

4 Press the POSITION (▲▼) key and increase or decrease the setting value.

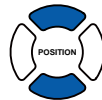

5 Confirm the setting and press the [ENTER] key (SET).

▶ Setting will be set, and it will return to CONDITION screen (1/3).

6 Press the [CONDITION] key.

▶ It will return to the default screen.

### Supplement

It will return to CONDITION screen (1/3) without changing the settings when you press the [4] key (CANCEL).

### Supplement

Guideline to set force

See "Setting the Tool Condition" P.2-24 .

# Setting the Acceleration

Set the acceleration of the tool that is used in each of the tool condition numbers. (Setting range: 1 to 8)

## Operation

1 Press the **[CONDITION]** key in the default screen.

▶CONDITION setting screen (1/3) is displayed.

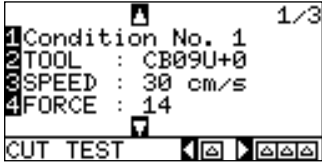

2 Press the **POSITION (▼)** key.

▶CONDITION setting screen (2/3) is displayed.



3 Press the **[1]** key (ACCEL.).

▶ACCEL setting screen is displayed.

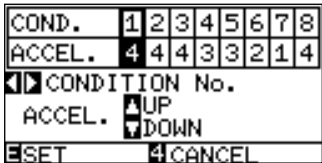

\* Display may vary depending on the selected tool condition number.

4 Press the **POSITION (◀▶)** key and select the tool condition number (CONDITION No.).



5 Press the **POSITION (▲▼)** key and increase or decrease the setting value.

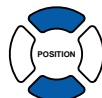

6 Confirm the setting and press the **[ENTER]** key (SET).

▶Setting will be set, and it will return to CONDITION screen (2/3).

7 Press the **[CONDITION]** key.

▶It will return to the default screen.

### Supplement

It will return to CONDITION screen (2/3) without changing the settings when you press the [4] key (CANCEL).

### Supplement

Guideline to set acceleration

See "Setting the Tool Condition" [P.2-24](#).

## Adjust the Blade Length Manually

Optimal cut is not achieved unless the blade length is adjusted in accordance to the used media and the cutter blade. Perform further adjustment by performing cutting test after adjusting the blade length manually.

### CAUTION

- To avoid bodily injury, handle cutter blades with care.
- It may result to damaging the cutter blade or the cutting mat if the blade is extended too much. Make sure the blade length is set less than the thickness of the media.

### Supplement

- See "Running Cutting Tests" [P.2-34](#) for cutting tests.
- See "Adjust the Blade Length (Automatic Height Adjust)" [P.2-36](#) for method to adjust the blade length with automatic height adjust.

## Operation

- 1 Align the blade tip to the tip of the cutter pen, and make it touch the surface of the media.

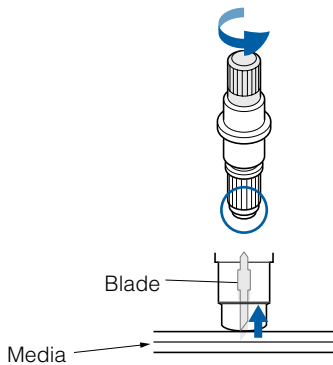

- 2 Extend the blade little by little to the thickness of the media. Optimal blade length is less than the thickness of film and backing sheet combined, but more than the thickness of the film. Try cutting the film, and adjust so there is slight cutting on the backing sheet. If the backing sheet gets cut completely, reduce the blade length, and if the film does not get cut completely, increase the blade length.

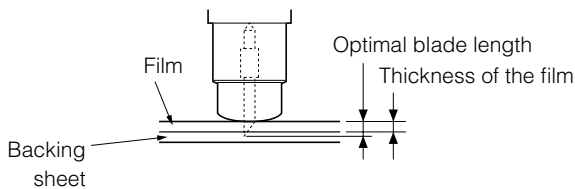

### Supplement

- Adjust the blade length by turning the blade-length adjustment knob. Turn the knob to right to extend the blade, or to left to retract the blade. When the knob is turned by one scale unit, the blade moves approximately 0.1 mm.

Cutter blade moves approximately 0.1 mm turning one scale unit

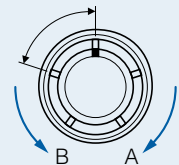

- Guideline to Set the Blade Length

See "Setting the Tool" [P.2-24](#) for the thickness of the media.

# Setting the Tool Number

Set the tool that is used in each of the tool condition numbers. (Setting range: 1 to 3)

## Operation

1 Press the [CONDITION] key in the default screen.

▶CONDITION setting screen (1/3) is displayed.

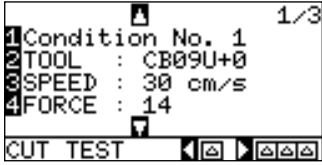

2 Press the POSITION (▼) key.

▶CONDITION setting screen (2/3) is displayed.



3 Press the [3] key (ASSIGN TOOL).

▶ASSIGN TOOL setting screen is displayed.

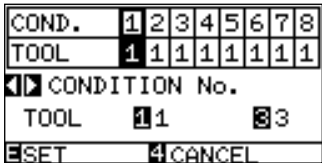

\* Display may vary depending on the mounted tool.

4 Press the POSITION (◀▶) key and select the tool condition number (CONDITION No.).



### Supplement

It will return to CONDITION screen (2/3) without changing the settings when you press the [4] key (CANCEL).

### Supplement

● Tool number and attached position

For half cutting (backward)

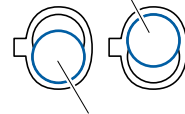

For cutting out (forward)

TOOL 1: When using the tool attached in backward position of the tool folder

TOOL 2: When using the tool attached on the tool station with the 2 pen option

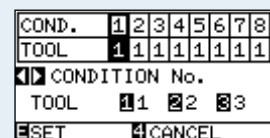

TOOL 3: When using the tool attached in forward position of the tool holder

● Attaching methods of the tool

See "Attaching a Tool" [P.2-4](#) and "2-Pen Assignment (Switching the Tools)" [P.14-7](#).

Next page

5

Confirm the setting and press the **[ENTER]** key (SET).

▶ Setting will be set, and it will return to CONDITION screen (2/3).

6

Press the **[CONDITION]** key.

▶ It will return to default screen.



Test cutting can be performed after making the tool, speed, force, and acceleration settings to ensure that the selected cutting conditions actually produce the desired cutting results. Check how far the blade cuts into the media and how the corners are being cut. If the cutting results are not satisfactory, adjust the various settings and repeat the test cutting until the optimal settings are achieved.

## Cutting Test

Perform the cutting test by deciding to make 1 cut with set value only, or to make 3 cuts with set value and  $\pm 1$  of set value, depending on the condition.

### To make 1 cut with set value

#### Operation

- 1 Load the media for test cutting in the plotter.
- 2 Press the **[CONDITION]** key in the default screen.  
▶CONDITION screen (1/3) is displayed.

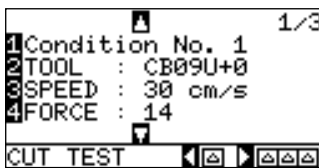

- 3 Press the **POSITION** (**◀**) key (CUT TEST).



- 4 Press the **POSITION** (**▲▼◀▶**) key the tool carriage to the location you wish to perform the test cutting.



- 5 Press the **[ENTER]** key.  
▶1 cut test pattern is cut.

- 6 Press the **[ENTER]** key after completion.  
▶CONDITION screen (1/3) is displayed.

- 7 Press the **[CONDITION]** key.  
▶It will return to the default screen.

#### Supplement

It will return to CONDITION screen (1/3) by pressing the [4] key (CANCEL).

#### CAUTION

When the [ENTER] key is pressed, the tool carriage will start moving, so take care not to cut your fingers.

## To make 3 cuts with set value and $\pm 1$ of set value

### Operation

- 1 Load the media for test cutting in the plotter.
- 2 Press the **[CONDITION]** key in the default screen.

►CONDITION screen (1/3) is displayed.

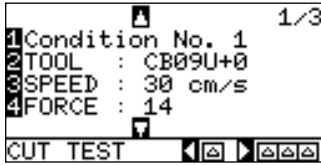

- 3 Press the **POSITION (▶)** key (CUT TEST).

►CUT TEST screen is displayed.

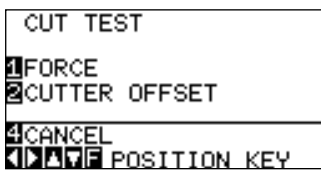

- 4 Press the **POSITION (▲▼◀▶)** key the tool carriage to the location you wish to perform the test cutting.



- 5 Press the **[1]** key (FORCE).

►3 cutting test patterns are cut, with current FORCE in the center, and 1 each of FORCE increased and decreased for 1.

- 6 Press the **[ENTER]** key after completion.

►It will return to CUT TEST menu screen.

- 7 Press the **[2]** key (CUTTER OFFSET).

►3 cutting test patterns are cut, with current CUTTER OFFSET in the center, and 1 each of CUTTER OFFSET increased and decreased for 1.

- 8 Press the **[ENTER]** key after completion.

►It will return to CUT TEST menu screen.

- 9 Press the **[CONDITION]** key.

►It will return to the default screen.

#### Supplement

It will return to CONDITION screen (1/3) by pressing the [4] key (CANCEL).

#### CAUTION

When the [1] key (FORCE) is pressed, the tool carriage will start moving, so take care not to cut your fingers.

#### CAUTION

When the [2] key (CUTTER OFFSET) is pressed, the tool carriage will start moving, so take care not to cut your fingers.

## Confirm the Results of the Cutting Test

Confirm the cutting test results, and adjust to optimal setting. Repeat cutting test and adjustment until optimal cut is achieved.

### Adjustment of Offset

Check the corners of the triangles and rectangles. See "Setting the Tool" [P.2-26](#) and adjust the offset value if the corner is not cut or if it is cut too much.

#### Supplement

How to check offset

Check if the offset value is set correctly by following.



Not enough adjustment. Increase the offset value.



Optimal offset value.



Too much adjustment. Decrease the offset value.

### Adjustment for Half Cutting

Peel off the triangle area, and adjust so it cuts slightly into the backing sheet.

If the backing sheet has been cut through, either the FORCE setting is too high or the cutter-blade tip is extended too far. If the backing sheet shows only a few traces of the cutter blade, either the FORCE setting is too low or the cutter blade tip is not sufficiently extended.

#### Supplement

See "Adjusting the Blade Length" [P.2-2](#) and "Setting the Force" [P.2-29](#), and adjust the settings.

### Adjustment for Cutting Out

Adjust so the media is completely cut out.

If the media is not completely cut, either the FORCE setting is too low or the cutter blade tip is not sufficiently extended.

See "Adjusting the Blade Length" [P.2-2](#) and "Setting the Force" [P.2-29](#), and adjust the settings.

### Adjustment When Using Plotting Pen

Adjust the FORCE so there will be no faint lines. To prolong the pen life, set the FORCE to the lowest setting without any faint lines. See "Setting the Force" [P.2-29](#) for setting the FORCE.

## Adjust the Blade Length (Automatic Height Adjust)

Test cutting must be performed several times in order to confirm the optimal blade length setting. However, if the blade length adjustment function is used, the optimal length can be easily set.

### Operation

- 1 Load the media for test cutting in the plotter.
- 2 Press the **POSITION** (**▲▼◀▶**) key the tool carriage to the location you wish to perform the blade length adjustment.



Next page

3 Press the [CONDITION] key in the default screen.

▶CONDITION screen (1/3) is displayed.

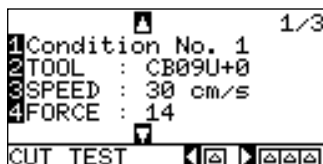

4 Press the POSITION (▲) key.

▶CONDITION setting screen (3/3) is displayed.

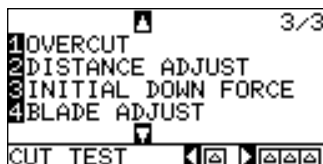

5 Press the [4] key (BLADE ADJUST).

▶Message prompting to turn the blade-length adjustment knob is displayed.



6 As instructed, turn the blade length adjustment knob to the left to fully retract the blade.

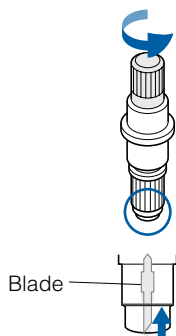

7 Press the [ENTER] key.

▶BLADE ADJUST screen is displayed.

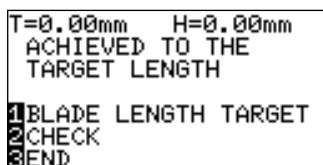

### Supplement

See "Structure of Cutter Pen" [P.2-2](#) for blade-length adjustment knob.

8

Press the [1] key (BLADE LENGTH TARGET).

▶BLADE LENGTH TARGET screen is displayed.



9

Press the **POSITION** (▲▼) key and increase or decrease the setting value.

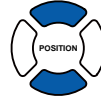

10

Confirm the settings and press the **POSITION** (◀) key (PREVIOUS).

▶BLADE LENGTH TARGE is set and it will return to the BLADE LENGTH setting screen.

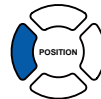

11

Press the [2] key (CHECK).

▶The amount and direction to turn the adjustment knob is displayed.

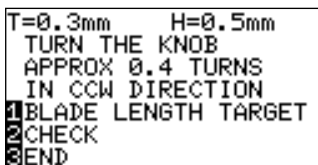

12

Turn the blade-length adjustment knob and adjust the cutter blade length.

[2] Current blade length is displayed by pressing the [2] key (CHECK), so adjust the blade length until it matches the thickness of the media.

13

Press the [3] key (END).

▶Adjustment is completed and it will return to CONDITION screen (3/3).

14

Press the [CONDITION] key.

▶It will return to default screen.

### Supplement

"T" is the target value of the blade length, and "H" is the current blade height (amount).

### CAUTION

Depending on the loaded media, the blade might sink in to the media, making accurate measurement impossible.

# Chapter 3: Basic Operations

**This chapter describes the basic methods to operate the plotter manually.**

**All the operations described in this chapter is to start from the READY status (media is set) as a general condition. Perform the operation described in this chapter after making the plotter in READY status referring to previous chapter.**

This is a function to raise or lower the tool (pen).

## Operation

1 Press the [MENU] key.

►MENU screen is displayed.



2 Press the [1] key (TOOL).

►TOOL SETTING screen is displayed.

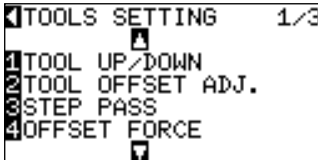

3 Tool is raised or lowered every time the [1] key (TOOL UP/DOWN) is pressed.

4 Press the [MENU] key.

►It will return to default screen.

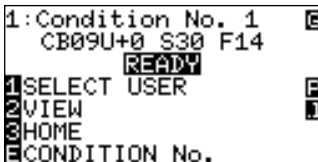

Tool carriage and media can be moved manually using the POSITION key.

It also can move the tool carriage and media to the origin, or move it certain distance to keep it away.

### Continuously Move Manually

It can manually move continuously when the screen is displaying "READY", or when the POSITION (▲▼◀▶) key is displayed.

#### Operation

1 Continuously press the POSITION (▲▼◀▶) key.

- ▶ Tool carriage or the media will keep on moving toward the direction of the pressed POSITION key.



#### Supplement

Tool carriage will move faster when [FAST] key is pressed simultaneously with POSITION key.

2 Release the POSITION (▲▼◀▶) key.

- ▶ Movement of the tool carriage or the media will stop.

### Move in Steps Manually

It can manually move in steps when the screen is displaying "READY", or when the POSITION (▲▼◀▶) key is displayed.

#### Operation

1 Press the POSITION (▲▼◀▶) key once.

- ▶ Tool carriage or the media will move toward the direction of the pressed POSITION key for 1 step.



#### Supplement

- It will move in steps every time POSITION (▲▼◀▶) key is pressed.
- Distance of step movement can be changed. See "Setting of Step Movement Distance"

 P.3-4



# Setting of Step Movement Distance

## Operation

1 Press the [MENU] key.

▶MENU screen is displayed.



2 Press the **POSITION** (▼) key (ADV).

▶ADV. setting screen (1/3) is displayed.



3 Press the [1] key (MOVE STEP).

▶MOVE STEP screen is displayed.

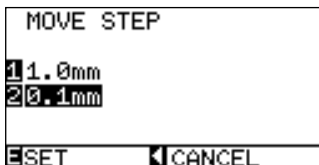

4 Press the [1] key (1.0mm) or the [2] key (0.1mm).

5 Confirm the setting and press the [ENTER] key (SET).

▶Setting will be set, and it will return to DEFAULT setting screen (1/3).

6 Press the [MENU] key.

▶It will return to default screen.

### Supplement

Value chosen here will be the movement distance for the step movement.

### Supplement

It will return to DEFAULT setting screen (1/3) without changing the settings when you press the POSITION (◀) key (CANCEL).

## Move Away the Tool Carriage

It is possible to move the tool carriage 100 mm toward upper right. It makes it easier to confirm the cutting results if you perform this operation after the cutting is completed.

<For rear loading/roll media>

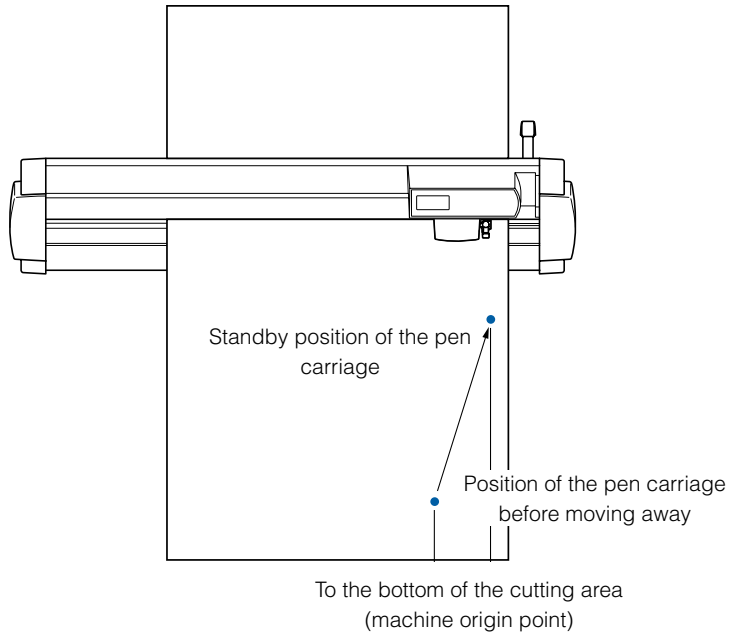

<For the sheet>

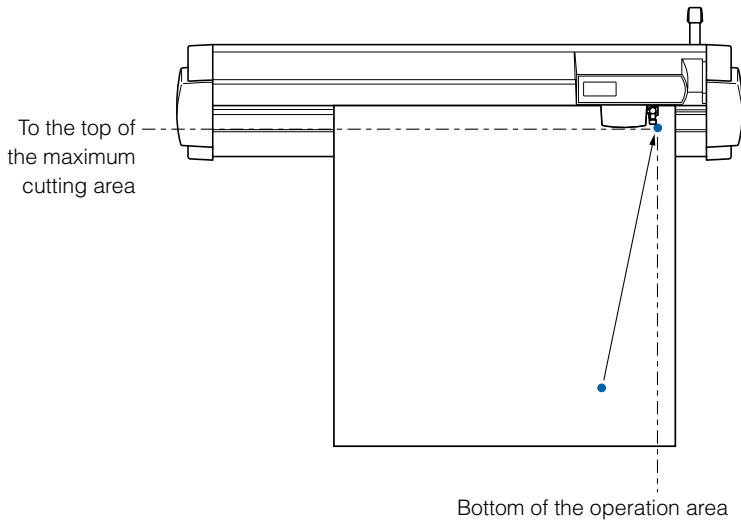

### Operation

1

Press the [2] key in READY status.

▶ Tool carriage will move away.

### Supplement

Tool carriage will move away to upper right by continuously performing the same operation.

To move the tool carriage to the origin point, do following:

### Operation

1

Press the [3] key in READY status.

▶ Tool carriage will move to the origin point.

## Changing CONDITION No.

To change the CONDITION No., do following:

### Operation

1 Press the [ENTER] key in READY status.

▶CONDITION No. selection screen is displayed.

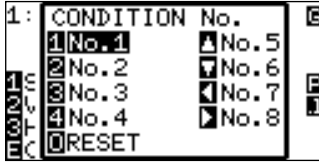

2 Press the [1] key (No.1), the [2] key (No.2), the [3] key (No.3), the [4] key (No.4), the [▲] key (No.5), the [▼] key (No.6), the [◀] key (No.7), or the [▶] key (No.8), while simultaneously pressing the [ENTER] key.

▶Setting will be set, and it will return to default screen.



#### Supplement

It will return to state when the power is turned on when the [ORIGIN] key (RESET) is pressed.

See "Setting to Default" [P.3-6](#).

## Setting to Default

To move to the position as after the power was turned on, do following:

### Operation

1 Press the [ENTER] key in READY status.

▶CONDITION No. selection screen is displayed.

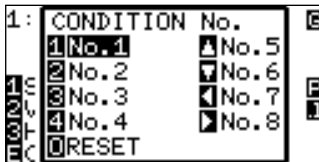

2 Press the [ORIGIN] key, while simultaneously pressing the [ENTER] key.

▶Initialization is performed, and SELECT screen is displayed.

Point where the cutting starts is called origin point. The origin point can be set at any location.

<For rear loading/sheet>

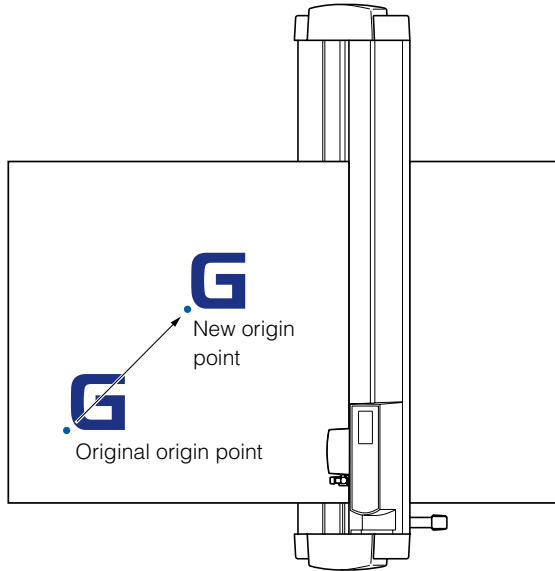

### Supplement

For the front loading model, rotate the above figure 180 degrees.

## Operation

1 Move the tool to the new origin point by pressing the **POSITION** (▲▼◀▶) key when it is in READY status.



2 Press the [**ORIGIN**] key.

▶ New origin point is set, and "NEW ORIGIN POINT IS SET!" is displayed for few seconds in the screen.

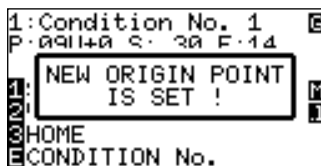

## When Coordinate Axes Rotation are Set

If the origin point is moved while the coordinate axes are rotated, the origin point will move as shown below.

### Supplement

See "Setting the Cutting Direction" [P.3-10](#) about the rotation of the coordinate axes.

<For rear loading/sheet>

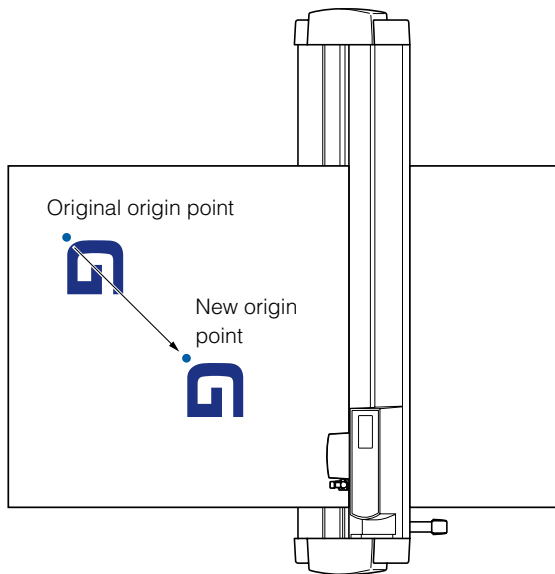

### Supplement

For the front loading model, rotate the above figure 180 degrees.

## When Coordinate Axes are Rotated After Origin Point is Set

The origin point will be initialized as shown below if the coordinate is rotated after moving the origin point. Distance "a" will be maintained, but distance "b" will be initialized.

<For rear loading/sheet>

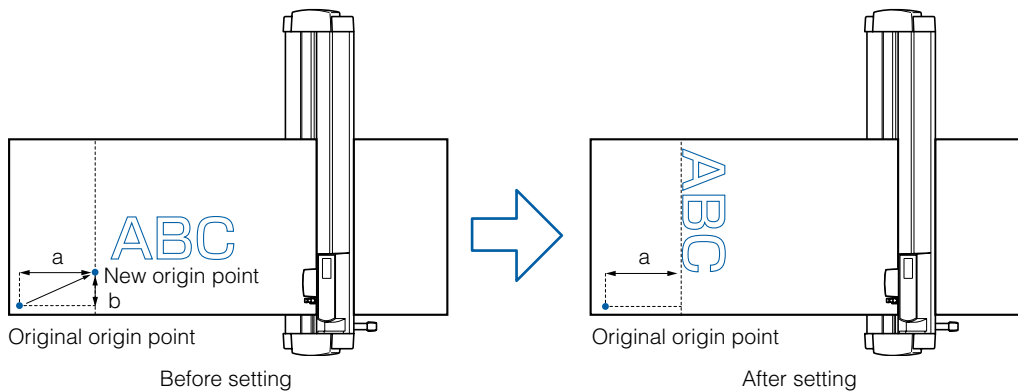

### Supplement

- For the front loading model, rotate the above figure 180 degrees.
- To use the origin point movement and coordinate axes rotation together, always rotate the coordinate axes first, and then move the origin point.
- Coordinate value displayed after setting new origin point is a distance from the new origin point.

## Setting Origin Point When HP-GL is Set

Set the origin point at the lower left or the center of the cutting area if the COMMAND is set to HP-GL.  
There is no setting if the COMMAND is set to GP-GL.

### Supplement

See "Settings of Controls from Computer" [P.11-1](#) about setting the COMMAND.

## Operation

1 Press the **[MENU]** key.

▶MENU screen is displayed.



2 Press the **POSITION (▲)** key (I/F).

▶INTERFACE screen (1/3) is displayed.

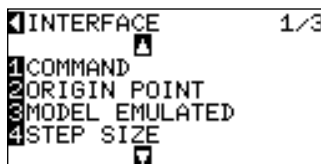

3 Press the **[2]** key (ORIGIN POINT).

▶ORIGIN POINT setting screen is displayed.

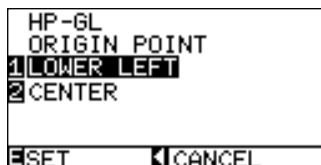

4 Press the **[1]** key (LOWER LEFT) or the **[2]** key (CENTER).

5 Confirm the setting and press the **[ENTER]** key (SET).

▶Setting will be set, and it will return to I/F screen (1/3).

6 Press the **[MENU]** key.

▶It will return to the default screen.

### Supplement

It will return to I/F screen (1/3) without changing the settings when you press the POSITION [**◀**] key (CANCEL).

# 3-4 Setting the Cutting Direction

Rotate the coordinate axes to change the cutting direction.

<For rear loading/sheet>

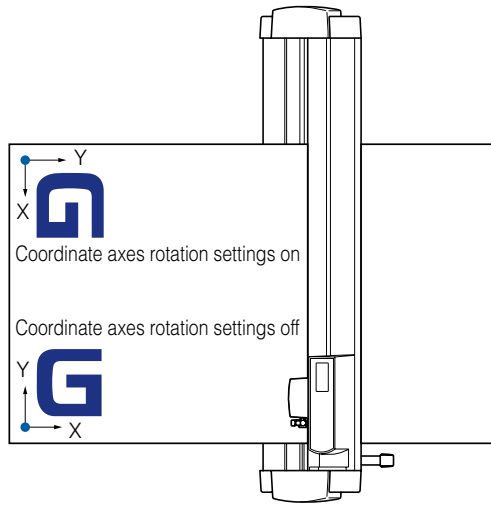

<For front loading>

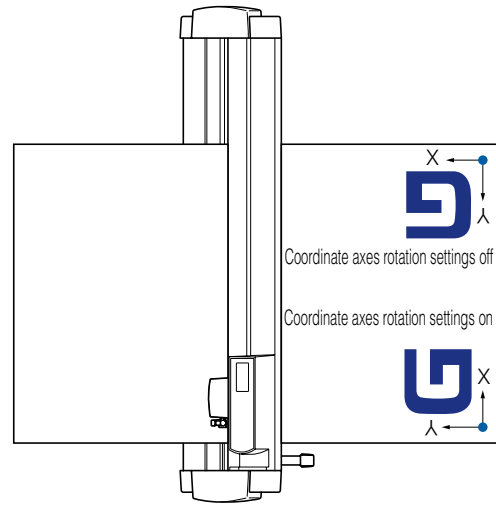

## Operation

1 Press the [MENU] key.

▶MENU screen is displayed.



2 Press the [3] key (AREA).

▶AREA PARAMETERS setting screen (1/2) is displayed.

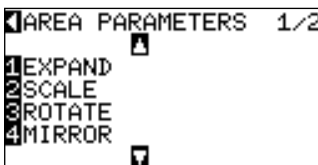

3 Press the [3] key (ROTATE).

▶ROTATE screen is displayed.



4 Press the [1] key (ON) or the [2] key (OFF).

Next page

5

Confirm the setting and press the **[ENTER]** key (SET).

▶ Setting will be set, and it will return to AREA parameter screen (1/2).

6

Press the **[MENU]** key.

▶ It will return to default screen.

#### **Supplement**

It will return to AREA parameter screen (1/2) without changing the settings when you press the POSITION (◀) key (CANCEL).



# 3-5 Stop Cutting

It will stop cutting when the [STOP] key is pressed while cutting. Operation selection menu is displayed on the screen of the control panel while it is stopped. It is possible to choose either to continue or stop the operation.

It is also possible to exchange or reset the media while it is stopped.

## Pause and Resume Cutting

### Operation

1 Press the [STOP] key.

▶Cutting will stop and following screen is displayed.

```
JOB IS INTERRUPTED
1CONTINUE JOB
2QUIT JOB
```

2 Perform necessary operation, such as exchanging the media.

3 Press the [1] key (CONTINUE JOB).

▶Cutting will start and the screen will resume to operation.

```
1:Condition No. 1  G
CB09U+0 S30 F14
      WORKING
MMENU  P
CCONDITION  I
SSTOP
```

#### Supplement

There is no effect on the selection of media type when the media set lever is moved up and down while pausing the cutting. It is also possible to exchange or reset the media.

#### Supplement

It will stop cutting by pressing [2] key (QUIT JOB).

See "Stop Cutting" [P.3-13](#) .

# Stop Cutting

## Operation

1

Press the [STOP] key.

▶ Operation will stop and following screen is displayed.

```
JOB IS INTERRUPTED
1 CONTINUE JOB
2 QUIT JOB
```

2

Press the [2] key (QUIT JOB).

▶ Following screen is displayed.

```
BUFFER CLEAR
CONFIRM DATA FROM
HOST STOPPED.
1 CLEAR
2 CANCEL
```

3

Press the [1] key (CLEAR).

▶ Following screen is displayed, the buffer memory is cleared, and it will return to default screen.

```
CLEARING BUFFER!
PLEASE WAIT
```



```
BUFFER CLEAR
COMPLETED!
```



```
1: Condition No. 1  [G]
  CB09U+0 S30 F14
      READY
1 SELECT USER      [P]
2 VIEW              [1]
3 HOME
[ ] CONDITION No.
```

### Supplement

- It will resume cutting by pressing [1] (CONTINUE) key.
- See "Pause and Resume Cutting" [P.3-12](#).

### Supplement

It will return to operation stop screen without clearing buffer memory when [2] key (CANCEL) is pressed.

# Cut off the Roll Sheet (Cross Cut)

Operation to cut off the media is called cross cut.

It is possible to cut at any location manually, or to automatically cut when the cutting is completed. Force of the blade when the cross cut is made is called cross cut force, and it can be adjusted.

## CAUTION

Do not place your hand where the blade might move. You may be injured.

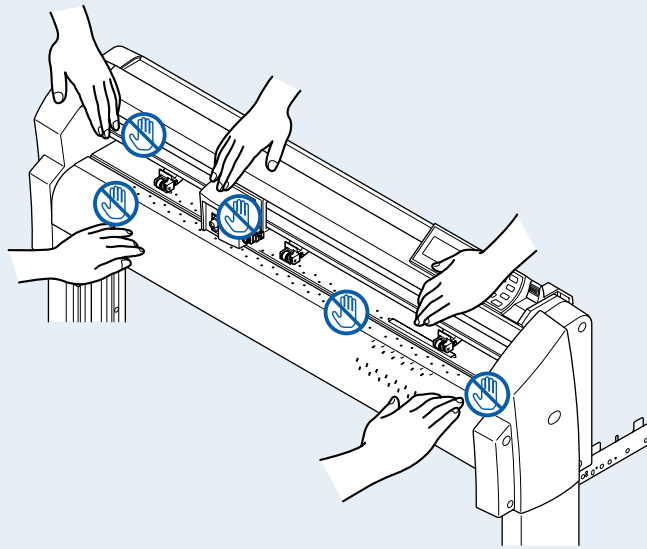

## Reference

- Only when the roll media is loaded by rear loading can be cross cut. Cross-cutting cannot be performed for the media that was front loaded or SHEET has been specified.
- Periodically clean out the groove with a cotton swab or similar item. Cutter will not operate properly if dust or dirt builds up in the cutting groove.
- Remove the media if it is resting on the media sensor after it was cross cut. If this is not removed, it is determined that the cut was not performed properly, and it will cross cut again.
- Set the "setting for the push roller sensor" and the "setting for the media sensor" in the basic settings to enabled. It cannot perform cross cut if it is set to disabled.

## Cut Width

The range of the blade movement for cross cut is 87 mm outside the leftmost push roller, and 37 mm outside the rightmost push roller. Set the media within this area.

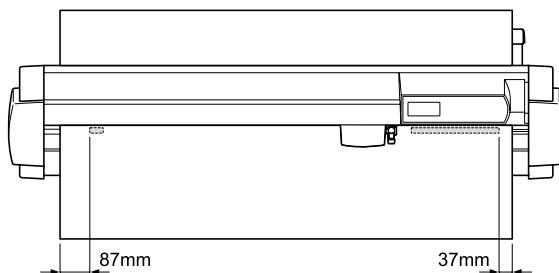

## Supplement

Replace the cross cut unit with following as a guideline.

- Paper back film: 1000 mm width media, about 3000 sheets (CT01H)
- Plastic back film: 1000 mm width media, about 3000 sheets (CT01H)

## Cross Cut Manually

Media is cross cut at the position 15 mm behind the last cut position.

If the cutting was very small, cross cut will be made at 40 mm including the cutting itself.

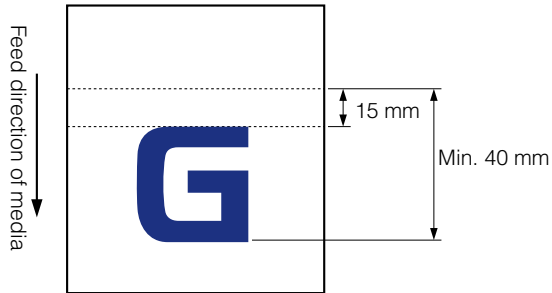

It is possible to cut off the roll media at desired position by cross cutting after manually moving the media using the POSITION (▲▼) key.

### CAUTION

Do not place your hand where the blade might move. You may be injured.

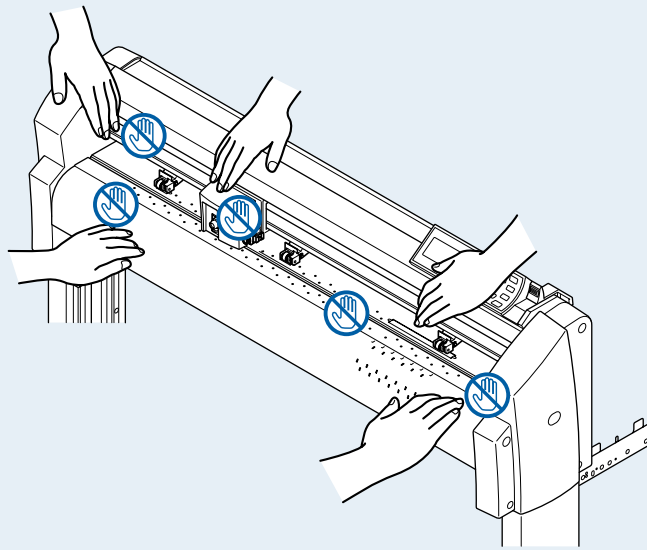

## Operation

1 Press the [CROSS CUT] key in the READY status.

►CROSS CUT screen is displayed.



2 Press the [1] key (CUT).

►Media is cross cut.

### Supplement

It will return to default screen without cross cut by pressing the [2] key (CANCEL).

## Automatically Cross Cut

It will automatically cross cut after cutting when the cutting is done with provided software. See the User Guide for the provided software for details.

It will perform a cross cut with timeout or SEPARATOR command even if the CROSS CUT command is not received when the AP mode is set on. Cross cut position will be "SPACE REAR" added behind the cut area. See the User Guide for the "Cutting Plotter Controller" for details.

See the "Apparel (AP) Mode" [P.4-14](#) for details about the settings of space rear and apparel (AP) mode.

### CAUTION

Do not place your hand where the blade might move while it is cutting. You may be injured.

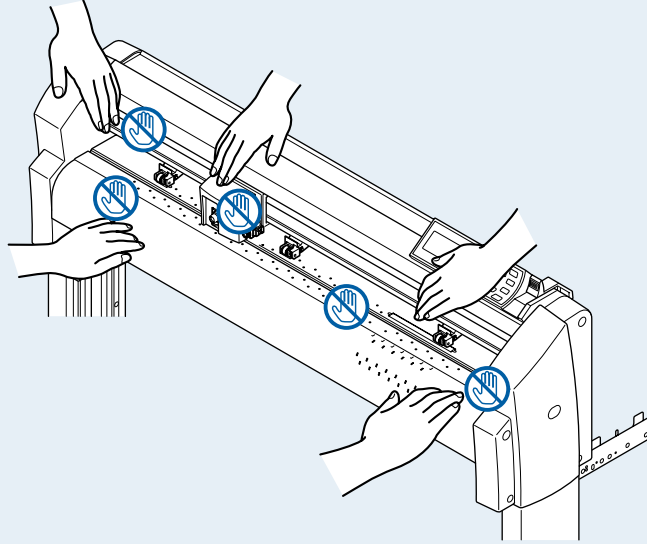

## Setting of the Cross Cut Force

This will adjust the blade force when it cross cuts.

Setting range of cross cut force is from 1 to 48. The force will be larger with larger value. It is set to 30 as a default.

Decrease the value if the media is thin, and increase the value if the media is thick.

### Operation

1 Press the **[MENU]** key.

►MENU screen is displayed.



2 Press the **[4]** key (MEDIA).

►MEDIA SETTING screen (1/2) is displayed.

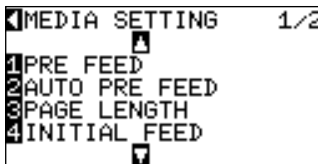

3 Press the **POSITION (▼)** key.

►MEDIA SETTING screen (2/2) is displayed.

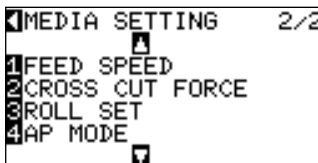

4 Press the **[2]** key (CROSS CUT FORCE).

►CROSS CUT FORCE setting screen is displayed.

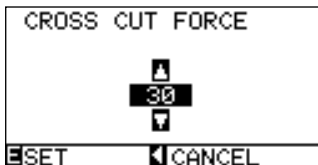

5 Press the **POSITION (▲▼)** key and increase or decrease the setting value.



6 Confirm the setting and press the **[ENTER]** key (SET).

►Setting will be set, and it will return to MEDIA setting screen (2/2).

7 Press the **[MENU]** key.

►It will return to default screen.

#### Supplement

Decrease the value of cross cut force if the media is thin, and increase the value if the media is thick.

- Range of cross cut force values: 1-48
- Default value: 30

#### Supplement

It will return to MEDIA setting screen (2/2) without changing the setting values when you press the POSITION (◀) key (CANCEL).



# Chapter 4: Convenient Functions

**This chapter describes about the convenient functions of the plotter.**



# 4-1 Settings for Cutting

Settings such as area and width of cutting, page length, mirrored, enlarged, shrunk, etc., can be set.

## Setting Cutting Area

Origin point will be set at lower left of the AREA once the AREA is set. It is possible to set the origin point at the center when the HP-GL is selected.

Move the origin point to change the cutting position.

<For rear loading/sheet>

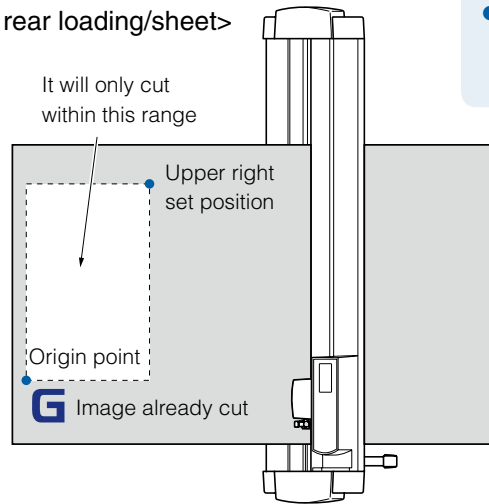

### Supplement

- See "Setting the Origin Point" [P.3-7](#) about the moving the origin point.
- See "Setting Origin Point When HP-GL is Set" [P.3-9](#) for setting the origin point with HP-GL command.

### Supplement

For the front loading model, rotate the above figure 180 degrees.

## Operation

1 Press the [MENU] key in READY status.

▶ MENU screen is displayed.



2 Press the [3] key (AREA).

▶ AREA PARAMETERS setting screen (1/2) is displayed.

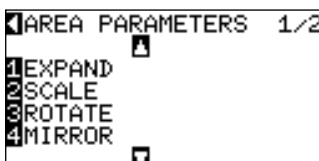

### Supplement

See "How to Use Control Panel" [P.2-17](#) for READY status.

Next page

3

Press the **POSITION (▼)** key.

▶ AREA PARAMETERS setting screen (2/2) is displayed.



4

Press the **[1]** key (AREA).

▶ LOWER LEFT setting screen is displayed.

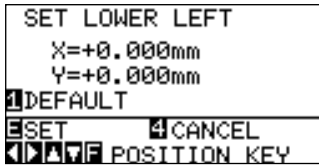

**Supplement**

- Coordinate value displayed here is the distance to the tool carriage from the origin point.
- Press [1] key (DEFAULT) if the cutting are is not to change.

5

Press the **POSITION (▲▼◀▶)** key and move the tool carriage to the position to be the lower left of the AREA.



6

Press the **[ENTER]** key (SET) once the tool carriage is in correct position.

▶ Setting will be set, and UPPER RIGHT setting screen is displayed.



7

Press the **POSITION (▲▼◀▶)** key and move the tool carriage to the upper right position of the AREA.



8

Press the **[ENTER]** key (SET) once the tool carriage is in correct position.

▶ Setting will be set, and it will return to AREA parameter screen (2/2).

9

Press the **[MENU]** key.

▶ It will return to default screen.

**Supplement**

It will return to AREA parameter screen (2/2) without changing the settings when you press the [4] key (CANCEL).

## Setting Cutting Width

Set the cutting width. It is possible to set that it will cut to the area outside of the push rollers, or not to cut at the ends of the media.

Default setting is to the internal edge of the push rollers. It can be set up to 10 mm outside (positive value) or 10 mm inside (negative value) from the default position. The width will enlarge if the value is set to positive, and the width will decrease if the value is set to negative. Setting will affect both ends, resulting the total width change will be double the set value.

### CAUTION

Do not set the "INITIAL BLADE CONTROL POSITION" of the special function to "OUTSIDE" when the setting value is set to more than 8 mm. The blade might be damaged by moving the carriage outside the media under this condition.

### Supplement

- If the value is set to positive, it is able to cut over where the push rollers are, but the push rollers passes where it is cut, creating a chance of bad feeding depending on the media.
- Set the width of cutting area, and then send the cutting data to the plotter. Cutting data in the buffer memory will be cleared when cutting area width is changed.

## Operation

1 Press the **[MENU]** key in READY status.

▶ MENU screen is displayed.



2 Press the **[3]** key (AREA).

▶ AREA PARAMETERS setting screen (1/2) is displayed.

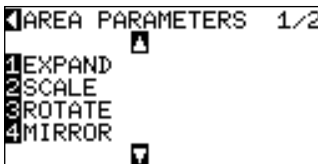

3 Press the **[1]** key (EXPAND).

▶ EXPAND LIMIT setting screen is displayed.

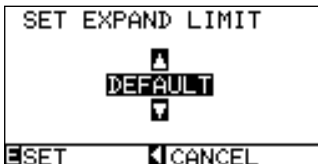

4 Press the **POSITION (▲▼)** key and increase or decrease the setting value.



### Supplement

See "How to Use Control Panel" [P.2-17](#) for READY status.

### Supplement

Setting range is from +10 to -10 mm.

Next page

5

Confirm the setting and press the [ENTER] key (SET).

▶ Setting will be set, and it will return to AREA parameter screen (1/2).

6

Press the [MENU] key.

▶ It will return to default screen.

### Supplement

It will return to AREA parameter screen (1/2) without changing the settings when you press the POSITION (◀) key (CANCEL).

## Setting Length of the Page

Length of 1 page when using the roll media is set.

Only the part that will fit in to the set page length will be cut for the cutting data that is longer than the set page length, and the exceeding part will not be cut.

### Reference

- Default setting for page length is 2 m. Check the setting of the page length when cutting long length.
- FC8000 guarantees the accuracy up to 15m page length. (It depends on the media specified by Graphtec and setting conditions.)
- Use the basket.
- Use 3M plastic backing film for the media.
- Set the speed to 30 or under, quality to 4 or under for conditions.
- Perform pre feed for the amount to be used before cutting.
- Leave the media in environment to use for adequate time if the deviation of temperature and humidity is big.
- Set the both push rollers at least 15mm inside the edge of media.
- Set the sideways tension of the media uniform when setting the color adhesive film or recording media when cutting long length. Media might come off the rollers while cutting if it is not uniform.
- Pull out the amount to use before cutting when you are using the roll media.
- To reduce the shifting of the media, perform the pre feed to the full length to be cut (see "Pre Feed of Media (Paper or Marking Film)" [P.2-23](#)). Also, pre feeding can be done automatically when the data is received (see "Perform Automatic Pre Feed When Cut Data is Received" [P.8-4](#)), or done automatically when the media is loaded (see "Perform Automatic Pre Feed When Media is Set (Initial Feed)" [P.8-6](#)).
- \* Pre feeding will stabilize the feed by acclimating the media, taking out the slack.
- This setting is maintained even after the power is turned off.

## Operation

1

Press the [MENU] key.

▶ MENU screen is displayed.



2

Press the [4] key (MEDIA).

▶ MEDIA setting screen (1/2) is displayed.

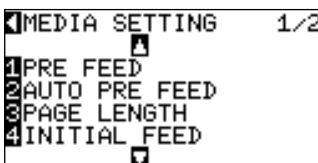

[Next page](#)

3

Press the [3] key (PAGE LENGTH).

▶PAGE LENGTH setting screen is displayed.

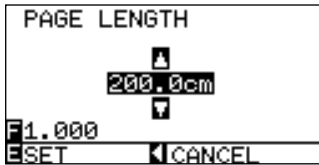

4

Press the **POSITION** (▲▼) key and increase or decrease the setting value.

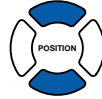

**Supplement**

- Digits of settings can be changed by pressing the [FAST] key.
- Setting range is from 20.0 cm to 5000.0 cm.

5

Confirm the setting and press the [ENTER] key (SET).

▶Setting will be set, and it will return to MEDIA setting screen (1/2).

**Supplement**

It will return to MEDIA setting screen (1/2) without changing the settings when you press the POSITION (◀) key (CANCEL).

6

Press the [MENU] key.

▶It will return to default screen.

## Setting Mirror

There is a function to mirror the cutting by reversing the origin point and coordinate axes. Set the MIRROR setting on to do mirroring.

**Reference**

Setting for mirror is maintained even after the power is turned off.

<For rear loading/sheet>

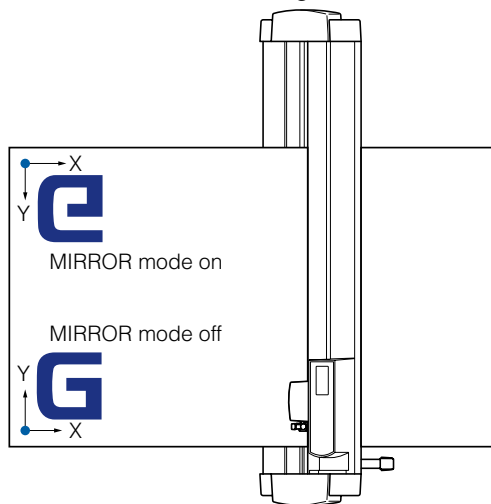

<For front loading>

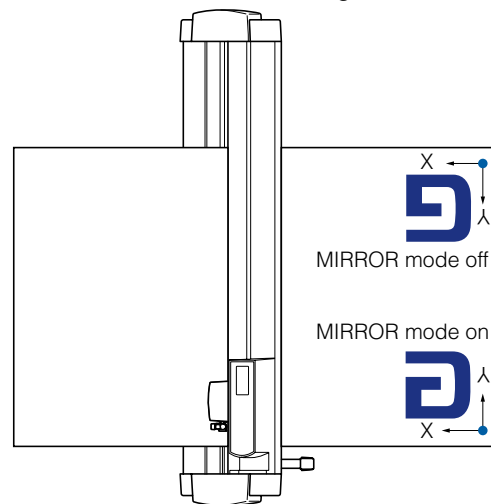

## Operation

1 Press the **[MENU]** key.

▶MENU screen is displayed.



2 Press the **[3]** key (AREA).

▶AREA PARAMETERS setting screen (1/2) is displayed.

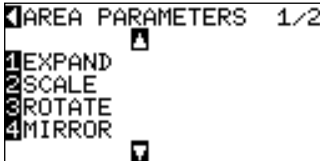

3 Press the **[4]** key (MIRROR).

▶MIRROR setting screen is displayed.



4 Press the **[1]** key (ON).

5 Confirm the setting and press the **[ENTER]** key (SET).

▶Setting will be set, and it will return to AREA parameter screen (1/2).

6 Press the **[MENU]** key.

▶It will return to default screen.

### Supplement

Press the [2] key (OFF) to turn off the mirror.

### Supplement

It will return to AREA parameter screen (1/2) without changing the settings when you press the POSITION (◀) key (CANCEL).

## Setting Enlarge/Shrink Scale

It can enlarge or shrink cutting.

The rate of enlargement or shrinkage of the cutting data can be changed by settings.

### Supplement

Settings of the enlarge/shrink scale is maintained even if the power is turned off.

## Operation

1 Press the **[MENU]** key.

▶ MENU screen is displayed.



2 Press the **[3]** key (AREA).

▶ AREA PARAMETERS setting screen (1/2) is displayed.

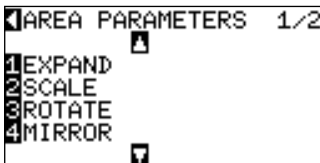

3 Press the **[2]** key (SCALE).

▶ SCALE setting screen is displayed.

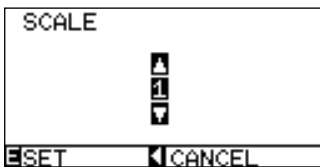

4 Press the **POSITION (▲▼)** key and increase or decrease the setting value.



5 Confirm the setting and press the **[ENTER]** key (SET).

▶ Setting will be set, and it will return to AREA parameter screen (1/2).

6 Press the **[MENU]** key.

▶ It will return to default screen.

### Supplement

Values that can be set are 1/8, 1/4, 1/2, 1, 2, 3, 4, 5, 6, 7, and 8 (multiplications).

### Supplement

It will return to AREA parameter screen (1/2) without changing the settings when you press the POSITION (◀) key (CANCEL).

The function to cut specified numbers of cutting data stored in the buffer memory is called COPY.

### Supplement

- Do not send new data to plotter while copying. Cutting data in the buffer memory will be cleared.
- Previous cutting data will be cleared and newly sent data will be stored as cutting data if you send new data with 10 seconds or more interval from the time it finished cutting.
- It can not copy if data is more than 1.6 MB because it cannot be stored in the buffer memory of the plotter.
- Buffer memory that can be used for copy will decrease if you turn on the data sort. Turn off the data sort when you need to copy cutting with large data. See "Sorting the Cutting Data" [P.8-2](#) for data sort.
- Watch out that it does not fall out of media when cutting with copy function.
- If the original cutting data to be copied starts away from the origin point, copied cutting will also start away from the origin point. To avoid wasted space, create the cutting data close to the origin point.

Copy is performed in following order.

<For rear loading/sheet>

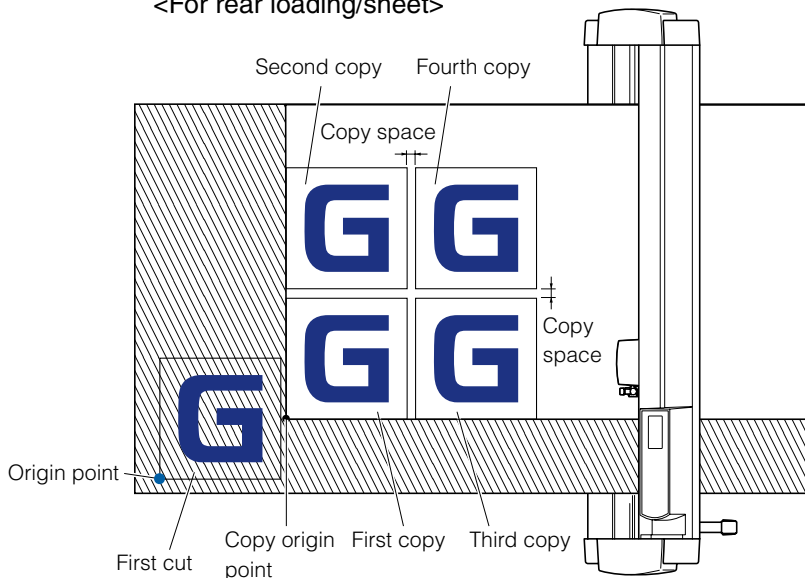

### Supplement

For the front loading model, rotate the above figure 180 degrees.

It will copy in following order when MIRROR is set.

<For rear loading/sheet>

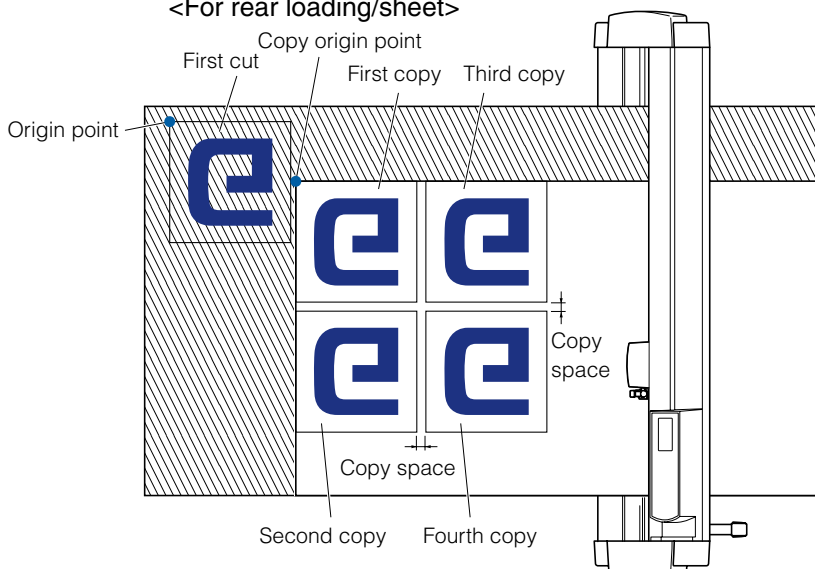

### Supplement

For the front loading model, rotate the above figure 180 degrees.



It will copy in following order when COORDINATE AXES ROTATION is set.

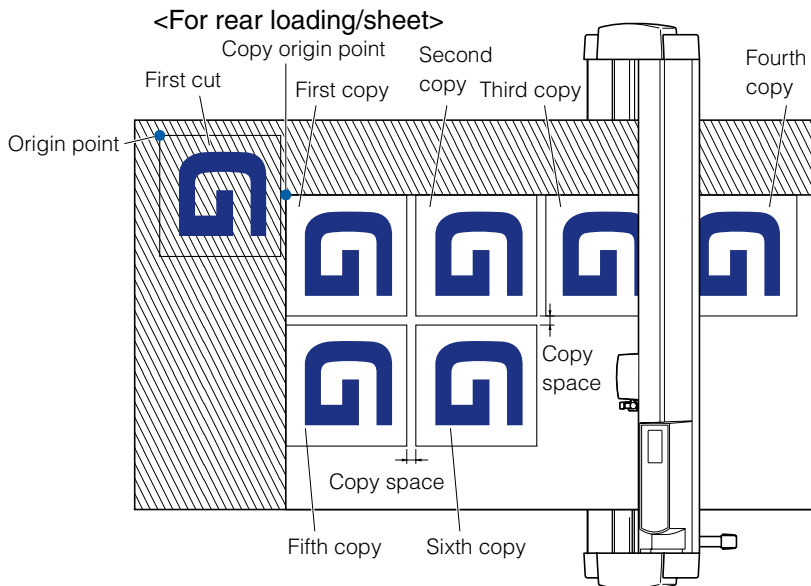

### Supplement

For the front loading model, rotate the above figure 180 degrees.

## Operation

1 Create one data you want to copy.

▶Cutting data is stored in the buffer memory.

2 Press the **POSITION** (▲▼◀▶) key and move the tool carriage to the position to copy.



3 Press the **[COPY]** key.

▶COPY MODE screen is displayed.



4 Press the **[1]** key (NUMBER OF COPIES).

▶NUMBER OF COPIES setting screen is displayed.

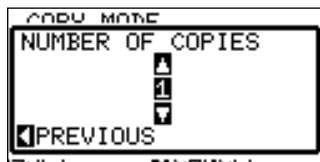

5 Press the **POSITION** (▲▼) key and increase or decrease the setting value.



### Supplement

- "NO DATA FOR COPY IN BUFFER!" is displayed if there is no data in the buffer memory. Send the cutting data.
- "COPY MODE BUFFER FULL! CANNOT COPY" is displayed if the data sent was bigger than what can be stored in the buffer memory.

### Supplement

Number of copies can be set from 1 to 100, as much as it can fit in the media set on the printer.

Next page

6

Confirm the setting and press the **POSITION** (◀) key (PREVIOUS).

▶Number of copies will be selected, and it will return to COPY mode screen.

7

Press the **[2]** key (COPY SPACE).

▶COPY SPACE setting screen is displayed.



8

Press the **POSITION** (▲▼) key and increase or decrease the setting value.

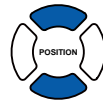

9

Confirm the setting and press the **POSITION** (◀) key (PREVIOUS).

▶Copy space will be selected, and it will return to COPY mode screen.

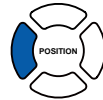

10

Confirm the setting and press the **[ENTER]** key (SET).

▶"COPY" is displayed on the screen, and it will copy as much as specified.

**Supplement**

"CANNOT COPY CUT AREA TOO SMALL!" is displayed if the cutting area is smaller than the copy data. Either expand the cutting area, or set the media that is big enough to copy.

**Supplement**

- Copy space can be set from 1.0 mm to 10.0 mm.
- This setting is maintained even if the power is turned off.

**Supplement**

Cutting data is stored even if the media is exchanged. It can be copied as many times until the buffer memory is cleared. It can be copied again after exchanging the media by pressing [COPY] key.

# 4-3 Dual Configuration

FC8000 can save 2 sets of settings independently. This is called dual configuration.

It is possible to quickly switch the different settings by the dual configuration.

2 preferred sets of setting can be stored separately if there are 2 operators, or 2 different settings for different media can be stored, making a quick change when the media is switched.

Dual configuration is done by selecting USER. There are USER 1 and USER 2 in the USER.

USER PRIORITY can be set for each USER. USER PRIORITY can specify to make the settings by the USER who has computer connected either by the key input, or from the "Cutting Plotter Controller" in addition to the key input.

## CAUTION

Cutting data will be cleared when USER is switched.

## Selection of the User

### Operation

1 Press the [1] key (SELECT USER) in the default screen.

▶USER screen is displayed.

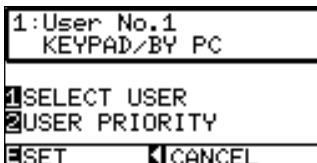

2 Press the [1] key (SELECT USER).

▶SELECT USER screen is displayed.

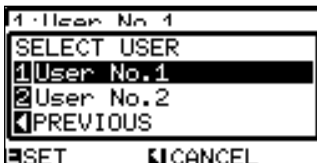

3 Press the [1] key (User No.1) or the [2] key (User No.2).

▶User is selected and it will return to USER screen.

4 Confirm the setting and press the [ENTER] key (SET).

▶Setting will be set, and it will return to default screen.

### Supplement

User name assigned in "Cutting Plotter Controller" is displayed as the user name.

### Supplement

It will return to USER screen without changing the settings when you press the POSITION (◀) key (PREVIOUS).

### Supplement

It will return to default screen without changing the settings when you press the POSITION (◀) key (CANCEL).

## Setting User Priority

### Operation

1 Press the [1] key (SELECT USER) in the default screen.

▶USER screen is displayed.



2 Press the [2] key (USER PRIORITY).

▶USER PRIORITY screen is displayed.



3 Press the [1] key (KEYPAD) or the [2] key (KEYPAD/BY PC).

▶USER PRIORITY is selected and it will return to USER screen.

4 Confirm the setting and press the [ENTER] key (SET).

▶Setting will be set, and it will return to default screen.

#### Supplement

- Settings only from key input are accepted in "KEYPAD" setting. Settings from the controller are not accepted. LED for USER1 or 2 will flash.
- "KEYPAD/BY PC" setting can be set from key input and controller. LED for USER1 or 2 will be lit.

#### Supplement

It will return to USER screen without changing the settings when you press the POSITION (◀) key (PREVIOUS).

#### Supplement

It will return to default screen without changing the settings when you press the POSITION (◀) key (CANCEL).

# 4-4 Apparel (AP) Mode

Apparel (AP) mode is a function to use the FC8000 in combination with CAD for apparel. This function becomes enabled by turning on the apparel mode. Turn off this function for all other uses. When the apparel mode is on, if the control command is not received within the specified time, it will be considered as timeout, and media will be cross cut. It will also cross cut when the separator command is received. Cross cut position will be "space rear" (item name: SPACE REAR) added behind the cut area. A separator command for GP-GL and HP-GL can also be set.

## Switching Apparel Mode

### Operation

1 Press the [MENU] key.

▶MENU screen is displayed.



2 Press the [4] key (MEDIA).

▶MEDIA SETTING screen (1/2) is displayed.

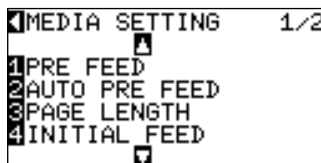

3 Press the POSITION (▼) key.

▶MEDIA SETTING screen (2/2) is displayed.

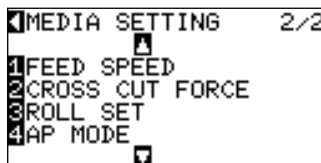

4 Press the [4] key (AP MODE).

▶AP MODE screen is displayed.

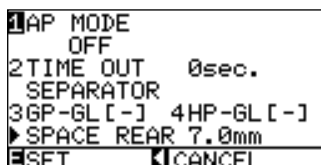

### Supplement

It will return to MEDIA setting screen (2/2) without changing the settings when you press the POSITION (◀) key (CANCEL).

Next page

5

Press the [1] key (AP MODE).

▶ AP MODE switch screen is displayed.

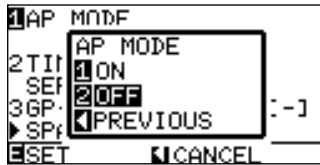

6

Press the [1] key (ON) or the [2] key (OFF).

▶ AP MODE is selected and it will return to AP MODE screen.

7

Confirm the setting and press the [ENTER] key (SET).

▶ Setting will be set, and it will return to MEDIA setting screen (2/2).

8

Press [MENU] key.

▶ It will return to default screen.

### Supplement

- It will be set to mode for apparel when the apparel (AP) mode is set on. Use it turned off for all other cases.
- TIME OUT, SEPARATOR, and SPACE REAR can be set when it is on.

### Supplement

It will return to AP MODE screen without changing the settings when you press the POSITION (◀) key (PREVIOUS).

### Supplement

It will return to default screen without changing the settings when you press the POSITION (◀) key (CANCEL).

## Setting Timeout

### Operation

1

Turn on the AP MODE by performing the steps 1-6 of "Switching Apparel Mode" [P.4-14](#).

▶ AP MODE is switched on and it will return to AP MODE screen.

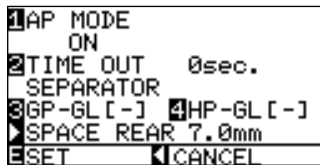

2

Press the [2] key (TIME OUT).

▶ TIME OUT setting screen is displayed.



3

Press the POSITION (▲▼) key and increase or decrease the setting value.



4

Confirm the settings and press the POSITION [◀] key (PREVIOUS).

▶ Timeout will be selected and it will return to AP MODE screen.

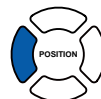

### Supplement

TIME OUT cannot be set if the AP MODE is off.

### Supplement

- Once the cutting is completed, it will automatically cross cut after time specified as timeout has past. It will not cross cut automatically if it is set to "0".
- Values that can be set are 0, 1, 2, 3, 5, 10, 20, 30, 60, or 120 seconds.

Next page

**5** Confirm the setting and press the [ENTER] key (SET).  
▶ Setting will be set, and it will return to MEDIA setting screen (2/2).

**6** Press the [MENU] key.  
▶ It will return to default screen.

### Supplement

It will return to MEDIA setting screen (2/2) without changing the settings when you press the POSITION (◀) key (CANCEL).

## Setting the Separator

### Operation

**1** Turn on the AP MODE by performing the steps 1-6 of "Switching Apparel Mode"  .

▶ AP MODE is switched on and it will return to AP MODE screen.

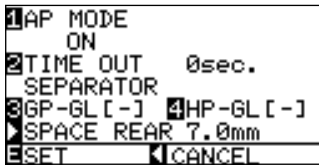

**2** Press the [3] key (GP-GL) or the [4] key (HP-GL).

▶ SEPARATOR setting screen is displayed.

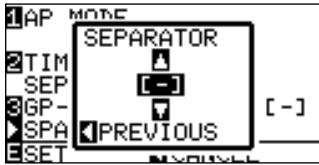

**3** Press the POSITION (▲▼) key and select the SEPARATOR.

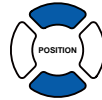

**4** Confirm the setting and press the POSITION (◀) key (PREVIOUS).

▶ Separator will be selected and it will return to AP MODE screen.

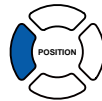

**5** Confirm the setting and press the [ENTER] key (SET).

▶ Setting will be set, and it will return to MEDIA setting screen (2/2).

**6** Press the [MENU] key.

▶ It will return to default screen.

### Supplement

SEPARATOR cannot be set if the AP MODE is off.

### Supplement

It will cross cut when the command set as a separator is received.

Separator can be selected from F, JO, H, or FS for the GP-GL.

Separator can be selected from AF, AH, PG, NR, SP, IP, SC, IW, PS, DF, or IN for the HP-GL.

"-" is showing that no separator is selected.

### Supplement

It will return to MEDIA setting screen (2/2) without changing the settings when you press the POSITION (◀) key (CANCEL).

# Setting the Space Rear

## Operation

1 Turn on the AP MODE by performing the steps 1-6 of "Switching Apparel Mode" [P.4-14](#).

▶ AP MODE is switched on and it will return to AP MODE screen.

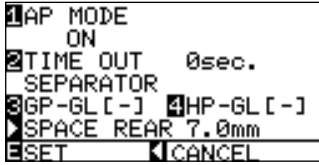

2 Press the **POSITION (▶)** key (SPACE REAR).

▶ SPACE REAR setting screen is displayed.

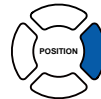

3 Press the **POSITION (▲▼)** key and increase or decrease the setting value.

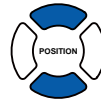

4 Confirm the setting and press the **POSITION (◀)** key (PREVIOUS).

▶ SEPARATOR settings will be selected and it will return to AP MODE screen.

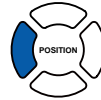

5 Confirm the setting and press the **[ENTER]** key (SET).

▶ Setting will be set, and it will return to MEDIA setting screen (2/2).

6 Press the **[MENU]** key.

▶ It will return to default screen.

### Supplement

SPACE REAR cannot be set if the AP MODE is off.

### Supplement

Setting range is between 7 and 30 mm.

### Supplement

It will return to MEDIA setting screen (2/2) without changing the settings when you press the POSITION (◀) key (CANCEL).





# Chapter 5: ARMS (Advanced Registration Mark Sensing System)

**ARMS (Advanced Registration Mark Sensing System) is a function to scan the registration mark written on the media using sensors. Tilt of the axes and distance can be adjusted with 2POINTS or 3 POINTS. 2 axes warp adjustment can be adjusted in addition to axes adjustment (tilt) and distance adjustment with 4POINTS. It makes possible for a precise cutting when cutting the borders of the images plotted by different plotter, or to cut the media again, by adjusting the print position by ARMS. It is possible to perform a multiple registration mark adjustment or segment area adjustment by linking with the application software on the computer. See the operation guides of the application software about the registration mark adjustment function linked with the application software. This chapter describes the outline of the ARMS (Advanced Registration Mark Sensing System) and how to setup and use the ARMS on the control panel.**

ARMS (Advanced Registration Mark Sensing System) will scan the registration mark (reference line) written on the media using sensors.

Accuracy of registration mark scan is within 0.3 mm when scanned registration mark specified by the plotter using supplied pen and high quality paper.

Be caution about following when scanning the registration mark.

-  P.5-2 Shape (Pattern) of the Registration Mark
-  P.5-3 Scan Range Necessary to Detect the Registration Mark
-  P.5-4 Positioning of the Media and the Registration Mark
-  P.5-5 Position of the Origin Point and the Registration Mark
-  P.5-5 Media That Registration Mark Cannot be Detected

#### Supplement

Perform the automatic registration mark scanning with paper-weight (See "Setting Paper-Weight"  P.7-21) turned on. The media might lift, and it may not scan the registration mark correctly if it is turned off.

## Shape (Pattern) of Registration Mark

The shapes (patterns) of the registration mark the plotter can scan are following 2 types.

### MARK TYPE 1

MARK TYPE 1 is used when you do not want the registration mark inside the cutting area. Cutting area becomes smaller for the area of registration mark on the media.

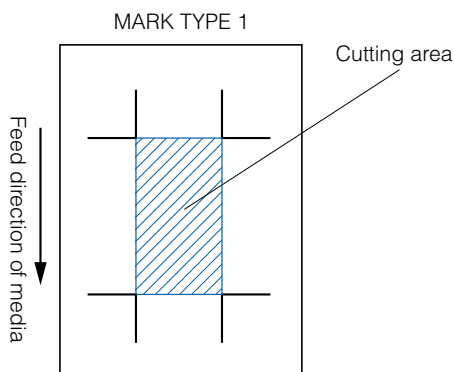

#### Supplement

- Left figure is for 4POINTS. Number of the registration mark will be different for the 2POINTS and 3 POINTS, but the shape of the registration mark will be same.
- See "Setting Shape (Pattern) of Registration Mark"  P.5-9 to change the shape (pattern) of the registration mark.

## MARK TYPE 2

MARK TYPE 2 is used when you would like to use as much area possible on the media as cutting area. The registration mark is inside the cutting area, so set the MARK DISTANCE so plotted image will not be mistaken as a registration mark. Also, you can not cut close to the registration mark (right image).

Do not plot image in the area where the sensor moves to scan the registration mark when the MARK DISTANCE is not used so it will not read the image while detecting the registration mark (left image).

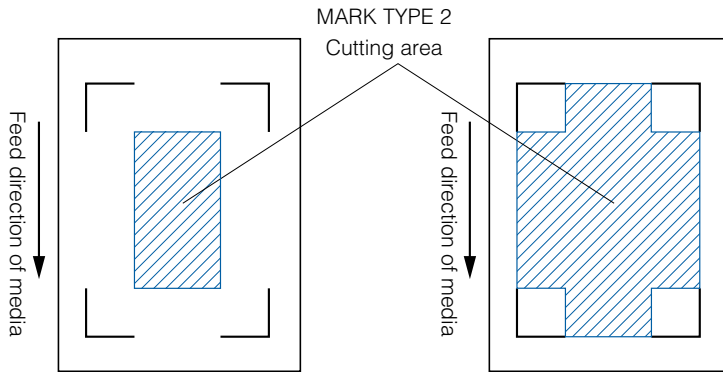

### Supplement

- Left figure is for 4POINTS. Number of the registration mark will be different for the 2POINTS and 3 POINTS, but the shape of the registration mark will be same.
- See "Setting Shape (Pattern) of Registration Mark" [P.5-9](#) to change the shape (pattern) of the registration mark.
- See "Setting Mark Distance" [P.5-12](#) for setting MARK DISTANCE.

### Supplement

- Create the registration mark as a plotting data with the application software. Registration marks generated by the application software cannot be used.
- Create the registration mark in accordance with following conditions.
  - Thickness of the line is between 0.3 and 1.0 mm.
  - Size of the registration mark is between 5 and 20 mm (see "Setting Registration Mark Size" [P.5-11](#)).
  - Use pattern 1 or pattern 2 for the shape of the registration mark.
  - Create the registration mark with single line, and specify the thickness of line to necessary thickness. Double line cannot be used.
  - Center of the line for the registration mark is the reference.

## Scan Range Necessary to Detect the Registration Mark

The range of tool carriage and media movement needed to scan the registration mark is as following.

### For 3POINTS

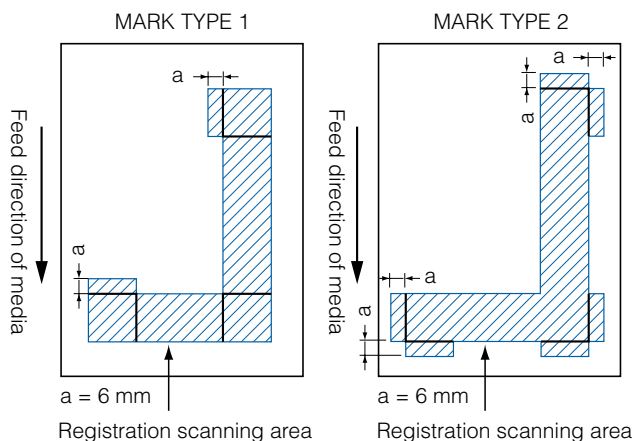

### For 4POINTS

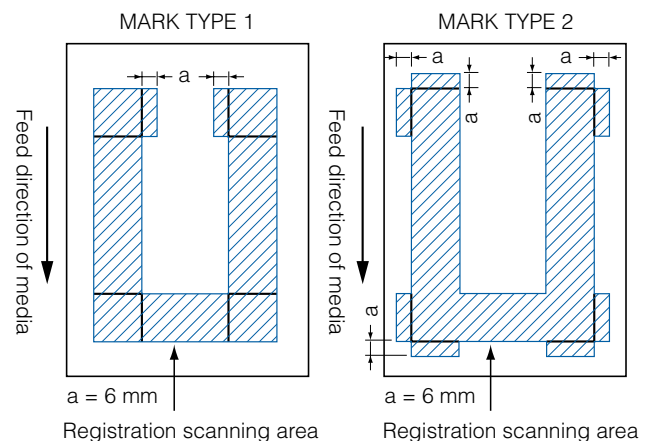

The area necessary to scan the registration mark when the mark distance is set is as following:

For 3POINTS

For 4POINTS

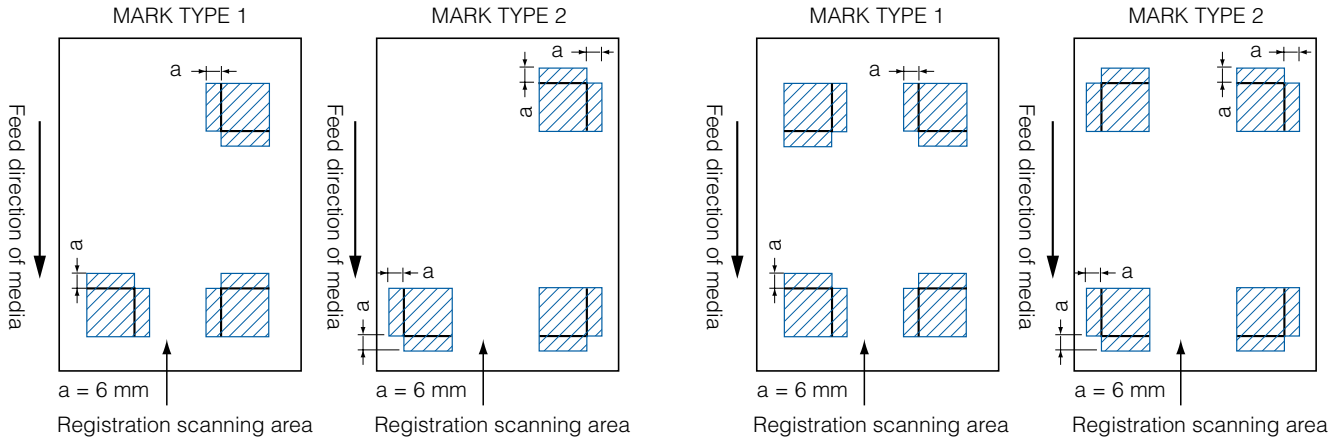

**Supplement**

- See "Setting Shape (Pattern) of Registration Mark" (P.5-9) to change the shape (pattern) of the registration mark.
- See "Setting Mark Distance" (P.5-12) for setting mark distance.
- It may mistakenly detect as registration mark if there is anything else plotted within the registration scanning area. Adjust the "MARK DISTANCE" so it can scan the registration mark correctly. (See "Setting Mark Distance" (P.5-12).)
- Clean any dirt or foreign objects from the media. Any dirt or foreign object might be scanned mistakenly as registration mark.
- Plot the registration mark in contrast easy to scan, such as black lines on white background. Adjust the scanning level of the sensor if you need to use the colored or glossy media. (See "Adjusting the Sensor Level" (P.5-18).)

**Positioning of the Media and the Registration Mark**

Place the registration mark away from the edge of media to scan the registration mark.  
Write the registration mark as following for the sheet media.

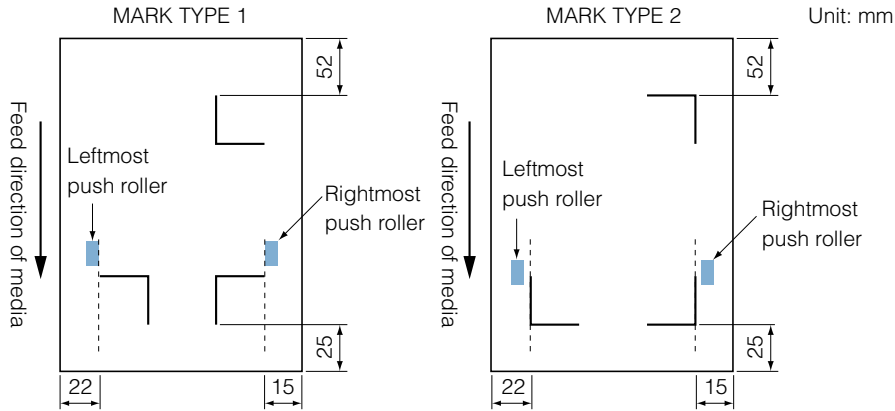

Write the registration mark with at least 110 mm from the end of media as shown below for the roll media.

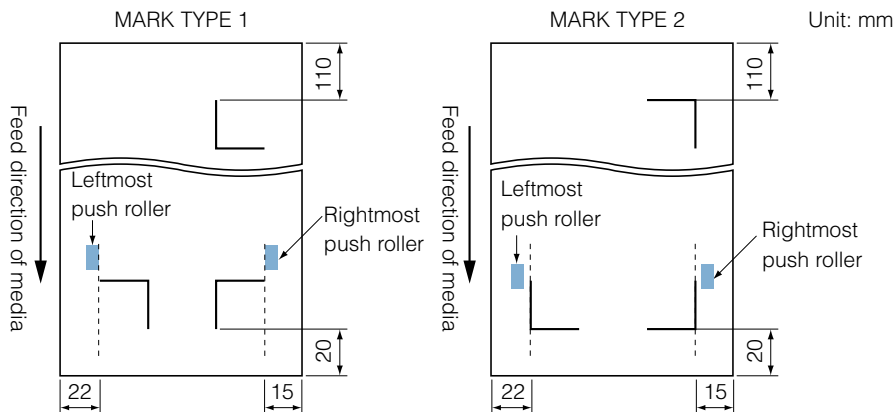

## Position of the Origin Point and the Registration Mark

The origin point after scanning the registration mark will be as shown below.

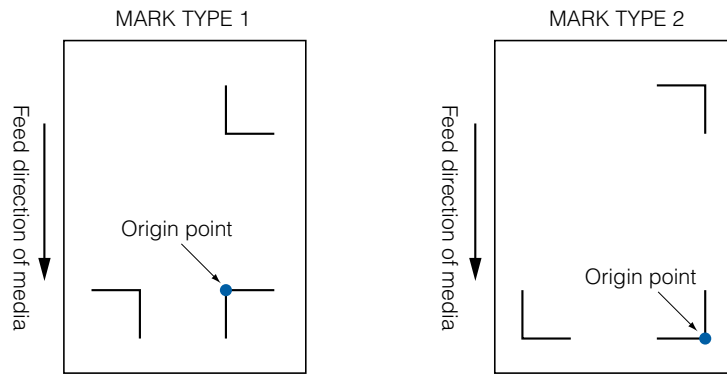

### Supplement

Offset amount away from the registration mark will be the origin point for cutting if the registration offset is set. (See "Setting Offset Between the Registration Mark and Cutting Origin Points" [P.5-16](#).)

The condition offset is generated is explained with creating the registration mark and the cutting data using an application software on the computer as an example.

Print onto the sheet media using a printer, and set that sheet media on the cutting plotter. Send the cutting data from the computer to cutting plotter.

Also, scan the registration mark on the sheet media with the cutting plotter, determine the origin point of the plotter.

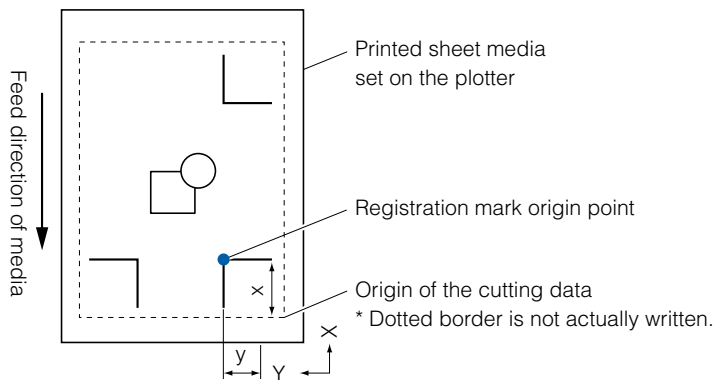

The origin point of the plotter will be set as the registration mark origin point as shown above, and it is different from the origin point of the cutting data. The difference between these two origin points are called as offset. It can cut properly by setting the offset value to the cutting plotter. There are following methods to measure the offset.

- Cutting data is checked on the computer, and the distance between the origin point of the cutting data and the registration mark origin point is Measured.

## Media That Registration Mark Cannot be Detected











It may be hard to scan the registration mark as following, depending on the media conditions.

- Transparent media  
Registration mark cannot be scanned because the cutting mat surface is also read in.
- Registration mark other than black line on white background  
Sensitivity of the sensor is based on the registration mark written in black on white background. It makes harder to scan the registration mark on colored background or written in colors other than black. Adjust the sensitivity level of the sensor. (See "Adjusting the Sensor Level" [P.5-18](#).)
- Sloppy plotting and media  
Registration mark may not be scanned if the surface is dirty, bent, or the lines are blurred.
- Thick media  
The registration mark can be scanned only on the media with thickness of 0.3 mm or less.

### Supplement

Use the axes adjustment function if the automatic registration mark scan is not possible. (See "Manual Position Adjust" [P.6-3](#).)

This section describes the necessary adjustment and settings to correctly scan the registration mark with ARMS.

-  P.5-6 **Setting MARK SCAN Mode and Numbers**
-  P.5-9 **Setting Shape (Pattern) of Registration Mark**
-  P.5-11 **Setting Registration Mark Size**
-  P.5-12 **Setting Mark Distance**
-  P.5-14 **Setting Distance Adjustment Between the Registration Mark**
-  P.5-16 **Setting Offset Between the Registration Mark and Cutting Origin Points**
-  P.5-18 **Adjusting the Sensor Level**
-  P.5-19 **Manually Adjusting the Sensor Level (Threshold Value)**
-  P.5-21 **Test the Registration Mark Sensor**
-  P.5-23 **Setting Speed of the Registration Mark Scan**
-  P.5-24 **Adjusting for the Registration Mark Scan Position**

#### Supplement

In addition to above, also see about the paper-weight ("Setting Paper-Weight"  P.7-21).

## Setting MARK SCAN Mode and Numbers

Set the MARK SCAN mode to ARMS to perform automatic registration mark scan.

#### Supplement

There are "AXIS ALIGNMENT" and "OFF" in addition to "ARMS" in the MARK SCAN modes. To turn "OFF", select "OFF" for the mode in following procedures. See "Manual Position Adjust"  P.6-1 for AXIS ALIGNMENT".

Set the numbers of registration marks when the MARK SCAN mode is set to ARMS. Select the POINTS from 2POINTS, 3POINTS, or 4POINTS. Position of the registration marks for each is as following.

#### 2POINTS

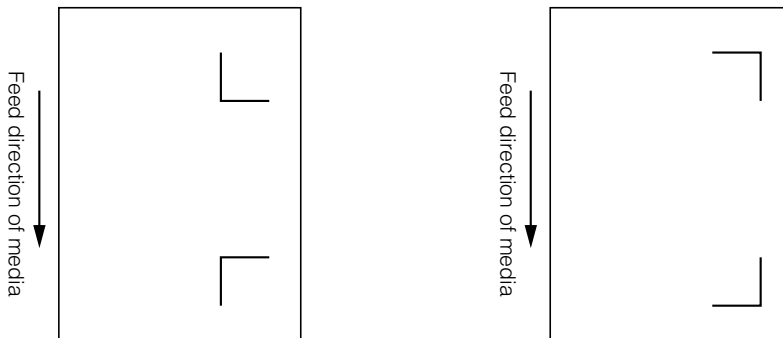

#### 3POINTS

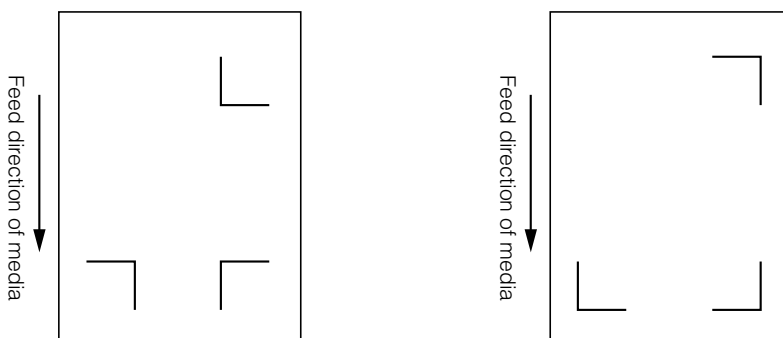

4POINTS

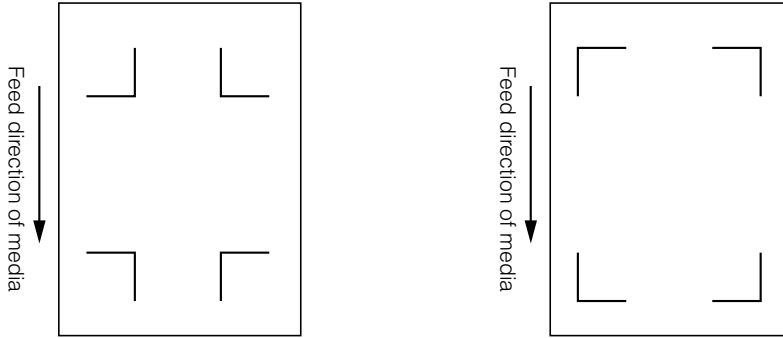

With more registration marks, precision of matching the printed image and the cutting will increase. But if there are many registration marks, it will take longer to detect, and the area that can be cut becomes smaller.

**1 axis adjustment (2POINT detection)**

It will detect the tilt of the printing from 2 registration marks, and cut is performed matching the tilt of the print.

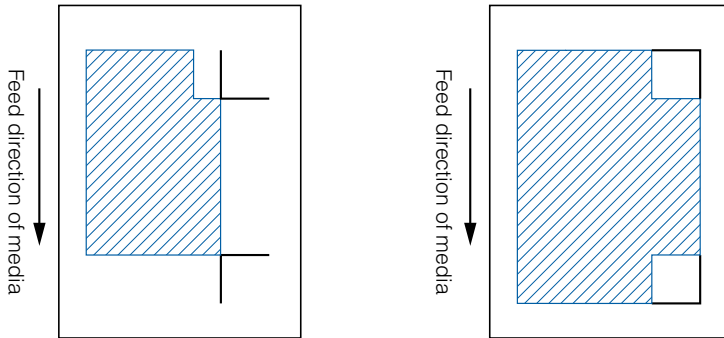

**Supplement**

- Alignment registration mark cannot be used.
- Cutting area depends on the MARK DISTANCE and the settings.

**2 axes adjustment (3POINT detection)**

It will detect the vertical and horizontal tilts from 3 registration marks, and cut is performed matching the tilt of the print.

Precision of print and cut position will be higher than the 1 axis adjustment.

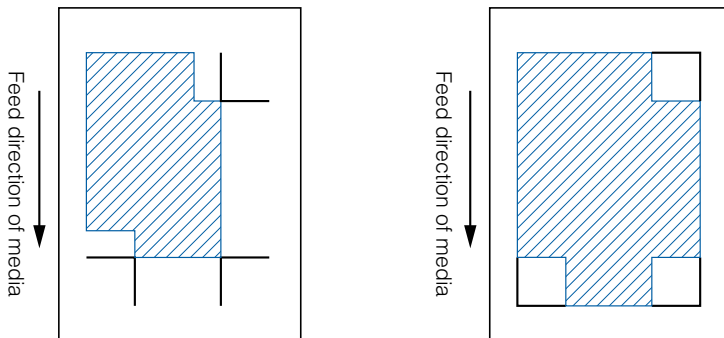

**Supplement**

- Distance between the registration marks can be adjusted.
- Alignment registration mark can be used.
- Cutting area depends on the MARK DISTANCE and the settings.

**4 axes adjustment (4POINT detection)**

It will detect the left and right vertical tilts and upper and lower horizontal tilt from 4 registration marks, and cut is performed matching the tilt of the print.

Precision of print and cut position will be higher than the 2 axes adjustment.

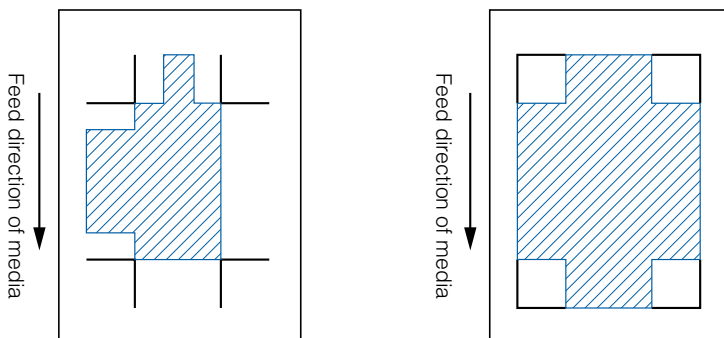

**Supplement**

- Distance between the registration marks can be adjusted.
- Alignment registration mark can be used.
- Cutting area depends on the MARK DISTANCE and the settings.



## Alignment registration mark

A function to continuously cut the print with same design aligned, using a plugin for the Illustrator. It is appropriate for cutting multiple numbers of stickers or similar.

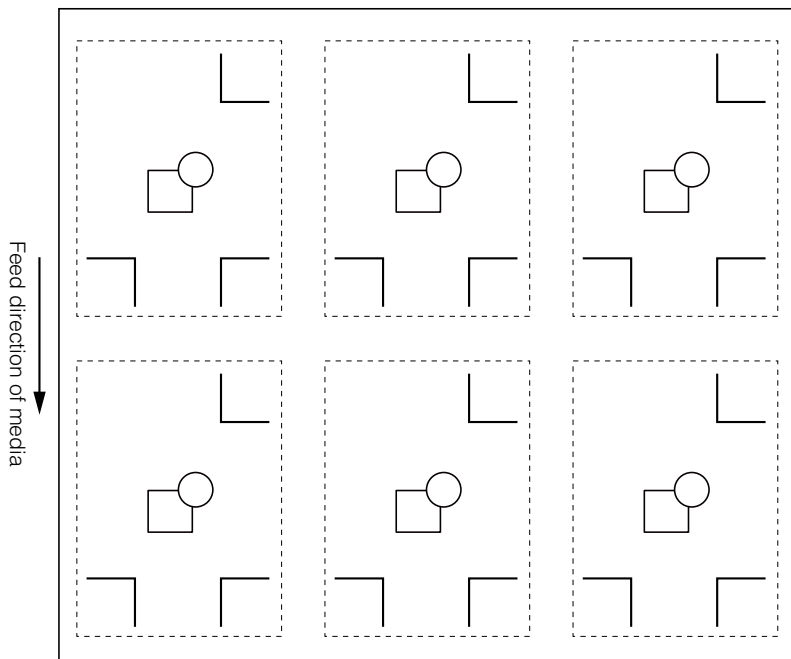

### Supplement

- It cannot be set on the plotter.
- Setting is only possible from the Cutting Master 2.

## Operation

1 Press the **[MENU]** key.

▶ MENU screen is displayed.



2 Press the **[2]** key (ARMS).

▶ ARMS SETTING screen (1/4) is displayed.

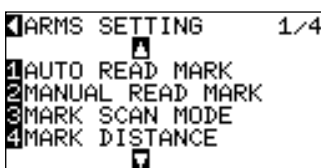

3 Press the **[3]** key (MARK SCAN MODE).

▶ MARK SCAN MODE screen is displayed.

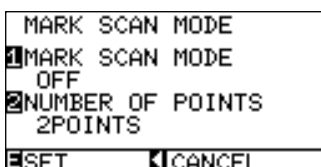

Next page

4 Press the [1] key (MARK SCAN MODE).

▶ MARK SCAN MODE setting screen is displayed.



5 Press the [1] key (OFF), the [2] key (ARMS), or the [3] key (AXIS ALIGNMENT).

▶ MARK SCAN MODE is selected and it will return to MARK SCAN MODE setting screen.

#### Supplement

It will return to MARK SCAN MODE setting screen without changing the settings when you press the POSITION (◀) key (PREVIOUS).

6 Press the [2] key (POINTS).

▶ NUMBER OF POINTS setting screen is displayed.

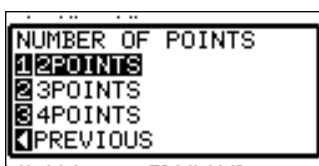

7 Press the [1] key (2POINT), the [2] key (3POINT), or the [3] key (4POINT).

▶ POINTS is selected and it will return to MARK SCAN MODE setting screen.

#### Supplement

It will return to MARK SCAN MODE setting screen without changing the settings when you press the POSITION (◀) key (PREVIOUS).

8 Confirm the setting and press the [ENTER] key (SET).

▶ Setting will be set, and it will return to ARMS setting screen (1/4).

#### Supplement

It will return to ARMS setting screen (1/4) without changing the settings when you press the POSITION (◀) key (CANCEL).

9 Press the [MENU] key.

▶ It will return to default screen.

## Setting Shape (Pattern) of Registration Mark

Preset the shape (pattern) of registration marks to scan.

#### Supplement

See "Setting Shape (Pattern) of Registration Mark" [P.5-9](#) P.5-9 for the difference in registration mark shapes.

### Operation

1 Press the [MENU] key.

▶ MENU screen is displayed.



Next page

2

Press the [2] key (ARMS).

▶ ARMS setting screen (1/4) is displayed.

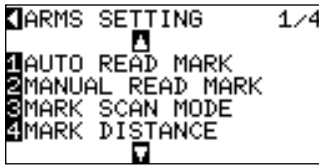

3

Press the **POSITION** (▼) key.

▶ ARMS SETTING screen (2/4) is displayed.

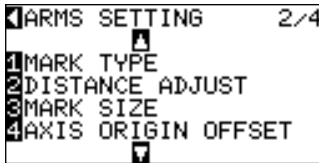

4

Press the [1] key (MARK TYPE).

▶ MARK TYPE setting screen is displayed.

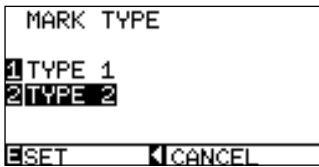

**Supplement**

It will return to ARMS setting screen (2/4) without changing the settings when you press the POSITION (◀) key (CANCEL).

6

Press the [1] key (TYPE1) or the [2] key (TYPE2).

**Supplement**

MARK TYPEs that the plotter can detect are 2 types shown in bottom left figures.

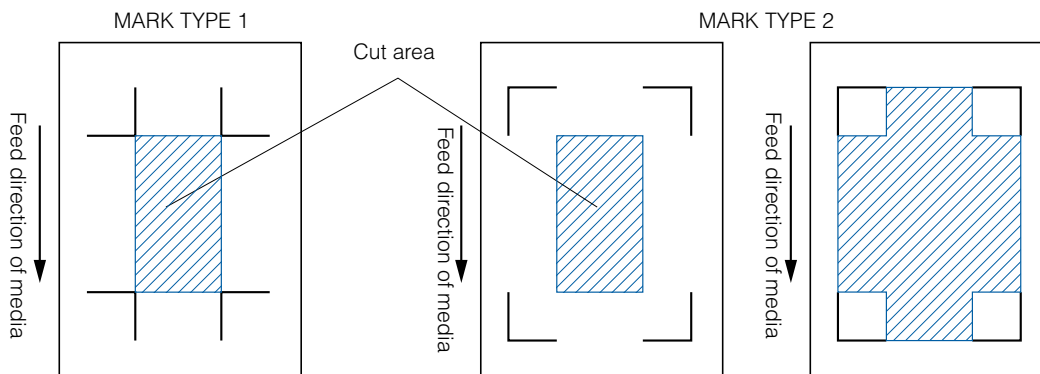

7

Confirm the setting and press the [ENTER] key (SET).

▶ Setting will be set, and it will return to ARMS setting screen (2/4).

**Supplement**

It will return to ARMS setting screen (2/4) without changing the settings when you press the POSITION (◀) key (CANCEL).

8

Press the [MENU] key.

▶ It will return to the default screen.

## Setting Registration Mark Size

Preset the size of registration marks to scan.

Size of the registration mark that can be set is from 5 mm to 20 mm.

Bigger registration mark size is better if there is difference in printing or media is set tilted. But the cutting area becomes smaller with the bigger registration mark.

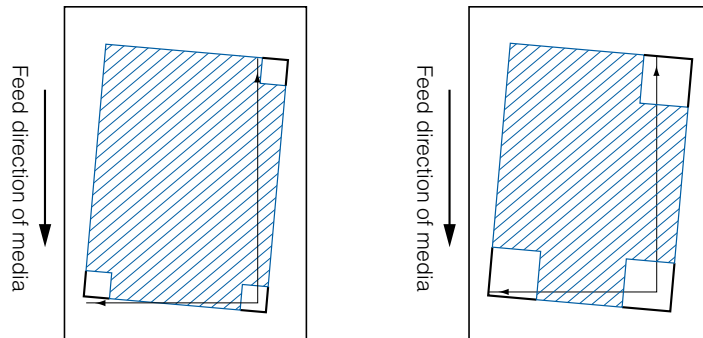

When detecting a registration mark, it will start from the lower left registration mark, and search next in horizontal and vertical directions. If the print is tilted as shown left, short registration marks will be outside the detection area.

If the registration marks are large like shown right, it can be detected even if the print is tilted.

It will be easier to detect using larger registration size when using a cutting data long in the media feed direction.

## Operation

1 Press the **[MENU]** key.

▶ MENU screen is displayed.



2 Press the **[2]** key (ARMS).

▶ ARMS SETTING screen (1/4) is displayed.

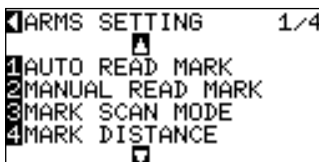

3 Press the **POSITION (▼)** key.

▶ ARMS SETTING screen (2/4) is displayed.

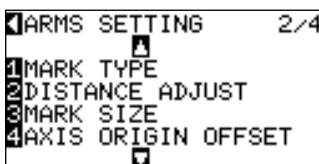

Next page

4

Press the [3] key (MARK SIZE).

▶ MARK SIZE setting screen is displayed.

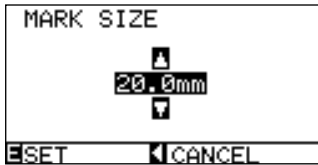

5

Press the **POSITION** (▲▼) key and increase or decrease the setting value.



6

Confirm the settings and press the [ENTER] key (SET).

▶ Setting will be set, and it will return to ARMS setting screen (2/4).

7

Press the [MENU] key.

▶ It will return to default screen.

### Supplement

It will return to ARMS setting screen (2/4) without changing the settings when you press the POSITION (▲) key (CANCEL).

### Supplement

It will return to ARMS setting screen (2/4) without changing the settings when you press the POSITION (▲) key (CANCEL).

## Setting Mark Distance

Mark distance is set so it will not perform detection of the location where the registration marks are not present. This allows to scan the registration marks faster, and also prevents malfunction by the dirty media. You can write a comment (TYPE1), or write the cut data (TYPE2) in the area that the registration mark is not detected.

### Reference

- Specify the distance between the registration marks in the direction of media movement for X, and the distance between the registration marks in the direction of the tool block movement for Y. (See below).

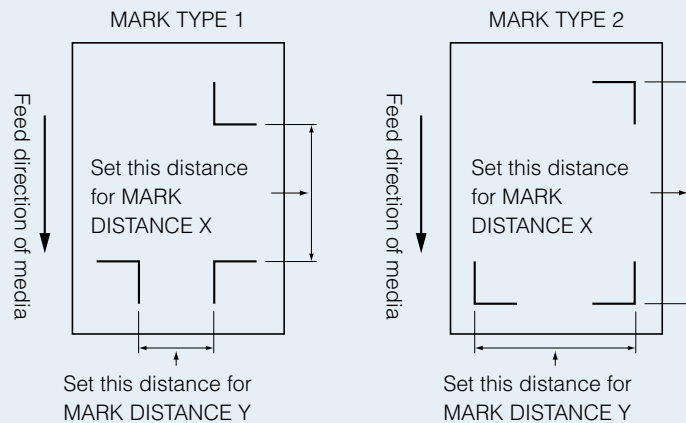

- Detection is started from the position of the registration mark size before the specified distance.
- Skipping of the distance between the registration mark will not be performed until next registration mark is found when the mark distance is set to 0 mm.
- Value of Y is ignored if it is 2POINTS.
- Enter value smaller than the length of the media for the MARK DISTANCE X. The media gets dropped if it is larger.

# Operation

1 Press the [MENU] key.

▶MENU screen is displayed.



2 Press the [2] key (ARMS).

▶ARMS SETTING screen (1/4) is displayed.

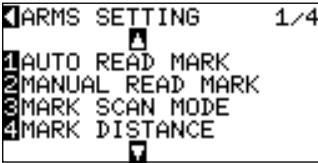

3 Press the [4] key (MARK DISTANCE).

▶MARK DISTANCE setting screen is displayed.



4 Press the [1] key (X).

▶X AXIS setting screen is displayed.



5 Press the **POSITION** (▲▼) key and increase or decrease the setting value.



6 Confirm the setting and press the **POSITION** (◀) key (PREVIOUS).

▶MARK DISTANCE is selected and it will return to MARK DISTANCE screen.

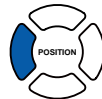

7 Press the [2] key (Y).

▶Y AXIS setting screen is displayed.



**Supplement**  
 Digits of settings can be changed by pressing the [FAST] key.  
 Setting range is from 0.0 to 50000.0 mm.

Next page

8 Press the **POSITION** (▲▼) key and increase or decrease the setting value.

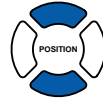

#### Supplement

Digits of settings can be changed by pressing the [FAST] key.  
Setting range is from 0.0 to 50000.0 mm.

9 Confirm the setting and press the **POSITION** (◀) key (PREVIOUS).

▶ MARK DISTANCE is selected and it will return to MARK DISTANCE screen.

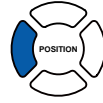

10 Confirm the setting and press the **[ENTER]** key (SET).

▶ Setting will be set, and it will return to ARMS setting screen (1/4).

#### Supplement

It will return to ARMS setting screen (1/4) without changing the settings when you press the POSITION (◀) key (CANCEL).

11 Press the **[MENU]** key.

▶ It will return to default screen.

## Setting Distance Adjustment Between the Registration Mark

It will adjust the cutting if the distance between the registration marks are different from the original value on the data using the ratio calculated from the difference. This is called distance adjustment between registration marks.

There are following 3 modes for adjustment between registration marks.

User: Original value on the data against the distance of scanned registration marks are entered manually to perform adjustment.

Custom: If the distance between the registration mark are to be output in factors of 5, 10, or 50 mm, set that unit as the "CUSTOM UNIT", and automatically adjust the distance between the registration marks. For example, set the "CUSTOM UNIT" to 5 mm, and if the distance between the scanned registration marks were 312 mm, it will be rounded off to the closest 5 mm, and the adjustment will be performed so the ideal distance will be 310 mm.

Standard: Depending on the settings of the distance between the registration marks (see "Setting Mark Distance" [P.5-12](#)), either 5, 10, or 50 mm will be selected as the unit automatically. Values of the distance between scanned registration mark will be rounded off to the nearest units selected, which will be used as the original value on the data to perform the adjustment.

## Operation

1 Press the **[MENU]** key.

▶ MENU screen is displayed.



Next page

2 Press the [2] key (ARMS).

▶ ARMS SETTING screen (1/4) is displayed.

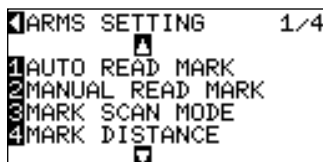

3 Press the POSITION (▼) key.

▶ ARMS SETTING screen (2/4) is displayed.

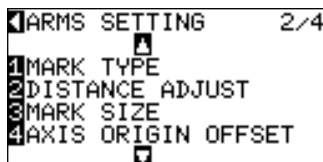

4 Press the [2] key (DISTANCE ADJUST).

▶ DISTANCE ADJUST setting screen is displayed.

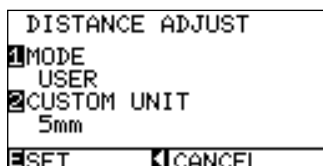

### Supplement

It will return to ARMS setting screen (2/4) without changing the settings when you press the POSITION (◀) key (CANCEL).

5 Press the [1] key (MODE).

▶ DISTANCE ADJUST MODE selection screen is displayed.

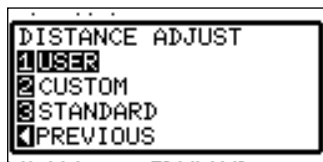

6 Press the [1] key (USER), the [2] key (CUSTOM), or the [3] key (STANDARD).

▶ Mode is selected and it will return to DISTANCE ADJUST screen.

### Supplement

It will return to MARK DISTANCE screen without changing the settings when you press the POSITION (◀) key (PREVIOUS).

7 The procedures are different depending on the selected mode.

### When USER or STANDARD modes are selected

Jump to step 9.

### When CUSTOM mode is selected

Press the [2] key (CUSTOM UNIT).

▶ CUSTOM UNIT selection screen is displayed.



Next page



8

Press the [1] key (5mm), the [2] key (10mm), or the [3] key (50mm).

▶CUSTOM UNIT is selected and it will return to DISTANCE ADJUST screen.

9

Confirm the setting and press the [ENTER] key (SET).

▶Setting will be set, and it will return to ARMS setting screen (2/4).

10

Press the [MENU] key.

▶It will return to default screen.

**Supplement**

It will return to MARK DISTANCE screen without changing the settings when you press the POSITION (◀) key (PREVIOUS).

**Setting Offset Between the Registration Mark and Cutting Origin Points**

The distance between the cutting origin point and the register mark (POINT1) is called axis origin offset. Default value of axis origin offset is 0.0 for both X and Y, but it can be set in the range from -1000.0 mm to +1000.0 mm.

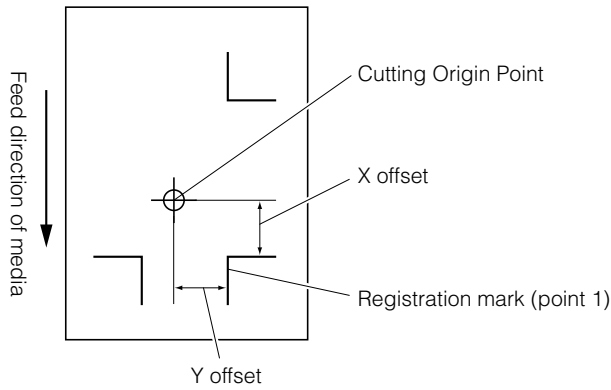

**Operation**

1

Press the [MENU] key.

▶MENU screen is displayed.



2

Press the [2] key (ARMS).

▶ARMS SETTING screen (1/4) is displayed.

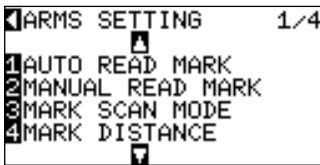

3

Press the POSITION (▼) key.

▶ARMS SETTING screen (2/4) is displayed.

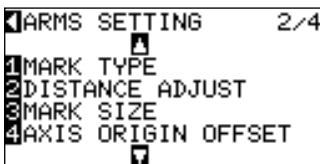

Next page

4

Press the [4] key (AXIS ORIGIN OFFSET).

►AXIS ORIGIN OFFSET screen is displayed.



5

Press the [1] key (X).

►X AXIS setting screen is displayed.



6

Press the **POSITION** (▲▼) key and increase or decrease the setting value.

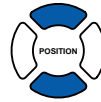

#### Supplement

- Digits of settings can be changed by pressing the [FAST] key.
- Setting range is from -1000.0 to +1,000.0mm.

7

Confirm the setting and press the **POSITION** (◀) key (PREVIOUS).

►Offset value will be selected, and it will return to AXIS ORIGIN OFFSET mode screen.

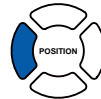

8

Press the [2] key (Y).

►Y AXIS setting screen is displayed.

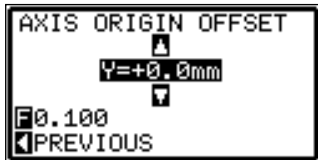

9

Press the **POSITION** (▲▼) key and increase or decrease the setting value.



#### Supplement

- Digits of settings can be changed by pressing the [FAST] key.
- Setting range is from -1,000.0 to +1,000.0mm.

10

Confirm the setting and press the **POSITION** (◀) key (PREVIOUS).

►Offset value will be selected, and it will return to AXIS ORIGIN OFFSET mode screen.

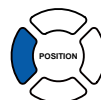

11

Confirm the setting and press the [ENTER] key (SET).

►Setting will be set, and it will return to ARMS setting screen (2/4).

12

Press the [MENU] key.

►It will return to default screen.

#### Supplement

It will return to ARMS setting screen (2/4) without changing the settings when you press the **POSITION** (◀) key (CANCEL).

## Adjusting the Sensor Level

Scan level (threshold value between the media background color and registration mark) of the sensor scanning the registration mark is automatically adjusted.

Sensor is adjusted to scan the registration mark written in black lines on white background. Readjust the scan level of the sensor depending on the color and gloss of the media.

If it is hard to adjust the level automatically due to media surface characteristics, adjust the scan level of the sensor manually.

### Operation

1 Load the media with level adjustment pattern in the plotter.

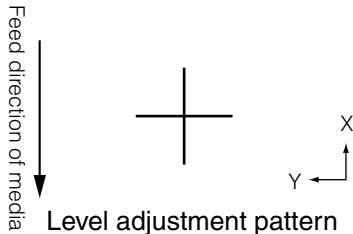

2 Press the [MENU] key.

▶MENU screen is displayed.



3 Press the [2] key (ARMS).

▶ARMS SETTING screen (1/4) is displayed.

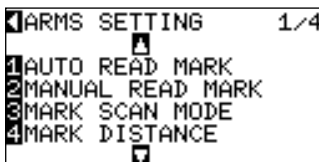

4 Press the POSITION (▼) key twice.

▶ARMS SETTING screen (3/4) is displayed.

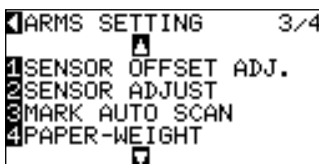

5 Press the [2] key (SENSOR ADJUST).

▶SENSOR ADJUST screen is displayed.

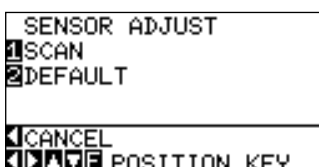

#### Supplement

- See "Loading Media (Paper or Marking Film)" P.2-6 for setting the media.
- Use the media that will be used with a line with width of the registration mark written in registration mark color for the level adjustment pattern.

#### Supplement

It will return to ARMS setting screen (3/4) without changing the settings when you press the POSITION (◀) key (CANCEL).

Next page

6

Press the [1] key (SCAN).

►Following message is displayed.



**Supplement**

It will return to ARMS setting screen (3/4) after setting the sensor level to default when you press the [2] key (DEFAULT).

7

Press the **POSITION** (▲▼◀▶) key and move the tool carriage to the area to start scanning of the registration mark.

Registration mark scan area

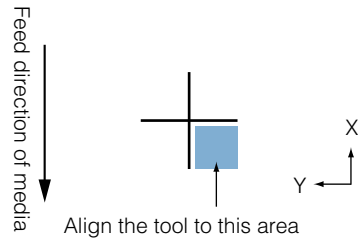

**Supplement**

The tool carriage will move faster when the [FAST] key is pressed simultaneously with the POSITION key.

8

Confirm the position of the tool, and if it is OK, press the [ENTER] key.

►Registration mark is scanned, and sensor level is adjusted. It will return to ARMS setting screen (3/4) once the adjustment is completed.

**Supplement**

- It will return to ARMS setting screen (3/4) without adjustment when you press the [4] key (CANCEL).
- It may not scan correctly even after the adjustment depending on the condition of the media. See "Manual Position Adjust" [P.6-3](#) if the detection does not complete properly.

9

Press the [MENU] key.

►It will return to default screen.

## Manually Adjusting the Sensor Level (Threshold Value)

Scan level (threshold value between the media background color and registration mark) of the sensor scanning the registration mark is set.

Sensor is adjusted to scan the registration mark written in black lines on white background. Adjust the scan level of the sensor depending on the color and gloss of the media.

[P.5-18](#) **Adjusting the Sensor Level**

### Operation

1

Press the [MENU] key.

►MENU screen is displayed.



2

Press the [2] key (ARMS).

►ARMS SETTING screen (1/4) is displayed.

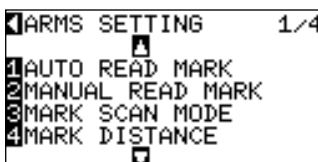

Next page

3

Press the **POSITION (▲)** key.

▶ ARMS setting screen (4/4) is displayed.

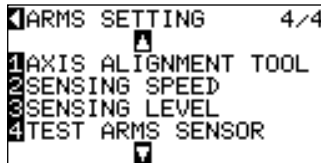
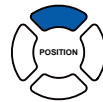

4

Press the **[3]** key (SENSING LEVEL).

▶ SENSING LEVEL adjusting screen is displayed.

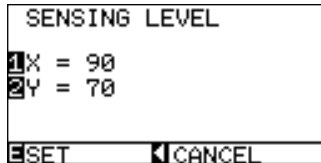

5

Press the **[1]** key (X).

▶ SENSING LEVEL X adjusting screen is displayed.



6

Press the **POSITION (▲▼)** key and increase or decrease the setting value.



7

Confirm the setting and press the **POSITION (◀)** key (PREVIOUS).

▶ SENSING LEVEL is selected and it will return to SENSING LEVEL adjusting screen.

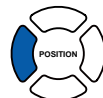

8

Press the **[2]** key (Y).

▶ SENSING LEVEL Y adjusting screen is displayed.

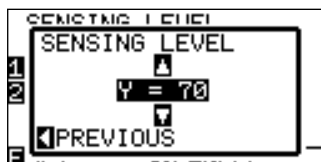

9

Press the **POSITION (▲▼)** key and increase or decrease the setting value.

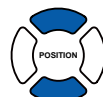

### Supplement

- It will return to ARMS setting screen (4/4) without changing the settings when you press the POSITION (◀) key (CANCEL).
- Detection level will define the threshold to be placed at what percentage point of the signal level difference between the media background color and the registration mark. So the setting range becomes 30 to 90 (%).
- X sets the level to detect the registration mark when moving in the X direction, and Y sets the level to detect the registration mark when moving in the Y direction.

### Supplement

It will ignore the dust and bumps on the media surface, but it will make the detection of the registration harder mark if the value of the "SENSING LEVEL" is set to larger number. The dust and bumps on the media surface might be detected as registration mark by mistake if the value of the "SENSING LEVEL" is set to smaller number.

### Supplement

Setting range is from 30 to 90.

### Supplement

Setting range is from 30 to 90.

10

Confirm the setting and press the **POSITION** (◀) key (PREVIOUS).

- ▶ DETECTION THRESHOLD is selected and it will return to DETECTION THRESHOLD adjusting screen.

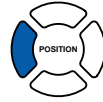

11

Confirm the setting and press the **[ENTER]** key (SET).

- ▶ Setting will be set, and it will return to ARMS setting screen (4/4).

12

Press the **[MENU]** key.

- ▶ It will return to default screen.

### Supplement

It will return to ARMS setting screen (4/4) without changing the settings when you press the POSITION (◀) key (CANCEL).

## Test the Registration Mark Sensor

If there still is a difference in the cutting, even after performing an adjustment using the registration mark, it is possible to check if there is a problem with the registration mark itself or the application by evaluating the position of the registration mark plotted and detected only using the plotter.

### CAUTION

This function performs cutting after the registration mark is scanned. If a cutter is used as the tool, it may harm the plotter.

## Operation

1

Print the standard registration mark in the accessory CD.

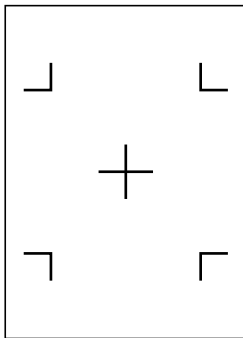

MARK TYPE 1

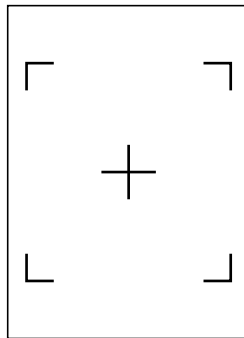

MARK TYPE 2

### Supplement

- Print the "Test Pattern 1" to test MARK TYPE 1, and "Test Pattern 2" to test MARK TYPE 2.
- Standard registration mark is inside the "ARMS Test Files" folder of the accessory CD.

Registration Mark	File Format	File Name
MARK TYPE 1	pdf	ARMStest_type1.pdf
	eps	ARMStest_type1.eps
MARK TYPE 2	pdf	ARMStest_type2.pdf
	eps	ARMStest_type2.eps

2

Load the printed media onto the plotter.

### Supplement

See "Loading Media (Paper or Marking Film)"

[P.2-6](#) for loading the media.

3

Press the **[MENU]** key.

- ▶ MENU screen is displayed.



4

Press the **[2]** key (ARMS).

- ▶ ARMS setting screen (1/4) is displayed.

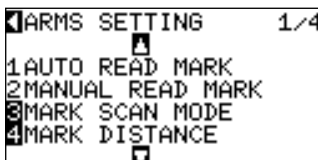

[Next page](#)

5

Press the **POSITION (▲)** key.

▶ ARMS setting screen (4/4) is displayed.

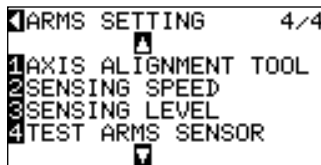

6

Press the **[4]** key (TEST ARMS SENSOR).

▶ TEST ARMS SENSOR screen is displayed.

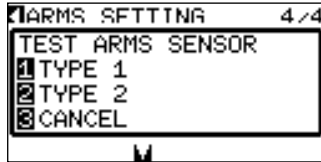

7

Press either the **[1]** key (TYPE 1) or the **[2]** key (TYPE 2) depending on the type of the registration mark to be used.

▶ Following message is displayed.



8

Move the tool to the position to start scanning of the registration mark by pressing the **POSITION (▲▼◀▶)** key.

#### Registration mark scan area

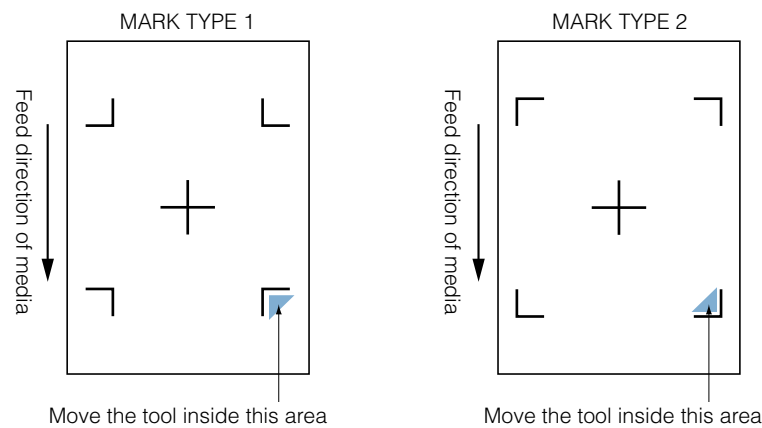

9

Confirm the position of the tool and press the **[ENTER]** key.

▶ The plotter will automatically detect the registration mark and cut the peak of each registration marks.

10

Confirm the cutting result.

▶ See "Adjusting for the Registration Mark Scan Position" P.5-24 and adjust if the cutting position is shifted. See "Adjusting the Sensor Level" P.5-18 and adjust if the registration mark cannot be scanned.

#### Supplement

It will return to TOOL setting screen (3/3) without changing the settings when you press the [3] key (CANCEL).

#### Supplement

It will return to TOOL setting screen (3/3) without changing the settings when you press the [4] key (CANCEL).

#### Supplement

Following error is displayed when the registration mark was not scanned properly. Press the [1] key (SCAN AGAIN) to scan again, or the [2] key (CANCEL) to exit.

## Setting Speed of the Registration Mark Scan

Speed of the tool carriage and media to scan the registration mark is set.

It may not scan the registration marks or the difference may become large when the speed is too high, but the cutting time becomes longer when the speed is too slow. Adjust the setting value considering the balance.

It is normally set to "NORMAL", but the scanning might improve when it is set to "SLOW" in cases where the registration marks cannot be scanned or the difference is too big.

### Operation

1 Press the **[MENU]** key.

▶MENU screen is displayed.



2 Press the **[2]** key (ARMS).

▶ARMS SETTING screen (1/4) is displayed.

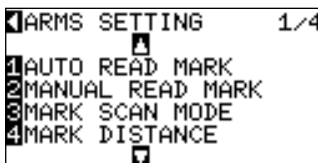

3 Press the **POSITION (▲)** key.

▶ARMS SETTING screen (4/4) is displayed.

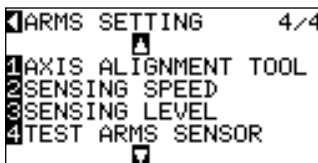
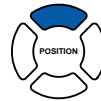

4 Press the **[2]** key (SENSING SPEED).

▶SENSING SPEED adjusting screen is displayed.

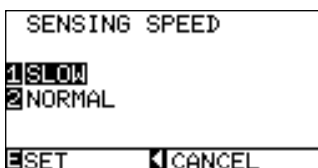

5 Press the **[1]** key (SLOW) or the **[2]** key (NORMAL).

6 Confirm the setting and press the **[ENTER]** key (SET)

▶Setting will be set, and it will return to ARMS setting screen (4/4).

7 Press the **[MENU]** key.

▶It will return to default screen.

#### Supplement

It will return to ARMS setting screen (4/4) without changing the settings when you press the **POSITION (◀)** key (CANCEL).



## Adjusting for the Registration Mark Scan Position

Sensor to scan the registration mark is positioned away from the tip of the tool (pen tip). Therefore, it is necessary to adjust the coordinate values of the scanned registration mark so it will match with the cutting position.

If the registration mark is already marked on the media, scan that registration mark, plot another registration mark in the same position, and measure the difference between them. This difference is entered as an adjustment value.

If there is no registration mark on the media, plot a registration mark first, scan that registration mark, plot another registration mark, and measure the difference of them. This difference is entered as an adjustment value.

### Reference

There is a restriction on the shape (style) of the registration marks that can be scanned. See "Setting Shape (Pattern) of Registration Mark"

 P.5-9

## Adjust After Plotting the Adjustment Registration Mark

This section describes the steps to plot the registration mark.

Registration mark is to be plotted if there is no registration mark on the media to adjust the registration mark scan position. Then proceed to the steps of "Adjust the Registration Mark Position".

### Reference

Proceed to "Setting the Position Using ARMS"  P.5-30 without plotting the registration mark if the registration mark is already drawn on the media.

## Operation

- 1 Load white media.
- 2 Set the water-based fiber pen (black) on the tool holder.
- 3 Press the [MENU] key.

▶MENU screen is displayed.



- 4 Press the [2] key (ARMS).

▶ARMS SETTING screen (1/4) is displayed.

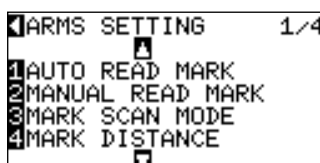

### Supplement

See "Loading Media (Paper or Marking Film)"

 P.2-6 for loading white media.

### Supplement

See "Attaching a Tool"  P.2-4 for setting the water-based fiber pen.

 Next page

5

Press the **POSITION (▼)** key twice.

► ARMS SETTING screen (3/4) is displayed.

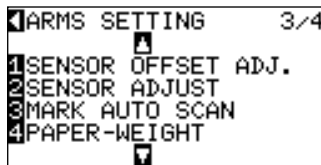

6

Press the **[1]** key (SENSOR OFFSET ADJ.).

► SENSOR OFFSET ADJ. setting screen is displayed.



### Supplement

It will return to ARMS setting screen (3/4) without changing the settings when you press the POSITION (◀) key (CANCEL).

7

Press the **[1]** key (TEST PATTERN).

► Following message is displayed.



8

Press the **POSITION (▲▼◀▶)** key and move the tool carriage to the position to plot the registration mark (position nothing is printed).



9

Press the **[ENTER]** key.

► Registration mark is plotted.

### Supplement

It will return to SENSOR OFFSET ADJ. screen without plotting by pressing the [4] key (CANCEL).

10

Confirm that the tool is at the position shown in the left image, and press the **[ENTER]** key.

► It will read the registration mark, and then plot the registration mark for comparison. It will return to SENSOR OFFSET ADJ. screen once the plotting is completed.

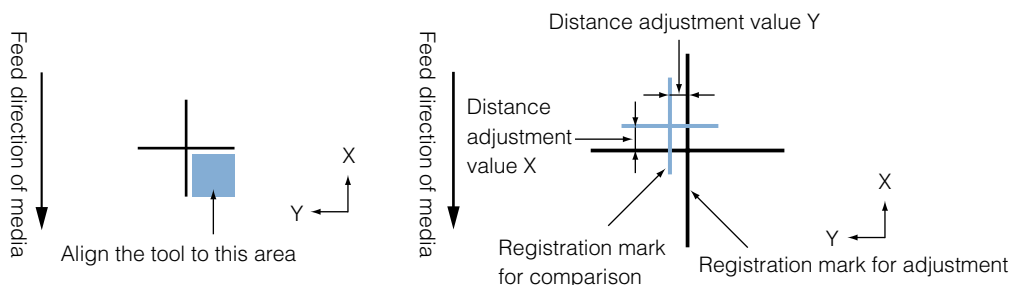

Next page

11 Using the registration mark plotted in step 9, measure the distance of how much the comparison registration mark needs to be moved so both will overlap, and record the value. As an example, in the figure above, it needs to move in negative directions for both X and Y directions, so both of the adjustment values will be negative values.

12 Press the [3] key (X).

►SENSOR OFFSET ADJ. X screen is displayed.

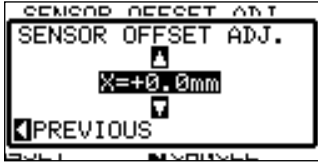

13 Press the **POSITION** (▲▼) key and increase or decrease the setting value. Set the X value measured in step 11.

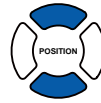

14 Confirm the setting and press the **POSITION** (◀) key (PREVIOUS).

►SENSOR OFFSET ADJ. is selected and it will return to SENSOR OFFSET ADJ. screen.

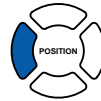

15 Press the [4] key (Y).

►SENSOR OFFSET ADJ. Y screen is displayed.

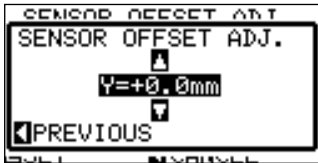

16 Press the **POSITION** (▲▼) key and increase or decrease the setting value. Set the Y value measured in step 11.

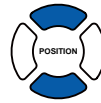

17 Confirm the setting and press the **POSITION** (◀) key (PREVIOUS).

►SENSOR OFFSET is selected and it will return to SENSOR OFFSET ADJ. screen.

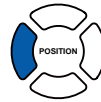

18 Confirm the setting and press the [ENTER] key (SET).

►Setting will be set, and it will return to ARMS setting screen (3/4).

19 Press the [MENU] key.

►It will return to the default screen.

### Supplement

Position of the registration mark is measured at the center of the line.

### Supplement

It will return to ARMS setting screen (3/4) without changing the setting when you press the POSITION (◀) key (CANCEL).

## Detect the Registration Mark for Adjustment on the Media and Enter the Value

Method to enter the adjustment value, which is the difference between the scanned registration mark on the media and the cutting position, is described here.

### Supplement

Plot the registration mark before going to following steps if there is no registration mark written on the media. See "Adjust After Plotting the Adjustment Registration Mark" [P.5-24](#) to plot registration marks.

## Operation

1 Load the media with adjustment registration mark in the plotter.

2 Press the [MENU] key.

▶MENU screen is displayed.



3 Press the [2] key (ARMS).

▶ARMS SETTING screen (1/4) is displayed.

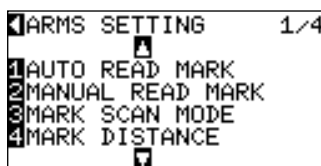

4 Press the POSITION (▼) key twice.

▶ARMS SETTING screen (3/4) is displayed.

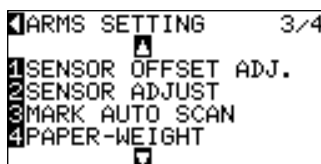

5 Press the [1] key (SENSOR OFFSET ADJ.).

▶SENSOR OFFSET ADJ. setting screen is displayed.



### Supplement

See "Loading Media (Paper or Marking Film)"

[P.2-6](#) for loading the media.

### Supplement

It will return to ARMS setting screen (3/4) without changing the settings when you press the POSITION (◀) key (CANCEL).

Next page

6

Press the [2] key (SCAN).

▶Following message is displayed.



7

Press the **POSITION** (▲▼◀▶) key and move the tool carriage to the area to start scanning of the registration mark.



Registration mark scan area

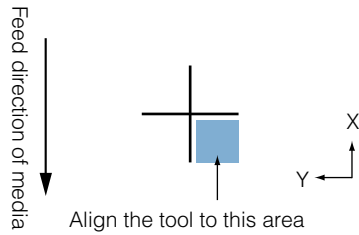

8

Confirm the position of the tool, and if it is OK, press the [ENTER] key.

▶The registration mark for comparison is plotted after scanning the registration mark (see below). It will return to SENSOR OFFSET ADJ. screen once the plotting is completed.

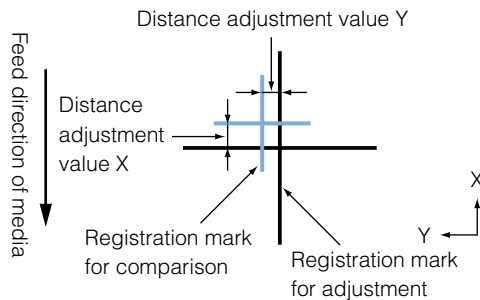

9

Using the scanned registration mark for adjusting, measure the distance of how much the comparison registration mark needs to be moved so both will overlap, and record the value. As an example, in the figure above, it needs to move in negative directions for both X and Y directions, so both of the adjustment values will be a negative values.

10

Press the [3] key (X).

▶SENSOR OFFSET ADJ. X screen is displayed.

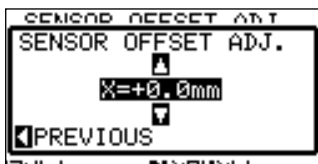

### Supplement

The tool carriage will move faster when the [FAST] key is pressed simultaneously with the POSITION key.

### Supplement

It will return to ARMS setting screen (3/4) without plotting when you press the [4] key (CANCEL).

### Supplement

Position of the registration mark is measured at the center of the line.

11

Press the **POSITION (▲▼)** key and increase or decrease the setting value. Set the X value measured in step 9.

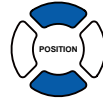

12

Confirm the setting and press the **POSITION (◀)** key (PREVIOUS).

►SENSOR OFFSET ADJ. is selected and it will return to SENSOR OFFSET ADJ. screen.

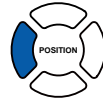

13

Press the **[4]** key (Y).

►SENSOR OFFSET ADJ. Y screen is displayed.

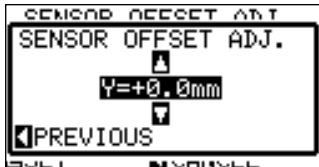

14

Press the **POSITION (▲▼)** key and increase or decrease the setting value. Set the Y value measured in step 9.

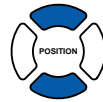

15

Confirm the setting and press the **POSITION (◀)** key (PREVIOUS).

►SENSOR OFFSET is selected and it will return to SENSOR OFFSET ADJ. screen.

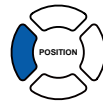

16

Confirm the setting and press the **[ENTER]** key (SET).

►Setting will be set, and it will return to ARMS setting screen (3/4).

17

Press the **[MENU]** key.

►It will return to the default screen.

**Supplement**

It will return to ARMS setting screen (3/4) without changing the setting when you press the **POSITION (◀)** key (CANCEL).

This section describes the method to adjust the position with the operation from control panel using ARMS.

There are following 3 methods depending on the number of registration marks scanned. In general, the adjustment becomes more accurate with more registration marks scanned, but it will take longer to adjust.

 **Adjust with 2POINTS**

 **Adjust with 3POINTS**

 **Adjust with 4POINTS**

 **Adjust Automatically**

 **Adjust Manually**

#### Reference

Perform the automatic registration mark scanning with paper-weight (See "Setting Paper-Weight" ) turned on. The media might lift, and it may not scan the registration mark correctly if it is turned off.

### Adjust with 2POINTS

2POINTS adjustment will scan 2 registration marks aligned in the media transportation direction, where the adjustment is done measuring the tilting of the axis and the distance between the registration marks. This adjustment is 1 axis adjustment (tilt adjustment).

If the loaded media is tilted as shown below, position of the scanned registration mark is shifted from the position where it should be. Tilt and distance can be adjusted by comparing these coordinate values.

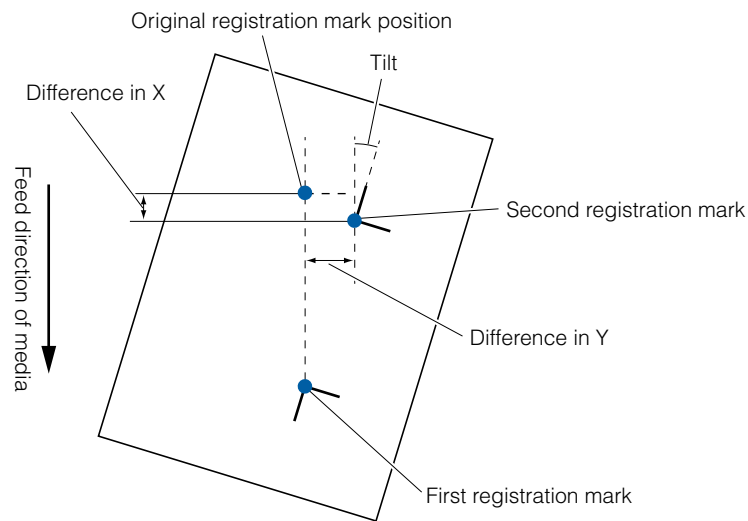

# Operation

1 Load the media with registration marks (2POINTS) plotted.

## Supplement

See "Loading Media (Paper or Marking Film)"

[P.2-6](#) for loading the media.

2 Set the MARK SCAN MODE to ARMS, and POINTS to 2POINTS.

[P.5-6](#) **Setting MARK SCAN Mode and Numbers**

3 Set the shape and size of the registration mark, mark distance, distance adjust mode, offset, paper-weight, sensor level, scan position adjustment, etc., as needed.

## Supplement

It is not necessary to set the MARK DISTANCE when it is adjusted manually.

[P.5-9](#) **Setting Shape (Pattern) of Registration Mark**

[P.5-11](#) **Setting Registration Mark Size**

[P.5-12](#) **Setting Mark Distance**

[P.5-14](#) **Setting Distance Adjustment Between the Registration Mark**

[P.5-16](#) **Setting Offset Between the Registration Mark and Cutting Origin Points**

[P.5-18](#) **Adjusting the Sensor Level**

[P.5-19](#) **Manually Adjusting the Sensor Level (Threshold Value)**

[P.7-21](#) **Setting Paper-Weight**

4 Press the [MENU] key.

▶MENU screen is displayed.



5 Press the [2] key (ARMS).

▶ARMS SETTING screen is displayed.

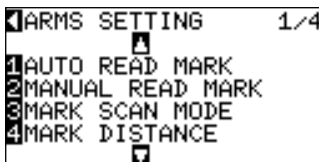

Steps are different from here depending if it is going to move to registration mark automatically to scan the registration mark, or if it is going to move manually to scan. See next section.

[P.5-34](#) **Automatically Adjust**

[P.5-36](#) **Adjust Manually**



## Adjust with 3POINTS

3POINTS adjustment will scan 3 registration marks as shown below, where the adjustment is done measuring the tilting of the X and Y axes and the distance between the registration marks (horizontal and vertical directions). This adjustment is called 2 axis adjustment (tilt adjustment).

If the loaded media is tilted as shown below, position of the scanned registration mark is shifted from the position where it should be. Tilt and distance can be adjusted by comparing these coordinate values.

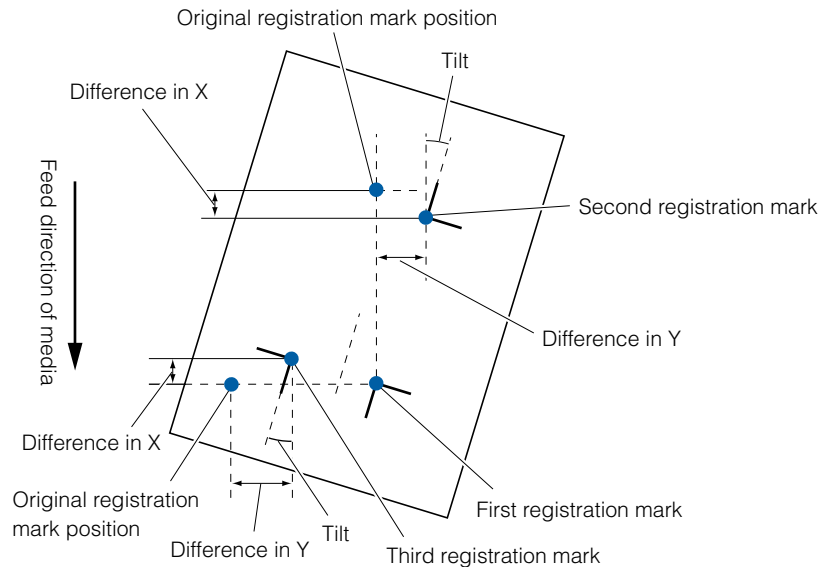

## Operation

1 Load the media with registration marks (3POINTS) plotted.

2 Set the MARK SCAN MODE to ARMS, and POINTS to 2POINTS.

P.5-6 **Setting MARK SCAN Mode and Numbers**

3 Set the shape and size of the registration mark, mark distance, distance adjust mode, offset, paper-weight, sensor level, scan position adjustment, etc., as needed.

P.5-9 **Setting Shape (Pattern) of Registration Mark**

P.5-11 **Setting Registration Mark Size**

P.5-12 **Setting Mark Distance**

P.5-14 **Setting Distance Adjustment Between the Registration Mark**

P.5-16 **Setting Offset Between the Registration Mark and Cutting Origin Points**

P.5-18 **Adjusting the Sensor Level**

P.5-19 **Manually Adjusting the Sensor Level (Threshold Value)**

P.7-21 **Setting Paper-Weight**

4 Press the [MENU] key.

▶MENU screen is displayed.



### Supplement

See "Loading Media (Paper or Marking Film)"

P.2-6 for loading the media.

### Supplement

It is not necessary to set the MARK DISTANCE when it is adjusted manually.

Next page

5

Press the [2] key (ARMS).

▶ ARMS SETTING screen is displayed.

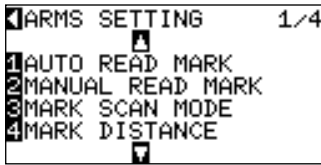

6

Steps are different from here depending if it is going to move to registration mark automatically to scan the registration mark, or if it is going to move manually to scan. See next section.

**P.5-34 Automatically Adjust**

**P.5-36 Adjust Manually**

### Adjust with 4POINTS

4POINTS adjustment will scan 4 registration marks in the corners, where the adjustment is done measuring the tilting of the X and Y axes and the distance between each of the registration marks. It will perform 2 axes warp adjustment in addition to the 2 axes (tilt) adjustment and distance adjustment, so it can adjust more precisely than other methods.

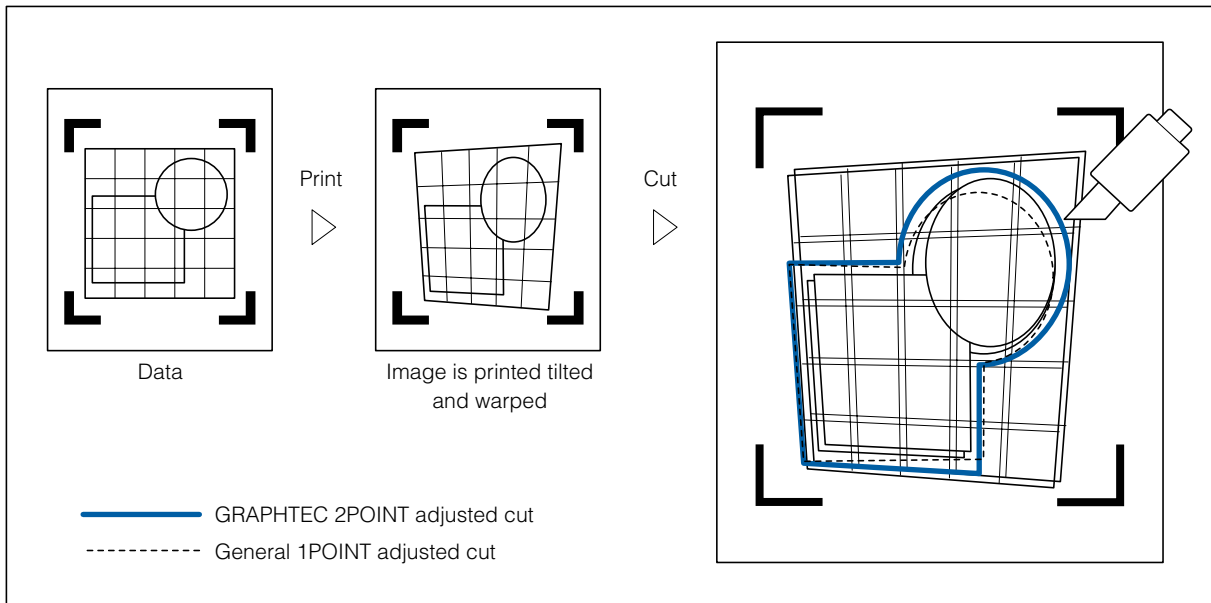

### Operation

1

Load the media with registration marks (4POINTS) plotted.

2

Set the MARK SCAN MODE to ARMS, and POINTS to 2POINTS.

**P.5-6 Setting MARK SCAN Mode and Numbers**

#### Supplement









See "Loading Media (Paper or Marking Film)"

**P.2-6** for loading the media.

Next page

3

Set the shape and size of the registration mark, mark distance, distance adjust mode, offset, paper-weight, sensor level, scan position adjustment, etc., as needed.

-  P.5-9 **Setting Shape (Pattern) of Registration Mark**
-  P.5-11 **Setting Registration Mark Size**
-  P.5-12 **Setting Mark Distance**
-  P.5-14 **Setting Distance Adjustment Between the Registration Mark**
-  P.5-16 **Setting Offset Between the Registration Mark and Cutting Origin Points**
-  P.5-18 **Adjusting the Sensor Level**
-  P.5-19 **Manually Adjusting the Sensor Level (Threshold Value)**
-  P.7-21 **Setting Paper-Weight**

**Supplement**

It is not necessary to set the MARK DISTANCE when it is adjusted manually.

4

Press the [MENU] key.

▶MENU screen is displayed.



5

Press the [2] key (ARMS).

▶ARMS SETTING screen is displayed.

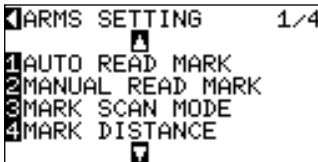

Steps are different from here depending if it is going to move to registration mark automatically to scan the registration mark, or if it is going to move manually to scan. See next section.

-  P.5-34 **Automatically Adjust**
-  P.5-36 **Adjust Manually**

**Automatically Adjust**

This section describes the operation to adjust with registration mark scan by moving to registration mark automatically after setting the ARMS mode and POINTS.

**Supplement**

See "Adjust Manually"  P.5-36 if you are moving manually to registration mark for scanning.

**Operation**

1

Press the [1] key (AUTO READ MARKS) in the ARMS setting screen (1/4).

▶Following message is displayed.

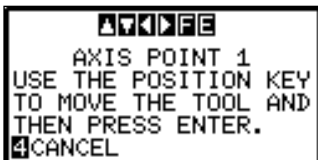

Next page

**Supplement**

Press the [2] key (ARMS) in the MENU screen if it is not ARMS setting screen.

2

Press the **POSITION** ( $\blacktriangle \blacktriangledown \blacktriangleleft \blacktriangleright$ ) key and move the tool carriage to the area to start scanning of the registration mark.



### Registration mark scan area

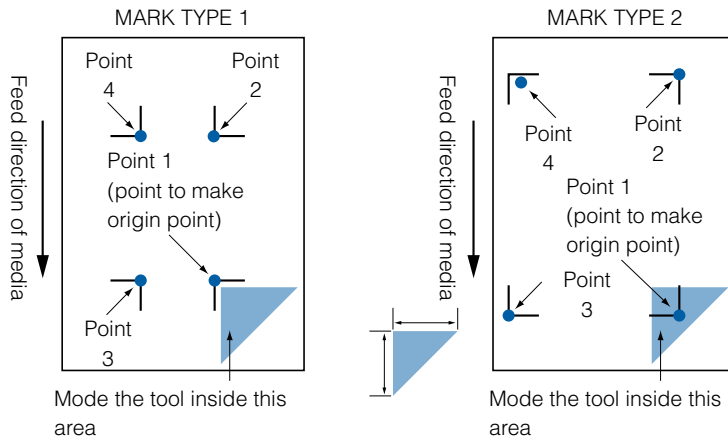

### Supplement

Left figure is for 4POINTS. Size and position of the registration scan start area is same for 2POINTS or 3POINTS.

3

Confirm the position of the tool, and if it is OK, press the **[ENTER]** key (SET).

Registration marks are scanned automatically. DISTANCE entry screen is displayed once the scanning is completed.

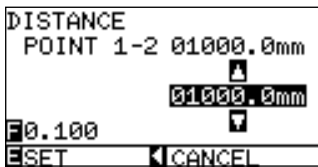

### Supplement

- Scan the registration marks in accordance with the setting of the MARK DISTANCE (see "Setting Mark Distance" [P.5-12](#)).
- It will return to ARMS setting screen (1/4) without scanning when you press the [4] key (CANCEL).

4

Press the **POSITION** ( $\blacktriangle \blacktriangledown$ ) key and increase or decrease the setting value.

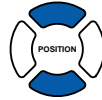

### Supplement

- Measured distance is displayed in the top line in the DISTANCE input screen. Input value (initially same as measured value) is displayed under that.
- If the input value is not changed, it will assume that there is no difference between measured distance and the distance in the data.
- Digits of settings can be changed by pressing the [FAST] key.

5

Confirm the setting and press the **[ENTER]** key (SET).

Adjustment by scanning the registration mark is completed, and it will return to default screen.

### Supplement

- It will return to ARMS setting screen (1/4) without changing the settings when you press the POSITION ( $\blacktriangleleft$ ) key (CANCEL).
- Distance input screen for point 3 is displayed if it is set to 3POINTS or more, so repeat steps 4 and 5 to set.

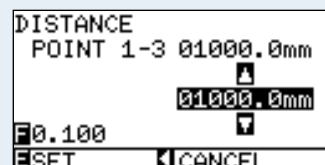

## Adjust Manually

This section describes the operation to adjust with registration mark scan by moving to registration mark manually after setting the ARMS mode and POINTS.

### Operation

- 1 Press the [2] key (MANUAL READ MARKS) in the ARMS setting screen.

▶ Following message is displayed.

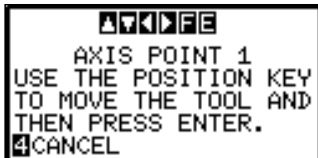

- 2 Press the **POSITION** (▲▼◀▶) key and move the tool carriage to the area to start scanning of the registration mark.



#### Registration mark scan start area

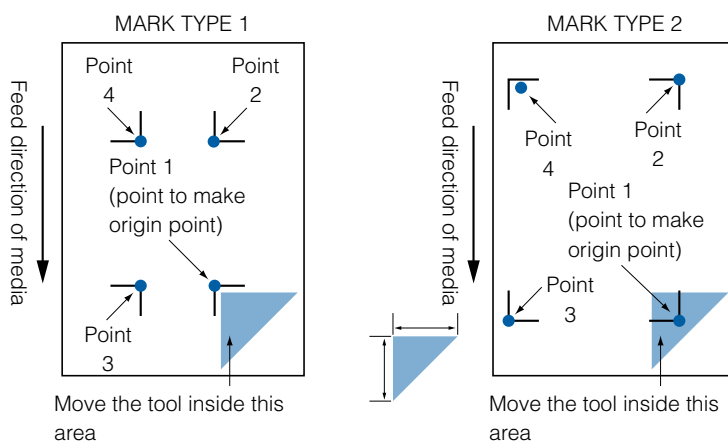

- 3 Confirm the position of the tool, and if it is OK, press the [ENTER] key.

▶ Registration marks are scanned. Following message is displayed when completed.

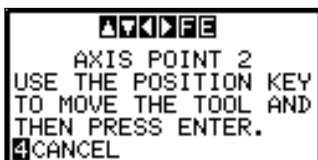

#### Supplement

See "Automatically Adjust" [P.5-34](#) if you are moving automatically to registration mark for scanning.

#### Supplement

Press the [2] key (ARMS) in the MENU screen if it is not ARMS setting screen.

#### Supplement

Left figure is for 4POINTS. Size and position of the registration scan start area is same for 2POINTS or 3POINTS.

#### Supplement

It will return to ARMS setting screen (1/4) without scanning when you press the [4] key (CANCEL).

**4** Press the **POSITION** (**▲▼◀▶**) key and move the tool carriage to the next area to start scanning of the registration mark.

Registration mark scan area

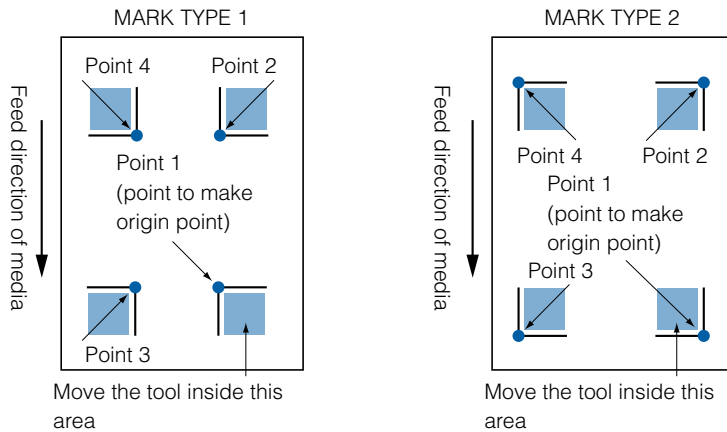

### Supplement

Left figure is for 4POINTS. Size and position of the registration scan start area is same for 2POINTS or 3POINTS.

**5** Confirm the position of the tool, and if it is OK, press the **[ENTER]** key.

- ▶ Registration marks are scanned. A message to move to next registration mark position is displayed once the scanning is completed. Repeat steps 4 and 5 following the message in that case.
- ▶ DISTANCE entry screen is displayed once the registration mark is scanned.

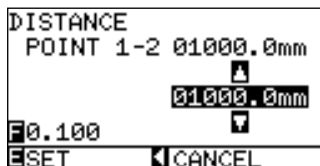

### Supplement

- Repeat steps 4 and 5 if a message prompting to move to next registration mark is displayed.
- Numbers to repeat steps 4 and 5 depends on the number of the registration marks to be scanned. Follow the instruction displayed on the screen.
- It will scan and return to ARMS setting screen (1/4) when the [4] key is pressed.

**6** Press the **POSITION** (**▲▼**) key and increase or decrease the setting value.

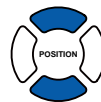

### Supplement

- Measured distance is displayed in the top line in the DISTANCE input screen. Input value (initially same as measured value) is displayed under that.
- If the input value is not changed, it will assume that there is no difference between measured distance and the distance in the data.
- Digits of settings can be changed by pressing the [FAST] key.

**7** Confirm the setting and press the **[ENTER]** key (SET).

- ▶ Adjustment by scanning the registration mark is completed, and it will return to default screen.

### Supplement

- It will return to default screen without changing the settings when you press the POSITION (**◀**) key (CANCEL).
- Distance input screen for point 3 is displayed if it is set to 3POINTS or more, so repeat steps 6 and 7 to set.

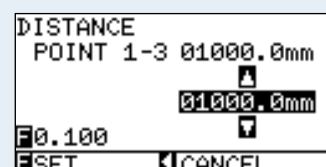



# Chapter 6: Manual Position Adjust

**This chapter describes the method to manually adjust the position of the media and tool, specify the position of the registration marks (adjustment marks), and adjust the tilting of the axes and distance.**

**It is possible to increase the precision when cutting outline of the image plotted by other plotter or need to cut the media again by this method, if the registration mark cannot be scanned by the ARMS.**



With manual position adjust, tilt of the axes are adjusted using the 2POINTS, 3POINTS, or 4POINTS adjustment marks (grits or registration marks) as a standard. The distance between each points can also be entered to adjust the distance.

Use magnifier or light pointer as a tool to match each points.

Use the media with prints (adjustment marks such as grits or registration marks) necessary to get XY axes and origin point.

### Setting of Mark Scan Mode and Number of Adjustment Marks

To perform the AXIS ALIGNMENT, set the MARK SCAN MODE to "AXIS ALIGNMENT".

Select the number of the registration marks (adjustment marks) from 2POINTS, 3POINTS, or 4POINTS when the MARK SCAN MODE is set to "AXIS ALIGNMENT". Position of each adjustment marks are as following.

2POINTS

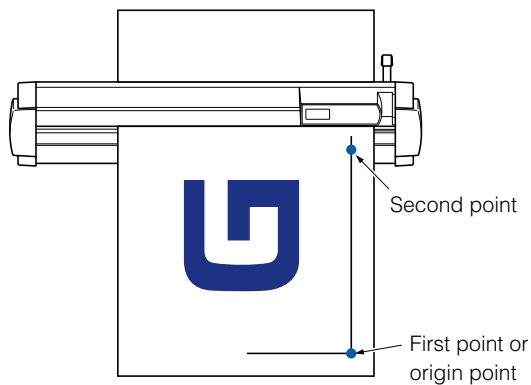

3POINTS

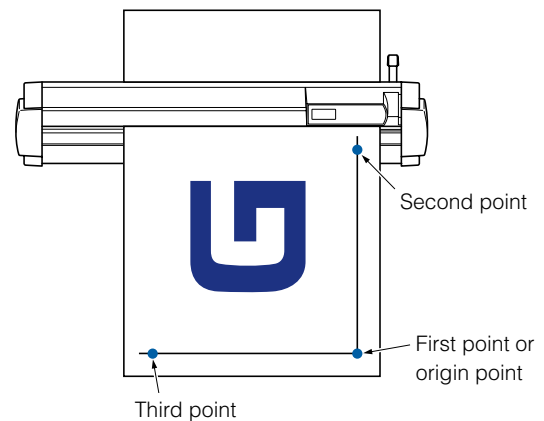

4POINTS

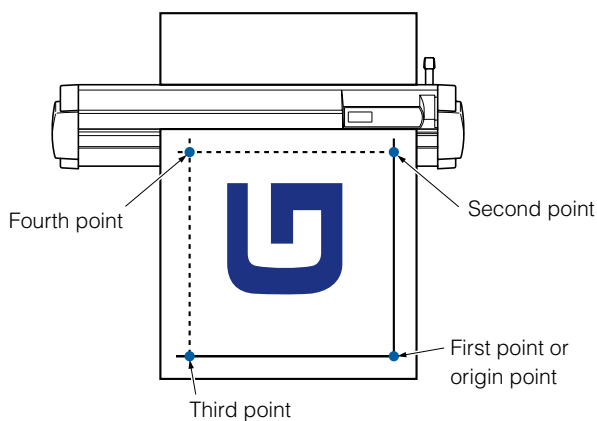

## Operation

See "Setting MARK SCAN Mode and Numbers"  for how to operate.

# 6-2 Manual Position Adjust

Method of manual position adjust is described here.

## Supplement

- Adjustment will be cleared if following is done after setting the adjustment.
  - Set new origin point.
  - Reload the media.
  - Set rotation or mirror. (Set the rotation or mirror prior to the axis adjustment)  
Axis adjustment will convert in accordance with rotation or mirror in this case.
- "AXIS SET ERROR! SET AGAIN" is displayed if the tilt of the axis at point 1 and point 2, point 1 and point 3, point 3 and point 4, or point 2 and point 4 is too large. Reload the media so it is not tilted as much, and redo the adjustment.
- Axis adjustment will be cleared when point 1 and point 2 is set to same point.

## Operation

1 Load the media with adjustment mark in the plotter.

 **P.2-6 Loading Media (Paper or Marking Film)**

2 To use the loupe for adjustment, set the loupe (optional) on the tool holder.

 **P.5-6 Setting MARK SCAN Mode and Numbers**

3 Set the paper-weight as needed.

 **P.7-21 Setting Paper-Weight**

4 Press the [MENU] key.

▶ MENU screen is displayed.



5 Press the [2] key (ARMS).

▶ ARMS SETTING screen (1/4) is displayed.

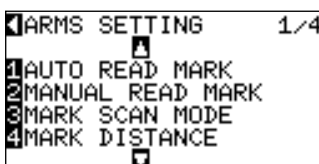

## Supplement

Confirm that the push roller is steadily on the media within the range of media movement. This adjustment is based on assumption that media is slightly tilted. Media might fall off if the tilting of the media is too large.

## Supplement

See "Attaching the Loupe"  **P.14-2** for attaching the magnifier.

Next page

6

Press the **POSITION (▲)** key.

▶ ARMS SETTING screen (4/4) is displayed.

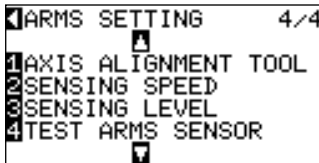

7

Press the **[1]** key (AXIS ALIGNMENT TOOL).

▶ AXIS ALIGNMENT TOOL selection screen is displayed.

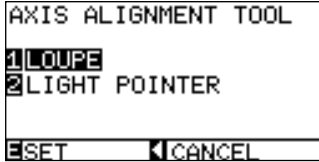

8

Press the **[1]** key (LOUPE) or the **[2]** key (LIGHT POINTER) depending on the tool set in step 2.

9

Confirm the setting and press the **[ENTER]** key (SET).

▶ Setting will be set, and it will return to ARMS setting screen (4/4).

10

Press the **POSITION (▼)** key.

▶ ARMS setting screen (1/4) is displayed.



11

Press the **[3]** key (MARK SCAN MODE).

▶ MARK SCAN MODE screen is displayed.

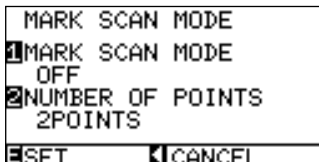

12

Press the **[1]** key (MARK SCAN MODE).

▶ MARK SCAN MODE setting screen is displayed.



13

Press the **[3]** key (AXIS ALIGNMENT).

▶ AXIS ALIGNMENT mode is selected and it will return to MARK SCAN MODE screen.

**Supplement**

It will return to MARK SCAN MODE screen without changing the settings when you press the POSITION (◀) key (PREVIOUS).

14

Press the [2] key (NUMBER OF POINTS).

▶NUMBER OF POINTS setting screen is displayed.

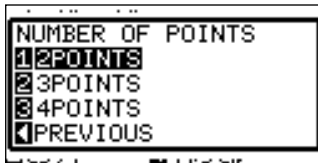

15

Press the [1] key (2POINT), the [2] key (3POINT), or the [3] key (4POINT).

▶POINTS is selected and it will return to MARK SCAN MODE screen.

### Supplement

It will return to MARK SCAN MODE screen without changing the settings when you press the POSITION (◀) key (CANCEL).

16

Confirm the setting and press the [ENTER] key (SET).

▶Setting will be set, and it will return to ARMS setting screen (1/4).

### Supplement

It will return to ARMS setting screen (1/4) without changing the settings when you press the POSITION (◀) key (CANCEL).

17

Press the [MENU] key.

▶ARMS SETTING screen (1/4) is displayed.

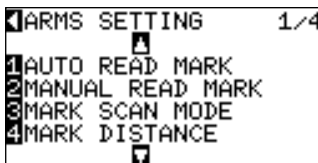

18

Press the [2] key (MANUAL READ MARKS).

▶Following message is displayed.



19

Press the POSITION (▲▼◀▶) key and move the tool to the position of the adjustment mark specified by the message.



### Supplement

Tool carriage will move faster when the [FAST] key is pressed simultaneously with the POSITION key.

20

Confirm the position of the tool, and if it is OK, press the [ENTER] key.

▶Once all the adjustment marks are specified, DISTANCE entry screen is displayed.

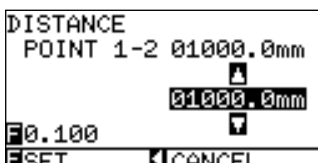

### Supplement

- Repeat steps 14 and 15 if following message prompting to move to the adjustment mark is displayed.
- Number to repeat steps 14 and 15 differs depending on the specified number of the adjustment marks. Follow the message that is displayed.
- It will return to ARMS setting screen (1/4) without scanning when the [4] key (CANCEL) is pressed.

Next page

21

Press the **POSITION** (▲▼) key to set the original distance on the data.

22

Confirm the setting and press the **[ENTER]** key (SET).

►It will return to default screen once all the distance is set.

### Supplement

- Measured distance is displayed in the top line in the DISTANCE input screen. Input value (initially same as measured value) is displayed under that.
- If the input value is not changed, it will assume that there is no difference between measured distance and the distance in the data.
- Digits of settings can be changed by pressing the [FAST] key.

### Supplement

- It will return to default screen without changing the settings when you press the POSITION (◀) key (PREVIOUS).
- DISTANCE input screen for point 3 is displayed if it is set to 3POINTS or more, so repeat steps 9 and 10 to set.

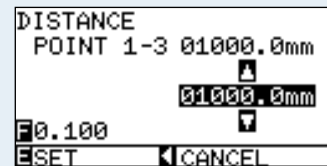

# Chapter 7: Setting Regarding Cutting Quality

**There are times that ideal cutting may not be possible, such as the lines may shift, corners deform, or uncut sections occur, due to the characteristics of the media (thickness, how hard it is, etc.) or the shape of the blades, when the actual cutting is done. Adjust the moving speed and force of the tool, and the control method to prevent these problems.**

**This chapter describes the setting regarding the quality of the cutting.**

# To cut the corner of thick media sharply

## Outline of Tangential Emulation

The blade needs to be facing toward the direction of cut when cutting the media. The tip of the blade is shaped as shown so the blade is facing the cutting direction even when it is cutting curved lines or corners. The tip of the blade is off from the rotation axis of the blade (CUTTER OFFSET). The blade will automatically turn and face the cutting direction when the tool carriage moves, because the blade is forced to move from the rotation center, and the blade tip gets resistance by the media.

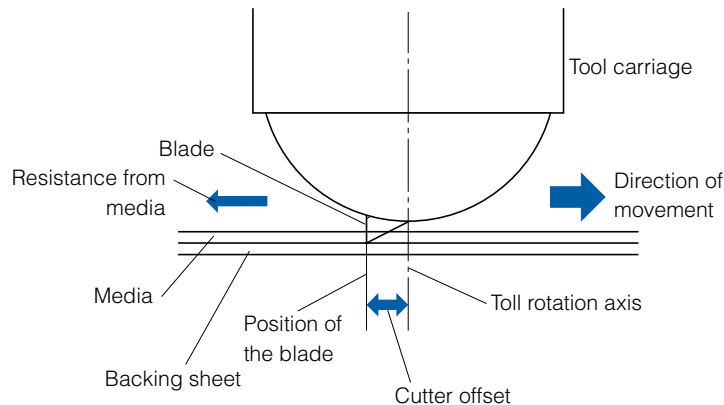

The blade tip gets sunk into the media with 0.3 mm or thicker, making the blade hard to rotate. Especially for the corners where two straight lines meet, cutting becomes very hard because it cannot rotate smoothly. Tangential emulation is a control method to precisely cut corners where two straight lines meet. (See below) With the tangential emulation, the blade is advanced so it will overcut at the corners before raising the tool. Then, it will be lowered at the position slightly before the next line, and start to cut with slight overcut.

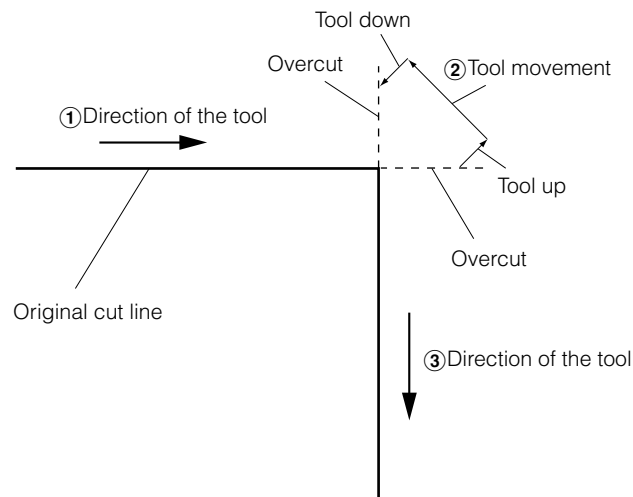

There are 2 modes for tangential emulation.

Mode 1: Overcuts the start and end points and acute-angle corners to eliminate uncut sections. In addition, the cutter blade is moved on the surface of the medium during cutting when it is rotated significantly, ensuring sharp cutting unaffected by the hardness or thickness of the media.

Mode 2: Overcuts the start and end points only. In addition, the cutter blade is rotated on the medium surface for the start cutting position only. Mode 2 uses simpler cutter control than Mode 1, and provides a shorter cutting time.

The length of the overcuts by tangential emulation can be set individually for start of the line and for end of the line.

# Setting the Tangential Emulation

On/off and the mode of the tangential emulation can be set individually for each of 1-8 tool control numbers.

## Operation

- 1 Press the **[CONDITION]** key.  
▶CONDITION setting screen (1/3) is displayed.

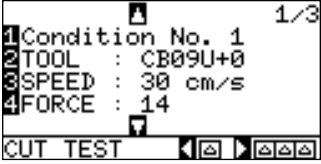

- 2 Press the **POSITION (▼)** key.  
▶CONDITION setting screen (2/3) is displayed.



- 3 Press the **[4]** key (TANGENT EMULATION).  
▶TANGENT EMULATION setting screen is displayed.

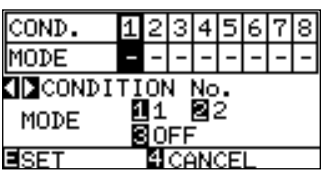

- 4 Press the **POSITION (◀▶)** key and select the CONDITION No.



- 5 Press the **[1]** key (MODE1), the **[2]** key (MODE2), or the **[3]** key (OFF) and select the mode.

- 6 Confirm the setting and press the **[ENTER]** key (SET).

▶Setting will be set, and it will return to CONDITION screen (2/3).

- 7 Press the **[CONDITION]** key.

▶It will return to default screen.

**Supplement**  
It will return to default screen without changing the settings when you press the [CONDITION] key.

**Supplement**  
It will return to CONDITION screen (2/3) without changing the settings when you press the [4] key (CANCEL).



# Setting Length of the Overcut

Set the length of overcut with tangential emulation.

## Operation

1 Press the [CONDITION] key.

►CONDITION setting screen (1/3) is displayed.

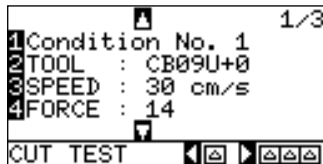

2 Press the POSITION (▲) key.

►CONDITION setting screen (3/3) is displayed.

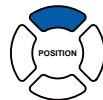
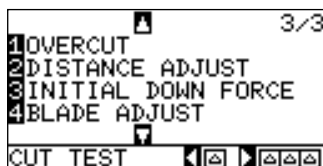

### Supplement

It will return to default screen without changing the settings when you press the [CONDITION] key.

3 Press the [1] key (OVERCUT).

►OVERCUT setting screen is displayed.

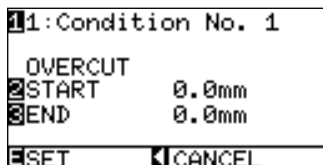

### Supplement

It will return to the CONDITION screen (3/3) without changing the settings when you press the POSITION (◀) key (CANCEL).

4 Press the [1] key (CONDITION No.).

►CONDITION No. selection screen is displayed.

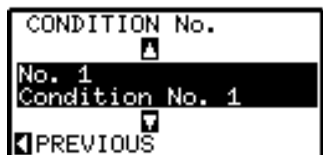

5 Press the POSITION (▲▼) key and select the CONDITION No.

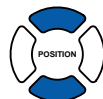

6 Confirm the setting, and press the POSITION (◀) key (PREVIOUS).

►CONDITION No. is selected and return to OVERCUT setting screen.

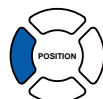

Next page

7

Press the **[2]** key (START).

▶ Overcut length for START setting screen is displayed.

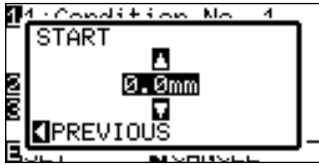

8

Press the **POSITION (▲▼)** key and increase or decrease the setting value.

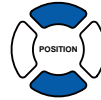

**Supplement**

Setting range is from 0.0 mm to 0.9 mm.

9

Confirm the setting value, and press the **POSITION (◀)** key (PREVIOUS).

▶ It will return to OVERCUT setting screen.

10

Press the **[3]** key (END).

▶ Overcut length for END setting screen is displayed.

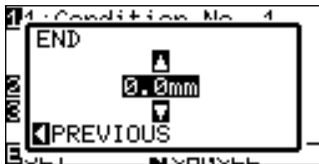

11

Press the **POSITION (▲▼)** key and increase or decrease the setting value.

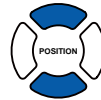

**Supplement**

Setting range is from 0.0 mm to 0.9 mm.

12

Confirm the setting value, and press the **POSITION (◀)** key (PREVIOUS).

▶ Length for overcut END is selected and return to OVERCUT setting screen.

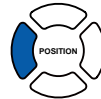

13

Repeat steps 3 to 12 as necessary to set multiple tool CONDITION No.

14

Confirm the setting and press the **[ENTER]** key (SET).

▶ Setting will be set, and it will return to CONDITION screen (3/3).

**Supplement**

It will return to CONDITION screen (3/3) without changing the settings when you press the POSITION (◀) key (CANCEL).

15

Press the **[CONDITION]** key.

▶ It will return to default screen.

## Setting of the Initial Down Force

The initial down-force setting is effective when tangential mode is selected.

Tangential control is generally used for the cutting of thick media. With thick film, additional time is required for the cutter blade to penetrate the media fully, even when the necessary cutting force is applied. The cutting operation starts before the cutter blade has fully penetrated the media, causing uncut sections to be left.

When the initial down force is specified, this force is used as the cutting force immediately after the lowering of the tool when tangential emulation is selected, enabling the cutter blade to penetrate the media rapidly. (As an example, if the cutting force is 25 and the initial down force is 4, for example, the cutting force applied immediately after the pen is lowered will be 29)

### Operation

1 Press the [CONDITION] key.

▶CONDITION setting screen (1/3) is displayed.

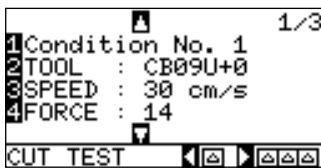

2 Press the POSITION (▲) key.

▶CONDITION setting screen (3/3) is displayed.

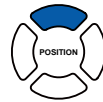
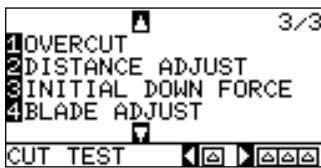

#### Supplement

It will return to default screen without changing the settings when you press the [CONDITION] key.

3 Press the [3] key (INITIAL DOWN FORCE).

▶INITIAL DOWN FORCE setting screen is displayed.



4 Press the POSITION (◀▶) key and select the CONDITION No.



5 Press the POSITION (▲▼) key and increase or decrease the setting value.



#### Supplement

Setting range is from 0 to 20.

6 Confirm the setting and press the [ENTER] key (SET).

▶Setting will be set, and it will return to CONDITION screen (3/3).

#### Supplement

It will return to CONDITION screen (3/3) without changing the settings when you press the [4] key (CANCEL).

7 Press the [CONDITION] key.

▶It will return to default screen.

# Setting the TOOL UP HEIGHT

Tip of the tool might touch the media when the blade is moved in normal tool up status when using a thick media such as sand blast rubber. TOOL UP HEIGHT is set to raise the tool higher than normal tool up status for these cases.

Leave the TOOL UP HEIGHT to default value (0) when using the media with normal thickness.

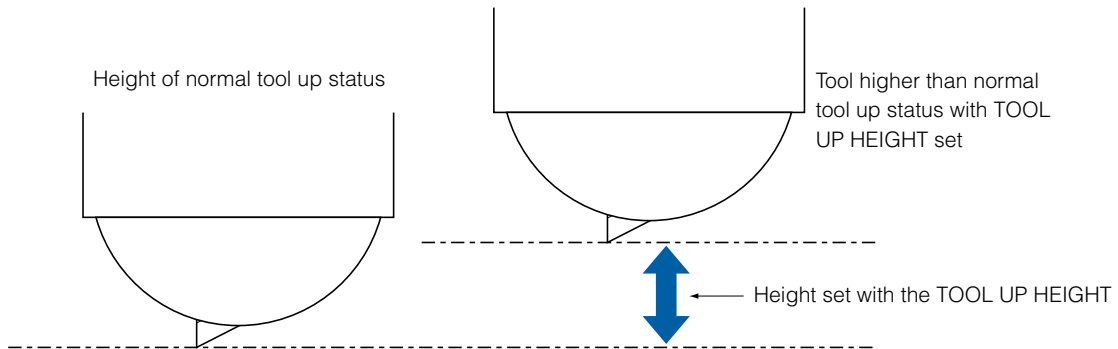

## Operation

- 1 Press the [MENU] key.  
 ► MENU screen is displayed.



- 2 Press the [1] key (TOOL).  
 ► TOOLS SETTING screen (1/3) is displayed.

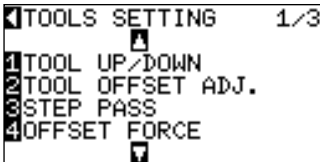

- 3 Press the POSITION (▲) key.  
 ► TOOLS SETTING screen (3/3) is displayed.

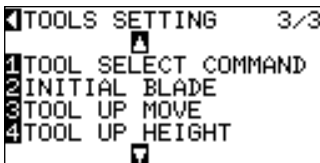
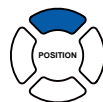

- 4 Press the [4] key (TOOL UP HEIGHT).  
 ► TOOL UP HEIGHT setting screen is displayed.

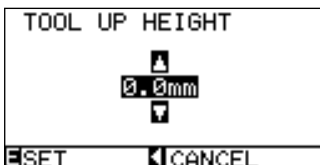

**Supplement**  
 It will return to TOOL setup screen (3/3) without changing the settings when you press the POSITION (◀) key (CANCEL).

**5** Press the **POSITION** (▲▼) key and increase or decrease the setting value.



**6** Confirm the setting and press **[ENTER]** key (SET).

▶ Setting will be set, and it will return to TOOLS SETTING screen (3/3).

**7** Press the **[MENU]** key.

▶ It will return to default screen.

#### **Supplement**

It will return to TOOLS SETTING screen (3/3) without changing the settings when you press the POSITION (◀) key (CANCEL).

# 7-2 Setting the Step Pass

It may not cut the curved line smoothly if there is very short lines in the curve.

It will cut in the units of the specified value when the STEP PASS is used, which allows to control the short lines with certain length, resulting to stable rotation of the blade for higher cut quality.

Setting range of STEP PASS is from 0 to 20.

Actual length of the STEP PASS is the value of the STEP PASS multiplied by the distance set in the "STEP SIZE".

## P.11-5 "Setting the Step Size (STEP SIZE)"

### Supplement

- STEP PASS setting is maintained even if the power is turned off.
- The cut image may not be what you intended if the set value is too large. It is recommended to set to "1" for normal use.

## Operation

1 Press the [MENU] key.

▶MENU screen is displayed.



2 Press the [1] key (TOOL).

▶TOOLS SETTING screen (1/3) is displayed.

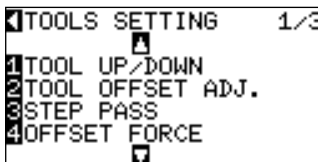

3 Press the [3] key (STEP PASS).

▶STEP PASS setting screen is displayed.

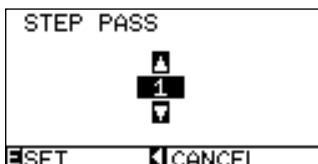

4 Press the **POSITION** (▲▼) key and increase or decrease the setting value.



### Supplement

Setting range is from 0 to 20.

 Next page

5

Confirm the setting and press the **[ENTER]** key (SET).

▶ Setting will be set, and it will return to TOOLS SETTING screen (1/3).

6

Press the **[MENU]** key.

▶ It will return to default screen.

#### **Supplement**

It will return to TOOLS SETTING screen (1/3) without changing the settings when you press the POSITION (◀) key (CANCEL).

# 7-3 Setting the Reference Angle

The FC8000 analyzes the cutting data, and controls the angle of the cutter blade tip if the change in the angles of the corner is large.

Angle control is applied if there is larger angle change than the angle specified as reference angle.

The time to cut is shortened by setting large value for the reference angle, since it will only apply blade control when there are angles with large angle change, hence reducing the time to make the blade control. But, if it is set too large, there will be not enough angle control of the blade, and the cut result may differ from what was expected. Set the reference angle in good balance.

## Supplement

This setting is maintained even if the power is turned off.

## Operation

1 Press the [MENU] key.

▶MENU screen is displayed.



2 Press the [1] key (TOOL).

▶TOOLS SETTING screen (1/3) is displayed.

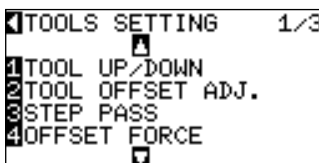

3 Press the **POSITION** (▼) key.

▶TOOLS SETTING screen (2/3) is displayed.

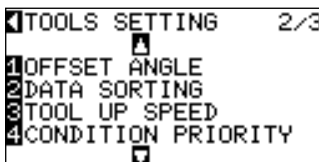

4 Press the [1] key (OFFSET ANGLE).

▶OFFSET ANGLE setting screen is displayed.

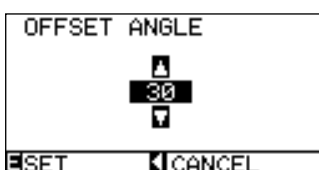

Next page



5

Press the **POSITION** (▲▼) key and increase or decrease the setting value.



6

Confirm the setting and press the **[ENTER]** key (SET).

▶ Setting will be set, and it will return to TOOLS SETTING screen (2/3).

7

Press the **[MENU]** key.

▶ It will return to default screen.

#### Supplement

Setting range is from 0 to 60.

#### Supplement

It will return to TOOLS SETTING screen (2/3) without changing the settings when you press the POSITION (◀) key (CANCEL).

# 7-4 Setting the Distance Adjust

**DISTANCE ADJUST** value corrects any deviation in the length of cut or plotted line segments, which occurs depending on the media being used. **DISTANCE ADJUST** value for the deviation is specified as a percentage of the total distance. For example, a setting of +0.05% adjusts a distance of 2 m (2,000 mm) by  $2,000 \times 0.05\% = 1$  mm, making 2,001 mm. **DISTANCE ADJUST** can be specified for each **CONDITION No.**

## Supplement

**DISTANCE ADJUST** setting is maintained even if the power is turned off.

## Operation

- 1 Press the **[CONDITION]** key.  
▶ **CONDITION** setting screen (1/3) is displayed.

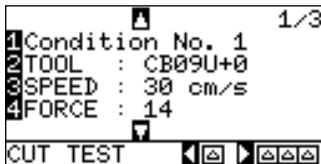

- 2 Press the **POSITION (▲)** key.  
▶ **CONDITION** setting screen (3/3) is displayed.

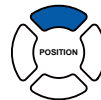
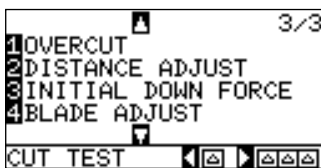

## Supplement

It will return to default screen without changing the settings when you press the **[CONDITION]** key.

- 3 Press the **[2]** key (**DISTANCE ADJUST**).  
▶ **DISTANCE ADJUST** setting screen is displayed.

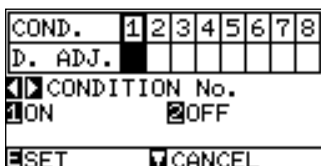

- 4 Press the **POSITION (◀▶)** key and select the **CONDITION No.**



- 5 Press the **[1]** key (**ON**).  
▶ **DISTANCE ADJUST** becomes on and **[3]** key (**X**) and **[4]** key (**Y**) becomes enabled.

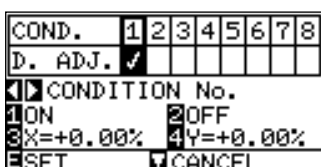

Next page

6

Press the [3] key (X).

▶ X DISTANCE ADJUST setting screen is displayed.

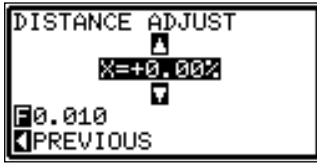

7

Press the **POSITION** (▲▼) key and increase or decrease the setting value.



**Supplement**

Setting range for adjustment value is -2.00% to +2.00%.

8

Confirm the setting value, and press the **POSITION** (◀) key (PREVIOUS).

▶ X DISTANCE ADJUST will be set, and it will return to DISTANCE ADJUST screen.

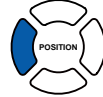

**Supplement**

Setting range for adjustment value is -2.00% to +2.00%.

9

Press the [4] key (Y).

▶ Y DISTANCE ADJUST setting screen is displayed.

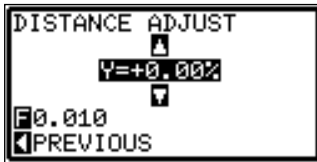

10

Press the **POSITION** (▲▼) key and increase or decrease the Y DISTANCE ADJUST value.



11

Confirm the setting value, and press the **POSITION** (◀) key (PREVIOUS).

▶ Y DISTANCE ADJUST will be set, and it will return to DISTANCE ADJUST screen.

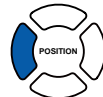

12

Confirm the setting and press the [ENTER] key (SET).

▶ Setting will be set, and it will return to CONDITION screen (3/3).

**Supplement**

It will return to CONDITION screen (3/3) without changing the settings when you press the POSITION (▼) key (CANCEL).

13

Press the [CONDITION] key.

▶ It will return to default screen.

# 7-5 Setting Cut Line Pattern

Lines can be cut with perforated lines so the cut parts will not fall off. There are 8 different patterns of perforated lines set as 0 to 7, and the ratio of cut and uncut part differs in each (tool is raised or the force is decreased for following length every 8 mm of the cut). The uncut part becomes shorter with smaller value, making it easier to separate the cut parts.

- Pattern 0: 0.15 mm ●Pattern 1: 0.20 mm ●Pattern 2: 0.25 mm ●Pattern 3: 0.30 mm
- Pattern 4: 0.35 mm ●Pattern 5: 0.40 mm ●Pattern 6: 0.45 mm ●Pattern 7: 0.50 mm

In addition to above 8 patterns, there are "OFF", which cuts with solid line, and "USER", where user can specify an unique pattern. Processing of the uncut part of the perforated lines are set with settings in "UP MODE". CUT LINE PATTERN can be specified for each CONDITION No.

## Supplement

- Normally use it with default value OFF. It will cut with solid line.
- Use TOOL3 for the cut with perforated lines (other than OFF).
- Do not use TOOL1 for the cutting out with perforated lines, instead of normal film cut (half cutting), because it will affect normal cutting by making scratches on the cutting mat.
- Replacement of the cutting mat will be with charge if it is damaged by performing perforated cut using the TOOL1.

## Operation

1 Press the [CONDITION] key.

▶CONDITION setting screen (1/3) is displayed.

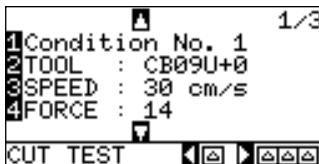

2 Press the POSITION (▼) key.

▶CONDITION screen (2/3) is displayed.



## Supplement

It will return to default screen without changing the settings when you press the [CONDITION] key.

3 Press the [2] key (CUT LINE PATTERN).

▶CUT LINE PATTERN setting screen is displayed.

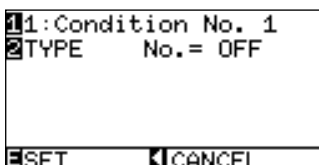

Next page

4

Press the [1] key.

▶CONDITION No. selection screen is displayed.

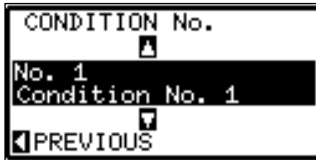

5

Press the **POSITION** (▲▼) key and select the CONDITION No.

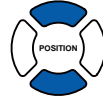

6

Confirm the setting value, and press the **POSITION** (◀) key (PREVIOUS).

▶CONDITION No. is selected and return to CUT LINE PATTERN setting screen.

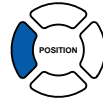

7

Press the [2] key (TYPE No.).

▶TYPE No. setting screen is displayed.



8

Press the **POSITION** (▲▼) key and select the TYPE No. .



9

Confirm the setting value, and press the **POSITION** (◀) key (PREVIOUS).

▶TYPE No. is selected and return to CUT LINE PATTERN setting screen.

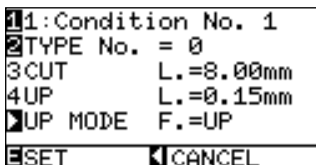
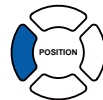

10

Press the **POSITION** (▶) key (UP MODE).

▶UP MODE setting screen is displayed.

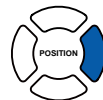

### Supplement

- CUT L and UP L is displayed when the TYPE No. 0-7 is selected. Also, you will be able to set the UP MODE.
- Setting for all becomes enabled when USER is selected.
- Nothing will be displayed when OFF is selected.

### Supplement

Setting range is from 1 to 48, and "UP".

11

Press the **POSITION** (**▲▼**) key and set the UP MODE.

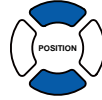

12

Confirm the setting, and press the **POSITION** (**◀**) key (PREVIOUS).

▶ It will return to UP MODE CUT LINE PATTERN setting screen.



13

If the "USER" is chosen in step 8, press the **[3]** key (CUT) and the **[4]** key (UP) to set the cut length and tool up length. Follow steps 10 to 12 for this operation.

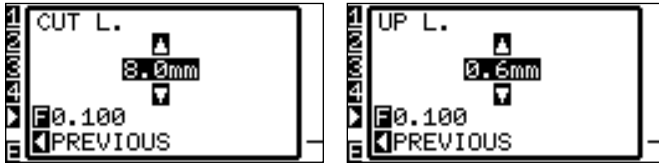

14

Confirm the setting and press the **[ENTER]** key (SET) in the CUT LINE PATTERN setting screen.

▶ Setting will be set, and it will return to CONDITION screen (2/3).

15

Press the **[CONDITION]** key.

▶ It will return to the default screen.

### Supplement

- Value set here will be the cut force for the uncut part of the perforated lines. Toll will be raised when set to "UP".
- Normally, input the smaller value than the FORCE for cutting to make it half cutting.

### Supplement

- If the TYPE No. 0-7 is selected in step 8, CUT L and UP L is only displayed, and not possible to change. Skip this step, and proceed.
- Range possible to set for the CUT L is 0.05 mm to 100.0 mm.
- Range possible to set for the UP L is 0.05 mm to 10.0 mm.
- Digits of settings can be changed by pressing the [FAST] key.

### Supplement

It will return to CONDITION screen (3/3) without changing the settings when you press the POSITION (**◀**) key (CANCEL).

# 7-6

## Setting Initial Blade Direction Adjust

The direction of blade is adjusted by making the blade touch the media right after the power is turned on, or after the pen condition is set. This is called the initial blade direction adjust. Since this action makes the blade touch the media, the position to perform the initial blade direction adjust is set to where it does not affect the actual cuttings.

Initial blade direction adjust is performed 2 mm below (2 mm toward the feed direction) of the start of the cut when "2mm BELOW" is selected.

Initial blade direction adjust is performed outside the cutting area when "OUTSIDE" is selected.

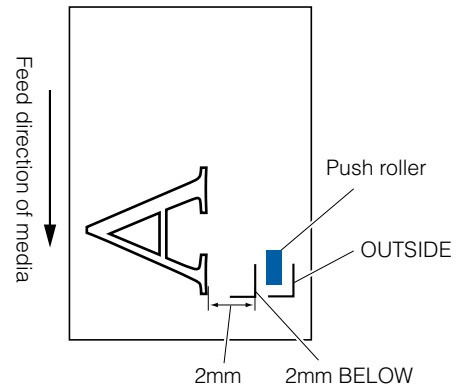
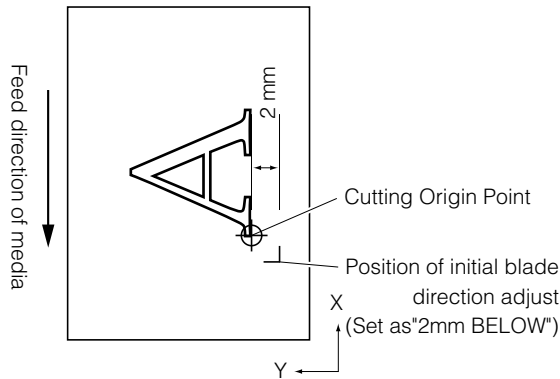

### Operation

1 Press the [MENU] key.

▶MENU screen is displayed.



2 Press the [1] key (TOOL).

▶TOOLS SETTING screen (1/3) is displayed.

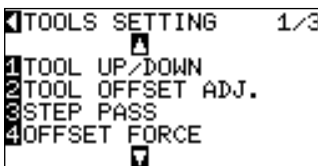

3 Press the POSITION (▲) key.

▶TOOLS SETTING screen (3/3) is displayed.

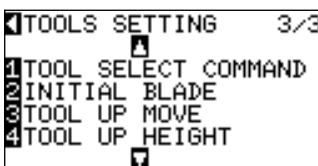

Next page

4

Press the [2] key (INITIAL BLADE).

▶ INITIAL BLADE setting screen is displayed.



5

Press the [1] key (OUTSIDE) or the [2] key (2mm BELOW).

6

Confirm the setting and press the [ENTER] key (SET).

▶ Setting will be set, and it will return to TOOLS SETTING screen (3/3).

7

Press the [MENU] key.

▶ It will return to default screen.

#### Supplement

It will return to TOOLS SETTING screen (3/3) without changing the settings when you press the POSITION (◀) key (CANCEL).



Slight cut operation is performed before the actual cut operation to align the blade toward the cutting direction. Lower FORCE is necessary compared with the normal cutting, so it is possible to set lower FORCE as an OFFSET FORCE.

OFFSET FORCE is used to control the rotation of the blade with the tangential emulation in addition to control the blade direction at the beginning of the cut.

## Operation

- 1 Press the [MENU] key.  
▶ TOOL setting screen (1/3) is displayed.



- 2 Press the [1] key (TOOL).  
▶ TOOLS SETTING screen (1/3) is displayed.

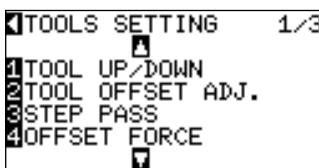

- 3 Press the [4] key (OFFSET FORCE).  
▶ OFFSET FORCE setting screen is displayed.



- 4 Press the POSITION (▲▼) key and increase or decrease the setting value.



- 5 Confirm the setting and press the [ENTER] key (SET).  
▶ Setting will be set, and it will return to TOOLS SETTING screen (1/3).

- 6 Press the [MENU] key.  
▶ It will return to default screen.

### Supplement

It will return to TOOLS SETTING screen (1/3) without changing the settings when you press the POSITION (◀) key (CANCEL).

### Supplement

OFFSET FORCE can be set between 1 and 40.

### Supplement

It will return to TOOLS SETTING screen (1/3) without changing the settings when you press the POSITION (◀) key (CANCEL).

# 7-8 Setting Paper-Weight

Hold the media down against the cutting surface by turning on the PAPER-WEIGHT to prevent decrease of the quality by the media rising up during scanning of the registration marks.

Turn it off when you need to prevent the smudging of the ink by the PAPER-WEIGHT.

Paper-weight is located under the tool carriage. (It cannot be seen from outside)

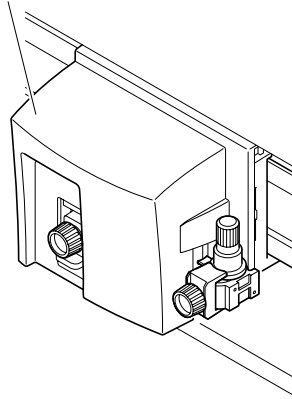

## Supplement

- The registration mark may not be scanned correctly if the paper-weight is set to OFF.
- Periodically clean the paper-weight using cotton swab or similar. It may smudge the media if it is dirty.

## Operation

1 Press the **[MENU]** key.

▶ MENU screen is displayed.



2 Press the **[2]** key (ARMS).

▶ ARMS SETTING screen (1/4) is displayed.

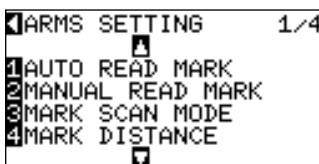

3 Press the **POSITION (▼)** key twice.

▶ ARMS SETTING screen (3/4) is displayed.

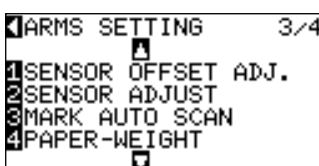

Next page

4

Press the **[4]** key (PAPER-WEIGHT).

▶ PAPER-WEIGHT setting screen is displayed.

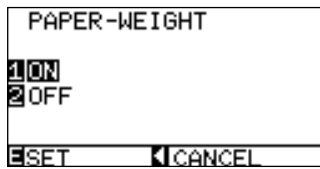

5

Press the **[1]** key (ON) or the **[2]** key (OFF),

6

Confirm the setting and press the **[ENTER]** key (SET).

▶ Setting will be set, and it will return to ARMS SETTING screen (3/4).

7

Press the **[MENU]** key.

▶ It will return to default screen.

#### Supplement

It will return to ARMS SETTING screen (3/4) without changing the settings when you press the POSITION (◀) key (CANCEL).

# Chapter 8: Settings Regarding Cutting Time

**Time necessary for cutting depends on the speed to move the tool and media, and efficiency of the operation.**

**It is best to cut slowly and carefully to cut precisely, but the speed is required to enhance the operational efficiency. The setting needs to be in good balance considering the characteristics of the media and tools, and the contents of the cutting data.**

**This chapter describes the settings affecting the cutting time.**

**In addition to this chapter, there are setting affecting the cutting times in following places.**

 **P.2-24 Selecting Tool Condition**

 **P.5-12 Setting Mark Distance**

Cutting efficiency is enhanced if the cutting data are sorted so it will combine the cutting to make the time needed to move the media and exchange the tool as less as possible.

There are 2 types of sorting, the area sort and the tool sort.

**Area sorting:** Data are sorted to optimize the movement of the media in the media feed direction. It will move to the various cutting positions with the tool raised, and it is most effective with the cutting data that is going around.

**Tool sorting:** It is most effective for the data that has parts that need to be cut with the cutter and the part plotted by the pen alternately. It will sort the data to do the plotting with the tool set on the tool holder all together at the end so it will optimize the time needed to change the tools. It is valid only when set to 2-pen.

### Supplement

- Sorting will start the process after all the data are stored in the buffer memory, so it takes time to start the cutting.
- Sorting might not be effective for the data that is created efficiently.
- Process may be faster to turn off the sorting on the plotter, if the data is already sorted using the software on the PC.

## Operation

1 Press the [MENU] key.

▶MENU screen is displayed.



2 Press the [1] key (TOOL).

▶TOOLS SETTING screen (1/3) is displayed.

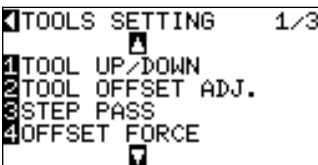

3 Press the POSITION (▼) key.

▶TOOLS SETTING screen (2/3) is displayed.

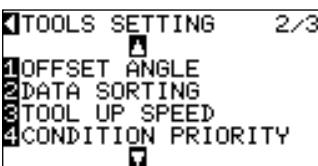

Next page

4

Press the [2] key (DATA SORTING).

▶ DATA SORTING setting screen is displayed.

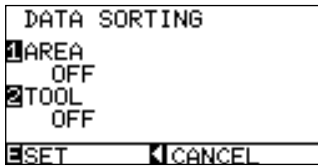

5

Press the [1] key (AREA).

▶ AREA SORTING setting screen is displayed.



6

Press the [1] key (ON) or the [2] key (OFF).

▶ AREA SORTING is selected and return to DATA SORTING screen.

7

Press the [2] key (TOOL).

▶ TOOL SORTING setting screen is displayed.



8

Press the [1] key (ON) or the [2] key (OFF).

▶ TOOL SORTING is selected and return to DATA SORTING screen.

9

Confirm the setting and press the [ENTER] key (SET).

▶ Setting will be set, and it will return to TOOLS SETTING screen (2/3).

10

Press the [MENU] key.

▶ It will return to default screen.

### Supplement

It will return to TOOLS SETTING screen (2/3) without changing the settings when you press the POSITION (◀) key (PREVIOUS).

### Supplement

[S] mark is displayed at the right of the screen when SORT MODE is set. See "How to Use Control Panel" (P.2-17).

# Perform Automatic Pre Feed When Cut Data is Received

It is possible to feed and reverse the media automatically for specified amount when the plotter receives the cutting data.

"Pre feeding" to prevent the shifting of media can be done automatically. Also, the media will be unrolled from the roll before cutting when rolled media is to be used.

 P.2-23 "Pre Feed of Media (Paper or Marking Film)"

 P.8-6 "Perform Automatic Pre Feed When Media is Set (Initial Feed)"

 P.8-7 "Setting Feed Speed for Pre Feed"

## Supplement

- The setting for AUTO PRE FEED when cutting data is received is maintained even if the power is turned off.
- Setting of the AUTO PRE FEED length is not linked to the setting of the page length. Change the setting for the page length if the cutting area is to be long.

## Operation

1 Press the [MENU] key.

▶MENU screen is displayed.



2 Press the [4] key (MEDIA).

▶MEDIA SETTING screen (1/2) is displayed.

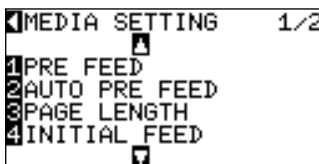

3 Press the [2] key (AUTO PRE FEED).

▶AUTO PRE FEED screen is displayed.

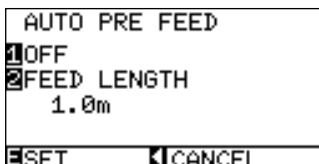

4 Press the [1] key.

▶AUTO PRE FEED setting screen is displayed.

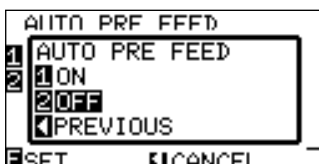

Next page

5

Press the [1] key (ON) or the [2] key (OFF).

▶AUTO PRE FEED is selected and return to AUTO PRE FEED screen.

6

Press the [2] key (FEED LENGTH).

▶FEED LENGTH setting screen is displayed.



7

Press the POSITION (▲▼) key and increase or decrease the setting value.

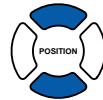

8

Confirm the setting value, and press the POSITION (◀) key (PREVIOUS).

▶FEED LENGTH is selected and return to AUTO PRE FEED screen.

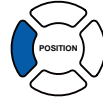

9

Confirm the setting and press the [ENTER] key.

▶Setting will be set, and it will return to MEDIA SETTING screen (1/2).

10

Press the [MENU] key.

▶It will return to default screen.

### Supplement

It will return to TOOL setting screen without changing the settings when you press the POSITION (◀) key (PREVIOUS). Digits of the setting can be changed by pressing the [FAST] key.

### Supplement

Feed length can be set in 0.1 m units. Setting range is 1.0 m to 50.0 m.

### Supplement

It will return to MEDIA SETTING screen (1/2) without changing the settings when you press the POSITION (◀) key (PREVIOUS).



### Supplement

[Pr] mark is displayed at the right of the screen when AUTO PRE FEED is set. See "How to Use Control Panel" [P.2-17](#).



# Perform Automatic Pre Feed When Media is Set (Initial Feed)

It can be set to automatically feed and return the length of the page when the media is loaded and the media set lever is raised. This is equal to automatically perform the "Pre Feed" to prevent the shifting of the media.

-  P.2-23 "Pre Feed of Media (Paper or Marking Film)"
-  P.8-4 "Perform Automatic Pre Feed When Cut Data is Received"
-  P.8-7 "Setting Feed Speed for Media Set"

## Supplement

Setting for the INITIAL FEED is maintained even if the power is turned off.

## Operation

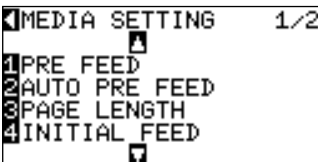
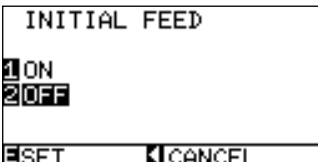
- 1 Press the [MENU] key.
  - ▶ MENU screen is displayed.
- 2 Press the [4] key (MEDIA).
  - ▶ MEDIA SETTING screen (1/2) is displayed.
- 3 Press the [4] key (INITIAL FEED).
  - ▶ INITIAL FEED screen is displayed.
- 4 Set the mode by pressing the [1] key (ON) or the [2] key (OFF).
- 5 Confirm the setting and press the [ENTER] key.
  - ▶ Setting will be set, and it will return to MEDIA SETTING screen (1/2).
- 6 Press the [MENU] key.
  - ▶ It will return to default screen.

## Supplement

It will return to MEDIA SETTING screen (1/2) without changing the settings when you press the POSITION (◀) key.

# 8-4 Setting Feed Speed for Pre Feed

Automatic pre feed when cut data is received and the speed of media for pre feed in initial feed are set here.

Set the feed speed to "SLOW" if the media shifts during the pre feed if the media is heavy or slippery. It is normally set to "NORMAL".

 "Pre Feed of Media (Paper or Marking Film)"

 "Perform Automatic Pre Feed When Media is Set (Initial Feed)"

 "Perform Automatic Pre Feed When Cut Data is Received"

## Supplement

Setting for the FEED SPEED for pre feed is maintained even if the power is turned off.

## Operation

1 Press the [MENU] key.

▶MENU screen is displayed.



2 Press the [4] key (MEDIA).

▶MEDIA SETTING screen (1/2) is displayed.

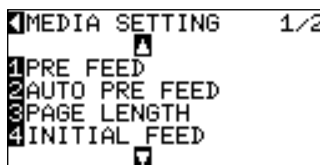

3 Press the POSITION (▼) key.

▶MEDIA SETTING screen (2/2) is displayed.

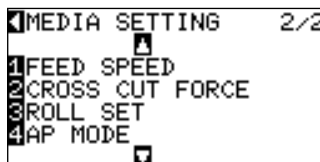

4 Press the [1] key (FEED SPEED).

▶FEED SPEED setting screen is displayed.

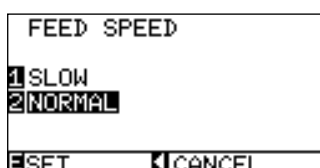

Next page

5

Press the **[1]** key (SLOW) or the **[2]** key (NORMAL).

6

Confirm the setting and press the **[ENTER]** key (SET).

▶ Setting will be set, and it will return to MEDIA SETTING screen (2/2).

7

Press the **[MENU]** key.

▶ It will return to default screen.

#### **Supplement**

It will return to MEDIA SETTING screen (2/2) without changing the settings when you press the POSITION (◀) key (CANCEL).

# 8-5 Setting the Tool Up Speed

**TOOL UP SPEED** is the speed the tool moves when it is raised.

The cutting time in total becomes short if you set the **TOOL UP SPEED** to fast speed even though the speed of the tool when it is cutting (lowered) is set to slow speed for the hard to cut media (hard or sticky).

## Supplement

Setting for the **TOOL UP SPEED** is maintained even if the power is turned off.

## Operation

1 Press the **[MENU]** key.

▶MENU screen is displayed.



2 Press the **[1]** key (TOOL).

▶TOOLS SETTING screen (1/3) is displayed.

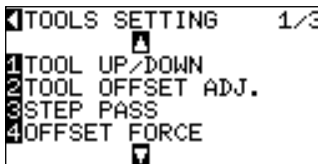

3 Press the **POSITION (▼)** key.

▶TOOLS SETTING screen (2/3) is displayed.

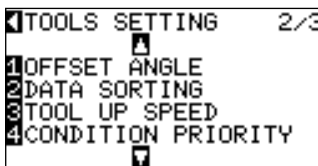

4 Press the **[3]** key (TOOL UP SPEED).

▶TOOL UP SPEED setting screen is displayed.



Next page

5

Press the **POSITION** (▲▼) key and increase or decrease the setting value.



6

Confirm the setting and press the **[ENTER]** key (SET).

▶ Setting will be set, and it will return to TOOLS SETTING screen (2/3).

7

Press the **[MENU]** key.

▶ It will return to default screen.

#### Supplement

- Values that can be set are AUTO, 10, 20, 30, 40, 50, and 60.
- It will be same speed as tool is lowered when AUTO is selected.

#### Supplement

It will return to TOOLS SETTING screen (2/3) without changing the settings when you press the POSITION (◀) key (CANCEL).

When the plotter receives a command to move the tool in the raised status to several coordinates from the control PC, "TOOL UP MOVE" setting decides either to move to each of the coordinates in order it receives, or directly to the last coordinate.

There are following 2 settings for "TOOL UP MOVE".

**ENABLED:** If several coordinates are received continuously, it will move to each in order it is received.

**DISABLED:** If several coordinates are received continuously, it will directly move to the last coordinate received.

Cutting time can be reduced if it is set to "DISABLED", if the time to move the tool in raised status is wasteful.

### Supplement

Setting for the TOOL UP MOVE is maintained even if the power is turned off.

## Operation

1 Press the [MENU] key.

▶ MENU screen is displayed.



2 Press the [1] key (TOOL).

▶ TOOLS SETTING screen (1/3) is displayed.

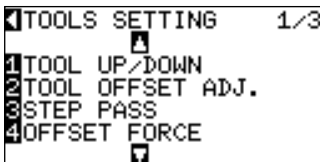

3 Press the POSITION (▲) key.

▶ TOOLS SETTING screen (3/3) is displayed.

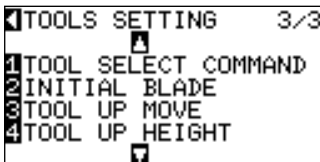
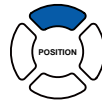

4 Press the [3] key (TOOL UP MOVE).

▶ TOOL UP MOVE setting screen is displayed.

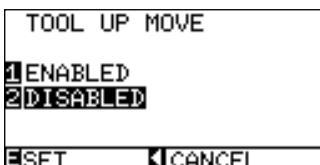

Next page

5

Press the **[1]** key (ENABLED) or the **[2]** key (DISABLED).

6

Confirm the setting and press the **[ENTER]** key (SET).

▶ Setting will be set, and it will return to TOOLS SETTING screen (3/3).

7

Press the **[MENU]** key.

▶ It will return to default screen.

#### **Supplement**

It will return to TOOLS SETTING screen (3/3) without changing the settings when you press the POSITION (◀) key (CANCEL).

# Chapter 9: Setting Regarding Interface

**This chapter describes setting regarding interface.**



This section describes how to set the interface.

The plotter has USB, network (LAN), and RS-232C interfaces, and these interfaces are switched automatically.

The network (LAN) interface is a factory-installed option. It cannot be retrofitted.

## USB Interface

To use the USB interface, a plotter driver must be installed in the computer. Please the Setup Manual to install the plotter driver.

The COMMAND mode and either the STEP SIZE parameter (when the COMMAND setting is GP-GL) or the ORIGIN parameter settings (when the COMMAND setting is HP-GL) are made at the plotter.

### CAUTION

Operation cannot be guaranteed in the following cases:

- When the plotter is connected to a USB hub or extension port.
- When the plotter is connected to a hand-built or modified computer.
- When a driver other than the one provided as a standard accessory is used.

Do not perform the followings:

- Do not connect or disconnect the USB cable while installing the USB driver on the computer.
- Do not connect or disconnect the USB cable when the computer or the plotter is performing an initialization routine.
- Do not disconnect the USB cable within a 5-second period of connecting it.
- Do not disconnect the USB cable within a 5-second period of connecting it.
- Do not connect multiple plotters to a single computer using the USB interface.

## Network (LAN) Interface



To use the network (LAN) interface, setting of the devices such as computer and network hub needs to be completed, and the computer is in the state ready to be connected to the network. Also, you need to either turn off or change the setting temporarily for the firewall function. If the firewall function is to be turned off, disconnect the network from the Internet.

### P.9-3 Connecting with network (LAN)

### CAUTION

- You will need a network (LAN) cables and network hub to connect via LAN. You will need to purchase them separately.
- Structures of the network equipment and necessity of the router function depends on the environment. For description, refer to the manual of the equipment, check with the manufacturer or the network administrator.
- Ethernet is compliant with 10BASE-T/100BASE-TX. Check your network environment.

## RS-232C Interface

To use the RS-232C interface, it is necessary to specify the COMMAND mode, either the STEP SIZE parameter (when the COMMAND setting is GP-GL) or the ORIGIN parameter (when the COMMAND setting is HP-GL), and the RS-232C interface conditions. You can specify the interface settings at the plotter's control panel. Set the interface conditions to the same settings on the software to be used and the plotter. If they are incorrectly set, the plotter may display an error message, fail to properly receive all of the data transmitted from the computer, or malfunction. In such cases, check your interface conditions once more. (See "Setting Origin Point When HP-GL is set"  P.3-9, "Setting the Step Size (STEP SIZE)"  P.11-5, and "Setting the Command (COMMAND)"  P.11-2.)

### P.9-6 Connecting with RS-232C

## Interface Setting Menu

Setting of the interface condition is only necessary when the plotter is connected using network (LAN) or RS-232C cables.

It is not necessary when the plotter is connected using the USB cable.

 **P9-3 Connecting with Network (LAN)**

 **P9-6 Connecting with RS-232C**

## Connecting with Network (LAN)

### Operation

1 Press the **[MENU]** key in the default screen.

▶MENU screen is displayed.



2 Press the **POSITION (▲)** key.

▶INTERFACE setting screen (1/3) is displayed.

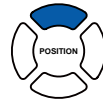
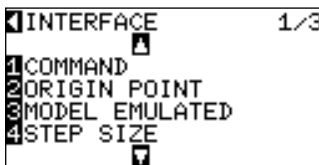

3 Press the **POSITION (▼)** key.

▶INTERFACE setting screen (2/3) is displayed.



#### Supplement

LAN setting is available only when the network (LAN) interface (factory-installed option) is installed.

4 Press the **[2]** key (LAN).

▶LAN setting screen is displayed.

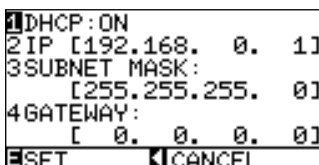

#### Supplement

● It will return to INTERFACE setting screen (2/3) without changing the settings when you press the POSITION (◀) key (CANCEL).

● MAC address is displayed when the POSITION (▶) key is pressed.

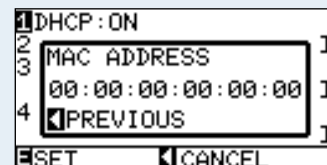

Next page

5

Press the [1] key (DHCP).

▶ DHCP setting screen is displayed.



\* What is displayed varies depending on the network environment.

6

Press the [1] key (on) or the [2] key (off).

7

Confirm the setting and press the [ENTER] key (SET).

▶ Setting will be set, and it will return to INTERFACE setting screen (2/3).

8

Press the [MENU] key.

▶ It will return to default screen.

### Supplement

- Setting of the DHCP depends on the structure of the network equipment and the environment. For description, refer to the manual of the equipment, check with the network administrator.
- It will return to LAN setting screen without changing the settings when you press the POSITION (◀) key (PREVIOUS).

### Supplement

- DHCP is set on in the initial setting.
- When the DHCP setting is set to [OFF], see "When DHCP Setting is Turned Off" [P.9-4](#).

## When DHCP Setting is Turned Off

Network is set manually.

### Operation

1

Press the [2] key (off) in the DHCP setting screen.

▶ LAN setting screen is displayed.

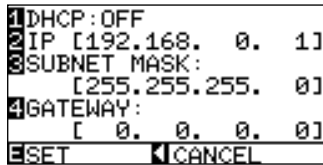

2

Press the [2] key (IP).

▶ IP ADDRESS setting screen is displayed.

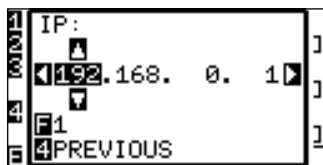

3

Press the POSITION (◀▶) key, and select the value to be set.



4

Press the POSITION (▲▼) key, and increase or decrease the values in the digits to be set.

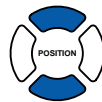

### Supplement

Digits of settings can be changed by pressing the [FAST] key.

Next page

5 Repeat steps 3 to 5 and select the 4 values to be set.

6 Confirm the setting and press the [4] key (PREVIOUS).

▶ IP ADDRESS will be set, and it will return to LAN setting screen.

7 Press the [3] key (SUBNET MASK).

▶ SUBNET MASK setting screen is displayed.



8 Press the **POSITION** (◀▶) key, and select the value to be set.

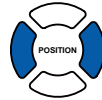

9 Press the **POSITION** (▲▼) key, and increase or decrease the values in the digits to be set.

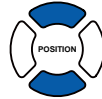

10 Repeat steps 8 to 9 and select the 4 values to be set.

11 Confirm the setting and press the [4] key (PREVIOUS).

▶ SUBNET MASK will be set, and it will return to LAN setting screen.

12 Press the [4] key (GATEWAY).

▶ GATEWAY setting screen is displayed.

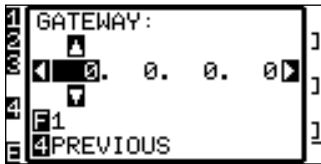

13 Press the **POSITION** (◀▶) key, and select the value to be set.

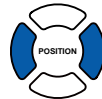

14 Press the **POSITION** (▲▼) key, and increase or decrease the values in the digits to be set.



15 Repeat steps 13 to 14 and select the 4 values to be set.

16 Confirm the setting and press the [4] key (PREVIOUS).

▶ GATEWAY will be set, and it will return to LAN setting screen.

17 Confirm the setting and press the [ENTER] key (SET).

▶ Setting will be set, and it will return to INTERFACE setting screen (2/3).

### Supplement

Digits of settings can be changed by pressing the [FAST] key.

### Supplement

Digits of settings can be changed by pressing the [FAST] key.

### Supplement

Digits of settings can be changed by pressing the [FAST] key.

Next page

Press the [MENU] key.

► It will return to the default screen.

## Connecting with RS-232C

4 different settings for RS-232C can be set to 1-4, and any can be called out arbitrarily. See "Switching Setting Numbers" [P.9-6](#) to call out the settings to use, and see "Changing and Storing RS-232C Settings" [P.9-7](#) to change and save the settings.

### Switching Setting Numbers

#### Operation

1 Press the [MENU] key in the default screen.

► MENU screen is displayed.



2 Press the **POSITION** (▲) key (I/F).

► INTERFACE setting screen (1/3) is displayed.

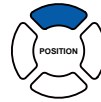
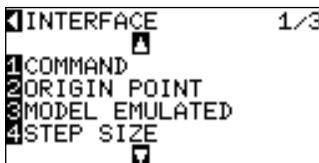

3 Press the **POSITION** (▼) key.

► INTERFACE setting screen (2/3) is displayed.



4 Press the [1] key (RS-232C).

► RS-232C setting screen is displayed.

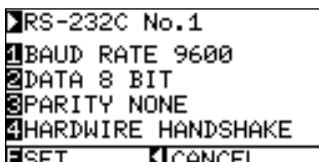

#### Supplement

It will return to INTERFACE setting screen (2/3) without changing the settings when you press the POSITION (◀) key (CANCEL).

5

Press the **POSITION (▶)** key (RS-232C).

▶RS-232C setting selection screen is displayed.

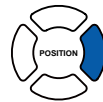

6

Press the **POSITION (▲▼)** key, and select the settings number.



7

Confirm the setting and press the **POSITION (◀)** key (PREVIOUS).

▶Setting will be set, and it will return to RS-232C setting screen (2/3).

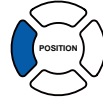

## Changing and Storing RS-232C Settings

### Operation

1

Press the **[MENU]** key in the default screen.

▶MENU screen is displayed.



2

Press the **POSITION (▲)** key (I/F).

▶INTERFACE setting screen (1/3) is displayed.

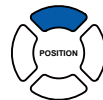
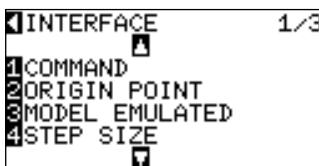

3

Press the **POSITION (▼)** key.

▶INTERFACE setting screen (2/3) is displayed.



Next page

4

Press the [1] key (RS-232C).

▶RS-232C setting screen is displayed.



5

Press the [1] key (BAUD RATE).

▶BAUD RATE setting screen is displayed.

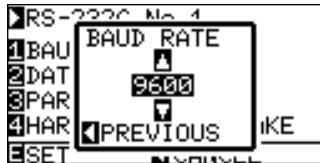

6

Press the **POSITION** (▲▼) key and increase or decrease the setting value.

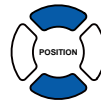

7

Confirm the setting and press the **POSITION** (◀) key (PREVIOUS).

▶BAUD RATE will be set, and it will return to RS-232C setting screen (2/3).

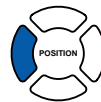

8

Press the [2] key (DATA BIT).

▶DATA BIT setting screen is displayed.

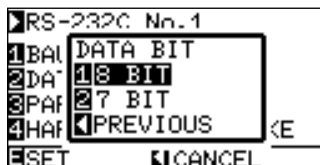

9

Press the [1] key (8 BIT) or the [2] key (7 BIT).

▶DATA will be set, and it will return to RS-232C setting screen (2/3).

10

Press the [3] key (PARITY).

▶PARITY setting screen is displayed.

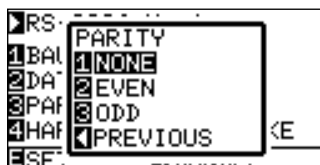

11

Press the [1] key (NONE), [2] key (EVEN), or the [3] key (ODD).

▶PARITY will be set, and it will return to RS-232C setting screen.

### Supplement

It will return to INTERFACE setting screen (2/3) without changing the settings when you press the **POSITION** (◀) key (CANCEL).

### Supplement

Match the setting value of the application to be used.

### Supplement

- Match the setting value of the application to be used.
- It will return to RS-232C setting screen without changing the settings when you press **POSITION** (◀) key (PREVIOUS).

### Supplement

- Match the setting value of the application to be used.
- It will return to RS-232C setting screen without changing the settings when you press **POSITION** (◀) key (PREVIOUS).

Next page

12

Press the [4] key (HANDSHAKE).

▶HANDSHAKE setting screen is displayed.



13

Press the [1] key (HARDWARE), the [2] key (Xon/off), or the [3] key (Enq/Ack).

▶HANDSHAKE will be selected, and it will return to RS-232C setting screen.

14

Confirm the setting and press the [ENTER] key (SET).

▶Setting will be set, and it will return to INTERFACE setting screen (2/3).

15

Press the [MENU] key.

▶It will return to default screen.

### Supplement

- Match the setting value of the application to be used.
- It will return to RS-232C setting screen when you press POSITION (◀) key (PREVIOUS).
- Enq/Ack setting is valid only when it is set to HP-GL. It will be set to HARDWARE even if Enq/Ack is selected when it is set to GP-GL.





# Chapter 10: Settings Regarding Operation Environment

**This chapter describes setting regarding the operation environment.**

### Display Language Setting (LANGUAGE SELECTION)

This function sets the language used on the display.

One of seven languages can be selected: English, Japanese, German, French, Italian, Spanish, or Portuguese.

#### Operation

1 Press the **[MENU]** key in the default screen.

▶MENU screen is displayed.



2 Press the **POSITION (▼)** key (ADV.).

▶ADVANCE setting screen (1/3) is displayed.

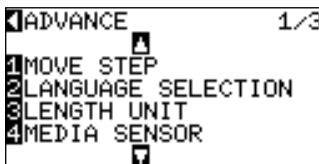

3 Press the **[2]** key (LANGUAGE SELECTION).

▶LANGUAGE SELECTION screen is displayed.



4 Press the **POSITION (▲▼)** key and select the language.

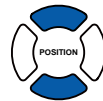

5 Confirm the setting and press the **[ENTER]** key (SET).

▶Setting will be set, and it will return to ADVANCE setting screen (1/3).

6 Press the **[MENU]** key.

▶It will return to the default screen.

## Setting the Display Length Unit (LENGTH UNIT)

This function enables you to set the unit for coordinates appearing on the display panel to either millimeter or inch units.

### Operation

1 Press the **[MENU]** key in the default screen.

▶MENU screen is displayed.



2 Press the **POSITION (▼)** key (ADV.).

▶ADVANCE setting screen (1/3) is displayed.

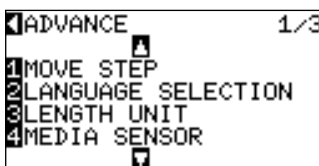

3 Press the **[3]** key (LENGTH UNIT).

▶LENGTH UNIT setting screen is displayed.

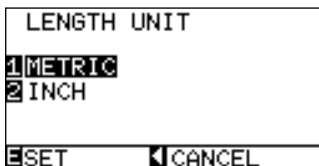

4 Press the **[1]** key (METRIC) or the **[2]** key (INCH).

5 Confirm the setting and press the **[ENTER]** key (SET).

▶Setting will be set, and it will return to ADVANCE setting screen (1/3).

6 Press the **[MENU]** key.

▶It will return to the default screen.

### Enabling/Disabling the Media Sensors (MEDIA SENSOR)

This function enables or disables the media sensors that detect the size of the medium in the feed direction.

#### Operation

1 Press the **[MENU]** key in the default screen.

▶MENU screen is displayed.



2 Press the **POSITION (▼)** key (ADV.).

▶ADVANCE setting screen (1/3) is displayed.

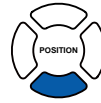

3 Press the **[4]** key (MEDIA SENSOR).

▶MEDIA SENSOR setting screen is displayed.

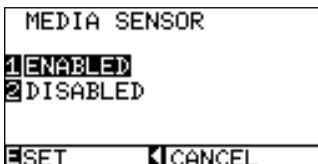

4 Press the **[2]** key (DISABLED) or the **[1]** key (ENABLED).

5 Confirm the setting and press the **[ENTER]** key (SET).

▶Setting will be set, and it will return to ADVANCE setting screen (1/3).

6 Press the **[MENU]** key.

▶It will return to the default screen.

#### Supplement

Cross cut will not be available when set to "DISABLED". Set the "AREA".

## Enabling/Disabling the Push Roller Sensors (PUSH ROLLER SENSOR)

This function enables or disables the push roller sensors that detect the width of the media.

### Operation

1 Press the **[MENU]** key in the default screen.

▶MENU screen is displayed.



2 Press the **POSITION (▼)** key (ADV.).

▶ADVANCE setting screen (1/3) is displayed.

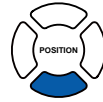

3 Press the **POSITION (▼)** key.

▶ADVANCE setting screen (2/3) is displayed.

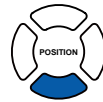
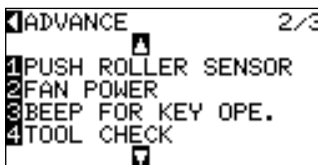

4 Press the **[1]** key (PUSH ROLLER SENSOR).

▶PUSH ROLLER SENSOR setting screen is displayed.

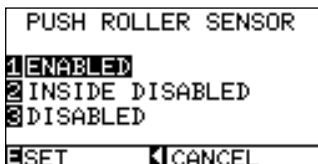

5 Press the **[1]** key (ENABLED), the **[2]** key (INSIDE DISABLED), or the **[3]** key (DISABLED).

6 Confirm the setting and press the **[ENTER]** key (SET).

▶Setting will be set, and it will return to ADVANCE setting screen (2/3).

7 Press the **[MENU]** key.

▶It will return to the default screen.

#### Supplement

All the sensors are disabled when DISABLED is selected. It will not generate error even if the inner push rollers are not on the grit rollers when the INSIDE DISABLED is selected.

#### Supplement

- Push roller sensor is used for the cross cut too, so it will not be able to cross cut when it is set to DISABLED.
- Position of the home sensor is not also detected, so there is a danger of clashing depending on the data. Use with "AREA" set.

### Fan Suction Setting (FAN POWER)

This function sets the suction force used to affix media to the plotter.  
It may not feed properly if the media is thin, so decrease the suction force.

#### Operation

1 Press the **[MENU]** key in the default screen.

▶MENU screen is displayed.



2 Press the **POSITION (▼)** key (ADV.).

▶ADVANCE setting screen (1/3) is displayed.



3 Press the **POSITION (▼)** key.

▶ADVANCE setting screen (2/3) is displayed.

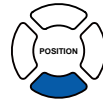
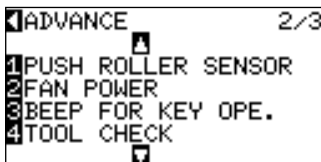

4 Press the **[2]** key (FAN POWER).

▶FAN POWER setting screen is displayed.



5 Press the **[2]** key (WEAK) or the **[1]** key (NORMAL).

6 Confirm the setting and press the **[ENTER]** key (SET).

▶Setting will be set, and it will return to ADVANCE setting screen (2/3).

7 Press the **[MENU]** key.

▶It will return to the default screen.

## Enabling/Disabling the Beep Setting (BEEP FOR KEY OPERATION)

This function selects whether to enable or disable the beep that is emitted whenever a control panel key is pressed.

### Operation

1 Press the **[MENU]** key in the default screen.

▶MENU screen is displayed.



2 Press the **POSITION (▼)** key (ADV.).

▶ADVANCE setting screen (1/3) is displayed.

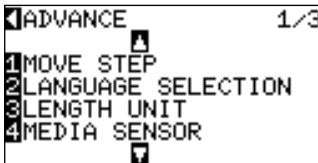

3 Press the **POSITION (▼)** key.

▶ADVANCE setting screen (2/3) is displayed.

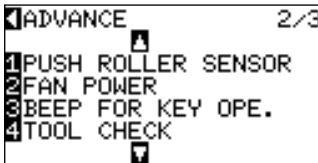

4 Press the **[3]** key (BEEP FOR KEY OPE.).

▶BEEP FOR KEY OPE. setting screen is displayed.



5 Press the **[1]** key (ON) or the **[2]** key (OFF).

6 Confirm the setting and press the **[ENTER]** key (SET).

▶Setting will be set, and it will return to ADVANCE setting screen (2/3).

7 Press the **[MENU]** key.

▶It will return to default screen.





# Chapter 11: Settings of Controls from Computer

**This chapter describes setting regarding the controls from the computer.**

## Related to Command Processing

### Setting the Command (COMMAND)

There are 2 types of commands, the GP-GL and the HP-GL, that the plotter can use. Match the setting to the used software, or set it to AUTO.

#### Supplement

- Automatic detection of the command may make mistake depending on the data. It will give error or malfunction when it has made mistake. In that case, set the command before using.
- Always send the data when the plotter is in READY status when in the automatic detection of the command.
- Once the data is cut with the automatic detection of the command, it will be ready to automatically detect next command 10 seconds after completing the cutting. Send next data after 10 seconds has past after previous cutting when sending data with different command.

### Operation

1 Press the **[MENU]** key in the default screen.

► MENU screen is displayed.



2 Press the **POSITION (▲)** key (I/F).

► INTERFACE setting screen (1/3) is displayed.

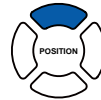
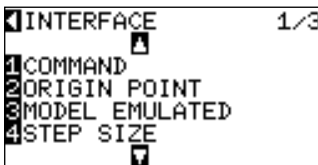

3 Press the **[1]** key (COMMAND).

► COMMAND setting screen is displayed.



4 Select the **[1]** key (GP-GL), the **[2]** key (HP-GL), or the **[3]** key (AUTO).

5 Confirm the setting and press the **[ENTER]** key (SET).

► Setting will be set, and it will return to INTERFACE setting screen (1/3).

6 Press the **[MENU]** key.

► It will return to the default screen.

## Priority of Tool Condition Selection (CONDITION PRIORITY)

Select the priority of the setting created by different method when the tool condition is set.

All the tool condition that is received from the computer will be ignored, and only the setting and change of the tool condition from the control panel is accepted when MANUAL is selected. This setting set here is maintained even if the power is turned off.

On the other hand, it will set the most current tool condition either from the control panel or from the software when PROGRAM is selected. The values set from the control panel is maintained, and the values set from the software is erased when the power is turned off.

### Operation

1 Press the **[MENU]** key in the default screen.

▶MENU screen is displayed.



2 Press the **[1]** key (TOOL).

▶TOOLS SETTING screen (1/3) is displayed.

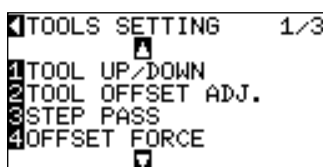

3 Press the **POSITION (▼)** key.

▶TOOLS SETTING screen (2/3) is displayed.

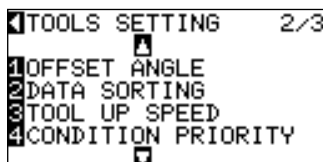

4 Press the **[4]** key (CONDITION PRIORITY).

▶CONDITION PRIORITY setting screen is displayed.

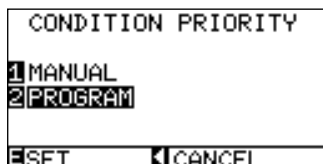

5 Press the **[1]** key (MANUAL) or the **[2]** key (PROGRAM).

6 Confirm the setting and press the **[ENTER]** key (SET).

▶Setting will be set, and it will return to TOOLS SETTING screen (2/3).

7 Press the **[MENU]** key.

▶It will return to default screen.

## Enabling/Disabling the Pen Select Command (PEN SELECT)

Setting for what to do when the pen select command ("J" in GP-GL, and "SP" in HP-GL) is received. It will ignore the pen select command when set to DISABLED.

### Operation

1 Press the **[MENU]** key in the default screen.

► MENU screen is displayed.



2 Press the **[1]** key (TOOL).

► TOOLS SETTING screen (1/3) is displayed.

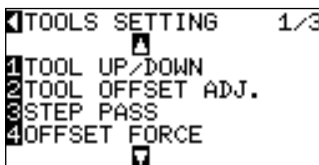

3 Press the **POSITION (▲)** key.

► TOOLS SETTING screen (3/3) is displayed.

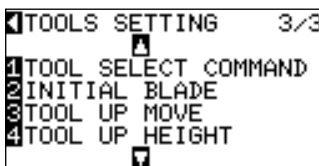

5 Press the **[1]** key (TOOL SELECT COMMAND).

► TOOL SELECT COMMAND setting screen is displayed.

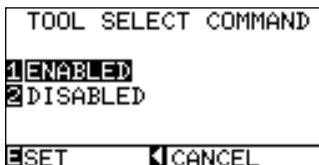

6 Press the **[1]** key (ENABLED) or the **[2]** key (DISABLED).

7 Confirm the setting and press the **[ENTER]** key (SET).

► Setting will be set, and it will return to TOOLS SETTING screen (3/3).

8 Press the **[MENU]** key.

► It will return to default screen.

#### Supplement

It will return to TOOLS SETTING screen (3/3) without changing the settings when you press the POSITION (◀) key (CANCEL).

## Related to GP-GL Command

This can be changed only when the GP-GL command is enabled in the COMMAND.

### Setting the Step Size (STEP SIZE)

The distance to travel with 1 step can be changed. Match the setting value of the application to be used.

#### Operation

1 Press the **[MENU]** key in the default screen.

▶MENU screen is displayed.



2 Press the **POSITION (▲)** key (I/F).

▶INTERFACE setting screen (1/3) is displayed.

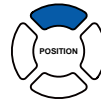

3 Press the **[4]** key (STEP SIZE).

▶GP-GL STEP SIZE setting screen is displayed.



4 Press the **[1]** key (0.100 mm), the **[2]** key (0.050 mm), the **[3]** key (0.025 mm), or the **[4]** key (0.010 mm).

5 Confirm the setting and press the **[ENTER]** key (SET).

▶Setting will be set, and it will return to INTERFACE setting screen (1/3).

6 Press the **[MENU]** key.

▶It will return to the default screen.

## Enabling/Disabling the ":" and ";" Commands (COMMAND ":";";")

If the first part of the data is lost when the GP-GL command is set, these commands may be having an adverse effect. In this case, set the ":" and ";" commands to DISABLED.

### Operation

1 Press the **[MENU]** key in the default screen.

▶MENU screen is displayed.



2 Press the **POSITION (▲)** key (I/F).

▶INTERFACE setting screen (1/3) is displayed.

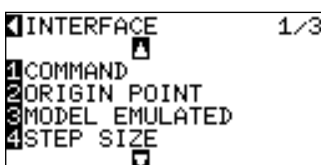

3 Press the **POSITION (▼)** key.

▶INTERFACE setting screen (2/3) is displayed.



4 Press the **[3]** key (COMMAND ":";";").

▶COMMAND ":";";" setting screen is displayed.



5 Press the **[1]** key (ENABLED) or the **[2]** key (DISABLED).

6 Confirm the setting and press the **[ENTER]** key (SET).

▶Setting will be set, and it will return to INTERFACE setting screen (2/3).

7 Press the **[MENU]** key.

▶It will return to the default screen.

## Moving the Pen While Raised or Lowered in Response to the "W" Command (COMMAND "W")

This function set the operation upon receipt of the "W" command for the drawing of arcs.

The pen will move to the specified starting position in the raised status when it is set to TOOL UP, regardless of the pen's conditions. The pen will move without changing its condition, to the specified starting position in the lowered status when it is set to TOOL DOWN.

### Operation

1 Press the **[MENU]** key in the default screen.

▶MENU screen is displayed.



2 Press the **POSITION (▲)** key (I/F).

▶INTERFACE setting screen (1/3) is displayed.

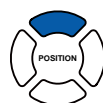
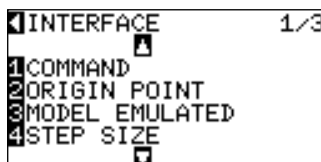

3 Press the **POSITION (▼)** key.

▶INTERFACE setting screen (2/3) is displayed.



4 Press the **[4]** key (COMMAND "W").

▶COMMAND "W" setting screen is displayed.

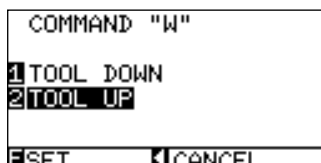

5 Press the **[1]** key (TOOL DOWN) or the **[2]** key (TOOL UP).

6 Confirm the setting and press the **[ENTER]** key (SET).

▶Setting will be set, and it will return to INTERFACE setting screen (2/3).

7 Press the **[MENU]** key.

▶It will return to the default screen.



## Related to HP-GL Command

These items are valid only when the HP-GL command is enabled in the COMMAND.

### Model ID Response (MODEL EMULATED)

This function set the operation upon receipt of the "OI" command requesting for the model ID. The reply will be 7550 when set to 7550, and 7586 when set to 7586.

#### Operation

1 Press the **[MENU]** key in the default screen.

▶MENU screen is displayed.



2 Press the **POSITION (▲)** key (I/F).

▶INTERFACE setting screen (1/3) is displayed.

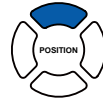

3 Press the **[3]** key (MODEL EMULATED).

▶HP-GL MODEL EMULATED setting screen is displayed.



4 Press the **[1]** key (7550) or the **[2]** key (7586).

5 Confirm the setting and press the **[ENTER]** key (SET).

▶Setting will be set, and it will return to INTERFACE setting screen (1/3).

6 Press the **[MENU]** key.

▶It will return to the default screen.

# Circle-Command Resolution Setting (CIRCLE RESOLUTION)

This function set the sets the resolution upon receipt of the circle-command for the pen plotter. Select either "AUTO" or "DEFAULT", which is 5 degrees.

## Operation

1 Press the [MENU] key in the default screen.

▶MENU screen is displayed.



2 Press the POSITION (▲) key (I/F).

▶INTERFACE setting screen (1/3) is displayed.

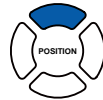
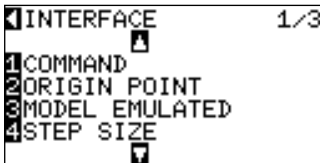

3 Press the POSITION (▲) key.

▶INTERFACE setting screen (3/3) is displayed.

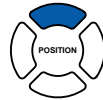
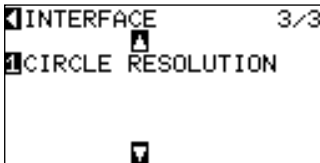

4 Press the [1] key (CIRCLE RESOLUTION).

▶CIRCLE RESOLUTION setting screen is displayed.

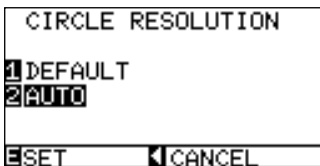

5 Press the [1] key (DEFAULT) or the [2] key (AUTO).

6 Confirm the setting and press the [ENTER] key (SET).

▶Setting will be set, and it will return to INTERFACE setting screen (1/3).

7 Press the [MENU] key.

▶It will return to default screen.



# Chapter 12: Maintenance

**This chapter describes the operation and information regarding maintenance.**

## Daily Maintenance

During the course of daily plotter operation, be sure to observe the following precautions:

- ① Never lubricate the mechanisms of the plotter.
  - ② Clean the plotter's casing using a dry cloth that has been moistened in a neutral detergent diluted with water. Never use thinner, benzene, alcohol, or similar solvents to clean the casings; they will damage the casing's finish.
  - ③ Clean the cutting mat using a dry cloth. In case of stubborn stains, use a cloth that has been moistened in alcohol or in a neutral detergent diluted with water.
  - ④ Clean the plotter's paper sensors using a cloth moistened in a neutral detergent diluted with water.
- \* Never use thinner, benzene, alcohol, or similar solvents to clean the sensors; cleaners such as these will damage the sensors.

## Storing the Plotter

When your plotter is not in use, be sure to observe the following points:

- ① Remove the tool attached to the tool holder.
- ② Cover the plotter with a cloth to protect it from dust and dirt.
- ③ Do not store the plotter in direct sunlight or in high temperatures.

Replace the cutter blade by referring to the structure diagram of the cutter pen.

## Supplement

See "Structure of Cutter Pen" [P2-2](#) for the structure of the cutter pen.

## Operation

- 1 Turn the blade-length adjustment knob in the direction indicated by the arrow to retract the blade into the plunger.

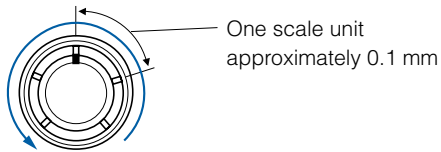

- 2 Turn the plunger cap in the counter-clockwise direction to remove it from the plunger.
- 3 Remove the blade from inside the plunger cap.
- 4 Remove a new blade from its pack. Insert the new blade into the hole provided in the plunger cap.
- 5 With the blade inserted into the plunger cap, screw on the plunger from above.

Replace the cross cut unit used to cut off the media after cutting.

### Supplement

Guideline for replacing cross cut unit.

- Paper back film: 1000 mm width media, about 3000 sheets (CT01H)
- Plastic back film: 1000 mm width media, about 3000 sheets (CT01H)

## Operation

- 1 Check that the power switch is turned off (the "O" side is pressed down).

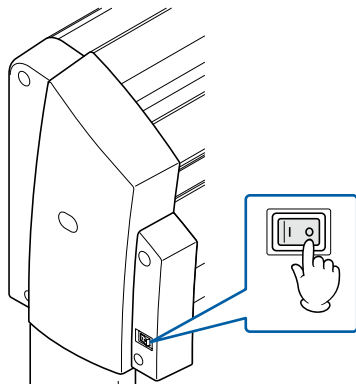

- 2 Remove the screw holding the cross cut unit in place, and then remove the cross cut unit.

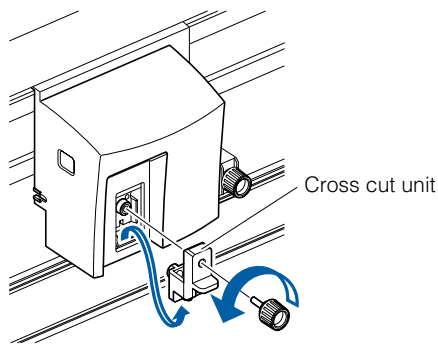

### CAUTION

The cross cut unit uses a very sharp blade. Take care not to cut yourself on the blade.

- 3 Remove the protective cover from the replacement cross cut unit. Be sure to remove the protective cover while holding the part of the unit shown in the figure below.

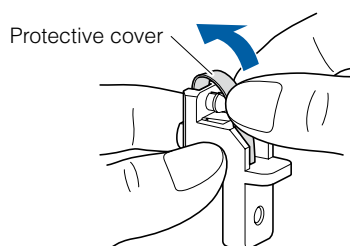

Next page

4

Attach the replacement cross cut unit, and tighten the screw to hold it in place.

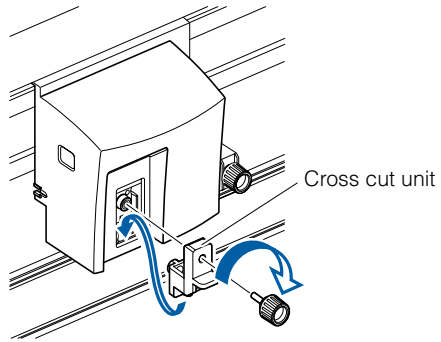

**CAUTION**

The cross cut unit uses a very sharp blade. Take care not to cut yourself on the blade.





# Chapter 13: Troubleshooting







**Refer to this chapter if you feel something is wrong, or it does not work right.**

**It also describes the settings of the plotter, confirming the cutting data, and method to create test patterns.**

### When the Plotter Does Not Operate After Turning the Power On

Symptom	Possible Cause	Solution
<ul style="list-style-type: none"> <li>•Both USER1 and USER2 lamp on the control panel does not light.</li> <li>•Nothing is displayed on the LCD panel.</li> </ul>	There is no power supplied. Or, the plotter is defective.	<p>Check that the power cord is securely connected to the plotter's AC line inlet and the electrical outlet.</p> <p>Check that the power is supplied to the electrical outlet.</p> <p>Contact your Graphtec call center if the problem still exists.</p>
<ul style="list-style-type: none"> <li>•USER1 or USER2 lamp light, but does not operate.</li> <li>•Nothing is displayed on the LCD panel.</li> </ul>	The plotter is defective.	Contact your Graphtec call center if the problem still exists.
<ul style="list-style-type: none"> <li>•USER1 or USER2 lamp light, but does not operate.</li> <li>•"Sum-Ck ROM RAM ERR!!" is displayed on the LCD panel.</li> </ul>	The ROM or RAM is defective.	Contact your Graphtec call center if the problem still exists.

## When It Does Not Work Right

Symptom	Possible Cause	Solution	Reference
Drops the media while detecting.	Bright light might be shining onto the media sensor.	Block the light if there is direct sunlight shining on the plotter that is placed near the window. Move away the fluorescent lamps if there is one close to the plotter.	
	Media sensor may be defective.	Contact your sales representative or the Graphtec call center. Set the media sensor to DISABLED to use the plotter temporarily.	 <a href="#">P.10-4</a> Enabling/Disabling the Media Sensors (MEDIA SENSOR)
Media wobbles.	Push rollers are not set correctly on the grit rollers.	Check the position of the push rollers.	 <a href="#">P.2-6</a> Loading Media (Paper or Marking Film)
One of the push roller goes off the media.	The leading edge or the trailing edge of the media is not cut straight against the media.	Cut the edge of the media straight.	
Tool carriage hits the left side of the plotter and "POSITION ALARM" is displayed after selecting the media type. Or, it hits the right side of the plotter and "POSITION ALARM" is displayed.	Push roller sensor may be defective if it hits the left side of the plotter. Home sensor may be defective if it hits the right side of the plotter.	Contact your sales representative or the Graphtec call center. Set the push roller sensor to DISABLED to use the plotter temporarily.	 <a href="#">P.10-4</a> Enabling/Disabling the Media Sensors (MEDIA SENSOR)
The plotter stops with "POSITION ALARM" displayed during initialization or cutting.	CONDITION setting for the media is invalid.	Slow down the speed or lower the FORCE.	 <a href="#">P.2-24</a> Setting Tool Condition
	The pen carriage does not move by hitting something.	Move the object disturbing the operation, and turn on the plotter after turning it off once.	
	External force is applied to the pen carriage while cutting.	Move the object disturbing the operation, and turn on the plotter after turning it off once.	
	Movement is disturbed by the media chaff in the operation area.	Move the object disturbing the operation, and turn on the plotter after turning it off once.	
	The plotter is defective.	Contact your sales representative or the Graphtec call center.	
It is cutting with origin point shifting to center of the media.	Data created with lower left origin point is received when the plotter is set with center origin point. (With HP-GL command)	Reset the origin point to center on the application software, or reset the origin point of the plotter to lower left.	 <a href="#">P.3-9</a> Setting Origin Point When HP-GL is Set
Media jumps out to forward side.	Selected wrong type of the media.	Check the type of media, "SHEET", "ROLL-1 REAR SET", or "ROLL-2 REAR SET".	 <a href="#">P.2-20</a> Setting Feeding Method



Symptom	Possible Cause	Solution	Reference
Displays command error.	Data sent to the plotter is not correct.	Check the data.	P.13-6 Error Message in GP-GL Command Mode P.13-7 Error Message in HP-GL Command Mode
It cannot cut above certain length.	Length of the cut is exceeding the length of the page set on the plotter.	Press the [ENTER] key and check the cutting area. Match the setting for the page length.	P.4-5 Setting Length of the Page
There are too many tool up and down.	Setting for the tangential emulation is set to ON.	Turn OFF the setting for the tangential emulation unless you are cutting thick media.	P.7-3 Setting the Tangential Emulation
It is cutting on the grit roller imprint.	Cutting width is widened.	Set the setting of the cutting width to 0.	P.4-4 Setting Cutting Width
Cannot change the tool condition.	Setting for the sorting is set to ON.	Normally, use the plotter with setting for the sorting OFF.	P.8-2 Sorting the Cutting Data
Tool condition changes.	Setting of the priority is set to PROGRAM.	Change the setting of the priority to MANUAL.	P.11-3 Priority of Tool Condition Selection (CONDITION PRIORITY)
	[ENTER] key is not pressed after changing the TOOL CONDITION.	Check the TOOL CONDITION again.	P.2-24 Setting the Tool Condition
Media travels tilted.	Media is loaded tilted.	Reload the media.	P.2-6 Loading Media (Paper or Marking Film)
	Media is slipping.	Perform pre feed once and make impression to make it harder to slip.	P.2-23 Pre Feed of Media (Paper or Marking Film)
It does not become specified length. (Slight distance error)	Media is slipping.	Make the speed slower. Increase the tool up speed. Perform feeding.	P.2-24 Setting the Tool Condition P.2-23 Loading Media (Paper or Marking Film) P.8-9 Setting the Tool Up Speed
	Distance adjust value is not correct.	Perform distance adjust.	P.7-13 Setting the Distance Adjust
"LOAD MEDIA!" is displayed even if the media is set and media set lever is moved up.	Media is close to transparent and media sensor makes false recognition. (This may happen depending on the media.)	Transparent media cannot be detected. DISABLE the media sensor and set the cut area when this kind of media is used.	P.10-4 Enabling/Disabling the Media Sensors (MEDIA SENSOR) P.4-2 Setting Cutting Area
	Media sensor malfunctions with strong scattered reflection.	Move the position of the light source. Make is so no direct sunlight shines.	
	There may be defective in the operation of the media set lever sensor.	Contact your sales representative or the Graphtec call center.	

## When the Cutting Result is Not Good

Symptom	Cause	Solution
<ul style="list-style-type: none"> <li>•Corners are rounded.</li> <li>•Corners are too sharp.</li> </ul>	Blade and OFFSET does not match.	Change the OFFSET. →It is rounded: Increase the OFFSET →It is too sharp: Decrease the OFFSET
<ul style="list-style-type: none"> <li>•The cut line starts out crooked.</li> </ul>	The blade mounted in the tool holder does not rotate smoothly.	Remove any foreign matter inside the holder.
	The CB09UA spring has come loose from the blade.	Replace the blade with a new one which has a spring.
<ul style="list-style-type: none"> <li>•The blade skips and does not completely cut lines that should be solid.</li> <li>•Straight cut lines seems to wobble.</li> </ul>	The blade is extended too far.	Adjust the blade length.
	The cutting speed is too high.	Lower the speed setting.
<ul style="list-style-type: none"> <li>•Coarse resolution of curved lines.</li> </ul>	The software's resolution setting is too low.	Adjust the software's resolution setting.
	The blade offset angle is too low.	Increase the value for the blade offset angle.
<ul style="list-style-type: none"> <li>•The media curls up at the corners.</li> <li>•Fine cut characters peels off.</li> </ul>	The blade is extended too far.	Adjust the blade length.
	Blade and OFFSET does not match.	Change the OFFSET.
	The cutting speed is too high.	Lower the speed setting.
	The blade is dull.	Replace the blade.
	The QUALITY setting is too high.	Lower the QUALITY setting.
<ul style="list-style-type: none"> <li>•The blade is cutting into the backing sheet.</li> </ul>	The blade is extended too far.	Adjust the blade length.
	The cutting FORCE is too high.	Lower the FORCE setting.
<ul style="list-style-type: none"> <li>•The blade falls out of the tool plunger.</li> </ul>	The blade is too small for the tool plunger.	Use a blade that fits securely in the tool plunger.
<ul style="list-style-type: none"> <li>•Media can be cut but it is hard to weed afterwards.</li> <li>•Cut media cannot be pulled up using retack sheet.</li> </ul>	The retack sheet is not sticky enough.	Switch to a stickier retack sheet.
	Media gets entangled during cutting.	Reduce the blade length. Lower the FORCE setting.
	Cleaning of cut media was postponed too long.	Promptly weed cut media.
<ul style="list-style-type: none"> <li>•Abnormal noise generated from the tool carriage during cutting.</li> <li>•The media is discolored where the blade has passed.</li> </ul>	Media is rubbed by the tip of the tool plunger.	Adjust the blade length and the cutting FORCE settings. .
<ul style="list-style-type: none"> <li>•The cutting results differ from the specified size.</li> </ul>	The STEP SIZE has been set differently at the computer and the plotter.	Set the STEP SIZE to same value.
	Scaling has been specified on the computer.	Check whether scaling has been specified.
<ul style="list-style-type: none"> <li>•Currently selected cutting conditions are disregarded or cannot be changed.</li> </ul>	The parameter priority setting is set to PROGRAM.	Change the setting of the priority to MANUAL.
	The [ENTER] key was not pressed after changing the settings.	Check the operation.
<ul style="list-style-type: none"> <li>•Characters or lines are deformed during pen plotting.</li> </ul>	The plotter is in cutting mode.	Select PEN as the tool in the CONDITION setting.
<ul style="list-style-type: none"> <li>•It does not become specified length. (Slight distance error)</li> </ul>	Distance adjust value is not correct.	Perform distance adjust.

Symptom	Cause	Solution
<ul style="list-style-type: none"> <li>•Characters are deformed.</li> <li>•Complex drawings are deformed.</li> </ul>	The STEP PASS setting is set too high.	Lower the STEP PASS setting.
<ul style="list-style-type: none"> <li>•The starting and end points of cutting do not match.</li> </ul>	Coordinate points are incorrectly specified.	Check the coordinate data by plotting it with a pen.
	The media backing is too flimsy.	Switch to a media with a stronger backing.
	Blade rotation is not smooth.	Check that there is no dirt in the blade.

## Error Messages in GP-GL Command Mode

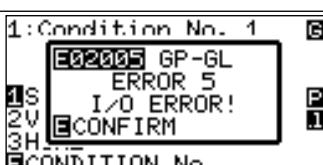
Error Displayed	LCD Display	Cause	Solution
E02001		The plotter received an unrecognizable command.	Press the [ENTER] key.
		<ul style="list-style-type: none"> <li>•Noise came in when the computer was turned on.</li> </ul>	Configure to drive the plotter from the menu of the software.
		<ul style="list-style-type: none"> <li>•The software configuration regarding the output device has been changed.</li> </ul>	Reset the interface settings of the software.
		<ul style="list-style-type: none"> <li>•The plotter's interface conditions have changed.</li> </ul>	Reset the interface settings of the plotter.
E02004		A command was received containing numeric parameters that exceed that command's permissible range.	Configure to drive the plotter from the menu of the software.
		<ul style="list-style-type: none"> <li>•The software configuration regarding the output device has been changed.</li> </ul>	Reset the interface settings of the software.
		<ul style="list-style-type: none"> <li>•The plotter's interface conditions have changed.</li> </ul>	Reset the interface settings of the plotter.
		<ul style="list-style-type: none"> <li>•The software configuration regarding the output device has been changed.</li> </ul>	Reset the interface settings of the software.
E02005		An error occurred in the receipt of data within the interface.	Configure to drive the plotter from the menu of the software.
		<ul style="list-style-type: none"> <li>•The software configuration regarding the output device has been changed.</li> </ul>	Reset the interface settings of the software.
		<ul style="list-style-type: none"> <li>•The plotter's interface conditions have changed.</li> </ul>	Reset the interface settings of the plotter.
		<ul style="list-style-type: none"> <li>•The software configuration regarding the output device has been changed.</li> </ul>	Reset the interface settings of the software.

## Error Messages in HP-GL Command Mode

If any of the following command errors occur, they are nearly always caused by following 2 reasons.

1. The configuration regarding the output device in the application software has changed.
2. The plotter's interface conditions have changed.

Perform following if these are the cause of the problem.

1. Reconfigure the output device of the application software to the plotter.
2. Reconfigure the plotter's interface conditions.

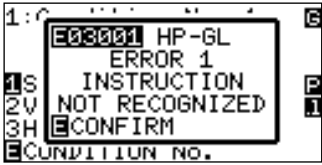
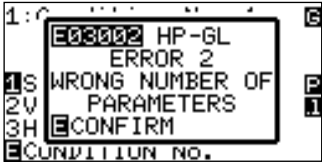
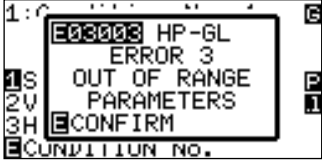
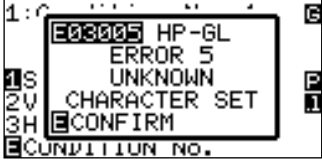
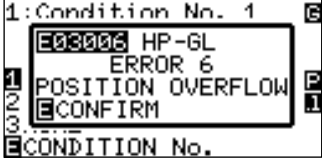
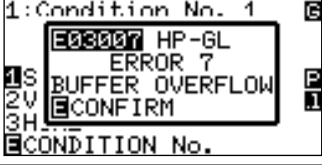
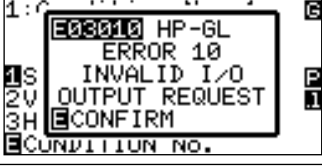
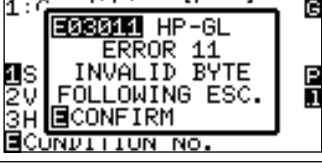
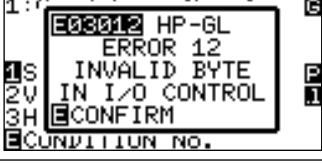



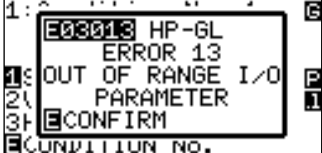
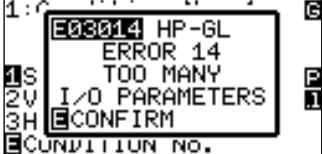
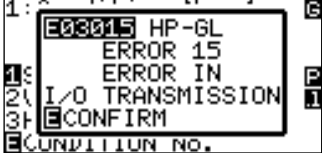
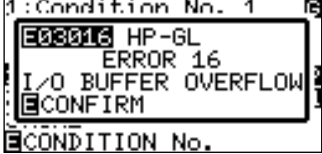



Error Displayed	LCD Display	Cause	Solution
E03001		An unrecognizable instruction was executed.	Execute a recognizable command.
E03002		Wrong number of parameters were specified.	Execute the command with the correct number of parameters.
E03003		An unusable parameter was executed.	Execute a recognizable parameter.
E03005		An unusable character set was specified.	Specify usable character set.
E03006		The data being input exceeds the capacity of the plotter's downloadable character buffer, polygon buffer, etc.	Execute coordinates within the cutting area.
E03007		Coordinates of command specified out of cutting area.	Adjust the buffer size.
E03010		Other output command was executed while executing an output command.	Check the program.
E03011		An invalid byte was received after ESC code.	Check the program.
E03012		Invalid byte was received within device control command.	Check the program.

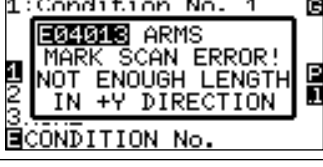

Error Displayed	LCD Display	Cause	Solution
E03013		A parameter outside of the permissible range was specified in the I/O related command.	Check the program.
E03014		Too many parameters in the I/O related command.	Check the program.
E03015		Framing error, parity error, or overrun error has occurred.	Set the RS-232C transmission condition.
E03016		Interface buffer memory has overflowed.	Set the RS-232C transmission condition.

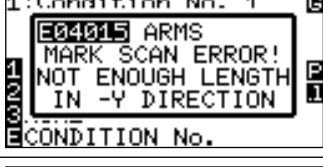

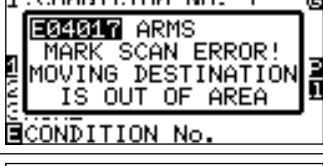

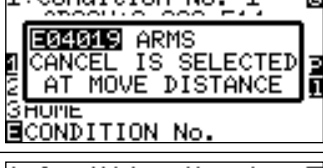
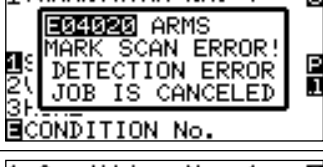
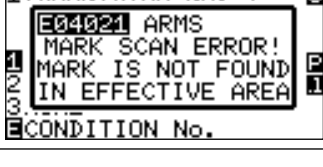





## Error Messages for ARMS







Symptom	LCD Display	Possible Cause	Solution
E04001	<pre> 1:Condition No. 1 CR0911+A S30 F14 E04001 ARMS 1S AXIS SET ERROR! 2V SET AGAIN 3HOME CONDITION No.                     </pre>	Tilt to adjust with AXIS ALIGNMENT is too large.	Reload the media.
E04002	<pre> 1:Condition No. 1 CR0911+A S30 F14 E04002 ARMS 1S ADJUSTMENT ERROR 2V DISTANCE 3H SET AGAIN! CONDITION No.                     </pre>	It is over the setting range of the distance adjust.	Reset to smaller value.
E04003	<pre> 1:Condition No. 1 CR0911+A S30 F14 E04003 ARMS 1S IT IS NOT POSSIBLE 2V TO ADJUST IT. 3HOME CONDITION No.                     </pre>	Failed to adjust the sensor level.	This media cannot be used.
E04004	<pre> 1:Condition No. 1 CR0911+A S30 F14 E04004 ARMS 1S DISTANCE 2V ADJUSTMENT ERROR 3H SET AGAIN! CONDITION No.                     </pre>	It is over the setting range of the distance adjust.	Reset to smaller value.
E04005	<pre> 1:Condition No. 1 CR0911+A S30 F14 E04005 ARMS 1S MARK SCAN ERROR! 2V 3HOME CONDITION No.                     </pre>	Could not scan the registration marks.	Check the registration scan position.
E04006	<pre> 1:Condition No. 1 CR0911+A S30 F14 E04006 ARMS 1S BUFFER OVERFLOW 2V 3HOME CONDITION No.                     </pre>	Amount of data has exceeded the I/O buffer size for the segment area registration mark.	Decrease the data.
E04007	<pre> 1:Condition No. 1 CR0911+A S30 F14 E04007 ARMS 1S ILLEGAL PLOT AREA 2V 3HOME CONDITION No.                     </pre>	Test pattern plotting position is not within the plotting area for sensor position adjustment.	Move the media toward center and plot the test pattern.
E04008	<pre> 1:Condition No. 1 CR0911+A S30 F14 E04008 ARMS 1S MARK SCAN ERROR! 2V MEDIA END DURING 3H MEDIA DETECTION CONDITION No.                     </pre>	Media end was detected while detecting the registration mark.	Check the media. Check the print position of the registration mark.
E04009	<pre> 1:Condition No. 1 CR0911+A S30 F14 E04009 ARMS 1S MARK SCAN ERROR! 2V NOT ENOUGH LENGTH 3H IN +X DIRECTION CONDITION No.                     </pre>	It has exceeded detection area while detecting the registration mark.	Check the media. Check the print position of the registration mark.
E04010	<pre> 1:Condition No. 1 CR0911+A S30 F14 E04010 ARMS 1S MARK SCAN ERROR! 2V EXCEED CUTTING 3H AREA DURING CONDITION No.                     </pre>	It has exceeded detection area while detecting the registration mark.	Check the media. Check the print position of the registration mark.

Symptom	LCD Display	Possible Cause	Solution
E04011		It has exceeded detection area while detecting the registration mark.	Check the media. Check the print position of the registration mark.
E04012		It has exceeded detection area while detecting the registration mark.	Check the media. Check the print position of the registration mark.
E04013		It has exceeded detection area while detecting the registration mark.	Check the media. Check the print position of the registration mark.
E04014		It has exceeded detection area while detecting the registration mark.	Check the media. Check the print position of the registration mark.
E04015		It has exceeded detection area while detecting the registration mark.	Check the media. Check the print position of the registration mark.
E04016		It has exceeded detection area while detecting the registration mark.	Check the media. Check the print position of the registration mark.
E04017		It has exceeded detection area while detecting the registration mark.	Check the media. Check the print position of the registration mark.
E04018		Media set lever was lowered.	Reload the media and try again.
E04019		There was cancel operation by the user.	Redo the process.
E04020		There is a defect in the detection settings value.	Check the settings value.
E04021		Registration mark was not detected in the auto detection area.	Check the media. Check the print position of the registration mark.

Symptom	LCD Display	Possible Cause	Solution
E04022	<p>1:Condition No. 1 CRA9114A S3A F14 E04022 ARMS JOB IS CANCELED HOME CONDITION No.</p>	There was cancel operation by the user.	Redo the process.
E04023	<p>1:Condition No. 1 CRA9114A S3A F14 E04023 ARMS MARK SCAN ERROR! MARK WAS NOT FOUND HOME CONDITION No.</p>	Registration mark was not detected.	Redo the sensor level adjustment. Change the color of the registration mark. Check the media. Check the print position of the registration mark.
E04024	<p>1:Condition No. 1 CRA9114A S3A F14 E04024 ARMS MARK SCAN ERROR! MARK SENSE LEVEL WAS NOT ENOUGH HOME CONDITION No.</p>	Registration mark was not detected.	Redo the sensor level adjustment. Change the color of the registration mark. Check the media. Check the print position of the registration mark.
E04025	<p>1:Condition No. 1 CRA9114A S3A F14 E04025 ARMS MARK SCAN ERROR! MARK WAS NOT FOUND IN HIGH SPEED MODE HOME CONDITION No.</p>	Registration mark was not detected.	Redo the sensor level adjustment. Change the color of the registration mark. Check the media. Check the print position of the registration mark.

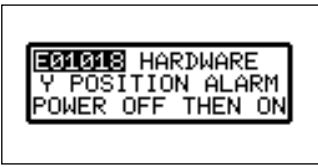
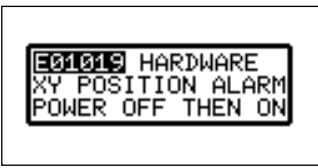
## Other Error Messages

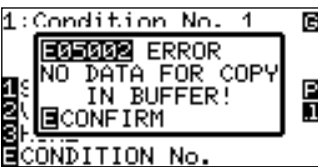
Symptom	LCD Display	Possible Cause	Solution
E01001~ E01005		The plotter is defective.	Contact your sales representative or the Graphtec call center.
E01006		The plotter is defective.	Contact your sales representative or the Graphtec call center.
E01007		The plotter is defective.	Contact your sales representative or the Graphtec call center.
E01008		The plotter is defective.	Contact your sales representative or the Graphtec call center.
E01009		The plotter is defective.	Contact your sales representative or the Graphtec call center.
E01010		The plotter is defective.	Contact your sales representative or the Graphtec call center.
E01011		The plotter is defective.	Contact your sales representative or the Graphtec call center.
E01012		The plotter is defective.	Contact your sales representative or the Graphtec call center.
E01013		The plotter is defective.	Contact your sales representative or the Graphtec call center.
E01014		The plotter is defective.	Contact your sales representative or the Graphtec call center.

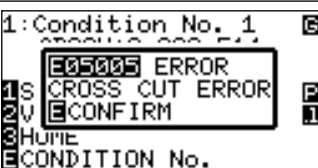
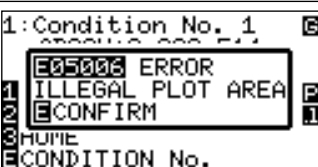
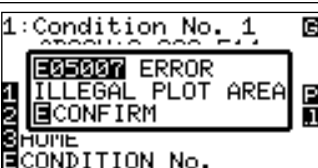
Symptom	LCD Display	Possible Cause	Solution
E01015		The plotter is defective.	Contact your sales representative or the Graphtec call center.
E01017		The plotter is defective. Load on the motor was too large.	Move the object disturbing the operation, and turn on the plotter after turning it off once. Do not use heavy media.
E01018		The plotter is defective. Load on the motor was too large.	Move the object disturbing the operation, and turn on the plotter after turning it off once. Do not use heavy media.
E01019		The plotter is defective. Load on the motor was too large.	Move the object disturbing the operation, and turn on the plotter after turning it off once. Do not use heavy media.
E05001		Data larger than the buffer size cannot be copied.	Perform normal cutting not using the copy mode.
E05002		There is no data to copy.	Perform normal cutting by sending the data, then use the copy mode.
E05003		Media valid area to copy is too small.	Use larger media.
E05004		The push roller is not on the grit roller.	Set the push roller on the grit roller.
E05005		It has failed to cross cut.	The media was not cut off. Check the blade for the cross cut. Check the media on the writing panel.
E05006		Distance between the bottom left and top right of the AREA setting is less than 5 mm.	Perform the AREA setting again.
E05007		Test pattern for the TOOL OFFSET ADJ. cannot start plotting because the start position is at the edge of the media.	Set the start position inside the media.

## Caution Message

Symptom	LCD Display	Description
W06001		Cross cut function cannot be used for sheet media.
W06002		Cross cut function cannot be used because the media is loaded from the front.
W06003		Cross cut function cannot be used until the media size is detected.
W06004		Cross cut function cannot be used when the push roller sensor is disabled.
W06005		Cross cut function cannot be used when the media sensor is disabled.
W06007		CONDITION No. that has selected pouncing tool as the tool number setting can only set TOOL 1.

# 13-2 Printing the Setting of the Plotter

Condition setting list can be printed when you need to check the current setting of the plotter.

## CAUTION

Do not place your hand around the moving areas. The tool carriage will start moving, so there is a chance of injury. Tool carriage will start to move immediately after selecting to print the CONDITION list.

## Operation

1 Set a media larger than A3 size.

2 Set the pen tool to the tool carriage.

3 Press the [MENU] key.

▶MENU screen is displayed.



4 Press the **POSITION** (◀) key (TEST).

▶TEST menu screen is displayed.

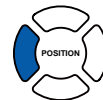
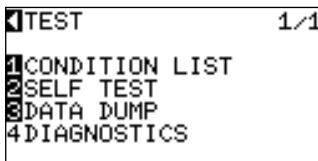

5 Press the [1] key (CONDITION LIST).

▶CONDITION LIST print screen is displayed.

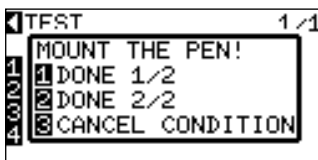

## Supplement

See "Loading Media (Paper or Marking Film)"

[P.2-6](#) for loading the media.

## Supplement

See "Attaching a Tool" [P.2-4](#) for setting the

pen tool.

Next page



6

Press the [1] key (DONE 1/2) or the [2] key (DONE 2/2).

►Message to confirm tool position is displayed.



7

Move the tool carriage to print start position by pressing the **POSITION** (▲▼◀▶) key.

8

Confirm that movable parts of the tool and media can safely operate and press the [ENTER] key.

►Selected page of the CONDITION LIST is printed.

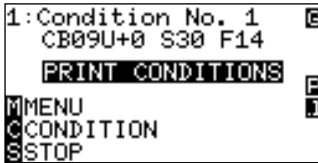

9

It will return to READY status when the printing is completed.

10

Press the [MENU] key.

►It will return to READY status when the printing is completed.

### Supplement

It will return to TEST menu screen without printing the list when [3] key (CANCEL CONDITION) is pressed.

### CAUTION

Do not place your hand around the moving areas. The tool carriage will start moving, so there is a chance of injury.

### Supplement

Set the media and repeat steps 6 to 8 to print different page at this point.

Create a self-test pattern to check the operation of the plotter.

**CAUTION**

Do not place your hand around the moving areas. The tool carriage will start moving, so there is a chance of injury. Tool carriage will start to move immediately after selecting to plot the test pattern.

**Operation**

1 Set a media larger than A4 size.

2 Set the pen tool to the tool carriage and select the condition where the pen tool is set.

3 Press the [MENU] key.

▶MENU screen is displayed.



4 Press the POSITION (◀) key (TEST).

▶TEST menu screen is displayed.

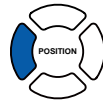
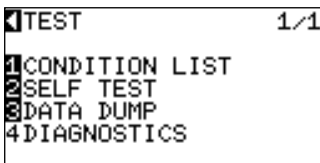

5 Press the [2] key (SELF TEST).

▶SELF TEST start screen is displayed.

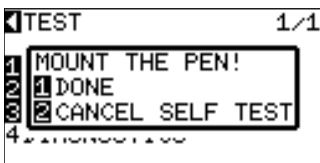

6 Confirm that the pen tool is set.

7 Confirm that operation area of tool and media is safe.

**Supplement**

See "Loading Media (Paper or Marking Film)"

[P.2-6](#) for loading the media.

**Supplement**

See "Attaching a Tool" [P.2-4](#) for setting the pen tool.

**CAUTION**

Do not place your hand around the moving areas. The tool carriage will start moving, so there is a chance of injury.

Next page

8

Press the [1] key (DONE).

▶Plotting of the test pattern starts.

```
1:Condition No. 1  [E]
  CB09U+0 S30 F14
    SELF TEST
1SELECT USER      [P]
2VIEW             [1]
3HOME
ECONDITION No.
```

9

Turn the power off to stop the printing.

### Supplement

- It will return to TEST menu screen without printing by pressing the [2] key (CANCEL SELF TEST).
- It will keep on printing until the power is turned off once the printing is started by pressing the [1] key (START SELF TEST).

# 13-4 Confirm the Cutting Data

Output of the dump list of the cutting data received by the plotter is possible. It is used to check if the transmission of cutting data is performed correctly.

## CAUTION

Do not place your hand around the moving areas. The tool carriage will start moving, so there is a chance of injury. Tool carriage will start to move immediately after selecting to print the dump list.

## Supplement

There may be a difference in the RS-232C transmission condition or the command setting when the printed output and the display of transmission data does not match. Check the transmission condition and the command.

## Operation

1 Set a media larger than A4 size.

### Supplement

See "Loading Media (Paper or Marking Film)" [P.2-6](#) for loading the media.

2 Set the pen tool to the tool carriage and select the condition where the pen tool is set.

### Supplement

See "Attaching a Tool" [P.2-4](#) for setting the pen tool.

3 Press the [MENU] key.

▶MENU screen is displayed.



4 Press the POSITION (◀) key (TEST).

▶TEST menu screen is displayed.

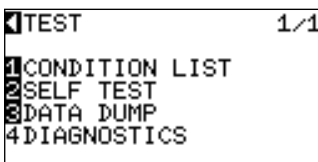
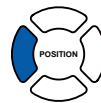

5 Press the [3] key (START DATA DUMP).

▶DATA DUMP start screen is displayed.

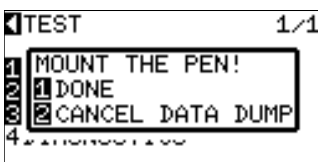

Next page

6

Confirm that the pen tool is set.

7

Confirm that operation area of tool and media is safe.

8

Press the [1] key (DONE).

▶Output of the dump list starts.

```
1:Condition No. 1  G
  CB09U+0 S30 F14
  PRINT DATA DUMP
1SELECT USER      P
2VIEW             1
3HOME
ECONDITION No.
```

9

Turn the power off to stop the printing.

 **CAUTION**

Do not place your hand around the moving areas.  
The tool carriage will start moving, so there is a chance of injury.

**Supplement**

- It will return to TEST menu screen without printing by pressing the [2] key (CANCEL DATA DUMP).
- It will keep on printing until the power is turned off once the printing is started by pressing the [1] key (START DATA DUMP).

# 13-5 Self Diagnostic Test

Operation status can be tested by self diagnostic test by operating the sensors and switches following the instruction on the screen.

## Supplement

Diagnostic test can be performed only right after the power is turned on. DIAGNOSTICS cannot be selected from the menu once any operation, such as loading media, is performed.

## Operation

- 1 Confirm that the power is turned off.
- 2 Turn the power on without loading the media.
- 3 Press the [MENU] key once the default screen is displayed.

►MENU screen is displayed.



- 4 Press the **POSITION** (◀) key (TEST).

►TEST menu screen is displayed.

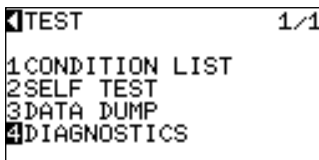
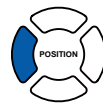

- 5 Press the [4] key (DIAGNOSTICS).

►DIAGNOSTICS start screen is displayed.

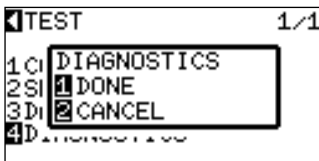

- 6 Press the [1] key (CONTINUE).

►Messages for testing are displayed on the screen.

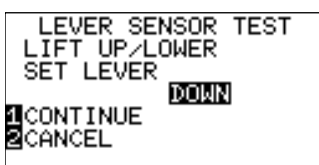

Next page

## 7 Operate switches and sensors following the instructions on the screen.

► "NORMAL" will be displayed if the operation is detected correctly, and next test will start.

► It will return to TEST menu screen once all the test items are completed.

Test items are as following.

1	Set lever sensor	2	Home sensor	3	Push roller sensor	4	-X media sensor
5	+X media sensor	6	X motor signal	7	Y motor signal	8	Tool height signal
9	[1] key	10	[2] key	11	[3] key	12	[4] key
13	POSITION [▶] key	14	POSITION [◀] key	15	POSITION [▼] key	16	POSITION [▲] key
17	[ENTER] key	18	[CONDITION] key	19	[ORIGIN] key	20	[FAST] key
21	[CROSSCUT] key	22	[COPY] key	23	[MENU] key	24	[STOP] key

## Reading the Error Message

Contents of most current 32 errors can be checked. Errors before that are not recorded.

### Operation

1 Press the [MENU] key.

► MENU screen is displayed.



2 Press the POSITION (▼) key (ADV.).

► ADVANCE screen (1/3) is displayed.

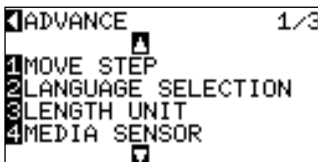

3 Press the POSITION (▲) key.

► ADVANCE screen (3/3) is displayed.

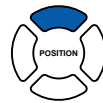
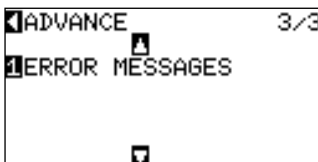

Next page

**4**

Press the **[1]** key (ERROR MESSAGES).

► ERROR MESSAGES list screen is displayed. Left column is time the error occurred, and right column is the type of the error. 4 error messages are displayed at once. If there are more error messages, next 4 messages will be displayed by pressing the POSITION (**▲▼**) key.

**5**

Press the **[1]** to **[4]** keys to see the contents of the error.

► Error message corresponding to the pressed key is displayed.

**6**

Press the **[ENTER]** key (CONFIRM) when the error message is confirmed.

► It will return to ERROR MESSAGES list screen.

**7**

Press the **[MENU]** key.

► It will return to default screen.

### Supplement

- "NO ERROR" will be displayed if there is no error.
- Up to 4 error messages will be displayed on the screen. Up to 32 error messages can be displayed by pressing the POSITION (**▲▼**) key.

### Supplement

Press the POSITION (**▲▼**) key in the screen of step 4 as necessary and repeat steps 5 and 6 if there are multiple error messages you would like to see.





# Chapter 14: Option

**This chapter describes about the options.**

## Axis Alignment, Cut Area Positioning

The loupe (bombsight) is used to align points for adjustment during axis alignment operations, and to align the corner points when specifying the plotting area. It indicates the current pen position, and is used for fine adjustment. The loupe is mounted in the tool holder.

## Attaching the Loupe

### Operation

1 Loosen the tool holder screw.

2 While pushing the tool holder in the upward direction, push the loupe all the way into the holder until its flange contacts the upper part of the tool holder.

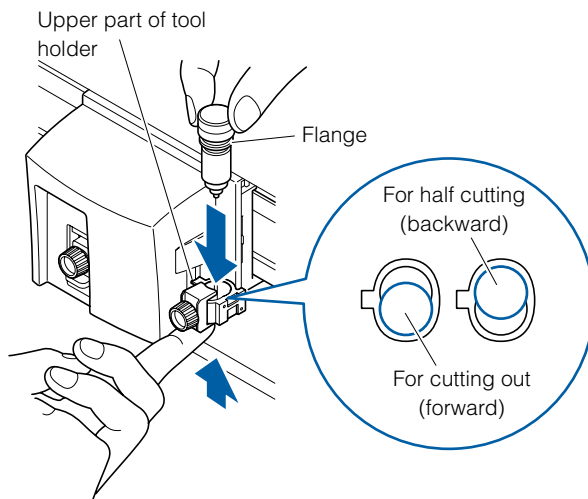

3 Make sure that the tool bracket is engaged on the loupe's flange, and then tighten the screw.

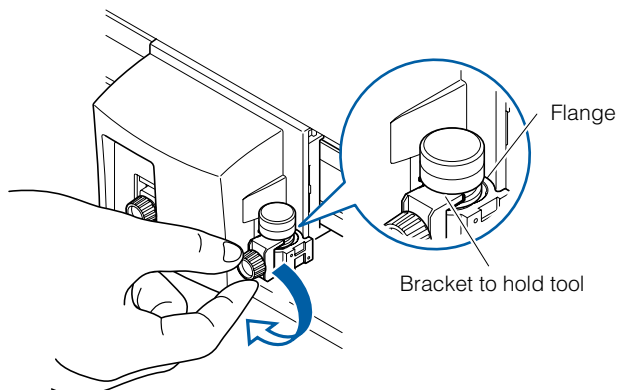

### Supplement

See "Attaching a Tool" [P.2-4](#) for how to tighten the screws on the tool holder.

### Supplement

- Use the same procedure to attach the pouncing tool to the tool holder of the 2-pen model.
- See "2 Pen Assignment (Switching the Tools)" [P.14-7](#) for 2-pen option.
- Attach the loupe to the half cutting (backward) side.

Next page

## Using the Loupe

Use your finger to put the loupe in the pen down status. Position your line of sight so that you are looking directly down into the loupe.

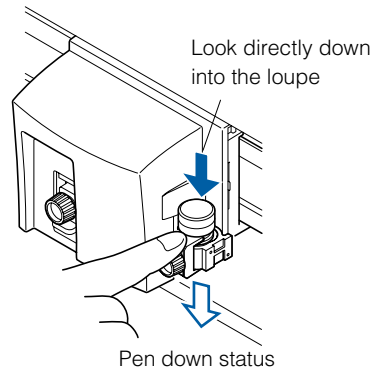

### CAUTION

If you look through the loupe at an angle, the center point will be shifted and you will not get a correct reading.

When aligning the loupe with a point, use the POSITION keys to move the loupe so that the crosshairs are aligned with the center of the target point.

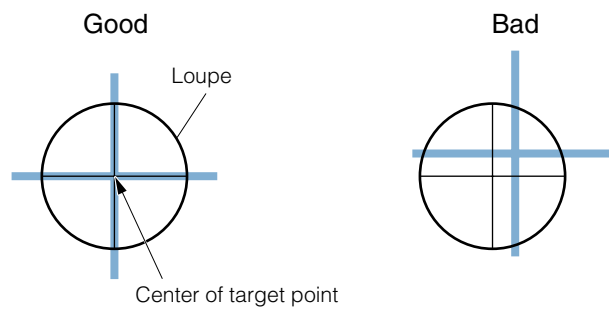

# 14-2 Pouncing (Punch Continuous Holes)

Pouncing is a method used to create a punched outline on media.

## Attaching the Pouncing Tool

### Operation

- 1 Loosen the tool holder screw.
- 2 While pushing the tool holder in the upward direction, push the pouncing tool all the way into the holder until its flange contacts the upper part of the holder. The flat edge must be parallel to the tool holder.

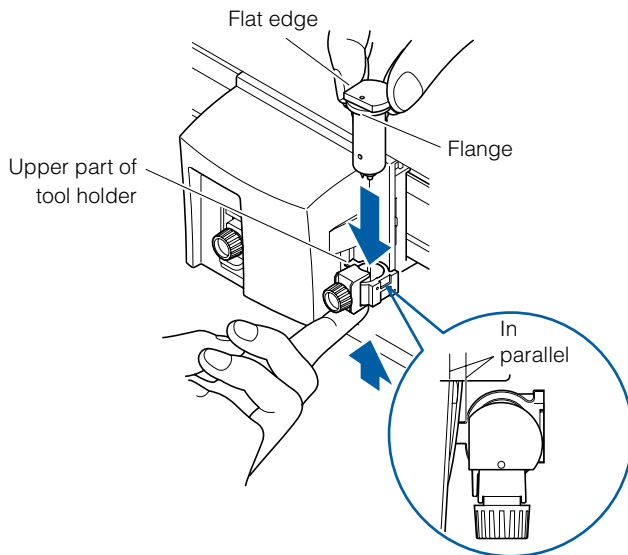

- 3 Make sure that the tool bracket is engaged mounted firmly over the flange, and then tighten the screw.

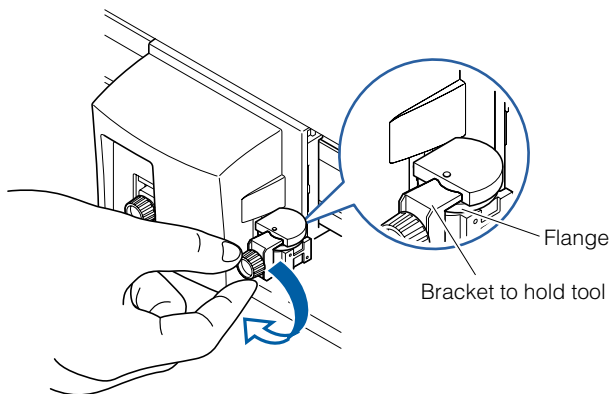

### Supplement

See "Attaching a Tool" [P.2-4](#) for how to tighten the screws on the tool holder.

### CAUTION

Attach the pouncing tool to the half cutting (backward) side. It may damage the panel if it is attached to the forward side.

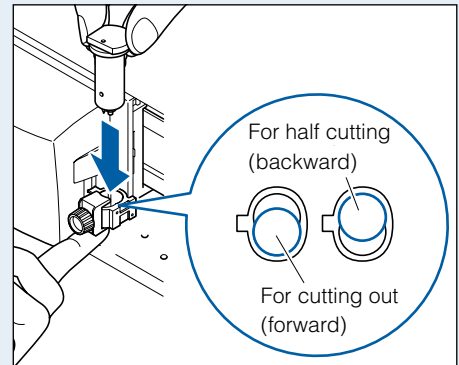

### Supplement

See "2 Pen Assignment (Switching the Tools)" [P.14-7](#) for 2-pen option.

# Setting the Pouncing Tool

Set the distance of the holes when continuous holes are to be punched.

## Operation

1 Press the [CONDITION] key in the default screen.

▶CONDITION setting screen (1/3) is displayed.

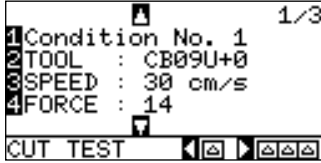

2 Press the [2] key (TOOL).

▶TOOL setting screen is displayed.

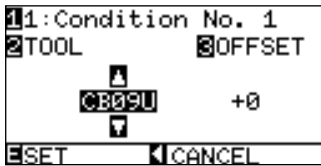

3 Press the [1] key.

▶CONDITION No. screen is displayed.

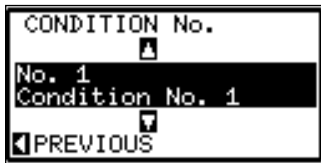

\* Display may vary depending on the selected tool condition number.

4 Press the **POSITION** (▲▼) key and select the tool condition number (CONDITION No.).

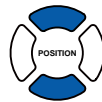

5 It will get set and return to TOOL setting screen by pressing the **POSITION** (◀) key (PREVIOUS).

▶CONDITION No. is selected and return to TOOL setting screen.

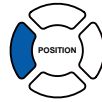

6 Press the **POSITION** (▲▼) key and select "POUNCE".

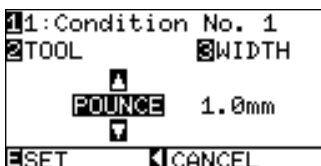

### Supplement

It will return to CONDITION screen (1/3) without changing the settings when you press the POSITION (◀) key (CANCEL).

Next page

7

Press the [3] key (WIDTH).

▶WIDTH setting screen is displayed.

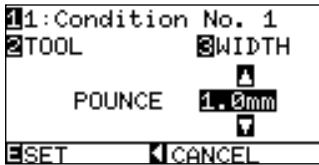

\* Display may vary depending on the selected tool condition number.

8

Press the **POSITION** (▲▼) key and increase or decrease the setting value.



**Supplement**

It will return to CONDITION screen (1/3) without changing the settings when you press the POSITION (◀) key (CANCEL).

9

Confirm the setting and press the [ENTER] key (SET).

▶Setting will be set, and it will return to CONDITION screen (1/3).

10

Press the [CONDITION] key.

▶It will return to default screen.

## Attaching to Tool Holder

The 2-pen unit is a factory-installed option. It cannot be retrofitted.

### Operation

- 1 Loosen the tool holder screw.

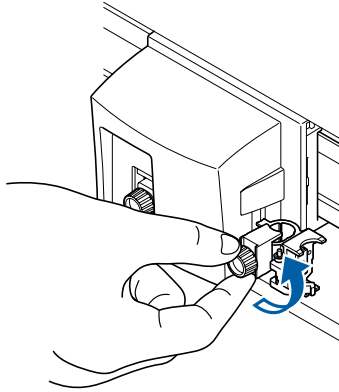

- 2 While pushing the tool holder in the upward direction, push the tool all the way into the holder until its flange contacts the upper part of the holder.

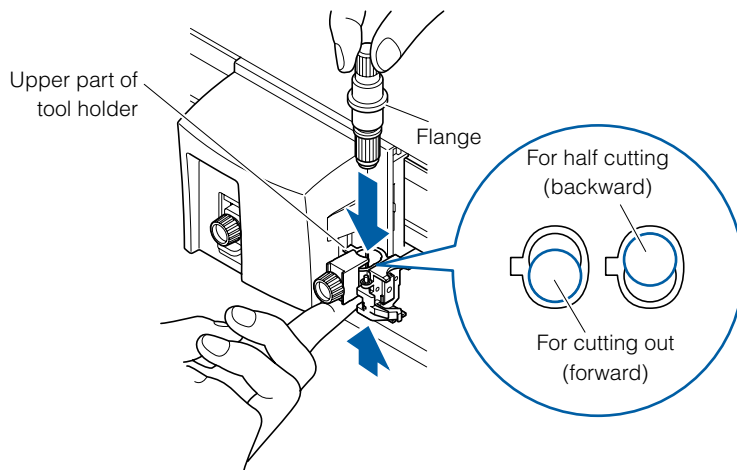

#### Supplement

See "Attaching a Tool" [P.2-4](#) for how to tighten the screws on the tool holder.

#### CAUTION

When pushing the tool holder with your fingers, the blade tip may be protruding. Take care not to cut your fingers.

#### Supplement

- The forward position of the tool is used for the cutting out mainly, and the backward position is used for the half cutting mainly.
- Cutting out means that the media is cut out completely.
- Half cutting means that only the marking film is cut out, leaving the backing sheet uncut.
- See "What is Cutting Plotter?" in Setup Manual for structure of the marking film.

Next page



- 3** Make sure that the tool bracket is engaged on the tool's flange, and then tighten the screw.

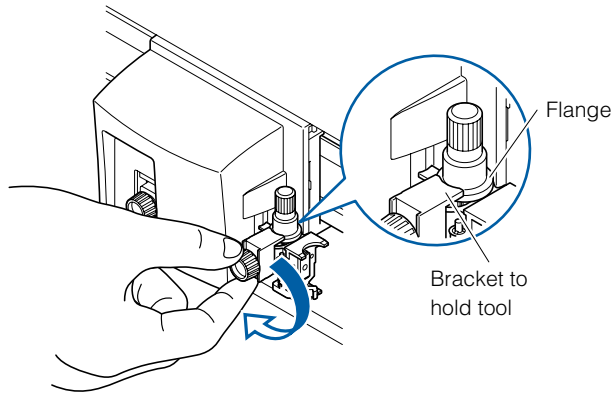

## Attaching to the Pen Station

Open the pen-hold mechanism on the pen station, and then attach the plotting pen.

### Operation

- 1** Easily pull the bracket on the pen station forward and attach the plotting pen.

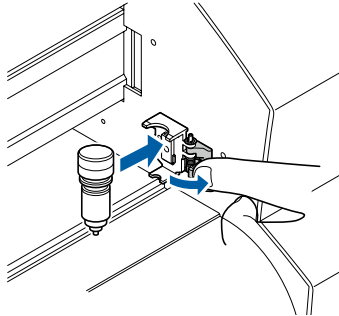

- 2** Make sure that the bracket of the pen station is engaged in the upper groove of the pen.

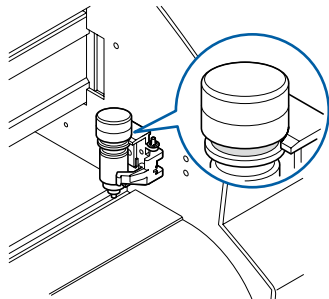

### CAUTION

- Do not leave the plotter pens mounted on the pen station for long period. Pen tips will dry out, making it unusable. Take the pens off from the pen station and place the caps to store.
- Only the plotting pens can be mounted on the pen station. Do not mount the cutter pens.

## Assigning Tool Number

The tool number to use can be set for each of the 8 TOOL CONDITION No. **Tool 1** will use the tool attached to the backward of the tool holder (**for half cutting**), **tool 2** will use the tool attached to the pen station, and **tool 3** will use the tool attached to the forward of the tool holder (**for cutting out**).

### Supplement

- This setting is maintained even if the power is turned off.
- Physical pen 2 can be set only when the tool is mounted on the pen station on the 2-pen plotter.
- See "Attaching to Tool Holder (Option)" [P.14-7](#) and "Attaching to the Pen Station" [P.14-8](#) for mounting of the tools.

## Operation

1 Press the [CONDITION] key.

▶CONDITION setting screen (1/3) is displayed.

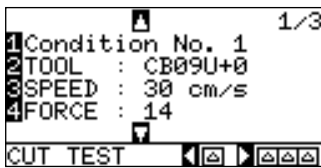

2 Press the POSITION (▼) key.

▶CONDITION setting screen (2/3) is displayed.



3 Press the [3] key (ASSIGN TOOL).

▶ASSIGN TOOL setting screen is displayed.

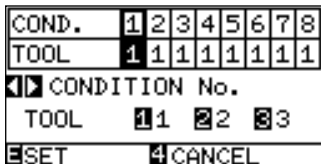

4 Press the POSITION (◀▶) key and select the CONDITION No.



5 Press the [1], the [2], or the [3] key and select the tool number to set.

### Supplement

- Tool number [2] can be set only when the tool is mounted on the pen station on the 2-pen plotter.
- Only [1] can be set when using the pouncing tool.

6 Confirm the setting and press the [ENTER] key (SET).

▶Setting will be set, and it will return to CONDITION screen (2/3).

### Supplement

It will return to CONDITION screen (2/3) without changing the settings when you press the [4] key (CANCEL).

Next page

7 Press the [CONDITION] key.

▶ It will return to default screen.

## Tool Offset Adjustment

This is used when there is difference in cutting between 2 tools.

### Supplement

This setting is maintained even if the power is turned off.

### For between tool 1 and 2

Position adjustment is performed by entering the compensation value if there is a difference between tool 1 (tool attached to the backward of the tool holder) and tool 2 (tool attached to the pen station).

## Operation

1 Mount either the cutter plungers or the plotting pens on the tool 1 (backward of the tool holder) and turn on the power.

2 Press the [MENU] key in READY status.

▶ MENU screen is displayed.



3 Press the [1] key (TOOL).

▶ TOOLS SETTING screen (1/3) is displayed.

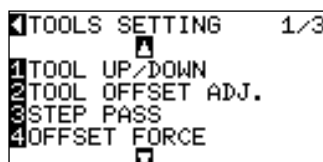

4 Press the [2] key (TOOL OFFSET ADJ.).

▶ TOOL OFFSET ADJ. setting screen is displayed.

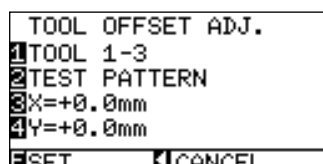

### Supplement

It will return to TOOLS SETTING screen (1/3) without changing the settings when you press the POSITION (◀) key (CANCEL).

5 Press the [1] key (TOOL).

▶ TOOL OFFSET ADJ. screen is displayed.



Next page

6

Press the [2] key (TOOL 1-2).

▶ It is set to adjust between the TOOL 1-2 and return to TOOL OFFSET ADJ. screen.

**Supplement**

It will return to TOOL OFFSET ADJ. screen without changing the settings when you press the POSITION (◀) key (CANCEL).

7

Press the [2] key (TEST PATTERN).

▶ Tool position move screen is displayed.



8

Press the POSITION (▲▼◀▶) key to move the tool carriage to the location to draw "+". Move at least 50 mm inside the cutting are for both X and Y.



**Supplement**

- It will return to TOOL OFFSET ADJ. screen by pressing the [4] key (CANCEL).
- Speed of movement will become faster by pressing the [FAST] key and POSITION key simultaneously.

9

Confirm the position of the tool and press the [ENTER] key.

▶ Tool 1 will plot the "+". Screen prompting to change the tool is displayed once the plotting is completed.

**Supplement**

Tool condition 1 will be used with tool 1.

10

Set the cutter plunger or plotting pen to the tool 2 (pen station) and press the [ENTER] key.

▶ Tool 2 will plot the "+" and return to the TOOL OFFSET ADJ. screen once the plotting is completed.

**Supplement**

Tool condition 2 will be used with tool 2.

11

Using the "+" plotted by tool 1, measure the distance to the "+" plotted by tool 2.

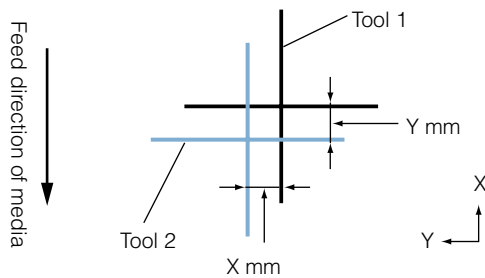

12

Press the [3] key (X).

▶ X AXIS ALIGNMENT setting screen is displayed.



13

Press the POSITION (▲▼) key to increase or decrease the value to set the difference in X axis direction measured in step 11.

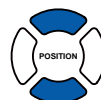

Next page

14

Confirm the setting and press the POSITION (◀) key (PREVIOUS).

▶ X AXIS ALIGNMENT is selected and return to the TOOL OFFSET ADJ. screen.

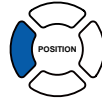

15

Press the [4] key (Y).

▶ Y AXIS ALIGNMENT setting screen is displayed.



16

Press the POSITION (▲▼) key to increase or decrease the value to set the difference in Y axis direction measured in step 11.

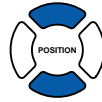

17

Confirm the setting and press the POSITION (◀) key (PREVIOUS).

▶ Y AXIS ALIGNMENT is selected and return to the TOOL OFFSET ADJ. screen.

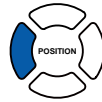

18

Repeat steps 7 to 17 until there is no difference.

19

Confirm the distance and press the [ENTER] key (SET).

▶ Setting will be set, and it will return to TOOLS SETTING screen (1/3).

20

Press the [MENU] key.

▶ It will return to default screen.

## For between tool 1 and 3

Position adjustment is performed by entering the compensation value if there is a difference between tool 1 (tool attached to the backward of the tool holder) and tool 3 (tool attached to the forward of the tool holder).

### Operation

1

Mount either the cutter plungers or the plotting pens on the tool 1 (backward of the tool holder) and turn on the power.

2

Press the [MENU] key in READY status.

▶ MENU screen is displayed.



#### CAUTION

When pushing the tool holder with your fingers, the blade tip may be protruding. Take care not to cut your fingers.

Next page

3

Press the [1] key (TOOL).

▶TOOLS SETTING screen (1/3) is displayed.

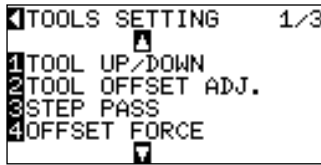

4

Press the [2] key (TOOL OFFSET ADJ.).

▶TOOL OFFSET ADJ. setting screen is displayed.



5

Press the [2] key (TEST PATTERN).

▶Tool position move screen is displayed.



6

Press the **POSITION** (▲▼◀▶) key to move the tool carriage to the location to draw "+". Move at least 50 mm inside the cutting are for both X and Y.



7

Confirm the position of the tool and press the [ENTER] key.

▶Tool 1 will plot the "+". Screen prompting to change the tool is displayed once the plotting is completed.

8

Set the cutter plunger or plotting pen to the tool 3 (forward of the tool holder) and press the [ENTER] key.

▶Tool 3 will plot the "+" and return to the TOOL OFFSET ADJ. screen once the plotting is completed.

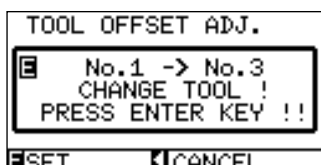

### Supplement

It will return to TOOLS SETTING screen (1/3) without changing the settings when you press the POSITION (◀) key (CANCEL).

### Supplement

- It will return to TOOL OFFSET ADJ. screen by pressing the [4] key (CANCEL).
- Speed of movement will become faster by pressing the [FAST] key and POSITION key simultaneously.

### Supplement

Tool condition 1 will be used with tool 1.

### Supplement

Tool condition 3 will be used with tool 3.

9

Using the "+" plotted by tool 1, measure the distance to the "+" plotted by tool 3.

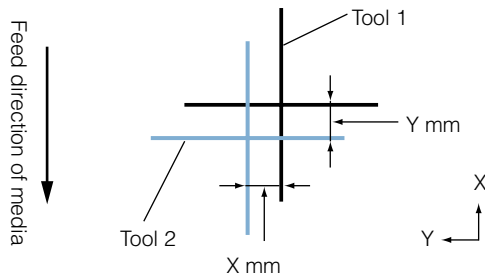

10

Press the **[3]** key (X).

► X AXIS ALIGNMENT setting screen is displayed.



11

Press the **POSITION (▲▼)** key to increase or decrease the value to set the difference in X axis direction measured in step 9.

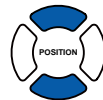

12

Confirm the setting and press the **POSITION (◀)** key (PREVIOUS).

► X AXIS ALIGNMENT is selected and return to the TOOL OFFSET ADJ. screen.

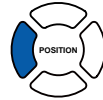

13

Press the **[4]** key (Y).

► Y AXIS ALIGNMENT setting screen is displayed.



14

Press the **POSITION (▲▼)** key to increase or decrease the value to set the difference in Y axis direction measured in step 9.

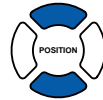

15

Confirm the setting and press the **POSITION (◀)** key (PREVIOUS).

► Y AXIS ALIGNMENT is selected and return to the TOOL OFFSET ADJ. screen.

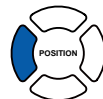

16

Repeat steps 5 to 15 until there is no difference.

17

Confirm the distance and press the **[ENTER]** key (SET).

► Setting will be set, and it will return to TOOLS SETTING screen (1/3).

[Next page](#)

18

Press the **[MENU]** key.

▶ It will return to default screen.



## Enabling/Disabling 1/2 Pen Check (CHECK TOOL)

It is possible to disable the check if the tool is mounted on the pen station at the media detection. It can be set back to enabled from here too. Make sure to set the plotting pen to the pen station at the power up when it is set to DISABLED.

### Operation

1 Mount either the cutter plungers or the plotting pens and turn on the power.

2 Press the [MENU] key in the default screen.

▶MENU screen is displayed.



3 Press the POSITION (▼) key (ADV).

▶ADVANCE setting screen (1/3) is displayed.



4 Press the POSITION (▼) key.

▶ADVANCE setting screen (2/3) is displayed.

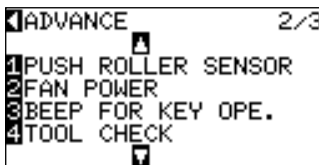

5 Press the [4] key (TOOL CHECK).

▶TOOL CHECK setting screen is displayed.

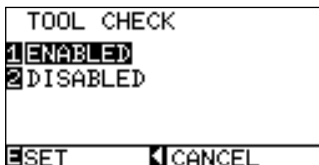

6 Press the [1] key (ENABLED) or the [2] key (DISABLED).

7 Confirm the setting and press the [ENTER] key (SET).

▶Setting will be set, and it will return to ADVANCE setting screen (2/3).

8 Press the [MENU] key.

▶It will return to the default screen.

### Supplement

- This setting is maintained even if the power is turned off.
- This menu is not displayed on standard equipment.

### CAUTION

Pen station is made for plotting pens only. Do not mount the cutter pens.

### Supplement

[4] is displayed only when there is a plotting pen mounted on the pen station.

### Supplement

It will return to TOOL setting screen without changing the settings when you press the POSITION (◀) key (CANCEL).

# Chapter 15: **Specifications**

**This chapter describes the specification of the plotter.**

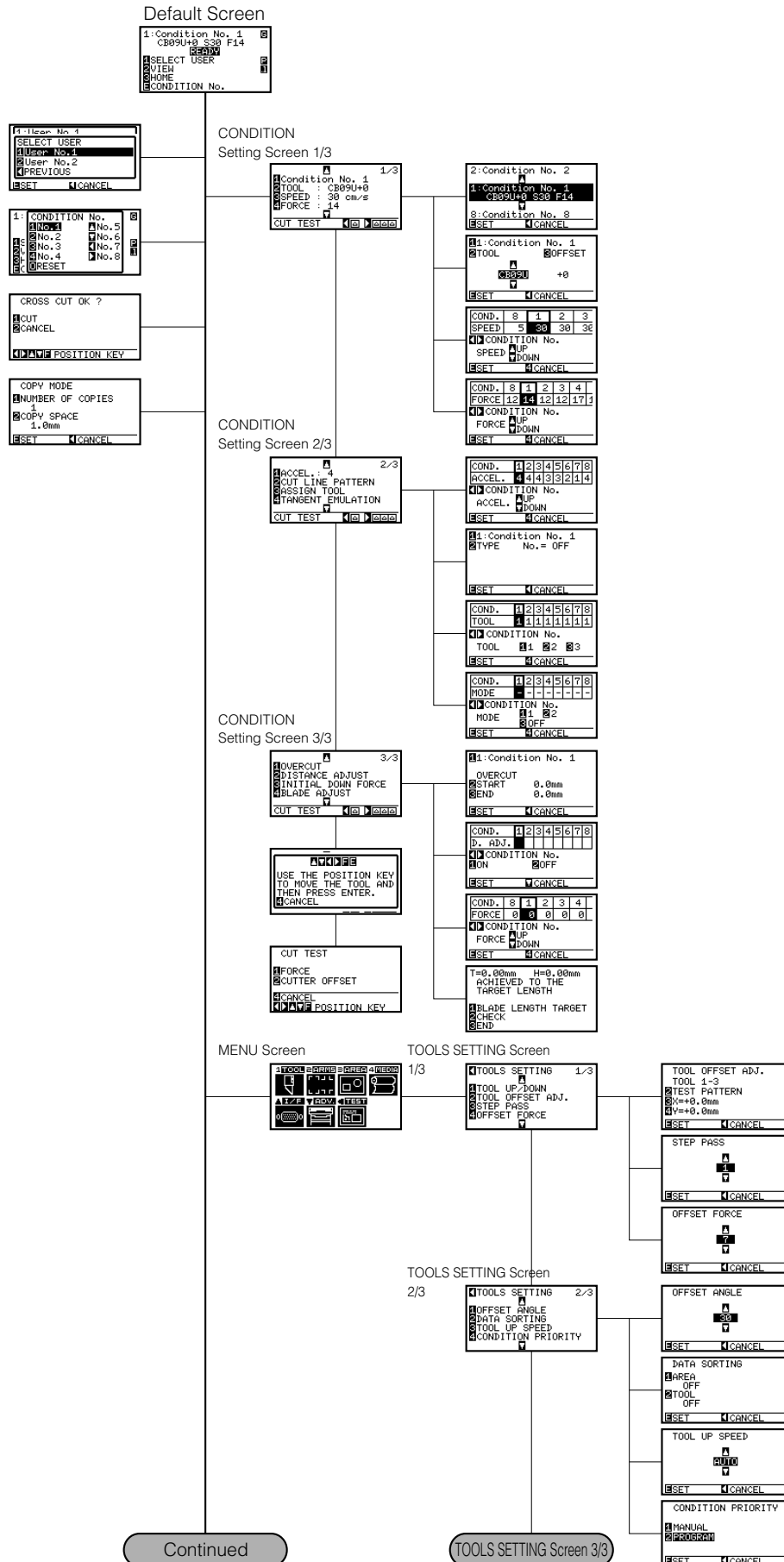

Continued

TOOLS SETTING Screen 3/3

MENU Screen



TOOLS SETTING Screen

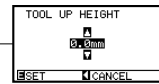
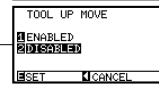
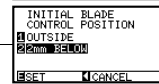
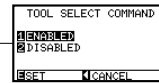
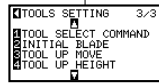

ARMS SETTING Screen

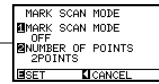
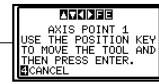

ARMS SETTING Screen

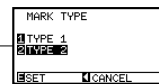
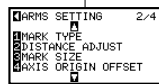

ARMS SETTING Screen

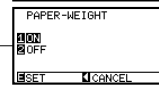
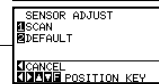
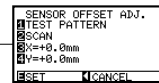
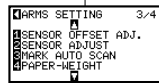

ARMS SETTING Screen

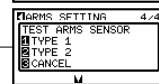
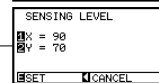

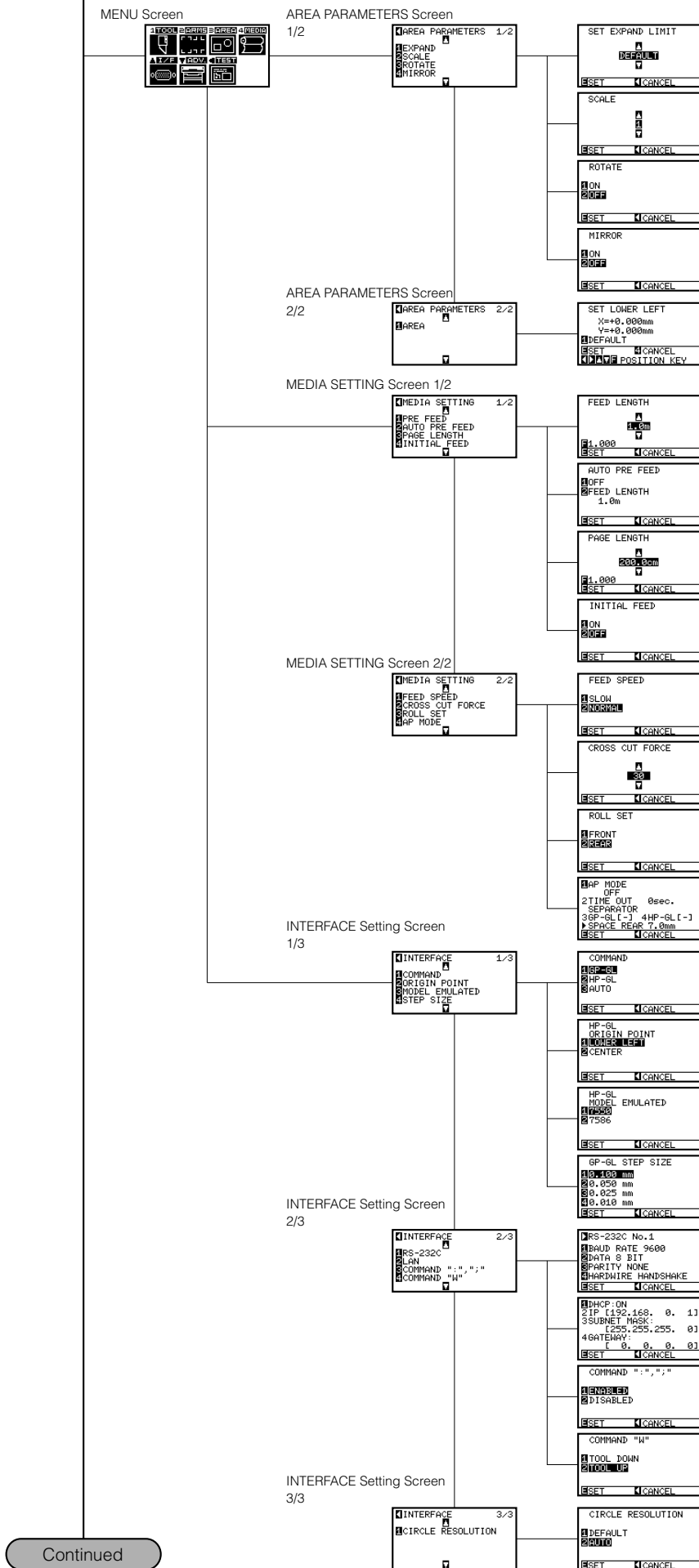

Continued

Default Screen (Continued)

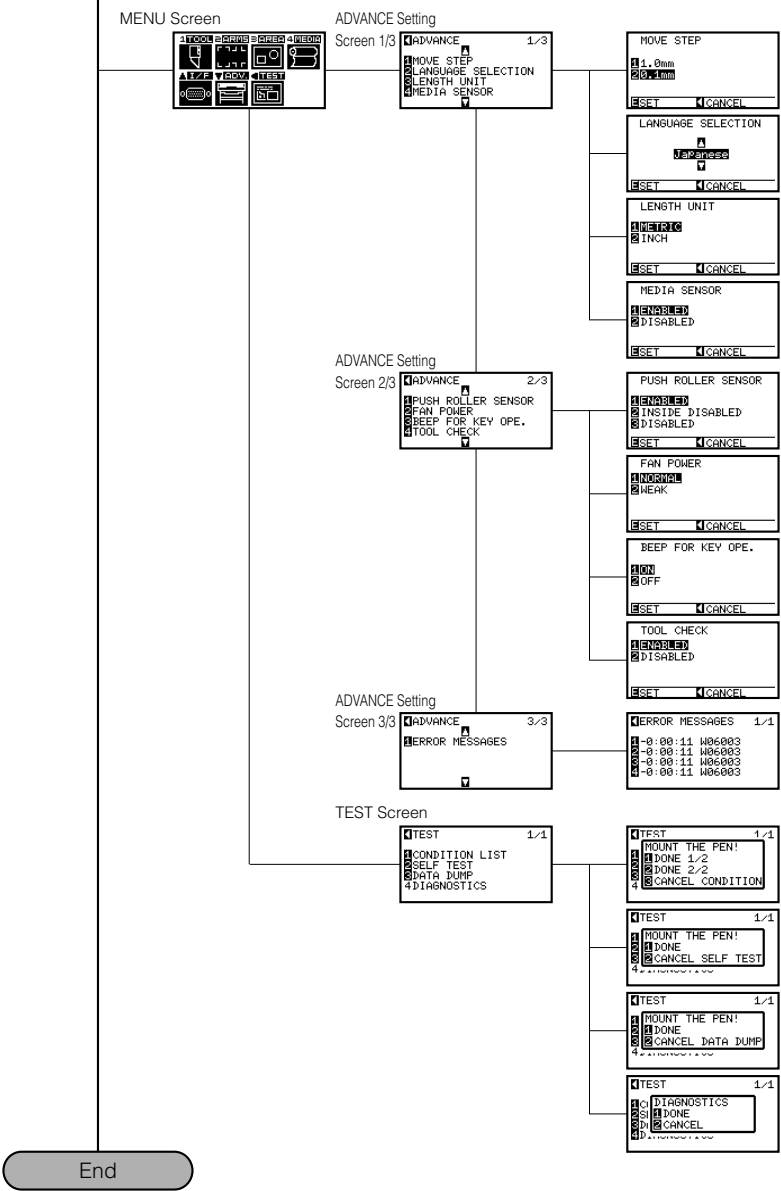

# 15-2 Main Specifications

	<b>FC8000-60</b>	<b>FC8000-75</b>	<b>FC8000-100</b>	<b>FC8000-130</b>	<b>FC8000-160</b>
CPU	32bit CPU				
Configuration	Grit-rolling plotter				
Drive	Digital servo				
Max. Cut Area	50 m x 610 mm (expanded mode)	50 m x 762 mm (expanded mode)	50 m x 1067 mm (expanded mode)	50 m x 1372 mm (expanded mode)	50 m x 1626 mm (expanded mode)
Guaranteed precision cutting area <sup>1</sup>	15 m x 590 mm	15 m x 742 mm	10 m x 1047 mm 15 m x 894 mm	10 m x 1352 mm 15 m x 894 mm	10 m x 1606 mm 15 m x 894 mm
Mountable media width	Max: 730 mm Min: 50 mm	Max: 901 mm Min: 50 mm	Max: 1206 mm Min: 50 mm	Max: 1511 mm Min: 50 mm	Max: 1765 mm Min: 50 mm
Max. cutting speed	148.5 cm/s (45° direction)				
Specifiable speeds	1, 2, 3, 4, 5, 6, 7, 8, 9, 10, 15, 20, 25, 30, 35, 40, 45, 50, 55, 60, 70, 80, 90, 100, 105 cm/s				
Cutting Pressure	48 steps, 0.196 to 5.88 N (20 to 600 gf)				
Min. character size	3 mm (0.125 in.) alphanumeric Helvetica med. Font				
Mechanical resolution	0.005 mm				
Program mable resolution	GP-GL: 0.1/0.05/0.025/0.01 mm, HP-GL <sup>2</sup> : 0.025 mm				
Repeatable accuracy <sup>1</sup>	Max. 0.1 mm/in unit of 2 m (excluding media shrinkage)				
Number of cutters/pens	1 (2 for 2-pen model <sup>3</sup> )				
Pen types	Water-based fiber-tip, oil-based ballpoint, and disposable ink pens				
Pouncing tool type	Pouncing tool: PPA33-TP12, 1.2-mm pin diameter <sup>4</sup>				
Compatible media	Mono-vinyl chloride media, fluorescent media, and reflective media up to 0.25 mm thick, high reflective media. <sup>5</sup>				
Compatible paper for pouncing	Regular paper from 0.06 to 0.13 mm thick				
Interface	USB2.0 (Full Speed)/Network (Ethernet 10BASE-T/100BASE-TX) <sup>3</sup> / RS-232C (Auto switching)				
Buffer memory	2 MB				
Resident command sets	GP-GL/HP-GL <sup>2</sup> (Control panel switching)				
LCD display	Graphic type (Yellow backlight)				
Power supply	100-240VAC/50-60 Hz (Auto switching)				
Power consumption	160VA max.				
Operating environment	10 to 35° C, 35 to 75% R.H. (non-condensing)				

	<b>FC8000-60</b>	<b>FC8000-75</b>	<b>FC8000-100</b>	<b>FC8000-130</b>	<b>FC8000-160</b>
Guaranteed accuracy environment	16 to 32° C, 35 to 70% R.H. (non-condensing)				
External dimensions (W x H x D)	1120x1219 x 715 mm	1270x1219 x 715 mm	1570x1219 x 715 mm	1870x1219 x 715 mm	2130x1219 x 715 mm
Weight (Including stand)	36 kg	39 kg	43 kg	51 kg	59 kg

\*1: When the basket and Graphtec-specified media are used under certain condition settings.

\*2: HP-GL is a registered trademark of Hewlett-Packard Company.

\*3: This function is a factory-installed option. It cannot be retrofitted.

\*4: The PPA32-TP12 pouncing tool cannot be used.

\*5: The CB15UA cutter blade and a reinforced backing sheet must be used when cutting high-intensity reflective film.



# 15-3 Options

Item	Model	Contents	Quantity
Multimedia stocker 60	RSK0020	Roll Media stocker for FC8000-60 <sup>*1</sup>	1
Multimedia stocker 75	RSK0021	Roll Media stocker for FC8000-75 <sup>*1</sup>	1
Multimedia stocker 100	RSK0022	Roll Media stocker for FC8000-100 <sup>*1</sup>	1
Multimedia stocker 130	RSK0023	Roll Media stocker for FC8000-130 <sup>*1</sup>	1
Multimedia stocker 160	RSK0024	Roll Media stocker for FC8000-160 <sup>*1</sup>	1
Loupe	PHP61-LOUPE	Pen-type loupe with a x6 magnification ratio	1
Pouncing tool	PPA33-TP12	1.2 mm diameter, plunger, pin	1
RS-232C (for DOS/V equipment, 3 m)	CB0023C-HS	RS-232C cable (universal)	1
Flange	OPH-A21	Flange for setting roll media	1

\*1: Up to three multimedia stockers can be mounted.

# 15-4 Supplies

Item	Model	Contents
Cutter plunger	PHP32-CB09N-HS	Used with $\Phi$ 0.9 mm diameter cutter blades (CB09UA-5)
	PHP32-CB15N-HS	Used with $\Phi$ 1.5 mm diameter cutter blades, has a built-in spring
	PHP31-CB09-HS	Used with $\Phi$ 0.9 mm diameter cutter blades (CB09UA-5)
	PHP31-CB15-HS	Used with $\Phi$ 1.5 mm diameter cutter blades, comes with one tube of grease
	PHP31-CB15B-HS	Used with $\Phi$ 1.5 mm diameter cutter blades (CB15U-5SP, CB15U-K30-5SP, CB15U-K20-2SP)
Cutter blade	CB09UA-5	$\Phi$ 0.9 mm diameter, supersteel blade, comes with a spring, for cutting general film (set of 5)
	CB15U-5	$\Phi$ 1.5 mm diameter, supersteel blade, for cutting slightly thick film (set of 5)
	CB15U-5SP	$\Phi$ 1.5 mm diameter, supersteel blade, comes with a spring (set of 5)
	CB15UA-2	$\Phi$ 1.5 mm diameter, supersteel blade, for cutting high-intensity reflective film (set of 2)
	CB15U-K30-5	$\Phi$ 1.5 mm diameter, supersteel blade, for cutting thick materials (set of 5)
	CB15U-K30-5SP	$\Phi$ 1.5 mm diameter, supersteel blade, comes with a spring (set of 5)
	CB15UA-K30-2	$\Phi$ 1.5 mm diameter, supersteel blade, for cutting high-intensity reflective film (set of 2)
	CB15UB-2	$\Phi$ 1.5 mm diameter, supersteel blade, for cutting small text (set of 2)
	CB15U-K20-2SP	For cutting sandblast rubber (set of 2)
Water-based fibertip pen	KF550 Series	
Oil-based ballpoint pen	KB130, 140 Series	
Oil-based ballpoint pen plunger	PHP31/32/33-BALL	
Disposable ink pen (black)	SD Series 0.2 to 0.5 mm diameter	
Ink pen plunger	PHP32/33/34-INK	
Cross cut blade	CT01H	
	CT02U	Ultra-hard blade



**Symbols**

(Cross Cut) .....	3-14
(Front Loading) .....	2-9

**Numerics**

2-pen .....	1-3
2POINTS .....	5-6, 6-2
2POINTS .....	5-12
3POINTS .....	5-6, 6-2
4POINTS .....	5-7, 6-2

**AlphabetGroup****A**

accessory .....	1-2
AC line inlet .....	1-4
AC power cord, 2/3 prong adapter .....	1-2
Adjusting for the Registration Mark Scan Position .....	5-24
Adjust Manually .....	5-36
Adjustment Marks .....	6-2
Adjust the Blade Length Automatically .....	2-36
Adjust the Blade Length Manually .....	2-31
Advanced Registration Mark Sensing System .....	5-1
After Turning on the Plotter .....	v
Aligning the Push Roller .....	2-13
Aligning the Push Rollers .....	2-13
Alignment registration mark .....	5-8
Apparel (AP) Mode .....	4-14
Area sorting .....	8-2
Assembling .....	1-5
Assembling the Stand .....	1-6
Attaching a Tool .....	2-4
Attaching the Loupe .....	14-2
Automatically Adjust .....	5-34
Automatically Cross Cut .....	3-16
Automatic Pre Feed .....	8-4
axes adjustment (3POINT detection) .....	5-7
axes adjustment (4POINT detection) .....	5-7
axis adjustment (2POINT detection) .....	5-7
Axis Alignment, Cut Area .....	14-2

**B**

Blade Application and Features .....	2-3
--------------------------------------	-----

**C**

Changing and Storing RS-232C Settings .....	9-7
Changing CONDITION No. .....	3-6
Changing the Hold-down Force .....	2-14
Circle-Command Resolution Setting .....	11-9
Cloth basket .....	1-9
Command .....	11-2
Confirm the Cutting Data .....	13-19
Connecting with Network (LAN) .....	9-3
Connecting with RS-232C .....	9-6
Contents of Operation from CONDITION Key .....	2-19
Contents of Operation from Menu Screen .....	2-19
Continuously Move Manually .....	3-3

Control Keys .....	2-17
Control Panel .....	2-17
Control panel .....	1-3
control panel .....	10-7
Copy (Duplicate Cutting) .....	4-9
COPY key .....	2-17
Cross Cut .....	3-16
Cross Cut Force .....	3-17
Cross Cut Manually .....	3-15
Cut Line Pattern .....	7-15
Cut off the Roll Sheet (Cross Cut) .....	3-14
Cutter Blades .....	iv
Cutter Pen .....	2-2
Cutter Pens .....	iv
Cutting Area .....	4-2
cutting area .....	4-4
cutting area, .....	4-4
Cutting groove .....	1-3
Cutting mat .....	1-3
Cutting Tests .....	2-34, 2-35
Cut Width .....	3-14

**D**

Display Language Setting .....	10-2
Distance Adjust .....	7-13
Distance Adjustment Between the Registration Mark ..	5-14
Dual Configuration .....	4-12

**E**

each cutter blades .....	2-27
Enabling/Disabling 1/2 Pen Check (CHECK TOOL) ..	14-16
Enabling/Disabling the ":" and ";" Commands (COMMAND ":" ";" ..)	11-6
Enabling/Disabling the Media Sensors (MEDIA SENSOR) .....	10-4
Enabling/Disabling the Pen Select Command .....	11-4
Enabling/Disabling the Push Roller Sensors .....	10-5
enlarge/shrink scale .....	4-8
ENTER key .....	2-17

**F**

Fan Suction Setting .....	10-6
Force .....	3-17

**G**

GP-GL Command .....	11-5, 13-6
GP-GL Command Error Display .....	13-4
Grit roller .....	1-3
Grit roller position guide .....	1-3
Guideline to Set Offset .....	2-27
Guideline to Set Pouncing .....	2-27

**H**

How to Use Control Panel .....	2-17
HP-GL .....	3-9
HP-GL Command .....	11-8, 13-7
HP-GL Command Error Display .....	13-4

<b>I</b>			
Indicator Lamp .....	2-17	Push roller.....	1-3
Initial Blade Direction Adjust .....	7-18	Push roller hold-down force switching lever.....	1-4
Interface Setting Menu .....	9-3		
<b>L</b>		<b>R</b>	
Loading Roll Media (Front Loading "FRONT SET") .....	2-9	Raise or Lower the Tool .....	3-2
Loading Roll Media (Rear Loading "REAR SET") .....	2-6	Reading the Screen (LCD).....	2-18
Loading Sheet Media .....	2-11	Reference Angle.....	7-11
Loupe .....	14-2	Replacing Cutter Blade.....	12-3
		Replacing the Cross Cut Unit.....	12-4
<b>M</b>		RS-232C Interface .....	9-2
Machine Caution Label .....	v	RS-232C interface .....	1-4
Main Specifications .....	15-6		
Manually .....	3-15	<b>S</b>	
Manual Position Adjust.....	6-1, 6-2	Scan Range Necessary to Detect the Registration Mark	
Mark Distance .....	5-12	.....	5-3
Mark Scan Mode .....	6-2	Selecting Tool Condition.....	2-24
Mark Size.....	5-11	Self Diagnostic Test.....	13-21
Media.....	2-6	Sensor Level.....	5-18
Media lock.....	1-4	Setting and Adjustment of ARMS.....	5-6
Media sensor.....	1-3	Setting Cutting Area .....	4-2
Media set lever.....	1-4	Setting Cutting Width.....	4-4
Media stocker.....	1-4	Setting Enlarge/Shrink Scale.....	4-8
Media That Registration Mark Cannot be Detected.....	5-5	Setting Feeding Method.....	2-20
MENU key.....	2-17	Setting Interface .....	9-2
Menu Keys.....	2-17	Setting Length of the Page.....	4-5
Model ID Response.....	11-8	Setting Mirror .....	4-6
Move Away the Tool Carriage.....	3-5	Setting of Step Movement Distance .....	3-4
Move in Steps Manually .....	3-3	Setting of the Cross Cut Force .....	3-17
Move the Tool Carriage and Media .....	3-3	Setting of the Initial Down Force.....	7-6
Moving the Pen While Raised or Lowered in Response		Setting priority .....	11-3
to the "W" Command (COMMAND "W").....	11-7	Settings for Cutting.....	4-2
		Setting the Acceleration .....	2-30
<b>N</b>		Setting the Cutting Direction .....	3-10
Network (LAN) Interface.....	9-2	Setting the Display Length Unit.....	10-3
Network interface .....	1-4	Setting the Force .....	2-29
Nomenclature .....	1-3	Setting the Origin Point.....	3-7
Notes on the Stand.....	v	Setting the Separator.....	4-16
		Setting the Space Rear .....	4-17
<b>O</b>		Setting the Speed.....	2-28
Offset Between the Registration Mark and Cutting Origin		Setting the Tangential Emulation .....	7-3
Points .....	5-16	Setting the Tool.....	2-26
Option.....	14-1	Setting the Tool Condition.....	2-24
Options.....	15-8	Setting the Tool Number .....	2-32
ORIGIN key .....	2-17	Setting to Default .....	3-6
origin point movement.....	3-8	Shape (Pattern) of Registration Mark.....	5-2, 5-9
Origin Points.....	5-16	Sorting the Cutting Data.....	8-2
Outline of ARMS .....	5-2	Special Precautions on Handling Blades.....	iv
Overcut.....	7-4	Specifications.....	15-1
		Speed of the Registration Mark Scan.....	5-23
<b>P</b>		Stand .....	1-3
Paper-Weight.....	7-21	Standby of the Push Roller .....	2-13
Pen Assignment .....	14-7	Step Pass .....	7-9
Pen station.....	1-3	Stock rollers.....	1-4
Plotting Registration Mark for Adjustment.....	5-24	Stop Cutting.....	3-12
Positioning of the Media and the Registration Mark.....	5-4	Storing the Plotter .....	12-2
Position of the Origin Point and the Registration Mark...	5-5	Structure of Cutter Pen .....	2-2
Pouncing .....	14-4, 14-5	Supplies.....	15-9
Power switch .....	1-3		
Pre Feed .....	2-23	<b>T</b>	
Pre Feed of Media (Paper or Marking Film) .....	2-23	Tangential Emulation .....	7-2
Printing the Setting of the Plotter .....	13-15	Test Pattern.....	13-17
Priority of Tool Condition Selection.....	11-3	The ENTER key.....	13-5
		the Pen Station .....	14-8
		the Step Size (STEP SIZE).....	11-5

TO ENSURE SAFE AND CORRECT USE .....	1-2
Tool carriage.....	1-3
Tool holder.....	1-3
Tool Offset Adjustment .....	14-10
Tool sorting .....	8-2
Tool Up Move.....	8-11
Tool Up Speed.....	8-9
Turning on the Power.....	2-16

## **U**

USB cable .....	1-2
USB Interface .....	9-2
USB interface .....	1-4
Using the Loupe.....	14-3

## **W**

What is Offset .....	2-27
----------------------	------



● The specifications, etc., in this manual are subject to change without notice.

FC8000 SERIES  
(FC8000-UM-151)

April 3, 2008  
1st edition

GRAPHTEC CORPORATION



**GRAPHTEC**