

**The
Collections'19**

DRENCH
INSPIRE BY DESIGN

***Introducing a bold
design that will
revolutionise the look of
the shower enclosure.***

DRENCH
INSPIRE BY DESIGN

follow us



Our Company	2-3
Product Features	4-5
Ordering Tips	6-8



FRAME Collection

Wall Fixed panels & Free Standing Panels	12 – 13
Support Bar & Accessories for Fixed Panels	14
Bath Screens	15
Shower Doors	16 – 17
Shower Door with inline panel	18 – 19
Shower Door hinged to inline panel	20 – 21
Return Panels for Shower Enclosures	22 – 23



DECO Collection

Wall Fixed panels & Free Standing Panels	26 – 27
Support Bar & Accessories for Fixed Panels	28
Bath Screens	29
Shower Doors	30 – 31
Shower Door with inline panel	32 – 33
Shower Door hinged to inline panel	34 – 35
Return Panels for Shower Enclosures	36 – 37



LINEA Collection

Wall Fixed panels & Free Standing Panels	40 – 41
Support Bar & Accessories for Fixed Panels	42
Bath Screens	43
Shower Doors	44 – 45
Shower Door with inline panel	46 – 47
Shower Door hinged to inline panel	48 – 49
Return Panels for Shower Enclosures	50 – 51



BORDER Collection

Wall Fixed panels & Free Standing Panels	54 – 55
Support Bar & Accessories for Fixed Panels	56
Bath Screens	57
Shower Doors	58 – 59
Shower Door with inline panel	60 – 61
Shower Door hinged to inline panel	62 – 63
Return Panels for Shower Enclosures	64 – 65

ACCESSORIES & Spare Parts

Small Fixed panels	67 – 68
Support Bars	69
Shower Door Handles	70
Extension Wall Profiles	71

Innovation along with meticulous design and quality manufacture have resulted in this superior bespoke solution.



OUR IDEA

When frameless glass showers are becoming second place and colour is playing a new role in bathrooms – Drench is born. Sharing different skills and driven by an spirit of innovation, we are now proud to introduce a bold new solution for your shower enclosure.

At Drench we have been working with some of the world's leading experts to manufacture enclosures that are at the forefront of design and engineering.

For years chrome and glass have been the two fundamental components of the shower door. This is about to change and we at Drench plan to revolutionise the industry. Rather than an accessory to the bathroom, our goal is to make the shower enclosure the focal point.

After almost half a decade of research and development, Drench now have a portfolio of 4 collections that complement these latest trends bringing a bold style statement to that once ignored space in your bathroom.

Drench has combined manufacturing techniques from a number of different industries and we are the first in the world to introduce them into shower door manufacturing.

Our production is so unique that we have a patent pending on our processes.

With our ever increasing manufacturing plant nestled in the countryside of Hampshire our expertise in engineering coupled with the latest in precision machinery guarantees the highest levels of quality.

All our components have been designed and manufactured in the United Kingdom, tested in accordance to BS EN 14428:2015. Manufacture in the UK not only allows us to offer a complete range of standard items but also gives us the capability to manufacture any design and bespoke configuration requested.

With Drench shower panels, designs, colours and textures are endless. The only limitations are your imagination.



PRODUCT FEATURES



MADE IN THE UK

Drench products are manufactured in the UK.



LIFETIME WARRANTY

Drench products are lifetime guaranteed.
For further details see Sales Terms & Conditions.



RAL CLASSIC COLOURS AVAILABLE

Standard items are available in Black RAL 9005 and ALL RAL Classic colours are available as bespoke (*).



EASY CLEAN

The metal framework is only on the external face of the shower and the glass is treated to make it easy clean.



TOWEL HOLDER OPTION

Some of our styles offer towel holder option.
For further details see Accessories pages.



ADJUSTABILITY

Drench products are adjustable. Every product is designed considering tolerances.



8MM GLASS

Products are available in 8mm toughened glass BS EN12150. See further detail opposite.

(*) Due to matching colour reasons we can guarantee 100% accuracy on RAL CLASSIC system. RAL Design or RAL Effect systems are available under request. RAL CLASSIC is the most commonly used colour system in the industry. You recognise this by the 4 digit numbers; for example our standard Matt Black, RAL 9005.



DRENCH Product Catalogue is available in both EQ Software and Virtual Worlds platforms.

Do not hesitate to contact us if any further information required.
sales@drenchshowers.co.uk

ABOUT OUR GLASS

Safety Glass

DRENCH products are manufactured using the highest quality of Toughened and Safety Glass in compliance with BS EN12150-1:2015.

THIS MEANS OUR GLASS HAS BEEN MODIFIED BY THERMAL TREATMENT TO GIVE:



BS EN12150-1: 2015
TOUGHENED

- Strength and Flexibility in accordance with BS EN 12150.
- Safety – up to BS EN 12600 Class 1.
- Improved resistance to heat.
- High strength to weight ratio.
- Light transmission equal to ordinary glass.
- Safe to handle – sharp edges are removed.

Easy Clean Glass

DRENCH products are treated with a special coating on the internal face of the shower to make it easy clean.

Glass Finishes

DRENCH standards products are manufactured using CLEAR GLASS to suit every bathroom style and every shower setup.

For bespoke configurations FLUTTED, GREY TINTED & FROSTED GLASS are also available with an extra surcharge.



Fluted Glass

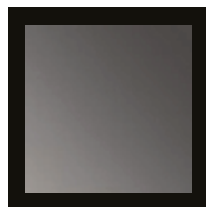

Grey Tinted Glass



Frosted Glass



Clear Glass

TIPS TO ORDER. Product Portfolio

Here below a quick guidance on our Product Portfolio. Please follow steps and notes per product configuration in order to find the correct information in the brochure.

Fixed Panels

- 1 Choose between FRAME, DECO, LINEA & BORDER and go to **Fixed panel section**.
- 2 Choose between **Wall fixed or Free Standing**
- 3 Take **price and code** according to dimensions required.
Please Note prices shown are for Matt Black and Clear glass option.
+30% for anyother glass option FROSTED, FLUTED and GREY TINTED.
+30% for any RAL Classic finish.
+50% for FROSTED, FLUTED or GREY TINTED Glass+RAL options.
- 4 Do you need any **different Support Bar**? Go to the following page to Support Bars Section.
- 5 Do you need any smaller size? Go to **Accessories** section Pages.

Bath Screens

- 1 Choose between FRAME, DECO, LINEA & BORDER and go to **Bath Screen section**.
- 2 Choose between **Wall fixed or Pivot Hinged**
Please Note RIGHT or LEFT Hand hinge needs to be specify on Pivot hinge option.
- 3 Take **price and code** according to dimensions required.
Please Note prices shown are for Matt Black and Clear glass option.
+30% for anyother glass option FROSTED, FLUTED and GREY TINTED.
+30% for any RAL Classic finish.
+50% for FROSTED, FLUTED or GREY TINTED Glass+RAL options.

Shower Doors

- 1 Choose between FRAME, DECO, LINEA & BORDER and go to **Single Shower Door section**.
- 2 Find out shower layout, is it for a **Recess** or would it be a **Shower Enclosure**?
If Shower Door is for a recess, please note the Adjustment range before ordering.
If Shower Door is part of an Enclosure, please note the Adjustment range and do not forget ordering your Return panel.
- 3 Choose between **Left or Right Hand hinge**.
Codes including L mean Left Hand
Codes including R mean Right Hand
- 4 Choose between **Opening Inwards or Outwards**.
Codes including I mean opening Inwards
Codes including O mean opening Outwards
- 5 Take **price and code** according to dimensions required.
Please Note prices shown are for Matt Black and Clear glass option.
+30% for anyother glass option FROSTED, FLUTED and GREY TINTED.
+30% for any RAL Classic finish.
+50% for FROSTED, FLUTED or GREY TINTED Glass+RAL options.
- 6 Please note DRENCH Shower doors include Standard handle, fixings and seal required to guarantee a correct installation.
If any other handle is required please Go to **Accessories** section Pages.

Shower Doors & Inline Panels

- 1** Choose between FRAME, DECO, LINEA & BORDER and find out if **Shower door closes into Inline or Shower door is hinged to Inline**.
 For Shower Doors closing into Inline Panel go to **Shower Door with Inline Panel section**.
 For Shower Doors hinged to Inline Panel go to **Shower Door hinged to Inline Panel section**.
- 2** Find out shower layout, is it for a **Recess** or would it be a **Shower Enclosure?**
 If Shower Door & Inline are for a recess, please note the Adjustment range before ordering.
 If Shower Door & Inline are part of an Enclosure, please note the Adjustment range and do not forget ordering your Return panel.
- 3** Choose between **Left or Right Hand hinge**.
 Codes including L mean Left Hand
 Codes including R mean Right Hand
- 4** Choose between **Opening Inwards or Outwards**.
 Codes including I mean opening Inwards
 Codes including O mean opening Outwards
- 5** Take **price and code** according to dimensions required.
 Please Note prices shown are for Matt Black and Clear glass option.
 +30% for anyother glass option FROSTED, FLUTED and GREY TINTED.
 +30% for any RAL Classic finish.
 +50% for FROSTED, FLUTED or GREY TINTED Glass+RAL options.
- 6** Please note DRENCH Shower doors with Inline panel include Standard handle, fixings, support bar and seal required to guarantee a correct installation.
 If any other handle is required please Go to **Accessories** section Pages.

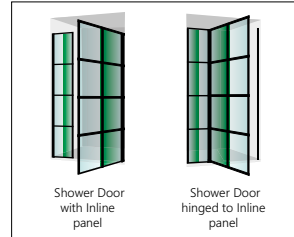

Return Panels

- 1** Choose between FRAME, DECO, LINEA & BORDER and go to **Return Panels section**.
- 2** Find out shower layout, is it just a corner Return Panel or Closing Return panel?
- 3** Choose between **Left or Right Hand side**
 Codes including L mean Left Hand
 Codes including R mean Right Hand
- 4** Take **price and code** according to dimensions required.
 Please Note prices shown are for Matt Black and Clear glass option.
 +30% for anyother glass option FROSTED, FLUTED and GREY TINTED.
 +30% for any RAL Classic finish.
 +50% for FROSTED, FLUTED or GREY TINTED Glass+RAL options.

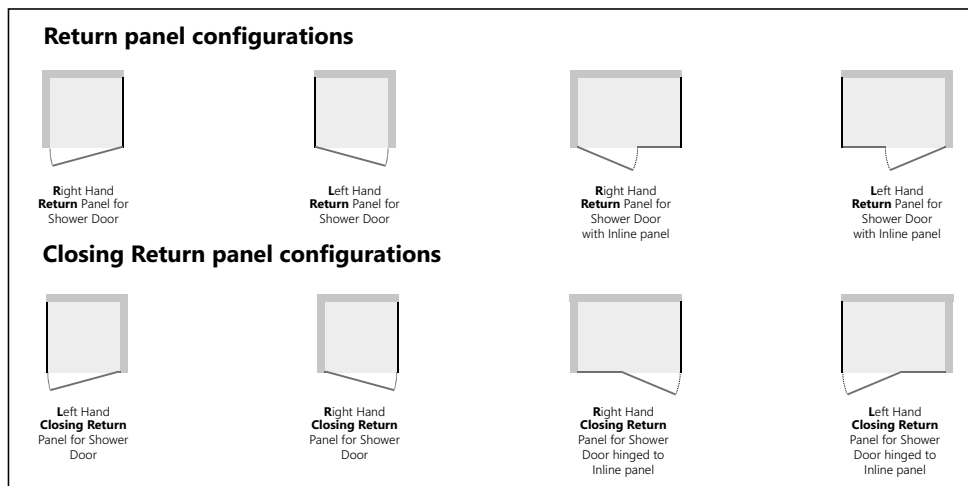

Please see Sample Layouts in the following page to see further examples. Contact us if any further assistance required. sales@drenchshowers.co.uk

TIPS TO ORDER. Sample Layouts

Here below some Layout samples and how to identify different codes within the Brochure.

SAMPLE LAYOUT 1





Shower Door with Inline Panel 1390 mm width

FRAME

DECO

LINEA

BORDER

LAYOUT	Item Description				
 1390 mm width x 2100 mm height	Shower Door with Inline Panel for a 1400 mm width Adjustment: 1361 - 1399 <i>Door 700 mm + Inline Panel 700 mm</i> L Left Hand OUT Opening out	FRADOR70/70LO1	DECODOR70/70LO1	LINDOR70/70LO1	BORDOR70/70LO1

SAMPLE LAYOUT 2

Shower Door 800 mm closing into Return Panel 800 mm

FRAME

DECO

LINEA

BORDER

LAYOUT	Item Description				
 800 mm width x 2100 mm height	Shower Door 800mm width Adjustment: 771 - 790 R Right Hand OUT Opening out	FRADOR80RO ++	DECODOR80RO	LINDOR80RO +	BORDOR80RO +
 800 mm width x 2100 mm height	Closing Return Panel 800mm Adjustment: 771 - 790 L Left Hand	FRACLRTN80L	DECLLRTN80L	LINLRTN80L	BORLRTN80L

SAMPLE LAYOUT 3





Shower Door hinged to inline 1200 mm closing into Return Panel 900 mm

FRAME

DECO

LINEA

BORDER

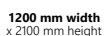
LAYOUT	Item Description				
 1200 mm width x 2100 mm height	Shower Door hinged to inline panel 1200 mm width Adjustment: 1171 - 1190 <i>Door 900 mm + Inline Panel 300 mm</i> L Left Hand OUT Opening out	FRADOR90/30LO2 ++	DECODOR90/30LO2	LINDOR90/30LO2 +	BORDOR90/30LO2 +
 900 mm width x 2100 mm height	Closing Return Panel 900mm Adjustment: 871 - 890 R Right Hand	FRACLRTN90R	DECLLRTN90R	LINLRTN90R	BORLRTN90R



**The
Collections'19**

DRENCH

INSPIRE BY DESIGN



FRAME
Collection





Fixed Panels

The ideal solution providing elegance, a pure sense of light and space to your shower.

Features:



**Patent Pending*

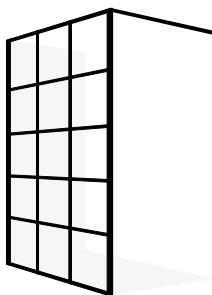

Wall Fixed Shower Panels

Wall fixed Shower Screen for Wet rooms and walk-in showers.

Please read carefully our instructions below reference to Support Bars included and possible Fixed Panel combinations.

Item Code	Specifications		Adjustment (mm)	Height (mm)	Retail Price (Exc VAT) for Clear Glass
	Item Description	LAYOUT			
FXFRA30	Fixed Panel 300 mm , Matt Black, Clear Glass Wall Fixings included.		260 - 280	2100	£ 661.38
FXFRA40	Fixed Panel 400 mm , Matt Black, Clear Glass Wall Fixings included.		360 - 380	2100	£ 752.27
FXFRA50	Fixed Panel 500 mm , Matt Black, Clear Glass Wall Fixings included.		460 - 480	2100	£ 857.39
FXFRA60	Fixed Panel 600 mm , Matt Black, Clear Glass Wall Fixings included.		560 - 580	2100	£ 962.51
FXFRA70	Fixed Panel 700 mm , Matt Black, Clear Glass Wall Fixings included.		660 - 680	2100	£ 1066.53
FXFRA80	Fixed Panel 800 mm , Matt Black, Clear Glass Wall Fixings included.		760 - 780	2100	£ 1172.56
FXFRA90	Fixed Panel 900 mm , Matt Black, Clear Glass Wall Fixings included.		860 - 880	2100	£ 1277.50
FXFRA100	Fixed Panel 1000mm , Matt Black, Clear Glass Wall Fixings included.		960 - 980	2100	£ 1405.25
FXFRA120	Fixed Panel 1200mm , Matt Black, Clear Glass Wall Fixings included.		1160 - 1180	2100	£ 1607.83
FXFRA140	Fixed Panel 1400mm , Matt Black, Clear Glass Wall Fixings included.		1360 - 1380	2100	£ 1811.31

Please NOTE

***Glass Options** available: FLUTED, GREY TINTED or FROSTED glass available **plus additional 30% to prices shown.**
Please see page 5 for further detail on our glass.

*All RAL colours are available **plus additional 30% to prices shown.**

*When both RAL colour and Glass option chosen please add 50% to prices shown.

Accessories



FXFRANGL

Angle Support Bar

Fixed panels from 500 - 700 mm width

Included in prices above

Maximum length of bar 450 mm.

(3 parts not pre-assembled)



FXFRACRS

Support Bar Across

Fixed panels from 800 - 1400 mm width

Included in prices above

Standard length 1000 mm.

(3 parts not pre-assembled)

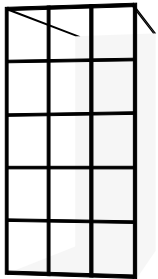

Free Standing Shower Panels

Free standing Shower Screen for Wet rooms and walk-in showers.
2 Support bars included on price.

Item Code	Specifications		Adjustment (mm)	Height (mm)	Retail Price (Exc VAT) for Clear Glass
	Item Description	LAYOUT			
FXFRA80FST	Fixed Panel 800 mm , Matt Black, Clear Glass 2 Support Bars included.		-	2100	£ 1172.56
FXFRA90FST	Fixed Panel 900 mm , Matt Black, Clear Glass 2 Support Bars included.		-	2100	£ 1277.50
FXFRA100FST	Fixed Panel 1000mm , Matt Black, Clear Glass 2 Support Bars included.		-	2100	£ 1405.25
FXFRA120FST	Fixed Panel 1200mm , Matt Black, Clear Glass 2 Support Bars included.		-	2100	£ 1607.83
FXFRA140FST	Fixed Panel 1400mm , Matt Black, Clear Glass 2 Support Bars included.		-	2100	£ 1811.31

Please NOTE

***Glass Options** available: FLUTED, GREY TINTED or FROSTED glass available **plus additional 30% to prices shown.**
Please see page 5 for further detail on our glass.

*All RAL colours are available **plus additional 30% to prices shown.**

*When both RAL colour and Glass option chosen please add 50% to prices shown.

Accessories

Standard Support Bar Across - **2 X FXFRACRS**
Included in prices above.

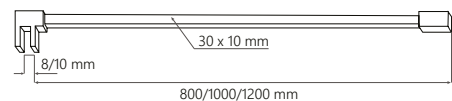

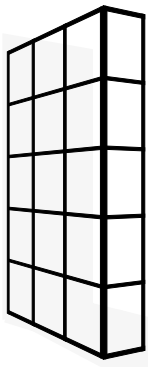

Wall Fixed Panels with Flipper Panel

Wall fixed Shower Screen for Wet rooms and walk-in showers with Flipper panel.

Flipper panel is already assembled to the fixed panel. The pivot mechanism is adjustable from 0 degree position. **Please note this item is Handed so Left or Right Hand need to be specified.**

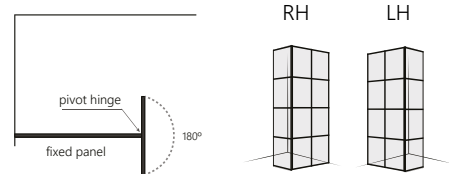

Item Code	Specifications		Adjustment (mm)	Height (mm)	Retail Price (Exc VAT) for Clear Glass	
	Item Description	LH				RH
FXFRA30FLIPL FXFRA30FLIPR	Fixed Panel 300mm with Flipper Panel 300mm L Left Hand / R Right Hand Matt Black, Clear Glass. Wall Fixings included.			560 - 580	2100	£ 1029.05
FXFRA40FLIPL FXFRA40FLIPR	Fixed Panel 400mm with Flipper Panel 300mm L Left Hand / R Right Hand Matt Black, Clear Glass. Wall Fixings included.			660 - 680	2100	£ 1124.50
FXFRA50FLIPL FXFRA50FLIPR	Fixed Panel 500mm with Flipper Panel 300mm L Left Hand / R Right Hand Matt Black, Clear Glass. Wall Fixings included.			760 - 780	2100	£ 1234.90
FXFRA60FLIPL FXFRA60FLIPR	Fixed Panel 600mm with Flipper Panel 300mm L Left Hand / R Right Hand Matt Black, Clear Glass. Wall Fixings included.			860 - 880	2100	£ 1345.30
FXFRA70FLIPL FXFRA70FLIPR	Fixed Panel 700mm with Flipper Panel 300mm L Left Hand / R Right Hand Matt Black, Clear Glass. Wall Fixings included.			960 - 980	2100	£ 1454.55
FXFRA80FLIPL FXFRA80FLIPR	Fixed Panel 800mm with Flipper Panel 300mm L Left Hand / R Right Hand Matt Black, Clear Glass. Wall Fixings included.			1060 - 1080	2100	£1496.91
FXFRA90FLIPL FXFRA90FLIPR	Fixed Panel 900mm with Flipper Panel 300mm L Left Hand / R Right Hand Matt Black, Clear Glass. Wall Fixings included.			1160 - 1180	2100	£ 1676.13
FXFRA100FLIPL FXFRA100FLIPR	Fixed Panel 1000mm with Flipper Panel 300mm L Left Hand / R Right Hand Matt Black, Clear Glass. Wall Fixings included.			1260 - 1280	2100	£ 1810.28
FXFRA120FLIPL FXFRA120FLIPR	Fixed Panel 1200mm with Flipper Panel 300mm L Left Hand / R Right Hand Matt Black, Clear Glass. Wall Fixings included.			1460 - 1480	2100	£ 2023.03
FXFRA140FLIPL FXFRA140FLIPR	Fixed Panel 1400mm with Flipper Panel 300mm L Left Hand / R Right Hand Matt Black, Clear Glass. Wall Fixings included.			1660 - 1680	2100	£ 2236.75

Please NOTE

***Glass Options** available: FLUTED, GREY TINTED or FROSTED glass available **plus additional 30% to prices shown.** Please see page 5 for further detail on our glass.

*All RAL colours are available **plus additional 30% to prices shown.**

*When both RAL colour and Glass option chosen please add 50% to prices shown.

Accessories



FXFRANGL

Angle Support Bar

Fixed panels from 500 - 700 mm width
Included in prices above
Maximum length of bar 450 mm.
(3 parts not pre-assembled)



FXFRACRS

Support Bar Across

Fixed panels from 800 - 1400 mm width
Included in prices above
Standard length 1000 mm.
(3 parts not pre-assembled)

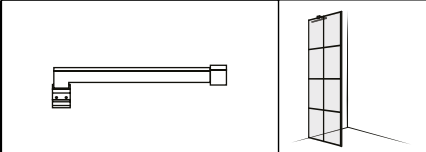
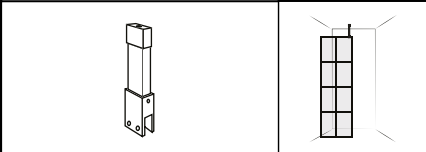
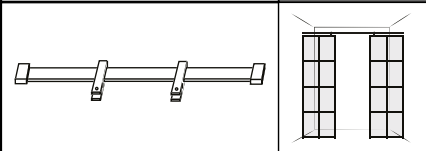
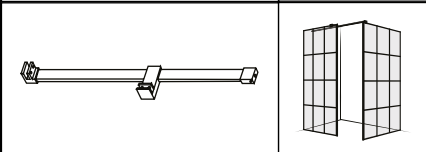

Support Bars

Standard fixed panels include Support bar Across however there are some more options available. Please note support bars below are not suitable for every unit.

Item Code	Specifications		Retail Price (Exc VAT)
	Item Description	LAYOUT	
FXFRANGL	90° Angled support bar. <i>Not preassembled, 3 pieces + fixings.</i> Bar: 30 x 10 mm Length: 350 mm Not suitable for Panels wider than 1000 mm.		+£ 0* <i>*To be specified when order is placed.</i>
FXFRACLN	Ceiling support bar. <i>Not preassembled, 3 pieces + fixings.</i> Bar: 30 x 10 mm Length: 350 mm Not suitable for Panels wider than 1000 mm.		+£ 0* <i>*To be specified when order is placed.</i>
FXFRAPRL2	Parallel support bar. <i>Not preassembled, 3 pieces + fixings.</i> Bar: 30 x 10 mm Length: Max 2000 mm. <i>To be specified on order.</i> Suitable for 2 panels.		+£45.63* <i>*To be specified when order is placed.</i>
FXFRADBL	Return panel support bar. <i>Not preassembled, 3 pieces + fixings.</i> Bar: 30 x 10 mm Length: Max 2000 mm. <i>To be specified on order.</i> Suitable for 2 panels.		+£45.63* <i>*To be specified when order is placed.</i>

Fixed panels Accesories

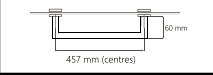
Standard fixed panels include Support bar Across however there are some more options available. Please note support bars below are not suitable for every unit.

Item Code	Specifications		Retail Price (Exc VAT)
	Item Description	LAYOUT	
VHAND1	Single towel holder for fixed Panels. 457 mm width / 60 mm projection.		+£ 124.17* <i>*To be specified when order is placed.</i>
VHAND2	Double towel holder for fixed Panels. 457 mm width / 60 mm projection.		

For any further enquiries feel free to contact our Sales team, we will be delighted to help. Please email us at sales@drenchshowers.co.uk

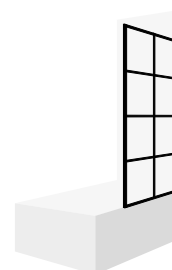

Right Hand

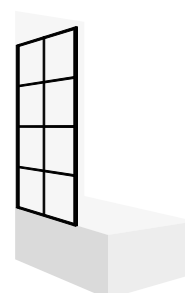

Left Hand

Bath Screen

A reduced size version of our product for those ones who love enjoying a bath. Both pivot and fixed bath screen options available.

Item Code	Specifications		Adjustment (mm)	Height (mm)	Retail Price (Exc VAT) for Clear Glass
	Item Description	LAYOUT			
FRAFxBAT	Fixed Bath Screen 800 mm , Matt Black, Clear Glass Wall fixing included.		760 - 780	1500	£ 789.50
FRABATL	Fixed Bath Screen 800 mm , Matt Black, Clear Glass Wall fixing included.		760 - 780	1500	£ 836.58
FRABATR	Fixed Bath Screen 800 mm , Matt Black, Clear Glass Wall fixing included.		760 - 780	1500	£ 836.58

Please NOTE

*Glass Options available: FLUTED, GREY TINTED or FROSTED glass available **plus additional 30% to prices shown.**

Please see page 5 for further detail on our glass.

*All RAL colours are available **plus additional 30% to prices shown.**

*When both RAL colour and Glass option chosen please add 50% to prices shown.

Features:



*Patent Pending

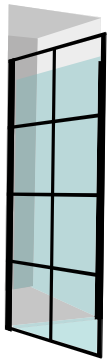

Left Hand
Opening **OUT**

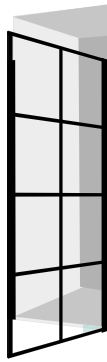

Right Hand
Opening **OUT**

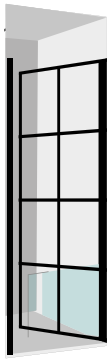

Right Hand
Opening **IN**

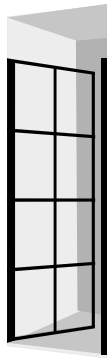

Left Hand
Opening **IN**



Single Shower Doors

DRENCH shower doors are both robust and sophisticated. Our pivot mechanism is manufactured using zinc die castings which give a durable and strong door performance. The magnetic closing post creates a secure seal after the shower door is closed. Pull handle and towel holder accessories are available to complete the item.

Features:



*Patent Pending

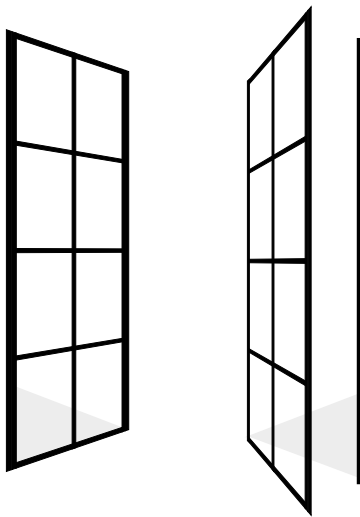

Single Shower Doors

Shower Door Left or Right Handed

Door is hinged to wall and both left and right hand options available. Code ending in L, means hinge on the Left and code ending in R, means hinge on the right.

Fixings, seals and every component of our standard shower door range is finished in **Matt Black**.

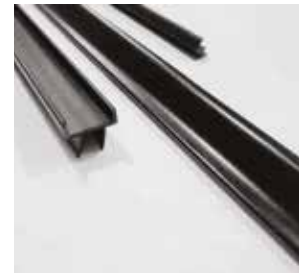

Item Code	Specifications			Adjustment Range		Height (mm)	Retail Price (Exc VAT)
	Item Description	LH	RH	RECESS	WITH RETURN PANEL		
FRADOR70LI FRADOR70LO FRADOR70RI FRADOR70RO	Shower Door for 700 mm width L Left Hand / R Right Hand I Opening in / O Opening out			661 - 699	661 - 699	2100	£ 1079.67
FRADOR76LI FRADOR76LO FRADOR76RI FRADOR76RO	Shower Door for 760 mm width L Left Hand / R Right Hand I Opening in / O Opening out			721 - 759	721 - 759	2100	£ 1175.67
FRADOR80LI FRADOR80LO FRADOR80RI FRADOR80RO	Shower Door for 800 mm width L Left Hand / R Right Hand I Opening in / O Opening out			761 - 799	761 - 799	2100	£ 1231.88
FRADOR90LI FRADOR90LO FRADOR90RI FRADOR90RO	Shower Door for 900 mm width L Left Hand / R Right Hand I Opening in / O Opening out			861 - 899	861 - 899	2100	£ 1387.00

Please NOTE

***Glass Options** available: FLUTED, GREY TINTED or FROSTED glass available **plus additional 30% to prices shown.**

Please see page 5 for further detail on our glass.

*All RAL colours are available **plus additional 30% to prices shown.**

*When both RAL colour and Glass option chosen please add 50% to prices shown.

Please check Adjustment range shown above before ordering. DRENCH is not liable for different dimensions on site.

Accessories

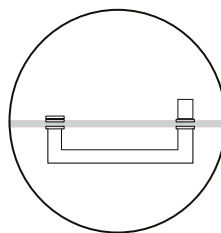

Handle Outside & Knob Inside
Included in prices above.

Shower doors bring horizontal square handle 25 x 10 mm, 457 mm width and 60 mm projection.

Suitable to be used as towel holder in the outside with knob in the inside.

For any further enquiries feel free to contact our Sales team, we will be delighted to help. Please email us at sales@drenchshowers.co.uk

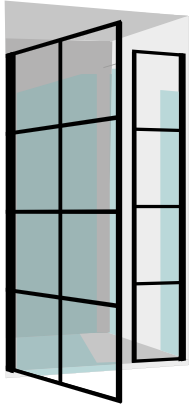

Left Hand
Opening **OUT**

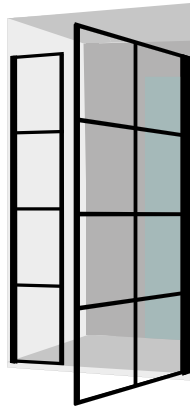

Right Hand
Opening **OUT**

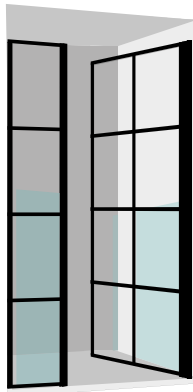

Right Hand
Opening **IN**

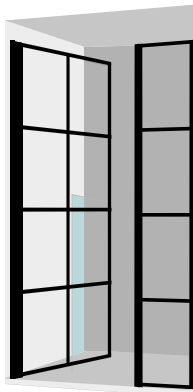

Left Hand
Opening **IN**



Shower Door with **Inline Panel**

Drench recess shower solutions include a range of complimentary inline panels. Our standard range is carefully designed to keep the grid pattern balanced which is of paramount importance within our collection. The product is completed with a support bar which gives stability and durability to the enclosure. BESPOKE sizes are available, contact us for further information.

Features:



*Patent Pending

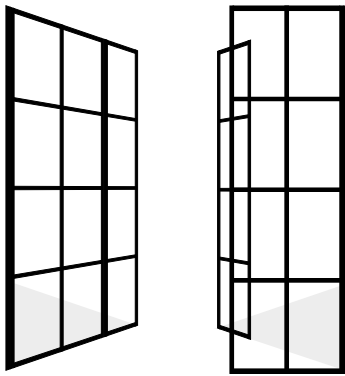

Shower Door with Inline Panel

Door is hinged to wall closing into an Inline Panel.
Both left and right hand options available. Code ending in L, means hinge on the Left and code ending in R, means hinge on the right.
Fixings, seals and every component of our standard shower door range is finished in Matt Black.
Please Adjustment range shown above before ordering. DRENCH is not liable for different dimensions on site.

Item Code	Specifications			Adjustment Range		Height (mm)	Retail Price (Exc VAT)
	Item Description	LH	RH	RECESS	WITH RETURN PANEL		
FRADOR70/20L1 FRADOR70/20LO1 FRADOR70/20R1 FRADOR70/20RO1	Shower Door for with inline Panel for a 900 mm width <i>Door 700 mm + Inline Panel 200 mm</i> L Left Hand / R Right Hand I Opening in / O Opening out			861 - 899	871 - 890	2100	£ 1389.56
FRADOR70/30L1 FRADOR70/30LO1 FRADOR70/30R1 FRADOR70/30RO1	Shower Door for with inline Panel for a 1000 mm width <i>Door 700 mm + Inline Panel 300 mm</i> L Left Hand / R Right Hand I Opening in / O Opening out			961 - 999	971 - 990	2100	£ 1615.13
FRADOR90/30L1 FRADOR90/30LO1 FRADOR90/30R1 FRADOR90/30RO1	Shower Door for with inline Panel for a 1200 mm width <i>Door 900 mm + Inline Panel 300 mm</i> L Left Hand / R Right Hand I Opening in / O Opening out			1161 - 1199	1171 - 1190	2100	£ 1886.69
FRADOR70/70L1 FRADOR70/70LO1 FRADOR70/70R1 FRADOR70/70RO1	Shower Door for with inline Panel for a 1400 mm width <i>Door 700 mm + Inline Panel 700 mm</i> L Left Hand / R Right Hand I Opening in / O Opening out			1361 - 1399	1371 - 1390	2100	£ 2393.67
FRADOR90/60L1 FRADOR90/60LO1 FRADOR90/60R1 FRADOR90/60RO1	Shower Door for with inline Panel for a 1500 mm width <i>Door 900 mm + Inline Panel 600 mm</i> L Left Hand / R Right Hand I Opening in / O Opening out			1461 - 1499	1471 - 1490	2100	£ 2551.35
FRADOR90/70L1 FRADOR90/70LO1 FRADOR90/70R1 FRADOR90/70RO1	Shower Door for with inline Panel for a 1600 mm width <i>Door 900 mm + Inline Panel 700 mm</i> L Left Hand / R Right Hand I Opening in / O Opening out			1561 - 1599	1571 - 1590	2100	£ 2691.51

Accessories

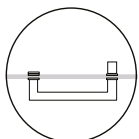

Handle Outside & Knob Inside

Included in prices above.
Shower doors bring horizontal square handle 25 x 10 mm, 457 mm width and 60 mm projection.
Suitable to be used as towel holder in the outside with knob in the inside.

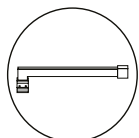

Angle Support Bar

Included in prices above.
Support bar for units narrower than 1200 mm.
Maximum length of bar 450 mm.
(3 parts, not pre-assembled)

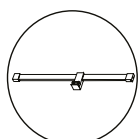

Double Support Bar

Included in prices above.
Support bar for units wider than 1200 mm.
Bar supplied at total width of unit ordered to be cut on site.
(4 parts, not pre-assembled)

Please NOTE

***Glass Options** available: FLUTED, GREY TINTED or FROSTED glass available **plus additional 30% to prices shown.**
Please see page 5 for further detail on our glass.

*All RAL colours are available **plus additional 30% to prices shown.**

*When both RAL colour and Glass option chosen please add 50% to prices shown.

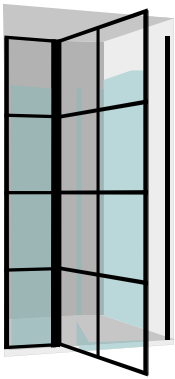

Left Hand
Opening **OUT**

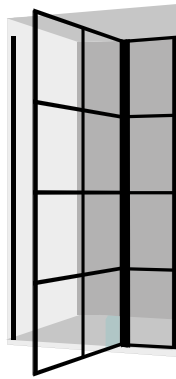

Right Hand
Opening **OUT**

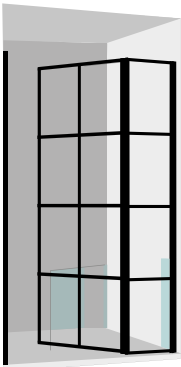

Right Hand
Opening **IN**

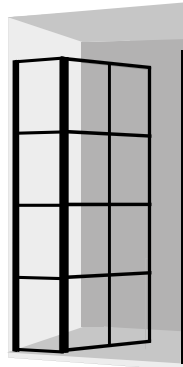

Left Hand
Opening **IN**



Shower Door hinged to **Inline Panel**

Drench recess shower solutions include a range of complimentary inline panels. Our standard range is carefully designed to keep the grid pattern balanced which is of paramount importance within our collection. The product is completed with a support bar which gives stability and durability to the enclosure. BESPOKE sizes are available, contact us for further information.

Features:



*Patent Pending

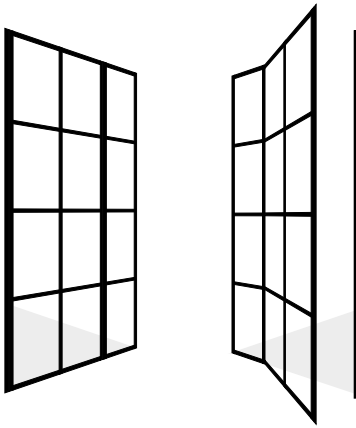









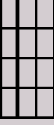

Shower Door

hinged to Inline Panel

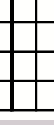
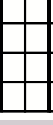
Door is hinged to an Inline panel closing into a our closing profile in the wall. Both **left and right hand options available**. Code ending in L, means hinge on the Left and code ending in R, means hinge on the right.

Fixings, seals and every component of our standard shower door range is finished in **Matt Black**.

Please Adjustment range shown above before ordering. DRENCH is not liable for different dimensions on site.

Item Code	Specifications			Adjustment Range		Height (mm)	Retail Price (Exc VAT)
	Item Description	LH	RH	RECESS	WITH RETURN PANEL		
FRADOR70/20LI2 FRADOR70/20LO2 FRADOR70/20RI2 FRADOR70/20RO2	Shower Door for hinged to Inline Panel for a 900 mm width <i>Door 700 mm + Inline Panel 200 mm</i> L Left Hand / R Right Hand I Opening in / O Opening out			861 - 899	871 - 890	2100	£ 1389.56
FRADOR70/30LI2 FRADOR70/30LO2 FRADOR70/30RI2 FRADOR70/30RO2	Shower Door for hinged to Inline Panel for a 1000 mm width <i>Door 700 mm + Inline Panel 300 mm</i> L Left Hand / R Right Hand I Opening in / O Opening out			961 - 999	971 - 990	2100	£ 1615.13
FRADOR90/30LI2 FRADOR90/30LO2 FRADOR90/30RI2 FRADOR90/30RO2	Shower Door for hinged to Inline Panel for a 1200 mm width <i>Door 900 mm + Inline Panel 300 mm</i> L Left Hand / R Right Hand I Opening in / O Opening out			1161 - 1199	1171 - 1190	2100	£ 1886.69
FRADOR70/70LI2 FRADOR70/70LO2 FRADOR70/70RI2 FRADOR70/70RO2	Shower Door for hinged to Inline Panel for a 1400 mm width <i>Door 700 mm + Inline Panel 700 mm</i> L Left Hand / R Right Hand I Opening in / O Opening out			1361 - 1399	1371 - 1390	2100	£ 2393.67
FRADOR90/60LI2 FRADOR90/60LO2 FRADOR90/60RI2 FRADOR90/60RO2	Shower Door for hinged to Inline Panel for a 1500 mm width <i>Door 900 mm + Inline Panel 600 mm</i> L Left Hand / R Right Hand I Opening in / O Opening out			1461 - 1499	1471 - 1490	2100	£ 2551.35
FRADOR90/70LI2 FRADOR90/70LO2 FRADOR90/70RI2 FRADOR90/70RO2	Shower Door for hinged to Inline Panel for a 1600 mm width <i>Door 900 mm + Inline Panel 700 mm</i> L Left Hand / R Right Hand I Opening in / O Opening out			1561 - 1599	1571 - 1590	2100	£ 2691.51

Accessories

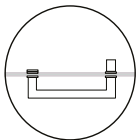

Handle Outside & Knob Inside

Included in prices above.

Shower doors bring horizontal square handle 25 x 10 mm, 457 mm width and 60 mm projection.

Suitable to be used as towel holder in the outside with knob in the inside.

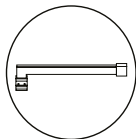

Angle Support Bar

Included in prices above.

Support bar for units narrower than 1200 mm.

Maximum length of bar 450 mm.

(3 parts, not pre-assembled)

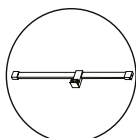

Double Support Bar

Included in prices above.

Support bar for units wider than 1200 mm.

Bar supplied at total width of unit ordered to be cut on site.

(4 parts, not pre-assembled)

Please NOTE

***Glass Options** available: FLUTED, GREY TINTED or FROSTED glass available **plus additional 30% to prices shown**.

Please see page 5 for further detail on our glass.

*All RAL colours are available **plus additional 30% to prices shown**.

*When both RAL colour and Glass option chosen please add 50% to prices shown.

Return Panels for Shower Enclosures

DRENCH doors may be paired with a range of return panels to create shower cubicles. Available in both, door closing onto return and door hinge from return.



Return panel configurations

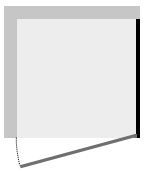

Right Hand
Return Panel for
Shower Door

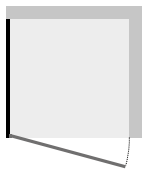

Left Hand
Return Panel for
Shower Door

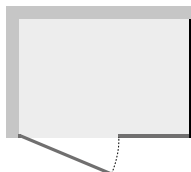

Right Hand
Return Panel for
Shower Door
with Inline panel

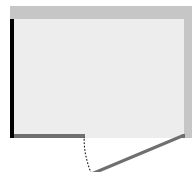

Left Hand
Return Panel for
Shower Door
with Inline panel

Closing Return panel configurations

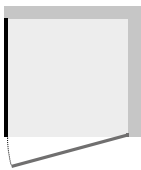

Left Hand
Closing Return
Panel for Shower
Door

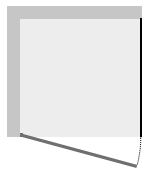

Right Hand
Closing Return
Panel for Shower
Door

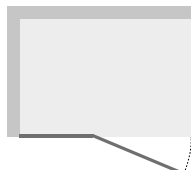

Right Hand
Closing Return
Panel for Shower
Door hinged to
Inline panel

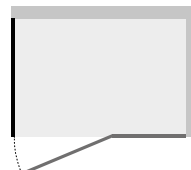

Left Hand
Closing Return
Panel for Shower
Door hinged to
Inline panel

Please NOTE

*Support Bar for Return Panel included on prices shown.

*Return panels shown are suitable for Opening **OUTWARDS** configurations **ONLY**.

For opening inwards please contact us.

***Glass Options** available: FLUTED, GREY TINTED or FROSTED glass available **plus additional 30% to prices shown.**

Please see page 5 for further detail on our glass.

*All RAL colours are available **plus additional 30% to prices shown.**

*When both RAL colour and Glass option chosen please add 50% to prices shown.

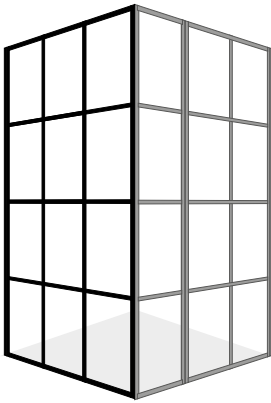

Return

Panel for Shower Enclosures

Suitable for **Door with Inline Panel and Shower doors closing on to the wall.**
Items below bring wall fixings and corner post included.

Please note Return panels are always sold as part of an enclosure; to be installed with **Shower doors, shower doors with inline or shower doors hinged to inline.**
Please note the **Adjustment** before ordering. We manufacture our Shower Enclosures to fit standard Shower tray sizes and any wet room configuration.

Item Code	Specifications		Adjustment (mm)	Height (mm)	Retail Price (Exc VAT) for Clear Glass
	Item Description	LAYOUT			
FRARTN70L FRARTN70R	Return Panel 700 mm width Wall fixing and Corner post included. L Left Hand / R Right Hand		664 - 693	2100	£ 785.12
FRARTN80L FRARTN80R	Return Panel 800 mm width Wall fixing and Corner post included. L Left Hand / R Right Hand		764 - 793	2100	£ 824.54
FRARTN90L FRARTN90R	Return Panel 900 mm width Wall fixing and Corner post included. L Left Hand / R Right Hand		864 - 893	2100	£ 891.33
FRARTN100L FRARTN100R	Return Panel 1000 mm width Wall fixing and Corner post included. L Left Hand / R Right Hand		964 - 993	2100	£ 990.98

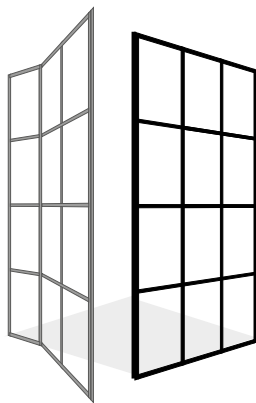

Closing Return

Panel for Shower Enclosures

Suitable for **Door hanging from Inline Panel and Shower doors closing on to a return panel.** Return panels below bring closing post preassembled in one side of the screen.

Please note Return panels are always sold as part of an enclosure; to be installed with **Shower doors, shower doors with inline or shower doors hinged to inline.**
Please note the **Adjustment** before ordering. We manufacture our Shower Enclosures to fit standard Shower tray sizes and any wet room configuration.

Item Code	Specifications		Adjustment (mm)	Height (mm)	Retail Price (Exc VAT) for Clear Glass
	Item Description	LAYOUT			
FRACLRTN70L FRACLRTN70R	Return Panel with closing post 700mm width Wall fixings included. L Left Hand / R Right Hand		671 - 690	2100	£ 785.12
FRACLRTN80L FRACLRTN80R	Return Panel with closing post 800mm width Wall fixings included. L Left Hand / R Right Hand		771 - 790	2100	£ 824.54
FRACLRTN90L FRACLRTN90R	Return Panel with closing post 900mm width Wall fixings included. L Left Hand / R Right Hand		871 - 890	2100	£ 891.33
FRACLRTN100L FRACLRTN100R	Return Panel with closing post 1000mm width Wall fixings included. L Left Hand / R Right Hand		971 - 990	2100	£ 990.98

DRENCH

INSPIRE BY DESIGN





DECO 
Collection



Fixed Panels

The ideal solution providing elegance, a pure sense of light and space to your shower.

Features:



*Patent Pending

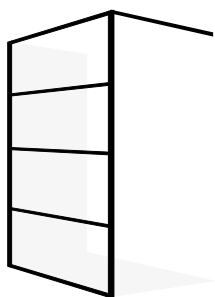

Wall Fixed Shower Panels

Wall fixed Shower Screen for Wet rooms and walk-in showers.

Please read carefully our instructions below reference to Support Bars included and possible Fixed Panel combinations.

Item Code	Specifications		Adjustment (mm)	Height (mm)	Retail Price (Exc VAT) for Clear Glass
	Item Description	LAYOUT			
FXDEC30	Fixed Panel 300 mm , Matt Black, Clear Glass Wall Fixings included.		260 - 280	2100	£ 517.00
FXDEC40	Fixed Panel 400 mm , Matt Black, Clear Glass Wall Fixings included.		360 - 380	2100	£ 558.00
FXDEC50	Fixed Panel 500 mm , Matt Black, Clear Glass Wall Fixings included.		460 - 480	2100	£ 600.00
FXDEC60	Fixed Panel 600 mm , Matt Black, Clear Glass Wall Fixings included.		560 - 580	2100	£ 642.00
FXDEC70	Fixed Panel 700 mm , Matt Black, Clear Glass Wall Fixings included.		660 - 680	2100	£ 684.00
FXDEC80	Fixed Panel 800 mm , Matt Black, Clear Glass Wall Fixings included.		760 - 780	2100	£ 870.00
FXDEC90	Fixed Panel 900 mm , Matt Black, Clear Glass Wall Fixings included.		860 - 880	2100	£ 920.00
FXDEC100	Fixed Panel 1000mm , Matt Black, Clear Glass Wall Fixings included.		960 - 980	2100	£ 970.00
FXDEC120	Fixed Panel 1200mm , Matt Black, Clear Glass Wall Fixings included.		1160 - 1180	2100	£ 1050.00
FXDEC140	Fixed Panel 1400mm , Matt Black, Clear Glass Wall Fixings included.		1360 - 1380	2100	£ 1150.00

Please NOTE

***Glass Options** available: FLUTED, GREY TINTED or FROSTED glass available **plus additional 30% to prices shown.**
Please see page 5 for further detail on our glass.

*All RAL colours are available **plus additional 30% to prices shown.**

*When both RAL colour and Glass option chosen please add 50% to prices shown.

Accessories



FXSBNGL

Angle Support Bar

Fixed panels from 500 - 700 mm width

Included in prices above

Maximum length of bar 450 mm.

(3 parts not pre-assembled)



FXSBCRS

Support Bar Across

Fixed panels from 800 - 1400 mm width

Included in prices above

Standard length 1000 mm.

(3 parts not pre-assembled)

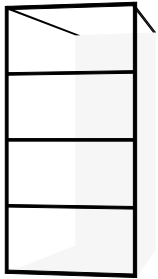

Free Standing Shower Panels

Free standing Shower Screen for Wet rooms and walk-in showers.
2 Support bars included on price.

Item Code	Specifications		Adjustment (mm)	Height (mm)	Retail Price (Exc VAT) for Clear Glass
	Item Description	LAYOUT			
FXDEC80FST	Fixed Panel 800 mm , Matt Black, Clear Glass 2 Support Bars included.		-	2100	£ 870.00
FXDEC90FST	Fixed Panel 900 mm , Matt Black, Clear Glass 2 Support Bars included.		-	2100	£ 920.00
FXDEC100FST	Fixed Panel 1000mm , Matt Black, Clear Glass 2 Support Bars included.		-	2100	£ 970.00
FXDEC120FST	Fixed Panel 1200mm , Matt Black, Clear Glass 2 Support Bars included.		-	2100	£ 1050.00
FXDEC140FST	Fixed Panel 1400mm , Matt Black, Clear Glass 2 Support Bars included.		-	2100	£ 1150.00

Please NOTE

***Glass Options** available: FLUTED, GREY TINTED or FROSTED glass available **plus additional 30% to prices shown.**
Please see page 5 for further detail on our glass.

*All RAL colours are available **plus additional 30% to prices shown.**

*When both RAL colour and Glass option chosen please add 50% to prices shown.

Accessories

Standard Support Bar Across - **2 X FXSBCRS**
Included in prices above.

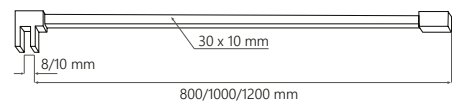

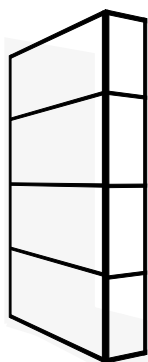

Wall Fixed Panels with Flipper Panel

Wall fixed Shower Screen for Wet rooms and walk-in showers with Flipper panel.

Flipper panel is already assembled to the fixed panel. The pivot mechanism is adjustable from 0 degree position. **Please note this item is Handed so Left or Right Hand need to be specified.**

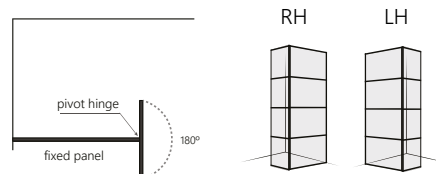

Item Code	Specifications		Adjustment (mm)	Height (mm)	Retail Price (Exc VAT) for Clear Glass	
	Item Description	LH				RH
FXDEC30FLIPL FXDEC30FLIPR	Fixed Panel 300mm with Flipper Panel 300mm L Left Hand / R Right Hand Matt Black, Clear Glass. Wall Fixings included.			560 - 580	2100	£ 825.28
FXDEC40FLIPL FXDEC40FLIPR	Fixed Panel 400mm with Flipper Panel 300mm L Left Hand / R Right Hand Matt Black, Clear Glass. Wall Fixings included.			660 - 680	2100	£ 866.28
FXDEC50FLIPL FXDEC50FLIPR	Fixed Panel 500mm with Flipper Panel 300mm L Left Hand / R Right Hand Matt Black, Clear Glass. Wall Fixings included.			760 - 780	2100	£ 908.28
FXDEC60FLIPL FXDEC60FLIPR	Fixed Panel 600mm with Flipper Panel 300mm L Left Hand / R Right Hand Matt Black, Clear Glass. Wall Fixings included.			860 - 880	2100	£ 950.28
FXDEC70FLIPL FXDEC70FLIPR	Fixed Panel 700mm with Flipper Panel 300mm L Left Hand / R Right Hand Matt Black, Clear Glass. Wall Fixings included.			960 - 980	2100	£ 992.28
FXDEC80FLIPL FXDEC80FLIPR	Fixed Panel 800mm with Flipper Panel 300mm L Left Hand / R Right Hand Matt Black, Clear Glass. Wall Fixings included.			1060 - 1080	2100	£ 1178.28
FXDEC90FLIPL FXDEC90FLIPR	Fixed Panel 900mm with Flipper Panel 300mm L Left Hand / R Right Hand Matt Black, Clear Glass. Wall Fixings included.			1160 - 1180	2100	£ 1228.28
FXDEC100FLIPL FXDEC100FLIPR	Fixed Panel 1000mm with Flipper Panel 300mm L Left Hand / R Right Hand Matt Black, Clear Glass. Wall Fixings included.			1260 - 1280	2100	£ 1278.28
FXDEC120FLIPL FXDEC120FLIPR	Fixed Panel 1200mm with Flipper Panel 300mm L Left Hand / R Right Hand Matt Black, Clear Glass. Wall Fixings included.			1460 - 1480	2100	£ 1358.28
FXDEC140FLIPL FXDEC140FLIPR	Fixed Panel 1400mm with Flipper Panel 300mm L Left Hand / R Right Hand Matt Black, Clear Glass. Wall Fixings included.			1660 - 1680	2100	£ 1458.28

Please NOTE

***Glass Options** available: FLUTED, GREY TINTED or FROSTED glass available **plus additional 30% to prices shown.** Please see page 5 for further detail on our glass.

*All RAL colours are available **plus additional 30% to prices shown.**

*When both RAL colour and Glass option chosen please add 50% to prices shown.

Accessories



FXSBNGL

Angle Support Bar

Fixed panels from 500 - 700 mm width
Included in prices above
Maximum length of bar 450 mm.
(3 parts not pre-assembled)



FXSBCRS

Support Bar Across

Fixed panels from 800 - 1400 mm width
Included in prices above
Standard length 1000 mm.
(3 parts not pre-assembled)

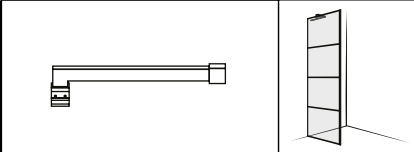
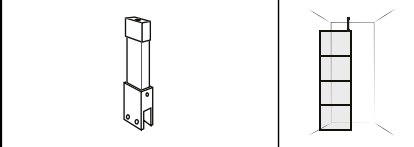
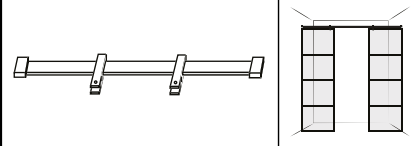
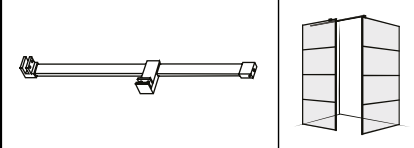

Support Bars

Standard fixed panels include Support bar Across however there are some more options available. Please note support bars below are not suitable for every unit.

Item Code	Specifications		Retail Price (Exc VAT)
	Item Description	LAYOUT	
FXSBNGL	90° Angled support bar. <i>Not preassembled, 3 pieces + fixings.</i> Bar: 30 x 10 mm Length: 350 mm Not suitable for Panels wider than 1000 mm.		+£ 0* <i>*To be specified when order is placed.</i>
FXSBCLN	Ceiling support bar. <i>Not preassembled, 3 pieces + fixings.</i> Bar: 30 x 10 mm Length: 350 mm Not suitable for Panels wider than 1000 mm.		+£ 0* <i>*To be specified when order is placed.</i>
FXSBPRL2	Parallel support bar. <i>Not preassembled, 3 pieces + fixings.</i> Bar: 30 x 10 mm Length: Max 2000 mm. <i>To be specified on order.</i> Suitable for 2 panels.		+£ 45.83* <i>*To be specified when order is placed.</i>
FXSBDBL	Return panel support bar. <i>Not preassembled, 3 pieces + fixings.</i> Bar: 30 x 10 mm Length: Max 2000 mm. <i>To be specified on order.</i> Suitable for 2 panels.		+£ 45.83* <i>*To be specified when order is placed.</i>

Fixed panels Accesories

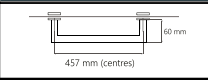
Standard fixed panels include Support bar Across however there are some more options available. Please note support bars below are not suitable for every unit.

Item Code	Specifications		Retail Price (Exc VAT)
	Item Description	LAYOUT	
VHAND1	Single towel holder for fixed Panels. 457 mm width / 60 mm projection.		+£124.17* <i>*To be specified when order is placed.</i>
VHAND2	Double towel holder for fixed Panels. 457 mm width / 60 mm projection.		

For any further enquiries feel free to contact our Sales team, we will be delighted to help. Please email us at sales@drenchshowers.co.uk

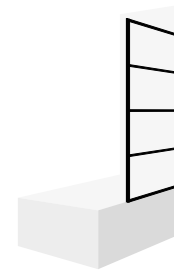

Right Hand

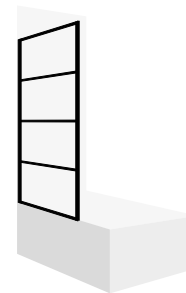

Left Hand

Bath Screen

A reduced size version of our product for those ones who love enjoying a bath. Both pivot and fixed bath screen options available.

Item Code	Specifications		Adjustment (mm)	Height (mm)	Retail Price (Exc VAT) for Clear Glass
	Item Description	LAYOUT			
DECFXBAT	Fixed Bath Screen 800 mm , Matt Black, Clear Glass Wall fixing included.		760 - 780	1500	£ 585.00
DECBATL	Fixed Bath Screen 800 mm , Matt Black, Clear Glass Wall fixing included.		760 - 780	1500	£ 621.42
DECBATR	Fixed Bath Screen 800 mm , Matt Black, Clear Glass Wall fixing included.		760 - 780	1500	£ 621.42

Please NOTE

***Glass Options** available: FLUTED, GREY TINTED or FROSTED glass available **plus additional 30% to prices shown.**

Please see page 5 for further detail on our glass.

*All RAL colours are available **plus additional 30% to prices shown.**

*When both RAL colour and Glass option chosen please add 50% to prices shown.

Features:



*Patent Pending

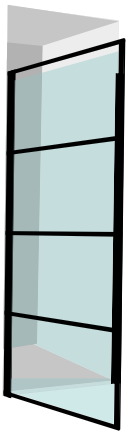

Left Hand
Opening **OUT**



Right Hand
Opening **OUT**

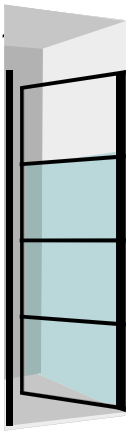

Right Hand
Opening **IN**

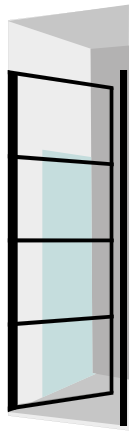

Left Hand
Opening **IN**



Single Shower Doors

DRENCH shower doors are both robust and sophisticated. Our pivot mechanism is manufactured using zinc die castings which give a durable and strong door performance. The magnetic closing post creates a secure seal after the shower door is closed. Pull handle and towel holder accessories are available to complete the item.

Features:



*Patent Pending

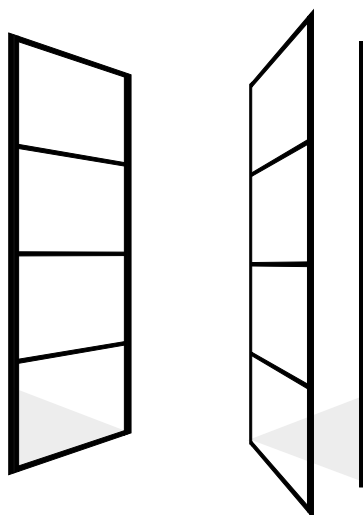

Single Shower Doors

Shower Door Left or Right Handed

Door is hinged to wall and both left and right hand options available. Code ending in L, means hinge on the Left and code ending in R, means hinge on the right.

Fixings, seals and every component of our standard shower door range is finished in **Matt Black**.

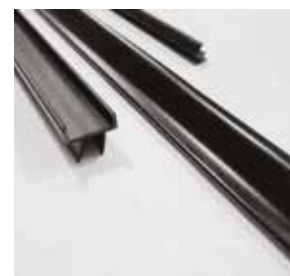

Item Code	Specifications			Adjustment Range		Height (mm)	Retail Price (Exc VAT)
	Item Description	LH	RH	RECESS	WITH RETURN PANEL		
DECDOR70LI DECDOR70LO DECDOR70RI DECDOR70RO	Shower Door for 700 mm width L Left Hand / R Right Hand I Opening in / O Opening out			661 - 699	661 - 699	2100	£ 823.33
DECDOR76LI DECDOR76LO DECDOR76RI DECDOR76RO	Shower Door for 760 mm width L Left Hand / R Right Hand I Opening in / O Opening out			721 - 759	721 - 759	2100	£ 896.67
DECDOR80LI DECDOR80LO DECDOR80RI DECDOR80RO	Shower Door for 800 mm width L Left Hand / R Right Hand I Opening in / O Opening out			761 - 799	761 - 799	2100	£ 940.83
DECDOR90LI DECDOR90LO DECDOR90RI DECDOR90RO	Shower Door for 900 mm width L Left Hand / R Right Hand I Opening in / O Opening out			861 - 899	861 - 899	2100	£ 1066.67

Please NOTE

***Glass Options** available: FLUTED, GREY TINTED or FROSTED glass available **plus additional 30% to prices shown**.

Please see page 5 for further detail on our glass.

*All RAL colours are available **plus additional 30% to prices shown**.

*When both RAL colour and Glass option chosen please add 50% to prices shown.

Please check Adjustment range shown above before ordering. DRENCH is not liable for different dimensions on site.

Accessories

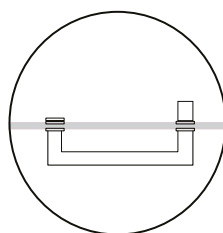

Handle Outside & Knob Inside
Included in prices above.

Shower doors bring horizontal square handle 25 x 10 mm, 457 mm width and 60 mm projection.

Suitable to be used as towel holder in the outside with knob in the inside.

For any further enquiries feel free to contact our Sales team, we will be delighted to help. Please email us at sales@drenchshowers.co.uk

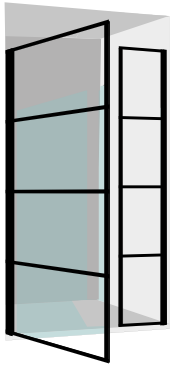

Left Hand
Opening **OUT**

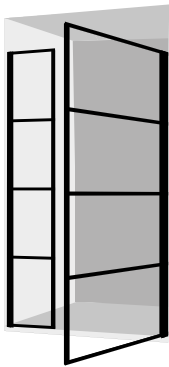

Right Hand
Opening **OUT**

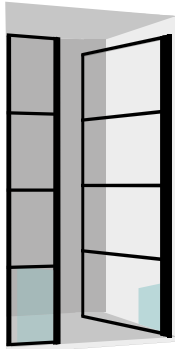

Right Hand
Opening **IN**

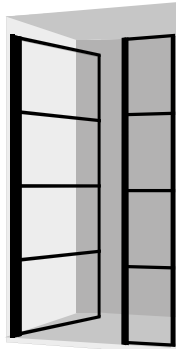

Left Hand
Opening **IN**



Shower Door with **Inline Panel**

Drench recess shower solutions include a range of complimentary inline panels. Our standard range is carefully designed to keep the grid pattern balanced which is of paramount importance within our collection. The product is completed with a support bar which gives stability and durability to the enclosure. BESPOKE sizes are available, contact us for further information.

Features:



*Patent Pending

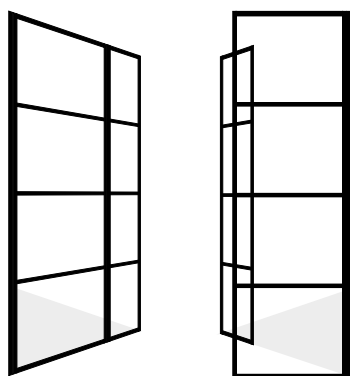

Shower Door with Inline Panel

Door is hinged to wall closing into an Inline Panel.
Both left and right hand options available. Code ending in L, means hinge on the Left and code ending in R, means hinge on the right.
Fixings, seals and every component of our standard shower door range is finished in Matt Black.
Please Adjustment range shown above before ordering. DRENCH is not liable for different dimensions on site.

Item Code	Specifications			Adjustment Range		Height (mm)	Retail Price (Exc VAT)
	Item Description	LH	RH	RECESS	WITH RETURN PANEL		
DECDOR70/20L1 DECDOR70/20LO1 DECDOR70/20R1 DECDOR70/20RO1	Shower Door for with inline Panel for a 900 mm width <i>Door 700 mm + Inline Panel 200 mm</i> L Left Hand / R Right Hand I Opening in / O Opening out			861 - 899	871 - 890	2100	£ 1067.00
DECDOR70/30L1 DECDOR70/30LO1 DECDOR70/30R1 DECDOR70/30RO1	Shower Door for with inline Panel for a 1000 mm width <i>Door 700 mm + Inline Panel 300 mm</i> L Left Hand / R Right Hand I Opening in / O Opening out			961 - 999	971 - 990	2100	£ 1232.50
DECDOR90/30L1 DECDOR90/30LO1 DECDOR90/30R1 DECDOR90/30RO1	Shower Door for with inline Panel for a 1200 mm width <i>Door 900 mm + Inline Panel 300 mm</i> L Left Hand / R Right Hand I Opening in / O Opening out			1161 - 1199	1171 - 1190	2100	£ 1449.00
DECDOR70/70L1 DECDOR70/70LO1 DECDOR70/70R1 DECDOR70/70RO1	Shower Door for with inline Panel for a 1400 mm width <i>Door 700 mm + Inline Panel 700 mm</i> L Left Hand / R Right Hand I Opening in / O Opening out			1361 - 1399	1371 - 1390	2100	£ 1850.00
DECDOR90/60L1 DECDOR90/60LO1 DECDOR90/60R1 DECDOR90/60RO1	Shower Door for with inline Panel for a 1500 mm width <i>Door 900 mm + Inline Panel 600 mm</i> L Left Hand / R Right Hand I Opening in / O Opening out			1461 - 1499	1471 - 1490	2100	£ 1995.00
DECDOR90/70L1 DECDOR90/70LO1 DECDOR90/70R1 DECDOR90/70RO1	Shower Door for with inline Panel for a 1600 mm width <i>Door 900 mm + Inline Panel 700 mm</i> L Left Hand / R Right Hand I Opening in / O Opening out			1561 - 1599	1571 - 1590	2100	£ 2060.00

Accessories

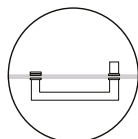

Handle Outside & Knob Inside

Included in prices above.
Shower doors bring horizontal square handle 25 x 10 mm, 457 mm width and 60 mm projection.
Suitable to be used as towel holder in the outside with knob in the inside.

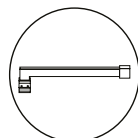

Angle Support Bar

Included in prices above.
Support bar for units narrower than 1200 mm.
Maximum length of bar 450 mm.
(3 parts, not pre-assembled)

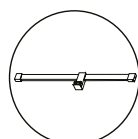

Double Support Bar

Included in prices above.
Support bar for units wider than 1200 mm.
Bar supplied at total width of unit ordered to be cut on site.
(4 parts, not pre-assembled)

Please NOTE

***Glass Options** available: FLUTED, GREY TINTED or FROSTED glass available **plus additional 30% to prices shown.**
Please see page 5 for further detail on our glass.

*All RAL colours are available **plus additional 30% to prices shown.**

*When both RAL colour and Glass option chosen please add 50% to prices shown.

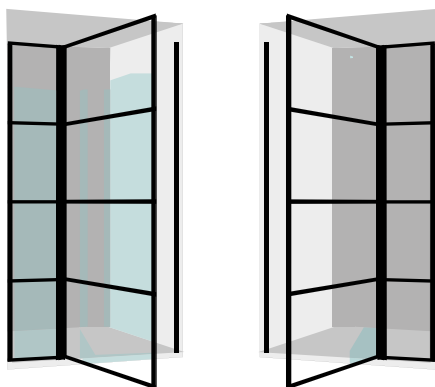

Left Hand
Opening **OUT**

Right Hand
Opening **OUT**

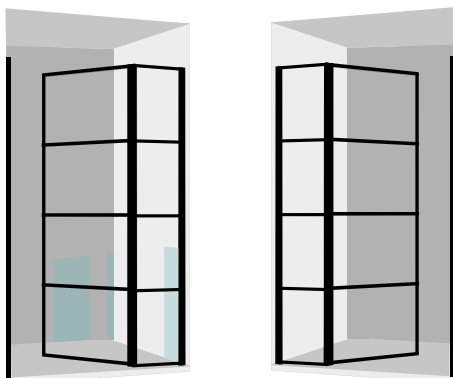

Right Hand
Opening **IN**

Left Hand
Opening **IN**



Shower Door hinged to **Inline Panel**

Drench recess shower solutions include a range of complimentary inline panels. Our standard range is carefully designed to keep the grid pattern balanced which is of paramount importance within our collection. The product is completed with a support bar which gives stability and durability to the enclosure. BESPOKE sizes are available, contact us for further information.

Features:



*Patent Pending

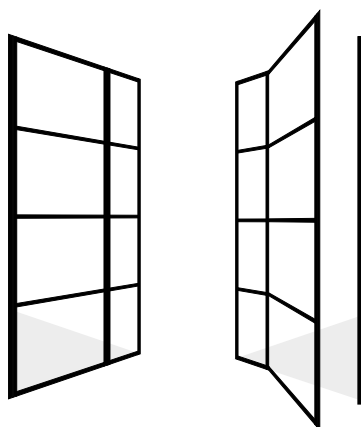

Shower Door

hinged to Inline Panel

Door is hinged to an Inline panel closing into a our closing profile in the wall. Both **left and right hand options available**. Code ending in L, means hinge on the Left and code ending in R, means hinge on the right.

Fixings, seals and every component of our standard shower door range is finished in **Matt Black**.

Please Adjustment range shown above before ordering. DRENCH is not liable for different dimensions on site.

Item Code	Specifications			Adjustment Range		Height (mm)	Retail Price (Exc VAT)
	Item Description	LH	RH	RECESS	WITH RETURN PANEL		
DECDOR70/20L12 DECDOR70/20LO2 DECDOR70/20R12 DECDOR70/20RO2	Shower Door for hinged to Inline Panel for a 900 mm width Door 700 mm + Inline Panel 200 mm L Left Hand / R Right Hand I Opening in / O Opening out			861 - 899	871 - 890	2100	£ 1067.00
DECDOR70/30L12 DECDOR70/30LO2 DECDOR70/30R12 DECDOR70/30RO2	Shower Door for hinged to Inline Panel for a 1000 mm width Door 700 mm + Inline Panel 300 mm L Left Hand / R Right Hand I Opening in / O Opening out			961 - 999	971 - 990	2100	£ 1232.50
DECDOR90/30L12 DECDOR90/30LO2 DECDOR90/30R12 DECDOR90/30RO2	Shower Door for hinged to Inline Panel for a 1200 mm width Door 900 mm + Inline Panel 300 mm L Left Hand / R Right Hand I Opening in / O Opening out			1161 - 1199	1171 - 1190	2100	£ 1449.00
DECDOR70/70L12 DECDOR70/70LO2 DECDOR70/70R12 DECDOR70/70RO2	Shower Door for hinged to Inline Panel for a 1400 mm width Door 700 mm + Inline Panel 700 mm L Left Hand / R Right Hand I Opening in / O Opening out			1361 - 1399	1371 - 1390	2100	£ 1850.00
DECDOR90/60L12 DECDOR90/60LO2 DECDOR90/60R12 DECDOR90/60RO2	Shower Door for hinged to Inline Panel for a 1500 mm width Door 900 mm + Inline Panel 600 mm L Left Hand / R Right Hand I Opening in / O Opening out			1461 - 1499	1471 - 1490	2100	£ 1995.00
DECDOR90/70L12 DECDOR90/70LO2 DECDOR90/70R12 DECDOR90/70RO2	Shower Door for hinged to Inline Panel for a 1600 mm width Door 900 mm + Inline Panel 700 mm L Left Hand / R Right Hand I Opening in / O Opening out			1561 - 1599	1571 - 1590	2100	£ 2060.00

Accessories

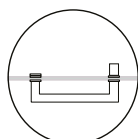

Handle Outside & Knob Inside

Included in prices above.

Shower doors bring horizontal square handle 25 x 10 mm, 457 mm width and 60 mm projection.

Suitable to be used as towel holder in the outside with knob in the inside.

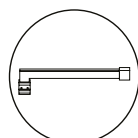

Angle Support Bar

Included in prices above.

Support bar for units narrower than 1200 mm.

Maximum length of bar 450 mm.

(3 parts, not pre-assembled)

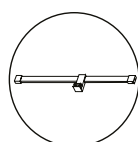

Double Support Bar

Included in prices above.

Support bar for units wider than 1200 mm.

Bar supplied at total width of unit ordered to be cut on site.

(4 parts, not pre-assembled)

Please NOTE

***Glass Options** available: FLUTED, GREY TINTED or FROSTED glass available **plus additional 30% to prices shown**.

Please see page 5 for further detail on our glass.

*All RAL colours are available **plus additional 30% to prices shown**.

*When both RAL colour and Glass option chosen please add 50% to prices shown.

Return Panels for Shower Enclosures

DRENCH doors may be paired with a range of return panels to create shower cubicles. Available in both, door closing onto return and door hinge from return.



Return panel configurations

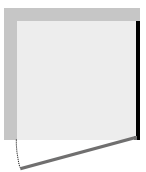

Right Hand
Return Panel for
Shower Door

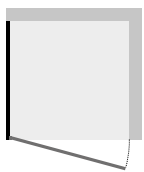

Left Hand
Return Panel for
Shower Door

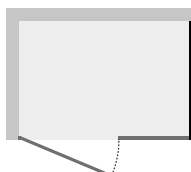

Right Hand
Return Panel for
Shower Door
with Inline panel

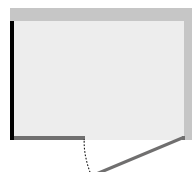

Left Hand
Return Panel for
Shower Door
with Inline panel

Closing Return panel configurations

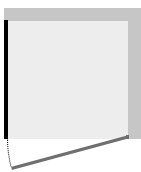

Left Hand
Closing Return
Panel for Shower
Door

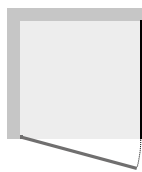

Right Hand
Closing Return
Panel for Shower
Door

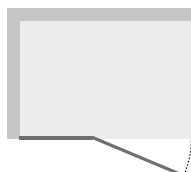

Right Hand
Closing Return
Panel for Shower
Door hinged to
Inline panel

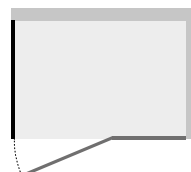

Left Hand
Closing Return
Panel for Shower
Door hinged to
Inline panel

Please NOTE

***Support Bar for Return Panel** included on prices shown.

***Return panels shown are suitable for Opening OUTWARDS configurations ONLY.**

For opening inwards please contact us.

***Glass Options** available: FLUTED, GREY TINTED or FROSTED glass available **plus additional 30% to prices shown.**

Please see page 5 for further detail on our glass.

*All RAL colours are available **plus additional 30% to prices shown.**

*When both RAL colour and Glass option chosen please add 50% to prices shown.

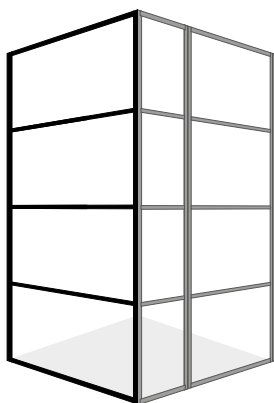

Return

Panel for Shower Enclosures

Suitable for **Door with Inline Panel and Shower doors closing on to the wall.**
Items below bring wall fixings and corner post included.

Please note Return panels are always sold as part of an enclosure; to be installed with **Shower doors, shower doors with inline or shower doors hinged to inline.**
Please note the **Adjustment** before ordering. We manufacture our Shower Enclosures to fit standard Shower tray sizes and any wet room configuration.

Item Code	Specifications		Adjustment (mm)	Height (mm)	Retail Price (Exc VAT) for Clear Glass
	Item Description	LAYOUT			
DECRTN70L DECRTN70R	Return Panel 700 mm width Wall fixing and Corner post included. L Left Hand / R Right Hand		664 - 693	2100	£ 594.00
DECRTN80L DECRTN80R	Return Panel 800 mm width Wall fixing and Corner post included. L Left Hand / R Right Hand		764 - 793	2100	£ 637.00
DECRTN90L DECRTN90R	Return Panel 900 mm width Wall fixing and Corner post included. L Left Hand / R Right Hand		864 - 893	2100	£ 684.00
DECRTN100L DECRTN100R	Return Panel 1000 mm width Wall fixing and Corner post included. L Left Hand / R Right Hand		964 - 993	2100	£ 830.00

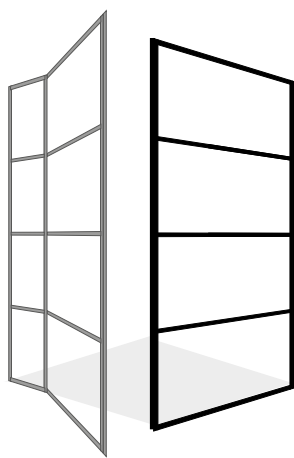

Closing Return

Panel for Shower Enclosures

Suitable for **Door hanging from Inline Panel and Shower doors closing on to a return panel.** Return panels below bring closing post preassembled in one side of the screen.

Please note Return panels are always sold as part of an enclosure; to be installed with **Shower doors, shower doors with inline or shower doors hinged to inline.**
Please note the **Adjustment** before ordering. We manufacture our Shower Enclosures to fit standard Shower tray sizes and any wet room configuration.

Item Code	Specifications		Adjustment (mm)	Height (mm)	Retail Price (Exc VAT) for Clear Glass
	Item Description	LAYOUT			
DECCLRTN70L DECCLRTN70R	Return Panel with closing post 700mm width Wall fixings included. L Left Hand / R Right Hand		671 - 690	2100	£ 594.00
DECCLRTN80L DECCLRTN80R	Return Panel with closing post 800mm width Wall fixings included. L Left Hand / R Right Hand		771 - 790	2100	£ 637.00
DECCLRTN90L DECCLRTN90R	Return Panel with closing post 900mm width Wall fixings included. L Left Hand / R Right Hand		871 - 890	2100	£ 684.00
DECCLRTN100L DECCLRTN100R	Return Panel with closing post 1000mm width Wall fixings included. L Left Hand / R Right Hand		971 - 990	2100	£ 830.00

DRENCH

INSPIRE BY DESIGN



LINEA 
Collection





Fixed Panels

The ideal solution providing elegance, a pure sense of light and space to your shower.

Features:



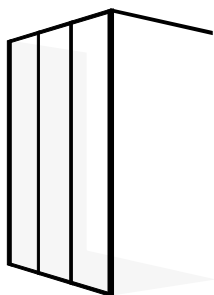

**Patent Pending*



Wall Fixed Shower Panels

Wall fixed Shower Screen for Wet rooms and walk-in showers.

Please read carefully our instructions below reference to Support Bars included and possible Fixed Panel combinations.

Item Code	Specifications		Adjustment (mm)	Height (mm)	Retail Price (Exc VAT) for Clear Glass
	Item Description	LAYOUT			
FXLIN30	Fixed Panel 300 mm , Matt Black, Clear Glass Wall Fixings included.		260 - 280	2100	£ 521.52
FXLIN40	Fixed Panel 400 mm , Matt Black, Clear Glass Wall Fixings included.		360 - 380	2100	£ 556.50
FXLIN50	Fixed Panel 500 mm , Matt Black, Clear Glass Wall Fixings included.		460 - 480	2100	£ 600.00
FXLIN60	Fixed Panel 600 mm , Matt Black, Clear Glass Wall Fixings included.		560 - 580	2100	£ 642.00
FXLIN70	Fixed Panel 700 mm , Matt Black, Clear Glass Wall Fixings included.		660 - 680	2100	£ 684.00
FXLIN80	Fixed Panel 800 mm , Matt Black, Clear Glass Wall Fixings included.		760 - 780	2100	£ 950.00
FXLIN90	Fixed Panel 900 mm , Matt Black, Clear Glass Wall Fixings included.		860 - 880	2100	£ 990.00
FXLIN100	Fixed Panel 1000mm , Matt Black, Clear Glass Wall Fixings included.		960 - 980	2100	£ 1030.00
FXLIN120	Fixed Panel 1200mm , Matt Black, Clear Glass Wall Fixings included.		1160 - 1180	2100	£ 1110.00
FXLIN140	Fixed Panel 1400mm , Matt Black, Clear Glass Wall Fixings included.		1360 - 1380	2100	£ 1190.00

Please NOTE

***Glass Options** available: FLUTED, GREY TINTED or FROSTED glass available **plus additional 30% to prices shown.**
Please see page 5 for further detail on our glass.

*All RAL colours are available **plus additional 30% to prices shown.**

*When both RAL colour and Glass option chosen please add 50% to prices shown.

Accessories



FXSBNGL

Angle Support Bar

Fixed panels from 500 - 700 mm width

Included in prices above

Maximum length of bar 450 mm.

(3 parts not pre-assembled)



FXSBCRS

Support Bar Across

Fixed panels from 800 - 1400 mm width

Included in prices above

Standard length 1000 mm.

(3 parts not pre-assembled)

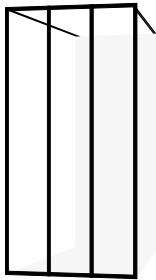

Free Standing Shower Panels

Free standing Shower Screen for Wet rooms and walk-in showers.
2 Support bars included on price.

Item Code	Specifications		Adjustment (mm)	Height (mm)	Retail Price (Exc VAT) for Clear Glass
	Item Description	LAYOUT			
FXLIN80FST	Fixed Panel 800 mm , Matt Black, Clear Glass 2 Support Bars included.		-	2100	£ 950.00
FXLIN90FST	Fixed Panel 900 mm , Matt Black, Clear Glass 2 Support Bars included.		-	2100	£ 990.00
FXLIN100FST	Fixed Panel 1000mm , Matt Black, Clear Glass 2 Support Bars included.		-	2100	£ 1030.00
FXLIN120FST	Fixed Panel 1200mm , Matt Black, Clear Glass 2 Support Bars included.		-	2100	£ 1110.00
FXLIN140FST	Fixed Panel 1400mm , Matt Black, Clear Glass 2 Support Bars included.		-	2100	£ 1190.00

Please NOTE

***Glass Options** available: FLUTED, GREY TINTED or FROSTED glass available **plus additional 30% to prices shown.**
Please see page 5 for further detail on our glass.

*All RAL colours are available **plus additional 30% to prices shown.**

*When both RAL colour and Glass option chosen please add 50% to prices shown.

Accessories

Standard Support Bar Across - **2 X FXSBCRS**
Included in prices above.

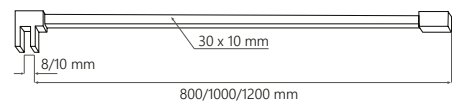

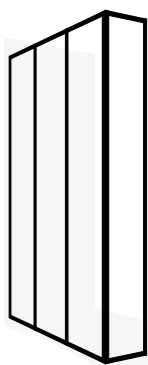

Wall Fixed Panels with Flipper Panel

Wall fixed Shower Screen for Wet rooms and walk-in showers with Flipper panel.

Flipper panel is already assembled to the fixed panel. The pivot mechanism is adjustable from 0 degree position. **Please note this item is Handed so Left or Right Hand need to be specified.**

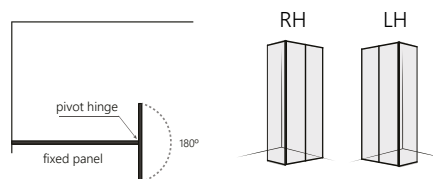

Item Code	Specifications		Adjustment (mm)	Height (mm)	Retail Price (Exc VAT) for Clear Glass	
	Item Description	LH				RH
FXLIN30FLIPL FXLIN30FLIPR	Fixed Panel 300mm with Flipper Panel 300mm L Left Hand / R Right Hand Matt Black, Clear Glass. Wall Fixings included.			560 - 580	2100	£ 829.80
FXLIN40FLIPL FXLIN40FLIPR	Fixed Panel 400mm with Flipper Panel 300mm L Left Hand / R Right Hand Matt Black, Clear Glass. Wall Fixings included.			660 - 680	2100	£ 864.78
FXLIN50FLIPL FXLIN50FLIPR	Fixed Panel 500mm with Flipper Panel 300mm L Left Hand / R Right Hand Matt Black, Clear Glass. Wall Fixings included.			760 - 780	2100	£ 908.27
FXLIN60FLIPL FXLIN60FLIPR	Fixed Panel 600mm with Flipper Panel 300mm L Left Hand / R Right Hand Matt Black, Clear Glass. Wall Fixings included.			860 - 880	2100	£ 950.27
FXLIN70FLIPL FXLIN70FLIPR	Fixed Panel 700mm with Flipper Panel 300mm L Left Hand / R Right Hand Matt Black, Clear Glass. Wall Fixings included.			960 - 980	2100	£ 992.27
FXLIN80FLIPL FXLIN80FLIPR	Fixed Panel 800mm with Flipper Panel 300mm L Left Hand / R Right Hand Matt Black, Clear Glass. Wall Fixings included.			1060 - 1080	2100	£ 1258.27
FXLIN90FLIPL FXLIN90FLIPR	Fixed Panel 900mm with Flipper Panel 300mm L Left Hand / R Right Hand Matt Black, Clear Glass. Wall Fixings included.			1160 - 1180	2100	£ 1298.27
FXLIN100FLIPL FXLIN100FLIPR	Fixed Panel 1000mm with Flipper Panel 300mm L Left Hand / R Right Hand Matt Black, Clear Glass. Wall Fixings included.			1260 - 1280	2100	£ 1338.27
FXLIN120FLIPL FXLIN120FLIPR	Fixed Panel 1200mm with Flipper Panel 300mm L Left Hand / R Right Hand Matt Black, Clear Glass. Wall Fixings included.			1460 - 1480	2100	£ 1418.27
FXLIN140FLIPL FXLIN140FLIPR	Fixed Panel 1400mm with Flipper Panel 300mm L Left Hand / R Right Hand Matt Black, Clear Glass. Wall Fixings included.			1660 - 1680	2100	£ 1498.27

Please NOTE

***Glass Options** available: FLUTED, GREY TINTED or FROSTED glass available **plus additional 30% to prices shown.** Please see page 5 for further detail on our glass.

*All RAL colours are available **plus additional 30% to prices shown.**

*When both RAL colour and Glass option chosen please add 50% to prices shown.

Accessories



FXSBNGL

Angle Support Bar

Fixed panels from 500 - 700 mm width
Included in prices above
Maximum length of bar 450 mm.
(3 parts not pre-assembled)



FXSBCRS

Support Bar Across

Fixed panels from 800 - 1400 mm width
Included in prices above
Standard length 1000 mm.
(3 parts not pre-assembled)

Support Bars

Standard fixed panels include Support bar Across however there are some more options available. Please note support bars below are not suitable for every unit.

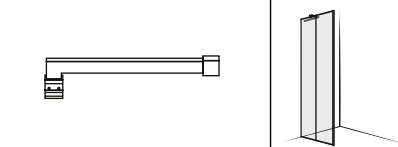
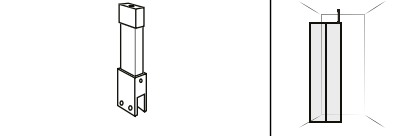
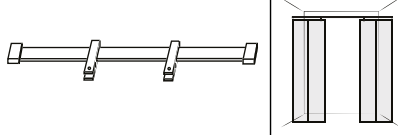
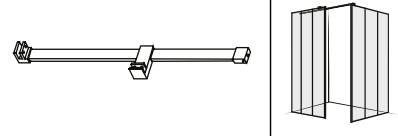
Item Code	Specifications		Retail Price (Exc VAT)
	Item Description	LAYOUT	
FXSBNGL	90° Angled support bar. <i>Not preassembled, 3 pieces + fixings.</i> Bar: 30 x 10 mm Length: 350 mm Not suitable for Panels wider than 1000 mm.		+£ 0* <i>*To be specified when order is placed.</i>
FXSBCLN	Ceiling support bar. <i>Not preassembled, 3 pieces + fixings.</i> Bar: 30 x 10 mm Length: 350 mm Not suitable for Panels wider than 1000 mm.		+£ 0* <i>*To be specified when order is placed.</i>
FXSBPRL2	Parallel support bar. <i>Not preassembled, 3 pieces + fixings.</i> Bar: 30 x 10 mm Length: Max 2000 mm. <i>To be specified on order.</i> Suitable for 2 panels.		+£45.83* <i>*To be specified when order is placed.</i>
FXSBDBL	Return panel support bar. <i>Not preassembled, 3 pieces + fixings.</i> Bar: 30 x 10 mm Length: Max 2000 mm. <i>To be specified on order.</i> Suitable for 2 panels.		+£45.83* <i>*To be specified when order is placed.</i>

Fixed panels Accesories

Standard fixed panels include Support bar Across however there are some more options available. Please note support bars below are not suitable for every unit.

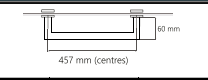
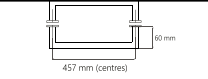
Item Code	Specifications		Retail Price (Exc VAT)
	Item Description	LAYOUT	
VHAND1	Single towel holder for fixed Panels. 457 mm width / 60 mm projection.		+£ 124.17* <i>*To be specified when order is placed.</i>
VHAND2	Double towel holder for fixed Panels. 457 mm width / 60 mm projection.		

180°

For any further enquiries feel free to contact our Sales team, we will be delighted to help. Please email us at sales@drenchshowers.co.uk

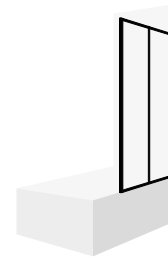

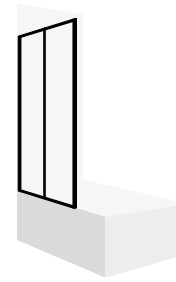

Right Hand



Left Hand

Bath Screen

A reduced size version of our product for those ones who love enjoying a bath. Both pivot and fixed bath screen options available.

Item Code	Specifications		Adjustment (mm)	Height (mm)	Retail Price (Exc VAT) for Clear Glass
	Item Description	LAYOUT			
LINFXBAT	Fixed Bath Screen 800 mm , Matt Black, Clear Glass Wall fixing included.		760 - 780	1500	£ 585.00
LINBATL	Fixed Bath Screen 800 mm , Matt Black, Clear Glass Wall fixing included.		760 - 780	1500	£ 621.42
LINBATR	Fixed Bath Screen 800 mm , Matt Black, Clear Glass Wall fixing included.		760 - 780	1500	£ 621.42

Please NOTE

***Glass Options** available: FLUTED, GREY TINTED or FROSTED glass available **plus additional 30% to prices shown.**

Please see page 5 for further detail on our glass.

*All RAL colours are available **plus additional 30% to prices shown.**

*When both RAL colour and Glass option chosen please add 50% to prices shown.

Features:



*Patent Pending

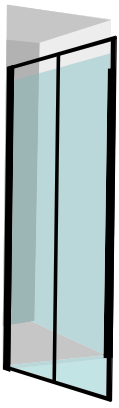

Left Hand
Opening **OUT**



Right Hand
Opening **OUT**

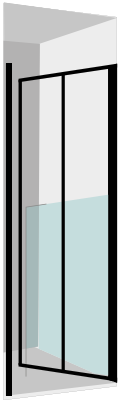

Right Hand
Opening **IN**

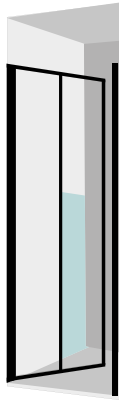

Left Hand
Opening **IN**



Single Shower Doors

DRENCH shower doors are both robust and sophisticated. Our pivot mechanism is manufactured using zinc die castings which give a durable and strong door performance. The magnetic closing post creates a secure seal after the shower door is closed. Pull handle and towel holder accessories are available to complete the item.

Features:



*Patent Pending

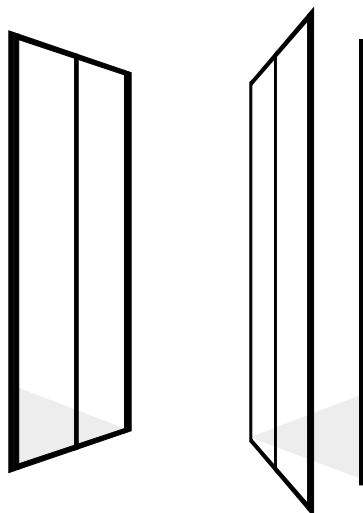

Single Shower Doors

Shower Door Left or Right Handed

Door is hinged to wall and both left and right hand options available. Code ending in L, means hinge on the Left and code ending in R, means hinge on the right.

Fixings, seals and every component of our standard shower door range is finished in **Matt Black**.

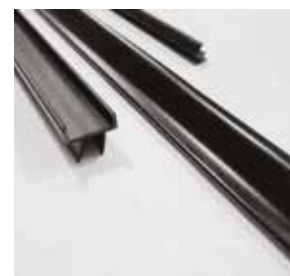

Item Code	Specifications			Adjustment Range		Height (mm)	Retail Price (Exc VAT)
	Item Description	LH	RH	RECESS	WITH RETURN PANEL		
LINDOR70LI LINDOR70LO LINDOR70RI LINDOR70RO	Shower Door for 700 mm width L Left Hand / R Right Hand I Opening in / O Opening out			661 - 699	661 - 699	2100	£ 823.33
LINDOR76LI LINDOR76LO LINDOR76RI LINDOR76RO	Shower Door for 760 mm width L Left Hand / R Right Hand I Opening in / O Opening out			721 - 759	721 - 759	2100	£ 896.67
LINDOR80LI LINDOR80LO LINDOR80RI LINDOR80RO	Shower Door for 800 mm width L Left Hand / R Right Hand I Opening in / O Opening out			761 - 799	761 - 799	2100	£ 940.83
LINDOR90LI LINDOR90LO LINDOR90RI LINDOR90RO	Shower Door for 900 mm width L Left Hand / R Right Hand I Opening in / O Opening out			861 - 899	861 - 899	2100	£ 1066.67

Please NOTE

***Glass Options** available: FLUTED, GREY TINTED or FROSTED glass available **plus additional 30% to prices shown.**

Please see page 5 for further detail on our glass.

*All RAL colours are available **plus additional 30% to prices shown.**

*When both RAL colour and Glass option chosen please add 50% to prices shown.

Please check Adjustment range shown above before ordering. DRENCH is not liable for different dimensions on site.

Accessories



Handle Outside & Knob Inside
Included in prices above.

Shower doors bring horizontal square handle 25 x 10 mm, 457 mm width and 60 mm projection.

Suitable to be used as towel holder in the outside with knob in the inside.

For any further enquiries feel free to contact our Sales team, we will be delighted to help. Please email us at sales@drenchshowers.co.uk

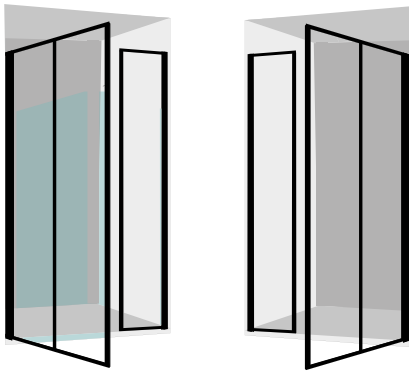

Left Hand
Opening **OUT**

Right Hand
Opening **OUT**

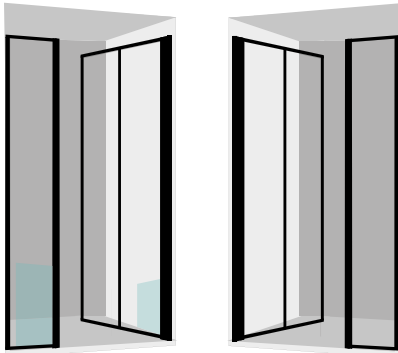

Right Hand
Opening **IN**

Left Hand
Opening **IN**



Shower Door with **Inline Panel**

Drench recess shower solutions include a range of complimentary inline panels. Our standard range is carefully designed to keep the grid pattern balanced which is of paramount importance within our collection. The product is completed with a support bar which gives stability and durability to the enclosure. BESPOKE sizes are available, contact us for further information.

Features:



*Patent Pending

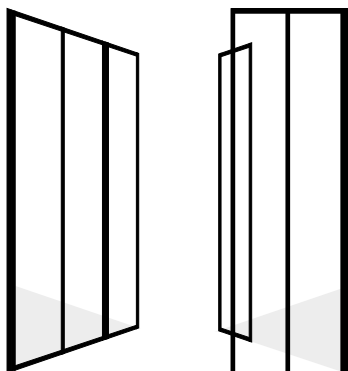

Shower Door

with Inline Panel

Door is hinged to wall closing into an Inline Panel.

Both left and right hand options available. Code ending in L, means hinge on the Left and code ending in R, means hinge on the right.

Fixings, seals and every component of our standard shower door range is finished in Matt Black.

Please Adjustment range shown above before ordering. DRENCH is not liable for different dimensions on site.

Item Code	Specifications			Adjustment Range		Height (mm)	Retail Price (Exc VAT)
	Item Description	LH	RH	RECESS	WITH RETURN PANEL		
LINDOR70/20LI1 LINDOR70/20LO1 LINDOR70/20RI1 LINDOR70/20RO1	Shower Door for with inline Panel for a 900 mm width <i>Door 700 mm + Inline Panel 200 mm</i> L Left Hand / R Right Hand I Opening in / O Opening out			861 - 899	871 - 890	2100	£ 1067.00
LINDOR70/30LI1 LINDOR70/30LO1 LINDOR70/30RI1 LINDOR70/30RO1	Shower Door for with inline Panel for a 1000 mm width <i>Door 700 mm + Inline Panel 300 mm</i> L Left Hand / R Right Hand I Opening in / O Opening out			961 - 999	971 - 990	2100	£ 1232.50
LINDOR90/30LI1 LINDOR90/30LO1 LINDOR90/30RI1 LINDOR90/30RO1	Shower Door for with inline Panel for a 1200 mm width <i>Door 900 mm + Inline Panel 300 mm</i> L Left Hand / R Right Hand I Opening in / O Opening out			1161 - 1199	1171 - 1190	2100	£ 1449.00
LINDOR70/70LI1 LINDOR70/70LO1 LINDOR70/70RI1 LINDOR70/70RO1	Shower Door for with inline Panel for a 1400 mm width <i>Door 700 mm + Inline Panel 700 mm</i> L Left Hand / R Right Hand I Opening in / O Opening out			1361 - 1399	1371 - 1390	2100	£ 1850.00
LINDOR90/60LI1 LINDOR90/60LO1 LINDOR90/60RI1 LINDOR90/60RO1	Shower Door for with inline Panel for a 1500 mm width <i>Door 900 mm + Inline Panel 600 mm</i> L Left Hand / R Right Hand I Opening in / O Opening out			1461 - 1499	1471 - 1490	2100	£ 1995.00
LINDOR90/70LI1 LINDOR90/70LO1 LINDOR90/70RI1 LINDOR90/70RO1	Shower Door for with inline Panel for a 1600 mm width <i>Door 900 mm + Inline Panel 700 mm</i> L Left Hand / R Right Hand I Opening in / O Opening out			1561 - 1599	1571 - 1590	2100	£ 2060.00

Accessories



Pull handle

Included in prices above.

Pull handle attached to the closing profile, both external and internal side.

For any further handle option, please check Accessories in page XX.

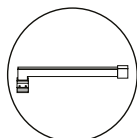

Angle Support Bar

Included in prices above.

Support bar for units narrower than 1200 mm.

Maximum length of bar 450 mm.

(3 parts, not pre-assembled)

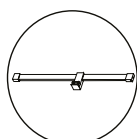

Double Support Bar

Included in prices above.

Support bar for units wider than 1200 mm.

Bar supplied at total width of unit ordered to be cut on site.

(4 parts, not pre-assembled)

Please NOTE

***Glass Options** available: FLUTED, GREY TINTED or FROSTED glass available **plus additional 30% to prices shown.**

Please see page 5 for further detail on our glass.

*All RAL colours are available **plus additional 30% to prices shown.**

*When both RAL colour and Glass option chosen please add 50% to prices shown.

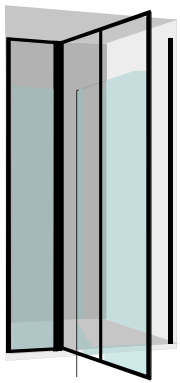

Left Hand Opening **OUT**

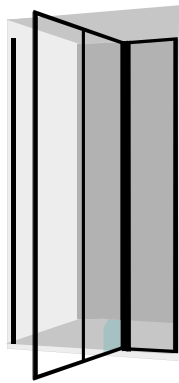

Right Hand Opening **OUT**

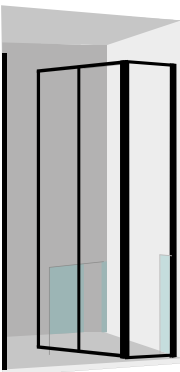

Right Hand Opening **IN**

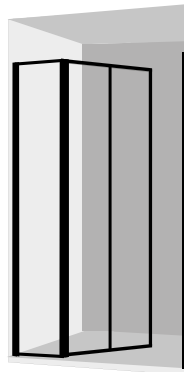

Left Hand Opening **IN**



Shower Door hinged to **Inline Panel**

Drench recess shower solutions include a range of complimentary inline panels. Our standard range is carefully designed to keep the grid pattern balanced which is of paramount importance within our collection. The product is completed with a support bar which gives stability and durability to the enclosure. BESPOKE sizes are available, contact us for further information.

Features:



*Patent Pending

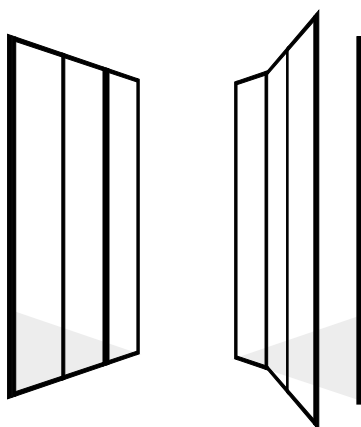

Shower Door

hinged to Inline Panel

Door is hinged to an Inline panel closing into a our closing profile in the wall. Both **left and right hand options available**. Code ending in L, means hinge on the Left and code ending in R, means hinge on the right.

Fixings, seals and every component of our standard shower door range is finished in **Matt Black**.

Please Adjustment range shown above before ordering. DRENCH is not liable for different dimensions on site.

Item Code	Specifications			Adjustment Range		Height (mm)	Retail Price (Exc VAT)
	Item Description	LH	RH	RECESS	WITH RETURN PANEL		
LINDOR70/20L12 LINDOR70/20LO2 LINDOR70/20R12 LINDOR70/20RO2	Shower Door for hinged to Inline Panel for a 900 mm width <i>Door 700 mm + Inline Panel 200 mm</i> L Left Hand / R Right Hand I Opening in / O Opening out			861 - 899	871 - 890	2100	£ 1067.00
LINDOR70/30L12 LINDOR70/30LO2 LINDOR70/30R12 LINDOR70/30RO2	Shower Door for hinged to Inline Panel for a 1000 mm width <i>Door 700 mm + Inline Panel 300 mm</i> L Left Hand / R Right Hand I Opening in / O Opening out			961 - 999	971 - 990	2100	£ 1232.50
LINDOR90/30L12 LINDOR90/30LO2 LINDOR90/30R12 LINDOR90/30RO2	Shower Door for hinged to Inline Panel for a 1200 mm width <i>Door 900 mm + Inline Panel 300 mm</i> L Left Hand / R Right Hand I Opening in / O Opening out			1161 - 1199	1171 - 1190	2100	£ 1449.00
LINDOR70/70L12 LINDOR70/70LO2 LINDOR70/70R12 LINDOR70/70RO2	Shower Door for hinged to Inline Panel for a 1400 mm width <i>Door 700 mm + Inline Panel 700 mm</i> L Left Hand / R Right Hand I Opening in / O Opening out			1361 - 1399	1371 - 1390	2100	£ 1850.00
LINDOR90/60L12 LINDOR90/60LO2 LINDOR90/60R12 LINDOR90/60RO2	Shower Door for hinged to Inline Panel for a 1500 mm width <i>Door 900 mm + Inline Panel 600 mm</i> L Left Hand / R Right Hand I Opening in / O Opening out			1461 - 1499	1471 - 1490	2100	£ 1995.00
LINDOR90/70L12 LINDOR90/70LO2 LINDOR90/70R12 LINDOR90/70RO2	Shower Door for hinged to Inline Panel for a 1600 mm width <i>Door 900 mm + Inline Panel 700 mm</i> L Left Hand / R Right Hand I Opening in / O Opening out			1561 - 1599	1571 - 1590	2100	£ 2060.00

Accessories



Pull handle

Included in prices above.

Pull handle attached to the closing profile, both external and internal side.

For any further handle option, please check Accessories in page XX.

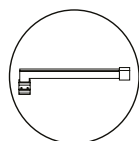

Angle Support Bar

Included in prices above.

Support bar for units narrower than 1200 mm.
Maximum length of bar 450 mm.

(3 parts, not pre-assembled)

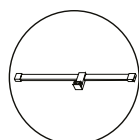

Double Support Bar

Included in prices above.

Support bar for units wider than 1200 mm.

Bar supplied at total width of unit ordered to be cut on site.
(4 parts, not pre-assembled)

Please NOTE

***Glass Options** available: FLUTED, GREY TINTED or FROSTED glass available **plus additional 30% to prices shown**.

Please see page 5 for further detail on our glass.

*All RAL colours are available **plus additional 30% to prices shown**.

*When both RAL colour and Glass option chosen please add 50% to prices shown.

Return Panels for Shower Enclosures

DRENCH doors may be paired with a range of return panels to create shower cubicles. Available in both, door closing onto return and door hinge from return.



Return panel configurations

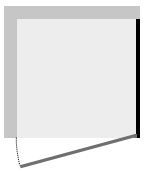

Right Hand
Return Panel for
Shower Door

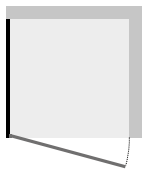

Left Hand
Return Panel for
Shower Door

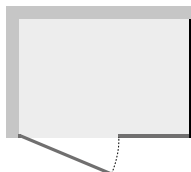

Right Hand
Return Panel for
Shower Door
with Inline panel

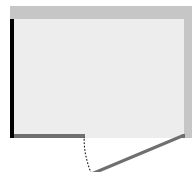

Left Hand
Return Panel for
Shower Door
with Inline panel

Closing Return panel configurations

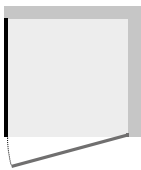

Left Hand
Closing Return
Panel for Shower
Door

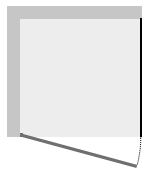

Right Hand
Closing Return
Panel for Shower
Door

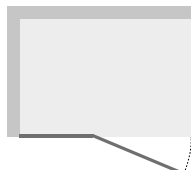

Right Hand
Closing Return
Panel for Shower
Door hinged to
Inline panel

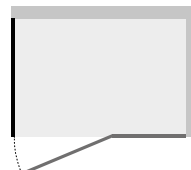

Left Hand
Closing Return
Panel for Shower
Door hinged to
Inline panel

Please NOTE

***Support Bar for Return Panel** included on prices shown.

***Return panels shown are suitable for Opening OUTWARDS configurations ONLY.**

For opening inwards please contact us.

***Glass Options** available: FLUTED, GREY TINTED or FROSTED glass available **plus additional 30% to prices shown.**

Please see page 5 for further detail on our glass.

*All RAL colours are available **plus additional 30% to prices shown.**

*When both RAL colour and Glass option chosen please add 50% to prices shown.

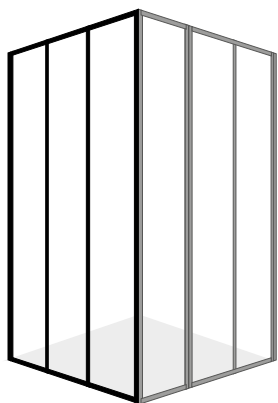

Return

Panel for Shower Enclosures

Suitable for **Door with Inline Panel and Shower doors closing on to the wall.**
Items below bring wall fixings and corner post included.

Please note Return panels are always sold as part of an enclosure; to be installed with **Shower doors, shower doors with inline or shower doors hinged to inline.**
Please note the **Adjustment** before ordering. We manufacture our Shower Enclosures to fit standard Shower tray sizes and any wet room configuration.

Item Code	Specifications		Adjustment (mm)	Height (mm)	Retail Price (Exc VAT) for Clear Glass
	Item Description	LAYOUT			
LINRTN70L LINRTN70R	Return Panel 700 mm width Wall fixing and Corner post included. L Left Hand / R Right Hand		664 - 693	2100	£ 594.00
LINRTN80L LINRTN80R	Return Panel 800 mm width Wall fixing and Corner post included. L Left Hand / R Right Hand		764 - 793	2100	£ 637.00
LINRTN90L LINRTN90R	Return Panel 900 mm width Wall fixing and Corner post included. L Left Hand / R Right Hand		864 - 893	2100	£ 684.00
LINRTN100L LINRTN100R	Return Panel 1000 mm width Wall fixing and Corner post included. L Left Hand / R Right Hand		964 - 993	2100	£ 830.00

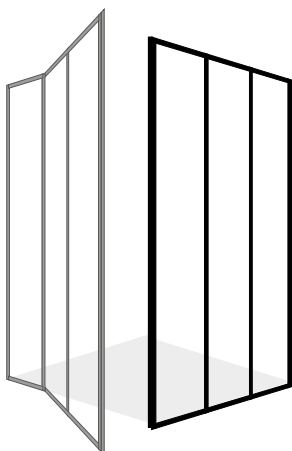

Closing Return

Panel for Shower Enclosures

Suitable for **Door hanging from Inline Panel and Shower doors closing on to a return panel.** Return panels below bring closing post preassembled in one side of the screen.

Please note Return panels are always sold as part of an enclosure; to be installed with **Shower doors, shower doors with inline or shower doors hinged to inline.**
Please note the **Adjustment** before ordering. We manufacture our Shower Enclosures to fit standard Shower tray sizes and any wet room configuration.

Item Code	Specifications		Adjustment (mm)	Height (mm)	Retail Price (Exc VAT) for Clear Glass
	Item Description	LAYOUT			
LINCLRTN70L LINCLRTN70R	Return Panel with closing post 700mm width Wall fixings included. L Left Hand / R Right Hand		671 - 690	2100	£ 594.00
LINCLRTN80L LINCLRTN80R	Return Panel with closing post 800mm width Wall fixings included. L Left Hand / R Right Hand		771 - 790	2100	£ 637.00
LINCLRTN90L LINCLRTN90R	Return Panel with closing post 900mm width Wall fixings included. L Left Hand / R Right Hand		871 - 890	2100	£ 684.00
LINCLRTN100L LINCLRTN100R	Return Panel with closing post 1000mm width Wall fixings included. L Left Hand / R Right Hand		971 - 990	2100	£ 830.00

DRENCH

INSPIRE BY DESIGN



BORDER 
Collection



Fixed Panels

The ideal solution providing elegance, a pure sense of light and space to your shower.

Features:



*Patent Pending

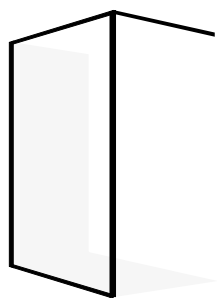

Wall Fixed Shower Panels

Wall fixed Shower Screen for Wet rooms and walk-in showers.

Please read carefully our instructions below reference to Support Bars included and possible Fixed Panel combinations.

Item Code	Specifications		Adjustment (mm)	Height (mm)	Retail Price (Exc VAT) for Clear Glass
	Item Description	LAYOUT			
FXBOR30	Fixed Panel 300 mm , Matt Black, Clear Glass Wall Fixings included.		260 - 280	2100	£ 521.52
FXBOR40	Fixed Panel 400 mm , Matt Black, Clear Glass Wall Fixings included.		360 - 380	2100	£ 556.50
FXBOR50	Fixed Panel 500 mm , Matt Black, Clear Glass Wall Fixings included.		460 - 480	2100	£ 591.48
FXBOR60	Fixed Panel 600 mm , Matt Black, Clear Glass Wall Fixings included.		560 - 580	2100	£ 627.52
FXBOR70	Fixed Panel 700 mm , Matt Black, Clear Glass Wall Fixings included.		660 - 680	2100	£ 662.50
FXBOR80	Fixed Panel 800 mm , Matt Black, Clear Glass Wall Fixings included.		760 - 780	2100	£ 697.83
FXBOR90	Fixed Panel 900 mm , Matt Black, Clear Glass Wall Fixings included.		860 - 880	2100	£ 733.17
FXBOR100	Fixed Panel 1000mm , Matt Black, Clear Glass Wall Fixings included.		960 - 980	2100	£ 768.50
FXBOR120	Fixed Panel 1200mm , Matt Black, Clear Glass Wall Fixings included.		1160 - 1180	2100	£ 839.17
FXBOR140	Fixed Panel 1400mm , Matt Black, Clear Glass Wall Fixings included.		1360 - 1380	2100	£ 909.83

Please NOTE

***Glass Options** available: FLUTED, GREY TINTED or FROSTED glass available **plus additional 30% to prices shown.**
Please see page 5 for further detail on our glass.

*All RAL colours are available **plus additional 30% to prices shown.**

*When both RAL colour and Glass option chosen please add 50% to prices shown.

Accessories



FXSBNGL

Angle Support Bar

Fixed panels from 500 - 700 mm width

Included in prices above

Maximum length of bar 450 mm.

(3 parts not pre-assembled)



FXSBCRS

Support Bar Across

Fixed panels from 800 - 1400 mm width

Included in prices above



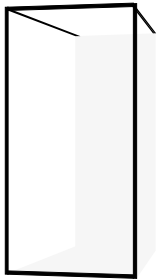

Standard length 1000 mm.

(3 parts not pre-assembled)



Free Standing Shower Panels

Free standing Shower Screen for Wet rooms and walk-in showers.
2 Support bars included on price.

Item Code	Specifications		Adjustment (mm)	Height (mm)	Retail Price (Exc VAT) for Clear Glass
	Item Description	LAYOUT			
FXBOR80FST	Fixed Panel 800 mm , Matt Black, Clear Glass 2 Support Bars included.		-	2100	£ 697.83
FXBOR90FST	Fixed Panel 900 mm , Matt Black, Clear Glass 2 Support Bars included.		-	2100	£ 733.17
FXBOR100FST	Fixed Panel 1000mm , Matt Black, Clear Glass 2 Support Bars included.		-	2100	£ 768.50
FXBOR120FST	Fixed Panel 1200mm , Matt Black, Clear Glass 2 Support Bars included.		-	2100	£ 839.17
FXBOR140FST	Fixed Panel 1400mm , Matt Black, Clear Glass 2 Support Bars included.		-	2100	£ 909.83

Please NOTE

***Glass Options** available: FLUTED, GREY TINTED or FROSTED glass available **plus additional 30% to prices shown.**
Please see page 5 for further detail on our glass.

*All RAL colours are available **plus additional 30% to prices shown.**

*When both RAL colour and Glass option chosen please add 50% to prices shown.

Accessories

Standard Support Bar Across - **2 X FXSBCRS**
Included in prices above.

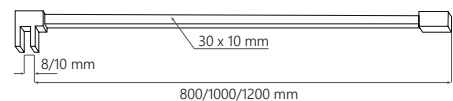

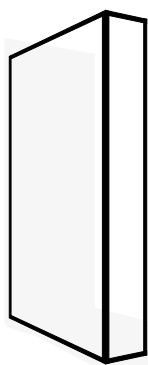

Wall Fixed Panels with Flipper Panel

Wall fixed Shower Screen for Wet rooms and walk-in showers with Flipper panel.

Flipper panel is already assembled to the fixed panel. The pivot mechanism is adjustable from 0 degree position. **Please note this item is Handed so Left or Right Hand need to be specified.**

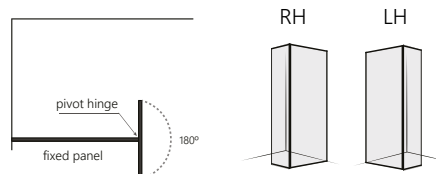

Item Code	Specifications		Adjustment (mm)	Height (mm)	Retail Price (Exc VAT) for Clear Glass	
	Item Description	LH				RH
FXBOR30FLIPL FXBOR30FLIPR	Fixed Panel 300mm with Flipper Panel 300mm L Left Hand / R Right Hand Matt Black, Clear Glass. Wall Fixings included.			560 - 580	2100	£ 829.80
FXBOR40FLIPL FXBOR40FLIPR	Fixed Panel 400mm with Flipper Panel 300mm L Left Hand / R Right Hand Matt Black, Clear Glass. Wall Fixings included.			660 - 680	2100	£ 864.78
FXBOR50FLIPL FXBOR50FLIPR	Fixed Panel 500mm with Flipper Panel 300mm L Left Hand / R Right Hand Matt Black, Clear Glass. Wall Fixings included.			760 - 780	2100	£ 899.75
FXBOR60FLIPL FXBOR60FLIPR	Fixed Panel 600mm with Flipper Panel 300mm L Left Hand / R Right Hand Matt Black, Clear Glass. Wall Fixings included.			860 - 880	2100	£ 935.80
FXBOR70FLIPL FXBOR70FLIPR	Fixed Panel 700mm with Flipper Panel 300mm L Left Hand / R Right Hand Matt Black, Clear Glass. Wall Fixings included.			960 - 980	2100	£ 970.78
FXBOR80FLIPL FXBOR80FLIPR	Fixed Panel 800mm with Flipper Panel 300mm L Left Hand / R Right Hand Matt Black, Clear Glass. Wall Fixings included.			1060 - 1080	2100	£ 1006.10
FXBOR90FLIPL FXBOR90FLIPR	Fixed Panel 900mm with Flipper Panel 300mm L Left Hand / R Right Hand Matt Black, Clear Glass. Wall Fixings included.			1160 - 1180	2100	£ 1041.44
FXBOR100FLIPL FXBOR100FLIPR	Fixed Panel 1000mm with Flipper Panel 300mm L Left Hand / R Right Hand Matt Black, Clear Glass. Wall Fixings included.			1260 - 1280	2100	£ 1076.77
FXBOR120FLIPL FXBOR120FLIPR	Fixed Panel 1200mm with Flipper Panel 300mm L Left Hand / R Right Hand Matt Black, Clear Glass. Wall Fixings included.			1460 - 1480	2100	£ 1147.44
FXBOR140FLIPL FXBOR140FLIPR	Fixed Panel 1400mm with Flipper Panel 300mm L Left Hand / R Right Hand Matt Black, Clear Glass. Wall Fixings included.			1660 - 1680	2100	£ 1218.10

Please NOTE

***Glass Options** available: FLUTED, GREY TINTED or FROSTED glass available **plus additional 30% to prices shown.** Please see page 5 for further detail on our glass.

*All RAL colours are available **plus additional 30% to prices shown.**

*When both RAL colour and Glass option chosen please add 50% to prices shown.

Accessories



FXSBNGL

Angle Support Bar

Fixed panels from 500 - 700 mm width
Included in prices above
Maximum length of bar 450 mm.
(3 parts not pre-assembled)



FXSBCRS

Support Bar Across

Fixed panels from 800 - 1400 mm width
Included in prices above
Standard length 1000 mm.
(3 parts not pre-assembled)

Support Bars

Standard fixed panels include Support bar Across however there are some more options available. Please note support bars below are not suitable for every unit.

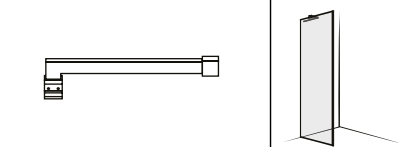
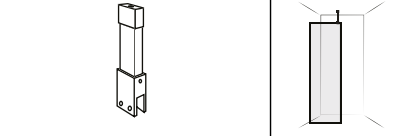
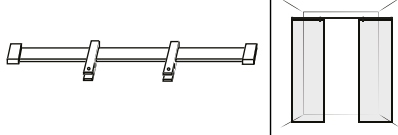
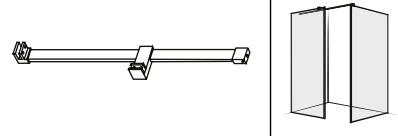
Item Code	Specifications		Retail Price (Exc VAT)
	Item Description	LAYOUT	
FXSBNGL	90° Angled support bar. <i>Not preassembled, 3 pieces + fixings.</i> Bar: 30 x 10 mm Length: 350 mm Not suitable for Panels wider than 1000 mm.		+£ 0* <i>*To be specified when order is placed.</i>
FXSBCLN	Ceiling support bar. <i>Not preassembled, 3 pieces + fixings.</i> Bar: 30 x 10 mm Length: 350 mm Not suitable for Panels wider than 1000 mm.		+£ 0* <i>*To be specified when order is placed.</i>
FXSBPRL2	Parallel support bar. <i>Not preassembled, 3 pieces + fixings.</i> Bar: 30 x 10 mm Length: Max 2000 mm. <i>To be specified on order.</i> Suitable for 2 panels.		+£ 45.83* <i>*To be specified when order is placed.</i>
FXSBDBL	Return panel support bar. <i>Not preassembled, 3 pieces + fixings.</i> Bar: 30 x 10 mm Length: Max 2000 mm. <i>To be specified on order.</i> Suitable for 2 panels.		+£ 45.83* <i>*To be specified when order is placed.</i>

Fixed panels Accesories

Standard fixed panels include Support bar Across however there are some more options available. Please note support bars below are not suitable for every unit.

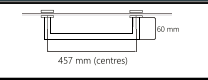
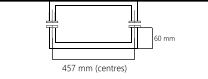
Item Code	Specifications		Retail Price (Exc VAT)
	Item Description	LAYOUT	
VHAND1	Single towel holder for fixed Panels. 457 mm width / 60 mm projection.		+£ 124.17* <i>*To be specified when order is placed.</i>
VHAND2	Double towel holder for fixed Panels. 457 mm width / 60 mm projection.		

For any further enquiries feel free to contact our Sales team, we will be delighted to help. Please email us at sales@drenchshowers.co.uk

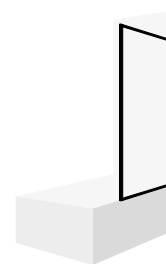

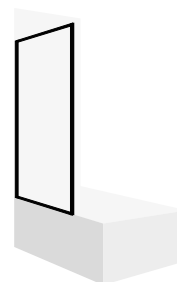

Right Hand



Left Hand

Bath Screen

A reduced size version of our product for those ones who love enjoying a bath. Both pivot and fixed bath screen options available.

Item Code	Specifications		Adjustment (mm)	Height (mm)	Retail Price (Exc VAT) for Clear Glass
	Item Description	LAYOUT			
BORFXBAT	Fixed Bath Screen 800 mm , Matt Black, Clear Glass Wall fixing included.		760 - 780	1500	£ 455.80
BORBATL	Fixed Bath Screen 800 mm , Matt Black, Clear Glass Wall fixing included.		760 - 780	1500	£ 498.81
BORBATR	Fixed Bath Screen 800 mm , Matt Black, Clear Glass Wall fixing included.		760 - 780	1500	£ 498.81

Please NOTE

*Glass Options available: FLUTED, GREY TINTED or FROSTED glass available **plus additional 30% to prices shown.**

Please see page 5 for further detail on our glass.

*All RAL colours are available **plus additional 30% to prices shown.**

*When both RAL colour and Glass option chosen please add 50% to prices shown.

Features:



*Patent Pending

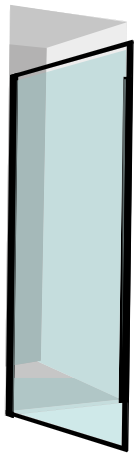

Left Hand
Opening **OUT**

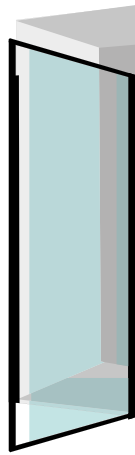

Right Hand
Opening **OUT**

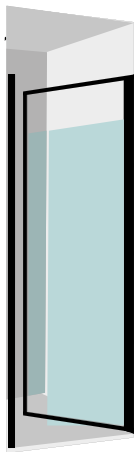

Right Hand
Opening **IN**

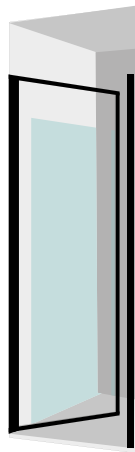

Left Hand
Opening **IN**



Single Shower Doors

DRENCH shower doors are both robust and sophisticated. Our pivot mechanism is manufactured using zinc die castings which give a durable and strong door performance. The magnetic closing post creates a secure seal after the shower door is closed. Pull handle and towel holder accessories are available to complete the item.

Features:



*Patent Pending

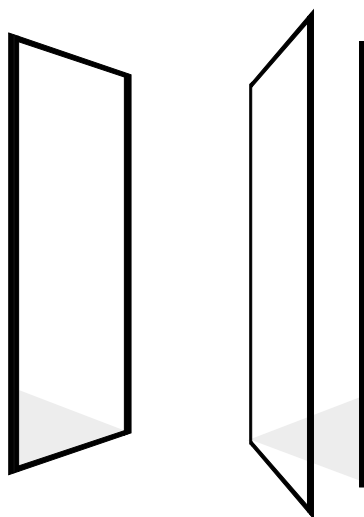







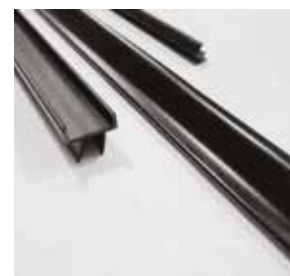

Single Shower Doors

Shower Door Left or Right Handed

Door is hinged to wall and both left and right hand options available. Code ending in L, means hinge on the Left and code ending in R, means hinge on the right.

Fixings, seals and every component of our standard shower door range is finished in **Matt Black**.



Item Code	Specifications		Adjustment Range		Height (mm)	Retail Price (Exc VAT)
	Item Description	LH	RH	RECESS		
BORDOR70LI BORDOR70LO BORDOR70RI BORDOR70RO	Shower Door for 700 mm width L Left Hand / R Right Hand I Opening in / O Opening out			661 - 699	661 - 699	2100 £ 696.42
BORDOR76LI BORDOR76LO BORDOR76RI BORDOR76RO	Shower Door for 760 mm width L Left Hand / R Right Hand I Opening in / O Opening out			721 - 759	721 - 759	2100 £ 757.90
BORDOR80LI BORDOR80LO BORDOR80RI BORDOR80RO	Shower Door for 800 mm width L Left Hand / R Right Hand I Opening in / O Opening out			761 - 799	761 - 799	2100 £ 795.43
BORDOR90LI BORDOR90LO BORDOR90RI BORDOR90RO	Shower Door for 900 mm width L Left Hand / R Right Hand I Opening in / O Opening out			861 - 899	861 - 899	2100 £ 901.44

Please NOTE

***Glass Options** available: FLUTED, GREY TINTED or FROSTED glass available **plus additional 30% to prices shown.**

Please see page 5 for further detail on our glass.

*All RAL colours are available **plus additional 30% to prices shown.**

*When both RAL colour and Glass option chosen please add 50% to prices shown.

Please check Adjustment range shown above before ordering. DRENCH is not liable for different dimensions on site.

Accessories

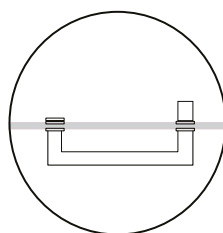

Handle Outside & Knob Inside
Included in prices above.

Shower doors bring horizontal square handle 25 x 10 mm, 457 mm width and 60 mm projection.

Suitable to be used as towel holder in the outside with knob in the inside.

For any further enquiries feel free to contact our Sales team, we will be delighted to help. Please email us at sales@drenchshowers.co.uk

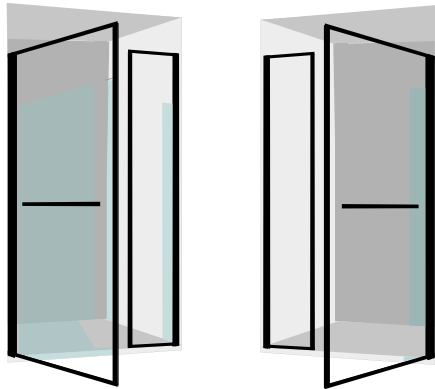

Left Hand
Opening **OUT**

Right Hand
Opening **OUT**

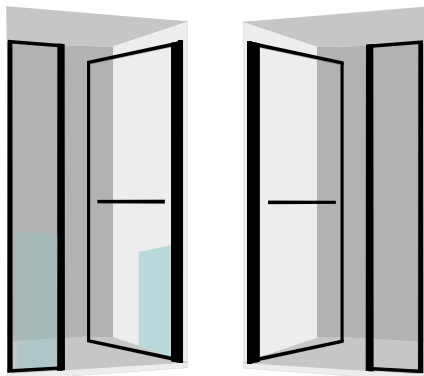

Right Hand
Opening **IN**

Left Hand
Opening **IN**



Shower Door with **Inline Panel**

Drench recess shower solutions include a range of complimentary inline panels. Our standard range is carefully designed to keep the grid pattern balanced which is of paramount importance within our collection. The product is completed with a support bar which gives stability and durability to the enclosure. BESPOKE sizes are available, contact us for further information.

Features:



*Patent Pending

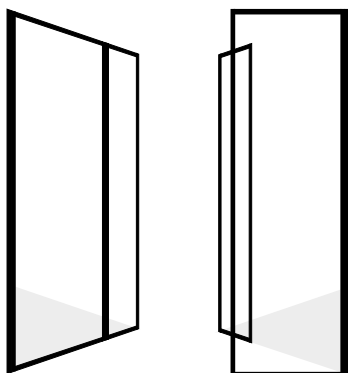

Shower Door with Inline Panel

Door is hinged to wall closing into an Inline Panel.
Both left and right hand options available. Code ending in L, means hinge on the Left and code ending in R, means hinge on the right.
Fixings, seals and every component of our standard shower door range is finished in Matt Black.
Please Adjustment range shown above before ordering. DRENCH is not liable for different dimensions on site.

Item Code	Specifications			Adjustment Range		Height (mm)	Retail Price (Exc VAT)
	Item Description	LH	RH	RECESS	WITH RETURN PANEL		
BORDOR70/20LI1 BORDOR70/20LO1 BORDOR70/20RI1 BORDOR70/20RO1	Shower Door for with inline Panel for a 900 mm width <i>Door 700 mm + Inline Panel 200 mm</i> L Left Hand / R Right Hand I Opening in / O Opening out			861 - 899	871 - 890	2100	£ 901.44
BORDOR70/30LI1 BORDOR70/30LO1 BORDOR70/30RI1 BORDOR70/30RO1	Shower Door for with inline Panel for a 1000 mm width <i>Door 700 mm + Inline Panel 300 mm</i> L Left Hand / R Right Hand I Opening in / O Opening out			961 - 999	971 - 990	2100	£ 1043.04
BORDOR90/30LI1 BORDOR90/30LO1 BORDOR90/30RI1 BORDOR90/30RO1	Shower Door for with inline Panel for a 1200 mm width <i>Door 900 mm + Inline Panel 300 mm</i> L Left Hand / R Right Hand I Opening in / O Opening out			1161 - 1199	1171 - 1190	2100	£ 1226.42
BORDOR70/70LI1 BORDOR70/70LO1 BORDOR70/70RI1 BORDOR70/70RO1	Shower Door for with inline Panel for a 1400 mm width <i>Door 700 mm + Inline Panel 700 mm</i> L Left Hand / R Right Hand I Opening in / O Opening out			1361 - 1399	1371 - 1390	2100	£ 1550.78
BORDOR90/60LI1 BORDOR90/60LO1 BORDOR90/60RI1 BORDOR90/60RO1	Shower Door for with inline Panel for a 1500 mm width <i>Door 900 mm + Inline Panel 600 mm</i> L Left Hand / R Right Hand I Opening in / O Opening out			1461 - 1499	1471 - 1490	2100	£ 1658.90
BORDOR90/70LI1 BORDOR90/70LO1 BORDOR90/70RI1 BORDOR90/70RO1	Shower Door for with inline Panel for a 1600 mm width <i>Door 900 mm + Inline Panel 700 mm</i> L Left Hand / R Right Hand I Opening in / O Opening out			1561 - 1599	1571 - 1590	2100	£ 1745.82

Accessories

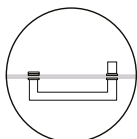

Handle Outside & Knob Inside

Included in prices above.
Shower doors bring horizontal square handle 25 x 10 mm, 457 mm width and 60 mm projection.
Suitable to be used as towel holder in the outside with knob in the inside.

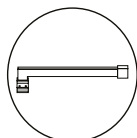

Angle Support Bar

Included in prices above.
Support bar for units narrower than 1200 mm.
Maximum length of bar 450 mm.
(3 parts, not pre-assembled)

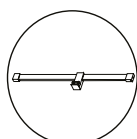

Double Support Bar

Included in prices above.
Support bar for units wider than 1200 mm.
Bar supplied at total width of unit ordered to be cut on site.
(4 parts, not pre-assembled)

Please NOTE

*Glass Options available: FLUTED, GREY TINTED or FROSTED glass available **plus additional 30% to prices shown.**
Please see page 5 for further detail on our glass.

*All RAL colours are available **plus additional 30% to prices shown.**

*When both RAL colour and Glass option chosen please add 50% to prices shown.

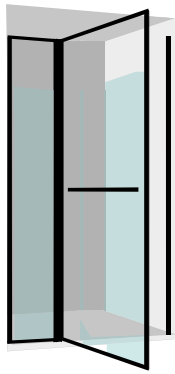

Left Hand
Opening **OUT**

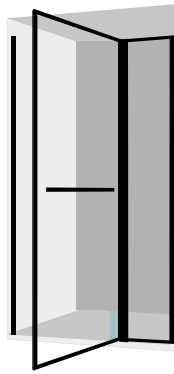

Right Hand
Opening **OUT**

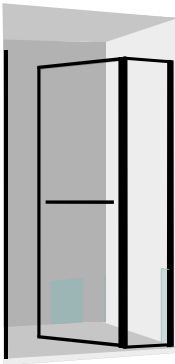

Right Hand
Opening **IN**

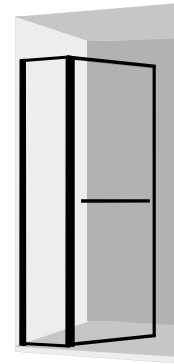

Left Hand
Opening **IN**



Shower Door hinged to **Inline Panel**

Drench recess shower solutions include a range of complimentary inline panels. Our standard range is carefully designed to keep the grid pattern balanced which is of paramount importance within our collection. The product is completed with a support bar which gives stability and durability to the enclosure. BESPOKE sizes are available, contact us for further information.

Features:



*Patent Pending

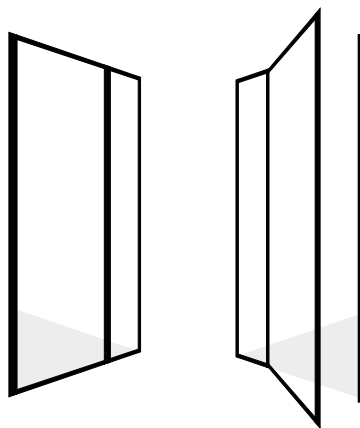

Shower Door

hinged to Inline Panel

Door is hinged to an Inline panel closing into a our closing profile in the wall. Both **left and right hand options available**. Code ending in L, means hinge on the Left and code ending in R, means hinge on the right.

Fixings, seals and every component of our standard shower door range is finished in **Matt Black**.

Please Adjustment range shown above before ordering. DRENCH is not liable for different dimensions on site.

Item Code	Specifications			Adjustment Range		Height (mm)	Retail Price (Exc VAT)
	Item Description	LH	RH	RECESS	WITH RETURN PANEL		
BORDOR70/20LI2 BORDOR70/20LO2 BORDOR70/20RI2 BORDOR70/20RO2	Shower Door for hinged to Inline Panel for a 900 mm width <i>Door 700 mm + Inline Panel 200 mm</i> L Left Hand / R Right Hand I Opening in / O Opening out			861 - 899	871 - 890	2100	£ 901.44
BORDOR70/30LI2 BORDOR70/30LO2 BORDOR70/30RI2 BORDOR70/30RO2	Shower Door for hinged to Inline Panel for a 1000 mm width <i>Door 700 mm + Inline Panel 300 mm</i> L Left Hand / R Right Hand I Opening in / O Opening out			961 - 999	971 - 990	2100	£ 1043.04
BORDOR90/30LI2 BORDOR90/30LO2 BORDOR90/30RI2 BORDOR90/30RO2	Shower Door for hinged to Inline Panel for a 1200 mm width <i>Door 900 mm + Inline Panel 300 mm</i> L Left Hand / R Right Hand I Opening in / O Opening out			1161 - 1199	1171 - 1190	2100	£ 1226.42
BORDOR70/70LI2 BORDOR70/70LO2 BORDOR70/70RI2 BORDOR70/70RO2	Shower Door for hinged to Inline Panel for a 1400 mm width <i>Door 700 mm + Inline Panel 700 mm</i> L Left Hand / R Right Hand I Opening in / O Opening out			1361 - 1399	1371 - 1390	2100	£ 1550.78
BORDOR90/60LI2 BORDOR90/60LO2 BORDOR90/60RI2 BORDOR90/60RO2	Shower Door for hinged to Inline Panel for a 1500 mm width <i>Door 900 mm + Inline Panel 600 mm</i> L Left Hand / R Right Hand I Opening in / O Opening out			1461 - 1499	1471 - 1490	2100	£ 1658.90
BORDOR90/70LI2 BORDOR90/70LO2 BORDOR90/70RI2 BORDOR90/70RO2	Shower Door for hinged to Inline Panel for a 1600 mm width <i>Door 900 mm + Inline Panel 700 mm</i> L Left Hand / R Right Hand I Opening in / O Opening out			1561 - 1599	1571 - 1590	2100	£ 1745.82

Accessories

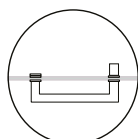

Handle Outside & Knob Inside

Included in prices above.

Shower doors bring horizontal square handle 25 x 10 mm, 457 mm width and 60 mm projection.

Suitable to be used as towel holder in the outside with knob in the inside.

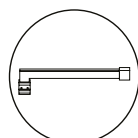

Angle Support Bar

Included in prices above.

Support bar for units narrower than 1200 mm.

Maximum length of bar 450 mm.

(3 parts, not pre-assembled)

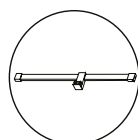

Double Support Bar

Included in prices above.

Support bar for units wider than 1200 mm.

Bar supplied at total width of unit ordered to be cut on site.

(4 parts, not pre-assembled)

Please NOTE

***Glass Options** available: FLUTED, GREY TINTED or FROSTED glass available **plus additional 30% to prices shown**.

Please see page 5 for further detail on our glass.

*All RAL colours are available **plus additional 30% to prices shown**.

*When both RAL colour and Glass option chosen please add 50% to prices shown.

Return Panels for Shower Enclosures

DRENCH doors may be paired with a range of return panels to create shower cubicles. Available in both, door closing onto return and door hinge from return.



Return panel configurations

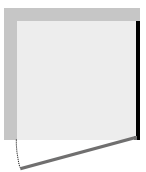

Right Hand
Return Panel for
Shower Door

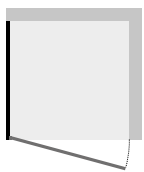

Left Hand
Return Panel for
Shower Door

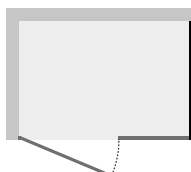

Right Hand
Return Panel for
Shower Door
with Inline panel

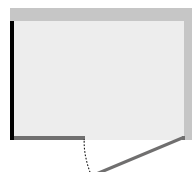

Left Hand
Return Panel for
Shower Door
with Inline panel

Closing Return panel configurations

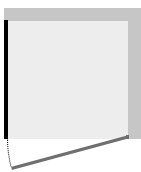

Left Hand
Closing Return
Panel for Shower
Door

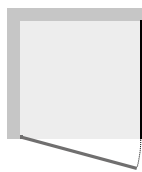

Right Hand
Closing Return
Panel for Shower
Door

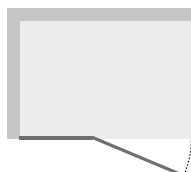

Right Hand
Closing Return
Panel for Shower
Door hinged to
Inline panel

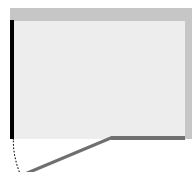

Left Hand
Closing Return
Panel for Shower
Door hinged to
Inline panel

Please NOTE

***Support Bar for Return Panel** included on prices shown.

***Return panels shown are suitable for Opening OUTWARDS configurations ONLY.**

For opening inwards please contact us.

***Glass Options** available: FLUTED, GREY TINTED or FROSTED glass available **plus additional 30% to prices shown.**

Please see page 5 for further detail on our glass.

*All RAL colours are available **plus additional 30% to prices shown.**

*When both RAL colour and Glass option chosen please add 50% to prices shown.

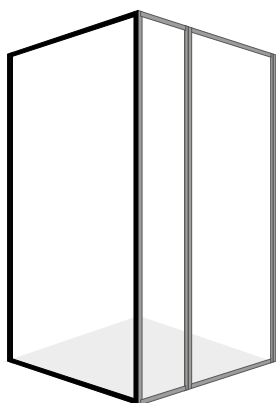





Return

Panel for Shower Enclosures

Suitable for **Door with Inline Panel and Shower doors closing on to the wall.**
Items below bring wall fixings and corner post included.

Please note Return panels are always sold as part of an enclosure; to be installed with **Shower doors, shower doors with inline or shower doors hinged to inline.**
Please note the **Adjustment** before ordering. We manufacture our Shower Enclosures to fit standard Shower tray sizes and any wet room configuration.

Item Code	Specifications		Adjustment (mm)	Height (mm)	Retail Price (Exc VAT) for Clear Glass
	Item Description	LAYOUT			
BORRTN70L BORRTN70R	Return Panel 700 mm width Wall fixing and Corner post included. L Left Hand / R Right Hand		664 - 693	2100	£ 634.94
BORRTN80L BORRTN80R	Return Panel 800 mm width Wall fixing and Corner post included. L Left Hand / R Right Hand		764 - 793	2100	£ 675.22
BORRTN90L BORRTN90R	Return Panel 900 mm width Wall fixing and Corner post included. L Left Hand / R Right Hand		864 - 893	2100	£ 725.04
BORRTN100L BORRTN100R	Return Panel 1000 mm width Wall fixing and Corner post included. L Left Hand / R Right Hand		964 - 993	2100	£ 879.80

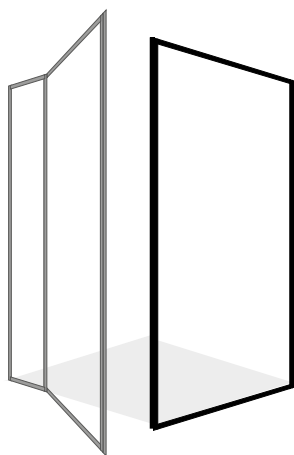





Closing Return

Panel for Shower Enclosures

Suitable for **Door hanging from Inline Panel and Shower doors closing on to a return panel.** Return panels below bring closing post preassembled in one side of the screen.

Please note Return panels are always sold as part of an enclosure; to be installed with **Shower doors, shower doors with inline or shower doors hinged to inline.**
Please note the **Adjustment** before ordering. We manufacture our Shower Enclosures to fit standard Shower tray sizes and any wet room configuration.

Item Code	Specifications		Adjustment (mm)	Height (mm)	Retail Price (Exc VAT) for Clear Glass
	Item Description	LAYOUT			
BORCLRTN70L BORCLRTN70R	Return Panel with closing post 700mm width Wall fixings included. L Left Hand / R Right Hand		671 - 690	2100	£ 634.94
BORCLRTN80L BORCLRTN80R	Return Panel with closing post 800mm width Wall fixings included. L Left Hand / R Right Hand		771 - 790	2100	£ 675.22
BORCLRTN90L BORCLRTN90R	Return Panel with closing post 900mm width Wall fixings included. L Left Hand / R Right Hand		871 - 890	2100	£ 725.04
BORCLRTN100L BORCLRTN100R	Return Panel with closing post 1000mm width Wall fixings included. L Left Hand / R Right Hand		971 - 990	2100	£ 879.80



ACCESSORIES
& Spare parts

Shower Door **Handles**



DRENCH Shower doors bring horizontal square handle 25 x 10 mm, 457 mm width and 60 mm projection.

Suitable to be used as towel holder in the outside with knob in the inside; it is the perfect accessory for our Shower doors.

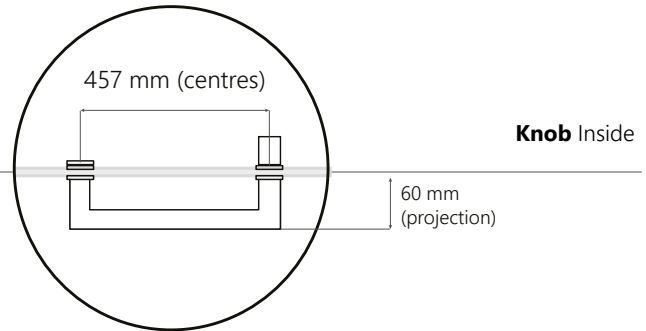

Horizontal handle Outside

Other handle options are available as per items and specifications below.

Every handle option is suitable for Shower Doors FRAME, DECO, LINEA or BORDER Collection.

Standard Handle with knob detail.

Item Code	Specifications			Retail Price (Exc VAT)
	Item Description	LAYOUT	DETAIL	
PHAND	Finger pull handle , 225 mm height. Specs as per drawing and detail. - No assembly required. **Pull handle is attached to closing profile in the shower door in both internal and external side**			+ £147.00 <i>*To be specified when order is placed.</i>
VSQHAND	Square vertical handle , 202 mm height (Centres). Specs as per drawing and detail. - 2 Parts + fixings. Not preassembled. **Please follow assembly instructions in the box**			+ £147.00 <i>*To be specified when order is placed.</i>
HSQHAND2	Square horizontal handle , 457 mm width (Centres). Specs as per drawing and detail. - 2 Parts + fixings. Not preassembled. **Please follow assembly instructions in the box**			+ £147.00 <i>*To be specified when order is placed.</i>
VRDHAND	Round vertical handle , 202 mm height (Centres). Specs as per drawing and detail. - 2 Parts + fixings. Not preassembled. **Please follow assembly instructions in the box**			+ £147.00 <i>*To be specified when order is placed.</i>
HRDHAND	Round horizontal handle , 457 mm width (Centres). Specs as per drawing and detail. - 2 Parts + fixings. Not preassembled. **Please follow assembly instructions in the box**			+ £147.00 <i>*To be specified when order is placed.</i>

Please NOTE

*Any Handle option above must be specified when order is placed otherwise Standard handle with knob will be supplied.

*Due to technical characteristics and assembly reasons handle option cannot be changed retrospectively.

Support Bars

DRENCH fixed panel range items will always bring the correct support bar specified when order is placed. However, **support bars are also available** as an individual item as per range and prices below.

Please do not hesitate to contact if any further assistance required. sales@drenchshowers.co.uk

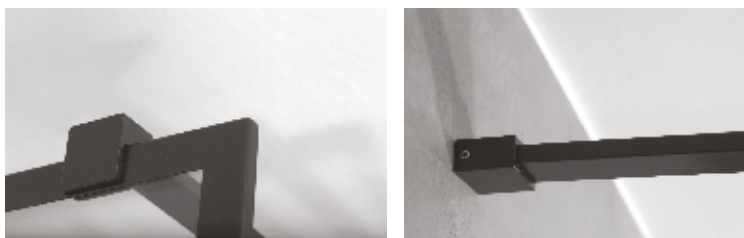

Support Bars for FRAME Collection Fixed Panels

Item Code	Specifications		LAYOUT		Retail Price (Exc VAT)
	Item Description				
FXFRACRS	Support bar across <i>Not preassembled, 3 pieces + fixings.</i> Bar: 30 x 10 mm Length: To be specified when order is placed. Max length 1600 mm (*)				£89 <i>*Length To be specified when order is placed.</i>
FXFRANGL	90° Angled support bar. <i>Not preassembled, 3 pieces + fixings.</i> Bar: 30 x 10 mm Length: 350 mm Not suitable for Panels wider than 1000 mm.				£72
FXFRACLN	Support bar to ceiling <i>Not preassembled, 3 pieces + fixings.</i> Bar: 30 x 10 mm Length: 400 mm Not suitable for panels wider than 1000 mm.				£72
FXFRADBL	Return panel support bar. <i>Not preassembled, 4 pieces + fixings.</i> Bar: 30 x 10 mm Length: Max 2000 mm. <i>To be specified on order.</i> Suitable for 2 panels.				£101

Support Bars for DECO, LINEA & BORDER Collection Fixed Panels

Item Code	Specifications		LAYOUT		Retail Price (Exc VAT)
	Item Description				
FXSBCRS	Support bar across <i>Not preassembled, 3 pieces + fixings.</i> Bar: 30 x 10 mm Length: To be specified when order is placed. Max length 1600 mm (*)				£89 <i>*Length To be specified when order is placed.</i>
FXSBNGL	90° Angled support bar. <i>Not preassembled, 3 pieces + fixings.</i> Bar: 30 x 10 mm Length: 350 mm Not suitable for Panels wider than 1000 mm.				£72
FXSBCLN	Support bar to ceiling <i>Not preassembled, 3 pieces + fixings.</i> Bar: 30 x 10 mm Length: 400 mm Not suitable for panels wider than 1000 mm.				£72
FXSBDBL	Return panel support bar. <i>Not preassembled, 4 pieces + fixings.</i> Bar: 30 x 10 mm Length: Max 2000 mm. <i>To be specified on order.</i> Suitable for 2 panels.				£101

(*) Please note prices for both FXFRACRS and FXSBCRS are for Support bars up to 1600 mm. If any longer dimensions required please contact. sales@drenchshowers.co.uk

Extension **Wall profiles**



Wall Channel detail picture

DRENCH Standard wall profiles give **19 mm of adjustment/each (+/-9,5mm)**.

Every item in this catalogue shows an adjustment range which is important to take into consideration before ordering.

The adjustment is given showing a Minimum point and a Maximum point as per below:

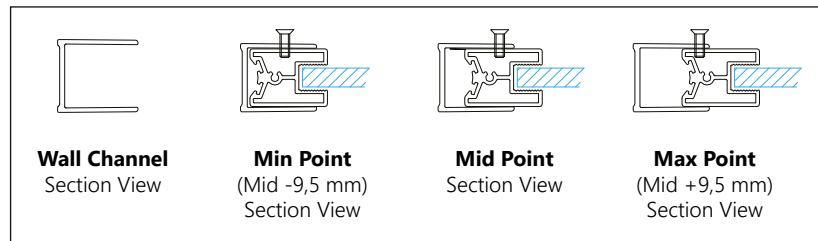

Our standard adjustment can be increased. DRENCH offers 2 additional profiles as detailed below to extend your shower enclosure. Profiles below are supplied individually and include fixings. For bespoke sizes please contact. sales@drenchshowers.co.uk

Item Code	Specifications		Retail Price (Exc VAT)
	Item Description	LAYOUT	
PREXT145	<p>Extended Wall Channel (+/-14.5 mm). <i>Deeper wall channel to extend Shower unit.</i></p> <p>Dimensions: Width: 45 mm/Depth: 29 mm Length: 2100 mm.</p>		<p>£59</p> <p>£61</p>
PREXT400	<p>Extended Box Section (+ 40 mm). <i>Box Section to extend 40 mm Shower Unit width</i></p> <p>Dimensions: Width: 40 mm/Depth: 30 mm Length: 2100 mm.</p>		

Please NOTE

*All RAL colours are available subject to minimum order surcharge. Please contact if any

WARRANTY TERMS

DRENCH products have a lifetime warranty against faulty materials or workmanship according to the following rules:

- Proof of purchase in the form a receipt or invoice is required in order to validate the guarantee.
- In the event that a product is faulty the defect must be notified to our technical department within 30 days of the fault happening.
- The product has been purchased in one of our authorised dealers for normal domestic use and it was not purchased as an ex-showroom display.
- The product has not been handled carelessly or misused and has not been wilfully damaged, neglected or used in abnormal conditions.
- The product has not been modified, altered or transformed in any way.
- The guarantee will not apply in the event of any repair if DRENCH EUROPE LTD had not been informed accordingly and it was not carried out under DRENCH EUROPE LTD authorisation/ supervision.
- The guarantee will not apply if installation, use and maintenance has not been carried out in accordance with DRENCH EUROPE LTD installation instructions.
- Damages and breakage of glass are not covered by the guarantee as all glass used by DRENCH EUROPE LTD conforms to EN12150-1.
- Fair wear and tear of the product and lime scale and mildew are excluded from the guarantee.
- Seals, subject to wear and tear are guaranteed only for a period of 12 months.
- Labour costs are not covered under guarantee unless specifically authorised in writing by DRENCH EUROPE LTD.
- The benefit of this guarantee cannot be assigned.

- The guarantee does not cover any further right than those expressed above and it does not cover any claim for consequential loss or damaged.
- This guarantee is offered as an extra benefit and does not affect your statutory right as a consumer in any way whatsoever.
- In the event of a claim under our guarantee a site visit is required which will be chargeable. This will be refunded in the event that the product is defective or manufactured incorrectly.

In the event that a replacement product is required and the product is no longer available, Drench Europe will replace it with the nearest available product.

TERMS AND CONDITIONS

Definitions

1. 'Company' means DRENCH EUROPE LTD.
2. 'Customer' means customer of the Company.
3. 'Conditions' means the below conditions of sale.
4. 'Contract' means any contract entered into for the sale of goods by the Company to the customer.
5. 'Goods' means any Goods the subject of any contract and shall include any part or parts of them and materials incorporated in them.
6. "Standard Items" means any item included in pricelist/catalogue with a specific description of size, colour and configuration.
7. "Bespoke" or "Non-standard items" mean any item manufactured made to measure as per customer request. Items in any specific RAL colour are considered "Bespoke" or "Non-Standard" despite size or configuration.
8. 'Carrier' the company person or persons with the object of delivering the Goods to the Customer.

TERMS & CONDITIONS OF SALE:

1. All orders are subject to these Conditions unless otherwise agreed. All goods are subject to availability. If you do not understand any of the following please e mail us at us at sales@drencheurope.co.uk or telephone 02380274945.
2. These Conditions represent the entire Conditions of sale and nothing shall operate to in any way alter or vary the Conditions without the prior approval of DRENCH EUROPE LTD.
3. These conditions shall apply to all contracts to the exclusion of all other conditions express or implied by statute or otherwise to the extent as is permissible by law.
4. Acceptance of Goods by the Customer shall be conclusive evidence before any Court of Arbitrator that these Conditions apply. DRENCH EUROPE LTD reserves the right to change the Conditions without prior notice. Customers are advised to check for any variations to the Conditions before an order.

PRODUCTS:

1. All items sold are brand new products and are supplied complete with full manufacturers guarantee.
2. All items are delivered with fixings and instructions for installation. For any further information please email us at sales@drencheurope.co.uk
3. It is very important that both Installation and Assembly of DRENCH Products are performed by qualified professionals and according to instructions supplied.

All images, specifications and advertising on our website are for the sole purpose of giving an approximate description of the goods. All information given to the Customer is approximate and intended as a guide only. We always endeavour to ensure all product descriptions are correct, but

we advise customers to seek technical advice from qualified sources prior to ordering products including any installation work that may be required.

PRICES:

All prices featured in this price list are recommended retail prices including VAT. DRENCH EUROPE LTD does not accept liability for any mistake or calculation error made when drawing up a quotation.

ORDERS:

Orders may be placed via Agents, Sales Representatives or directly submitted to our Commercial Department. A written format may be required when placing an order. DRENCH EUROPE LTD do not accept orders via phone or any other means other than email/post. DRENCH EUROPE LTD reserves the right to refuse any order. Orders are accepted on the basis the Customer has read and accepted these conditions.

CANCELLATIONS & MODIFICATIONS:

No order cancellation or modification will be accepted once the manufacturing process has started. In any event, there is a maximum period of 24 hours from receipt of order to ask for any modification or cancellation.

To exercise your right of cancellation within 24 hours after receipt of order you must give notice by post, telephone or by emailing us at sales@drencheurope.co.uk giving details of goods ordered and the delivery details, we will then contact you and supply a confirmation of cancellation. Orders can only be cancelled once this confirmation has been provided, any claims for cancellation will not be entertained unless a confirmation can be supplied.

If any order is cancelled before you receive the goods, all delivery and collection costs that have been incurred from our transport company will be your responsibility and this will be deducted from the amount refunded.

DELIVERY:

Please check all deliveries for damages or discrepancies within 48 hours from receiving the goods. Claims for damaged goods must be notified to DRENCH EUROPE LTD you within 48 hours by telephone, email or phone and confirmed within 2 days by e-mail stating any damages and/or defects of the goods received from the courier. Unless we have notification within this time period, we have no claim against the courier and therefore we will not be liable for any claim made against our company. Please note that all items must be removed from the packaging and checked within the above time scale, please check all contents.

RETURN POLICY:

We hope that you are happy with your purchase but should you wish to return any item to us, the return of the goods must be done subject to the following conditions:

1. The return of goods will only be admitted when it has been accepted and communicated accordingly by DRENCH Commercial department.
2. The return of goods will only be admitted with the condition as new, in the packaging provided and with all the components provided in the initial delivery.
3. Bespoke and non-standard items are non-returnable.
4. The goods must not have been installed or attempted to be installed. (Please do not return items that have been installed as no refund will be given)
5. Customers are responsible for obtaining proof of delivery and receipt of returned goods. It is the responsibility of the customer to ensure that returned item(s) reach us in good condition.

RETURNS ADDRESS:

DRENCH EUROPE LTD
Unit 5 & 6 Deerpark Farm, Hursley Road
Hursley SO21 2LD, Hampshire
United Kingdom

RETENTION OF TITLE:

1. The Goods shall be at the Buyer's risk as from delivery.
- 1.2 In spite of delivery having been made property of the Goods shall not pass from the Seller until:
 - 1.2.1 The Buyer shall have paid the Price in full; and
 - 1.2.2 No other sums of any kind shall be due from the Buyer to the Seller.

PAYMENT CONDITIONS:

Payments can be made by BACS transfer or Cheque. Payment terms may be agreed between Agents, Sales Representative or Drench Commercial Department and the customer.

In the event of outstanding payments DRENCH EUROPE LTD will not dispatch any goods.

DIVISIBILITY CLAUSE

This contract is divisible. Each delivery made hereunder: 1) shall be deemed to arise from a separate contract, and 2) shall be invoiced separately and any invoice for a delivery shall be payable in full in accordance with the terms of payment provided for herein without reference to and notwithstanding any defect of default in delivery of any other instalment.

The Collections

DRENCH
INSPIRE BY DESIGN

Unit 5 & 6 Deer Park Farm
Hursley Road
Hursley
SO21 2LD
Hampshire

+44 (0) 2380 274 945
sales@drenchshowers.co.uk

www.drenchshowers.co.uk