

G



05

GOALIE CATALOGUE



When you're born to play™

# When you're born to play

Leading the way. That's what we've been doing now for over 100 years. That's what we're dedicated to do for many years to come. Dedicated to make a difference, dedicated to improve your game.

Developed in conjunction with the most impressive line-up of pro goalies such as **Martin Brodeur**, **Ed Belfour**, **Olaf Kolzig** and **Marc Denis**, our line of goalie equipment stands out from the crowd with its clear focus on innovation and performance. Results speak for themselves. New Jersey Devils' goaltender Martin Brodeur won the Vezina Trophy and a World Cup Championship title wearing CCM's Gatekeeper Series.

The NHL<sup>1</sup> Platinum Shield Collection.



We work closely with NHL<sup>1</sup> players to bring you the best products in the industry. CCM<sup>®</sup> equipment bearing the NHL<sup>1</sup> Platinum Shield are those same select pieces of authentic hockey equipment that meet the highest standards of NHL<sup>1</sup> pro players.

Our commitment to the game is also reflected in our continued support of hockey leagues across the world. Ground-breaking partnerships with the AHL<sup>1</sup>, ECHL<sup>1</sup> and CHL<sup>1</sup> make CCM<sup>®</sup> the most visible brand in hockey today and for many years to come. It also guarantees that every piece of equipment we put on the market was tested and approved by the best players in the game.

Premier Equipment Supplier



**CCM**  
When you're born to play™

## TABLE

## OF CONTENTS

2	→	Gatekeeper™ Series
6	→	Blockade™ Series
16	→	Gatekeeper™ Arm & Body
20	→	Gatekeeper™ Pants
26	→	CCM™ Composite Stick
28	→	CCM™ Sticks
30	→	Goalie Masks
32	→	Accessories

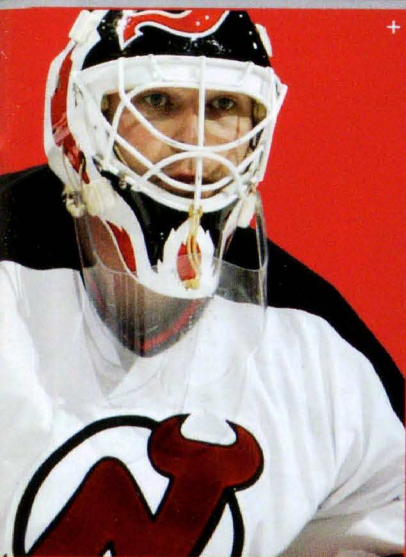

**Martin Brodeur**  
New Jersey Devils  
2004 World Cup Champion  
2004 Vezina Trophy  
1995, 2000 and 2003 Stanley Cup Champion  
2002 Olympic Gold Medalist



**Ed Belfour**  
Toronto Maple Leafs  
1993 Vezina Trophy  
1994 Stanley Cup Champion  
1999 William M. Jennings Trophy



**Olaf Kolzig**  
Washington Capitals  
2000 Vezina Trophy

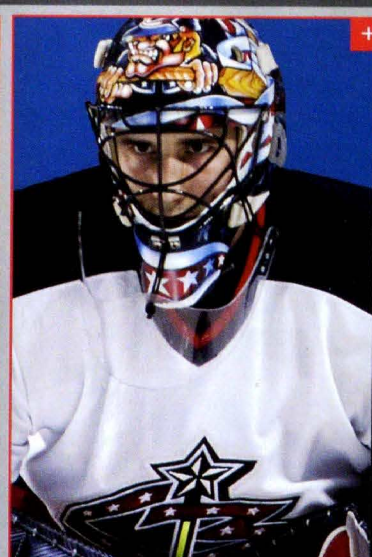

**Marc Denis**  
Columbus Blue Jackets  
Most Minutes Played in season 2003-04



Martin Brodeur  
New Jersey Devils

## Gatekeeper™

Control your performance with an optimized transitioned design adapted to the needs of today's goalie.

### **Domination: Optimized blocking surface**

- Tapered thigh rise for better "control" in stand up position
- Square outer rolls and shallow boot channel for better "control" in butterfly position
- Flat shin and knee "control" rebound and weight

### **Dexterity: Optimized speed**

- Anatomically positioned knee and calf support system controls your speed when going in butterfly position
- Dual knee flex for optimized blocking surface in butterfly position
- Adjustable knee cushion increases comfort to your knees in "V" position

### **Moisture Management System: Optimized dry time**

- Ultima Dry™ liner minimizes water absorption and decreases drying time
- Combat Superknit optimizes durability and "control" of moisture in the material
- AgION™ treatments "control" odor and prevent bacterial and fungal growth

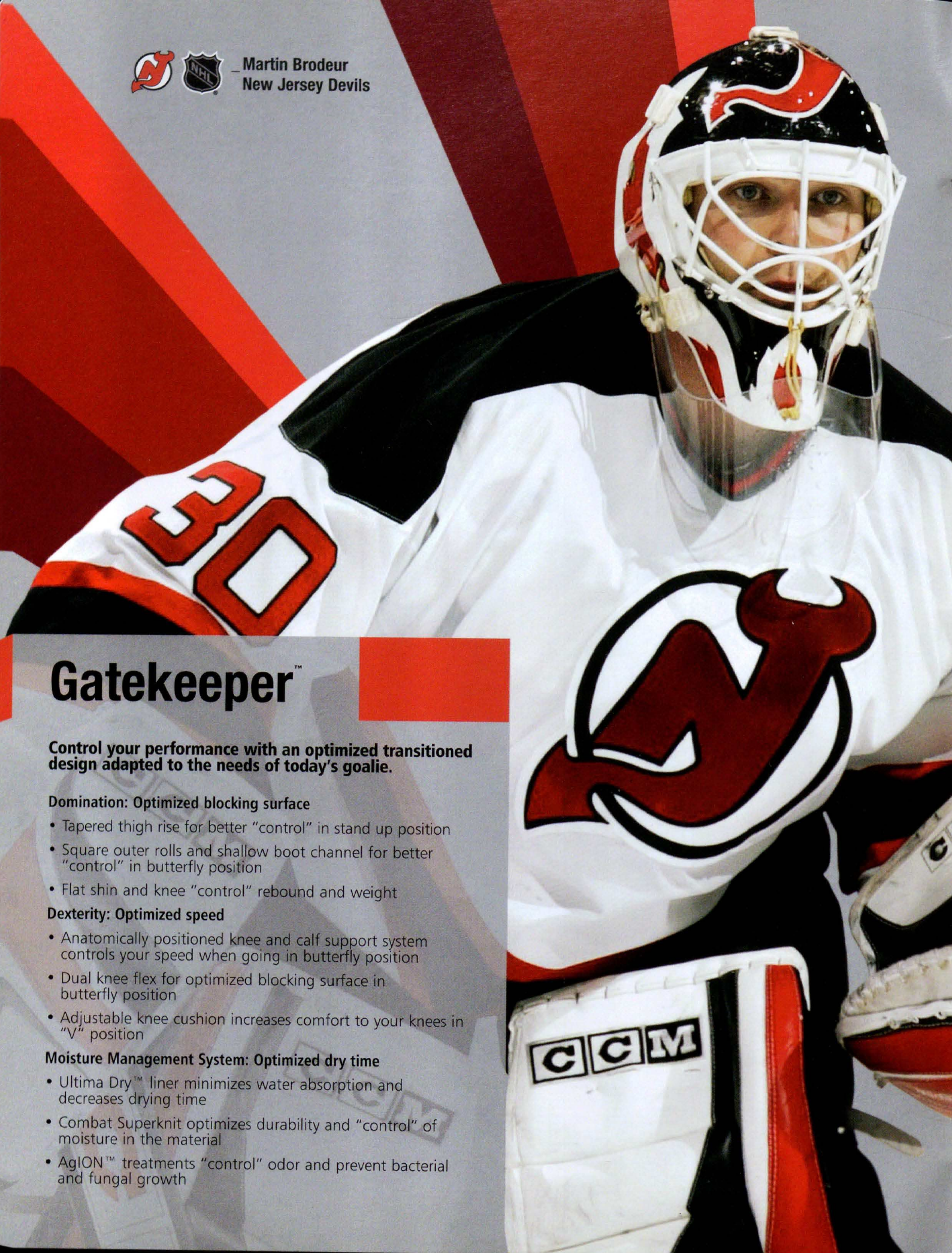

G

**\_ Tapered Thigh Rise**

Tapered thigh rise for better "control" in stand up position

**\_ Square Vertical Rolls**

Square vertical rolls increase coverage in both stand up and butterfly position

**\_ Knee Breaks**

2 knee breaks increase coverage in butterfly position

**\_ Flat Knee Rolls**

Flat knee rolls for rebound control and weight reduction

**\_ Shallow Boot Channel**

Shallow boot channel increases width and maximizes skate pivot



**Gatekeeper™ PRO Pad**

# Gatekeeper™ Series



Featuring the NHL® Platinum Shield.

Thigh rise	+1" to customize the fit with thin profile
Knee	Flat knee rolls for rebound control and weight reduction
Boot	Shallow boot channel increases width and maximizes skate pivot
Last	100% foam construction, HD/LD, lightweight and consistent in shape
Knee	Cradle suspension system controls the rotation of the knee when going into butterfly
Calf	Suspension system gives a better support to the leg
Liner	ULTIMA DRY™ anti-microbial ULTRA FRESH™ liner for an optimal blend of comfort, durability and moisture management
Straps	Nylon webbing with plastic buckles increases durability and decreases weight
Knee breaks	2 knee breaks increase coverage in butterfly position
Rolls	Square vertical rolls increase coverage in both stand up and butterfly position
Colors	White/Black/Silver, White/Red/Black, Black/White/White, Navy/Silver/White
Sizes	*31"+1, 32"+1, 33"+1, 34"+1, 35"+1, 36"+1**All stock sizes come with an extra 1" at the thigh rise
	Also available in custom colors and sizes

## GATEKEEPER™ PRO PAD SERIES



### FEATURES

**GATEKEEPER™**



- 1 ULTIMA DRY™ anti-microbial ULTRA FRESH™ lining in calf and knee for an optimal blend of comfort, durability and moisture management
- 2 Cradle suspension system controls the rotation of the knee when going into butterfly

## GATEKEEPER™ PRO GLOVE SERIES



Featuring the NHL® Platinum Shield.

<b>"T"</b>	Design with a deeper pocket for better control when playing the puck
<b>Cuff</b>	Two-piece design allows greater wrist flexibility and control
<b>Knuckles</b>	Open knuckles for better fit and freedom of movement
<b>Palm</b>	Synthetic felt with foam insert for easier break in
<b>Break</b>	All Pro Gatekeeper™ gloves are steamed for "game ready" feeling
<b>Protection</b>	Molded high-density foam finger protector for increased protection when freezing the puck
<b>Liner</b>	ULTIMA DRY™ anti-microbial ULTRA FRESH® liner for an optimal blend of comfort, durability and moisture management
<b>Straps</b>	Two way strapping system, wrist and top of hand
<b>Flex</b>	Flexible cuff increases puck control around the net
<b>Combat</b>	COMBAT SUPERKNIT provides comfort and moisture management
<b>Colors</b>	White/Black/Silver, White/Red/Black, Black/White/White, Navy/Silver/White
<b>Sizes</b>	Medium, Large, Regular and Full Right



## FEATURES

- 1 Traditional mid 60° break provides great fit and optimized control when playing the puck
- 2 Open knuckle design for better fit and control
- 3 ULTIMA DRY™ palm and COMBAT SUPERKNIT for maximum moisture control



## GATEKEEPER™ PRO BLOCKER SERIES



Featuring the NHL® Platinum Shield.

<b>Insert</b>	Lightweight design using HD/LD foam for maximum control and balance
<b>Thumb</b>	Extra protection in the thumb extends to the first finger
<b>Finger</b>	Extra protection for the index and top finger using HD foam
<b>Cuff</b>	Open in two pieces for increased fit
<b>Strap</b>	Wrist strap attachment for custom fit
<b>Palm</b>	PITTARD® palm, goat skin leather palm with seamless finger and Silicone Dot nash maximize fit and increase durability
<b>Gussets</b>	3D mesh palm and thumb gusset provide greater air circulation
<b>Combat</b>	COMBAT SUPERKNIT provides comfort, moisture management and greater durability
<b>Balance</b>	Design maximizes weight balance
<b>Colors</b>	White/Black/Silver, White/Red/Black, Black/White/White, Navy/Silver/White
<b>Sizes</b>	Regular (legal) and Full Right



## FEATURES

- 1 Lightweight blocking insert optimizes blocking surface and controls balance
- 2 COMBAT SUPERKNIT open cuff for better flex and greater fit for the arm & body
- 3 Pittard's palm with seamless finger for better fit and less moisture absorption - Nash SILICONE DOTS for better grip





Marc Denis  
Columbus Blue Jackets

# Blockade®

The equipment line that revolutionized goaltending.

## Control : Maximize blocking surface

- The maximized square design allows goalies to always be square with the shooter and control the direction of the puck
- The ergonomic fit improves equipment responsiveness and comfort

## Agility : Quicker response

- Use of ultra-light materials makes for some of the lightest equipment ever developed
- Perfectly balanced equipment for quicker reaction time

## Heritage : Be part of history

- CCM® has been the industry leader for more than 100 years
- The Blockade® series was developed to increase net coverage in any style of play without restrictions, using lightweight foam and performance driven technology

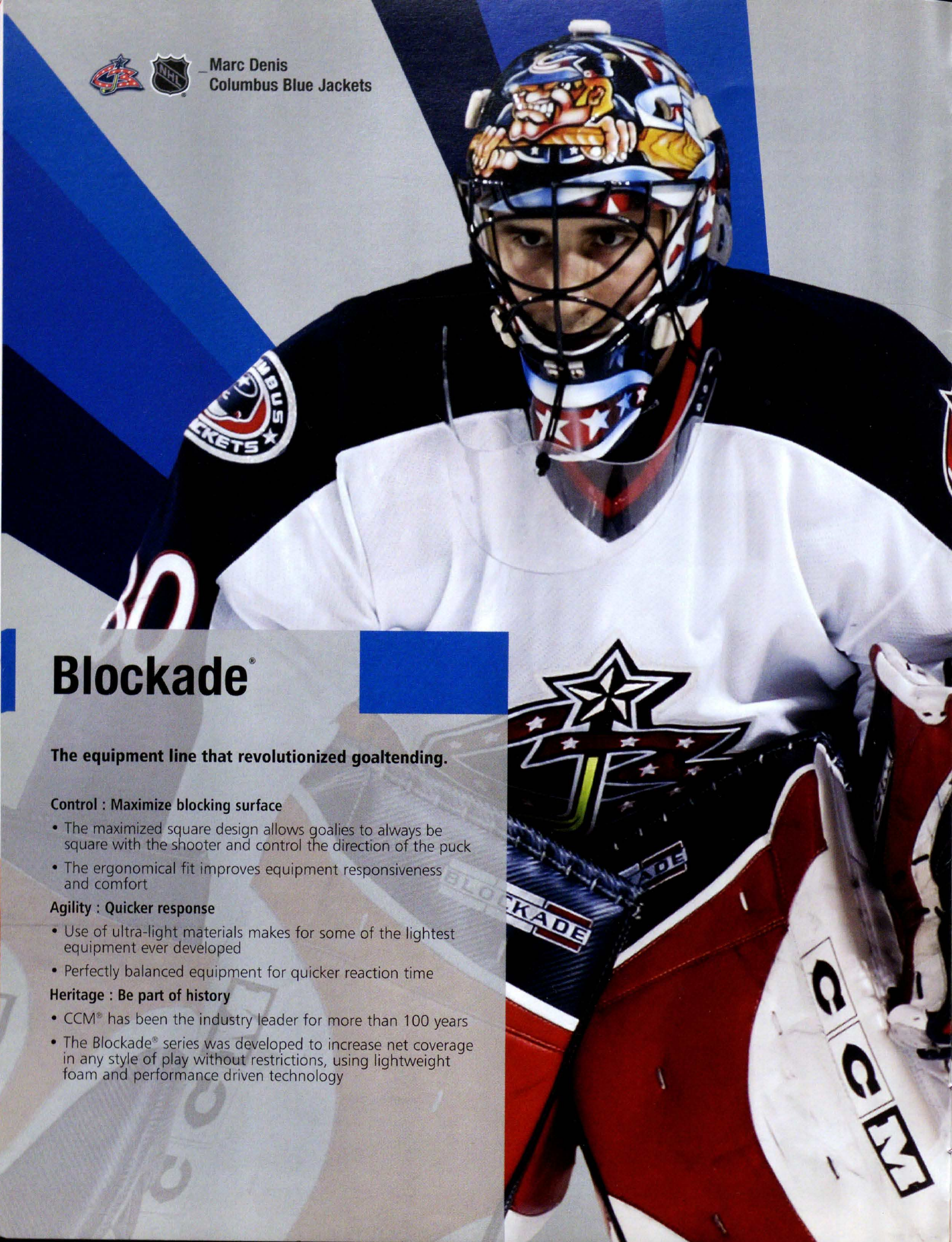



**B**

**Upper Knee Break**

Upper knee break to help close 5 hole in butterfly position

**30 Degree Roll**

30 degree vertical roll generates deflection control and maximizes blocking surface in butterfly position

**Uniform Flat Front**

Uniform flat front design provides absolute puck rebound control

**Shallow Boot Channel**

Shallow boot channel allows maximum width and better skate pivot

Use of ultra-light materials makes for some of the lightest equipment ever developed



**Blockade PRO Pad**

Rebound	Uniform flat front design provides absolute puck rebound control
Deflection	30 degree vertical roll generates deflection control and maximizes blocking surface in butterfly position
Suspension	Ergonomical knee and calf cradle suspends the leg to control the rotation of the pad when in stand up and butterfly position
Foam	High-density foam inside gusset squares the front of the pad, providing additional blocking surface
Boot	Shallow boot channel allows the skate to pivot when going in butterfly position
Straps	Nylon webbing straps with plastic buckles for durability and lightweight
Liner	H:O Control™ liner for increased fit and better moisture management
Colors	White/Red/Black, White/Blue/Black, White/Silver/Red, White/Black
Sizes	32", 33", 34", 35"

\*Also available in custom colors and sizes



## BLOCKADE® PRO PAD SERIES

### FEATURES

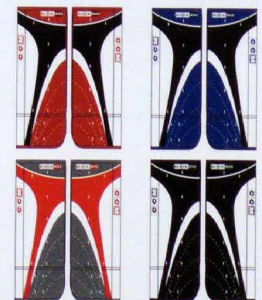
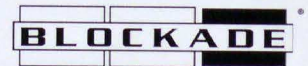

- 1 Ergonomic ultra lightweight EPP knee and calf cradle suspends the leg to control the rotation of the pad when playing stand-up and butterfly
- 2 H:O Control™ liner for increased fit and better moisture management

## BLOCKADE® PRO GLOVE SERIES

<b>Uniform</b>	One-piece thumb and cuff design keeps the glove square to the shooter providing greater blocking surface
<b>Moisture</b>	Construction allows the knuckle pad to completely fold open to dry the H:O Control™ inside palm
<b>Cuff</b>	Contoured cuff design allows greater wrist flexibility when playing and freezing the puck
<b>Break</b>	All Pro Blockade® gloves are steamed to provide a "game ready" feel
<b>Protection</b>	Molded high-density foam finger protector provides the greatest protection
<b>Straps</b>	3-way strapping system, finger, hand, wrist for custom fit and better feel with comfort pad at the wrist
<b>Pocket</b>	Extended pocket for better coverage
<b>Colors</b>	White/Red/Black, White/Blue/Black, White/Silver/Red, White/Black
<b>Sizes</b>	Large, Full Right

\*Also available in custom colors

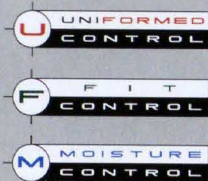

## FEATURES

- 1 Uniform one-piece thumb and cuff design keeps the glove square with the shooter to provide a greater blocking surface
- 2 Construction allows the knuckle pad to completely fold open to dry the H:O Control™ inside palm
- 3 Finger-cinching system provides an improved fit and additional glove control when opening the glove



## BLOCKADE® PRO BLOCKER SERIES

<b>Gravity</b>	GRAVITY CONTROL TECHNOLOGY™ provides greater wrist control to prevent torque
<b>Deflection</b>	High-density molded foam design allows the goalie to control the puck deflection on the blocker face
<b>Cuff</b>	Contoured cuff design allows greater wrist flexibility when playing the puck
<b>Finger</b>	3-piece finger protection offers increased protection in butterfly and paddle down
<b>Protection</b>	High-density foam protection for the wrist and thumb
<b>Straps</b>	VELCRO® wrist straps for custom fit
<b>Comfort</b>	Comfort foam improves comfort at the back of the hand and wrist
<b>Gusset</b>	3D mesh palm gusset and thumb provides greater air circulation
<b>Colors</b>	White/Red/Black, White/Blue/Black, White/Silver/Red, White/Black
<b>Sizes</b>	Regular, Full Right

\*Also available in custom colors



## FEATURES

- 1 Ultra thin dual density molded foam technology brings the center of gravity closer to the back of the hand to optimize blocker control
- 2 High-density foam protection for the wrist and thumb
- 3 Improved flexibility at the wrist with the two piece contoured cuff design



## BLOCKADE® INT PRO PADS

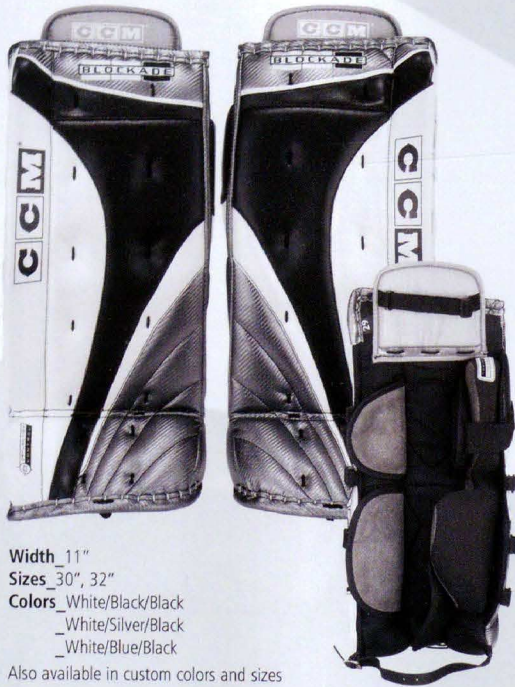

Width 11"  
 Sizes 30", 32"  
 Colors \_White/Black/Black  
 \_White/Silver/Black  
 \_White/Blue/Black  
 Also available in custom colors and sizes

## BLOCKADE® SR PADS



Width 12"  
 Sizes 32", 34", 36"  
 Colors \_White/Red/Black  
 \_White/Blue/Black  
 \_White/Black/Black

## BLOCKADE® JR PADS



Width 10"  
 Sizes 26", 28", 30"  
 Colors \_White/Blue/Black  
 \_White/Black/Black

## BLOCKADE® YTH PADS



Width 9"  
 Sizes 20", 22", 24"  
 Colors \_White/Black/Black

## SPECIFICATION CHART

		INT	SR	JR	YTH
<b>Rebound</b>	Uniform flat front design provides absolute puck rebound control	•	•	•	•
<b>Deflection</b>	30 degree vertical roll generates deflection control and maximizes blocking surface in butterfly position	•	•	•	•
<b>Suspension</b>	Ergonomical knee and calf cradle suspends the leg to control the rotation of the pad when in stand up and butterfly position	•	•	•	
	Low-density foam inner knee and calf for comfort and protection				•
<b>Foam</b>	High-density foam inside gusset squares the front of the pad, providing additional blocking surface	•			
	Low-Density foam inside gusset squares the front of the pad, providing additional blocking surface and lightweight		•	•	•
<b>Boot</b>	Shallow boot channel allows the skate to pivot when going in butterfly position	•	•	•	•
<b>Straps</b>	Nylon webbing straps with plastic buckles for durability and lightweight	•	•	•	•
<b>Liner</b>	H <sub>2</sub> O Control™ liner for increased fit and better moisture management	•			
	Nash inner knee and calf for comfort		•	•	
	Nylon inner knee and calf for comfort and better knee rotation				•

INT PRO

SR

JR

YTH

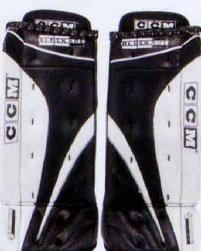
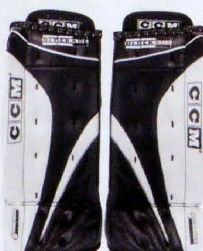
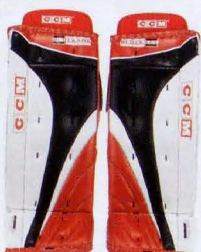
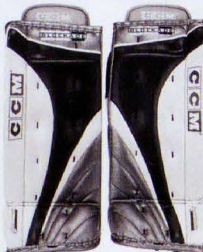

BLOCKADE® INT PRO GLOVE



Sizes Regular and Full Right  
 Colors \_White/Black/Black  
 \_White/Silver/Black  
 \_White/Blue/Black  
 Also available in custom colors

BLOCKADE® SR GLOVE



Sizes Regular and Full Right  
 Colors \_White/Red/Black  
 \_White/Blue/Black  
 \_White/Black/Black

BLOCKADE® JR GLOVE

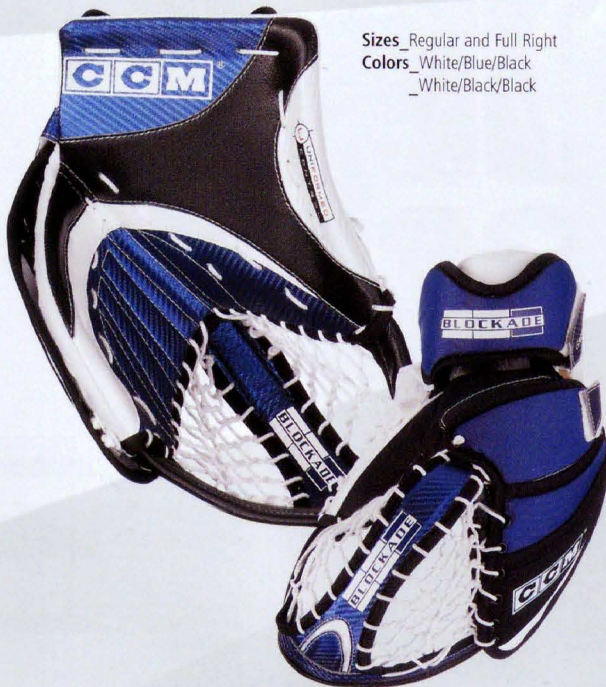

Sizes Regular and Full Right  
 Colors \_White/Blue/Black  
 \_White/Black/Black

BLOCKADE® YTH GLOVE



Sizes Regular  
 Colors \_White/Black/Black

## SPECIFICATION CHART

		INT	SR	JR	YTH
<b>Uniform</b>	One-piece thumb and cuff design keeps the glove square to the shooter providing greater blocking surface	.	.	.	.
<b>Moisture</b>	Construction allows the knuckle pad to completely fold open to dry the H <sub>2</sub> O Control™ inside palm	.			
	Construction allows the knuckle pad to completely fold open to dry the nash inside palm		.	.	.
<b>Cuff</b>	Contoured cuff design allows greater wrist flexibility when playing and freezing the puck	.	.	.	.
<b>Break</b>	"Game ready" fit	.	.	.	.
<b>Protection</b>	Molded High-density foam finger protector provides extra protection	.			
	Low-density foam finger protector provides extra protection		.	.	.
<b>Straps</b>	3-way strapping system, finger, hand, wrist for custom fit and better feel with comfort pad at the wrist	.			
	2-way strapping system, hand, wrist for custom fit and better feel with comfort pad at the wrist		.	.	
	1-way strapping system, hand, for custom fit and better feel with nylon comfort pad at the wrist to secure the glove				.
<b>Pocket</b>	Extended pocket for better coverage	.	.	.	.

INT PRO

SR

JR

YTH

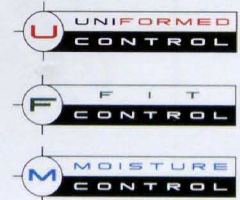

## BLOCKADE® INT PRO BLOCKER



Sizes Regular and Full Right  
Colors \_White/Black/Black  
\_White/Silver/Black  
\_White/Blue/Black  
Also available in custom colors

## BLOCKADE® SR BLOCKER



Sizes Regular and Full Right  
Colors \_White/Red/Black  
\_White/Blue/Black  
\_White/Black/Black

## BLOCKADE® JR BLOCKER



Sizes Regular and Full Right  
Colors \_White/Blue/Black  
\_White/Black/Black

## BLOCKADE® YTH BLOCKER



Sizes Regular  
Colors \_White/Black/Black



## SPECIFICATION CHART

		INT	SR	JR	YTH
Gravity	GRAVITY CONTROL TECHNOLOGY™ provides greater wrist control to prevent torque	.	.	.	.
Deflection	High-density molded foam design allows the goalie to control the puck deflection on the blocker face	.			
	Low-density molded foam design allows the goalie to control the puck deflection on the blocker face		.	.	.
Cuff	Contoured cuff design allows greater wrist flexibility when playing the puck	.	.	.	.
Finger	3-piece finger protection offers increased protection in butterfly and paddle down	.	.		
	2-piece finger protection offers increased protection in butterfly and paddle down			.	
	One-piece finger protection				.
Protection	High-density foam protection for the wrist and thumb	.			
	Low-density foam protection for the wrist and thumb		.	.	.
Straps	Wrist straps for custom fit	.	.	.	.
Comfort	Comfort foam improves comfort at the back of the hand and wrist	.	.	.	.
Gusset	3D mesh palm gusset and thumb provide greater air circulation	.	.	.	.

INT PRO

SR

JR

YTH





Olaf Kolzig  
Washington Capitals

## Arm & Body

Introducing the most technologically advanced arm & body protection to date.

**Protection :**

- 3-way flex shoulder protection high-density foam
- Extended rib protection using HD/LD blocks

**Flexibility :**

- 4-way flex in the arm hinge creates mobility
- New chest design creates easier movement in crouch position

**Fit :**

- Adjustable web strap in the back better fits the front chest and shoulder
- New hydrophobic orange liner with lightweight CELIFF foam creates one of the lightest body protectors in the game, at only **5.71 lbs**

A

**\_ Hydrophobic Mesh**

New orange fabric mesh with hydrophobic properties

**\_ 3-Way Flex Design**

New 3-way flex design maximizes fit and protection



**\_ 4-Way Flex**

New 4-way hinge fit increases flexibility



**\_ Chest protection**

High-density foam blocks in new triangle shape increase fit, flex and protection

**\_ Rib protection**

High-density foam blocks in the rib area for best protection

**\_ Bicep protection**

CELIFF foam in the forearm and biceps combined with low-density foam reduces weight to 5.7lbs (large)



**AB Gatekeeper™ PRO**

**NEW**

## GATEKEEPER™ PRO AB



Featuring the NHL® Platinum Shield.



S 34"-38" / M 38"-42" / L 42"-46" / XL 46"+

## BLOCKADE™ PRO AB



S 34"-38" / M 38"-42" / L 42"-46" / XL 46"+

## BLOCKADE™ INT AB



M 26"-30" / L 30"-34" / XL 34"-38"

## BLOCKADE™ SR AB



S 34"-38" / M 38"-42" / L 42"-46" / XL 46"+

## SPECIFICATION CHART

		GK PRO	BLC PRO	BLC INT	BLC SR	BLC JR	BLC YTH
<b>Comfort</b>	AIR CONTROL TECHNOLOGY™ provides greater air circulation between the body and protection		.	.			
<b>Shoulder</b>	High-density foam contoured to the top of the shoulder with 2 CELIFF caps	.					
	Increased protection in the wing for improved coverage		.	.	.	.	.
<b>Elbow</b>	Molded plastic cap with high-density foam on the side for maximum protection	.	.	.			
	Low-density foam and poly elbow cap to prevent injury				.	.	.
<b>Chest</b>	High-density foam blocks with new triangle shape increases fit, flex and protection	.					
	High-density foam blocks increase protection		.	.	.		
	Low-density foam blocks for protection and lightweight					.	.
<b>Ribs</b>	High-Density foam blocks in the rib area for protection	.					
	2-piece foam rib for better fit and protection		.	.	.	.	.
<b>Arm</b>	New 4-way hinge fit for increased flexibility with comfort foam pad	.					
	CELIFF foam in the forearm and biceps with low-density foam reduce weight to 5.7lbs (large) without affecting protection	.					
	Molded bicep and forearm for high level protection		.	.			
	Molded bicep and forearm for increased protection				.	.	
	Molded bicep and forearm for protection						.
<b>Back</b>	New 3-way flex back protection for increased fit and comfort	.					
<b>Fit</b>	New adjustment in the back for customized fit for shoulder and chest	.	.	.	.	.	.
<b>Wing</b>	New 3-way flex design maximizes fit and protection	.					
<b>Liner</b>	New orange fabric mesh with hydrophobic properties	.					

### BLOCKADE® JR AB



S 20"-24" / M 24"-28" / L 28"-32" / XL 32"-36"

### BLOCKADE® YTH AB



S 20"-24" / M 24"-28" / L 28"-32" / XL 32"-36"



Ed Belfour  
Toronto Maple Leafs

# Pants

The new Gatekeeper™ Pro pants are setting new standards of flexibility and protection to help goalies like Ed Belfour make key saves.

## Protection :

- High-density foam upper thigh blocks
- Adjustable/removable knee protector
- Extended lower thigh protection using lightweight CELIFF foam
- Inside/outside thigh High-density foam blocks

## Fit :

- Hydrophobic orange mesh liner
- Adjustable waist using webbed technology
- Stretch knit in the back of leg
- Molded HD foam lower thigh for a better fit and to be square with the shooter
- Thigh Stabilizer for better fit and increased protection

TORONTO  
MAPLE  
LEAFS

Hexton 10

CCM

P

**\_ Hydrophobic Liner**

New hydrophobic orange liner

**\_ Ergodynamic Back**

Ergodynamic back provides better fit and added protection for the lower back



**\_ Hip / Kidney Protection**

CELIFF foam in the waist and hips reduces weight

**\_ Easy Lacing**

New attachment using webbed technology

**\_ New 3-Piece Design**

New 3-piece design increases protection in the upper thigh, is reinforced with ballistic nylon and uses high-density foam

**\_ Thigh Protection**

Upper knee extension protector

**\_ Adjustable Knee Protection**

New plastic cap adjustable knee protector with adjustable/removable parts



**Gatekeeper™ PRO Pants**

**NEW**

## GATEKEEPER™ PRO PANT



Featuring the NHL® Platinum Shield.



### Thigh Stabilizer

Thigh stabilizer for better fit and increased protection

## FEATURES

### GATEKEEPER™

S 30"-32" / M 32"-34" / L 34"-36" / XL 36"-38"



### Knee Cushion

ULTIMADRY®, ULTRAFRESH® technology knee cushion

### Ultimate Fit

VELCRO® adjustment system  
Elastic attachment



### Protection

Engineered hard cap preventing knee injuries

### Knee Adjustability

Adjustable side knee protector



## SPECIFICATION CHART

		PRO	SR	JR
Shell	Removable shell	•		
Hips	CELIFF foam in the waist and hips reduces weight	•		
Back	Ergodynamic back provides better fit and added protection for the lower back	•	•	•
Upper thigh	New 3-piece design increases protection in the upper thigh, is reinforced with ballistic nylon and uses high-density foam	•		
	New 3-piece design increases protection in the upper thigh using low-density foam		•	•
Thigh	Round thigh protector with upper knee extension	•		
	Round thigh protector			
Knee	New plastic cap adjustable knee protector with adjustable/removable parts	•	•	•
Liner	New hydrophobic orange liner	•	•	•
Lace	New attachment using webbed technology	•	•	•

**NEW**

### GATEKEEPER™ SR PANT



Featuring the NHL® White Shield.



S 30"-32" / M 32"-34" / L 34"-36" / XL 36"-38"



### GATEKEEPER™ JR PANT

**NEW**

Featuring the NHL® White Shield.



S 22"-24" / M 24"-26" / L 26"-28" / XL 28"-30"



## PRO TACKS™



Senior\_6-12 Full/Half D,E\_13 E



## FEATURES

- 1 Integrated LACE BITE PROTECTOR evenly distributes lace pressure and anatomical foam-felt tongue with Tacks® binding stays in place
- 2 Pro comfort plus foams immediately form to the ankles eliminating break-in
- 3 CCM® pro proven traditional profile carbon runner maximizes stability
- 4 Comfort foams cover entire length of foot for maximum comfort
- 5 CLARINO® H<sub>2</sub>O CONTROL™ anti-microbial lining by ULTRA-FRESH® for a better blend of comfort, durability and moisture reduction
- 6 White Protectall II™ max-drainage shell integrates with pads. Modifications maximize mid-foot and heel comfort

## 852 SUPER TACKS®



Senior\_6-12 Full/Half D,E  
Junior\_1-5 Full/Half D,E

## SPECIFICATION CHART



		PRO	852	652
<b>F-I-T-SYSTEM®</b>	CCM® F-I-T-SYSTEM® combines heat and pressure for a gapless customized fit	•	•	•
<b>Ankle Pads</b>	3D heel pocket locks foot in place and maximizes comfort	•		
	Pro comfort plus foams immediately form to the ankles eliminating break-in	•	•	
	Pro comfort foams immediately form to the ankles eliminating break-in			•
<b>Tongue</b>	Integrated LACE BITE PROTECTOR™ evenly distributes lace pressure and anatomical foam-felt tongue with Tacks® binding stays in place and provides a comfortable fit	•	•	
<b>Liner</b>	CLARINO® H <sub>2</sub> O CONTROL™ anti-microbial lining by ULTRA-FRESH® for a better blend of comfort, durability and moisture reduction	•		
	NYTEK® H <sub>2</sub> O lining produces a great combination of comfort, durability and moisture reduction		•	
	CAMBRELLE® liner delivers a comfortable dry fit			•
<b>Comfort Foam</b>	Covers entire length of foot for maximum comfort	•	•	•
<b>Quarter Package</b>	Panama PU2™ is lightweight and offers increased lateral stiffness. Double PU impregnated nylon package maximizes cut and abrasion resistance	•		
	SP7 Ballistic nylon provides lightweight support and stiffness		•	
	Tag quarters improve abrasion resistance and weight reduction			•
<b>Footbed</b>	H <sub>2</sub> O CONTROL™ footbed provides excellent fit, comfort and moisture management	•		
	CCM® F-I-T-SYSTEM® footbed provides excellent fit and comfort		•	•
<b>Cowling</b>	White Protectall II™ max-drainage cowling integrates with pads. Modifications maximize mid-foot and heel comfort	•		
	White Protectall II™ dual-drainage cowling integrates with pads. Modifications maximize mid-foot and heel comfort		•	•
<b>Runner</b>	CCM® pro proven traditional profile carbon runner maximizes stability	•	•	•

## 652 SUPER TACKS®



Senior\_6-12 Full/Half D,E -  
 Junior\_1-5.5 Full/Half D,E  
 Youth\_13-13.5 D



Martin Brodeur  
New Jersey Devils

## Goalie Sticks

CCM® introduces the first major goalie stick revolution in 15 years from the same team that originally designed the foam composite goalie sticks. Exceptionally lightweight, this 700 gram goal stick allows for quicker stick movement to make that big save and less fatigue late in the game.

### Graphite Handle

- Compression molded 3K pre-preg graphite composite shaft reduces weight
- New dimension optimized design controls stiffness along the full length of the stick and increases paddle durability

### Graphite Reinforced Paddle

- Graphite laminated paddle reduces weight to improve overall stick balance
- Volume optimized design provides better stiffness profile to make shooting easier

### High Impact Blade Laminates

- Graphite blade laminates increase blade stiffness for less blade deflection – controls shot redirection on saves and increases goalie shot velocity
- High Impact design provides premium durability in lightweight construction

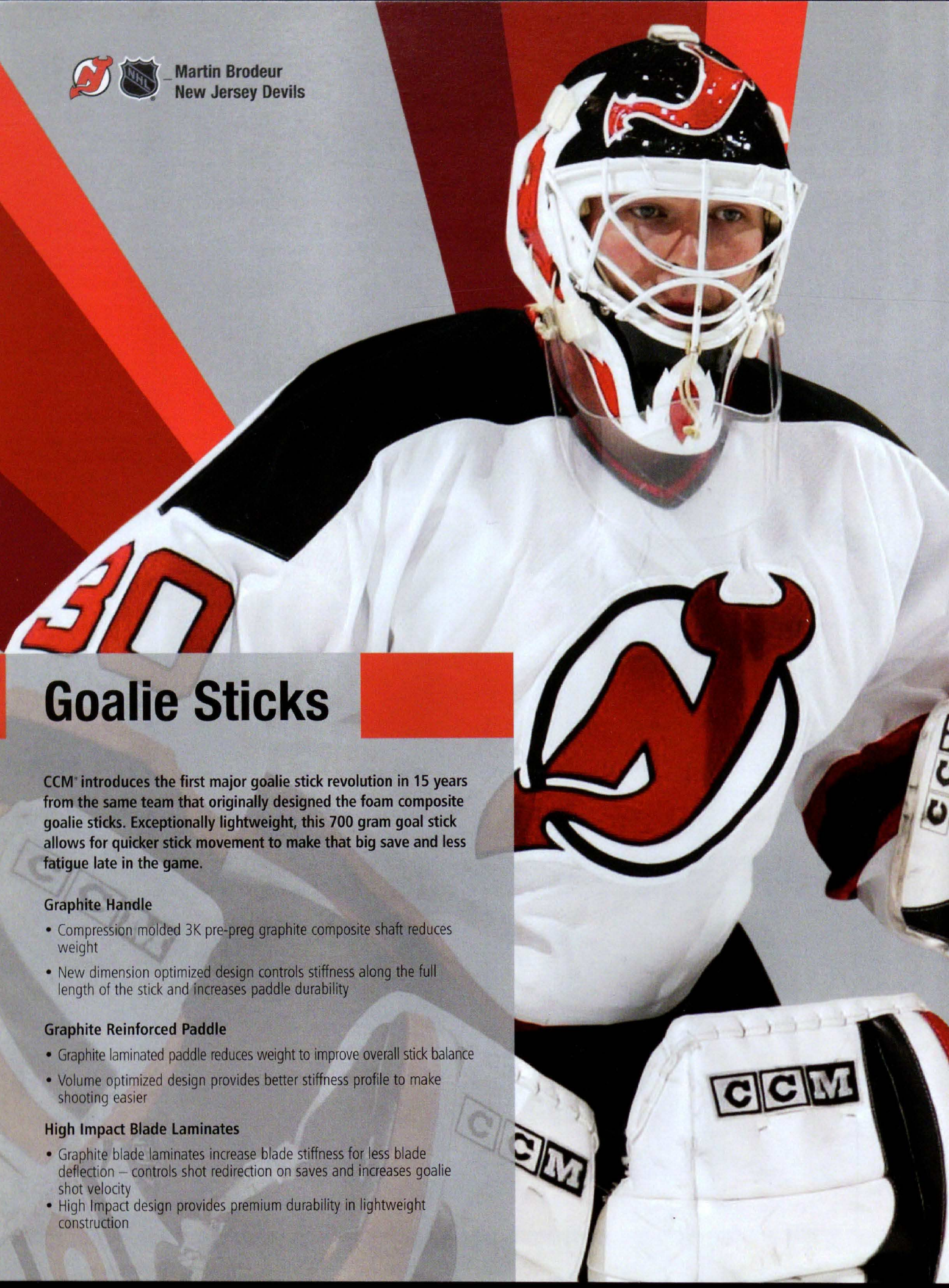

S

**\_ Graphite Handle**

Compression molded 3K pre-preg graphite composite shaft reduces weight

New dimension optimized design controls stiffness along the full length of the stick and increases paddle durability

**\_ Graphite Reinforced Paddle**

Graphite laminated paddle reduces weight to improve overall stick balance

Volume optimized design provides better stiffness profile to make shooting easier

**\_ High Impact Blade Design**

Graphite blade laminates increase blade stiffness for less blade deflection – controls shot redirection on saves and increases goalie shot velocity

High Impact design provides premium durability in lightweight construction



**CCM® Composite Stick**

**NEW**

**CCM® FULL G12 PRO COMPOSITE**



**FULL COMPOSITE G12**

	<u>Pattern</u>	<u>Shaft</u>	<u>Paddle</u>	<u>Blade</u>	<u>Lie</u>	<u>L/R</u>
Senior_	Brodeur	58" - 147cm	26" - 66cm	15" - 37.5cm	14	L/R
	Kolzig	57" - 145cm	25" - 63cm	15" - 37.5cm	14	L
	Denis	58" - 147cm	26" - 66cm	15" - 37.5cm	14	L
	Belfour	58" - 147cm	26" - 66cm	15" - 37.5cm	14	L



**CCM® H10 PRO**

**GRAPHITE REINFORCED H-10**

	<u>Pattern</u>	<u>Shaft</u>	<u>Paddle</u>	<u>Blade</u>	<u>Lie</u>	<u>L/R</u>
Senior_	Brodeur	58" - 147cm	26" - 66cm	15" - 37.5cm	14	L/R
	Kolzig	57" - 145cm	25" - 63cm	15" - 37.5cm	14	L
	Denis	58" - 147cm	26" - 66cm	15" - 37.5cm	14	L

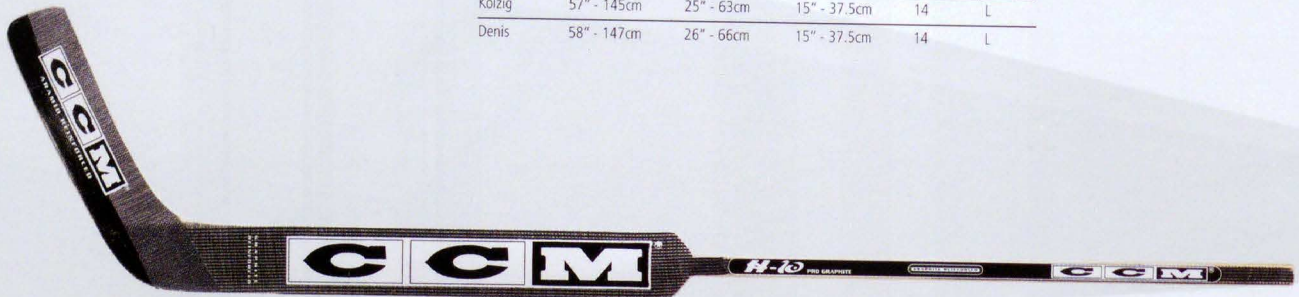

**SPECIFICATION CHART**

		G12	H10	H8	H6
<b>Handle</b>	Lightweight compression molded graphite shaft construction	•			
	Aspen wood core shaft reinforced with pre-pressed graphite and fiberglass laminates		•		
	Aspen wood core shaft reinforced with pre-pressed fiberglass laminates			•	
	Solid hardwood core shaft				•
<b>Paddle</b>	Graphite laminated paddle reduces weight for better balance	•			
	Polyurethane foam injected paddle reinforced with graphite and fiberglass		•		
	Polyurethane foam injected paddle reinforced with fiberglass			•	•
<b>Blade</b>	High impact laminate blade construction provides durability and stiffness	•			
	Polyurethane foam core injected blade reinforced with black aramid, fiberglass and ABS heel insert for extra durability		•		
	Polyurethane foam core injected blade reinforced with fiberglass			•	•
<b>Lie</b>	14	•	•	•	•

## CCM® H8 SR/INT

FIBERGLASS REINFORCED

### H-8

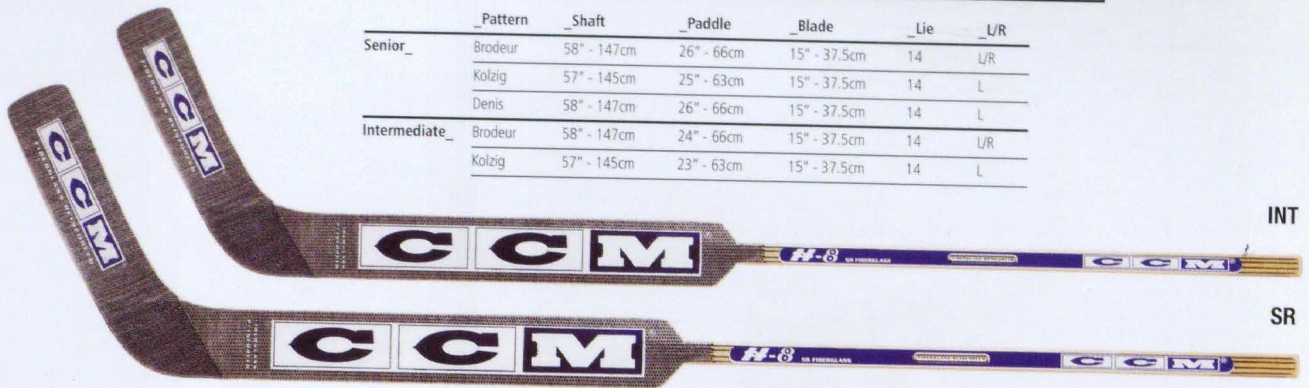

	Pattern	Shaft	Paddle	Blade	Lie	L/R
Senior	Brodeur	58" - 147cm	26" - 66cm	15" - 37.5cm	14	L/R
	Kolzig	57" - 145cm	25" - 63cm	15" - 37.5cm	14	L
	Denis	58" - 147cm	26" - 66cm	15" - 37.5cm	14	L
Intermediate	Brodeur	58" - 147cm	24" - 66cm	15" - 37.5cm	14	L/R
	Kolzig	57" - 145cm	23" - 63cm	15" - 37.5cm	14	L

INT

SR

## CCM® H6 SR/INT JR/YTH

WOODCORE REINFORCED



### H-6



	Pattern	Shaft	Paddle	Blade	Lie	L/R
Senior	Brodeur	57" - 145cm	26" - 66cm	15" - 37.5cm	14	L/R
Intermediate	Brodeur	56" - 142cm	24" - 61cm	15" - 37.5cm	14	L/R
Junior	Brodeur	50" - 127cm	21" - 53cm	13 5/8" - 35cm	13	L/R
Youth	Brodeur	45" - 114cm	18" - 46cm	13 5/8" - 35cm	13	L/S

JR/YTH

SR/INT

	Sticks Models	Shaft Lengths						Blade Curves
		Sr 58"	Sr 57"	Int 57-58"	Int 56"	Jr 50"	Yth 45"	
 <b>Martin Brodeur</b> Small mid curve - Slightly opened face	G12	•						
	H-10	•						
	H-8	•		•				
	H-6		•		•	•	•	
 <b>Olaf Kolzig</b> Big mid curve - Slightly opened face	G12	•						
	H-10		•					
	H-8		•	•				
	H-6				•	•	•	
 <b>Marc Denis</b> Gradual heel curve - Opened face	G12							
	H-10	•						
	H-8	•						
	H-6							



MARTIN BRODEUR DESIGN



MARC DENIS DESIGN<sup>1</sup> Marlene Ross

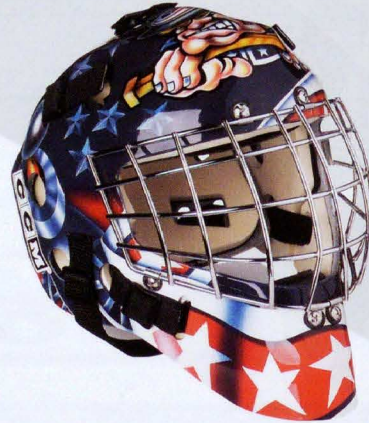

NEW

METAL DEMON DESIGN<sup>2</sup> John Harrow

GATEKEEPER DESIGN<sup>2</sup> John Harrow



SKULL DESIGN

COBRA DESIGN<sup>3</sup> Benoit Kelly





## SPECIFICATION CHART

<b>Style</b>	Pro style goalie mask
<b>Protection</b>	Aramid reinforced at the chin and forehead to optimize strength and stiffness
	Hand-crafted, multi-layered fiberglass shell
	Extended throat protection
	Dual density vinyl nitrile liner delivers protection and superior comfort and fit
<b>Vision</b>	Streamlined chrome cage provides maximum peripheral vision
<b>Straps</b>	Solid 1" (2.50 cm) straps and buckle
<b>Comfort</b>	Two sweatbands included with each mask
<b>Certification</b>	CSA, HECC and CE certified
	Hang tag listing authorized painters included with every mask
<b>Colors</b>	White
	Black
	Factory custom paint designs available
<b>Sizes</b>	S 6 1/2 - 7 1/4 • 52 - 57 cm
	L 7 - 7 5/8 • 56 - 61 cm
<b>Replacement parts</b>	ACPART4508 - sweatbands (pair)
	ACPART4501 - Backplate straps
	ACPART4502 - 1" (2.50 cm) buckles (25 per pack)
<b>Artists</b>	1 Marlene Ross
	2 John Harrow
	3 Benoit Kelly

### WOLF DESIGN<sup>1</sup> Marlene Ross



\*Also available in custom colors, black and white

## FM6 - GOALIE REPLACEMENT CAGE

Protection	High quality carbon steel
	Finished with high quality powder coating or chrome plating
	CSA, HECC and CE approved
Colors	White, Black, Chrome



## AC485 - GOALIE LEXAN THROAT GUARD

Vision	Precision cut edges for optimal visibility
Motion	Contoured chin and neck for increased range of motion



## TPGATE PRO - GOALIE THIGH PAD

Protection	High-density foam for increased protection
Liner	420 nylon Denier for durability and lightweight
Fit	Adjustable elastic for custom fit
Color	White
Sizes	Senior - 31"-34", 35"+



## TCPRO - GOALIE THROAT GUARD

Protection	High-density foam in neck and clavicle area
Comfort	PU foam 3/8"
Abrasion	Water resistant ballistic nylon covered
Fit	Adjustable 4"-10cm(MEN) and 3"-7.5cm (BOY) neck strap for a comfortable fit
BNQ	Approved (Bureau de Normalisation du Quebec)
Color	Black
Sizes	Senior/Junior



## GJ8 PRO - GOALIE JOCK

Cup	Extra deep molded cup for full wraparound and maximum comfort, removable
Liner	Working ventilation from the 3D mesh liner and ventilated cup
Waist	Low cut waist for better fit and ease of forward bending
Fit	Adjustable 3"-7.5cm wide elastic
Color	Black
Sizes	Senior/Junior



## GATEKEEPER™ GOALIE BAGS 44WH

Nylon	600 Denier polyester construction
Wheels	All-terrain In-line .90mm bearing corner wheels with retractable handle system
Zipper	Full length top zipper extends down end panels
Bottom	PE bottom board with two plastic rails on bottom of bag
Shoulder	Padded shoulder strap detachable at one end
Corner	Reinforced with heavy vinyl patches on bottom panel
Color	Black/White
Size	44"x 24"x 24", 110cm x 60cm x 60cm



## BLOCKADE® GOALIE BAGS 40WH

Nylon	600 Denier polyester construction
Wheels	All-terrain In-line .90mm bearing corner wheels with retractable handle system.
Zipper	Full length top zipper extends down end panels
Bottom	PE bottom boards
Shoulder	Padded shoulder strap detachable at one end
Corner	Reinforced with heavy vinyl patches on bottom panel
Colors	Black/White
Sizes	40"x 24"x 24", 105.5cm x 60cm x 60cm



## GOALIE MASK BAG

Nylon	Coated Nylon construction
Zipper	#10 durable zipper
Foam	Padded foam for extra protection
Colors	Black/White
Sizes	14"x 9"x 9.5", 35cm x 22cm x 24cm



## GATEKEEPER™ CUSTOM COLORS

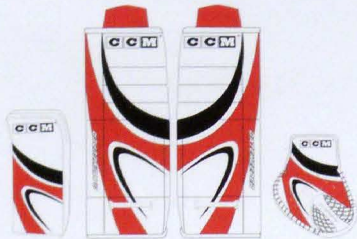

**Brodeur**

#6 #14 #9009

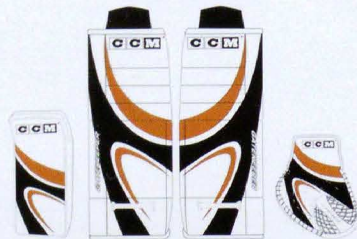

**Kolzig**

#6 #9009 #47



**N.Y. Islanders**

#4 #333 #6



**Buffalo**

#9009 #14 #94

## COLOR OPTIONS

\*Gatekeeper™ Only

#70	Red Sonic	
#71	Royal Sonic	
#72	Black Sonic	
#73	Silver Sonic	
#74	White Sonic	
#75	Navy Sonic	
#80	Royal Laser	
#70	Black Laser	
#83	Silver Laser	
#84	White Laser	
#85	Navy Laser	
#86	Red Laser	

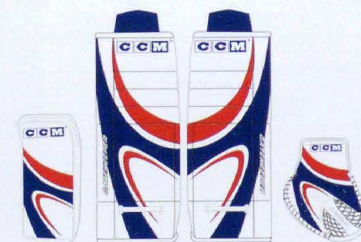

**Montreal**

#6 #3006 #14



**Vancouver**

#6 #94 #9009

#6	White	
#505	Yellow	
#44	Gold Sport	
#4	Orange	
#14	Red	
#108	Marron	
#19	Eggplant	
#3006	Royal	
#333	Navy	
#1009	Purple	
#9009	Black	
#37	Caps. Blue	
#32	Ana. Teal	
#34	S.J. Teal	
#2009	Dark Green	
#9003	Grey	
#94	Silver	
#47	Bronze	
#1006	Phoenix Red	
#408	Antique gold	
#57	Tan Retro	
#14	Red Emboss	
#3006	Royal Emboss	
#9009	Black Emboss	
#94	Silver Emboss	
#61	White Emboss	
#308	Navy Emboss	
#47	Bronze Emboss	

**GATEKEEPER™**

## BLOCKADE CUSTOM COLORS

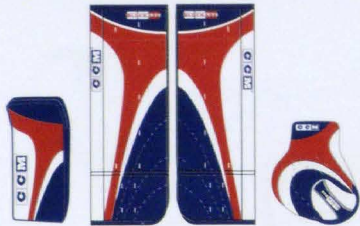

**Denis**

#6 #14 #3006

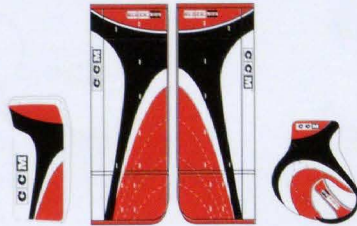

**New Jersey**

#6 #9009 #14

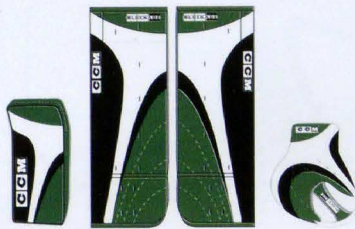

**Dallas**

#9009 #6 #2009

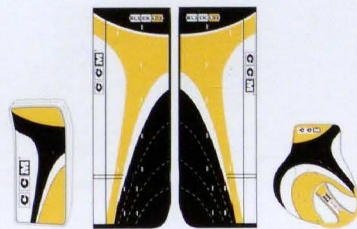

**Pittsburgh**

#6 #408 #9009

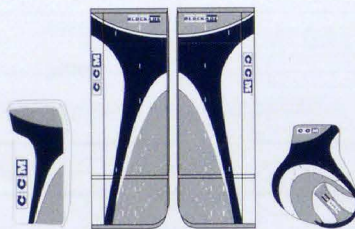

**Tampa Bay**

#6 #333 #94

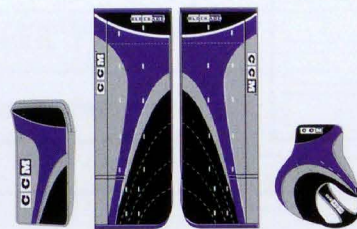

**Los Angeles**

#94 #19 #9009

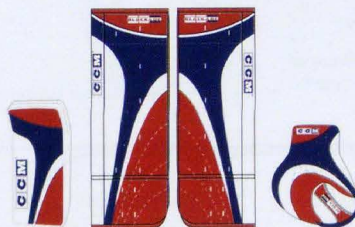

**Montreal**

#6 #3006 #14



**Nashville**

#44 #333 #94

## COLOR OPTIONS

#6	White	
#505	Yellow	
#44	Gold Sport	
#4	Orange	
#14	Red	
#108	Marron	
#19	Eggplant	
#3006	Royal	
#333	Navy	
#1009	Purple	
#9009	Black	
#37	Caps. Blue	
#32	Ana. Teal	
#34	S.J. Teal	
#2009	Dark Green	
#9003	Grey	
#94	Silver	
#47	Bronze	
#1006	Phoenix Red	
#408	Antique gold	
#57	Tan Retro	
#14	Red Emboss	
#3006	Royal Emboss	
#9009	Black Emboss	
#94	Silver Emboss	
#61	White Emboss	
#308	Navy Emboss	
#47	Bronze Emboss	

**BLOCKADE**

## GOALIE PAD CCM® GATEKEEPER™ PRO

If color chart is not completed, the order will not be processed.

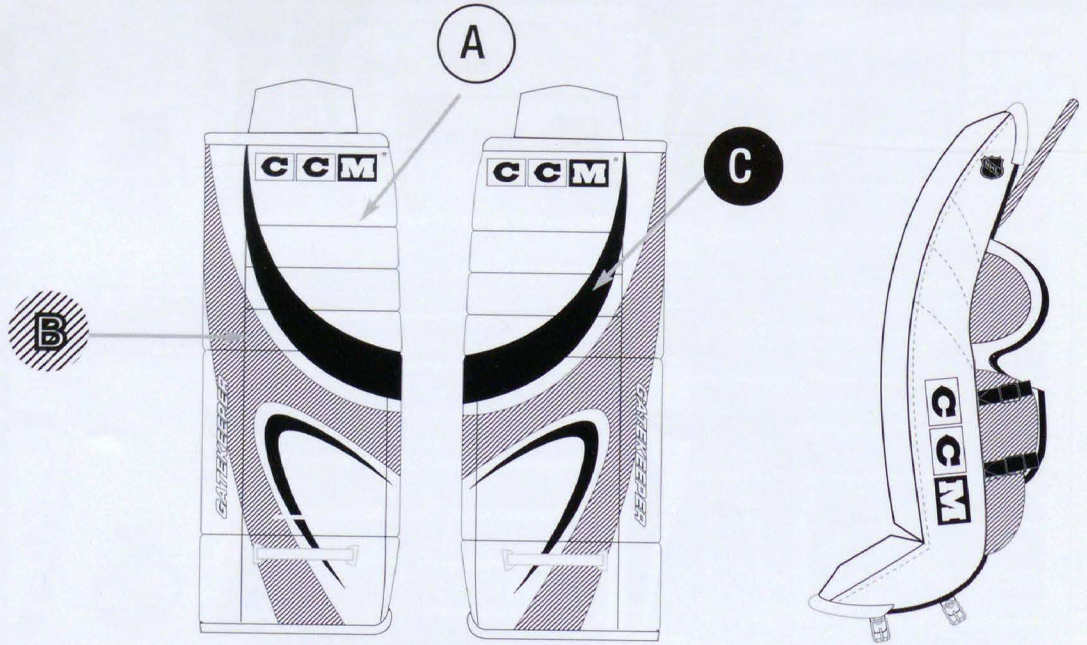

A	
PU Leather	# <input type="text"/>
Laser	# <input type="text"/>
Sonic	# <input type="text"/>
Emboss PU	# <input type="text"/>

B	
PU Leather	# <input type="text"/>
Laser	# <input type="text"/>
Sonic	# <input type="text"/>
Emboss PU	# <input type="text"/>

C	
PU Leather	# <input type="text"/>
Laser	# <input type="text"/>
Sonic	# <input type="text"/>
Emboss PU	# <input type="text"/>

Custom sizing: Ankle to knee length: \_\_\_\_\_ Dealer's name: \_\_\_\_\_  
 Thigh rise length: \_\_\_\_\_ Customer #: \_\_\_\_\_  
 Skate size: \_\_\_\_\_ Customer signature: \_\_\_\_\_  
 Finished Pad length: \_\_\_\_\_ Retailer's signature: \_\_\_\_\_  
 Grandeur inventaire: \_\_\_\_\_ +1"

Toe arrangement: Toe straps  Standard lacing  Embroidery name \_\_\_\_\_  
 SR Pro  Custom made for: \_\_\_\_\_

Internal use only. Production date: \_\_\_\_\_ Order #: \_\_\_\_\_ Order date: \_\_\_\_\_ P.O. #: \_\_\_\_\_

Canada Tel : 1-800-636-5895  
 USA Tel : 1-800-524-4226

FAX : 1-800-636-5751  
 FAX : 1-800-232-9226

## CATCHER CCM® GATEKEEPER™ PRO

If color chart is not completed, the order will not be processed.

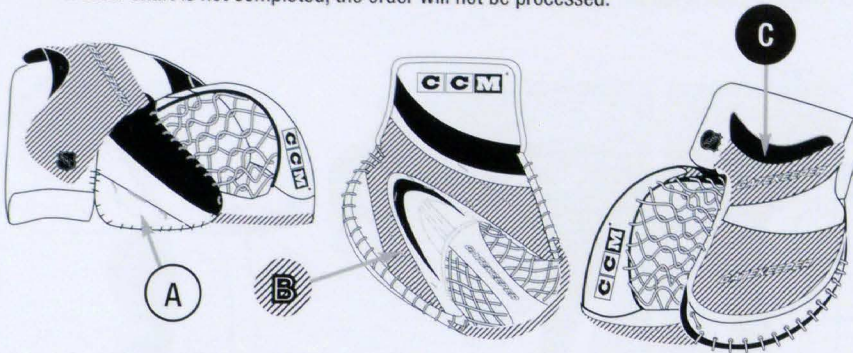

Dealer's name: \_\_\_\_\_ Embroidery name: \_\_\_\_\_  
 Customer #: \_\_\_\_\_  
 Customer signature: \_\_\_\_\_  
 Retailer's signature: \_\_\_\_\_

Size: M  L   
 Regular  Full right

Internal use only. Production date: \_\_\_\_\_ Order #: \_\_\_\_\_ Order date: \_\_\_\_\_ P.O. #: \_\_\_\_\_

Canada Tel : 1-800-636-5895  
 USA Tel : 1-800-524-4226

FAX : 1-800-636-5751  
 FAX : 1-800-232-9226

**A**

PU Leather #   
 Laser #   
 Sonic #   
 Emboss PU #

**B**

PU Leather #   
 Laser #   
 Sonic #   
 Emboss PU #

**C**

PU Leather #   
 Laser #   
 Sonic #   
 Emboss PU #

## BLOCKER CCM® GATEKEEPER™ PRO

If color chart is not completed, the order will not be processed.

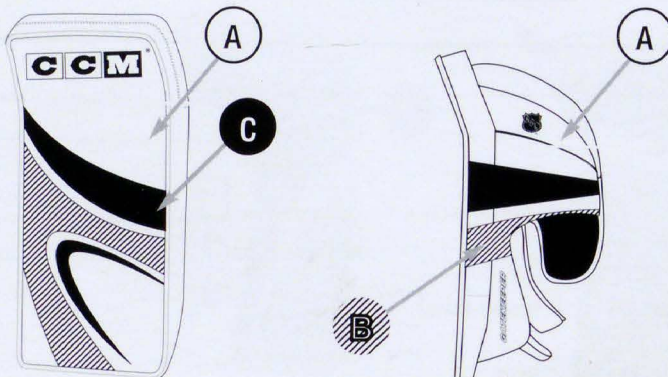

Dealer's name: \_\_\_\_\_ Embroidery name: \_\_\_\_\_  
 Customer #: \_\_\_\_\_  
 Customer signature: \_\_\_\_\_  
 Retailer's signature: \_\_\_\_\_

Size: Regular(Legal)  Full right

**A**

PU Leather #   
 Laser #   
 Sonic #   
 Emboss PU #

**B**

PU Leather #   
 Laser #   
 Sonic #   
 Emboss PU #

**C**

PU Leather #   
 Laser #   
 Sonic #   
 Emboss PU #

**GOALIE PAD CCM® BLOCKADE® PRO**

If color chart is not completed, the order will not be processed.

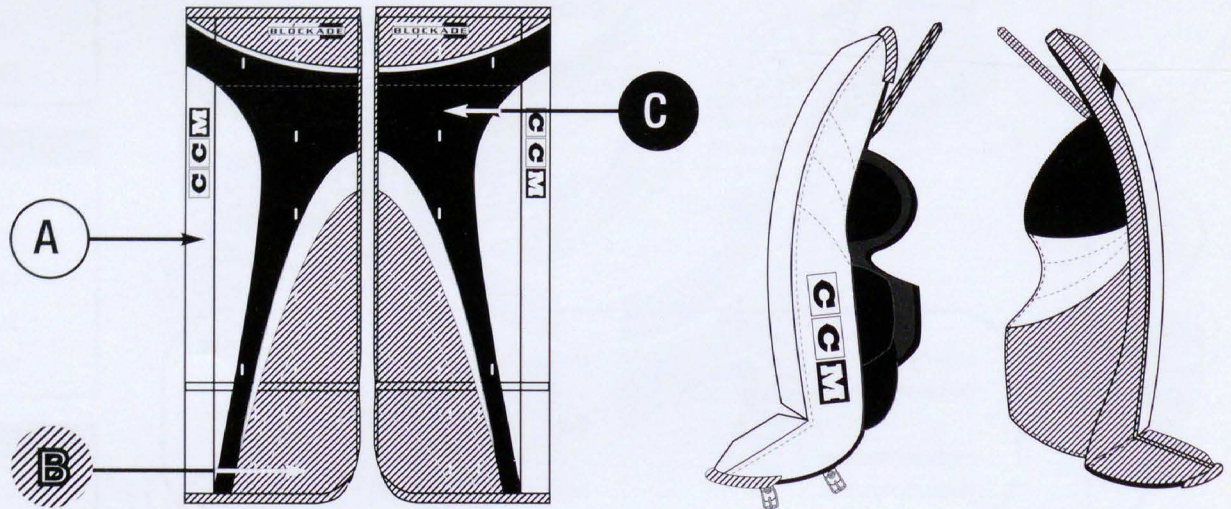

**A**

PU Leather #

Emboss PU #

**B**

PU Leather #

Emboss PU #

**C**

PU Leather #

Emboss PU #

Custom sizing: Ankle to knee length: \_\_\_\_\_ Dealer's name: \_\_\_\_\_  
 Thigh rise length: \_\_\_\_\_ Customer #: \_\_\_\_\_  
 Skate size: \_\_\_\_\_ Customer signature: \_\_\_\_\_  
 Finished Pad length: \_\_\_\_\_ Retailer's signature: \_\_\_\_\_

Toe arrangement: Toe straps with buckles (optional)  Standard lacing   
 Int  SR Pro

Embroidery name \_\_\_\_\_  
 Custom made for: \_\_\_\_\_

Internal use only. Production date: \_\_\_\_\_ Order #: \_\_\_\_\_ Order date: \_\_\_\_\_ P.O. #: \_\_\_\_\_

Canada Tel: 1-800-636-5895  
 U.S.A. Tel: 1-800-524-4226

Fax: 1-800-636-5751  
 Fax: 1-800-232-9226



**CATCHER CCM® BLOCKADE® PRO**

If color chart is not completed, the order will not be processed.

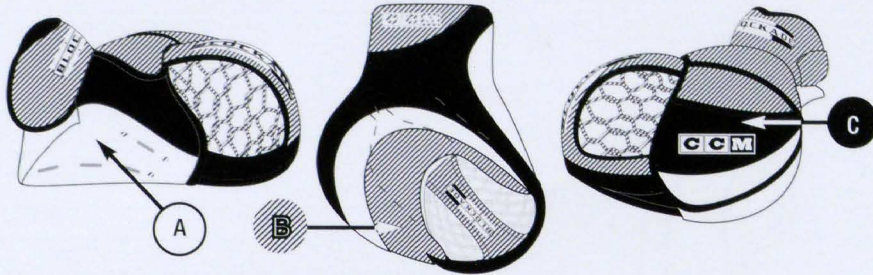

Dealer's name: \_\_\_\_\_ Embroidery name: \_\_\_\_\_  
 Customer #: \_\_\_\_\_  
 Customer signature: \_\_\_\_\_ Size: Regular (Legal)  Full right   
 Retailer's signature: \_\_\_\_\_ Int  SR Pro

Internal use only. Production date: \_\_\_\_\_ Order #: \_\_\_\_\_ Order date: \_\_\_\_\_ P.O. #: \_\_\_\_\_

Canada Tel: 1-800-636-5895  
 U.S.A. Tel: 1-800-524-4226

Fax: 1-800-636-5751  
 Fax: 1-800-232-9226

**A**

PU Leather # \_\_\_\_\_  
 Emboss PU # \_\_\_\_\_

**B**

PU Leather # \_\_\_\_\_  
 Emboss PU # \_\_\_\_\_

**C**

PU Leather # \_\_\_\_\_  
 Emboss PU # \_\_\_\_\_

**BLOCKER CCM® BLOCKADE® PRO**

If color chart is not completed, the order will not be processed.

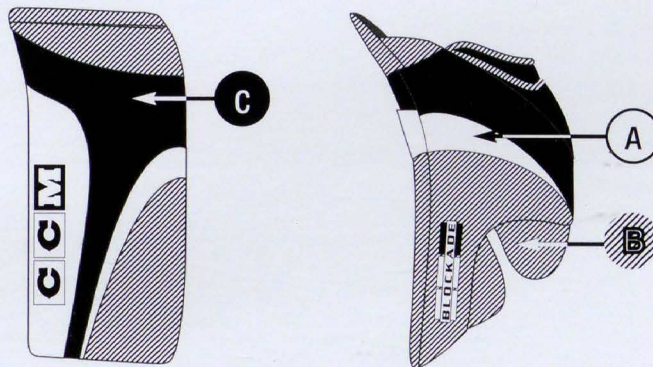

Dealer's name: \_\_\_\_\_ Embroidery name: \_\_\_\_\_  
 Customer #: \_\_\_\_\_  
 Customer signature: \_\_\_\_\_ Size: Regular (Legal)  Full right   
 Retailer's signature: \_\_\_\_\_ Int  SR Pro

**A**

PU Leather # \_\_\_\_\_  
 Emboss PU # \_\_\_\_\_

**B**

PU Leather # \_\_\_\_\_  
 Emboss PU # \_\_\_\_\_

**C**

PU Leather # \_\_\_\_\_  
 Emboss PU # \_\_\_\_\_

# Pads Sizing Chart

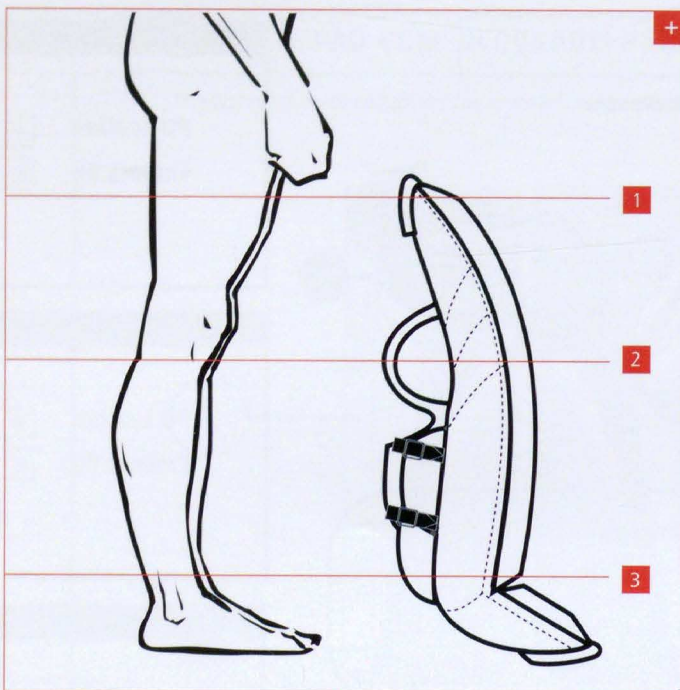

\_ Description

SIZE	BLOCKADE*		GATEKEEPER*	
	ANKLE TO KNEE	THIGH	THIGH	SKATE
JR 27"	14 1/2"	5 3/4"		6
JR 28"	15"	6"		6 1/2
JR 29"	15 1/2"	6 1/4"		7
JR/SR 30"	16"	6 1/2"		7 1/2
SR 31"	16 1/2"	6 3/4"	7 3/4"	8
SR 32"	17"	7"	8"	8 1/2
SR 33"	17 1/2"	7 1/4"	8 1/4"	9
SR 34"	18"	7 1/2"		9 1/2
SR 35"	18 1/2"	7 3/4"	8 3/4"	10
SR 36"	19"	8"9"		10 1/2
SR 37"	19 1/2"	8 1/4"	9 3/4"	11 1/2 -12

\_ Goal Pad Size Chart

Sizing is a critical part of feeling comfortable on the ice. CCM® goal pads have been developed around a simple sizing procedure.

- 1 The thigh rise of the goal pad, which is the area above the knee roll, is determined by measuring from the FRONT center of the knee cap up to the desired height on the front of the thigh.
- 2 Measure the distance from the INSIDE ankle bone up to the front center of the knee cap. Do this while the leg is slightly bent.
- 3 The third dimension is the size of the goal skate.  
 An example of a common size goal pad for a 5'10" adult would be:  
 Ankle to Knee = 17 1/2"  
 Thigh rise = 7"  
 Skate size = 9
- 4 The pad is measured from the inside of the pad outer roll.

## Notes

---

---

---

---

---

---

---

---

---

---



CCM® is a registered trademark of CCM Holdings (1983) Inc./Gestion CCM (1983) Inc. and is used under licence by Sport Maska Inc. and under sublicense by Masko U.S., Inc.

† : This catalog may refer to the following trademarks which are owned by the companies whose names appear after the trademark : AHL - - American Hockey League, Inc.; CHL - - Canadian Hockey League; CLARINO - - Huraray Co Ltd.; ECHL - - ECHL Inc.; LEXAN - - General Electric Company; NYTEK - - Magilite Corporation; PITTARDS - - Pittards PLC; ULTRA-FRESH - - Kroy International Inc.; VELCRO - - Velcro Industries B.V.; AgION - - AgION Technologies.; CENTER ICE, NHL and the NHL Shield are registered trademarks of the National Hockey League. NHL Enterprises, L.P., © 2004 NHL. All rights reserved.

® : Means a registered trademark of Sport Masko Inc.

™ : Means a trademark of Sport Masko Inc.

While the information shown in this publication was correct at time of printing, we reserve the right to discontinue the sale of product or change specifications or designs without notice or obligation.

Warning : Hockey is a dangerous collision sport. We recommend that protective equipment and a certified helmet be worn at all times.

Printed in Canada. Sport Masko Inc. 2004.

All rights reserved.



**Martin Brodeur**  
 New Jersey Devils  
 2004 World Cup Champion  
 2003 and 2004 Vezina Trophy  
 1995, 2000 and 2003 Stanley Cup Champion  
 2002 Olympic Gold Medalist



**Ed Belfour**  
 Toronto Maple Leafs  
 1993 Vezina Trophy  
 1994 Stanley Cup Champion  
 1999 William M. Jennings Trophy



**Olaf Kolzig**  
 Washington Capitals  
 2000 Vezina Trophy

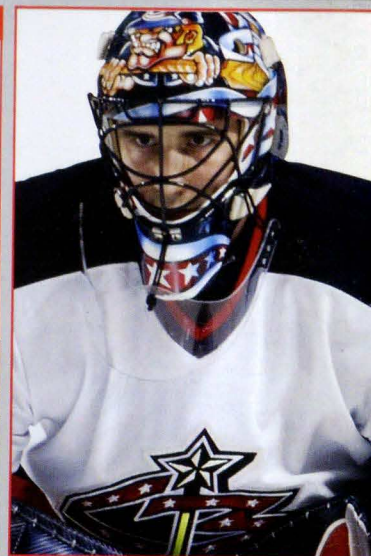

**Marc Denis**  
 Columbus Blue Jackets  
 Most Minutes Played in season 2003-04

**ccmsports.com**

**NORTH AMERICA**

The Hockey Company, 2 Place Alexis Nihon,  
 3500 De Maisonneuve Blvd West Suite 800,  
 Westmount, Québec, Canada, H3Z 3C1  
**Canada:** Tel.: (800) 636-5895 Fax: (800) 636-5751  
**USA:** Tel.: (800) 524-4226 Fax: (800) 232-9226

**EUROPE**

Jofa AB  
 P.O. Box 66  
 SE-782 22  
 Malung  
**Sweden :** Tel.: 46-280-444 00 Fax: 46-280-143 40  
 KHF Finland OY  
 Box 28  
 SF-30101 Forssa  
**Finland :** Tel.: 358-3-414 21