



Instructions for Use

Emfit Tonic-Clonic Seizure Monitor

NOTE!

THE DEVICE MUST NOT BE USED IF AN OPERATIONAL FAILURE OF THE DEVICE MIGHT LEAD TO A DELAY IN GETTING THE APPROPRIATE TREATMENT OR MEDICATION FOR THE PATIENT, WHICH COULD PUT THE PATIENTS LIFE AT RISK.

Applicable to products:

Control unit D-1090-2G, t63 v.1.3.2
Bed sensor L-4060SL or L-4060SLC
08 August 2013, ENG ver. 5.5

Emfit and the Emfit logo are either registered trademarks or trademarks of Emfit Ltd. Copyright © 2002–2013 Emfit Ltd.
All rights reserved. Patented, patents applied (see list at www.emfit.com).



TABLE OF CONTENTS

- 1. IMPORTANT SAFETY PRECAUTIONS** 3
 - 1.1. Important information. Read before use 3
 - 1.2. Unintended adjustment of control unit settings: 3
- 2. SYMBOLS USED IN THIS MANUAL** 3
- 3. INTRODUCTION** 5
 - 3.1. Intended use 5
 - 3.2. Liability of the manufacturer 5
 - 3.3. About this manual 5
- 4. PACKAGE CONTENTS** 6
- 5. GENERAL** 6
 - 5.1. Control unit (*picture 1*) 6
 - 5.2. Bed sensor (*picture 6*) 6
- 6. SETTING UP THE DIP SWITCHES** 6
 - 6.1. Adjusting the tonic-clonic seizure notification delay (switches #1 and #2) 6
 - 6.2. Setting the Bed-Exit Notification Delay 7
 - 6.3. SW 1 switch function (switch #6) 7
 - 6.4. Adjusting the notification sound volume (switches #7 and #8) 7
- 7. INSERTING BATTERIES AND BATTERY SERVICE LIFE** 8
- 8. EXTERNAL POWER SUPPLY** 8
- 9. CONNECTORS AND CABLES** 9
 - 9.1. X2 (AUX) Connector Pin Order (*picture 16*) 9
- 10. INSTALLATION OF THE CONTROL UNIT** 9
 - 10.1. With wall mounting bracket 9
 - 10.1. With bed side clip 9
- 11. INSTALLATION OF THE BED SENSOR** 10
- 12. SW1 PRESS SWITCH (*picture 21*)** 10
 - 12.1. ON/OFF switch 10
 - 12.2. Acknowledgement switch 10
 - 12.3. Bed exit alarm bypass switch 10
 - 12.4. Bed exit alarm "presence / absence" sensitivity switch 10
- 13. SIGNAL LIGHTS (*picture 22*)** 10
 - 13.1. Green – Presence 10
 - 13.2. Blue – Device on/standby 11
 - 13.3. Red – Malfunction 11
- 15. CALIBRATING THE "PRESENCE / ABSENCE" SENSITIVITY** 11
 - 15.1. Doing calibration 11
 - 15.2. Error messages and how to handle them 11
- 16. CHECKS** 12
 - 16.1. Weekly checks 12
 - 16.2. Start-up and monthly checks 12
- 17. TROUBLESHOOTING** 12
- 18. CLEANING** 13
- 19. DISPOSAL OF THE DEVICE AFTER USE** 13
- 20. DECLARATION OF CONFORMITY (EU)** 13
- 21. EMFIT LIMITED WARRANTY STATEMENT** 13
- 22. TECHNICAL SPECIFICATIONS** 14
 - 22.1. Control unit 14
 - 22.2. Sensor 15
 - 22.3. External Power Supply 15
 - 22.4. Ambient conditions 15
 - 22.5. Product class 15
- 23. ELECTROMAGNETIC CONDITIONS** 16
- 24. MANUFACTURER** 19
- 25. APPENDIX - RELATED PICTURES** 19

1. IMPORTANT SAFETY PRECAUTIONS

1.1. Important information. Read before use.

- Must not be used in situations where a delay in the arrival of appropriate medical care, could lead to a potentially life-threatening situation.
- This device is designed only to be used as an aid for a caregiver.
- Pets can cause false notifications or prevent a notification when needed if they walk or lie on a bed fitted with this device.
- Do not use this device for any purpose other than that specified by the manufacturer.
- Do not connect the device to any other devices other than those specified by the manufacturer.
- Do not try to repair the device yourself.
- The device is designed to be used in the electromagnetic environment and conditions specified on chapter "Electromagnetic conditions". The client or user of the device must ensure that it is only used in the specified ambient conditions.
- Do not install this device near or on top of another device. However, if this cannot be avoided, the user must ensure that the device functions in the normal manner.
- Do not use X1, X2 or X3 connectors for any purpose other than that specified by the manufacturer. Do not connect the connectors to e.g. telecommunications or local area networks.
- If this device is used with a pressure care mattress filled using a compression pump, the device may not function normally in some cases.
- Equipment is not suitable for use in the presence of a flammable anaesthetic mixture with air or with oxygen or nitrous oxide.
- Do not let the device get wet.
- Remove the batteries when the device is not in use or when it is stored for an extended period. Alkaline batteries may become self-discharged, start leaking and contaminate the device.
- Do not use any rechargeable batteries or lithium-ion batteries! Rechargeable or lithium-ion batteries carry the risk of melting, ruining the device and causing possible danger to the user.
- The device is not diagnostic and cannot differentiate between a tonic-clonic seizure and other fast movements.
- When removing the power supply from the socket, ensure that the plug part is not left in the socket. If the plug part is left in the socket, touching or trying to remove it carries the risk of an electric shock.

1.2. Unintended adjustment of control unit settings:

- Adjusting the volume may lead to the notification sound not being heard.
- Increasing sensitivity may lead to false notifications while decreasing sensitivity may lead to the notification not becoming activated when needed.
- Incorrect positioning of the DIP switches may interfere with the normal operation of the device.
- Pressing the ON/OFF/Reset (SW1) press switch for too long will switch off the device.

2. SYMBOLS USED IN THIS MANUAL

The following instructions are designed to ensure the personal safety of the user and protect this device or any device connected to it from damage. These instructions use symbols to draw the user's attention to the instructions at hand. The symbols act as safety and warning signs. The symbols and their explanations are as follows:

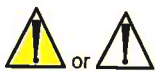

If the instructions are not adhered to, the situation may lead to a death or serious personal injury (in this User's Guide). ATTENTION - consult accompanying documents (i.e. this User's Guide)



Means that the section contains important information for the user (in this User's Guide)



Indicates the maximum use and storage temperature (of the sensor).



When led next to this is blinking it indicates person is in bed (on the control device)



When led next to this is blinking it indicates product is in stand-by mode (on the control device).



Non-ionizing radiation (in this User's Guide, section 23)



Symbol of European Waste Electrical and Electronic Equipment Directive (WEEE Directive) 2002/96/EC on waste electrical and electronic equipment (in this User's Guide, section 19 and on bed sensor).

RoHS

Indicates that the product is in compliance with the European directive 2002/95/EC on the restriction of the use of certain hazardous substances in electrical and electronic equipment (commonly referred to as the Restriction of Hazardous Substances Directive or RoHS).

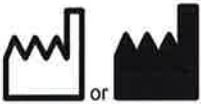

Indicates manufacturer name and address.

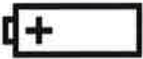

Indicates positioning of battery cell. + is positive terminal and - is negative terminal



Indicates polarity of d.c. power connector (In the external power supply)



Indicates alternating current (In the external power supply)



Indicates direct current (In the external power supply)



Indicates meets safety requirements specified in IEC 61140 for Class II equipment (In the external power supply)



In the external power supply indicates it is for indoor use only



In the external power supply indicates it is UL Demko certified



In the external power supply indicates it is UL Demko certified



In the external power supply indicates it is UL Certified



Indicates that the product conforms with the relevant requirements of the Medical Device Directive 93/42/EEC.

3. INTRODUCTION

- These instructions describe the use of the Emfit Tonic-Clonic Seizure Monitor. The exact version number on the first page of this manual should be referred to and compared against the number on the sticker found on your device.
- Use the device only in the ambient conditions specified by the manufacturer. For detailed information, refer to "Technical Specifications" in this manual.
- Follow all instructions provided in this document concerning the installation, use and cleaning of the device.
- Based on the intended use, point 1) of section 3.1 below, the Emfit Tonic-Clonic Seizure Monitor is a medical device as defined in the Medical Device Directive 93/42/EEC. Based on the nature of point 2) regarding the intended use, the device is not defined as a medical device (Directive 93/42/EEC, Article 1(2), subparagraph a).
- The device is a Class I medical device in accordance with the Medical Device Directive 93/42/EEC and carries the CE marking accordingly.

3.1. Intended use

The Emfit Tonic-Clonic Seizure Monitor is intended to be used to assist in sensory monitoring and to notify the user

- 1) of the body movements of a person lying on a mattress equipped with the under-mattress sensor due to a tonic-clonic seizure while sleeping
- 2) of the presence of the monitored person on the mattress equipped with the under-mattress bed sensor and if he or she gets up from the mattress.

The device may either be used

- solely for the task described in point 1) above,
- for the tasks described in points 1) and 2) above simultaneously.

NOTE 1

The manufacturer cannot guarantee that the device will detect all episodes of tonic-clonic seizure-induced body movements of the monitored person.

NOTE 2

The device may trigger a false body movement notification, especially if the person lying on the mattress fitted with the under-mattress bed sensor is awake.

NOTE 3

The device cannot be used to verify whether the alerted body movement was caused by a tonic-clonic seizure. The occurrence of a tonic-clonic epileptic seizure can be verified, among other things, against electroencephalogram (EEG) data interpreted by a healthcare professional. The Emfit Tonic-Clonic Seizure Monitor cannot replace an EEG recording system.

NOTE 4

Always ensure the suitability of the device - particularly for small children - by conducting a test run. There are no weight or age restrictions for the use of the device.

3.2. Liability of the manufacturer

Emfit Ltd. is liable to ensure the safety, reliability and performance of the device, provided that:

- the device is installed, used and cleaned in accordance with the instructions in this manual
- any changes to the product, maintenance and repairs are conducted by a person trained by Emfit Ltd. or its representative
- any spare parts or accessories used have been approved by Emfit Ltd.

3.3. About this manual

Read all warnings and reminders in this manual with care to avoid any hazardous situations and damage.

4. PACKAGE CONTENTS

- A control unit and two screws to attach the lid (D-1090-2G) *(picture 1)*
- A bed sensor (L-4060SL or L-4060SLC) *(picture 6)*
- Two pieces 3M double-sided tape to fix the sensor *(picture 26)*
- A wall mounting bracket with two screws and two plugs *(picture 7)*
- Clip for bed side attachment *(picture 8)*
- This manual
- Two AA size 1.5 V alkaline batteries
- Optional power supply (GlobTek model no: GTM41060-1505 and P/N: WR9QA3000LCP-N-MNK) *(picture 2)*

5. GENERAL

5.1. Control unit *(picture 1)*

The control unit emits a notification via dry-contact output and by sound (unless muted) when the sensor detects fast-paced movement (frequency 3–20Hz) in the bed for the duration of the preset time (10, 13, 16 or 20 sec.).

The control unit operates with 2 pcs AA size 1.5 V alkaline batteries. An optional AC adapter is available. Do not use any power supply other than that provided by Emfit Ltd. (model no. GTM41060-1505 and P/N:WR9QA3000LCP-N-MNK, manufactured by Globtek) *(picture 2)*. In the event of a power failure, two high-quality 1.5V AA alkaline batteries can be used as an emergency power supply. Do not use any rechargeable batteries or lithium-ion batteries! Rechargeable or lithium-ion batteries carry the risk of melting, ruining the device and causing possible danger to the user.

The control unit has an input connector for the bed sensor (X3) and power supply (X1). The device also has a connector (X2) to transfer the notification via an external system e.g. a nurse call system or a personal emergency phone.

Next to the input connector, there is a push button (SW1) that can be used to acknowledge a notification or as an on/off switch. *(picture 3)*

The control unit has 8 DIP switches *(picture 4)* to select the settings and a rotary switch to adjust the sensitivity of the device. *(picture 5)*

5.2. Bed sensor *(picture 6)*

The bed sensor produces a millivolt alternating current when detecting movement. The control unit calculates the frequency and scale of the movement from this signal and, on this basis, detects possible tonic-clonic seizure. Micro-movement from heartbeat allow the device to detect the person's presence.

6. SETTING UP THE DIP SWITCHES

Open the lid of the control unit by lifting it from the side *(picture 9)*. Inside, you will find eight DIP switches that are used to select the desired functions *(picture 4)*. Remember to select the desired settings using the DIP switches before using the device.



Disconnect the device from the power supply before opening the lid.



Remove the batteries and disconnect the power supply before setting up the DIP switches in order to implement the new settings.

The control unit has the following factory settings. DIP 1, 2, 4, 5, 6, 7 and 8 OFF (down). DIP 3 ON (up). With these settings:

- Movement notification delay is 13 seconds.
- The SW1 switch acts as the On/Off switch which means that the device can be switched on or off by pressing the switch for three (3) seconds.
- The notification sound is loudest.
- The bed exit notification is disabled

6.1. Adjusting the tonic-clonic seizure notification delay (switches #1 and #2)

When the device detects faster movement (between 3–20Hz), its internal timer switches on. The device gives a notification if the move-

ment continues for longer than the preset time. The desired delay should be set up according to the table below. The factory setting is 13 seconds. If the user makes other habitual movements, such as rocking, scratching or restlessness, a longer delay time can be selected to avoid false notifications.

Setting the fast movements duration after which the notification goes off	Switch # 1	Switch #2
10 seconds	ON (up)	ON (up)
13 seconds (default)	OFF (down)	OFF (down)
16 seconds	ON (up)	OFF (down)
20 seconds	OFF (down)	ON (up)

6.2. Setting the Bed-Exit Notification Delay

The device can be set to trigger notification when person leaves the bed and system does not notice any micro-movements.

Time delay	Switch # 3	Switch # 4	Switch #5
No Delay	OFF (down)	OFF (down)	OFF (down)
Disabled (default)	ON (up)	OFF (down)	OFF (down)
3min Delay	ON (up)	ON (up)	OFF (down)
6min Delay	OFF (down)	OFF (down)	ON (up)
10min Delay	ON (up)	OFF (down)	ON (up)
15min Delay	OFF (down)	ON (up)	ON (up)
30min Delay	ON (up)	ON (up)	ON (up)

6.3. SW 1 switch function (switch #6)

SW 1 switch function	Switch #6
The SW1 switch acts as the On/Off switch which means that the device can be switched on or off by pressing the switch for three (3) seconds.	OFF (down)
The SW1 switch does not act as the On/Off switch. The device is always on when it is connected to the power supply or when the batteries are in.	ON (up)

6.4. Adjusting the notification sound volume (switches #7 and #8)

There are four volume levels: Very loud, loud, quiet and mute. The factory setting is very loud.

Level	Switch #7	Switch #8
Very loud	OFF (down)	OFF (down)
Normal	ON (up)	OFF (down)
Quiet	OFF (down)	ON (up)
Mute	ON (up)	ON (up)

The notification sound stops when the SW1 switch is pressed or when the seizure stops.



Remove the batteries and disconnect the power supply before setting up the DIP switches. If the power supply is not disconnected, the new settings will not take effect.

7. INSERTING BATTERIES AND BATTERY SERVICE LIFE



Disconnect the device from the (optional) power supply before opening the lid.

Product operates with 2 pcs high quality AA size 1.5 V alkaline batteries (operating voltage $2 \times 1.5V = 3V$). Install and remove the batteries as follows:

1) Open the lid by removing the screws and lifting it from one side (for first-time assembly: the screws for the lid can be found in the pouch containing wall mounting parts). **(picture 9)**

2) Insert two high-quality AA size 1.5V alkaline batteries into the device following the polarity symbols at the bottom of the device. Close the lid and screw the screws back on. **(picture 10)**

The easiest way to remove a battery is by lifting it from the + end. **(picture 11)**

Estimated battery life is 3 months when using high quality alkaline batteries with 2800 mAh capacity (2pcs). Estimation is based on measured battery consumption in various conditions and then a calculation where device is on 50% of time (shut down 50% of time) and of that 50% of time there is someone in bed 75% of that time, there are two notifications per day and sound notification is on 30 seconds each time.



When the batteries are getting low, the red LED will begin to flash slowly. A "beep" sound will be heard after every 1.5 hours and the dry-contact output will give a low battery notification after every 3 hours.



NOTE! All alkaline batteries start to leak when empty, and a leak will contaminate the device. Remember to replace the batteries at least once a year to avoid any leaks. Remove the batteries when the device is not being used or when it is being stored for an extended period. Disconnect the power supply briefly to test the batteries. If the batteries are empty, the red light on the control unit will flash every fourth time compared to blue light. The X2 connector and the connected system will also trigger a notification. Replace the batteries when necessary.



Product is tested and safe to use with following two alkaline batteries:

Manufacturer: Duracell Type: AA 1.5V Model: MN1500 LR6

Manufacturer: Energizer Type: AA 1.5V Model: E91 LR6 AM3



Do not use any rechargeable batteries or lithium-ion batteries! Rechargeable or lithium-ion batteries carry the risk of melting, ruining the device and causing possible danger to the user.

8. EXTERNAL POWER SUPPLY

Set up the power supply in the following manner:

- 1) Remove the plastic cover. **(picture 23)**
- 2) Select a suitable plug from the four alternatives. **(picture 24)**
- 3) Plug in the plug and ensure that it is not loose. **(picture 25)**



The control unit has been designed and tested to be used with the Globtek inc. power supply model no GTM41060-1505 and P/N: WR9QA3000LCP-N-MNK. Using any other power supply may interfere with the safe use of the device.



The power supply is fitted with a light which lights up when the power supply is connected. If the light is not on while the power supply is connected to the mains, the power supply is probably faulty and needs to be replaced.



When the power supply is connected, the batteries act as backup power supply in the event of a power failure. All alkaline batteries self-discharge and start to leak when empty, contaminating the device. Ensure that batteries are replaced at least once a year.



When removing the power supply from the socket, ensure that the plug part is not left in the socket. If the plug part is left in the socket, touching or trying to remove it carries the risk of an electric shock.

9. CONNECTORS AND CABLES

Connector symbols can be found at the bottom of the control unit. *(picture 3)*



X1 / connector for an external power supply. Only use Globtek inc. power supply model no. GTM41060-1505 and P/N: WR9QA3000L-CP-N-MNK which can be obtained as an original accessory from Emfit Ltd.



X2 / AUX connector to connect the device to an external battery-operated wireless transmitter to send the notification to another system. The connector may only be connected to a system safety voltage input with max. voltage below 25V(AC) / 60 (DC), where both poles have been separated from the electrical network. Max. load current 100mA.

9.1. X2 (AUX) Connector Pin Order *(picture 16)*

From left to right:

Pin #1	Common return
Pin #2	Normally Open (NO) send
Pin #3	Normally Closed (NC) send
Pin #4	Low Battery send (NC)
Pin #5	Not in use, do not connect
Pin #6	Not in use, do not connect
Pin #7	Not in use, do not connect
Pin #8	Not in use, do not connect



X3 / sensor connector. Only use the Emfit bed sensor.

Connect the bed sensor *(picture 13)*, the power supply delivered as an accessory *(picture 14)* and any connector cables *(picture 15)* according to the pictures.

10. INSTALLATION OF THE CONTROL UNIT

10.1. With wall mounting bracket

- 1) Fix the mounting bracket onto a wall with the plugs and screws supplied. *(picture 17)*
- 2) Slide the control unit onto the wall mounting bracket. *(picture 18)*
- 3) Press the control unit down until you hear a click. *(picture 19)*

10.1. With bed side clip

- 1) Press the control unit down to the clip *(picture 20)*

11. INSTALLATION OF THE BED SENSOR

- Place the bed sensor across the bed, under the mattress at approximately chest height. (*picture 12*)
- To prevent the bed sensor from moving, fix the sensor to the bed bottom or mattress using the double sided tape provided or e.g. cable ties (*picture 26*). The tape will not leave a mark and it will come off as a whole if removed.
- Check at least once a week that the bed sensor is properly positioned.
- If you are using the bed sensor with a spring mattress, always place the bed sensor between the mattress and the mattress topper!
- Always place the bed sensor under the mattress or mattress topper, never just under the sheet. The bed sensor must not come into direct contact with a person!
- The bed sensor is designed to last for a minimum of two (2) years placed under a foam mattress and against the hard base of a bed frame.
- With a spring mattress, the service life of the bed sensor may be considerably shorter. When the bed sensor is placed on a spring mattress, the user's weight and movement may cause the sensor to crumple, which may affect the sensor's performance. The manufacturer recommends that users replace the sensor when it starts to look crumpled. When used with a spring mattress, the sensor should be replaced every 2-3 years. The warranty does not cover damage caused by crumpling.
- If the bed sensor is used with a pressure care mattress that is adjusted using a compressor pump, the mattress may interfere with the sensor's performance. If you are unsure about the suitability of your mattress, please contact the manufacturer.

12. SW1 PRESS SWITCH (*PICTURE 21*)

12.1. ON/OFF switch

The SW1 switch acts as the on/off switch if this function is activated (DIP switch #6 is down).

Press the SW1 switch for three (3) seconds in order to activate or deactivate the control unit. When the control unit is switched on, you will hear a beep and the blue LED light will start to flash. When the device is switched off, you will hear a "beep-beep-boop" (high-high-low) sound. The blue LED light will go off.

12.2. Acknowledgement switch

The notification sound (if activated) can be muted by pressing the SW1 switch shortly. The device will make a "beep-beep" sound. NOTE! If you press the switch for too long, you might accidentally switch off the device. The notification sound will also stop when the fast-paced movements stop.

12.3. Bed exit alarm bypass switch

The SW1 switch acts as the bypass switch for bed exit alarm if this function is activated and person wants to exit the bed without causing an alarm. Note! This feature will not work if any bed exit delay is being used!

Before leaving the bed press SW1 shortly to hear sound "beep beep". You now have 20 seconds to leave the bed without causing a bed exit alarm. If you do not leave the bed within 20 seconds the device will re-activate.

12.4. Bed exit alarm "presence / absence" sensitivity switch

SW1 switch can be used to launch automatic calibration for presence / absence sensitivity. See chapter 15.

13. SIGNAL LIGHTS (*PICTURE 22*)

13.1. Green – Presence

Light flashes every second time compared to blue light.	A person is on the bed or other movement is being made.
Light flashes the same speed as blue light.	A person has been on the bed for 60 seconds and the device has become activated.
Light flashes rapidly.	Fast-paced movement on the bed detected.
Light is off.	No one is on the bed.

13.2. Blue – Device on/standby

Light is off.	Device is switched off.
Light flashes slowly.	Device is switched on.
Light flashes rapidly a few times.	Device triggers a notification.

13.3. Red – Malfunction

Light is flashing the same speed as blue light	Bed sensor is disconnected or defective. Signal alarm sounds after 10 seconds and then every 45 seconds. There is also an alarm sent through the X2 connector after 30 seconds and then every 30 minutes.
Light is flashing every fourth time compared to blue light.	Batteries are empty. Replace batteries.

14. SETTING SENSITIVITY TO NOTICE TONIC-CLONIC SEIZURE

The sensitivity to notice fast movements caused by tonic-clonic seizure can be adjusted with the 10-position rotary switch inside (see picture 5). The factory default setting is #3.

Use following table to make a pre-adjustment per person weight BUT adjust it if needed either up or down. If you feel that sensitivity is not good enough, simply adjust higher step by step. Or, if you feel it is too sensitive causing false notifications, simply drop the setting lower step by step.

Test it so that when person is in bed, gentle tapping of mattress nearby sensor should start the green led blinking faster which indicates fast movements are detected. If not, adjust higher. However, when person is lying still it should not start blinking fast without reason. If so, adjust lower.

During rest the green led should blink the same speed as blue led. If person is rolling over in bed, lights may momentarily blink faster. This type of normal movement in bed should not last long enough for the notification to sound.

Person weight	Switch position# (in parenthesis if false alarms occur)
>75 kg	1 (0)
50 - 75 kg	2 (1)
35 - 50	3 (2 or 1)
25 - 35	4 or 5 (3 or 2)
15 - 25	6 or 7 (5 or 4)
<15	8 or 9 (7 or 6)

15. CALIBRATING THE “PRESENCE / ABSENCE” SENSITIVITY

15.1. Doing calibration

If you use the bed-exit (absence) notification, the sensitivity to determine that person is in or out of the bed is adjusted in calibration mode. The person to be monitored should be in bed and lying still (not moving or talking) for at least one (1) minute until green light starts to blink the same speed as blue light. The monitor (control unit) should be placed on a table, clipped on bed, or mounted on wall. Do not hold monitor in hand while testing. Sensor should be in correct position under mattress.

Start calibration by pressing the SW1 switch (picture 21) three (3) times. You will hear 3 low and high tones (bu-beep, bu-beep, bu-beep). The calibration takes 18 seconds. If calibration is successful, the confirmation sound will be the same 3 low and high tones (bu-beep, bu-beep, bu-beep).

15.2. Error messages and how to handle them

One (1) long beep - Device has not detected strong enough micro movement signal and has reached an adjustment limit. Device might not work optimally. Is the sensor positioned correctly in the bed and device was not in error -state (red led was not blinking)? If not: Correct the problem and re-try calibration. If yes: Adjust the rotary switch (picture 5) up 2 notches and re-try auto adjustment.

Two (2) long beeps - Device has detected too strong signal and has reached an adjustment limit. Device might not work optimally. Was person laying still during the calibration period? Re-try calibration again and see if second time would be successful. If second time gives same error sound, adjust the rotary switch (picture 5) down 2 notches and do the calibration again.

You can always return sensitivity to factory default. First press SW1 three (3) times and soon after hearing the three sounds, press SW1 again 3 times. That interrupts adjustment and device returns to factory setting.



Adjust the sensitivity of the device every time the sensor is re-installed, if the user or the sensor changes.

16. CHECKS

16.1. Weekly checks

1. Condition of the cables

Check the condition of the cables

2. Position of the bed sensor

Check the position of the bed sensor under the mattress. The correct position is at the chest height of the user and across the bed.

16.2. Start-up and monthly checks

To ensure faultless performance, conduct the following tests at least once a month and when ever the device is re-installed.

1. Testing the absence notification sensitivity

To test the sensitivity of the sensor, have person lie on the bed completely still and without talking. Wait at least 1–2 minutes. If the green light does not light up, adjust the rotary switch up one position at a time until the green light lights up. If the green LED lights up when no one is on the bed, adjust the rotary switch down one position at a time until the green light is no longer on. See also chapter "Calibrating the "presence / absence" sensitivity.

2. Testing the tonic-clonic seizure notification

Make fast-paced movements (e.g. tapping the mattress repeatedly around the bed sensor). The device should trigger a notification after the preset delay time has passed (10–20 seconds depending on the position of DIP switches #1 and #2). The green light should start flashing when you tap the mattress. See also chapter "Setting sensitivity to notice tonic-clonic seizure":

17. TROUBLESHOOTING

Ensure that the device is properly installed. Test the device carefully every time its settings are adjusted.

The device triggers a notification but the nurse call system does not.	Ensure that the external wireless transmitter or other system's connection cable is connected to the X2 connector. Check the battery of the external wireless transmitter.
Notification sound is inaudible	Check the volume.
The device triggers a notification even if there is no unusual movement	Check the condition, installation and position of the bed sensor. Check that the sensitivity setting of the sensor is not too high. The green light should not be on if no one is on the bed. The device may interpret normal movements (scratching, rocking, etc.) as a seizure. Adjust the delay time longer if necessary. Some people are restless before they fall asleep, and this might cause false notifications. Try switching the device on only after the person has fallen asleep. If the bed exit alarm is enabled (DIP switch 3 in DOWN position) and sensitivity is not set high enough, alarm may trigger. Either disable alarm (DIP switch 3 in UP position) or see section 15.
The green light is on even if no one is on the bed.	Ensure that the bed sensor and its cables are not affected by external movement and remove any distractions. Check the condition of the bed sensor and its cables. Faulty sensor or cable may cause distractions so that the green light is on all the time. Adjust sensitivity
The device does not trigger a notification, and the green light is on even if no one is on the bed.	Check the condition of the bed sensor and its cables. Faulty sensor or cable may cause distractions so that the green light is on all the time. This means that the device cannot necessarily detect a seizure due to constant distraction.

The device does not trigger a notification, and the green light is not on even if someone is on the bed.

Check the condition of the bed sensor and its cables. Check the sensitivity of the device by having someone lie on the bed completely still. The green light should be on.

See also the "Troubleshooting Flow Chart" (picture 27).

If you experience any problems with the use of the device, please contact the manufacturer.

18. CLEANING

You can wipe the bed sensor and cables, control unit and external power supply with a damp cloth, neutral cleaning product or mild disinfectant.



Always disconnect the external power supply before cleaning the device. Dry all parts well after cleaning.

19. DISPOSAL OF THE DEVICE AFTER USE

In conformity with the Waste Electrical and Electronic Equipment Directive (WEEE Directive), the device must be collected separately and returned to an authorised collection facility. The owner must take the device to the waste collection point specified by local authorities.



For more information on how to dispose of the device, please contact the relevant authorities.

20. DECLARATION OF CONFORMITY (EU)



The manufacturer, Emfit Ltd., hereby declares that the Emfit Tonic-Clonic Seizure Monitor conforms with the relevant requirements of the Medical Device Directive 93/42/EEC.

21. EMFIT LIMITED WARRANTY STATEMENT

In the unlikely event that your product needs guarantee service, please contact your dealer, distributor or manufacturer. To avoid any unnecessary inconvenience on your part, we recommend you read this instruction manual carefully before seeking guarantee service.

YOUR GUARANTEE

By this Guarantee, Emfit guarantees the product to be free from defects in materials and workmanship at the date of original purchase for a period of two (2) years from that date.

If within the guarantee period the product is determined to be defective (at the date of original purchase) due to improper materials or workmanship, Emfit will, without charge for labour or parts, repair or (at Emfit's discretion) replace the product or its defective parts subject to the terms and limitations below. Emfit may replace defective products or parts with new or refurbished products or parts. All products and parts replaced become the property of Emfit.

TERMS

Guarantee services will be provided only if the original invoice or sales receipt (indicating the date of purchase, model name and dealer's name) is presented with the defective product within the guarantee period. Emfit may refuse free-of-charge guarantee service if these documents are not presented or if they are incomplete or illegible. This Guarantee will not apply if the model name or serial number on the product has been altered, deleted, removed or made illegible.

This Guarantee does not cover transport costs and risks associated with transport of your product to and from Emfit.

This Guarantee does not cover:

- a) periodic maintenance and repair or parts replacement due to wear and tear. Notice! Emfit bed sensor wears and tears significantly faster when installed on soft base like spring mattress.
- b) consumables (components that are expected to require periodic replacement during the lifetime of a product such as non-rechargeable batteries)
- c) damage or defects caused by use, operation or treatment of the product inconsistent with normal use
- d) damage or changes to the product as a result of:

- i. misuse, including:
 - treatment resulting in physical, cosmetic or surface damage or changes to the product
 - failure to install or use the product for its normal purpose or in accordance with Emfit's instructions on installation or use
 - failure to maintain the product in accordance with Emfit's instructions on proper maintenance
 - installation or use of the product in a manner inconsistent with the technical or safety laws or standards in the country where it is installed or used
- ii. the condition of or defects in systems with which the product is used or incorporated except other Emfit's products designed to be used with the product
- iii. use of the product with accessories, peripheral equipment and other products of a type, condition and standard other than prescribed by Emfit
- iv. repair or attempted repair by persons who are not Emfit employees
- v. adjustments or adaptations without Emfit's prior written consent, including:
 - upgrading the product beyond specifications or features described in the instruction manual, or modifications to the product to conform it to national or local technical or safety standards in countries other than those for which the product was specifically designed and manufactured
- vi. neglect
- vii. accidents, fire, liquids, chemicals, other substances, flooding, vibrations, excessive heat, improper ventilation, power surges, excess or incorrect supply or input voltage, radiation, electrostatic discharges including lightning, other external forces and impacts.
This guarantee covers only hardware components of the product.

EXCLUSIONS AND LIMITATIONS

Except as stated above, Emfit makes no warranties (express, implied, statutory or otherwise) regarding product or accompanying or constituent software quality, performance, accuracy, reliability, fitness for a particular purpose, or otherwise. If this exclusion is not permitted or fully permitted by applicable law, Emfit excludes or limits its warranties only to the maximum extent permitted by applicable law. Any warranty that cannot be fully excluded will be limited (as far as permitted by applicable law) to the duration of this Guarantee. Emfit's only obligation under this Guarantee is to repair or replace products subject to these Guarantee terms and conditions. Emfit is not liable for any loss or damage relating to products, service, this Guarantee or otherwise, including - economic or intangible losses - the price paid for the product - loss of profits, revenue, data, enjoyment or use of the product or any associated products - indirect, incidental or consequential loss or damage. This applies whether that loss or damage relates to: impaired or non-operation of the product or associated products through defects or unavailability while with Emfit, which caused downtime, loss of user time or business interruption inaccuracy of output from the product or associated products.

This applies to loss and damages under any legal theory, including negligence and other torts, breach of contract, express or implied warranty, and strict liability (even where Emfit has been advised of the possibility of such damages).

Where applicable law prohibits or limits these liability exclusions, Emfit excludes or limits its liability only to the maximum extent permitted by applicable law. For example, some countries prohibit the exclusion or limitation of damages resulting from negligence, gross negligence, wilful misconduct, deceit and similar acts. Emfit's liability under this guarantee will in no case exceed the price paid for the product, but if applicable law permits only higher liability limitations, the higher limitations apply.

YOUR LEGAL RIGHTS RESERVED

Consumers have legal (statutory) rights under applicable national laws relating to the sale of consumer products. This guarantee does not affect statutory rights you may have nor those rights that cannot be excluded or limited, nor rights against the person from whom you purchased the product. You may assert any rights you have at your sole discretion.

22. TECHNICAL SPECIFICATIONS



Equipment is not suitable for use in the presence of a flammable anaesthetic mixture with air or with oxygen or nitrous oxide.

Equipment is for continuous operation

22.1. Control unit

Model:	D-1090-2G
Operating voltage:	3V DC with batteries / 5V DC with external power supply

Input and output connectors:	Power supply, AUX and bed sensor
Dry-contact output:	Max. 100mA A, <60V DC, <25V AC
Switches and controls:	SW1 (On/Off/Reset switch), 8 pcs DIP switches for settings (volume, delay), one 10-position rotary switch for adjusting sensitivity.
Signal lights:	3 LEDs: green, blue and red
Delays:	Movement notification delay alternatives: 10s, 13s, 16s or 20s.
Mounting:	Wall mounting, bed-side or table
Measurements:	96 x 127 x 34mm
Weight (g):	120g
Colour:	White
IP rating:	IP20
Casing:	Plastic

22.2. Sensor

Model:	L-4060SL / L-4060SLC
Type:	Bed sensor
Placing:	Under a mattress
Portability:	Yes
Measurements mm (length x width):	430 x 580mm
Thickness:	0.4mm / 1.4mm
Weight:	185g / 410g
Colour:	Blue / White
Surface material:	Polyester / PVC
Cable length:	1,8m
IP rating:	IP20

22.3. External Power Supply

Manufacturer	GlobTek inc.
Model	GTM41060-1505
Input voltage	100-240 V
Input current	<0,6 A RMS MAX
Input frequency	50 - 60 Hz
Output voltage	5 VDC
Output power (rated)	3,0 A, no minimum load required
Electrical safety class	Class II

22.4. Ambient conditions

Operating temperature:	10–40°C
Storage and transport temperature:	-30–50°C
Relative humidity:	20–75%

22.5. Product class

Product class in accordance with the Directive 93/42/EEC:	Class I
Electrical safety class:	Internal and external power supply / Class II device

23. ELECTROMAGNETIC CONDITIONS

System specification:

D-1090-2G monitor

L-4060SL or L-4060SLC bed sensor

GlobTek power supply model: no GTM41060-1505 and P/N:WR9QA3000LCP-N-MNK

Cable specification:

Power cable (non-shielded) max. Length 2 m

Sensor cable (shielded) max. length 3 m

Note! RF communications equipment can effect medical electrical equipment!

Guidance and manufacturer's declaration – electromagnetic emissions

The Emfit Tonic-Clonic Seizure Monitor is intended for use in the electromagnetic environment specified below. The customer or the user of the equipment should assure that it is used in such an environment.

RF emissions CISPR 11	Group 1	The Emfit Tonic-Clonic Seizure Monitor uses RF energy only for its internal function. Therefore, its RF emissions are very low and are not likely to cause any interference in nearby electronic equipment.
RF emissions CISPR 11	Class B	The Emfit Tonic-Clonic Seizure Monitor is suitable for use in all establishments, including domestic establishments and those directly connected to the public low-voltage power supply network that supplies buildings used for domestic purposes.
Harmonic emissions IEC 61000-3-2	Class A	
Voltage fluctuations/ flicker emissions IEC 61000-3-3	Complies	

Guidance and manufacturer's declaration – electromagnetic immunity

The Emfit Tonic-Clonic Seizure Monitor is intended for use in the electromagnetic environment specified below. The customer or the user of the equipment should assure that it is used in such an environment.

Immunity test	IEC 60601 test level	Compliance level	Electromagnetic environment
Electrostatic discharge (ESD) IEC 61000-4-2	±6 kV contact ±8 kV air	IEC-60601-1-2 test level	Floors should be wood, concrete or ceramic tile. If floors are covered with synthetic material, the relative humidity should be at least 30 %.
Electrical fast transient/burst IEC 61000-4-4	±2 kV for power supply lines ±1 kV for input/output lines	IEC-60601-1-2 test level	Mains power quality should be that of a typical commercial or hospital environment.
Surge IEC 61000-4-5	±1 kV line(s) to line(s)	IEC-60601-1-2 test level	Mains power quality should be that of a typical commercial or hospital environment

<p>Voltage dips, short interruptions and voltage variations on power supply input lines IEC 61000-4-11</p>	<p><5 % UT (>95 % dip in UT) for 0.5 cycle 40 % UT (60 % dip in UT) for 5 cycles 70 % UT (30 % dip in UT) for 25 cycles <5 % UT (>95 % dip in UT) for 5 sec</p>	<p>IEC-60601-1-2 test level</p>	<p>Mains power quality should be that of a typical commercial or hospital environment. If the user of the The Emfit epileptic seizure alarm enquires continued operation during power mains interruptions, it is recommended that the Emfit Tonic-Clonic Seizure Monitor be powered from an uninterruptible power supply or battery.</p>
<p>Power frequency (50/60 Hz) magnetic field IEC 61000-4-8</p>	<p>3 A/m</p>	<p>IEC-60601-1-2 test level</p>	<p>Power frequency magnetic fields should be at levels characteristic of a typical location in a typical commercial or hospital environment.</p>

NOTE UT is the a.c. mains voltage prior to application of the test level.

Guidance and manufacturer's declaration – electromagnetic immunity

The Emfit Tonic-Clonic Seizure Monitor is intended for use in the electromagnetic environment specified below. The customer or the user of the equipment should assure that it is used in such an environment.

Immunity test	IEC 60601 test level	Compliance level	Electromagnetic environment – guidance
Conducted RF IEC 61000-4-6	3 Vrms 150 kHz to 80 MHz	3 V 150 kHz to 80 MHz	<p>Portable and mobile RF communications equipment should be used no closer to any part of the Emfit Tonic-Clonic Seizure Monitor, including cables, than the recommended separation distance calculated from the equation applicable to the frequency of the transmitter.</p> <p>Recommended separation distance</p> $d = 1,2\sqrt{P}$
Radiated RF IEC 61000-4-3	3 V/m 80 MHz to 2.5 GHz	3 V/m 80 MHz to 2.5 GHz	$d = 1,2\sqrt{P} \quad 80 \text{ MHz} - 800 \text{ MHz}$ $d = 2,3\sqrt{P} \quad 800 \text{ MHz} - 2.5 \text{ GHz}$ <p>where P is the maximum output power rating of the transmitter in watts (W) according to the transmitter manufacturer and d is the recommended separation distance in metres (m).</p> <p>Field strengths from fixed RF transmitters, as determined by an electromagnetic site survey, ^a should be less than the compliance level in each frequency range. ^b</p> <p>Interference may occur in the vicinity of equipment marked with the following symbol:</p> 

NOTE 1 At 80 MHz and 800 MHz, the higher frequency range applies.

NOTE 2 These guidelines may not apply in all situations. Electromagnetic propagation is affected by absorption and reflection from structures, objects and people.

^a Field strengths from fixed transmitters, such as base stations for radio (cellular/cordless) telephones and land mobile radios, amateur radio, AM and FM radio broadcast and TV broadcast cannot be predicted theoretically with accuracy. To assess the electromagnetic environment due to fixed RF transmitters, an electromagnetic site survey should be considered. If the measured field strength in the location in which the Emfit Tonic-Clonic Seizure Monitor is used exceeds the applicable RF compliance level above, the Emfit Tonic-Clonic Seizure Monitor should be observed to verify normal operation. If abnormal performance is observed, additional measures may be necessary, such as reorienting or relocating the Emfit Tonic-Clonic Seizure Monitor.

^b Over the frequency range 150 kHz to 80 MHz, field strengths should be less than 3 V/m.

Recommended separation distances between portable and mobile RF communications equipment and the Emfit Tonic-Clonic Seizure Monitor.

The Emfit Tonic-Clonic Seizure Monitor is intended for use in an electromagnetic environment in which radiated RF disturbances are controlled. The customer or the user of the Emfit epileptic seizure alarm can help prevent electromagnetic interference by maintaining a minimum distance between portable and mobile RF communications equipment (transmitters) and the Emfit Tonic-Clonic Seizure Monitor alarm as recommended below, according to the maximum output power of the communications equipment.

Rated maximum output power of transmitter W	Separation distance according to frequency of transmitter		
	150 kHz – 80 MHz $d = 1,2\sqrt{P}$	80 MHz – 800 MHz $d = 1,2\sqrt{P}$	800 MHz – 2.5 GHz $d = 2,3\sqrt{P}$
0.01	0.12 m	0.12 m	0.23 m
0.1	0.38 m	0.38 m	0.73 m
1	1.2 m	1.2 m	2.3 m
10	3.8 m	3.8 m	7.3 m
100	12 m	12 m	23 m

For transmitters rated at a maximum output power not listed above, the recommended separation distance d in metres (m) can be determined using the equation applicable to the frequency of the transmitter, where P is the maximum output power rating of the transmitter in watts (W) according to the transmitter manufacturer.

NOTE 1 At 80 MHz and 800 MHz, the separation distance for the higher frequency range applies.

NOTE 2 These guidelines may not apply in all situations. Electromagnetic propagation is affected by absorption and reflection from structures, objects and people.

24. MANUFACTURER

Emfit Ltd.
Konttisentie 8
FI-40800 Vaajakoski, Finland
Telephone: +358 20 778 0870
Fax: +358 20 778 0871
Email: info@emfit.com
Internet: www.emfit.com

25. APPENDIX - RELATED PICTURES

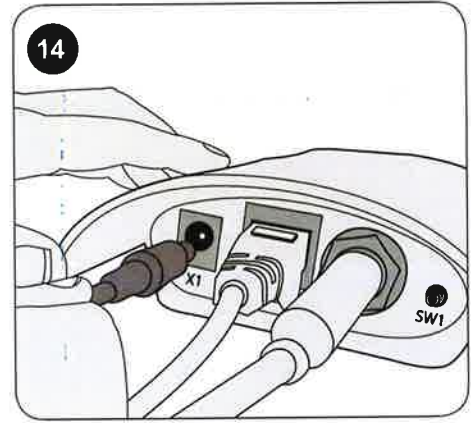
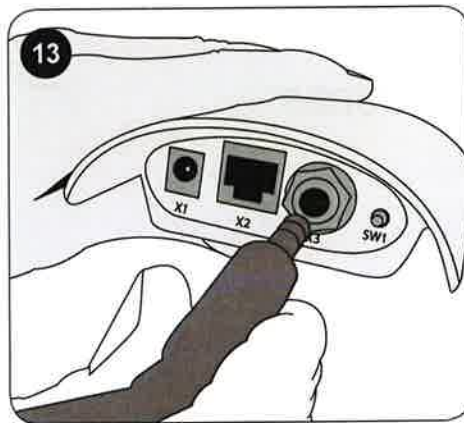
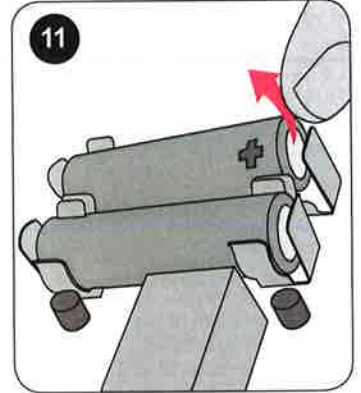
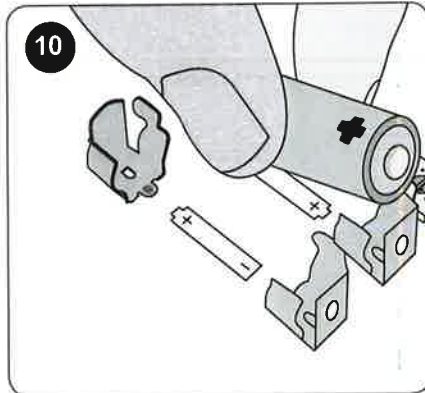
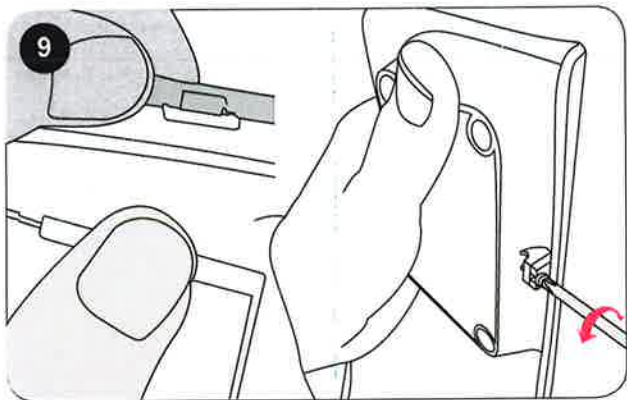
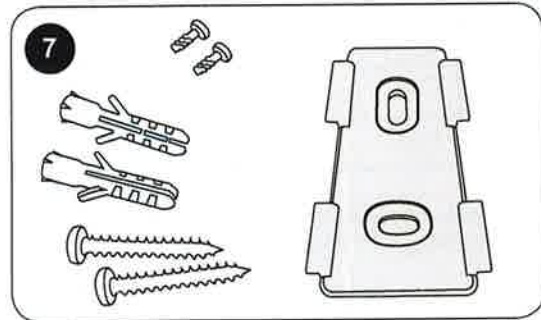
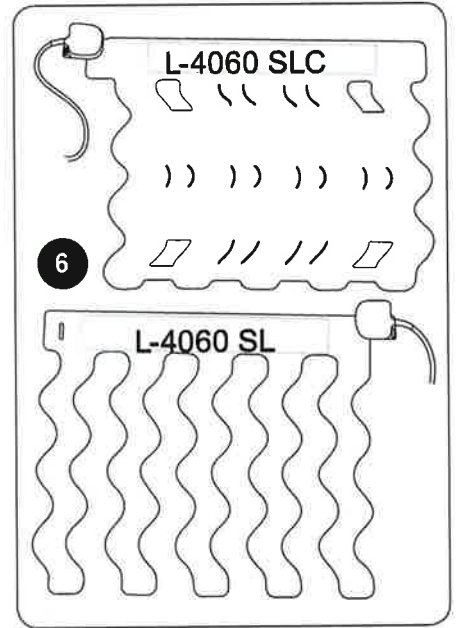
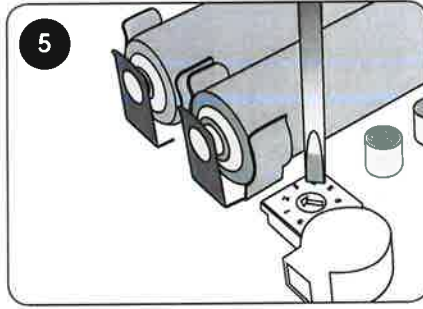
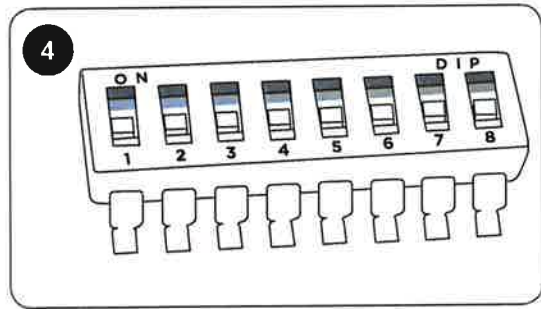
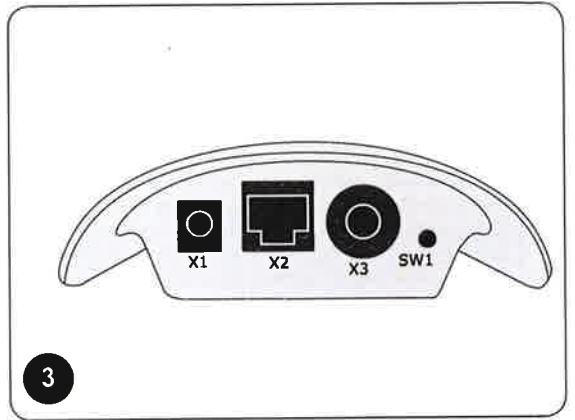
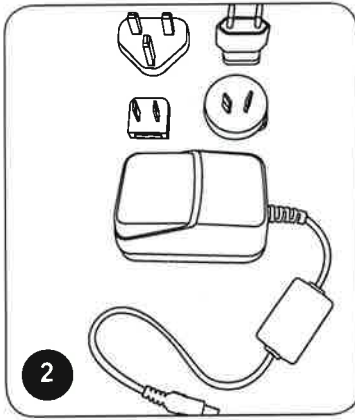
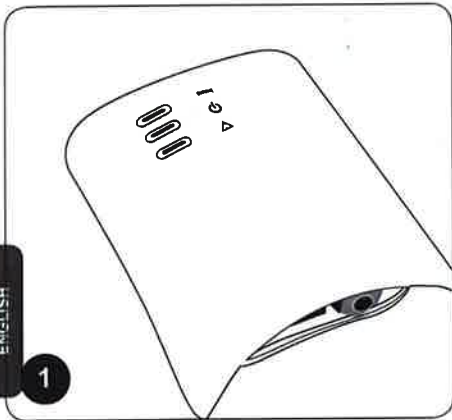

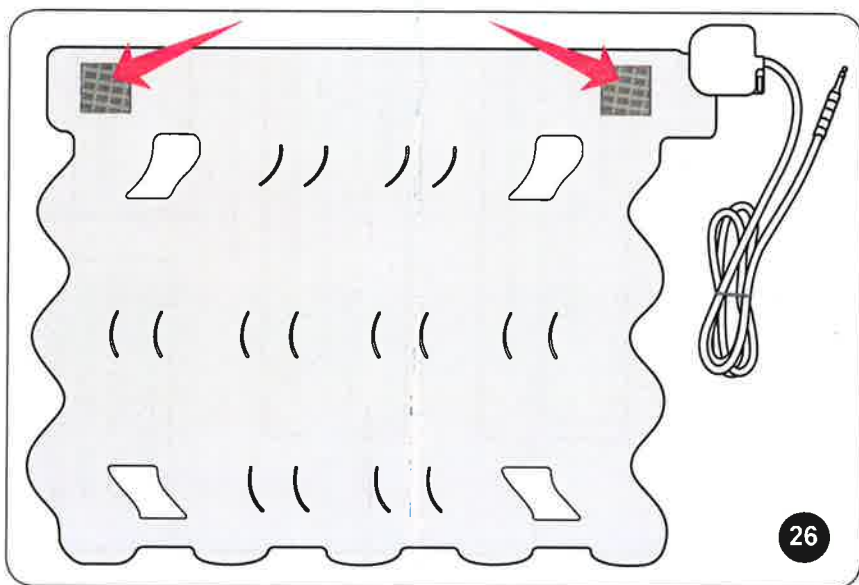
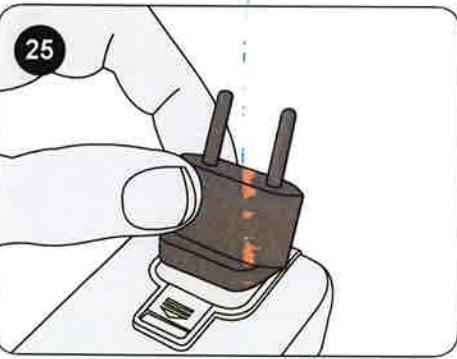
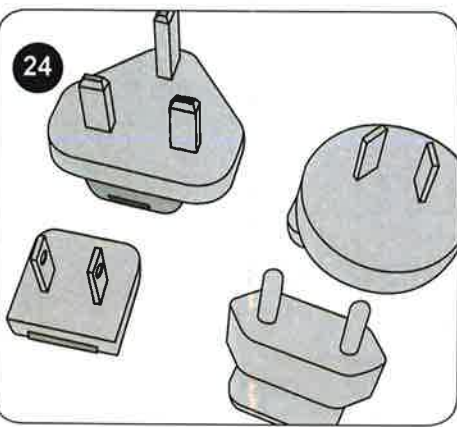
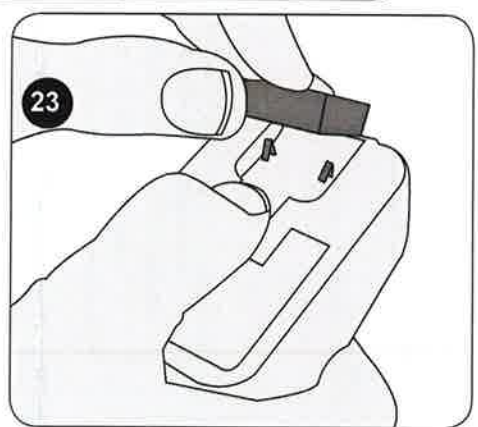
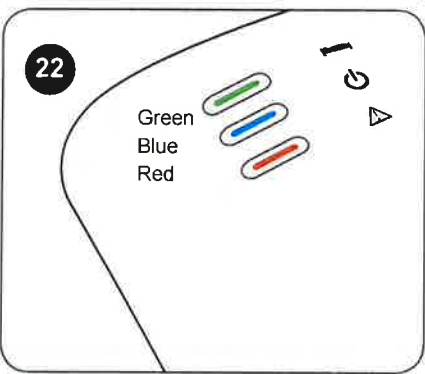
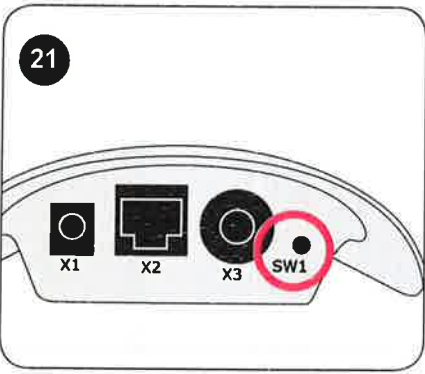
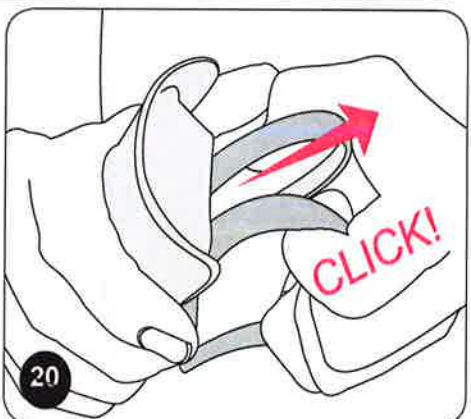
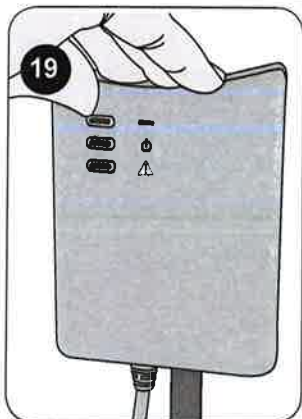
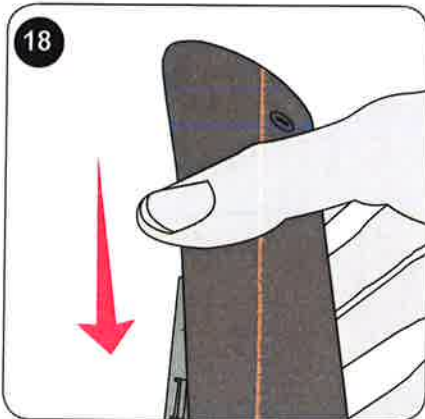
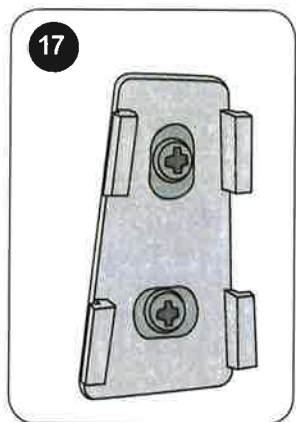
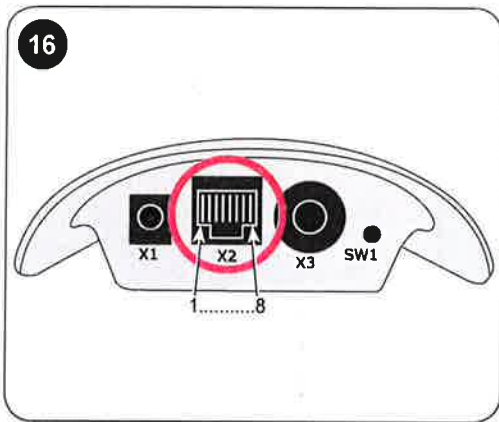
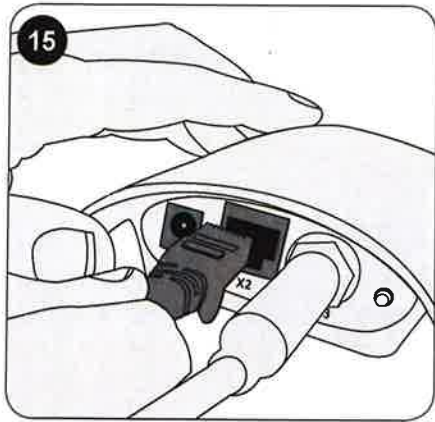

Emfit Tonic-Clonic Seizure Monitor Trouble Shooting Flow Chart

My monitor does not seem to be working properly.

I have already verified that power is on (blue led is blinking).

Batteries are installed or AC adapter is plugged in. Does the monitor turn ON when pressing the SW1 switch for 4 seconds (blue light will start to blink)?

Contact customer service.

YES

NO

NO

NO

Is the red light blinking on the control unit?

YES

Verify that system is installed, ready for use and no one is in the bed. Is green light now blinking?

NO

Test the fast movement notification operation by gently tapping the mattress at the sensor area. The green light must begin to blink faster and the alarm sound after pre-set delay.

Is the sensor connected to the control unit?

YES

Presence detection sensitivity is too high. Read the manual chapter regarding presence detection sensitivity adjustment.

NO

IF EITHER

NO

Connect sensor to the device.

NO

Good. Now have person lying still on the bed. Is the green light blinking at the same speed (simultaneously) as the blue? (wait at least 2 minutes)

YES

NO

NO, every second time

Replace batteries.

YES

Is the red light blinking the same speed as the blue light?

NO

Sensitivity is too low. Read the manual chapter regarding presence detection sensitivity adjustment.

NO

If device did not notice fast movement notifications, adjust the orange rotary switch by step higher until you feel sensitivity is correct.

OR

IF experiencing false fast movement notifications, adjust orange rotary switch by step lower until you feel sensitivity is correct.

Ask person to leave the bed. Does the green light stop blinking a few seconds afterwards? If bed exit alarm is enabled, alarm should sound within 5-10 seconds.

NO

YES

Sensor needs to be replaced.

NO

Monitor is working properly.

YES

Contact customer service.

NO

YES

NO

NO

EMFIT

Emfit Ltd
Kontisentie 8
40800 Vaajakoski
FINLAND

Tel: +358 20 778 0870

Fax: +358 20 778 0871

info@emfit.com

