



Rugasa

RUFINO GARCÍA SÁNCHEZ, S.L.

Edita:

RUFINO GARCÍA SÁNCHEZ, S.L.

FÁBRICA Y OFICINAS

Avda. de San Miguel, 15

47420 Íscar (Valladolid)

Telf.: +34 983 61 13 47 Fax: +34 983 62 01 63

www.rugasa.com

rugasa@rugasa.com



Colección Lisa | Flush Collection | *Colección Lisse*

SERIE LISA	08 - 13
SERIE GRECA	14 - 17
SERIE RANURADA	18 - 23
SERIE ALUMINIO	24 - 27
SERIE LACADA	28 - 32

*Colección Pantografiada**Graphic Desing Collection* | *Collection Moulée Lacqué*

SERIE PANTOGRAFIADA	34 - 36
---------------------	---------

Puertas en block | *Block set* | *Bloc*

38 - 41

PERFILES Y MEDIDAS

Cross sections and Measures / Panneau et Mesures	42 - 43
--------------------------------------------------	---------

MADERAS / Woods / Bois	44 - 45
------------------------	---------

SELLOS DE CALIDAD

Quality Certifications / Certifications de Qualité	46 - 47
----------------------------------------------------	---------



RUGASA, S.L. da un salto en cuanto al diseño de puertas de interior y exterior se refiere, y presenta sus nuevos modelos, basándose en tres conceptos fundamentales: Creatividad, ergonomía y versatilidad. La experiencia de nuestro equipo de profesionales se pone al servicio de la calidad y el diseño para que su hogar sea el lugar perfecto. Lo que hace que una empresa tenga éxito es su equipo de personas y la pasión por el trabajo bien hecho. En RUGASA, S.L. nos enorgullece decir que, gracias a trabajar duro hemos conseguido ser líderes en el sector.

En RUGASA, S.L. le ofrecemos una amplia gama de modelos y diseños para decorar su hogar con el mejor estilo y la máxima calidad.

Este catalogo trata de acercar a sus manos lo mejor de RUGASA, para que disfrute de todas las ventajas que ofrecen nuestros productos.

RUGASA, S.L. takes a step forward in the field of outdoor and indoor door design and presents the new models that are based on three fundamental concepts: Creativity, ergonomics and versatility. The experience of our team of professionals has always been in the service of quality and design, helping you to make your home a perfect place.

What makes a company successful is its team of staff and their passion for a job well done. At RUGASA, S.L. we are proud to say that we are the leading company in our field thanks to our hard work.

RUGASA, S.L. offers a wide range of models and designs to decorate your home with the highest quality and style.

The aim of this catalogue is to bring you the best from RUGASA, giving you the chance to enjoy all the advantages that our product lines offer.

RUGASA, S.L. avance à grands pas vers le design de portes d'intérieur et d'extérieur et présente ses nouveaux modèles, sur la base de trois concepts fondamentaux : créativité, ergonomie et versatilité. L'expérience de notre équipe de professionnels est au service de la qualité et du design pour que votre habitation soit le lieu parfait.

Le succès d'une entreprise est dû principalement à son équipe et à la passion du travail bien fait. Chez RUGASA, S.L. nous sommes fiers de pouvoir affirmer que, grâce à notre travail acharné, nous sommes leader dans le secteur.

RUGASA, S.L. offre une large gamme de modèles et de designs pour décorer votre habitation dans le meilleur style et la plus grande qualité.

Ce catalogue a été conçu afin de rapprocher le meilleur de RUGASA vers vous et pour que vous puissiez profiter de tous les avantages que vous offrent nos produits.



Rugasa

Carpintería - Puertas - Block - Kit
Telf.: 985 61 13 47 - Fax.: 985 62 01 65



RUGASA es una empresa dedicada a la fabricación de carpintería de madera: puertas y block.

La calidad de nuestros productos viene avalada por la certificación que les concede AITIM y que nos obliga a continuos exámenes que aseguran el cumplimiento de las normas UNE de producción.

La empresa fue fundada por D. Rufino García Sánchez en el año 1933, y con el transcurrir de los años se ha posicionado en el mercado como una de las líderes en su sector, ampliando y adaptando sus instalaciones a las exigencias de un mercado, cada vez más internacional y competitivo.

Rugasa ha basado su éxito en la excelente calidad de sus productos; esta calidad es posible gracias a la elección minuciosa de la materia prima, a la aplicación de los conocimientos de tres generaciones de carpinteros y a una tecnología de vanguardia.

El grado de satisfacción de nuestros clientes nos muestra que el camino emprendido es el correcto, por lo que incidiremos en él, mejorando poco a poco en todos los aspectos de nuestra organización. Nuestro objetivo principal es aumentar todo lo posible ese grado de satisfacción.

Rugasa

Rufino García Sánchez, S.L.

Rugasa
RUFINO GARCÍA SÁNCHEZ, S.L.

RUGASA is a company dedicated to the manufacture of woodwork: doors, block.

The quality of our products is guaranteed by the certificate given by AITIM (Association of technical research of the woodworking industries) that requires continuous checking to assure the compliance to the UNE production standards.

The company was founded by Mr Rufino García Sánchez in 1933 and, as time has passed, it has positioned itself in the market as one of the leaders in its sector, expanding and adapting its premises to the demands of a market that is becoming more international and competitive every day.

Rugasa's success is based on the excellent quality of its products; this quality can only be made possible by meticulously selecting the raw materials and using the knowledge of three generations of carpenters together with state-of-the-art technology.

The degree of satisfaction within our clients shows that we are on the right track, and consequently we will continue getting better every day in all aspects of our organisation. Our main objective is, above all, to raise that degree of satisfaction.

RUGASA est une entreprise dédiée à la fabrication de menuiserie: portes, block.

La qualité de nos produits est garantie par le label AITIM qui nous oblige à des examens continus, ce qui assure l'accomplissement des normes UNE de production.

L'entreprise a été créée par Rufino García Sánchez en 1933, et depuis elle n'a cessé de se positionner dans le marché et est maintenant un des leaders de son secteur, en agrandissant et adaptant ses installations aux exigences d'un marché toujours plus international et compétitif.

Rugasa a basé son succès sur l'excellente qualité de ses produits; cette qualité est possible grâce au choix minutieux de la matière première, à l'application des connaissances de trois générations de menuisiers et à une technologie d'avant-garde.

Le niveau de satisfaction de nos clients nous démontre que le chemin suivi est correcte. Notre objectif principal étant d'augmenter au maximum ce niveau de satisfaction.



CANTEADO DE PUERTAS
Bordering - *Rivage*



LIJADO DE PUERTAS
Sanding - *Ponçage des portes*



MECANIZADO DE CERCOS
Frame mechanizing - *Mécanisée des cadres*



MECANIZADO DE PUERTAS
Door mechanizing - *Mécanisée des portes*



ARMADO DE BASTIDORES
Frame assembly - *Assemblage des châssis*



CONFECCION DE CHAPA DE MADERA
Wood panel generation - *Elaboration du tôle du bois*



ARMADO DE BLOCK
Block assembly - *Assemblage du block*



EMBLAJE DE BLOCK
Block packaging - *Emballage du block*



BARNIZADO AUTOMÁTICO DE PUERTAS
Automatic varnished ' doors - *Vernissage automatique des portes*



ALMACÉN MATERIA PRIMA
Raw material ware house - *Depôt de matière première*

Colección Lisa





Rugasa
RUFINO GARCÍA SÁNCHEZ, S.L.

Serie Lisa

Sin renunciar al sentido práctico, se han creado ambientes muy cómodos que rodean de calidez la vida cotidiana.

Never giving up the practical sense, a comfortable atmosphere is created to fill every day with warmth.

Sans renoncer au sens pratique, nous avons créé des ambiances très confortables pour qu'elles rendent plus chaleureuse la vie au quotidien.





Detalle Marco
Door frame detail
Détail encadrement
de porte



Detalle manilla
Detail of handle
Détail poignée

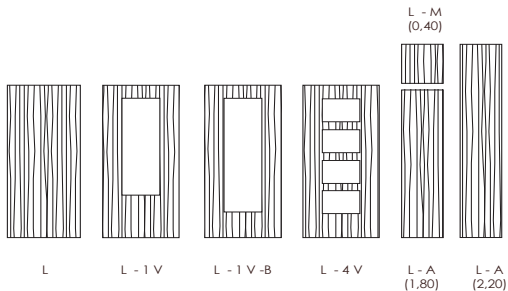

MOD. L

SERIE LISA H



Detalle Marco
Door frame detail
Détail encadrement
de porte



Detalle manilla
Detail of handle
Détail poignée

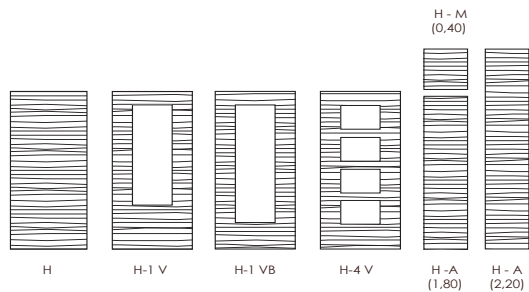

MOD. H



Detalle Marco
Door frame detail
Détail encadrement
de porte



Detalle manilla
Detail of handle
Détail poignée

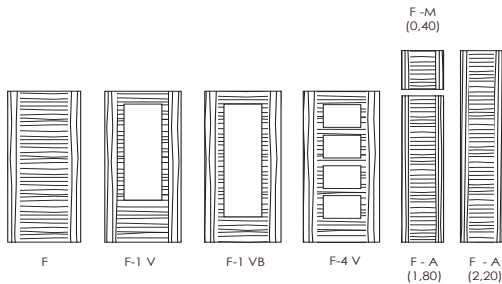

MOD. F

Serie Greca

Colección Lisa

En esta colección encontraremos diseños modernos y funcionales que personalizarán cualquier ambiente.

In this collection you can find modern and functional designs to customize any atmosphere.

Cette collection présente des designs modernes et fonctionnels qui rappellent toutes les ambiances.

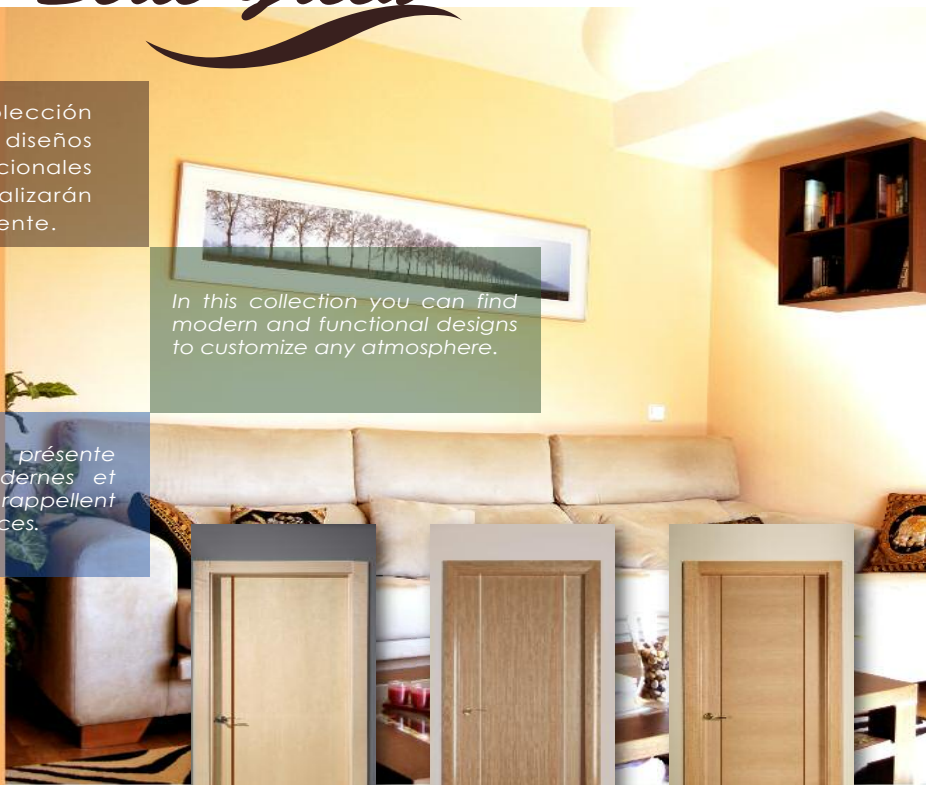



Detalle Marco
 Door frame detail
 Détail encadrement de porte



Detalle manilla
 Detail of handle
 Détail poignée

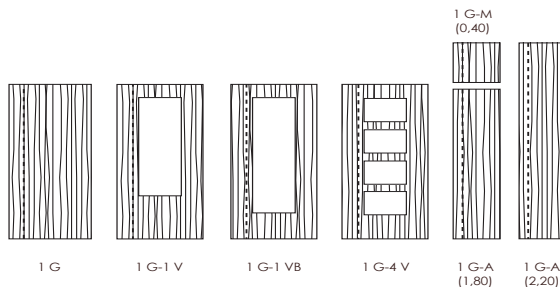

MOD. 1 G



MOD. 2 G



Detalle Marco
Door frame detail
Détail encadrement
de porte



Detalle manilla
Detail of handle
Détail poignée

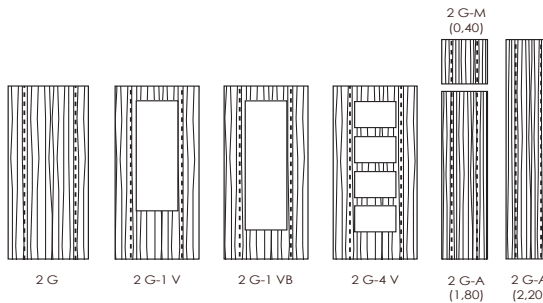



Detalle Marco
 Door frame detail
 Détail encadrement
 de porte



Detalle manilla
 Detail of handle
 Détail poignée

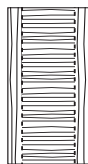

F 2 G

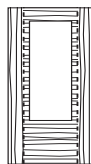

F 2 G-1 V

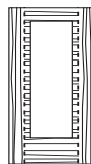

F 2 G-1 VB

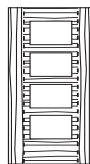

F 2 G-4 V

F 2 G-M
 (0,40)



F 2 G-A
 (1,80)



F 2 G-A
 (2,20)

MOD. F 2 G

Serie Ranurada

Colección Lisa

Descubre una colección en la que predominan las líneas rectas e innovadoras. Diseños acordes con las últimas tendencias de decoración. En esta serie la madera y el dibujo son los grandes protagonistas.

Discover a collection in which innovative straight lines are predominating. The designs follow the latest decor trends. In this series, the wood and the patterns play the leading role.

Découvrez une collection où prédominent les lignes droites et innovatrices. Leurs designs sont en accord avec les dernières tendances en décoration. Dans cette collection le bois et le dessin sont les grands protagonistes.





Detalle Marco
 Door frame detail
 Détail encadrement
 de porte



Detalle manilla
 Detail of handle
 Détail poignée

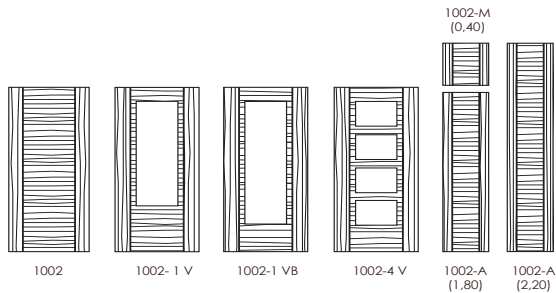

MOD. 1002



MOD. 1004



Detalle Marco
Door frame detail
Détail encadrement
de porte



Detalle manilla
Detail of handle
Détail poignée

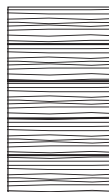

1004

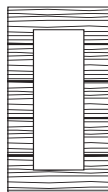

1004-1 V



1004-4 V

1004-M
(0,40)



1004-A
(1,80)



1004-A
(2,20)





Detalle Marco
 Door frame detail
 Détail encadrement
 de porte



Detalle manilla
 Detail of handle
 Détail poignée

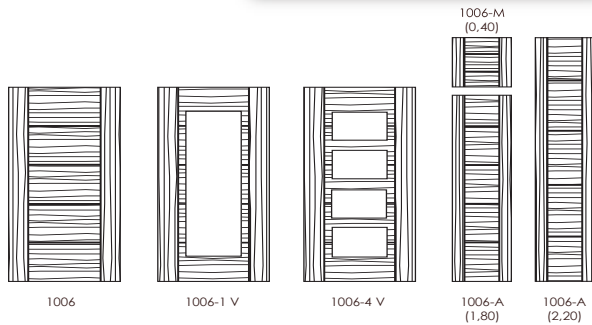

1006

1006-1 V

1006-4 V

1006-A
 (1,80)

1006-A
 (2,20)



MOD. 1006

CARACTERÍSTICAS

CHARACTERISTICS / CARACTÉRISTIQUES

Descubre la nueva Serie Ranurada de RUGASA, una colección en la que predominan las líneas rectas e innovadores diseños acordes con las últimas tendencias de decoración.

La serie ranurada permite crear toda serie de ambientes y adaptarse a los gustos de cualquier cliente gracias a la infinidad de modelos, combinaciones y acabados.

Todas las puertas pueden realizarse en dos tipos de composición:

- "Base interna vista en DM"
- "Base interna color crema"

Discover RUGASA'S new Grooved Serie, a collection in which straight lines and innovative design stand out in line with the latest decor trends.

The grooved series allows the creation of all kinds of atmospheres and can be adapted to the client's own taste thanks to the wide variety of models, combinations and finishes.

Two structure types are available for all doors:

- "DM structure"
- "Structure Internal color cream"

Découvrez la nouvelle Série Ranurada de RUGASA, une collection où prédominent les lignes droites et un design innovateur en accord avec les dernières tendances en décoration.

La série Ranurada permet de créer toute la série d'ambiances et s'adapte à tous les goûts grâce au nombre illimité de modèles, combinaisons et finitions qu'elle offre.

Toutes les portes peuvent être réalisées avec deux types de compositions:

- "Composition en DM"
- "Composition de couleur crème"



BASE INTERNA VISTA EN DM

Grooved serie : "Pico de Gorrión" detail DM appearance
 Ranurada série: "Pico de Gorrión" design DM détaillé

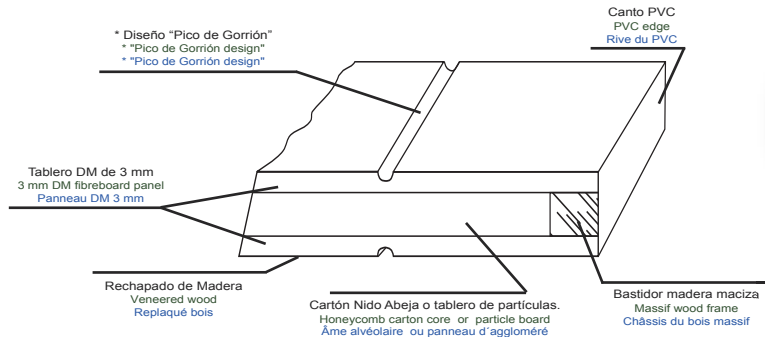

- * NOTA: Este modelo se suministrará con un barniz color crema recubriendo el "Pico de Gorrión".
- * NOTE: This model is supplied with cream-colored slip coating the "Pico de Gorrión".
- * NOTE: Ce modèle sera fourni avec un vernis couleur crème, qui recouvre le "Pico de Gorrion".

CANTOS DE PVC

PVC edge
 Rive du PVC

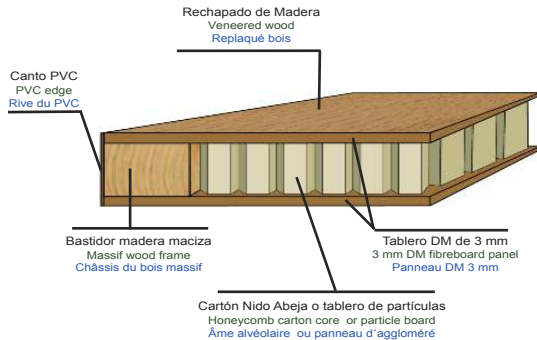

CANTOS DE PUERTAS

Doors's edges
 Rives des portes

CANTOS DE MADERA

Wood edge
 Rive du bois

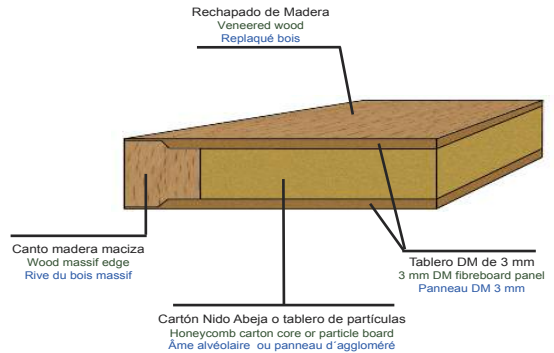

Serie Aluminio

Colección Lisa





Detalle Marco
 Door frame detail
 Détail encadrement
 de porte



Detalle manilla
 Detail of handle
 Détail poignée

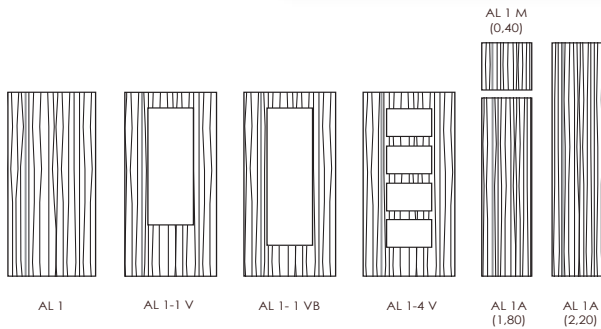

MOD. AL 1



MOD. AL 2



Detalle Marco
Door frame detail
Détail encadrement
de porte



Detalle manilla
Detail of handle
Détail poignée

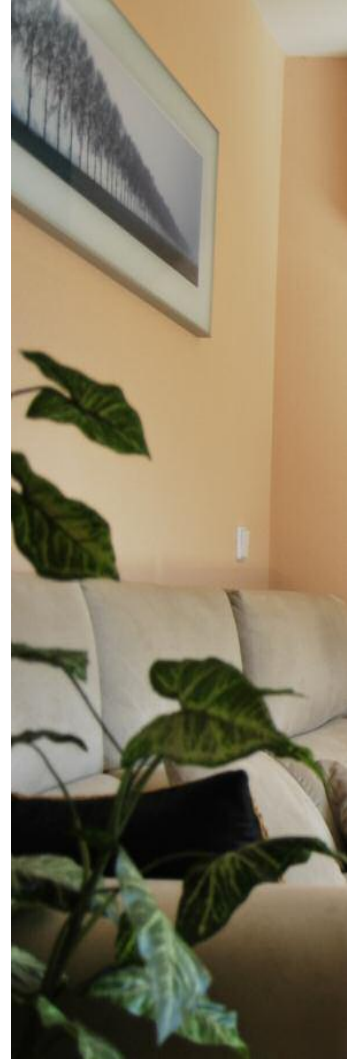
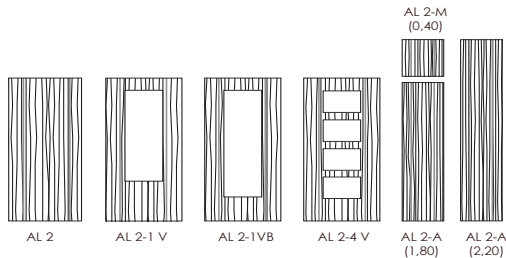



Detalle Marco
Door frame detail
Détail encadrement
de porte



Detalle manilla
Detail of handle
Détail poignée

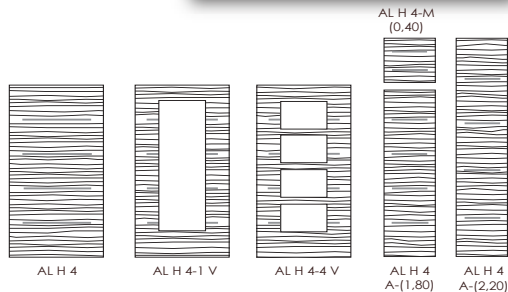

MOD. AL H 4

Serie Lacada

Colección Lisa

En esta colección se muestran líneas muy suaves que realzan la sencillez y luminosidad en la decoración de su hogar

This is a collection of soft lines that emphasises the simplicity and brightness of your home decor.

Cette collection nous montre des lignes très suaves où prédominent la simplicité et la luminosité pour décorer votre demeure.





Detalle Marco
Door frame detail
Détail encadrement
de porte



Detalle manilla
Detail of handle
Détail poignée

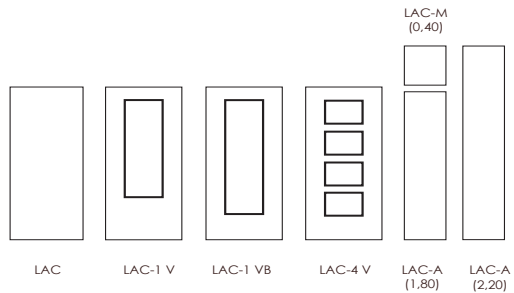

MOD. LAC



MOD. 1002 LAC



Detalle Marco
Door frame detail
Détail encadrement de porte



Detalle manilla
Detail of handle
Détail poignée

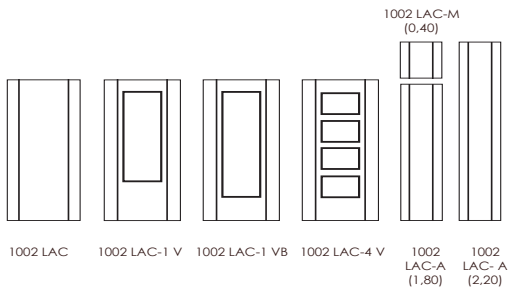



Detalle Marco
 Door frame detail
 Détail encadrement
 de porte



Detalle manilla
 Detail of handle
 Détail poignée

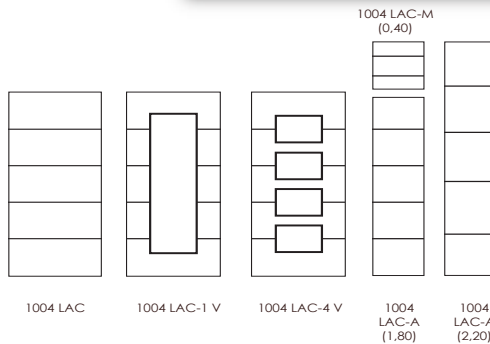

MOD. 1004 LAC



MOD. 1006 LAC



Detalle Marco
Door frame detail
Détail encadrement de porte



Detalle manilla
Detail of handle
Détail poignée

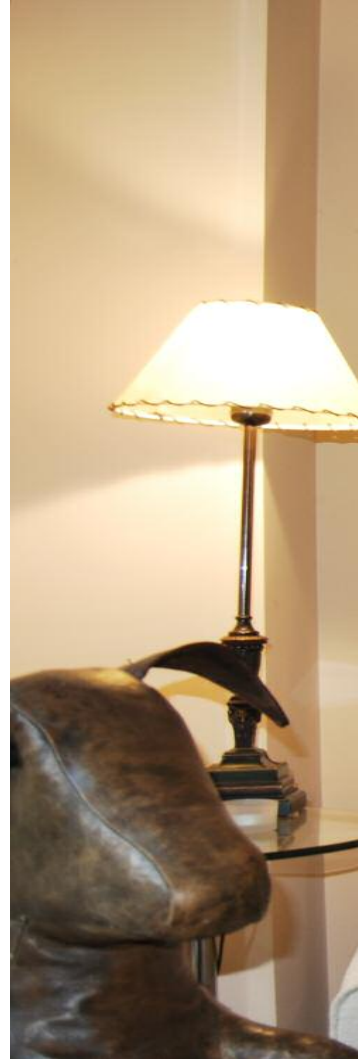
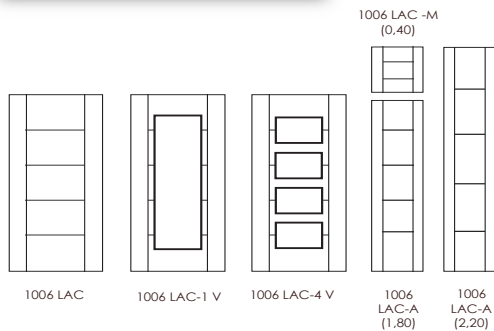

Colección Pantografiada



Descubre lo armonioso de esta serie que introduce delicadas curvas en el lacado transmitiéndonos un ambiente de elegancia y ligereza en su hogar.

Discover the harmony of this series that mixes delicate lacquered curved lines conveying an elegant and light atmosphere to your home.

Découvrez l'harmonie de cette série qui mêle les courbes délicates au laqué, offrant ainsi une ambiance élégante et légère.



Rugasa
RUFINO GARCÍA SÁNCHEZ, S.L.



MOD. PANT 2



Detalle Marco
Door frame detail
Détail encadrement
de porte



Detalle manilla
Detail of handle
Détail poignée

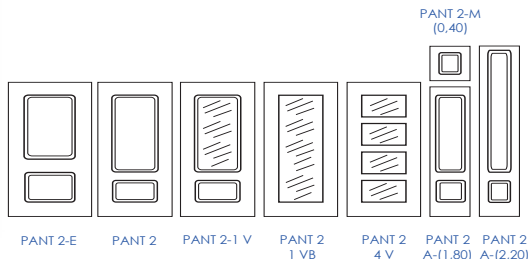

PANT 2-E PANT 2 PANT 2-1 V PANT 2 1 VB PANT 2 4 V PANT 2 A-(1,80) PANT 2 A-(2,20)

PANT 2-M
 (0,40)





Detalle Marco
Door frame detail
Détail encadrement
de porte



Detalle manilla
Detail of handle
Détail poignée

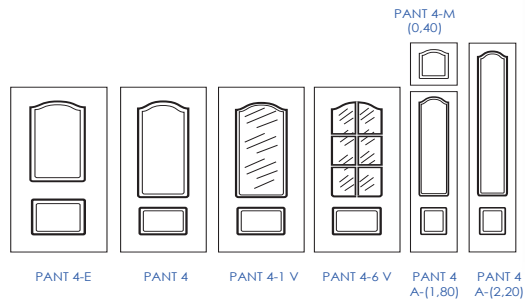

MOD. PANT 4



MOD. PANT 5



Detalle Marco
Door frame detail
Détail encadrement
de porte



Detalle manilla
Detail of handle
Détail poignée

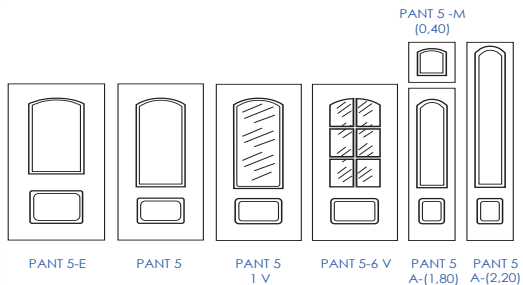



Block





Rugasa

RUTINO GARCÍA SÁNCHEZ, S.L.



El Block es un conjunto formado por la hoja de puerta barnizada y ya montada al batiente, con sus herrajes correspondientes. Con el block se pretende dar una solución rápida a la instalación de puertas.

No necesita ninguna preparación mecánica, sólo es preciso sacarlo de su embalaje y presentarlo de manera rápida y sencilla al premarco, ajustarlo mediante cuñas y comprobar la libre apertura de la hoja, posteriormente fijarlo con la tornillería suministrada.

Block



Rugasa

RUFINO GARCÍA SÁNCHEZ, S.L.



The Block is a set, intending to provide a fast solution to door installations. It consists of a varnished side hung door leaf that comes with the appropriate hardware. This solution provides a fast and simple installation on the sub-frame.

No mechanical preparation is required, you only need to unpack it, put it onto the sub-frame, fit it using wedges, check that the leaf opens freely and finally fix it with the screws provided.

Le Block est un ensemble, avec lequel il est possible d'apporter une solution rapide à l'installation de portes. Il est formé de la feuille de porte montée au battant avec les ferrures correspondantes et vernis, ce qui permet une installation au pré-encadrement existant plus rapide et simple.

Aucune préparation mécanique n'est nécessaire; il faut seulement ôter l'emballage et le présenter au pré-encadrement, l'ajuster à l'aide de cales et vérifier la libre ouverture de la feuille et le fixer par la suite avec les vis fournies.

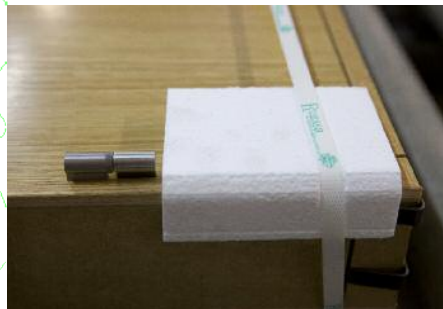

Perfiles y Medidas



Cross sections and Measures

MEDIDAS ESTÁNDAR

Estándar measures
Mesures standard

Panneau et Mesures

CLASE Type - Type	ALTO Height - Hauteur	ANCHO Width - Largeur	GRUESO Thickness - Épaisseur
Entrada Main entrance door Porte d'entrée	203 - 211	82,5 - 92,5	40 - 45 mm
Blindada Reinforced door Porte blindée	203 - 211	82,5 - 92,5	40 - 45 mm
Paso Passage door Porte de passage	203 - 211	62,5 - 72,5 - 82,5	35 mm
Fijo Fixe leaf Double porte	203 - 211	42,5	35 mm
Armario Enterizo One piece Wardrobedoor Armoire avec Feuilles lisses entières	220	40 - 50 - 60	16 -19 - 30 mm
Armario Wardrobe Without superior Wardrobe Armoire sans casier à valises	180	40 - 50 - 60	16 -19 - 30 mm
Maletero Superior wardrobe Portes de casier à valises	40	40 - 50 - 60	16 -19 - 30 mm

PERFILES - Tablero Liso

Cross section- Flush door leaf / Feuille lisse

ENTRADA

Main entrance door / Porte d'entrée



Entrada Blindada

Reinforced main entrance door
Porte d'entrée blindée

PASO

Passage door / Porte de passage



Paso Maciza

Massif passage door
Porte de passage massive

ARMARIOS

Wardrobes / Armoires



Armario Maciza

Massif wardrobe
Armoire massif



Entrada Maciza

Massif entrance door
Porte d'entrée massive

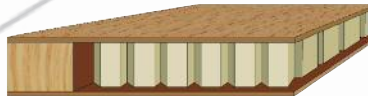

Paso Alveolar

Honeycomb structure passage door
Porte de passage alvéolaire



Armario Alveolar

Honeycomb structure wardrobe
Armoire alvéolaire

PANTOGRAFIADA

Graphic design door / Porte pantographié

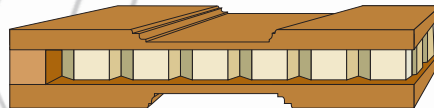

35 mm

Maderas

Woods Bois



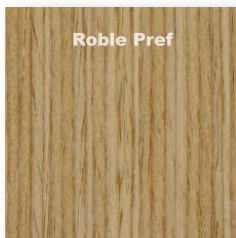

Pref Oak / Chêne Pref



Wenge / Wengue



**Steamed Beech /
Hêtre Vaporisé**

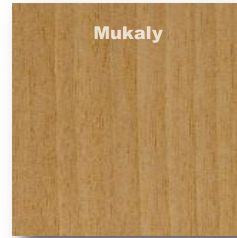

Mukaly / Mukaly



Cherry / Merisier



**Eastern black walnut
Noyer américain**



Maple / Erable



Country pine / Pin Pays



Oak / Chêne



**Sapelly Rameado
Sapelly Rameado**

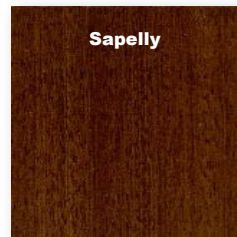

Sapelly / Sapelly

Sellos de calidad

Quality certifications *Certifications de qualité*

La calidad es un factor de supervivencia en un mercado tan competitivo y globalizado, por este motivo RUGASA, S.L. tiene su propio departamento de calidad.

Con exhaustivos controles que engloban desde las materias primas hasta los ensayos del producto final.

RUGASA, S.L. certifica la calidad de su fabricación mediante la norma ISO 9001:2000, por la cual quedan aseguradas las características de toda nuestra producción.

Como consecuencia de los sucesivos cambios normativos RUGASA, S.L. desarrolla los productos aplicando tecnologías de última generación con lo que nos permite satisfacer las necesidades de nuestros clientes.

Así mismo RUGASA, S.L. tiene el certificado de producto de "puerta plana alveolar", "puerta plana maciza" y "puerta carpintera" entre otros, con el sello de calidad AITIM.

Quality is a very important factor in the survival of a company in our highly competitive and globalised market, for that reason RUGASA, S.L. has its own Quality Department.

The thorough quality controls involved range from the raw materials to the testing of the final product.

RUGASA, S.L. certifies that the quality of the manufacturing complies with the regulation ISO 9001:2000, ensuring the properties of all our products.

As a result of the subsequent changes to the regulations, RUGASA, S.L. all our products are developed applying state-of-the-art technology, in order to fulfil all of our clients needs.

Moreover RUGASA, S.L. has the product certification for the "flush door with honeycomb structure", "solid structure flush door" and "carpentry door" amongst others, with AITIM's Quality seal.

La qualité est un facteur de survie dans un marché si compétitif et globalisé. Raison pour laquelle RUGASA, S.L. s'est dotée de son propre service qualité.

RUGASA, S.L. réalise des contrôles rigoureux de tous les processus de fabrication : des matières premières jusqu'aux essais de produits finis.

RUGASA, S.L. s'est vu décerner la qualification ISO 9001 : 2000, et, par conséquent, garantie la qualité de fabrication de ses produits ainsi que les caractéristiques de sa production.

Suite aux changements normatifs successifs, RUGASA, S.L. développe ses produits en appliquant les technologies de dernière génération, ce qui nous permet de satisfaire les besoins de nos clients.

D'autre part, RUGASA S.L. a obtenu le certificat de produit " porte plate alvéolaire ", " porte plate en bois massif " et " porte menuiserie " entre autres, avec le label de qualité AITIM.

NOTA: La Empresa se reserva el derecho de modificar sin previo aviso sus modelos y características.

NOTE: The Company reserves the right to modify its models and their characteristics without any previous warning

NOTE: L'Entreprise se réserve le droit de modifier sans préavis ses modèles et caractéristiques.



ISO 9001
BUREAU VERITAS
Certification





Rugasa

RUFINO GARCÍA SÁNCHEZ, S.L.