

LED PARKING GARAGE LIGHT INSTRUCTION

Caution:

1. Can not use the electric generator to test the LED lamp.
2. Please abide by related country, regional and local law and regulations when install this fixture.
3. Please turn off the power before installation or maintenance.
4. Proper earth grounding is required to ensure safety.

Note:

1. To avoid possibility of electrical shock or fire, the installation personnel must have professional electric knowledge.
2. Please wear gloves to avoid injury before installation.
3. If any smoke or spark of the wire happened, please turn off the power immediately and notify relevant personnel.

Attention:

1. Please check if there is any damage during shipping. If so, please contact manufacturer timely.
2. Please read the installation instruction carefully to check whether all the accessories are complete. After confirmation, then install the fixture according to installation steps.

Wiring Diagram

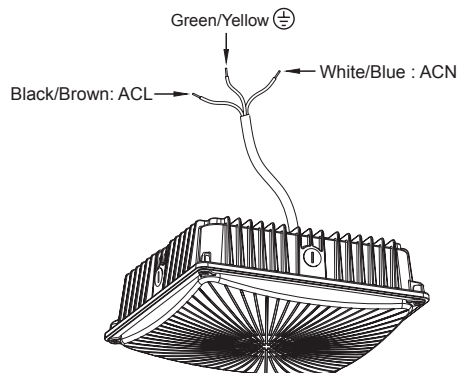

Installation Method I :

1. Connect the wiring to the local power supply in the 3/4"NPT Stem (Figure 1).

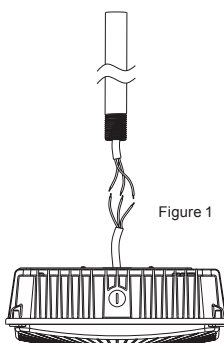

2. Screw the fixture to the 3/4"NPT Stem (Figure 2).

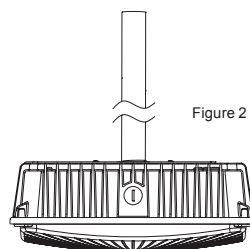

Installation Method II :

1. Take off the plate of the led fixture (Figure 3).

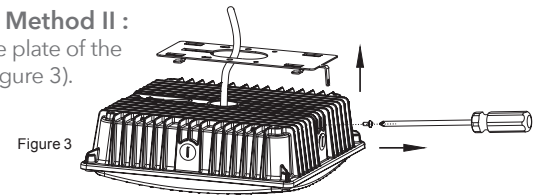

2. Drill the holes on the ceiling accordingly to fit the plate (Figure 4).

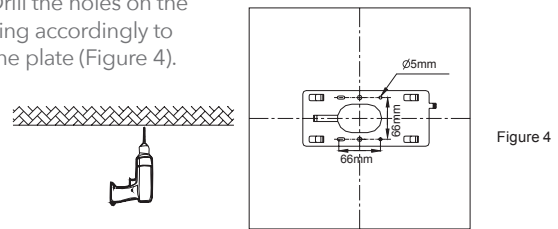

3. Drill the rubber plug into the ceiling, then fix the plate to the ceiling. (Figure 5).

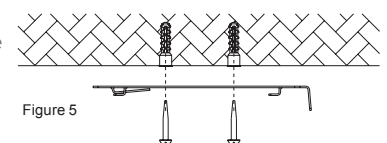

4. Hang the fixture by the plate (figure 6), then connect to local power supply with necessary wiring protection .

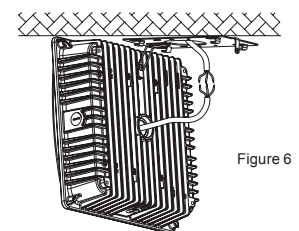

5. Install the fixture by the plate, then fasten the screws on both sides of the fixture (Figure 7) .

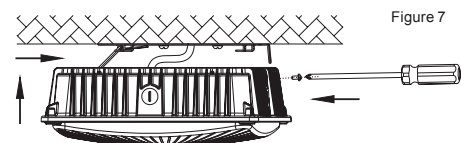

Warning/Avertissement:

MIN 75°C SUPPLY CONDUCTOR

THIS PRODUCT MUST BE INSTALLED IN ACCORDANCE WITH THE APPLICABLE INSTALLATION CODE BY A PERSON FAMILIAR WITH THE CONSTRUCTION AND OPERATION OF THE PRODUCT AND THE HAZARDS INVOLVED

LES FILS D'ALIMENTATION 75°C MIN

CE PRODUIT DOIT ÊTRE INSTALLÉ SELON LE CODE D'INSTALLATION PERTINENT, PAR UNE PERSONNE QUI CONNAÎT BIEN LE PRODUIT ET SON FONCTIONNEMENT AINSI QUE LES RISQUES INHÉRENTS.

LED PARKING GARAGE LIGHT INSTRUCTION

Caution:

1. Can not use the electric generator to test the LED lamp.
2. Please abide by related country, regional and local law and regulations when install this fixture.
3. Please turn off the power before installation or maintenance.
4. Proper earth grounding is required to ensure safety.

Note:

1. To avoid possibility of electrical shock or fire, the installation personnel must have professional electric knowledge.
2. Please wear gloves to avoid injury before installation.
3. If any smoke or spark of the wire happened, please turn off the power immediately and notify relevant personnel.

Attention:

1. Please check if there is any damage during shipping. If so, please contact manufacturer timely.
2. Please read the installation instruction carefully to check whether all the accessories are complete. After confirmation, then install the fixture according to installation steps.

Wiring Diagram

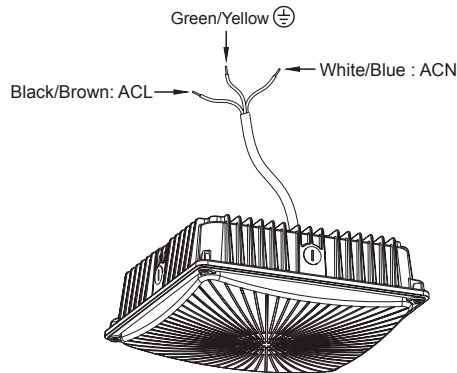

Installation Steps:

1. Take off the mounting bracket with screwdriver (one screw off is enough). See picture 1.

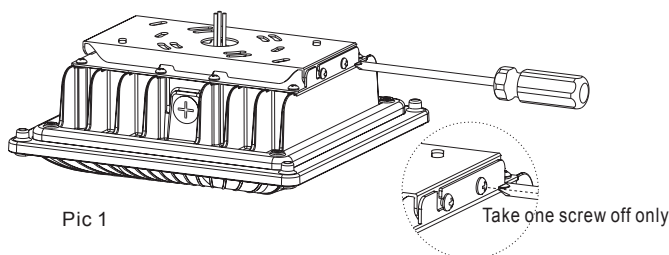

2. Drill holes on the ceiling as per the size of holes on brackets. See picture 2.

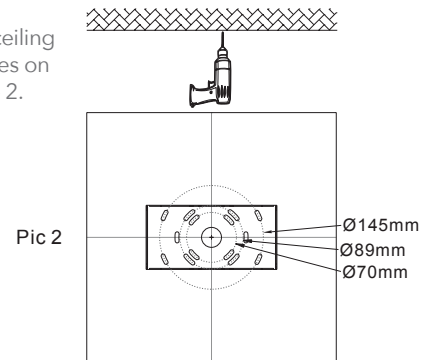

3. Put the rubber plug into the ceiling and fix the mounting bracket; Hang the fixture on the mounting bracket; Wire correctly and make sure it's insulated. See picture 3.

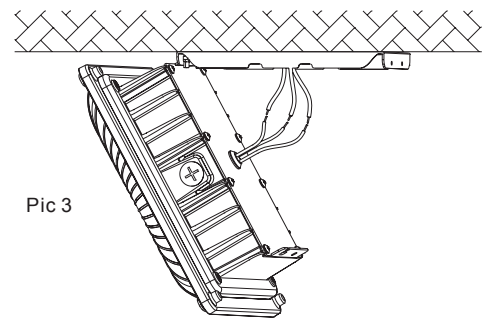

4. Buckle the fixture completely on the mounting bracket; Fix side screws of bracket on the fixture. See picture 4.

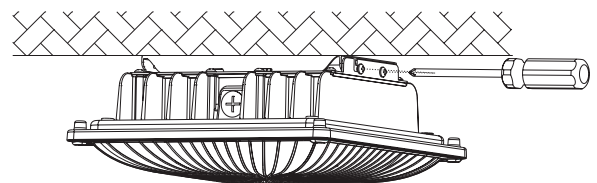

Warning/Avertissement:

MIN 75°C SUPPLY CONDUCTOR
 THIS PRODUCT MUST BE INSTALLED IN ACCORDANCE WITH THE APPLICABLE INSTALLATION CODE BY A PERSON FAMILIAR WITH THE CONSTRUCTION AND OPERATION OF THE PRODUCT AND THE HAZARDS INVOLVED

LES FILS D'ALIMENTATION 75°C MIN
 CE PRODUIT DOIT ÊTRE INSTALLÉ SELON LE CODE D'INSTALLATION PERTINENT, PAR UNE PERSONNE QUI CONNAÎT BIEN LE PRODUIT ET SON FONCTIONNEMENT AINSI QUE LES RISQUES INHÉRENTS.