

DEVIATE

cycles



User Manual:

highlander II

2023

TABLE OF CONTENTS

SAFETY INSTRUCTIONS	3
Bicycle Safety	3
Usage	3
Environmental	3
Protective Equipment	3
Suspension	4
Pre-ride Checks.	4
Entrapment	4
Luggage and Child Seats or Carrier	4
Permissible Weight	4
Public Roads	4
ASSEMBLY	5
Parts Specific Standards	5
Seat Post Dropper Cable	5
Top Tube Cable Guides	5
Shock Fitment	6
Bottom Bracket Washer	6
MAINTENANCE	6
Service Intervals	6
Bolt Torque Summary	7
PARTS LIST	7
Quick Reference Spares	7
DIAGRAMS	8
Front Triangle - Diagram	8
Front Triangle - Parts Table	9
Rear Triangle - Diagram	10
Rear Triangle - Parts Table	11
Rocker Diagram	12
Rocker Parts Table	13
WARRANTY	14
Warranty Exclusions	14-15
Functioning of Warranty	15

SAFETY INSTRUCTIONS

WARNING

BICYCLE SAFETY

As with all mechanical components, the bicycle is subjected to wear and high stresses. Different materials and components might react to wear or stress fatigue in different ways. If the design life of a component has been exceeded, it may suddenly fail, possibly causing injuries or death to the rider. Any form of crack, scratches, or change of colouring in highly stressed areas indicate that the life of the component has been reached and it should be replaced. Additionally, after a crash or impact even without visible damage – affected components should be replaced or a professional opinion should be sought.

For composite components for example the frame, impact damage is often invisible to the user. In the event of any impact you should stop using the bicycle immediately and return affected components to the manufacturer for inspection. Failure to do so may result in catastrophic failure and injury or death.

USAGE

This product is intended for off road use on trails and tracks. **It is not designed for use on Downhill racing and tracks.** The use of this product in downhill bike parks including jumps or drops is not recommended. The use of any bicycle on or off-road, even the best circumstances, is dangerous and may result in injury or death. Correct set-up and maintenance is your responsibility and helps reduce the risk of injury, death, or damage to your bicycle.

ENVIRONMENTAL

High or low temperature exposure may result in damage to components. The safe operating temperature is between -10°C and +50°C.

PROTECTIVE EQUIPMENT

The use of a bicycle helmet and gloves are recommended as well as other protective gear appropriate to the terrain – for example knee guards, elbow guards or a spine protector.

SAFETY INSTRUCTIONS (CONTINUED)

SUSPENSION

Suspension set-up and adjustment should be carried out according to the manufactures recommendations. Please refer to the suspension manufacturers product instructions.

PRE-RIDE CHECKS

All bolts and fasteners should be checked before according to the recommendations in the Maintenance section of this manual or the manufactures recommendations. Brake function and tyre pressure, wheel fitment and the functioning of the suspension should be checked before every ride. Additionally, normal functioning of pedals and drivetrain should be checked.

ENTRAPMENT

There is a risk of trapping body parts during maintenance and normal use. Care should be taken when maintaining moving parts and appropriate protective equipment should be worn. During normal use care should be taken to prevent loose clothing catching in the moving parts.

LUGGAGE AND CHILD SEATS OR CARRIER

The bicycle is not suitable for the fitment of any luggage carrying device or any child seat or carrier.

PERMISSIBLE WEIGHT

The total permissible weight of a rider including gear is 120kg.

PUBLIC ROADS

If used on public roads it is your responsibility to ensure your bike is legal and roadworthy

ASSEMBLY

PARTS SPECIFIC STANDARDS

Interface	Specification
Fork Compatibility	29" 160mm 44/42mm offset
Bottom Bracket	73mm BSA Threaded
Headset	ZS44/ ZS44/28.6 upper and a ZS56/40 lower headset cup
Chainline	52mm (any deviation from this will cause increased idler wear)
Chain Length	126 links (widely available, no need to join chains)
Max Chainring Size	36t round (oval chainrings may fit depending on design but check for interference before riding)
Shock Size	Metric 210*55mm (coil or air)
Shock Hardware	Front: 40*8mm Rear: Eyelet bushing
Shock Average Leverage Ratio	2.54 mm/mm
Brake Mount	Post Mount 180mm (Max 203mm Disc Size Rear)
Seatpost Compatibility	Internal dropper routing with internal cable routing. 34.9mm, Minimum Insertion Depth: 150mm. Maximum Insertion Depth: Medium:- 300mm, Large:- 330mm, XL:- 360mm
Seat Collar	38.5mm (supplied with frame)
Max Tyre Size	2.8"

Deviante Cycles recommends this bike is assembled by a competent bike mechanic.

SEAT POST DROPPER CABLE

Scan below for video guidance



TOP TUBE CABLE GUIDES

There are a number of cable clamps along the length of the top tube. These provide clamping for the cables, but also serve as tool fixing points, Di2 or additional bottle mounting.

BOTTOM BRACKET WASHER

Provided in the box is a BB washer (part number 14 on Front Triangle Assembly). Please ensure this is fitted when installing the BB between the frame and BB. It replaces the 2.5mm spacer found with BB's to achieve a 52mm chainline. Additional spacers may be required for certain BB's.

MAINTENANCE

SERVICE INTERVALS

Action	Every Ride	50hrs	Notes
Clean/Lube Train	•		Not wax chain lubricants
Check Tyre Pressures	•		
Clean Mud/Debris	•		
Check Brake Function	•		
Clean Stanchions	•		
Check Brake Pad Wear	•		
Check Shock Pressure	•		See manufacturer guidelines (25-30% sag)
Check For Loose Bolts	•		Refer to diagrams on page (xxx)
Lube Grease Ports		•	See diagrams for port locations (Pages 10, 12)
Check Tyre Wear		•	
Check Spoke Tension		•	
Check Drivetrain Wear		•	Replace chain before 0.75% wear
Check Bearing Wear		•	Check for play in pivots and idler
Rebuild Linkages			As Required
Fork Service			Refer to fork manufacturers recommendations
Shock Service			Refer to shock manufacturers recommendations

GREASE PORTS

After locating the grease ports (see diagrams on pages 10 & 12) use a Deviate Cycles Dualco grease gun to insert Peaty's speed grease into the specified port. Ensure any excess grease is cleaned and removed prior to using the bike.

BOLT TORQUE SUMMARY

Part	Torque (Nm)
Main Pivot Bolt	30
Pull Link to Rocker Bolt	30
Pull Link to Rear Triangle Bolt	20
Shock Extender to Rocker Bolt	20
Sleeve - Shock	20
Sleeve - Frame Bolt	10
Rear Axle	10
Idler Cover Bolts	2
Drop Out Bolts	2
Bottle Cage Bolts	3

If a bolt is found to be loose it should be removed and the relevant thread locktite should be applied as detailed in the product diagrams on pages 8, 10, 12.

PARTS LIST

QUICK REFERENCE SPARES

The following table is a quick reference for typical spares you might need over the life of the bike:

Part	Part Number	Quantity Per Frame
Dropout	TRP04-D9-008-C	1
Rear Axle	TRP04-S9-022-A	1
Idler	TRP04-D9-006-D	1
Idler Bearings	61803_2RS1	2
Main Pivot, Rear Links, Extender Bearing	3802 LLU MAX	7
Rocker Bearing	6808 LLU MAX	2
Idler Seals, Main Pivot Seals	SEAL - 20x26x4 VC	10
Rear Triangle Inner Seal	SEAL - 16x22x4 VC	2
Cable Grommet (Large)	G10 RCS60-00-45	2
Cable Grommet (Small)	G10 RCS50-00-35	3

Deviat Cycles can happily supply any spares that you may need for your bike, but some items such as bearings and seals can be sourced from you local bearing dealer.

For all other frame related spares please contact us or check the online store. The use of non-genuine parts is not recommended and would void the warranty associated with Deviate products.

FRONT TRIANGLE ASSEMBLY - DIAGRAM

View page 9 to see the corresponding parts table.

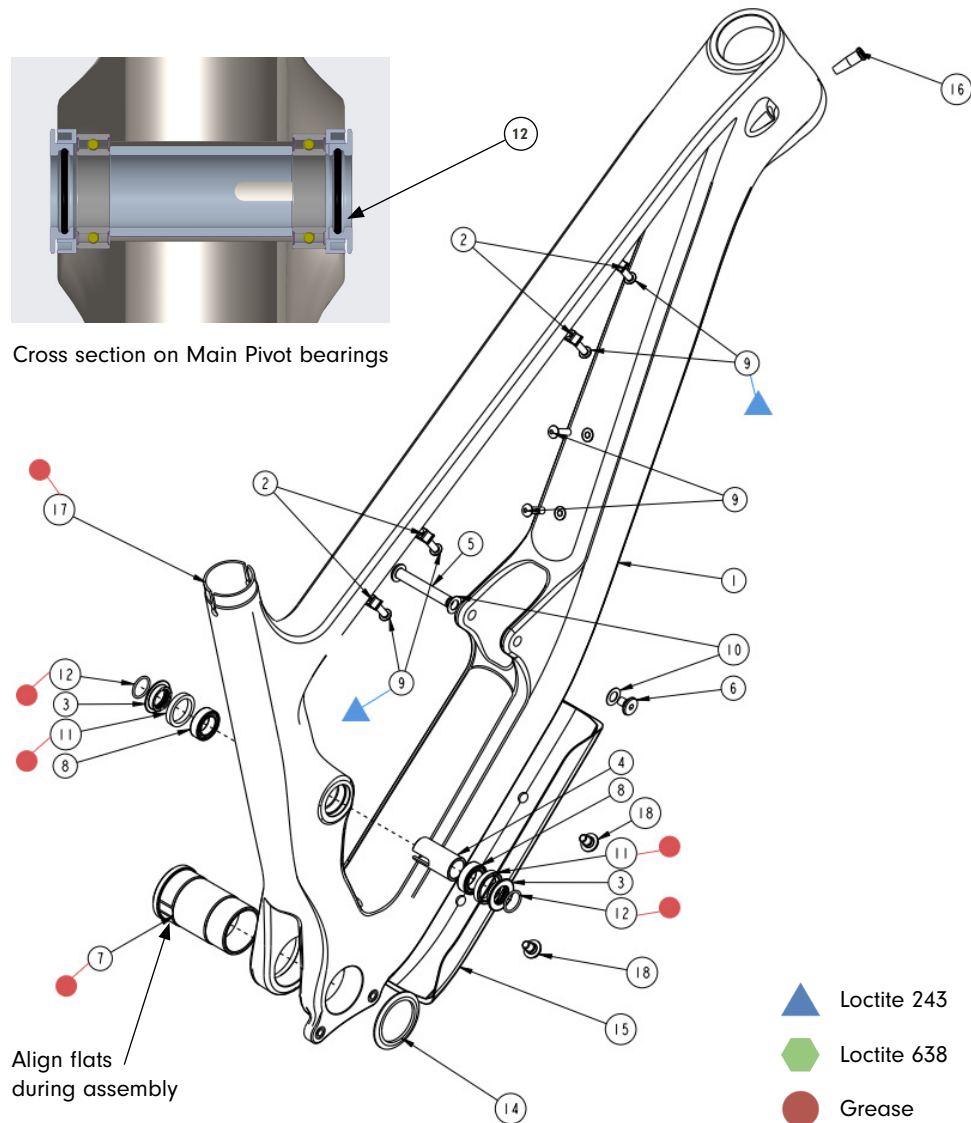

FRONT TRIANGLE ASSEMBLY - PARTS TABLE

View page 8 to see the corresponding diagram.

Item	Part Number	Name	Notes	QTY
1	TRP08-F9-XXX	Frame - Carbon		1
2	TRP04-F9-010-B	Clamp - Cable Gutter		4
3	TRP04-F9-011-B	Top Hat - Pivot		4
4	TRP04-S9-035-C	Spacer Tube - Main Pivot		1
5	AMP06-F9-013-A	Sleeve - Frame Bolt		1
6	TRP04-F9-017-A	Bolt - Sleeve Frame		1
7	TRP04-F9-015-C	Axle - Bottom Bracket		1
8	3802LLUMAX	Enduro Bearing		2
9	BTN_HEAD_M5x18	BUTTON HEAD - M5x18 - SS A2/A4	Torque to 4.5 Nm	4
10	WASHER DIN988 8x14x0.5	Washer - DIN988	8x14x0.5	2
11	SEAL_20x26x4_VC	SEAL - 20x26x4 VC - NITRILE	Apply grease to lips	2
12	O-RING_15x1_5	O-RING - 15x1.5mm - NITRILE	Prepare with grease	2
13	/	/	Not shown	/
14	TRP04-F9-024	Washer - BB	Replaces 2.5mm spacer with BB	1
15	TRP08-F9-007-A	Protection - Downtube		1
16	G10_RCS50-00-35	Grommet (Small)		1
17	CL-FJ21-1	Deviate Seat Clamp	Apply grease prior to seat post installation	1
18	WAFER_HEAD_M6x16	WAFER HEAD M6x16		2

REAR TRIANGLE ASSEMBLY - DIAGRAM

View page **11** to see the corresponding parts table.

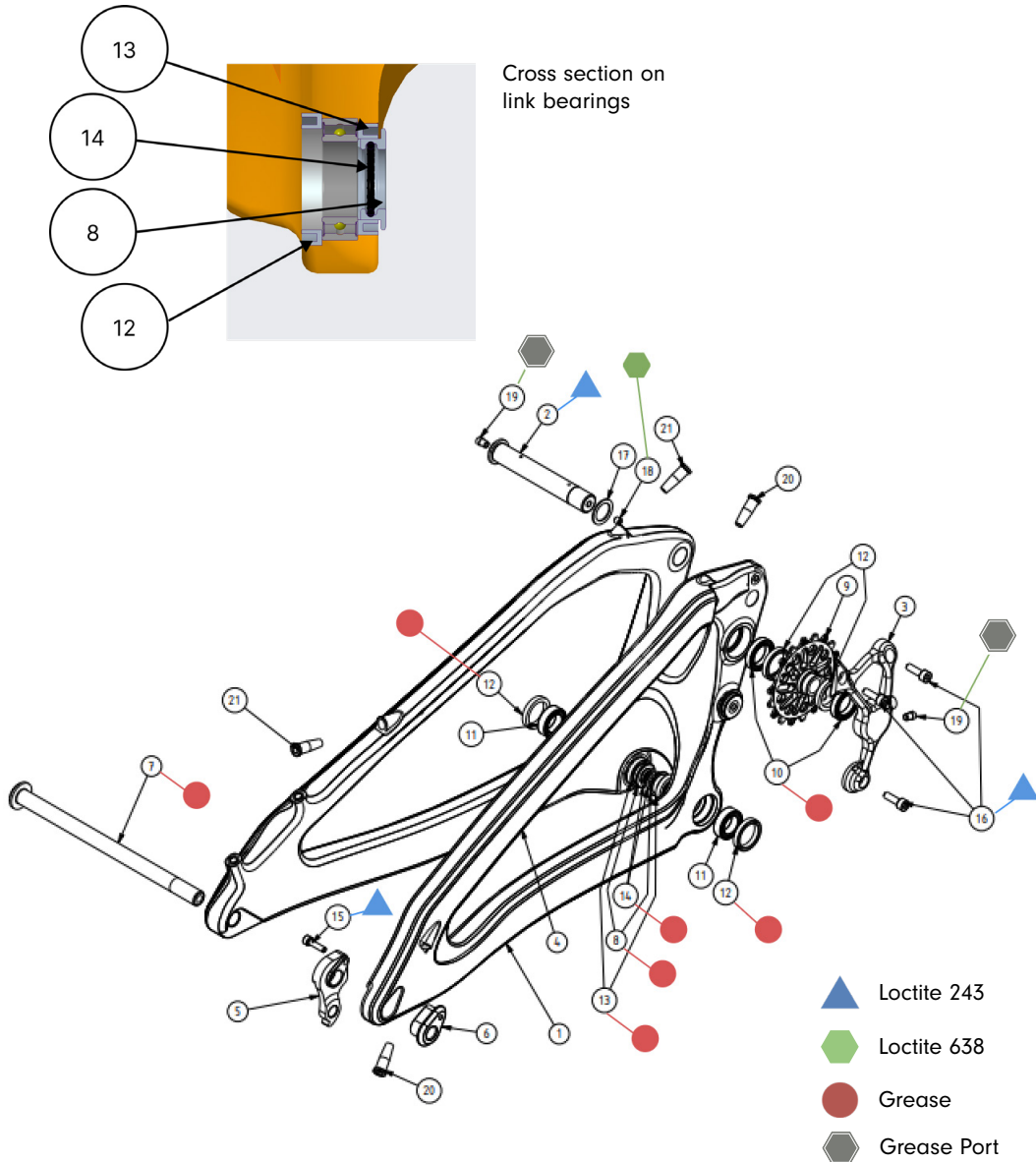

REAR TRIANGLE ASSEMBLY - PARTS TABLE





View page **10** to see the corresponding diagram.

Item	Part Number	Name	Notes	QTY
1	TRP08-S9-XXX	Rear Swing Arm		1
2	TRP04-S9-029-F	Axle - Main Pivot	Loctite Threads w/243	1
3	TRP04-D9-007-J	52mm Idler Cover	55mm Idler Cover = AMP06-D9-011-A	1
4	TRP04-S9-063-B	Chain stay protector		1
5	TRP04-D9-008-C	Drop Out - 12x148	UDH Hanger = 411H0300001	1
6	TRP04-D9-009-B	Insert - Rear Axle		1
7	TRP04-S9-022-A	Rear Axle 148x12	UDH Axle = 411L12B2000003	1
8	AMP06-F9-020	Top Hat - Pivot Small	Fit o-ring 12x1.5 w/grease	2
9	TRP04-D9-006-D	52mm Idler - 18T	55mm Idler = AMP06-D9-012-B	1
10	61803_2RS1	BEARING - 61803 2RS		2
11	3802LLUMAX	ENDURO BEARING 3802 LLU MAX		2
12	SEAL_20x26x4_VC	SEAL - 20x26x4 VC - NITRILE	Prepare with grease	4
13	SEAL_16x22x4_VC	SEAL - 16x22x4 VC - NITRILE		2
14	O-RING_12x1_5	O-RING - 12x1.5MM - NITRILE	Replaces 2.5mm spacer with BB	2
15	CAP_M4x16	CAP HEAD - M4x18 - SS A2/A4	Torque to 2 Nm	1
16	CAP_M5x16	CAP HEAD - M5x16 - SS A2/A4	Loctite 243, Torque 2Nm	3
17	WASHER_DIN988_15x21x1	WASHER - DIN988 - 15x21x1 - SS		1
18	GRUB_SCREW-M5x5	GRUB SCREW - M5x5 - SS A2/A4	Loctite Threads w/243	1
19	ZERKS_FITTING	10-32 UNF Flush Straight Slotted	Loctite Threads w/638	2
20	G10_RCS50-00-35	Grommet (Large)		2
21	G10_RCS60-00-45	Grommet (Small)		2

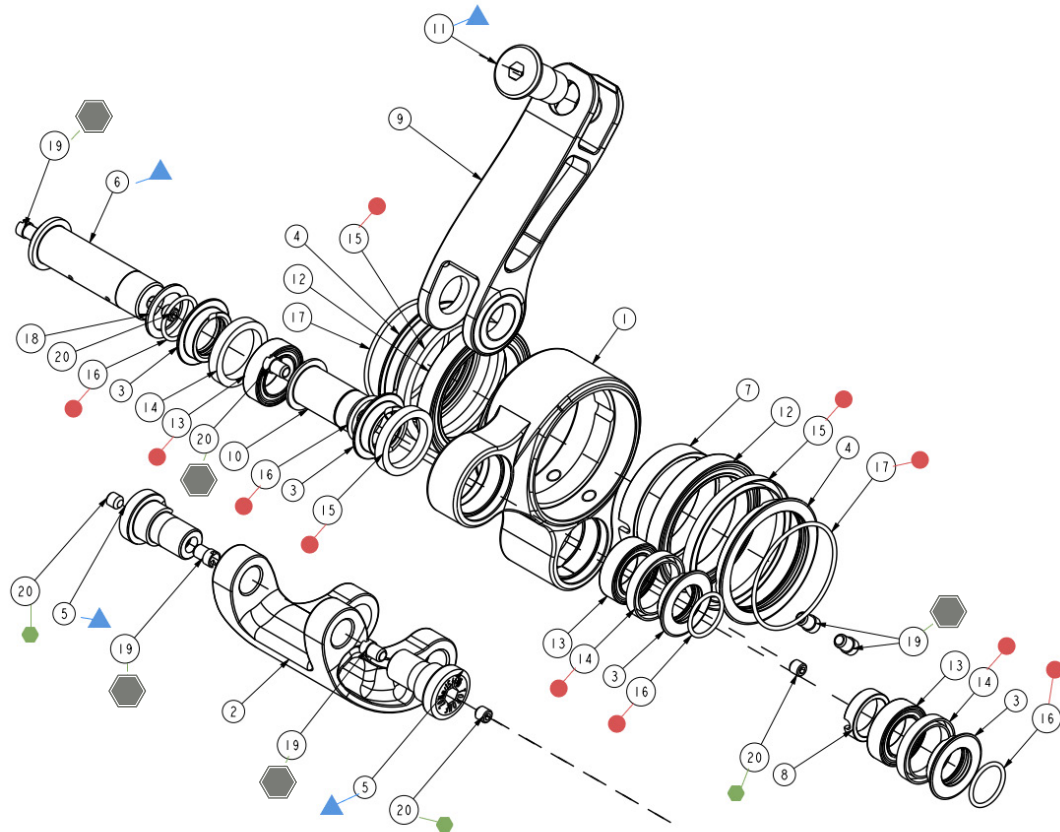
ROCKER - DIAGRAM

View page **13** to see the corresponding parts table.



-  Loctite 243
-  Loctite 638
-  Grease
-  Grease Port

ROCKER - PARTS TABLE

View page **12** to see the corresponding diagram.

Item	Part Number	Name	Notes	QTY
1	TRP08-S9-002	Rocker - 145mm		1
2	TRP08-S9-004	Link - 145mm		1
3	TRP04-F9-011-B	Top Hat - Pivot		4
4	TRP04-F9-013-B	Top Hat - BB		2
5	TRP04-S9-045-D	Axle Bolt - Swingarm Link	Tighten to 20Nm	2
6	TRP04-S9-030-F	Axle - Swing Arm Link	Tighten to 30Nm	1
7	TRP04-S9-036-C	Spacer Tube - BB		1
8	TRP04-S9-037-C	Spacer Tube Rocker		1
9	TRP08-S9-003	Shock Extender - 145mm		1
10	TRP04-S9-046-A	Sleeve - Extender	Tighten to 12Nm	1
11	TRP04-S9-049-B	Sleeve - Shock	Fitted for transport	1
12	6808LLUMAX	Enduro Bearing 6808 LLU MAX		2
13	3802LLUMAX	Enduro Bearing 3802 LLU MAX		3
14	SEAL_20x26x4	Seal - 20x26x4 VC	Apply grease to lips	4
15	SEAL_45x52x4	Seal - 45x52x4 VC	Apply grease to lips	2
16	O-RING_15x1.5	O-RING - 15x1.5MM - NITRILE	Prepare w/grease	4
17	O-RING_40x1.5	O-RING - 40x1.5MM - NITRILE	Prepare w/grease	2
18	WASHER_DIN988_15x21x1	WASHER - DIN988 - 15x21x1 -SS		1
19	ZERKS FITTING	10-32 UNF Flush Straight Slotted		6
20	GRUB_M5X5	GRUB SCREW - M5x5 - SS A2/A4		4

WARRANTY

All of Deviate Cycles frames come with a lifetime warranty. This warranty comes with some important conditions.

We want you to have peace of mind when purchasing a Deviate. We produce high end carbon frames and stand behind our product 100% with a lifetime warranty. Saying that, in return we expect you to maintain your frame and not use it beyond it's intended limits.

If our analysis (or your honesty) suggests abnormal loading, for example due to casing downhill style jumps on a trail bike - then our crash damage replacement policy will apply. Our engineering team have extensive experience with carbon fibre failure analysis so their decision is final.

The following conditions apply to the lifetime warranty:

- Lifetime Warranty is only valid for manufacturing defects.
- Applies to frame-set and machined parts.
- Valid for intended and appropriate use only.
- Warranty only applies to the original owner with proof of purchase.
- Does not include any work associated with warranty process (i.e. stripping down or re-building a replaced frame).
- Does not include import tax or duty when shipping outside the UK.
- If a replacement is required we will endeavour to replace like for like - but if this is not possible we may offer an alternative.
- Subject to exclusions (see page 14).

WARRANTY EXCLUSIONS

- Wear and tear.
- Paintwork. 2 year warranty applies to paintwork manufacturing defects. Custom painting voids the frame warranty except where carried out by an authorised paint-shop or where written authorisation is obtained from us. Where an authorised paint-shop is used, we take no liability for this work and will be not liable for any costs incurred due to a separate warranty claim, for example where re-painting may be required due to a replacement part.
- Where clear protection is applied, this voids any warranty we supply on the paintwork including any damage to the existing paint occurring during removal or fitting.
- Cable rub and other friction damage.
- Bearings and other "wear parts" i.e. the idler wheel and seals.
- Damage occurring due to insufficient maintenance or poor treatment. Refer to the manual for maintenance instructions.

- The fitment of incompatible parts voids the warranty. For the avoidance of doubt, forks beyond the travel range quoted for a frame are deemed incompatible, as are wheel sized that are not quoted for the frame or 3rd party linkages.
- Damage occurring due to the seizing of bolts or components due to insufficient maintenance or over-tightening. To be clear if lack of maintenance causes the linkage or bearings to seize and this results in damage to the frame, this is not covered.
- Damage occurring as a result of over-torquing, cross threading or other mis-fitting of components. Refer to manual for tightening torques.
- Damage occurring due to impact damage of any description.
- Damage occurring where another vehicle or bicycle is involved.
- Damage occurring due to extreme temperature exposure (cold night rides okay, liquid nitrogen not okay | hot deserts okay, blowtorch not okay).
- Any component not manufactured by Deviate Cycles (i.e. rear shock and other build parts). Refer to relevant manufacture for warranty details.
- Crash damage (see crash replacement policy) and other damage caused by the environment (i.e. rock strikes).
- Beyond intended/appropriate use. i.e. using a trail bike for downhill riding.
- Professional competitive use.
- Deliberate damage including attempted theft.
- Damage that occurs during transit (i.e. by an airline or in a vehicle).

FUNCTIONING OF WARRANTY

It is our decision if either the bike must be returned to us for inspection or photos must be provided. The frame must be stripped of all non warranty components and cleaned. You will be charged for the pick up service and if the warranty is confirmed the shipping cost will be refunded in full. If the warranty

case is declined then you will be charged for return shipping, if required.

Our decision is final on warranty matters. Your statutory rights are not affected.

For questions or warranty claims please email info@deviatecycles.com



Deviatè Cycles Limited,
Main Street, Kinbuck, Dunblane, FK15 0NQ

tel. +44 (0) 1786 643486
email. info@deviatecycles.com
web. deviatecycles.com

DEVIA TE
cycles