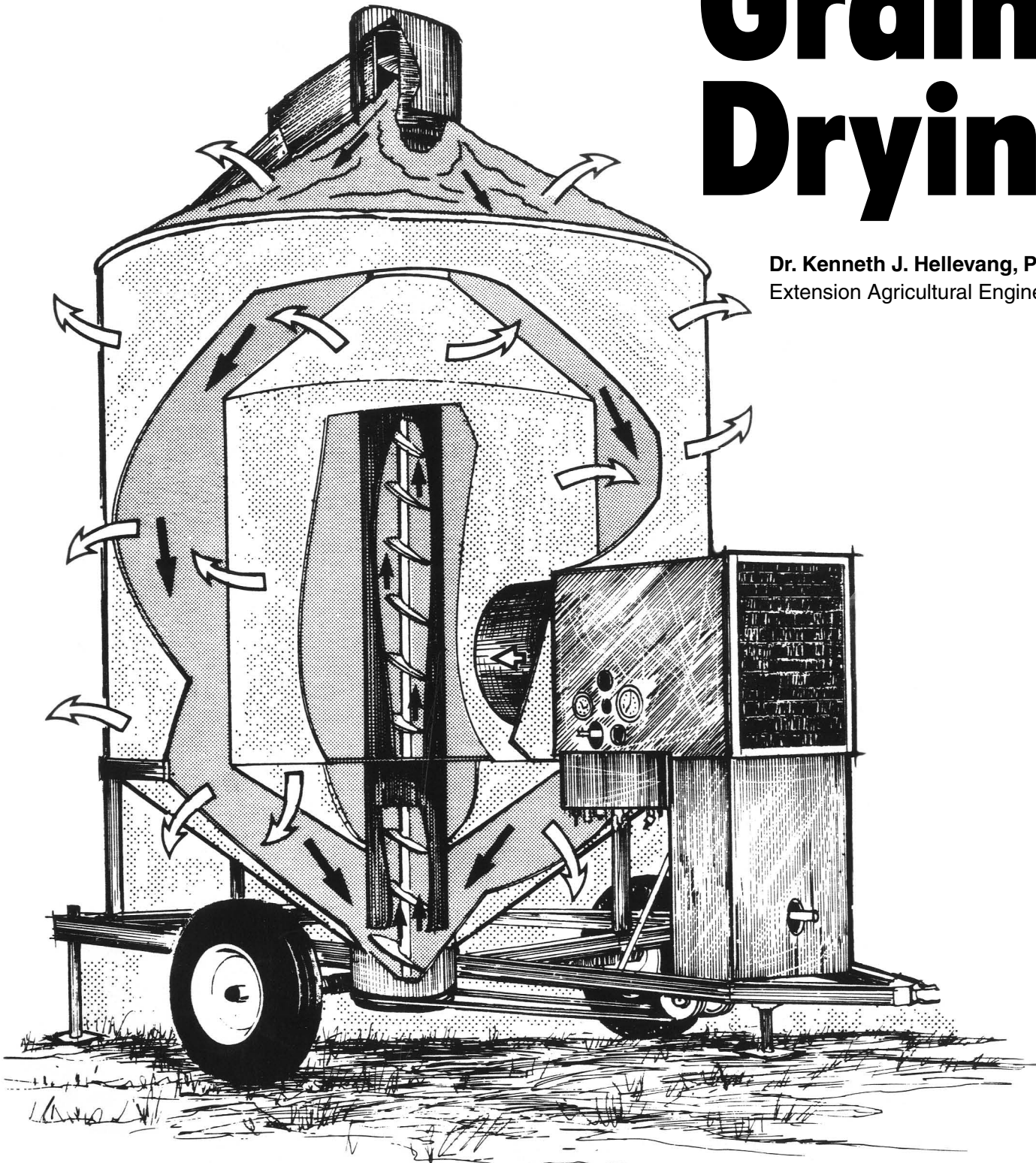


# Grain Drying

Dr. Kenneth J. Hellevang, PE  
Extension Agricultural Engineer



**NDSU** EXTENSION  
SERVICE

North Dakota State University, Fargo, North Dakota

Reviewed October 2013

# CONTENTS

	<b>Page</b>
Tables/Figures .....	2
Recommended Storage Moisture Contents and Estimated Allowable Storage Times.....	3
Influence of Drying Conditions .....	4
Types of Dryers.....	4
Natural Air/Low Temperature Drying.....	5
Layer Drying .....	7
High Temperature Bin Drying .....	7
Batch-in-Bin Drying .....	7
Recirculating Bin Dryer .....	8
Continuous Flow Bin Dryer .....	8
Column Dryers .....	8
Column Batch Dryers .....	9
Continuous Flow Drying .....	9
Combination Drying .....	10
Dryeration and In-Storage Cooling.....	11
Energy Efficiency .....	11
Selecting a Drying System .....	12
Maintaining Quality During Drying .....	13
Drying Fire Hazard.....	13
Moisture Determination .....	14
Moisture Shrink .....	14
Selecting Fans .....	15
Selecting a Heater .....	19
Drying System Cost .....	20
Grain Handling Systems.....	20
Safety Considerations .....	21
Managing Stored Grain .....	21
Other Drying and Storage Information .....	22

# Tables

	<b>Page</b>
1. Maximum Recommended Moisture Contents of Selected Clean, Sound Grains for Storage with Aeration in North Dakota.....	3
2. Approximate Allowable Storage Time of Cereal Grains.....	4
3. Equilibrium Moisture Contents of Three Grains.....	5
4. Minimum Airflow Rates for Natural Air/Low Temperature Drying of Wheat, Corn and Sunflower.....	5
5. Estimated Drying Energy Requirement for Some Dryer Types.....	12
6. Maximum Recommended Drying Air Temperatures for Selected Grains.....	13
7. Estimated Static Pressures for Various Airflow Rates and Grain Depths for Bin Drying Clean Grain.....	15
8. Estimated Static Pressures for Various Airflow Rates and Grain Depths for Natural Air/Low Temperature Bin Drying.....	15
9. Estimated Static Pressures for Various Airflow Rates and Thicknesses of Grain for Batch and Continuous Flow Dryers.....	17
10. Typical Fan Performance.....	18
11. Bin Types, Sizes and Uses.....	20
12. Conveyor Types.....	21
13. Dimensions for Circular Bin Arrangements.....	22

# Figures

	<b>Page</b>
1. A Typical Bin Dryer Utilizing Natural Air/Low Temperature Drying.....	5
2. Duct Sizes and Spacing for Natural Air Drying in a 36 x 72 ft. Building with Grain 6 ft. Deep next to the Wall and 15 ft. Deep in the Center.....	6
3. Example of Layer Drying.....	7
4. Recirculating Batch Bin Dryer and Continuous Flow Bin Dryer.....	8
5. Cross-Section of a Column Batch Dryer.....	9
6. Recirculating Batch Dryer.....	9
7. Cross-Flow Dryer with Forced-Air Drying and Cooling.....	10
8. Cross-Flow Dryer with Reverse-Flow Cooling.....	10
9. Schematic of a Concurrent-Flow Dryer with Counter Flow Cooling.....	10
10. Mixed Flow Dryer.....	10
11. Predicted Moisture Content Differentials of Corn Leaving a Conventional Crossflow Dryer as a Function of Drying Air Temperature and Airflow Rate.....	11
12. Energy Requirements of a Conventional Crossflow Dryer as a Function of Drying Air Temperature and Airflow Rate.....	12
13. A U-Tube Manometer Used for Measuring Static Pressure.....	16
14. Resistance of Clean Grain to Airflow.....	16
15. Common Fans Used on Grain Systems.....	17
16. Handling System for a Bin Dryer Using Portable Augers.....	23
17. Circular Bin Arrangement for Use with Portable Conveyors.....	23
18. Portable Conveyors Handle Grain To and From a Continuous Flow Dryer.....	23
19. A Completely Mechanized Grain Handling- Drying System Using All Permanently Installed Handling Equipment.....	24

**G**rain drying, as used in this publication, refers to the removal of some of the moisture from grain by mechanically moving air through the grain after it has been harvested. Grain in the field dries naturally as the crop matures, giving up moisture to the air until the grain moisture is in equilibrium with the moisture in the air (equilibrium moisture content). Conditions become less favorable for grain to dry to moisture contents considered safe for storage as the harvest is delayed into late fall.

### Drying Advantages and Disadvantages

Grain drying has several advantages and disadvantages.

#### Advantages include:

- Increases quality of harvested grain by reducing crop exposure to weather.
- Reduces harvesting losses, including head shattering and cracked kernels.
- Reduces dependency on weather conditions for harvest.
- Allows use of straight combining for small grains.
- Reduces size and/or number of combines and other harvest-related equipment and labor required due to extending harvest time.
- Allows more time for post-harvest field work.

#### Disadvantages include:

- Original investment for drying equipment and annual cost of ownership.
- Operating costs for fuel, electricity and labor.
- Extra grain handling required may result in further investment for equipment.

## Recommended Storage Moisture Contents and Estimated Allowable Storage Times

The length of time grain can be stored without significant deterioration is determined by temperature and the moisture content at which it is stored. Table 1 shows the maximum recommended moisture content for storage with aeration of some typical North Dakota grains. Short-term storage generally refers to storage under winter conditions while long-term storage considers the effect of summer conditions. Grain with damaged kernels or with significant amounts of foreign material needs to be stored at a 1 to 2 percentage points lower moisture content than sound, clean grain.

Grain can be stored at a higher moisture content without significant fungus development when stored at colder temperatures. Table 2 shows the relationship between moisture and temperature and its effect on allowable storage time for cereal grains.

The allowable storage time for corn has been established to be the time until a 0.5 percent dry matter reduction is reached. At that point there will be a reduction of one grade. Storage life is cumulative. If half of the storage life is used before the grain is dried, only half of the indicated storage time at the lower moisture content is available after the grain has been dried.

**Table 1. Maximum Recommended Moisture Contents of Selected Clean, Sound Grains for Storage with Aeration in North Dakota.**

	Short term (less than 6 months)	Long term (more than 6 months)
Barley	14 %	12 %
Corn	15.5	13
Edible Beans	16	13
Flax seed	9	7
Millet	10	9
Oats	14	12
Rye	13	12
Sorghum	13.5	13
Soybeans	13	11
Non-Oil Sunflower	11	10
Oil Sunflower	10	8
Wheat	14	13

**Table 2. “Approximate” Allowable Storage Time (days) For Cereal Grains.**

M.C. (%)	Temperature (°F)					
	30°	40°	50°	60°	70°	80°
14	*	*	*	*	200	140
15	*	*	*	240	125	70
16	*	*	230	120	70	40
17	*	280	130	75	45	20
18	*	200	90	50	30	15
19	*	140	70	35	20	10
20	*	90	50	25	14	7
22	190	60	30	15	8	3
24	130	40	15	10	6	2
26	90	35	12	8	5	2
28	70	30	10	7	4	2
30	60	25	5	5	3	1

Based on composite of 0.5 percent maximum dry matter loss calculated on the basis of USDA research at Iowa State University; Transactions of ASAE 333-337, 1972; and “Unheated Air Drying,” Manitoba Agriculture Agdex 732-1, rev. 1986.

\*Approximate allowable storage time exceeds 300 days.

A rough estimate of storage life for oil crops might also be made based on the values for corn using an adjusted moisture content calculated using the equation:

$$\text{Comparable Corn Moisture Content} = \frac{\text{Oil Seed Moisture Content} \times 100}{100 - \text{Seed Oil Content}}$$

For example, oil sunflower at 12.0 percent moisture content is comparable to corn at 20 percent moisture content.

Comparable Corn Moisture Content =

$$\frac{12}{100 - 40} \times 100 = 20\%$$

## Influence of Drying Conditions

Airflow rate, air temperature and air relative humidity influence drying speed. In general, higher airflow rates, higher air temperatures and lower relative humidities increase drying speed.

Raising the temperature of the drying air increases the moisture-carrying capacity of the air and decreases the relative humidity. As a general rule of thumb, increasing the air temperature by 20 degrees Fahrenheit (F) doubles the moisture-holding capacity of air and cuts the relative humidity in half.

The drying rate depends on the difference in moisture content between the drying air and the grain kernel. The rate of moisture movement from high moisture grain to low relative humidity air is rapid. However, the moisture movement from wet grain to moist air may be very small or nonexistent. At high relative humidities, dry grain may pick up moisture from the air.

The airflow rate also affects drying rate. Air carries moisture away from the grain, and higher airflow rates give higher drying rates. Airflow is determined by fan design and speed, fan motor size and the resistance of the grain to airflow. Deeper grain depths and higher airflow rates cause higher static pressures against the fan. Higher static pressures decrease fan output.

As air enters the grain, it picks up some moisture, which cools the air slightly. As air moves through a deep grain mass, the air temperature is gradually lowered and relative humidity increased until the air approaches equilibrium with the grain. If the air reaches equilibrium with the grain, it passes through the remaining grain without any additional drying. If high relative humidity air enters dry grain, some moisture is removed from the air and enters the grain. This slightly dried air will begin to pick up moisture when it reaches wetter grain. Air in a 12 to 16 inch grain column does not reach equilibrium with the grain.

## Types of Dryers

Dryers can be categorized in different ways. There are natural air, low temperature, and high temperature dryers; there are batch, automatic batch and continuous flow dryers; and there are in-bin and column or self-contained dryers. Dryers can also be classified according to the direction of airflow through the grain; cross-flow, counter-flow, and concurrent-flow.

# Natural Air/Low Temperature Drying

## Advantages:

- No harvest bottle neck. The bins can be filled at the harvest rate.
- A properly sized system may dry the crop more economically than a high temperature dryer.

## Disadvantages:

- There is a limit on initial moisture content that can be effectively dried.
- Electrical power must be available at each bin for dryer fan motors.

Natural air/low temperature drying refers to drying grain using little or no additional heat. Drying takes place in a drying zone which advances upward through the grain (Figure 1).

Grain above this drying zone remains at the initial moisture content or slightly above, while grain below the drying zone is at a moisture content in equilibrium with the drying air. The equilibrium moisture content of three grains is shown in Table 3.

Drying may take several weeks depending on the airflow rate, climatic conditions and the amount of water to be removed. Natural air/low temperature drying requires enough airflow to complete drying within the allowable storage time. Minimum airflow rates for natural air/low temperature drying of wheat, corn and sunflower are shown in Table 4.

A perforated floor is recommended for all in-bin drying. Since air does the drying, it is imperative that air reaches all the grain. Provide one square foot of perforated surface area for each 30 cubic feet per minute (cfm) of airflow. One square foot of bin exhaust opening should be provided for each 1000 cfm of airflow.

The uniform airflow distribution required for drying is more difficult to achieve with ducts than with perforated floors. However, drying can be done successfully with proper duct spacing and careful attention to detail.

Perforated ducts should be placed on the floor with a maximum centerline spacing equal to one-half the grain depth or the shortest distance to the grain

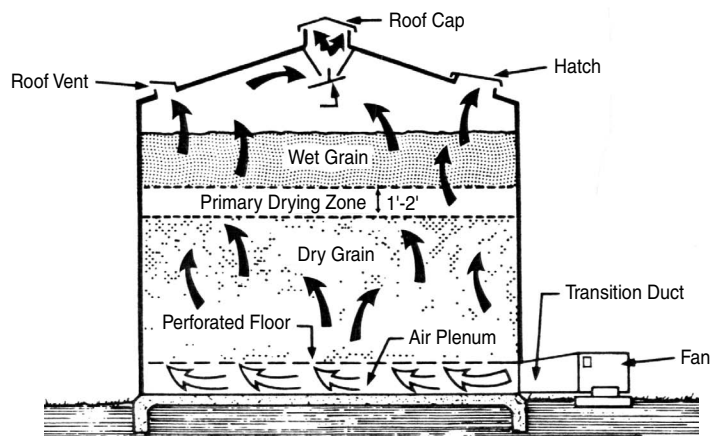


Figure 1. A typical bin dryer utilizing natural air/low temperature drying.

Table 3. Equilibrium Moisture Contents of Three Grains (% W.B.).

Relative Humidity %	Wheat		Corn		Oil Sunflower	
	40°F	70°F	40°F	70°F	40°F	70°F
20	8.5	7.7	7.4	6.4	4.6	4.2
30	10.2	9.2	9.3	8.1	5.6	5.0
40	11.7	10.7	11.0	9.7	6.5	5.9
50	13.2	12.0	12.7	11.2	7.4	6.6
60	14.6	13.3	14.5	12.8	8.3	7.4
70	16.2	14.8	16.4	14.5	9.2	8.3
80	18.0	16.5	18.7	16.6	10.3	9.3
90	20.4	18.7	21.7	19.4	11.9	10.7

Table 4. Minimum Airflow Rates for Natural Air/Low Temperature Drying of Wheat, Corn and Sunflower.

Maximum Airflow Rate (cfm/bu)	Initial Moisture Content (% WB)		
	Sunflower	Wheat	Corn
1/2	15	16	18
1	17	18	21
2	21	20	23

surface, and the distance from the duct to the wall must not exceed one-fourth the grain depth at the duct next to the wall. Provide at least one square foot of duct cross-sectional area for each 2000 cfm of airflow. Provide at least one square foot of perforated surface for each 30 cfm of airflow. If the



duct is longer than 100 feet, it is better to place a fan at each end of the duct.

**Example:** A rectangular building 36 by 72 feet is being used to dry wheat. The wheat is spread to a depth of 10 feet (20,800 bushels). At an airflow rate of 1 cfm/bu, a total of 20,800 cfm of air is required. The ducts must not be spaced more than 5 feet apart to be spaced at one-half the grain depth. The distance from the ducts to the wall must not exceed 2.5 feet to be spaced at one-fourth the grain depth. Eight ducts are needed, with the first duct placed 2.5 feet from the wall and the remainder placed 4.5 feet apart. Each duct must handle 2600 cfm of airflow ( $20,800 \div 8$ ). With a velocity of 2000 ft/minute, a duct area of 1.3 square feet is needed ( $2600 \div 2000$ ). This is a 14-inch square duct, a semi-circular duct with a diameter of 25 inches, or a round duct 16 inches in diameter.

The equations to calculate duct cross-sectional area are:

**Square or Rectangle**

Area (ft<sup>2</sup>) = Width (in.) x Depth (in.) ÷ 144

**Round**

Area (ft<sup>2</sup>) = 3.14 x Diameter (in.) x Diameter (in.) ÷ 576

**Semi-Circle**

Area (ft<sup>2</sup>) = 3.14 x Diameter (in.) x Diameter (in.) ÷ 1152

Drying 20,300 bushels of wheat using the same airflow rate in the same building with the wheat 6 feet deep on the sidewall and peaked to 15 feet in the center would require nine ducts as shown in Figure 2. The ducts are spaced apart no more than one-half the shortest air path out of the grain. The shortest path is different than the grain depth as shown in the figure. The distance between the wall and the first duct must not exceed one-fourth the grain depth. The duct size varies because the quantity of grain that receives air from the duct varies.

The addition of supplemental heat to the air decreases the final moisture content of the grain. The airflow rate affects the drying rate. Using the temperature and relative humidity of the air after it has been heated, the grain equilibrium moisture content can be determined from Table 3. Heating the air 10F will reduce the relative humidity about one-fourth, and heating the air 5F will reduce the relative humidity about one-eighth. With air at 40F and 80 percent relative humidity, heating it 10F will reduce the relative humidity to about 60 percent.

Grain harvested at or near freezing temperatures may be held over winter at acceptable natural air/low temperature drying moisture contents and dried in the spring. The grain should be cooled to about 25F for storage during the winter and monitored regularly. Start drying corn and sunflower in the spring as soon as daily temperatures average above freezing (April) and wheat about May 1.

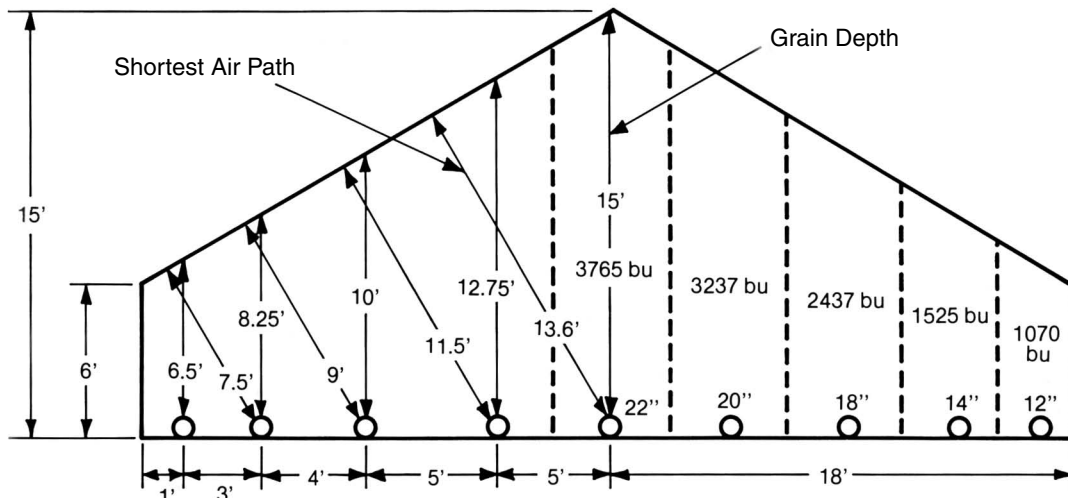


Figure 2. Duct size and spacing for natural air drying in a 36' x 72' building with grain 6 feet deep next to the walls and 15 deep in the center. Perforated duct diameter varies due to different amounts of air required.

The greatest risk involved with natural air/low temperature drying occurs if an abnormally warm, damp period of weather occurs after the grain has been placed in the drying bin. This permits rapid mold development while drying speed is increased very little.

Layer drying or combination drying, to be described later, are options used with natural air/low temperature drying when the grain is wetter than the system is designed to handle.

For more information refer to NDSU Extension Bulletin 35, "Natural Air/Low Temperature Crop Drying."

## Layer Drying

### Advantage:

- Grain with a higher initial moisture content can be harvested as compared to the maximum initial moisture content used in full-bin drying.

### Disadvantage:

- The harvesting schedule may be restricted.

Layer drying is very similar to natural air/low temperature drying except the grain is placed into the drying bin in layers normally about 4 to 5 feet deep. An initial batch or layer of grain is placed in the bin and drying is begun. A drying zone is established and begins to move through the grain. Other layers of grain are periodically added so that a depth of wet grain exists ahead of the drying zone. Limiting grain depth to get a higher airflow rate allows drying a crop at higher moisture contents than the system can handle on a full-bin basis. In a bin designed for 1 cfm/bushel on a full-bin basis, the air flow rate is estimated to be about 4 cfm/bushel if the bin is one-fourth full, Figure 3. The actual airflow rate will vary due to individual fan performance.

The drying front may be found by probing and measuring the moisture content at various levels. Several points should be checked, since progress of the drying front will not be uniform throughout the bin because of fines accumulation. A common problem with layered drying systems is adding additional wet grain too rapidly, resulting in spoilage of the upper layers.

## High Temperature Bin Drying

### Advantages:

- The bin can be used for storage at the end of the drying season.
- Wetter grain can be dried than can be dried with a natural air or low temperature dryer.

### Disadvantages:

- A large moisture variation between grain kernels is possible.
- Grain damage may occur from stirring.

## Batch-in-Bin Drying

The batch-in-bin drying process involves using a bin as a batch dryer. A 3 to 4-foot deep layer of grain is placed in the bin and the fan and heater started. Typical drying air temperatures are 120 to 160 F with airflow rates of 8 to 12 cfm/bushel. Drying begins at the floor and progresses upward.

Grain at the floor of the bin becomes excessively dry while the top layer of the batch remains fairly wet. The grain is cooled in the bin after it is dried. Some batch-in-bin dryers hold the grain being dried in a layer near the roof. After the grain is dried it is dropped to the bin floor where it is cooled. As the grain is moved from the bin, the grain is mixed, and the average moisture content going into final storage should be low enough that mold growth will not be a problem.

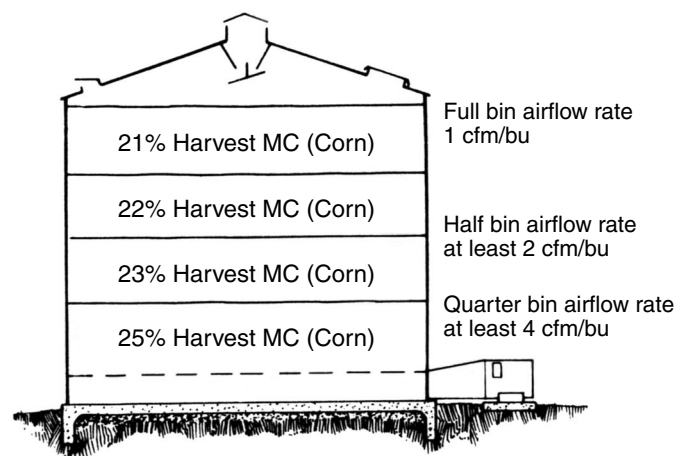


Figure 3. Example of layer drying. The higher airflow rates on a per bushel basis early in the filling permit a higher initial moisture content to be loaded.

A stirring device can be added to provide more uniform drying and moisture content and to increase the capacity of the bin dryer. Research conducted at Iowa State University indicates that with a stirring device there is less than 1 percentage point moisture variation between upper and lower layers of a batch of grain. This research also indicates there is some reduction in resistance to airflow, permitting an increase batch size in the typical bin. Stirring allows depths of up to 7 or 8 feet for corn. There is a tendency for fine materials to migrate to the bin floor as the stirring device is in operation.

Condensation is likely to form on the bin walls. If the last batch of grain to be dried is to be left in the bin for the winter months, air tubes and bin liners have been used to help reduce the problems of mold growth next to the bin wall. Another technique that has shown some benefit is to operate the stirring device next to the wall to provide extra stirring.

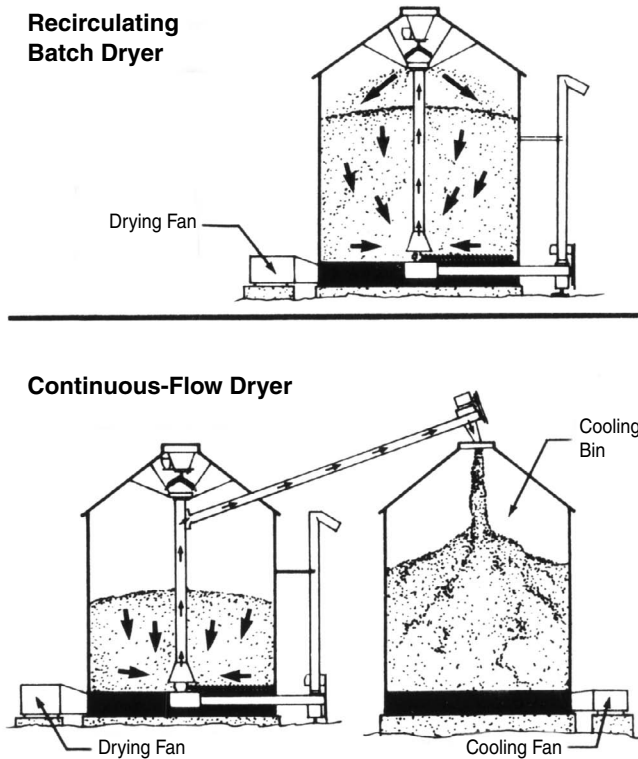
A disadvantage of batch-in-bin drying is that additional storage for wet grain holding is required.

## Recirculating Bin Dryer

The recirculating bin dryer incorporates a tapered sweep auger which removes grain from the bottom of the bin as it dries (Figure 4). The sweep auger may be controlled by temperature or moisture sensors. When the desired condition is reached, sensors start the sweep auger, which removes a layer of grain. After one complete revolution around the bin, the sweep auger stops until the sensor determines that another layer is dry. This dried grain is redistributed on top of the grain surface. The dried grain will be partially rewet by the moist air coming through the grain, which reduces drying efficiency. After all the grain has been dried, the grain is cooled in the bin. The dried and cooled grain is then moved to storage or may be left in the bin. It is common to dry the last bin full of grain using a continuous flow bin dryer as a recirculating bin dryer.

## Continuous Flow Bin Dryer

The continuous flow bin dryer also incorporates a tapered sweep auger which removes grain from the bottom of the bin as it dries, but the grain is moved to a second bin for cooling (Figure 4). Up to 2 points of moisture may be removed in the cooling bin if dryeration is used. (Dryeration is described later in this publication.) Increasing the grain depth will reduce the airflow rate, cfm, and the drying rate of a continuous flow bin dryer. In a recirculating batch or continuous flow bin dryer, it is the total airflow capacity, cfm, that determines the drying rate, not the airflow rate, cfm/bu.



**Figure 4.** Grain recirculators convert a bin dryer to a high speed recirculating batch or continuous flow dryer.

## Column Dryers

### Advantages:

- Dryer does not occupy grain storage space.
- Portable units can be moved from one location to another.

### Disadvantage:

- The heat available in the dryer is not used as efficiently as in deep bed drying.



## Column Batch Dryers

Column batch dryers are completely filled at one time. A common batch dryer configuration is two columns surrounding a plenum chamber (Figure 5). Several circular-shaped batch dryers are also available. Hot air forced into the plenum from a fan-heater unit passes through the grain-filled columns and dries the grain. Common batch capacity of batch dryers varies from 80 to 1,000 bushels. Column widths are normally from 10 to 20 inches. High temperatures and high airflow rates characterize batch dryers. The typical operating sequence is fill-dry-cool-unload. Time for one batch varies, but an average may be two to three hours per batch. Control of the drying sequence can be either manual or automatic.

A recirculating device may be added to some batch dryers (Figure 6). This has the effect of reducing the moisture variation across the column of the dryer. For some crops, a higher temperature may be used with a recirculating batch dryer since a kernel of grain will not be next to the heated air for the entire drying cycle and as a result should not get as hot.

## Continuous Flow Drying

Wet grain constantly feeds in the top and is dried and cooled in a continuous flow dryer. Dry grain is drawn off the bottom and placed into storage. These dryers are similar to batch dryers in configuration but have a divided plenum chamber. Hot drying air is pushed into the top chamber, and unheated air for cooling is pushed into the lower chamber. Column widths on continuous flow dryers vary from 8 to 20 inches. A sensor controls the discharge rate and consequently the moisture content of the dried grain. Continuous flow dryers use high temperatures and high airflow rates. Airflow rates of 50 to 100 cfm/ bushel of grain are common. Continuous flow dryers are available in a large range of sizes. Portable units are available in sizes up to about 1000 bushel per hour capacity, and stationary units of larger capacity are available. The first grain through a continuous-flow dryer generally will need to be cycled through the dryer again for drying to be completed. A continuous flow dryer with cross-flow airflow is shown in Figure 7.

Some cross-flow models reverse the airflow through the dryer as the grain progresses down the column to reduce overdrying. Some reverse the air flow in the cooling section to increase energy efficiency (Figure 8). A concurrent flow dryer with counter-flow

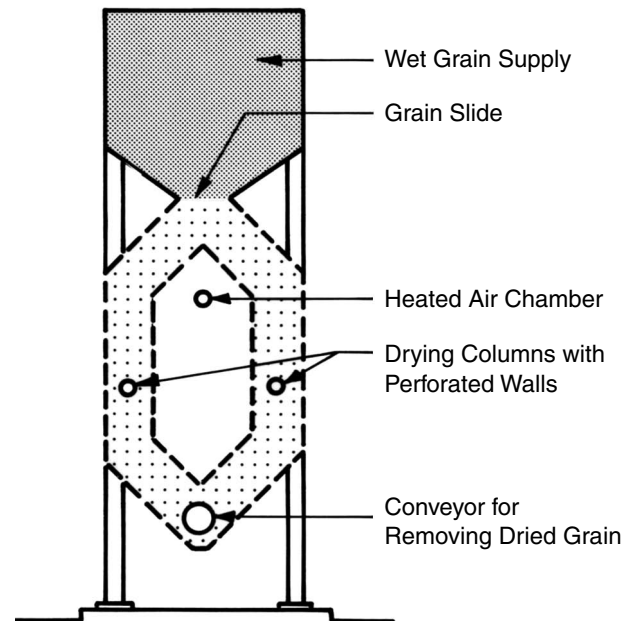


Figure 5. Cross-section of a column batch dryer.

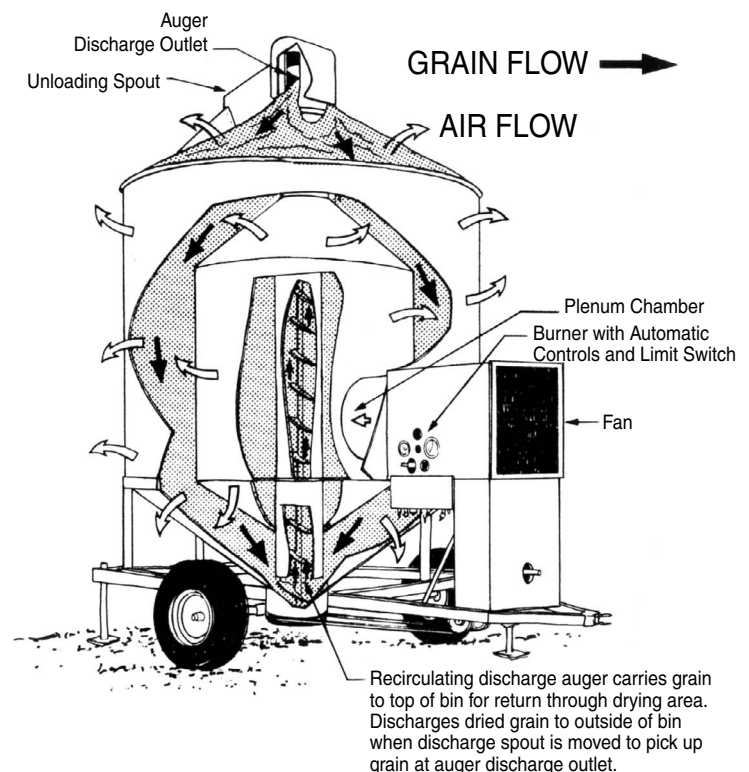
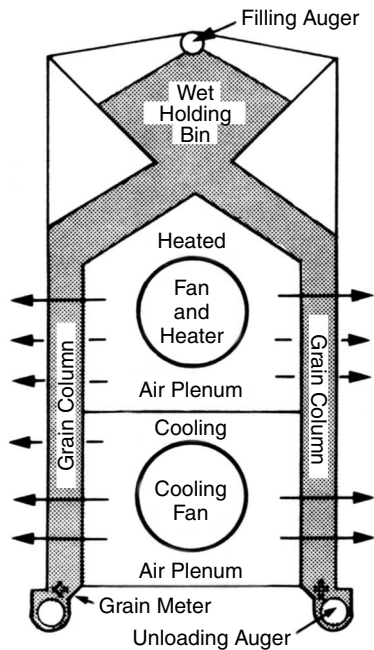
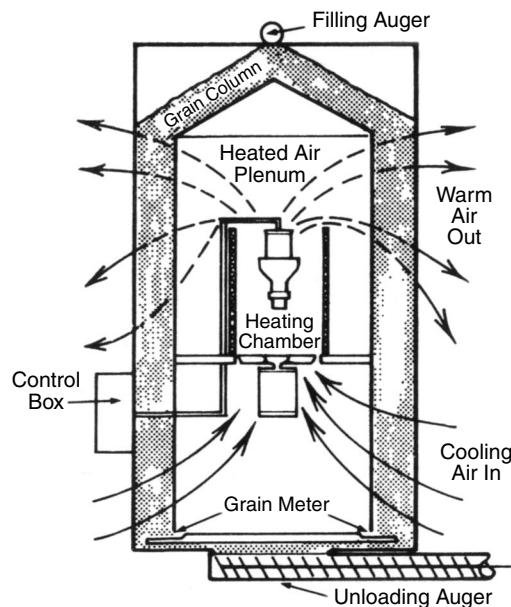


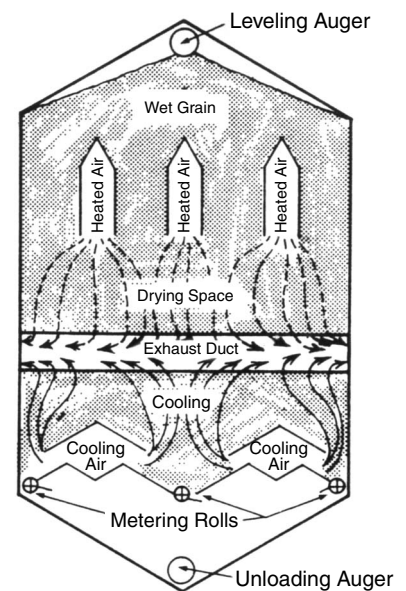
Figure 6. Recirculating batch dryer.



**Figure 7. Cross-flow dryer with forced-air drying and cooling.**



**Figure 8. Cross-flow dryer with reverse-flow cooling.**

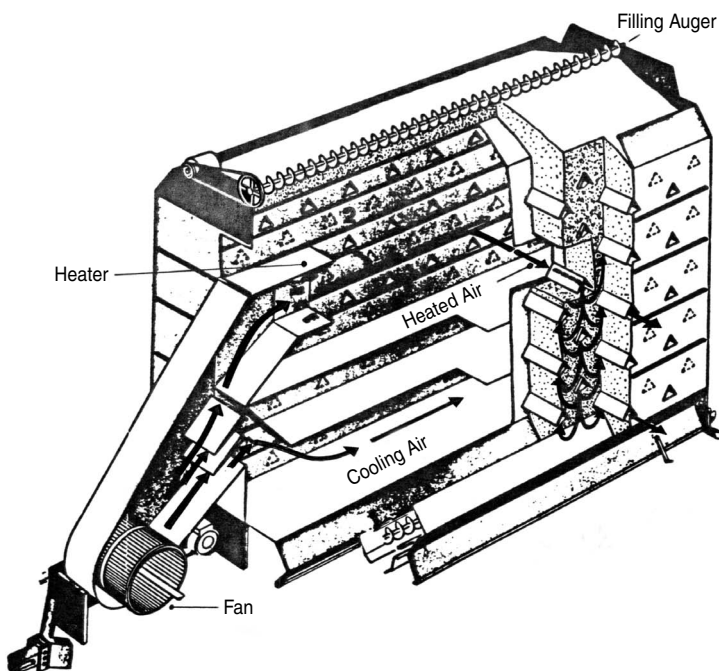


**Figure 9. Schematic of a concurrent-flow dryer with counter-flow cooling.**

cooling is shown in Figure 9. The concurrent-airflow in the drying section and counterflow in the cooling section improves energy efficiency and reduces stress cracking in corn. With this system, the heated

air enters the grain near the top of the dryer and moves downward in the same direction as the grain. The cooling air moves in the opposite direction as the grain.

Another type of dryer is the mixed flow dryer shown in Figure 10. In this type, the grain flows over alternating rows of heated air supply ducts and air exhaust ducts. This action provides mixing of the grain and alternate exposure to drying air that is relatively hot and air which has been cooled by previous contact with the grain. It promotes moisture uniformity and nearly equal exposure of the grain to the drying air.



**Figure 10. Mixed-flow dryer.**

## Combination Drying

### Advantages:

- Increases drying rate of high temperature dryer by about 300 percent.
- Increases energy efficiency.

### Disadvantages:

- Requires natural air/low temperature drying to complete drying.
- Requires more grain handling.

Combination drying is a process using a high temperature dryer to dry the crop to a certain level, then a natural air/low temperature drying system completes the drying process. This system may be used to increase the capacity of the high temperature drying equipment, for increased energy efficiency, or when conditions are not suitable to start drying with a natural air/low temperature drying system. The crop is dried from the harvest moisture content to a level acceptable for natural air/low temperature drying, then it is moved to the natural air/low temperature dryer and drying is completed.

## Dryeration and In Storage Cooling

### Advantages:

- Increases drying rate by about 60 percent for dryeration and 30 percent for in-storage cooling.
- Increases energy efficiency.

### Disadvantages:

- Requires cooling fan and bin.
- Requires more grain handling.

Dryeration is a process where hot grain is removed from the dryer with a moisture content 1 or 2 percentage points above that desired for storage. The hot grain is placed in a dryeration bin where it is allowed to temper without airflow for at least four to six hours. The moisture content equalizes in the kernel during tempering. After the first hot grain delivered to the bin has tempered, the cooling fan is turned on while additional hot grain is delivered to the bin. The grain is cooled and 1 to 2 percent moisture content is removed by the airflow before it is moved to final storage. Cooling is normally completed about six hours after the last hot grain is added if the cooling rate equals the filling rate.

In-storage cooling eliminates tempering. Grain is dried to the desired moisture content for storage in the dryer, then moved to storage where it is cooled. Quality of the grain is improved with both in-storage cooling and dryeration because the final drying and cooling are done at a slower rate than in a conventional high temperature drying system.

Refer to NDSU Extension Circular AE-808, "Crop Dryeration and In-Storage Cooling," for detailed information on dryeration and in-storage cooling.

## Energy Efficiency

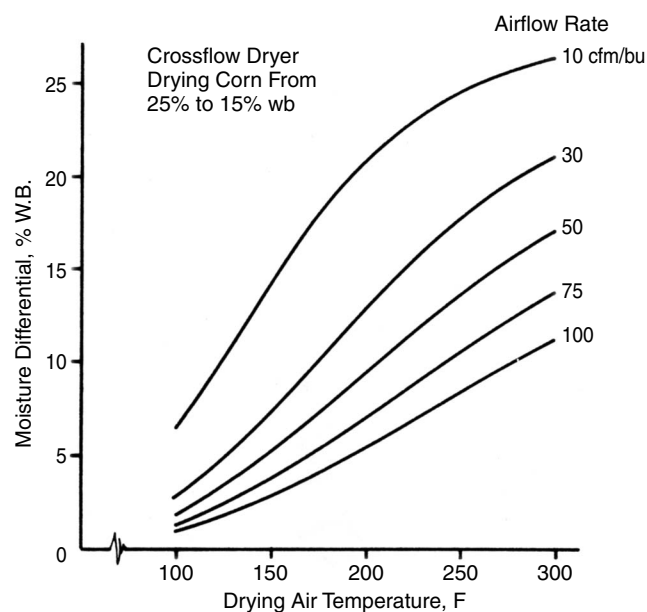
Dryer design is a compromise between speed, energy efficiency and moisture variation across the grain dryer column.

Figure 11 shows how airflow and temperature affect the moisture variation across a grain column one foot thick when drying corn from 25 percent to 15 percent moisture.

The least moisture variation was obtained at low temperatures and high airflow rates. However, Figure 12 shows that these conditions result in high energy requirements. For energy efficiency, a high temperature and low airflow rate are required. Each grain reacts differently to high temperatures; low temperatures may be needed to maintain grain quality.

Table 5 shows the estimated drying energy requirement of some dryer types. Generally more energy is required the faster the grain is dried.

Other factors affecting the energy required for drying grain include the moisture content at harvest and moisture content for storage. If the grain dries in the



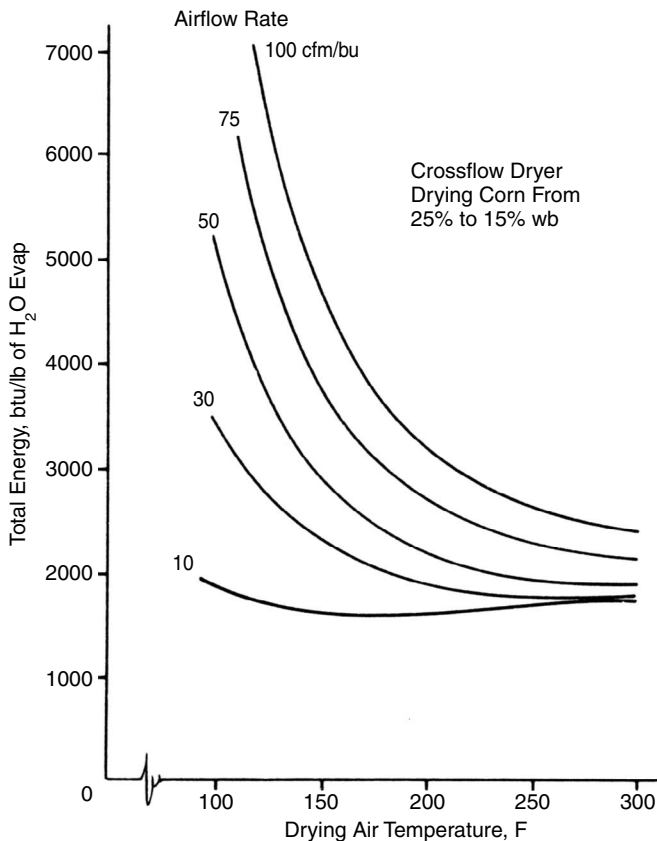
**Figure 11. Predicted moisture content differentials of corn leaving a conventional crossflow dryer as a function of drying air temperature and airflow rate. Column width is 12 inches.** (University of Nebraska, Dr. Thompson)

field, no fuel is required for drying but field losses, both grain quantity and quality, may be higher. Avoiding overdrying also results in energy savings since less water is removed.

The energy savings to be obtained from a grain dryer with air-recirculation capability depends on the type and the amount of air recirculated in the

dryer and the difference between the recirculation air temperatures and the drying temperature. Dryers that can recirculate only the cooling air show an energy efficiency increase of 10 to 20 percent compared to equivalent dryers without air recirculation. Units capable of recirculating both the cooling and part of the drying air may improve energy efficiency up to 30 percent. Air recirculation may increase the fire hazard when drying sunflower, so it is not normally recommended.

For more information on energy conservation, refer to National Corn Handbook leaflet NCH-14, "Energy Conservation and Alternative Energy Sources for Corn Drying."



**Figure 12. Energy requirements of a conventional crossflow dryer as a function of drying air temperature and airflow rate.** (University of Nebraska)

## Selecting a Drying System

Each drying system has advantages and limitations. Select a dryer and system to meet your particular need.

It is important to weigh all factors in the drying system before selecting a dryer. For example, a continuous flow column dryer needs holding facilities for both wet and dry grain. Grain handling equipment is a very important part of any drying system. Large electric motors that need adequate electrical service are likely involved. Fuel must be stored and supplied to the dryer. The drying system needs to be located to allow for good traffic flow and drainage. Existing storage facilities and handling equipment also need to be considered.

Purchase the dryer or equipment from a reputable dealer that will be able to service the dryer and provide other assistance. Check with people who have dealt with the dealer you are considering. Examine existing systems or dryer installations and visit with the operators about their experiences.

Planning for the future primarily means leaving space for future facilities and equipment. One rule of thumb is to plan for the foreseeable future and then double it. This allows an orderly development as the system expands. Structures in place cannot be easily changed.

**Table 5. Estimated Drying Energy Requirements for Some Dryer Types.**

Dryer Type	BTU's/lb. of Water Removed
Natural Air	1000–1200
Low Temperature	1200–1500
Batch-in-Bin	1500–2000
High Temperature	
Air Recirculating	1800–2200
W/O Air Recirculating	2000–3000

## Maintaining Quality During Drying

Nutritional quality of livestock feed is unaffected by temperatures up to 250 F, although some kernel surface scorching may result.

A number of tests on drying seed grains show that germination drops rapidly as the seed kernel temperature goes above 120 F. For this reason it is recommended that a maximum of 110 F air be used. Some seed producers use lower temperature limits in an effort to provide some extra protection. Since germination is important for malting barley, 110 to 120 F is the maximum recommended drying air temperature.

For flour milling, it is important that temperatures above about 150 F be avoided because of the effect of high temperatures on the chemical structure of the grain. It is a common practice for some millers to test a sample of the grain for milling properties before purchasing. High temperatures can severely damage baking quality even though the grain kernels appear undamaged. The maximum drying air temperature for drying milling wheat is 150 F for 16 percent moisture content and 130 F for 20 percent moisture content wheat.

**Table 6. Maximum Recommended Drying Air Temperatures for Selected Grains. (°F)**

Grain	Dryer Type				Seed
	Cont. Flow Dryer	Recirculating Batch Dryer	Column Batch Dryer	Bin Batch Dryer	
Wheat and Durum	150°	150°	135°	120°	110°
Malting Barley	120°	120°	110°	110°	110°
Soybeans (non-food)	130°	130°	110°	110°	110°
Oats	150°	150°	135°	120°	110°
Rye	150°	150°	135°	120°	110°
Sunflower	200°	200°	180°	120°	110°
Flaxseed	180°	180°	160°	120°	110°
Corn	200°	200°	180°	120°	110°
Mustard and Rape	150°	150°	130°	110°	110°
Pinto Beans, Navy Beans	90°	90°	90°	90°	90°

Rate of drying, which is related to drying temperature, is the major limitation on drying beans. At high drying rates, the seed coat of soybeans shrinks faster than the seed, causing cracks in the seed coat. Further handling results in breaking and re-moval of the seed coat. Development of bitter or “off” flavors and increased spoilage can occur in the split seed. If the relative humidity of the drying air is kept above 40 percent, there is little or no damage to the seed coat. Pinto beans may develop stress cracks and splits anytime the relative humidity of the drying air drops below 40 percent. A 10 F temperature rise will reduce the relative humidity by about one-fourth. If air is 40 F and 80 percent relative humidity, heating it 10 F will reduce the relative humidity to about 60 percent;  $80 - (80 \div 4)$ . Natural air/low temperature drying is best for drying beans.

Oil yield and fatty acid composition of sunflower are not affected by drying air temperatures up to 220 F. Non-oil sunflower seed meats may be scorched at temperatures exceeding 180 to 190 F.

Maximum recommended drying air temperatures for selected grains are shown in table 6.

## Drying Fire Hazard

Any dryer using an open flame to heat the air poses a constant fire hazard when used to dry any crop, especially sunflower and sorghum. Fine fibers from sunflower seed or other plant materials may be ignited by the burner and carried to the seeds, causing them to ignite. This fire hazard can be reduced by turning portable dryers into the wind so airborne fibers are blown away from the dryer intake and by pointing permanent dryers into the prevailing wind. A moveable air intake duct may be placed on the burner intake to draw clean air away from the dryer. The duct must be large enough to not restrict the airflow, because drying speed will be reduced if the airflow is reduced.

Clean the dryer, air ducts, and area around the dryer at least daily. Frequently remove the collection of sunflower lint on the dryer column and in the plenum chamber, as this material becomes extremely dry and can be ignited during dryer operation. A major concern is that some sunflower seeds will hang up



in the dryer or be stopped by an accumulation of fines and become over dried. Make sure the dryer is completely cleaned out after each batch, keep sunflower seed moving in the dryer, and check a continuous flow dryer regularly (hourly) to see that the sunflower seed are moving.

High speed dryers are like a forge when a fire gets going. However, fires can be controlled if they are noticed immediately, which makes constant monitoring necessary. Many fires can be extinguished by just shutting off the fan to cut off the oxygen. A little water applied directly to the fire at the early stages may extinguish it if shutting off the fan fails to do so. A fire extinguisher for oil type fires should be used for oil sunflower fires. Many dryers are now designed so that sunflower can be unloaded rapidly in case of a fire, before the dryer is damaged. In some dryers, just the part of the dryer affected by the fire needs to be unloaded.

## Moisture Determination

Grain moisture content may be determined by direct or indirect methods. Direct methods are commonly used for laboratory work where exact determination is critical. Heating the grain sample to drive off moisture and weighing before and after heating, according to a standardized procedure, to find water loss is a direct method.

Moisture meters commonly used with farm drying installations measure moisture indirectly. They measure the electrical conductance or capacitance of the grain, since moisture in grain affects these electrical properties of the kernels. A reading on the moisture meter is converted to a moisture reading by use of a calibration chart or table.

Most farm moisture meters have accuracies of  $\pm 1/2$  percent moisture content under normal operating conditions. High grain temperatures affect the accuracy of moisture meter readings. Grain close to the meter's calibration temperature, often about 75 F, give more accurate readings than grain at higher or lower temperatures. Some meters have an internal temperature compensation and others require that the temperatures be measured and a correction be made to the meter reading using a correction chart.

Many stories of moisture contents "rebounding" after drying actually are caused by grain tempering. Grain that has just been dried will have an uneven moisture content across the kernel. The kernel surface will be drier than the interior, and this will cause the moisture meter to read low. During tempering, the moisture redistributes in the kernel, which gives a more accurate but higher moisture reading.

When checking samples for moisture directly from the dryer, a correction factor may have to be added. The factor changes with temperature and moisture content, so the factor must be determined periodically for your meter. One method of approximating this correction is to seal a sample in a canning jar for 10 to 12 hours until the temperatures and moisture distribution within the kernels equalize. Then check the moisture content. Comparing this reading to the moisture readings of the sample straight from the dryer will give an approximate correction factor.

**Caution:** Recheck grain 12 hours after drying to be sure the moisture content is what you want.

### Points to remember when using moisture testers are:

- When testing during or immediately after drying, the reading is probably in error.
- Find the moisture content of several samples for the lot of grain being checked.
- Do not handle the sample with your hands (this adds moisture) or expose it to air in an open container (this causes some drying or wetting to occur)
- Weigh or measure the sample accurately if required.
- Use proper procedure for temperature correction if necessary.

## Moisture Shrink

The removal of moisture from grain during drying causes a reduction in grain quantity referred to as moisture shrink. The moisture shrink can be calculated using the following equation.

Moisture Shrink (%) =

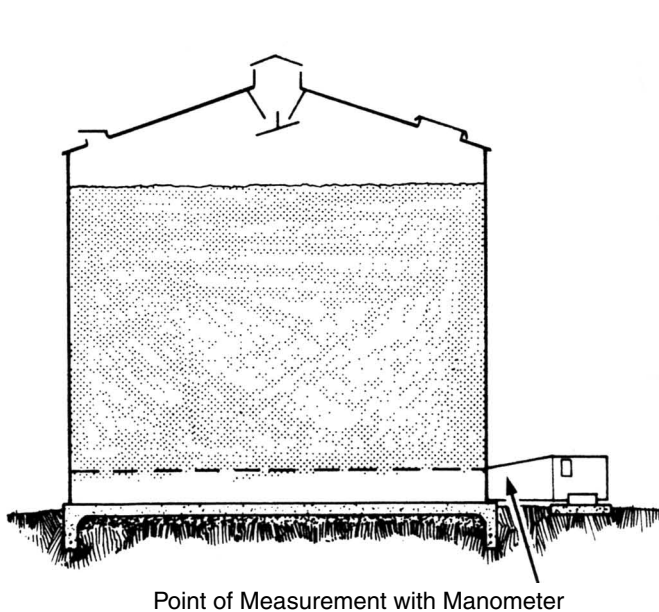
$$\frac{\text{Initial Moisture Content} - \text{Final Moisture Content}}{100 - \text{Final Moisture Content}} \times 100$$

The moisture shrink percentage for drying corn from 25 to 15 percent moisture content is:

$$\text{Moisture Shrink (\%)} = \frac{25 - 15}{100 - 15} \times 100 = 11.76\%$$

The weight reduction drying 1000 pounds of corn from 25 to 15 percent moisture content is 11.76% x 1000 = 117.6 pounds. Moisture shrink tables AE-94, "Grain Drying Tables," are available from the NDSU Extension Service.

Refer to NDSU Extension Circular AE-905, "Grain Moisture Content Effects and Management," for more information on moisture shrink and other effects of changing grain moisture content.



## Selecting Fans

Satisfactory drying depends upon both the airflow rate supplied and the ability of the air to hold water. The ability of a fan to move air through the grain will depend upon the fan design, and the resistance to the airflow. The pressure a fan must develop to overcome the resistance of grain to airflow is referred to as static pressure. The unit most commonly used for measuring resistance to airflow is inches of water as measured by a manometer (Figure 13). One inch of water is equal to 0.036 pounds per square inch (psi). Figure 14 shows typical resistances to airflow of some clean grains commonly grown in North Dakota. This resistance to airflow is technically referred to as static pressure drop through the grain. Multiply this pressure drop for clean grain by 1.3 to 1.5 to adjust for packing and foreign material in the grain. The value varies depending on the cleanliness and physical properties of the grain. A value of 1.3 is commonly used for wheat and 1.5 for other crops. Tables 7 and 8 list the estimated static pressure for various airflow rates and grain depths for bin drying clean grain.

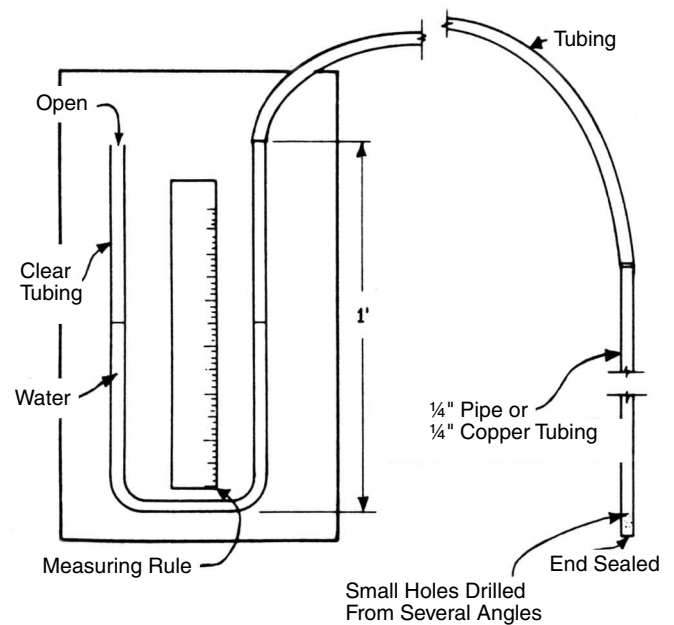


Figure 13. A U-tube manometer used for measuring static pressure.

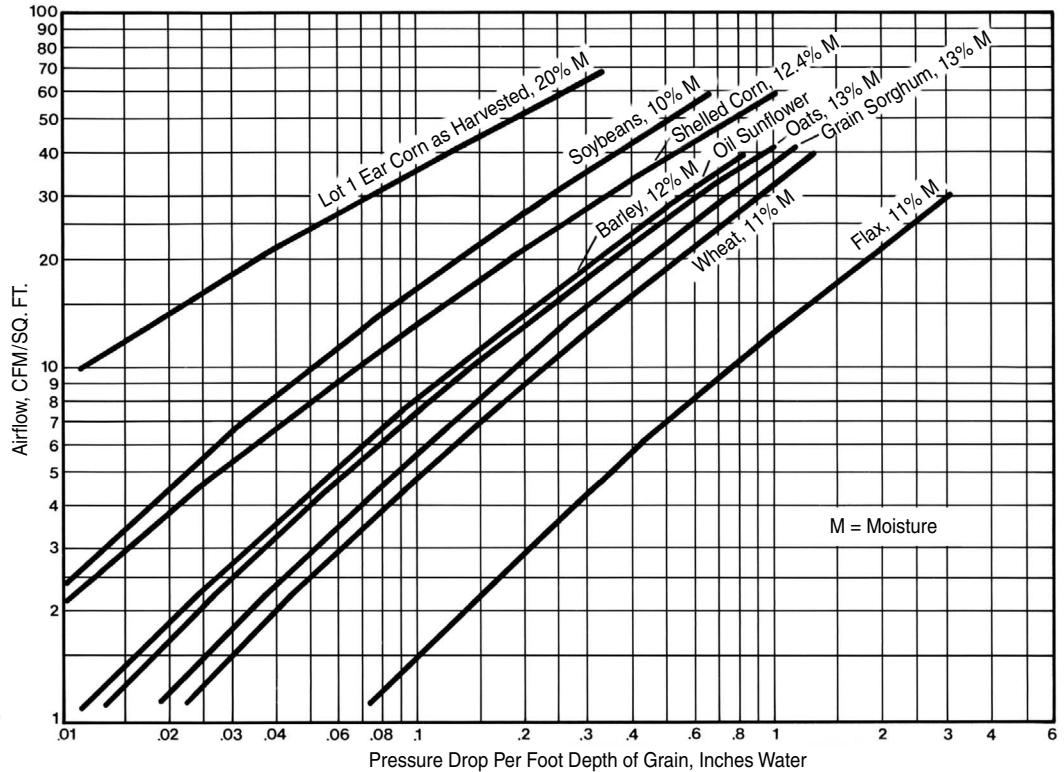


Figure 14. Resistance of clean grains to air flow. Multiply values by 1.3 to 1.5 to adjust for packing and foreign material. Using a grain distributor will increase the resistance to airflow.

Table 7. Estimated Static Pressures for Various Airflow Rates and Grain Depths for Bin Drying Clean Grain. Increase Values Slightly to Account for Foreign Material.

Depth of Grain	Airflow Rate			
	8 cfm/bu	6 cfm/bu	5 cfm/bu	3 cfm/bu
Static pressure inches of water				
Wheat				
4 feet	3.25	2.25	1.85	1.13
6 feet	7.45	5.35	3.79	2.35
8 feet	16.25	10.65	8.25	4.25
10 feet	27.75	18.25	13.25	7.75
Barley				
4 feet	2.10	1.45	1.25	.77
6 feet	5.05	3.37	2.65	1.45
8 feet	12.25	6.65	5.05	2.65
10 feet	18.25	12.25	8.75	4.25
Soybeans				
4 feet	1.00	.77	.61	.44
6 feet	2.35	1.57	1.27	.76
8 feet	4.65	3.30	2.40	1.21
10 feet	7.75	5.15	4.05	1.95
12 feet	12.25	7.69	4.81	2.89
Shelled Corn				
4 feet	1.36	.93	.81	.51
6 feet	2.95	2.11	1.69	1.00
8 feet	7.05	4.25	3.45	1.61
10 feet	13.25	7.25	5.45	2.75
12 feet	21.85	11.17	8.65	4.33

Use barley values for sunflower.

Table 8. Estimated Static Pressures For Various Airflow Rates and Grain Depths for Natural Air/Low Temperature Bin Drying.\*

Grain	Depth (ft.)	Airflow Rate (cfm/bu.)			
		1/2	3/4	1	2
inches of water column					
Wheat	10.0	1.5	2.1	2.8	5.7
	12.5	2.2	3.2	4.2	9.1
	15.0	2.9	4.4	5.7	13.8
	17.5	3.9	5.9	8.4	20.0
	20.0	5.1	7.7	10.6	24.7
Barley	10.0	1.2	1.6	2.0	4.0
Oats	12.5	1.6	2.2	3.0	6.5
Sunflower	15.0	2.1	3.2	4.1	9.6
	17.5	2.7	4.1	5.8	14.2
	20.0	3.5	5.3	7.4	18.5
Shelled Corn	10.0	0.8	1.0	1.3	2.5
	12.5	1.0	1.4	1.8	3.9
	15.0	1.3	1.9	2.2	5.9
	17.5	1.6	2.3	3.7	8.6
	20.0	2.1	3.1	4.4	11.6
Soybeans	10.0	0.7	0.9	1.0	1.5
	12.5	1.0	1.2	1.6	2.1
	15.0	1.1	1.4	1.8	3.1
	17.5	1.2	1.6	2.0	4.3
	20.0	1.5	2.2	2.9	5.9

\*Includes 0.5 inch of static pressure drop for the distribution system

Refer to NDSU Extension Bulletin EB-35, "Natural Air/Low Temperature Crop Drying," for more detailed low airflow rate tables.

Table 9 lists estimated static pressures for various airflow rates and column widths typically used for column dryers.

There are several different types of fans. Each has specific operating characteristics and applications. The common types of fans used for grain drying applications are the axial-flow, low speed centrifugal, high speed centrifugal, and the in-line centrifugal (Figure 15).

Table 10 shows the airflow at various static pressures for some typical fans. **NOTE: A similar table for the specific fan being considered should be consulted when selecting a fan.**

**Fan Selection Example:** Select a fan to provide an airflow rate of 1.0 cfm/bushel for a bin of wheat. The bin is 24 feet in diameter and the wheat is 16 feet deep.

1. Calculate capacity of the bin.

$$\begin{aligned} \text{Area of bin floor} &= \frac{\pi \times \text{Diameter}^2}{4} \\ &= \frac{3.14 \times 24 \times 24}{4} = 452.16 \text{ ft}^2 \end{aligned}$$

$$\text{Volume} = \text{Area} \times \text{Depth}$$

$$\text{Volume} = 452.16 \times 16 = 7238 \text{ ft}^3$$

$$\text{One Bushel} = 1.244 \text{ ft}^3$$

$$\text{Bushels} = 7238 \div 1.244 = 5818 \text{ bushels}$$

2. Determine airflow required.

$$\text{Bushels} \times \text{cfm/bu} = \text{cfm}$$

$$5818 \times 1.0 = 5818 \text{ cfm}$$

3. Determine velocity of air through grain.

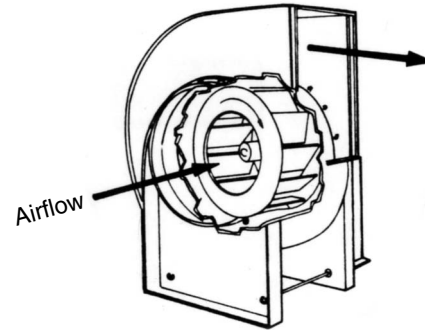
$$\text{cfm} \div \text{bin floor area} = \text{cfm/sq. ft.}$$

$$5818 \div 452.16 = 12.9 \text{ cfm/sq. ft.}$$

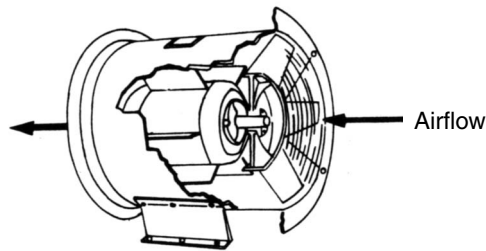
**Table 9. Estimated Static Pressures for Various Airflow Rates and Thicknesses of Grain for Batch and Continuous Flow Dryers.**

Depth of Grain	Air Flow Rate (cfm/bu)				
	25	50	75	100	150
(Wheat)					
8"	0.21	0.53	0.87	1.30	2.70
12"	0.54	1.30	2.20	3.10	6.80
16"	1.00	2.50	4.10	6.10	12.60
20"	1.80	4.20	6.80	10.00	21.70
24"	2.60	6.20	10.40	15.20	—
(Corn)					
8"	0.07	0.18	0.35	0.54	1.60
12"	0.18	0.53	1.10	1.70	4.70
16"	0.37	1.10	2.30	3.60	10.10
20"	0.68	2.20	4.00	6.20	17.50
24"	1.10	3.40	6.60	10.00	—

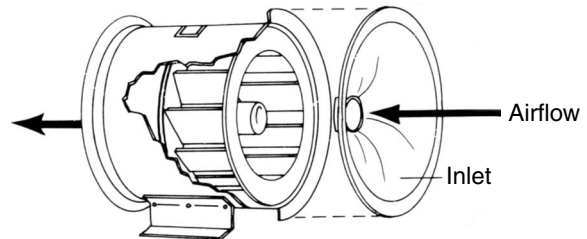
\*Note: This table gives values for clean, dry, unpacked grain. Under actual drying conditions higher values may be expected.



Axial-flow fans operate most efficiently at static pressures below 3 to 4 inches of water. Noise can be a problem.



Centrifugal fans require higher investment than axial-flow fans, but are more efficient at higher static pressures and are quieter. They normally operate at 1,750 or 3,500 rpm.



In-line centrifugal fans develop higher pressure than an axial fan at a lower cost than a normal centrifugal fan.

**Figure 15. Common Fans Used on Grain Systems.**

4. Determine resistance to airflow from Figure 14.

Approximately 0.32 inches of water per foot of depth.

16 ft. grain depth

16 x .32 = 5.1 inches static pressure

Non-clean wheat static pressure =

5.1 x 1.3 = 6.6 inches

Add 0.5 inch for ducts and vents.

6.6 + 0.5 = 7.1 inches

5. Select the fan.

Air Horsepower =

$\frac{\text{Airflow Rate (cfm)} \times \text{static pressure}}{6320 \times \text{fan efficiency}}$

6320 x fan efficiency

Fan efficiency will vary from about 30 to 70% over the fans operating static pressure range.

Drying fans operating at peak efficiency will have an efficiency of about 65 percent.

$$HP = \frac{5818 \times 7.1}{6320 \times 0.65}$$

$$HP = 10.1$$

A centrifugal fan is needed due to the high static pressure.

Of the fans in Table 10, a 10 hp low speed centrifugal fan appears to have the ability to deliver the required airflow against 7 inches of static pressure. If a fan cannot be found to meet the requirements or a smaller horsepower fan is desired, there is the option of using a lower airflow rate or a shallower depth. Let's redo the calculations with 12 feet of wheat in the bin.

Total bushels = 4364

Air flow rate required (cfm) = 4364 cfm

Velocity = 9.6 cfm/sq. ft.

Resistance = 0.29 inches of water/foot x 12 x 1.3 + .5

= 5 inches static pressure

A 5 hp low speed centrifugal fan as shown in Table 10 will deliver the required airflow against 5 inches static pressure.

**Table 10. Typical Fan Performance.\***

Type	Fan			Static Pressure (Inches of Water)									
	Hp	Dia. (in.)	RPM	1	2	3	4	5	6	7	8	9	10
				Airflow Rate (cfm)									
Axial	3.0	18	3450	5700	4600	2650	1400						
LS Cent.	3.0	24	1750	4580	4230	3820	3350	2550					
HS Cent.	3.0	16	3500		2950		2550		2120		1650		1000
IL Cent.	3.0	18	3450	3800	3600	3400	3000	2500	1900				
IL Cent.	3.0	24	3450	4100	4000	3750	3500	3250	2950	2650			
Axial	5.0	24	3450	10500	9000	7000	4600	2900					
LS Cent.	5.0	24	1750	7800	7000	6250	5550	4600	3300				
HS Cent.	5.0	13	3500		4350		3850		3200		2200		1800
IL Cent.	5.0	24	3450	5500	5000	4400	4100	3900	3600	2800	1800		
Axial	7.5	24	3450	12500	11100	9450	6550	3900					
LS Cent.	7.5	24	1750	10550	9750	8950	8000	7400	6100				
HS Cent.	7.5	15	3500		5700		5100		4500		3800		2900
IL Cent.	7.5	28	3450	6200	6000	5700	5500	5200	4800	4500	4000	3500	3000
Axial	10.0	26	3450	15500	14000	12250	9500	5800	3400				
LS Cent.	10.0	27	1750	13300	12400	11550	10500	9550	8500	7300			
HS Cent.	10.0	18	3500		6800		6300		5750		5100		4450
IL Cent.	10.0	28	3450	7700	7300	6800	6500	6300	6000	5400	5100	4800	4400

LS = Low Speed Centrifugal Fan  
 HS = High Speed Centrifugal Fan  
 IL = In-Line Centrifugal Fan

\*Consult a comparable table for the actual fan being selected.



Two or more fans are sometimes used to move air through the grain. The fans can be attached either in parallel or series. When the fans are attached in parallel, each fan must be selected based on the total static pressure. For example, one 5 hp low speed centrifugal fan will move about 4600 cfm against a static pressure of 5 inches. Two 5 hp low speed centrifugal fans in parallel will each move about 3000 cfm against the resulting higher static pressure of 6.5 inches. The total airflow will be about 6000 cfm. Hooking fans in series (tandem) allows developing twice the static pressure. For example, a 5 hp axial fan will only move about 2900 cfm against a 5.0 inch static pressure. That fan, however, will move 8000 cfm at 2.5 inches of static pressure. Two 5 hp axial fans hooked in series will be able to move about 8000 cfm against 5.0 inches of static pressure.

Remember that a 10 hp LSC fan will deliver about 9550 cfm at 5 inches of static pressure.

**Caution:** Be sure to use the manufacturer's data for the specific fan you are using or plan to use. The fan diameter, speed, horsepower and the static pressure all affect the fan performance.

## Selecting a Heater

The amount of heat required to heat the drying air can be determined from the equation:  $\text{BTU/hr} = \text{cfm} \times 1.10 \times \text{temperature increase desired}$ . If we want to increase the temperature of 4364 cfm of air from the preceding example 10F, we would need a heater capable of delivering about 48,004 BTU/hr ( $4364 \times 1.10 \times 10$ ).

1 gallon propane = 88,000 BTU

1 KWH = 3413 BTU/hr

Approximately 30 percent of the energy is lost in a heat exchanger dryer where the combustion gases and heated air heat an exchanger that heats the drying air. Approximately 10 percent of the energy is lost in a direct-fired dryer where the combustion gases go through the grain being dried. All the energy enters the grain as heat from an electric heating element.

The calculated heat requirement needs to be adjusted based on the heating efficiency. The actual

heat requirement for a direct fired dryer would be about 1.10 x the calculated value. For the preceding example, the heat needed considering the 10 percent heat loss would be  $48,004 \times 1.10 = 52,804$  BTU/hr.

In a natural air drying system, the heat requirement comes from the air and to a limited extent from the energy supplied by the fan motor if the air passes over the motor. With a heated air system, the heat can be supplied from an electric heater, a LP gas burner, a fuel oil burner, from coal or wood, burning crop residue, or a solar collector. The LP gas burner and electric heater are the most common types.

Research on solar heating for grain drying has been primarily on low temperature systems to minimize the cost of the collector. To dry 1000 pounds of sunflower from 18 percent to 8 percent in one hour requires the removal of about 109 pounds of water. Using 3000 BTU/pound of water removed, a typical energy requirement for a high temperature continuous flow dryer, means that 327,000 BTUs of energy must be supplied. A solar collector with an area of at least 3,800 square feet, 5 x 760 ft., would be required to provide the heat. The maximum solar energy reaching the earth's surface at solar noon during the harvest season is about 290 BTU/hr per square foot of solar collector. Since solar collectors are only about 30 percent efficient when heating air 100F, only 87 BTU/hr per square foot are captured. At solar noon,  $327,000 \text{ BTU/hr} \div 87 \text{ BTU/hr} - \text{sq. foot} = 3759$  square feet of collector is required. Less heat would be collected at other times because the solar energy reaching the collector decreases to zero at sunset. With a low temperature drying system, a much smaller collector can be used since the heating needs are spread over a much longer time period.

Information on solar collector and grain drying systems are available in Midwest Plan Service Handbook MWPS-22, "Low Temperature and Solar Grain Drying."

Biomass burners are another option. A pound of dry crop residue or wood contains about 7,000 BTUs of heat. Generally a biomass dryer will use a heat exchanger with an efficiency of about 70 percent. Therefore, to provide the heat for the

preceding example using a biomass type dryer would require about 67 pounds of dry crop residue or wood per hour,  $327,000 \div 0.70 \div 7000 = 66.7$ .

## Drying System Cost

The cost of drying systems fluctuate with dryer, energy and other prices so actual values will not be given. Generally, the less supplemental heat required, the less expensive the system will be. However, the speed of drying will be slower. Several items must be considered to calculate the cost of a drying system. These would include ownership costs such as interest, depreciation and insurance, and operating expenses such as fuel and electricity. The labor required and the amount of grain to be dried are also important factors to consider. For more information request the NDSU Extension Circular AE-923 Calculating Grain Drying Cost.

## Grain Handling Systems

The addition of grain drying to a farm operation will normally increase the grain handling required. Increased handling makes hopper type storage structures and good handling equipment more important.

Handling the grain can be done by portable equipment, permanent equipment or a combination. When using portable conveyors, circular bin arrangements are satisfactory, enabling one conveyor to reach all the bins from the center of the

bin circle. However, if permanently installed handling equipment is planned, a straight-line arrangement is more suitable. Straight-line bin arrangements lend themselves more readily to drive through unloading facilities, ease of expansion, and efficient use of permanently installed loading and unloading equipment.

In planning, it is necessary to consider the grain flow pattern. This needs to include the time factor as well as where the grain goes. For example, when using a portable batch or continuous flow dryer, both wet and dried grain holding bins are necessary to enable efficient use of the dryer. Generally speaking, the continuous flow drying process requires a more complex grain handling system than the batch system. The batch drying system requires larger equipment since large quantities of grain are handled in fairly short periods of time.

Several factors need to be considered in selecting equipment. Table 11 lists some information on bins and Table 12 lists information on conveyors.

Four types of grain handling systems for drying are shown in Figures 16, 17, 18 and 19. Figure 16 uses portable augers for conveying grain into a drying bin. The batch-in-bin dryer in Figure 17 is contained in a circular bin arrangement. Figure 18 shows a system for a continuous flow dryer, and Figure 19 shows a completely mechanized grain handling-drying system using permanently installed equipment. Table 13 shows the dimensions for a circular bin arrangement for some bin diameters.

**Table 11. Bin Types, Sizes and Uses.**

Description	Grade Level Discharge Flat Bottom Bin	Grade Level Discharge Hopper Bottom Bin	Overhead, or Elevated-Discharge Hopper Bottom Bin
Name	Storage Bin	Bulk Bin	Work Bin
Use Pattern	Usually fill once per year & unload over a relatively long time period.	Fill & unload many times/year; generally weekly to monthly	Fill & unload daily. Value is in choke-fed gravity flow.
Size (Relative)	Large 1000's of bushels or 100's of tons	Medium 3-30 Tons; can be large & storage bins	Small 1/4-2 Tons

**Table 12. Conveyor Types.**

Type of Conveyor	Type of Material	Capacity	Horsepower Requirement	Cost	Advantages	Disadvantages
Screw (Auger)	ground granular or chopped	medium	low to medium	medium	1-can be used as mixer or for uniform flow feeder 2-good for unloading bulk storage 3-wide range available	1-size of material limited 2-single sections limited in length 3-medium to heavy wear factor
Bucket	ground granular or lumpy	medium to high	low	medium to high	1-efficient 2-high capacity for vertical lift	1-limited speed range 2-difficult to erect 3-expensive
Belt	beans grain	high	low	high	1-can be used for long distances 2-low power requirement	1-limited in angle of elevation 2-expensive
Pneumatic	grain ground feed, chopped forage	variable	high	medium to high	1-flexibility of installation 2-easily cleaned 3-mechanical parts at ground level	1-high power requirement 2-conditions of operation vary with type of material 3-noisy
Mass Flow	grain granular	medium to high	low	high	1-nearly self cleaning 2-reliable	1-expensive 2-some types can only operate on small inclines

More information on handling systems is available in Midwest Plan Service Handbook MWPS-13, "Grain Drying, Handling and Storage Handbook," available from Extension Agricultural Engineering, P.O. Box 5626, Fargo, ND 58105.

## Safety Considerations

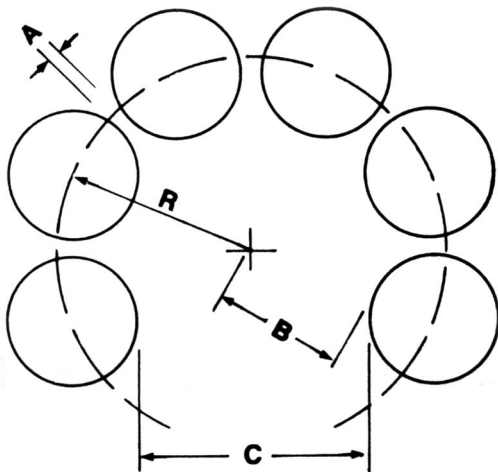
Safety should be a part of all grain drying and handling operations. Use proper shielding of all moving parts. Avoid high voltage power lines when locating or moving equipment. Contact your electric power supplier before constructing a grain drying system for assistance with electric service.

Bottom unloading equipment and grain bins have a special suffocation hazard. As this equipment is unloaded, the grain flows off the top and down the center withdrawal cone. Anyone entering the withdrawal cone will be pulled down and may suffocate if they become covered. The only way to prevent this type of accident is to be absolutely sure no one is inside a grain bin, hopper bottom bin, truck box, or wagon when unloading takes place.

## Managing Stored Grain

For best results in storing dried grain, an accurate moisture test is needed to determine that the grain is dry and an aeration system is necessary for controlling grain temperature. The drying fan can be used for cooling if the grain is stored in the bin in which it is dried. If the grain is placed into a different bin, it should be equipped with an aeration system to control grain temperature during storage. It is imperative that the grain be cooled during storage to control insects and reduce moisture migration. Request NDSU Extension Circular AE-791, "Crop Storage Management," for grain storage management and aeration system design and operation information.

**Table 13. Dimensions for Circular Bin Arrangements.**



Circular bin arrangement working from center filling location.  
 R = radius from central dump to center of bins  
 A = distance between bins  
 B = distance from inside of bin to central dump  
 C = opening for back-in, the number listed is an approximate figure  
 All numbers are in feet

18 Ft. Diameter Bins				
No. of Bins	6	8	7	9
R	26	32	30	35
A	2	2	2	2
B	17	23	21	26
C	35	35	35	35
Min. Auger Length	36	40	41	45
Bin Height	24	24	28	28
21 Ft. Diameter Bins				
No. of Bins	6	8	6	8
R	29	36	29	36
A	2	2	2	2
B	18.5	25.5	18.5	25.5
C	35	35	35	35
Min. Auger Length	38	44	41	46
Bin Height	24	24	28	28
24 Ft. Diameter Bins				
No. of Bins	5	7	5	7
R	28	36	30	36
A	2	2	2	2
B	16	24	18	24
C	30	30	30	30
Min. Auger Length	37	43	41	46
Bin Height	24	24	28	28
27 Ft. Diameter Bins				
No. of Bins	5	7	5	7
R	30	39	30	39
A	2	2	2	2
B	16.5	25.5	16.5	25.5
C	30	30	30	30
Min. Auger Length	39	46	41	48
Bin Height	24	24	28	28

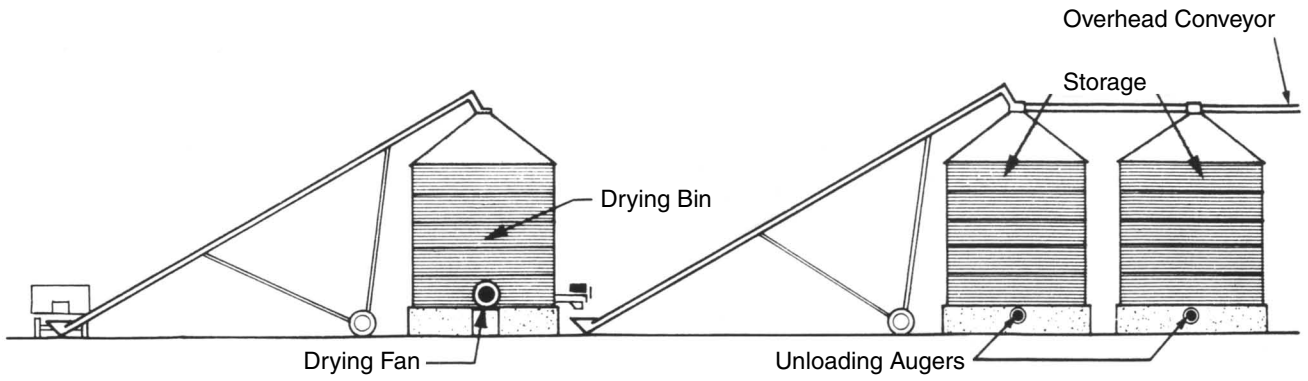
## Other Drying and Storage Information Available

Other information on grain drying and storage is available from the county extension offices and from Extension Agricultural Engineering at North Dakota State University. Some of the literature available is listed below. Many plans are also available.

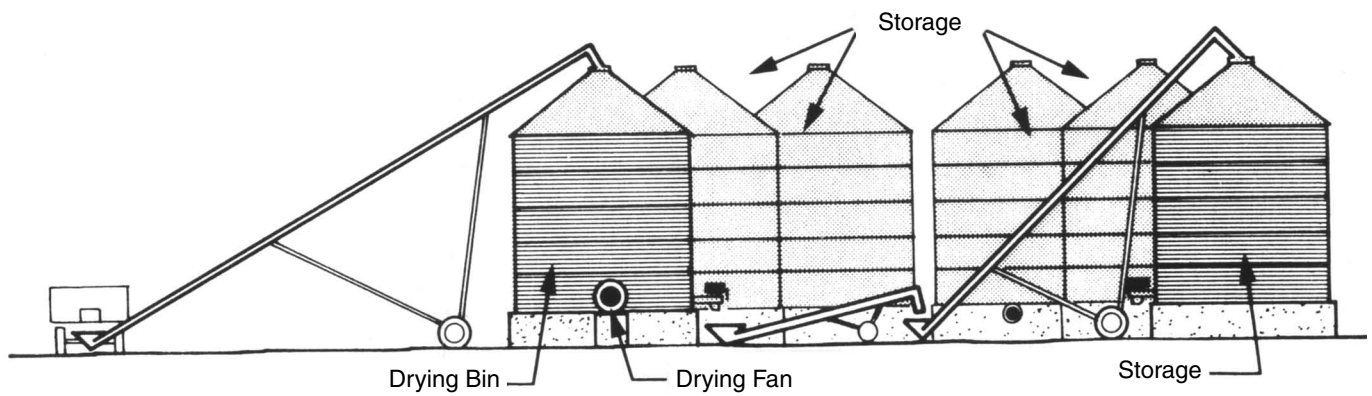
- AE791 Crop Storage Management
- AE808 Crop Dyeration and In-Storage Cooling
- AE850 Pneumatic Grain Conveyors
- AE905 Grain Moisture Content Effects and Management
- AE84 Temporary Grain Storage on the Farm
- AE93 Approved Seed Cleaning Plants
- AE94 Grain Drying Tables
- AE923 Calculating Grain Drying Cost
- AE945 Equivalent Weights of Grain and Oilseeds
- AE1044 Grain Stream Sampling and Sampler Construction
- EB35 Natural Air/Low Temperature Crop Drying
- EB45 Insect Pest Management for Farm Stored Grain
- EC801 Determining Grain Storage Cost
- MWPS-13 Grain Drying, Handling and Storage Handbook
- MWPS-22 Low Temperature and Solar Grain Drying Handbook
- NCH-14 Energy Conservation and Alternative Energy Sources for Corn Drying

**A bin full of grain represents a substantial cash value.**

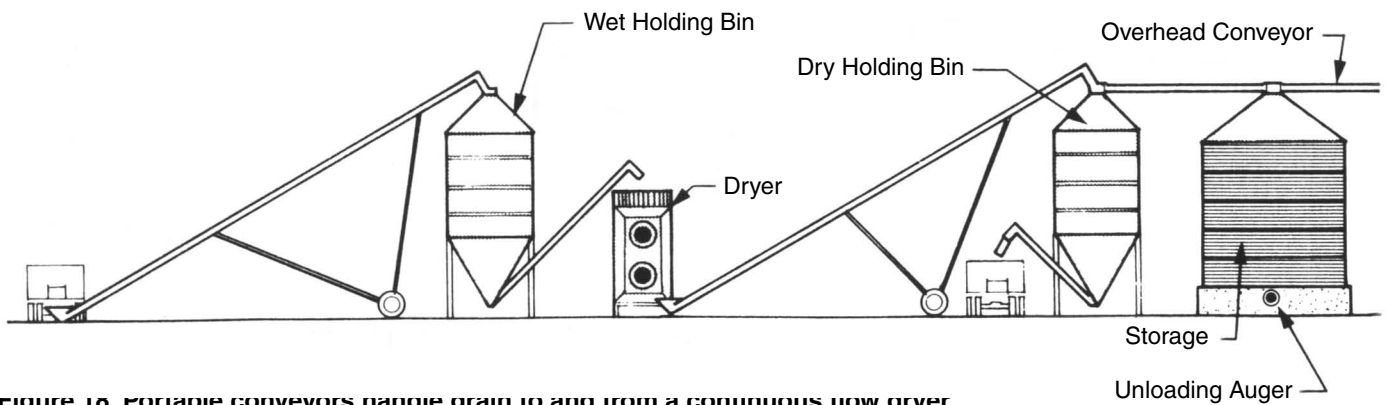
**Avoid loss with regular checking.**



**Figure 16. Handling system for a bin dryer using portable augers. Overhead conveyors connect to several storage bins.**

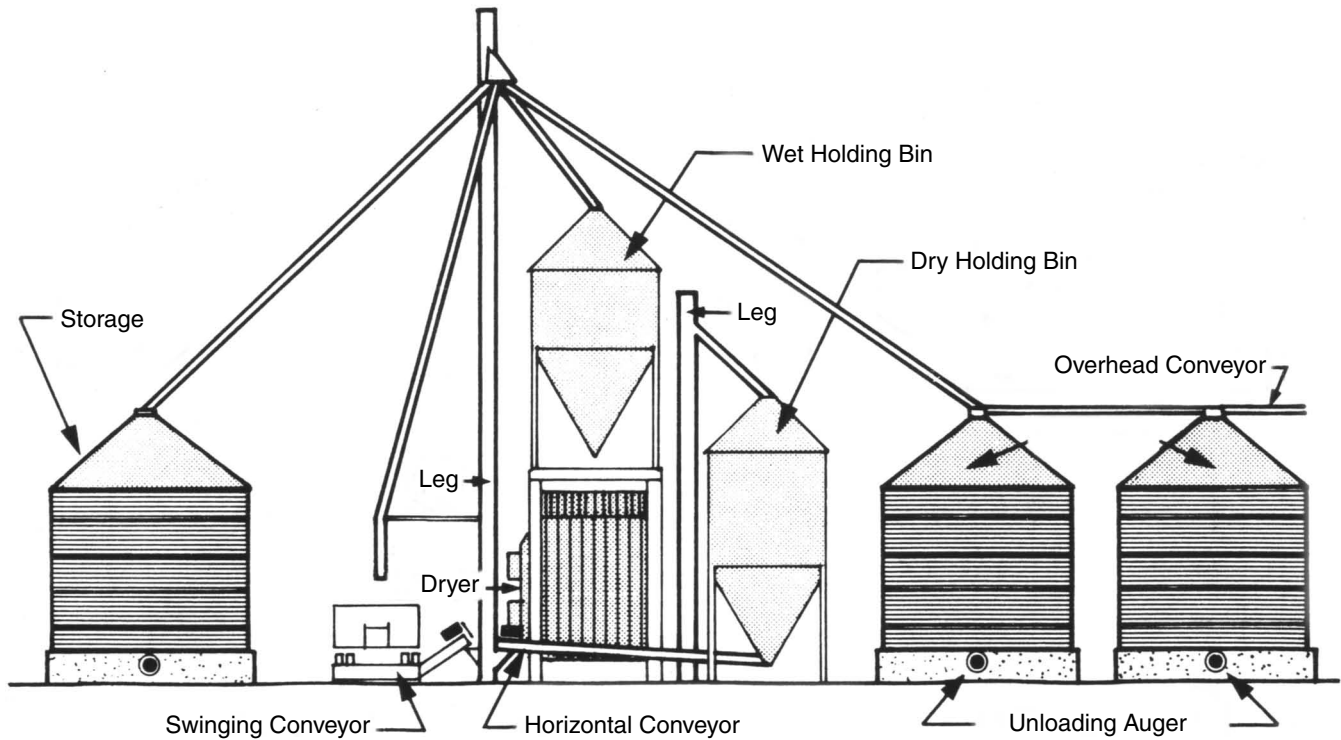


**Figure 17. Circular bin arrangement for use with portable conveyors.**



**Figure 18. Portable conveyors handle grain to and from a continuous flow dryer.**





**Figure 19. A completely mechanized grain handling-drying system using all permanently installed handling equipment.**

The NDSU Extension Service does not endorse commercial products or companies even though reference may be made to tradenames, trademarks or service names.

NDSU encourages you to use and share this content, but please do so under the conditions of our Creative Commons license. You may copy, distribute, transmit and adapt this work as long as you give full attribution, don't use the work for commercial purposes and share your resulting work similarly. For more information, visit [www.ag.ndsu.edu/agcomm/creative-commons](http://www.ag.ndsu.edu/agcomm/creative-commons).

**For more information on this and other topics, see [www.ag.ndsu.edu](http://www.ag.ndsu.edu)**

County commissions, North Dakota State University and U.S. Department of Agriculture cooperating. North Dakota State University does not discriminate on the basis of age, color, disability, gender expression/identity, genetic information, marital status, national origin, public assistance status, race, religion, sex, sexual orientation, or status as a U.S. veteran. Direct inquiries to the Vice President for Equity, Diversity and Global Outreach, 205 Old Main, (701) 231-7708. This publication will be made available in alternative formats for people with disabilities upon request, (701) 231-7881.