

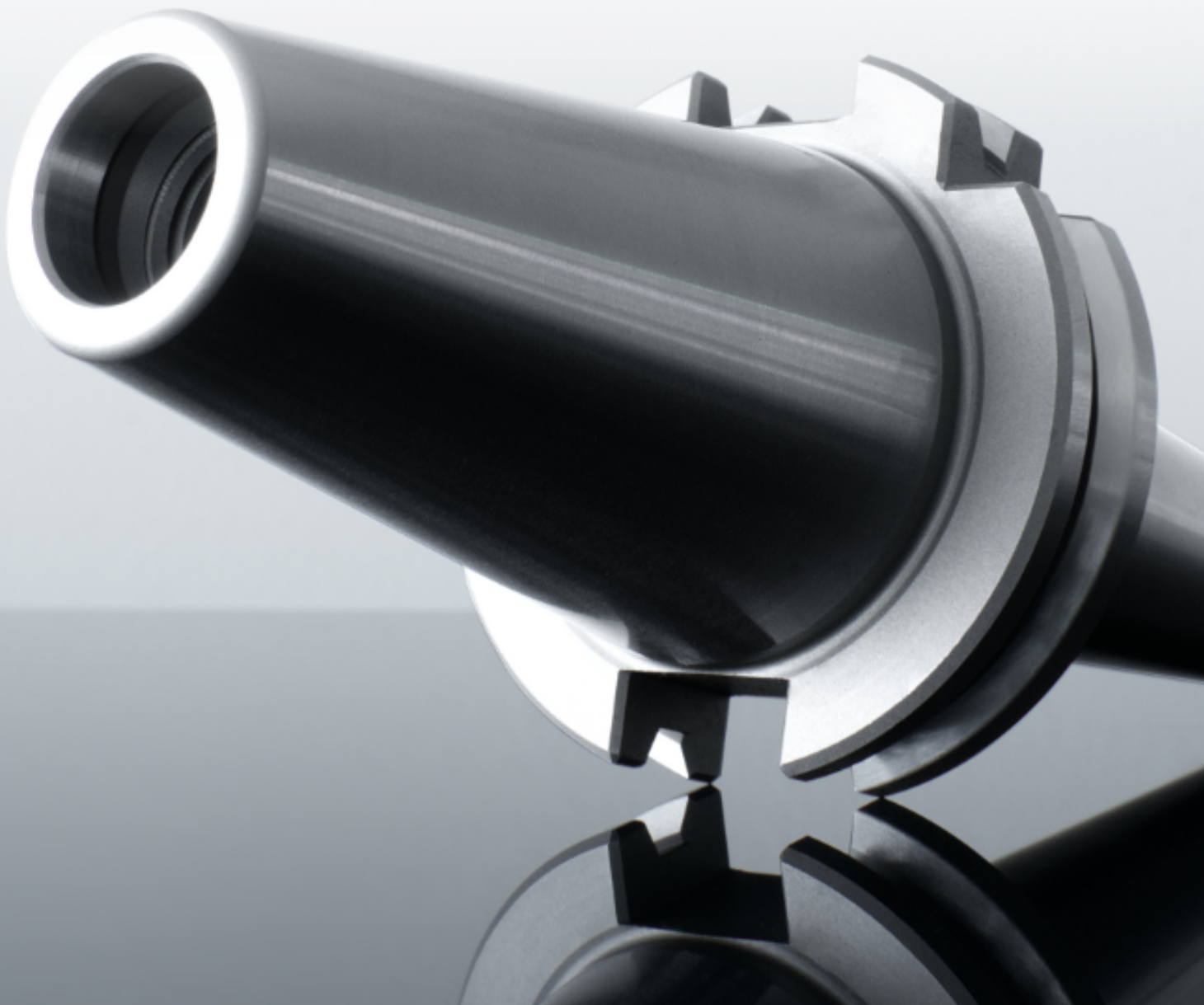

Tool holders
DIN ISO 7388-1 (DIN 69871)

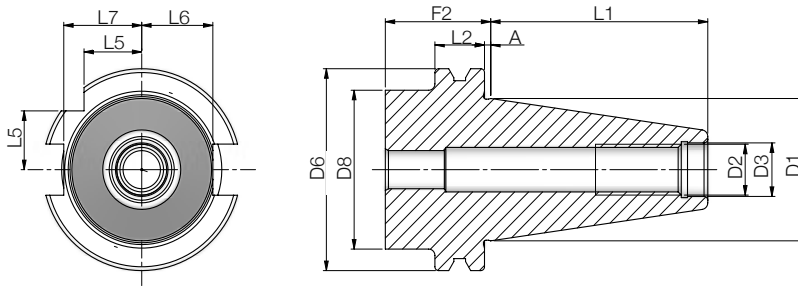





DIN 69871 A/AD

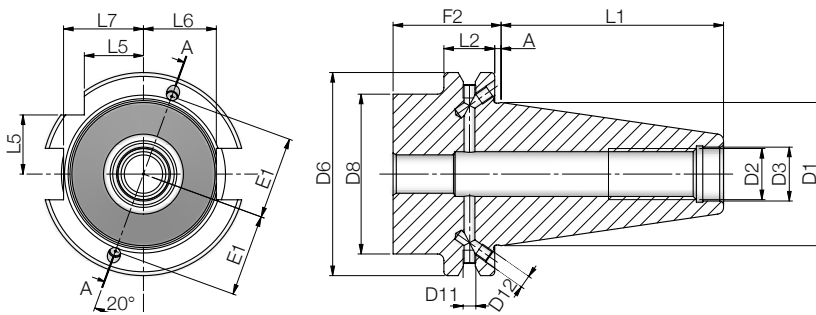

DIN 69871 AD+B

Cone	D1	D2	D3	D6	D8	D11	D12	L1	L2	L5	L6	L7	A	E1	F2
30	31.75	M12	13	50	<45	-	-	47.80	15.90	15.00	16.40	19.00	3.20	21	Min.35
40	44.45	M16	17	63.55	<50	M4	M4	68.40	15.90	18.50	22.80	25.00	3.20	27	Min.35
50	69.85	M24	25	97.50	<80	M4	M6	101.75	15.90	30.00	35.50	35.70	3.20	42	Min.35

Material: Case hardened steel with min. 900 N/mm² of tensile strength in core.

Execution: Case hardened 58±2 Hrc. Depth of case 0.6 - 0.8 mm. Black oxidised.

Accuracy: Taper angle AT3 quality class or better. Roughness Ra < 0.2

All dimensions in this catalogue are in millimeters unless otherwise specified.

Key benefits of THERMO Shrink-fit:

Unlike more traditional tool clamping systems, Shrink-fit toolholding employs heating and cooling properties of steel in order to achieve superior clamping force.

Inside diameter of the toolholder is precisely manufactured to be slightly smaller than the shank diameter of the cutting tool at the room temperature.

Using shrink-fit machine, heat is applied to the toolholder allowing it to expand so that the cutting tool can fit in. Upon cooling down, toolholder contracts to its original dimension the cutting tool.

This clamping system allows for certain benefits not found in more traditional clamping:

- **Superior tool runout** - monobloc toolholder, without clamping elements (bolts, nuts, etc.)
- **Higher rigidity** - tool shank is gripped 360 deg., through the whole bore length
- **Straightforward operation** - fast tool change, less accessories required
- **Increased tool life** - better chip load distribution along the cutting edge
- **Easier workpiece approach** - thinner profile, reduced nose diameter, various toolholder lengths
- **Enhanced reach** - with use of cylindrical shrink fit extensions
- **Internal coolant supply** - delivering coolant through the toolholder to the tool edge for better chip removal and superior surface finish.
 - Coolant ports sealable using M4 screws.
 - High pressure nozzles for better coolant direction at higher rpm.
- **Extended spindle life** - tool holders fine balanced G2.5 at 25 000 rpm or more.
- **Costs saving** - higher machine productivity due to stable operation, increased feeds and speeds and cutting depths.

SAB has two decades worth of experience in supplying customers around the world with only top-quality Shrink fit toolholders.

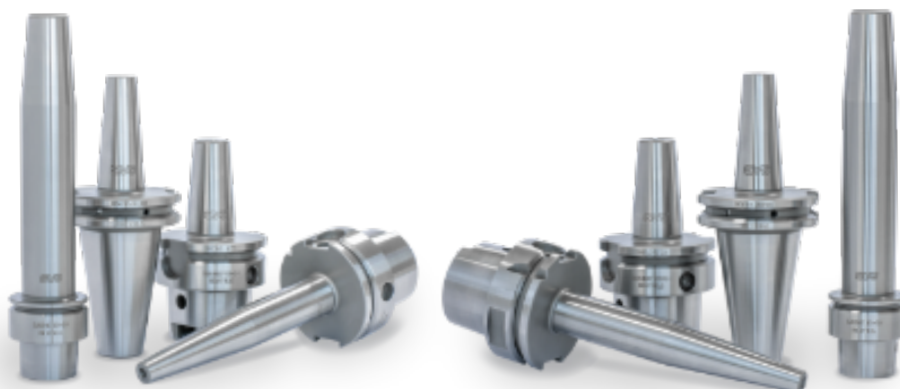

THERMO Shrink-fit chucks

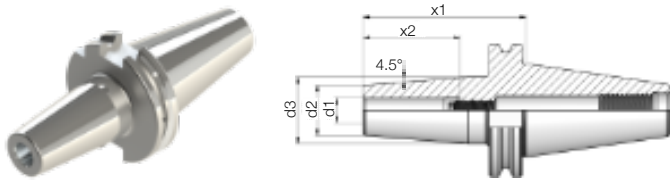
Radial runout $\leq 0,003$ mmG2.5 at 25 000 min⁻¹

d1	d2	d3	x1	x2	Code
3	9	16	80	-	SF03.D30.080
3	9	16	120	-	SF03.D30.120
3	9	22	160	-	SF03.D30.160
4	10	17	80	-	SF04.D30.080
4	10	17	120	-	SF04.D30.120
4	10	22	160	-	SF04.D30.160
5	11	18	80	-	SF05.D30.080
5	11	18	120	-	SF05.D30.120
5	11	22	160	-	SF05.D30.160
6	21	27	80	36	SF06.D30.080
6	21	27	120	36	SF06.D30.120
6	21	27	160	36	SF06.D30.160
8	21	27	80	36	SF08.D30.080
8	21	27	120	36	SF08.D30.120
8	21	27	160	36	SF08.D30.160
10	24	32	80	42	SF10.D30.080
10	24	32	120	42	SF10.D30.120
10	24	32	160	42	SF10.D30.160
12	24	32	80	47	SF12.D30.080
12	24	32	120	47	SF12.D30.120
12	24	32	160	47	SF12.D30.160
14	27	34	80	47	SF14.D30.080
14	27	34	120	47	SF14.D30.120
14	27	34	160	47	SF14.D30.160
16	27	34	80	50	SF16.D30.080
16	27	34	120	50	SF16.D30.120
16	27	34	160	50	SF16.D30.160
18	33	42	80	50	SF18.D30.080
18	33	42	120	50	SF18.D30.120
18	33	42	160	50	SF18.D30.160
20	33	42	80	52	SF20.D30.080
20	33	42	120	52	SF20.D30.120
20	33	42	160	52	SF20.D30.160

30
Form AD

THERMO Shrink-fit chucks

Radial runout $\leq 0,003$ mm

G2.5 at 25 000 min⁻¹

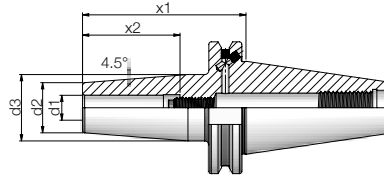

	d1	d2	d3	x1	x2	Code
<div style="background-color: #0056b3; color: white; padding: 5px; display: inline-block; text-align: center;"> 40 Form AD+B </div>	3	9	16	80	-	SF03.D44.080
	3	9	16	120	-	SF03.D44.120
	3	9	22	160	-	SF03.D44.160
	4	10	17	80	-	SF04.D44.080
	4	10	17	120	-	SF04.D44.120
	4	10	22	160	-	SF04.D44.160
	5	11	18	80	-	SF05.D44.080
	5	11	18	120	-	SF05.D44.120
	5	11	22	160	-	SF05.D44.160
	6	21	27	80	36	SF06.D44.080
	6	21	27	120	36	SF06.D44.120
	6	21	27	160	36	SF06.D44.160
	8	21	27	80	36	SF08.D44.080
	8	21	27	120	36	SF08.D44.120
	8	21	27	160	36	SF08.D44.160
	10	24	32	80	42	SF10.D44.080
	10	24	32	120	42	SF10.D44.120
	10	24	32	160	42	SF10.D44.160
	12	24	32	80	47	SF12.D44.080
	12	24	32	120	47	SF12.D44.120
	12	24	32	160	47	SF12.D44.160
	14	27	34	80	47	SF14.D44.080
	14	27	34	120	47	SF14.D44.120
	14	27	34	160	47	SF14.D44.160
	16	27	34	80	50	SF16.D44.080
	16	27	34	120	50	SF16.D44.120
	16	27	34	160	50	SF16.D44.160
	18	33	42	80	50	SF18.D44.080
	18	33	42	120	50	SF18.D44.120
	18	33	42	160	50	SF18.D44.160
	20	33	42	80	52	SF20.D44.080
	20	33	42	120	52	SF20.D44.120
20	33	42	160	52	SF20.D44.160	
25	44	53	100	58	SF25.D44.100	
25	44	53	160	58	SF25.D44.160	
25	44	53	200	58	SF25.D44.200	
32	44	53	100	63	SF32.D44.100	
32	44	53	160	63	SF32.D44.160	
32	44	53	200	63	SF32.D44.200	

3° THERMO Shrink-fit chucks

Slim execution

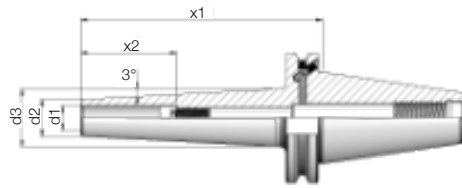

Radial runout $\leq 0,003$ mm

G2.5 at 25 000 min⁻¹

d1	d2	d3	x1	x2	Code
3	9	15	80	-	SF03.D44.080.3
3	9	19	120	-	SF03.D44.120.3
3	9	23	160	-	SF03.D44.160.3
4	10	16	80	-	SF04.D44.080.3
4	10	20	120	-	SF04.D44.120.3
4	10	24	160	-	SF04.D44.160.3
5	11	17	80	-	SF05.D44.080.3
5	11	21	120	-	SF05.D44.120.3
5	11	25	160	-	SF05.D44.160.3
6	12	18	80	36	SF06.D44.080.3
6	12	22	120	36	SF06.D44.120.3
6	12	26	160	36	SF06.D44.160.3
8	14	20	80	36	SF08.D44.080.3
8	14	24	120	36	SF08.D44.120.3
8	14	28	160	36	SF08.D44.160.3
10	16	22	80	42	SF10.D44.080.3
10	16	26	120	42	SF10.D44.120.3
10	16	30	160	42	SF10.D44.160.3
12	18	24	80	47	SF12.D44.080.3
12	18	28	120	47	SF12.D44.120.3
12	18	32	160	47	SF12.D44.160.3
16	24	30	80	47	SF16.D44.080.3
16	24	34	120	47	SF16.D44.120.3
16	24	38	160	47	SF16.D44.160.3

40
Form AD+B

“3-in-1” THERMO Shrink-fit chucks

Internal coolant supply

Radial runout $\leq 0,003$ mm

G2.5 at 25 000 min⁻¹

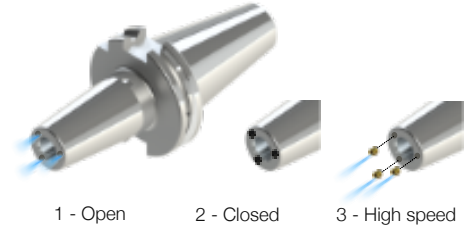
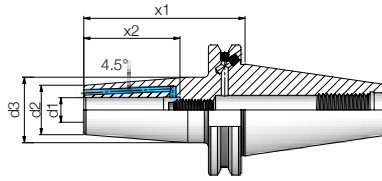

40
Form AD+B

	d1	d2	d3	x1	x2	Code
	6	21	27	80	36	SF06.D44.080.IK
	6	21	27	120	36	SF06.D44.120.IK
	8	21	27	80	36	SF08.D44.080.IK
	8	21	27	120	36	SF08.D44.120.IK
	10	24	32	80	42	SF10.D44.080.IK
	10	24	32	120	42	SF10.D44.120.IK
	12	24	32	80	47	SF12.D44.080.IK
	12	24	32	120	47	SF12.D44.120.IK
	14	27	34	80	47	SF14.D44.080.IK
	14	27	34	120	47	SF14.D44.120.IK
	16	27	34	80	50	SF16.D44.080.IK
	16	27	34	120	50	SF16.D44.120.IK
	18	33	42	80	50	SF18.D44.080.IK
	18	33	42	120	50	SF18.D44.120.IK
	20	33	42	80	52	SF20.D44.080.IK
	20	33	42	120	52	SF20.D44.120.IK
	25	44	53	100	58	SF25.D44.100.IK
	32	44	53	100	63	SF32.D44.100.IK

Including high speed nozzles and sealing plugs

Extended "3-in-1" THERMO Shrink-fit chucks

Internal coolant supply

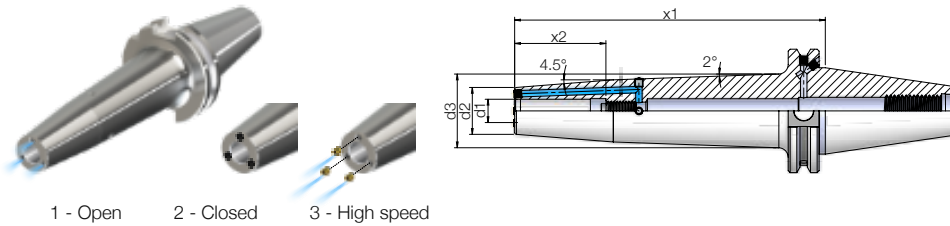

Radial runout $\leq 0,003$ mm

G2.5 at 25 000 min⁻¹

d1	d2	d3	x1	x2	Code
6	21	34	160	36	SF06.D44.160.IK
6	21	37	200	36	SF06.D44.200.IK
8	21	34	160	36	SF08.D44.160.IK
8	21	37	200	36	SF08.D44.200.IK
10	24	38	160	42	SF10.D44.160.IK
10	24	41	200	42	SF10.D44.200.IK
12	24	38	160	47	SF12.D44.160.IK
12	24	41	200	47	SF12.D44.200.IK
14	27	40.5	160	47	SF14.D44.160.IK
14	27	43.5	200	47	SF14.D44.200.IK
16	27	40.5	160	50	SF16.D44.160.IK
16	27	43.5	200	50	SF16.D44.200.IK
18	33	48	160	50	SF18.D44.160.IK
18	33	51	200	50	SF18.D44.200.IK
20	33	48	160	52	SF20.D44.160.IK
20	33	51	200	52	SF20.D44.200.IK
25	44	53	160	58	SF25.D44.160.IK
25	44	53	200	58	SF25.D44.200.IK
32	44	53	160	63	SF32.D44.160.IK
32	44	53	200	63	SF32.D44.200.IK

40
Form AD+B

Including high speed nozzles and sealing plugs

Vibration-dampening tapered profile

THERMO Shrink-fit chucks

Compact execution

Radial runout $\leq 0,003$ mm

G2.5 at 25 000 min⁻¹

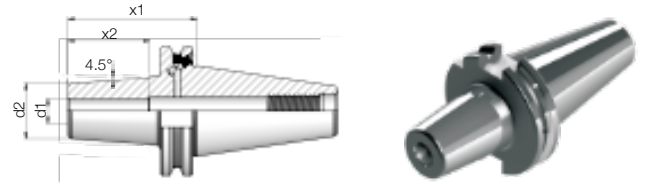

40
Form AD+B

d1	d2	x1	x2	Code
3	9	65	-	SF03.D44.065
4	10	65	-	SF04.D44.065
5	11	65	-	SF05.D44.065
6	20	65	36	SF06.D44.065
8	20	65	36	SF08.D44.065
10	24	65	42	SF10.D44.065
12	27	65	47	SF12.D44.065
14	33	70	47	SF14.D44.070
16	33	70	50	SF16.D44.070
18	44	70	50	SF18.D44.070
20	44	70	50	SF20.D44.070
25	46	70	56	SF25.D44.070
32	47	75	58	SF32.D44.075

End mill holders

Slim execution

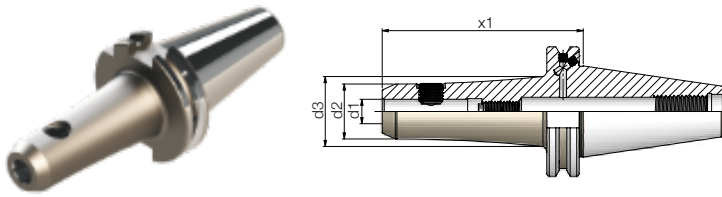
Radial runout $\leq 0,003$ mmG2.5 at 25 000 min⁻¹

d1	d2	d3	x1	Code
6	17	25	100	WE06.D44.100F
6	17	30	130	WE06.D44.130F
6	17	31	160	WE06.D44.160F
8	21	29	100	WE08.D44.100F
8	21	35	130	WE08.D44.130F
8	21	35	160	WE08.D44.160F
10	24	32	100	WE10.D44.100F
10	24	37	130	WE10.D44.130F
10	24	38	160	WE10.D44.160F
12	27	35	100	WE12.D44.100F
12	27	40	130	WE12.D44.130F
12	27	41	160	WE12.D44.160F
14	29	37	100	WE14.D44.100F
14	29	42	130	WE14.D44.130F
14	29	43	160	WE14.D44.160F
16	33	41	100	WE16.D44.100F
16	33	46	130	WE16.D44.130F
16	33	47	160	WE16.D44.160F
18	35	43	100	WE18.D44.100F
18	35	48	130	WE18.D44.130F
18	35	49	160	WE18.D44.160F
20	39	47	100	WE20.D44.100F
20	39	50	130	WE20.D44.130F
20	39	50	160	WE20.D44.160F
25	47	47	100	WE25.D44.100F
25	47	47	130	WE25.D44.130F
25	47	47	160	WE25.D44.160F
32	57	57	100	WE32.D44.100F
32	57	57	130	WE32.D44.130F
32	57	57	160	WE32.D44.160F

40
Form AD+B

End mill holders

Radial runout $\leq 0,003$ mm
 G6.3 at 25 000 min⁻¹

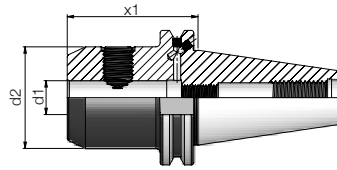

	d1	d2	x1	Code
40 Form AD+B	6	25	50	WE06.D44.050
	6	25	100	WE06.D44.100
	6	25	120	WE06.D44.120
	6	25	160	WE06.D44.160
	6	25	200	WE06.D44.200
	8	28	50	WE08.D44.050
	8	28	100	WE08.D44.100
	8	28	120	WE08.D44.120
	8	28	160	WE08.D44.160
	8	28	200	WE08.D44.200
	10	35	50	WE10.D44.050
	10	35	100	WE10.D44.100
	10	35	120	WE10.D44.120
	10	35	160	WE10.D44.160
	10	35	200	WE10.D44.200
	12	42	50	WE12.D44.050
	12	42	100	WE12.D44.100
	12	42	120	WE12.D44.120
	12	42	160	WE12.D44.160
	12	42	200	WE12.D44.200
14	44	50	WE14.D44.050	
14	44	100	WE14.D44.100	
14	44	120	WE14.D44.120	
14	44	160	WE14.D44.160	
14	44	200	WE14.D44.200	
16	48	35	WE16.D44.035	
16	48	63	WE16.D44.063	
16	48	100	WE16.D44.100	
16	48	120	WE16.D44.120	
16	48	160	WE16.D44.160	
16	48	200	WE16.D44.200	

End mill holders

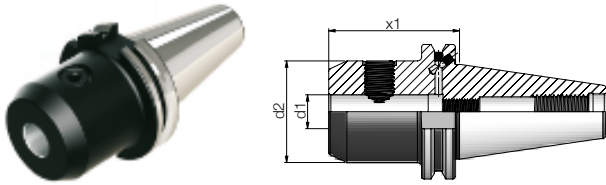
Radial runout $\leq 0,003$ mmG6.3 at 25 000 min⁻¹

d1	d2	x1	Code
18	50	63	WE18.D44.063
18	50	100	WE18.D44.100
18	50	120	WE18.D44.120
18	50	160	WE18.D44.160
18	50	200	WE18.D44.200
20	50	35	WE20.D44.035
20	52	63	WE20.D44.063
20	52	100	WE20.D44.100
20	52	120	WE20.D44.120
20	52	160	WE20.D44.160
20	52	200	WE20.D44.200
25	50	35	WE25.D44.035
25	50	60	WE25.D44.060
25	65	100	WE25.D44.100
25	65	120	WE25.D44.120
25	65	160	WE25.D44.160
25	65	200	WE25.D44.200
32	50	45	WE32.D44.045
32	50	63	WE32.D44.063
32	72	100	WE32.D44.100
32	72	160	WE32.D44.160
32	72	200	WE32.D44.200
40	90	120	WE40.D44.120

40
 Form AD+B

End mill holders

Internal coolant supply

Radial runout $\leq 0,003$ mm

G6.3 at 25 000 min⁻¹

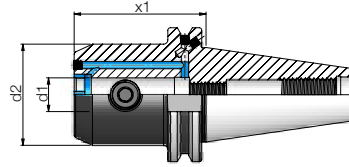

	d1	d2	x1	Code
<div style="background-color: #0056b3; color: white; padding: 5px; display: inline-block;"> 40 Form AD+B </div>	6	25	50	WE06.D44.050.IK
	6	25	100	WE06.D44.100.IK
	8	28	50	WE08.D44.050.IK
	8	28	100	WE08.D44.100.IK
	10	35	50	WE10.D44.050.IK
	10	35	100	WE10.D44.100.IK
	12	42	50	WE12.D44.050.IK
	12	42	100	WE12.D44.100.IK
	14	44	50	WE14.D44.050.IK
	14	44	100	WE14.D44.100.IK
	16	48	63	WE16.D44.050.IK
	16	48	100	WE16.D44.100.IK
	18	50	63	WE18.D44.050.IK
	18	50	100	WE18.D44.100.IK
	20	52	63	WE20.D44.050.IK
	20	52	100	WE20.D44.100.IK
25	65	100	WE25.D44.100.IK	
32	72	100	WE32.D44.100.IK	
40	90	120	WE40.D44.120.IK	

Collet chucks 1:10 for DIN6388 collets

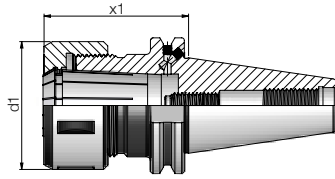
Radial runout $\leq 0,003$ mmG6.3 at 25 000 min⁻¹

Range	x1	d1	Code
1.5 - 16	70	43	SP16.D44.070
1.5 - 16	100	43	SP16.D44.100
1.5 - 16	160	43	SP16.D44.160
2 - 25	70	60	SP25.D44.070
2 - 25	100	60	SP25.D44.100
2 - 25	160	60	SP25.D44.160
4 - 32	80	72	SP32.D44.080
4 - 32	140	72	SP32.D44.140

40
Form AD+B

ER Collet chucks

Radial runout $\leq 0,003$ mm
 G6.3 at 25 000 min⁻¹

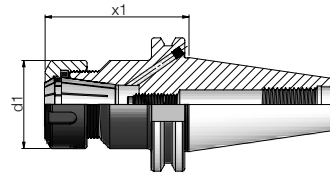

ER	Range	x1	d1	Code	
40 Form AD+B	16	0.5 - 10	63	28	ER16.D44.063
	16	0.5 - 10	100	28	ER16.D44.100
	16	0.5 - 10	130	28	ER16.D44.130
	16	0.5 - 10	160	28	ER16.D44.160
	16	0.5 - 10	200	28	ER16.D44.200
20	1 - 13	70	35	ER20.D44.070	
20	1 - 13	100	35	ER20.D44.100	
20	1 - 13	130	35	ER20.D44.130	
20	1 - 13	160	35	ER20.D44.160	
20	1 - 13	200	35	ER20.D44.200	
25	1 - 16	60	42	ER25.D44.060	
25	1 - 16	100	42	ER25.D44.100	
25	1 - 16	130	42	ER25.D44.130	
25	1 - 16	160	42	ER25.D44.160	
25	1 - 16	200	42	ER25.D44.200	
32	2 - 20	70	50	ER32.D44.070	
32	2 - 20	100	50	ER32.D44.100	
32	2 - 20	130	50	ER32.D44.130	
32	2 - 20	160	50	ER32.D44.160	
32	2 - 20	200	50	ER32.D44.200	
40	3 - 26	80	63	ER40.D44.080	
40	3 - 26	100	63	ER40.D44.100	
40	3 - 26	130	63	ER40.D44.130	
40	3 - 26	160	63	ER40.D44.160	
40	3 - 26	200	63	ER40.D44.200	

ER Collet chucks

Mini execution

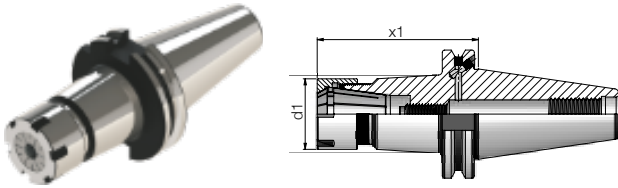
Radial runout $\leq 0,003$ mmG6.3 at 25 000 min⁻¹

ER	Range	x1	d1	Code
11	0.5 - 7	70	16	ER11.D44.070M
11	0.5 - 7	100	16	ER11.D44.100M
11	0.5 - 7	160	16	ER11.D44.160M
16	0.5 - 10	70	22	ER16.D44.070M
16	0.5 - 10	100	22	ER16.D44.100M
16	0.5 - 10	160	22	ER16.D44.160M
20	1 - 13	70	28	ER20.D44.070M
20	1 - 13	100	28	ER20.D44.100M
20	1 - 13	160	28	ER20.D44.160M
25	1 - 16	70	35	ER25.D44.070M
25	1 - 16	100	35	ER25.D44.100M
25	1 - 16	160	35	ER25.D44.160M

40
Form AD+B

Morse taper holders for drills

Radial runout $\leq 0,005$ mm
G6.3 at 25 000 min⁻¹

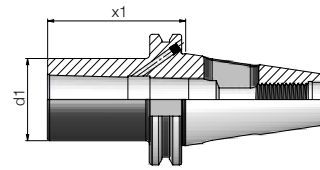

40 Form AD+B	MK	x1	d1	Code
	1	1	50	25
	1	100	25	MK1B.D40.100AD
	2	50	32	MK2B.D44.050
	2	116	32	MK2B.D40.116AD
	3	70	40	MK3B.D44.070
	3	136	40	MK3B.D40.136AD
	4	95	48	MK4B.D44.095
	4	167	48	MK4B.D40.167AD

Morse taper holders for mills

Radial runout $\leq 0,005$ mm
G6.3 at 25 000 min⁻¹

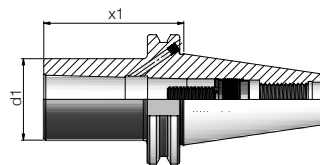

40 Form AD+B	MK	x1	d1	Code
	1	1	50	25
	2	50	32	MK2A.D44.050
	3	70	40	MK3A.D44.070
	4	95	48	MK4A.D44.095

Threaded shank milling cutter holders

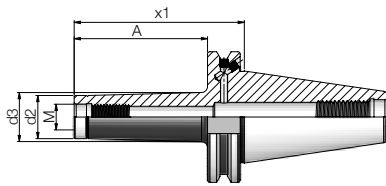
Radial runout $\leq 0,003$ mmG2.5 at 25 000 min⁻¹

M	A	x1	d2	d3	Code
M6	25	44	10	13	EF06.D44.044
M6	50	69	10	20	EF06.D44.069
M6	75	94	10	23	EF06.D44.094
M6	100	119	10	25	EF06.D44.119
M8	25	44	13	15	EF08.D44.044
M8	50	69	13	23	EF08.D44.069
M8	75	94	13	23	EF08.D44.094
M8	100	119	13	25	EF08.D44.119
M10	25	44	18	20	EF10.D44.044
M10	50	69	18	23	EF10.D44.069
M10	75	94	18	28	EF10.D44.094
M10	100	119	18	32	EF10.D44.119
M10	125	144	18	32	EF10.D44.144
M12	25	44	21	24	EF12.D44.044
M12	50	69	21	24	EF12.D44.069
M12	75	94	21	31	EF12.D44.094
M12	100	119	21	33	EF12.D44.119
M12	125	144	21	36	EF12.D44.144
M12	150	169	21	40	EF12.D44.169
M16	25	44	29	29	EF16.D44.044
M16	50	69	29	34	EF16.D44.069
M16	75	94	29	34	EF16.D44.094
M16	100	119	29	36	EF16.D44.119
M16	125	144	29	40	EF16.D44.144
M16	150	169	29	42.5	EF16.D44.169

40
Form AD+B

Combi shell mill holders for milling cutters

Radial runout $\leq 0,005$ mm
 G6.3 at 25 000 min⁻¹

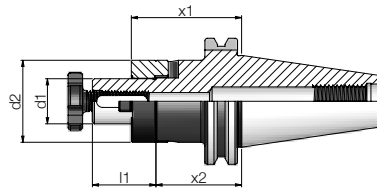

	d1	x1	x2	d2	l2	Code
40 Form AD	16	55	45	32	27	KD16.D40.055
	16	100	90	32	27	KD16.D40.100
	16	150	140	32	27	KD16.D40.150
	22	55	43	40	31	KD22.D40.055
	22	100	88	40	31	KD22.D40.100
	22	150	138	40	31	KD22.D40.150
	27	55	43	48	33	KD27.D40.055
	27	100	88	48	33	KD27.D40.100
	27	150	138	48	33	KD27.D40.150
	32	60	46	58	38	KD32.D40.060
	32	100	86	58	38	KD32.D40.100
	32	150	136	58	38	KD32.D40.150
	40	60	46	70	41	KD40.D40.060
	40	100	86	70	41	KD40.D40.100
	40	150	136	70	41	KD40.D40.150

Shell mill holders for cutters with driving slot

Internal coolant supply

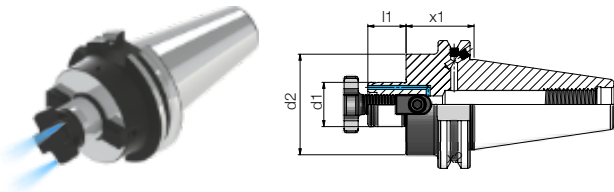

Radial runout $\leq 0,005$ mm

G6.3 at 25 000 min⁻¹

d1	x1	l1	d2	Code
16	35	17	38	AD16.D44.035
16	100	17	38	AD16.D44.100
16	130	17	38	AD16.D44.130
16	160	17	38	AD16.D44.160
16	200	17	38	AD16.D44.200
22	35	19	50	AD22.D44.035
22	100	19	50	AD22.D44.100
22	130	19	50	AD22.D44.130
22	160	19	50	AD22.D44.160
22	200	19	50	AD22.D44.200
27	35	21	50	AD27.D44.035
27	100	21	50	AD27.D44.100
27	130	21	50	AD27.D44.130
27	160	21	50	AD27.D44.160
27	200	21	50	AD27.D44.200
32	50	24	78	AD32.D44.050
32	100	24	78	AD32.D44.100
32	130	24	78	AD32.D44.130
32	160	24	78	AD32.D44.160
32	200	24	78	AD32.D44.200
40	50	27	89	AD40.D44.050
40	100	27	89	AD40.D44.100

40
Form AD+B

Holders for indexable inserts drills

Radial runout $\leq 0,005$ mm
G6.3 at 25 000 min⁻¹

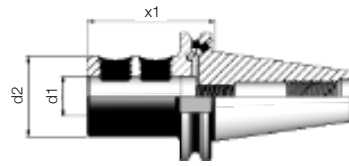

40 Form AD+B	d1	x1	d2	Code
	20	65	40	VB20.D44.065
	25	70	45	VB25.D44.070
	32	75	52	VB32.D44.075

Quick-change tapping heads

Length compensation in compression and tension.

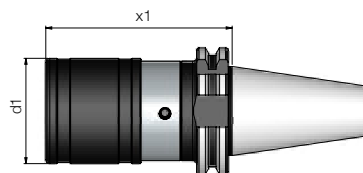

40 Form A	Tap size	Compensation	Insert size	x1	d1	Code
	M3 - M14	± 7.5	1	74	36	GN12.D40.074
	M6 - M24	± 12.5	2	98	53	GN20.D40.098
	M14 - M33	± 20.0	3	169	78	GN33.D40.169
	M22 - M48	± 22.5	4	185	96	GN48.D40.185

HV drill chucks for RH and LH rotation

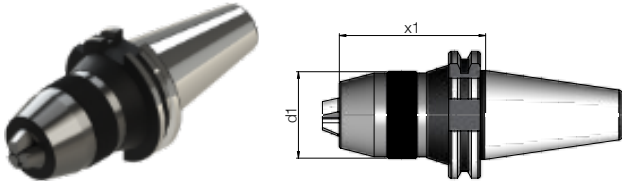

Radial runout $\leq 0,02$ mm
G2.5 at 25 000 min⁻¹

mm	x1	d1	Code
0.3 - 8	70	36	HV08.D40.070
0.5 - 13	76	44	HV13.D40.076
1 - 16	80	51	HV16.D40.080

40
Form AD

Integrated precision drill chuck with Hexagonal key lock.

For drilling, milling, reaming and tapping.

Through coolant.

Drill chuck slipping impossible due to chuck being screwed with the holder body.

Compact design, enhanced reach.

Range up to 8, 13 or 16 mm.

NC drill chucks for RH rotation

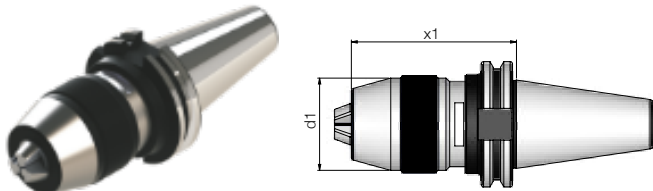

Special wrench supplied.
Radial runout $\leq 0,03$ mm
G6.3 at 12 000 min⁻¹

mm	x1	d1	Code
0 - 8	70	37	NC08.D40.070
0 - 10	74	43	NC10.D40.074
1 - 13	80	48	NC13.D40.080
3 - 16	97	53	NC16.D40.097

40
Form A

Integrated drill chuck with high clamping force achieved through special wrench.

2x chucking torque vs. hand tightening.

Drill bit slipping nearly impossible.

Drill chuck slipping impossible due to chuck being screwed with the holder body.

Compact design, external coolant supply.

Range up to 8, 10, 13 or 16 mm.

Blank bars

Cone and flange hardened and finished.
 Machineable soft body.
 Pre-balanced

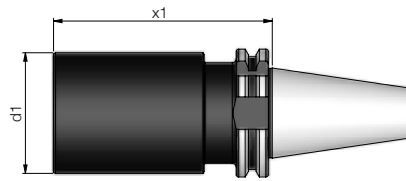

40
Form A

d1	x1	Code
63.5	160	RL63.D40.160
63.5	250	RL63.D40.250

Test bars

Radial runout $\leq 0,003$ mm
 Precisely ground length and diameter.
 Test certificate and protective case supplied.

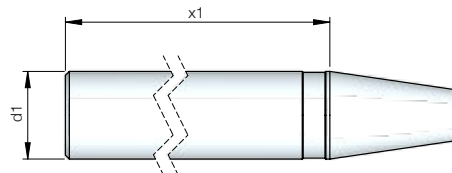

40
Form A

d1	x1	Code
40	250	TB40.D40.250



THERMO Shrink-fit chucks

Radial runout $\leq 0,003$ mm
 Balanced G2.5 at 25 000 min⁻¹

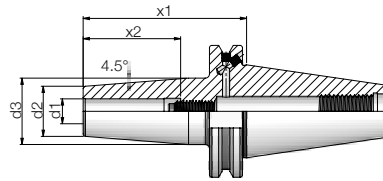

50
Form AD+B

d1	d2	d3	x1	x2	Code
3	9	18	80	-	SF03.D55.080
3	9	22	120	-	SF03.D55.120
3	9	22	160	-	SF03.D55.160
4	10	19	80	-	SF04.D55.080
4	10	22	120	-	SF04.D55.120
4	10	22	160	-	SF04.D55.160
5	11	20	80	-	SF05.D55.080
5	11	22	120	-	SF05.D55.120
5	11	22	160	-	SF05.D55.160
6	21	27	80	36	SF06.D55.080
6	21	27	120	36	SF06.D55.120
6	21	27	160	36	SF06.D55.160
8	21	27	80	36	SF08.D55.080
8	21	27	120	36	SF08.D55.120
8	21	27	160	36	SF08.D55.160
10	24	32	80	42	SF10.D55.080
10	24	32	120	42	SF10.D55.120
10	24	32	160	42	SF10.D55.160
12	24	32	80	47	SF12.D55.080
12	24	32	120	47	SF12.D55.120
12	24	32	160	47	SF12.D55.160
14	27	34	80	47	SF14.D55.080
14	27	34	120	47	SF14.D55.120
14	27	34	160	47	SF14.D55.160
16	27	34	80	50	SF16.D55.080
16	27	34	120	50	SF16.D55.120
16	27	34	160	50	SF16.D55.160
18	33	42	80	50	SF18.D55.080
18	33	42	120	50	SF18.D55.120
18	33	42	160	50	SF18.D55.160
20	33	42	80	52	SF20.D55.080
20	33	42	120	52	SF20.D55.120
20	33	42	160	52	SF20.D55.160
25	44	53	100	58	SF25.D55.100
25	44	53	120	58	SF25.D55.120
25	44	53	160	58	SF25.D55.160
32	44	53	100	63	SF32.D55.100
32	44	53	120	63	SF32.D55.120
32	44	53	160	63	SF32.D55.160

3° THERMO Shrink-fit chucks

Slim execution

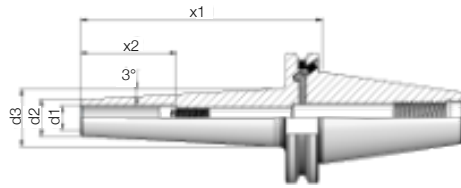

Radial runout $\leq 0,003$ mm
Balanced G2.5 at 25 000 min⁻¹

d1	d2	d3	x1	x2	Code
6	12	18	80	36	SF06.D55.080.3
6	12	22	120	36	SF06.D55.120.3
6	12	26	160	36	SF06.D55.160.3
8	14	20	80	36	SF08.D55.080.3
8	14	24	120	36	SF08.D55.120.3
8	14	28	160	36	SF08.D55.160.3
10	16	22	80	42	SF10.D55.080.3
10	16	26	120	42	SF10.D55.120.3
10	16	30	160	42	SF10.D55.160.3
12	18	24	80	47	SF12.D55.080.3
12	18	28	120	47	SF12.D55.120.3
12	18	32	160	47	SF12.D55.160.3
16	24	30	80	47	SF16.D55.080.3
16	24	34	120	47	SF16.D55.120.3
16	24	38	160	47	SF16.D55.160.3

50
Form AD+B

THERMO Shrink-fit chucks

Compact execution

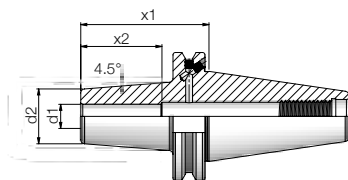

Radial runout $\leq 0,003$ mm
Balanced G2.5 at 25 000 min⁻¹

d1	d2	x1	x2	Code
6	21	65	36	SF06.D55.065
8	21	65	36	SF08.D55.065
10	24	65	42	SF10.D55.065
12	27	65	47	SF12.D55.065
14	33	70	47	SF14.D55.070
16	33	70	50	SF16.D55.070
18	44	70	50	SF18.D55.070
20	44	70	50	SF20.D55.070
25	46	70	56	SF25.D55.070
32	47	75	58	SF32.D55.075

50
Form AD+B

“3-in-1” THERMO Shrink-fit chucks

Internal coolant supply

Radial runout $\leq 0,003$ mm

Balanced G2.5 at 25 000 min⁻¹

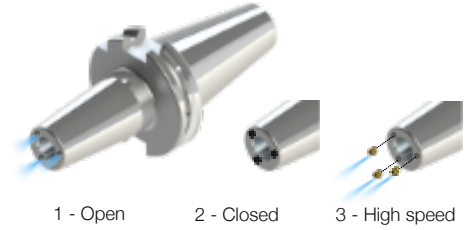
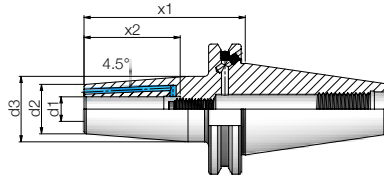

50
Form AD+B

d1	d2	d3	x1	x2	Code
6	21	27	80	36	SF06.D55.080.IK
6	21	27	120	36	SF06.D55.120.IK
8	21	27	80	36	SF08.D55.080.IK
8	21	27	120	36	SF08.D55.120.IK
10	24	32	80	42	SF10.D55.080.IK
10	24	32	120	42	SF10.D55.120.IK
12	24	32	80	47	SF12.D55.080.IK
12	24	32	120	47	SF12.D55.120.IK
14	27	34	80	47	SF14.D55.080.IK
14	27	34	120	47	SF14.D55.120.IK
16	27	34	80	50	SF16.D55.080.IK
16	27	34	120	50	SF16.D55.120.IK
18	33	42	80	50	SF18.D55.080.IK
18	33	42	120	50	SF18.D55.120.IK
20	33	42	80	52	SF20.D55.080.IK
20	33	42	120	52	SF20.D55.120.IK
25	44	53	100	58	SF25.D55.100.IK
25	44	53	120	58	SF25.D55.120.IK
32	44	53	100	63	SF32.D55.100.IK
32	44	53	120	63	SF32.D55.120.IK

Including high speed nozzles and sealing plugs

Extended “3-in-1” THERMO Shrink-fit chucks

Internal coolant supply

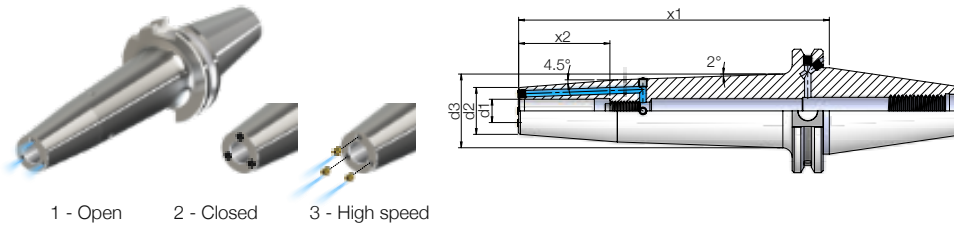

Radial runout $\leq 0,003$ mm

G2.5 at 25 000 min⁻¹

1 - Open 2 - Closed 3 - High speed

d1	d2	d3	x1	x2	Code
6	21	34	160	36	SF06.D55.160.IK
6	21	37	200	36	SF06.D55.200.IK
8	21	34	160	36	SF08.D55.160.IK
8	21	37	200	36	SF08.D55.200.IK
10	24	38	160	42	SF10.D55.160.IK
10	24	41	200	42	SF10.D55.200.IK
12	24	38	160	47	SF12.D55.160.IK
12	24	41	200	47	SF12.D55.200.IK
14	27	40.5	160	47	SF14.D55.160.IK
14	27	43.5	200	47	SF14.D55.200.IK
16	27	40.5	160	50	SF16.D55.160.IK
16	27	43.5	200	50	SF16.D55.200.IK
18	33	47.5	160	50	SF18.D55.160.IK
18	33	50.5	200	50	SF18.D55.200.IK
20	33	47.5	160	52	SF20.D55.160.IK
20	33	50.5	200	52	SF20.D55.200.IK
25	44	58.5	160	58	SF25.D55.160.IK
25	44	61.5	200	58	SF25.D55.200.IK
32	44	58.5	160	63	SF32.D55.160.IK
32	44	61.5	200	63	SF32.D55.200.IK

50
Form AD+B

Including high speed nozzles and sealing plugs

Vibration-dampening tapered profile

End mill holders

Radial runout $\leq 0,003$ mm
 Balanced G6.3 at 18 000 min⁻¹

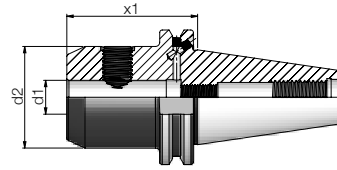

	d1	d2	x1	Code
50 Form AD+B	6	25	63	WE06.D55.063
	6	25	100	WE06.D55.100
	6	25	120	WE06.D55.120
	6	25	160	WE06.D55.160
	6	25	200	WE06.D55.200
	8	28	63	WE08.D55.063
	8	28	100	WE08.D55.100
	8	28	120	WE08.D55.120
	8	28	160	WE08.D55.160
	8	28	200	WE08.D55.200
	10	35	63	WE10.D55.063
	10	35	100	WE10.D55.100
	10	35	120	WE10.D55.120
	10	35	160	WE10.D55.160
	10	35	200	WE10.D55.200
	12	42	63	WE12.D55.063
	12	42	100	WE12.D55.100
	12	42	120	WE12.D55.120
	12	42	160	WE12.D55.160
	12	42	200	WE12.D55.200
14	44	63	WE14.D55.063	
14	44	100	WE14.D55.100	
14	44	120	WE14.D55.120	
14	44	160	WE14.D55.160	
14	44	200	WE14.D55.200	
16	48	63	WE16.D55.063	
16	48	100	WE16.D55.100	
16	48	120	WE16.D55.120	
16	48	160	WE16.D55.160	
16	48	200	WE16.D55.200	
18	50	63	WE18.D55.063	
18	50	100	WE18.D55.100	
18	50	120	WE18.D55.120	
18	50	160	WE18.D55.160	
18	50	200	WE18.D55.200	
20	52	63	WE20.D55.063	
20	52	100	WE20.D55.100	
20	52	120	WE20.D55.120	
20	52	160	WE20.D55.160	
20	52	200	WE20.D55.200	

End mill holders

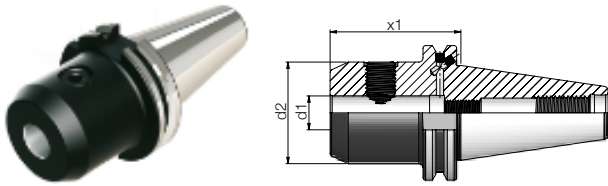

Radial runout $\leq 0,003$ mm
Balanced G6.3 at 18 000 min⁻¹

d1	d2	x1	Code
25	50	35	WE25.D55.035
25	65	80	WE25.D55.080
25	65	100	WE25.D55.100
25	65	120	WE25.D55.120
25	65	160	WE25.D55.160
25	65	200	WE25.D55.200
32	65	35	WE32.D55.035
32	72	100	WE32.D55.100
32	72	120	WE32.D55.120
32	72	160	WE32.D55.160
32	72	200	WE32.D55.200
40	90	100	WE40.D55.100
50	90	125	WE50.D55.125

50
Form AD+B

End mill holders

Internal coolant supply

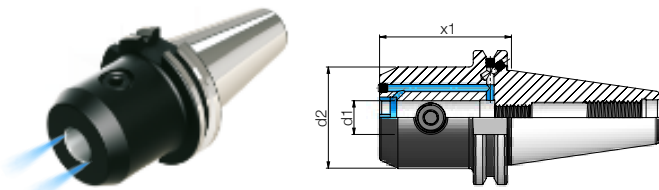

Radial runout $\leq 0,003$ mm
Balanced G6.3 at 18 000 min⁻¹

d1	d2	x1	Code
6	25	63	WE06.D55.063.IK
8	28	63	WE08.D55.063.IK
10	35	63	WE10.D55.063.IK
12	42	63	WE12.D55.063.IK
14	44	63	WE14.D55.063.IK
16	48	63	WE16.D55.063.IK
18	50	63	WE18.D55.063.IK
20	52	63	WE20.D55.063.IK
25	65	80	WE25.D55.080.IK
32	72	100	WE32.D55.100.IK
40	90	100	WE40.D55.100.IK

50
Form AD+B

End mill holders

Slim execution

Radial runout $\leq 0,003$ mm

G6.3 at 25 000 min⁻¹

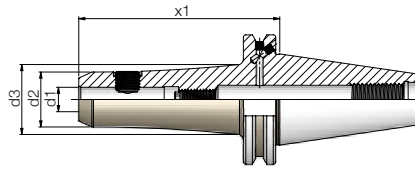

50
Form AD+B

d1	d2	d3	x1	Code
6	17	25	100	WE06.D55.100F
6	17	30	130	WE06.D55.130F
6	17	31	160	WE06.D55.160F
6	17	40	200	WE06.D55.200F
8	21	29	100	WE08.D55.100F
8	21	35	130	WE08.D55.130F
8	21	35	160	WE08.D55.160F
8	21	44	200	WE08.D55.200F
10	24	32	100	WE10.D55.100F
10	24	37	130	WE10.D55.130F
10	24	38	160	WE10.D55.160F
10	24	47	200	WE10.D55.200F
12	27	35	100	WE12.D55.100F
12	27	40	130	WE12.D55.130F
12	27	41	160	WE12.D55.160F
12	27	50	200	WE12.D55.200F
14	29	37	100	WE14.D55.100F
14	29	42	130	WE14.D55.130F
14	29	43	160	WE14.D55.160F
14	29	52	200	WE14.D55.200F
16	33	41	100	WE16.D55.100F
16	33	46	130	WE16.D55.130F
16	33	47	160	WE16.D55.160F
16	33	56	200	WE16.D55.200F
18	35	43	100	WE18.D55.100F
18	35	48	130	WE18.D55.130F
18	35	49	160	WE18.D55.160F
18	35	58	200	WE18.D55.200F
20	39	47	100	WE20.D55.100F
20	39	52	130	WE20.D55.130F
20	39	53	160	WE20.D55.160F
20	39	62	200	WE20.D55.200F
25	47	55	100	WE25.D55.100F
25	47	60	130	WE25.D55.130F
25	47	61	160	WE25.D55.160F
25	47	70	200	WE25.D55.200F
32	57	70	130	WE32.D55.130F
32	57	71	160	WE32.D55.160F
32	57	72	200	WE32.D55.200F

Collet chucks 1:10 for DIN6388 collets

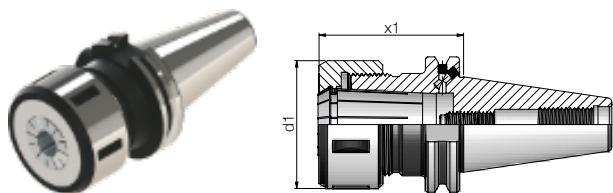
Radial runout $\leq 0,003$ mmG6.3 at 18 000 min⁻¹

Range	x1	d1	Code
1.5 - 16	70	43	SP16.D55.070
1.5 - 16	100	43	SP16.D55.100
1.5 - 16	160	43	SP16.D55.160
2 - 25	70	60	SP25.D55.070
2 - 25	100	60	SP25.D55.100
2 - 25	160	60	SP25.D55.160
4 - 32	80	72	SP32.D55.080
4 - 32	140	72	SP32.D55.140

ER Collet chucks

Radial runout $\leq 0,003$ mm
 Balanced G6.3 at 18 000 min⁻¹

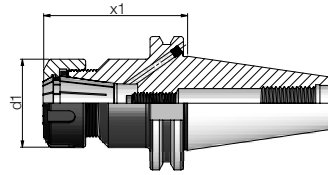

ER	Range	x1	d1	Code	
50 Form AD+B	16	0.5 - 10	63	28	ER16.D55.063
	16	0.5 - 10	100	28	ER16.D55.100
	16	0.5 - 10	130	28	ER16.D55.130
	16	0.5 - 10	160	28	ER16.D55.160
	16	0.5 - 10	200	28	ER16.D55.200
25	1 - 16	60	42	ER25.D55.060	
25	1 - 16	100	42	ER25.D55.100	
25	1 - 16	130	42	ER25.D55.130	
25	1 - 16	160	42	ER25.D55.160	
25	1 - 16	200	42	ER25.D55.200	
32	2 - 20	70	50	ER32.D55.070	
32	2 - 20	100	50	ER32.D55.100	
32	2 - 20	130	50	ER32.D55.130	
32	2 - 20	160	50	ER32.D55.160	
32	2 - 20	200	50	ER32.D55.200	
40	3 - 26	80	63	ER40.D55.080	
40	3 - 26	100	63	ER40.D55.100	
40	3 - 26	130	63	ER40.D55.130	
40	3 - 26	160	63	ER40.D55.160	
40	3 - 26	200	63	ER40.D55.200	

ER Collet chucks

Mini execution

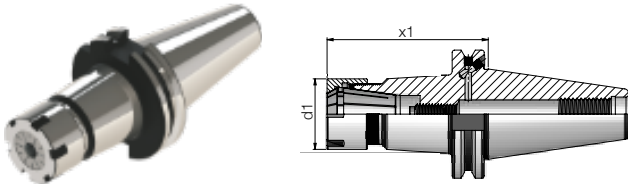

Radial runout $\leq 0,003$ mm
Balanced G6.3 at 18 000 min⁻¹

ER	Range	x1	d1	Code
11	0.5 - 7	100	16	ER11.D55.100M
11	0.5 - 7	160	16	ER11.D55.160M
16	0.5 - 10	100	22	ER16.D55.100M
16	0.5 - 10	160	22	ER16.D55.160M
20	1 - 13	100	28	ER20.D55.100M
20	1 - 13	160	28	ER20.D55.160M
25	1 - 16	100	35	ER25.D55.100M
25	1 - 16	160	35	ER25.D55.160M

50
Form AD+B

Morse taper holders for mills

Radial runout $\leq 0,005$ mm
Balanced G6.3 at 18 000 min⁻¹

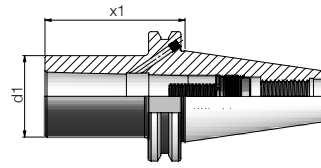

50
Form AD+B

MK	x1	d1	Code
1	45	25	MK1A.D55.045
2	60	32	MK2A.D55.060
3	65	40	MK3A.D55.065
4	70	48	MK4A.D55.070
5	100	63	MK5A.D55.100

Morse taper holders for drills

Radial runout $\leq 0,005$ mm
Balanced G6.3 at 18 000 min⁻¹

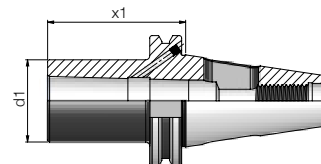

50
Form AD+B

MK	x1	d1	Code
1	45	25	MK1B.D55.045
2	60	32	MK2B.D55.060
3	65	40	MK3B.D55.065
4	95	48	MK4B.D55.095
5	105	63	MK5B.D55.105

Threaded shank milling cutter holders

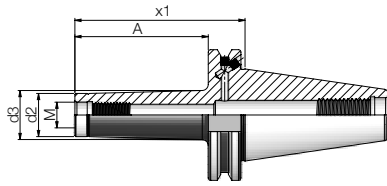

Radial runout $\leq 0,003$ mm
Balanced G2.5 at 25 000 min⁻¹

M	A	x1	d2	d3	Code
M8	50	69	13	20	EF08.D55.069
M8	100	119	13	25	EF08.D55.119
M8	150	169	13	30	EF08.D55.169
M10	50	69	18	24	EF10.D55.069
M10	100	119	18	32	EF10.D55.119
M10	150	169	18	40	EF10.D55.169
M12	50	69	21	23	EF12.D55.069
M12	100	119	21	33	EF12.D55.119
M12	150	169	21	47	EF12.D55.169
M16	50	69	29	32	EF16.D55.069
M16	100	119	29	42	EF16.D55.119
M16	150	169	29	45	EF16.D55.169
M16	200	219	29	55	EF16.D55.219

50
Form AD+B

Combi shell mill holders for milling cutters

Radial runout $\leq 0,003$ mm
 Balanced G6.3 at 18 000 min⁻¹

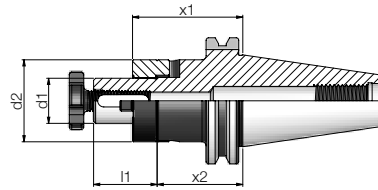

50
Form AD

d1	x1	x2	d2	l1	Code
16	55	45	32	27	KD16.D50.055
16	100	90	32	27	KD16.D50.100
16	150	140	32	27	KD16.D50.150
16	200	190	32	27	KD16.D50.200
22	55	43	40	31	KD22.D50.055
22	100	88	40	31	KD22.D50.100
22	150	138	40	31	KD22.D50.150
22	200	188	40	31	KD22.D50.200
27	55	43	48	33	KD27.D50.055
27	100	88	48	33	KD27.D50.100
27	150	138	48	33	KD27.D50.150
27	200	188	48	33	KD27.D50.200
32	55	41	58	38	KD32.D50.055
32	100	86	58	38	KD32.D50.100
32	150	136	58	38	KD32.D50.150
32	200	186	58	38	KD32.D50.200
40	55	41	70	41	KD40.D50.055
40	100	86	70	41	KD40.D50.100
40	150	136	70	41	KD40.D50.150
40	200	186	70	41	KD40.D50.200
50	70	54	90	46	KD50.D50.070

Shell mill holders for cutters with driving slot

Internal coolant supply

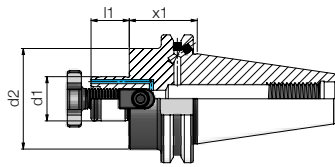

Radial runout $\leq 0,003$ mm
Balanced G6.3 at 18 000 min⁻¹

d1	x1	l1	d2	Code
16	35	17	38	AD16.D55.035
16	100	17	38	AD16.D55.100
16	160	17	38	AD16.D55.160
16	200	17	38	AD16.D55.200
22	35	19	50	AD22.D55.035
22	100	19	50	AD22.D55.100
22	160	19	50	AD22.D55.160
22	200	19	50	AD22.D55.200
27	35	21	50	AD27.D55.035
27	100	21	50	AD27.D55.100
27	160	21	50	AD27.D55.160
27	200	21	50	AD27.D55.200
32	35	24	78	AD32.D55.035
32	100	24	78	AD32.D55.100
32	160	24	78	AD32.D55.160
32	200	24	78	AD32.D55.200
40	50	27	89	AD40.D55.050
40	100	27	89	AD40.D55.100
40	160	27	89	AD40.D55.160
40	200	27	89	AD40.D55.200
50	120	30	129	AD50.D55.120
60	70	40	129	AD60.D50.070

50
Form AD+B

Holders for indexable inserts drills

Radial runout $\leq 0,005$ mm
Balanced G6.3 at 18 000 min⁻¹

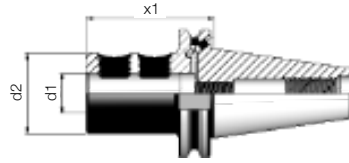

50
Form AD+B

d1	x1	d2	Code
20	70	40	VB20.D55.070
25	70	45	VB25.D55.070
32	75	52	VB32.D55.070
40	80	60	VB40.D55.080

Quick-change tapping head

Length compensation in compression and tension

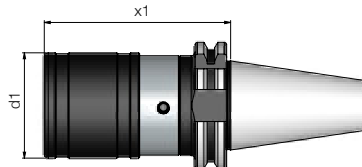

50
Form A

Tap size	Compensation	Insert size	x1	d1	Code
M3 - M14	± 7.5	1	74	36	GN12.D50.074
M6 - M24	± 12.5	2	98	53	GN20.D50.098
M14 - M33	± 20.0	3	159	78	GN33.D50.159
M22 - M48	± 22.5	4	175	96	GN48.D50.175

HV drill chucks for RH and LH rotation

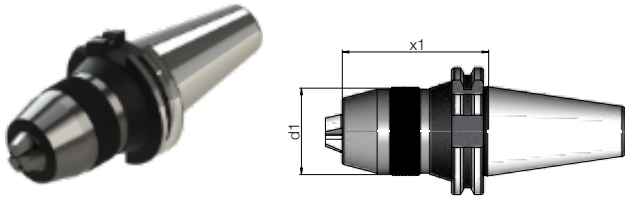

Radial runout $\leq 0,02$ mm
Balanced G6.3 at 25 000 min⁻¹

mm	x1	d1	Code
1 - 16	80	51	HV16.D50.080

50
Form AD

Integrated precision drill chuck with Hexagonal key lock.

For drilling, milling, reaming and tapping.

Through coolant.

Drill chuck slipping impossible due to chuck being screwed with the holder body.

Compact design, enhanced reach.

NC drill chucks for RH rotation

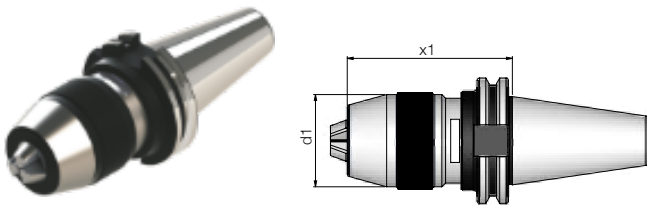

Special wrench supplied.
Radial runout $\leq 0,03$ mm
Balanced G6.3 at 12 000 min⁻¹

mm	x1	d1	Code
1 - 13	80	54	NC13.D50.080
3 - 16	97	57	NC16.D50.097

50
Form A

Integrated drill chuck with high clamping force achieved through special wrench

2x chucking torque vs. hand tightening

Drill bit slipping nearly impossible

Drill chuck slipping impossible due to chuck being screwed with the holder body.

Compact design, external coolant supply.

Range up to 8, 10, 13 or 16 mm.

Blank bars

Cone and flange hardened and finished.
Machineable soft body.
Pre-balanced

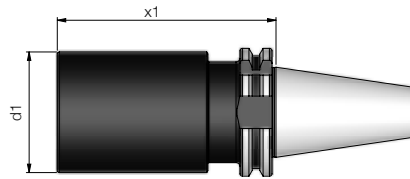

	d1	x1	Code
50 Form A	95.5	160	RL95.D50.160
	95.5	250	RL95.D50.250

Test bars

Precisely ground length and diameter.
Test certificate and protective case supplied.
Radial runout $\leq 0,003$ mm

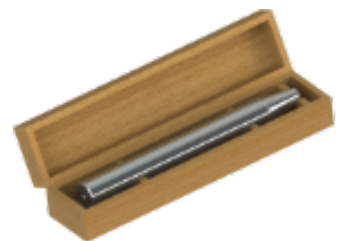
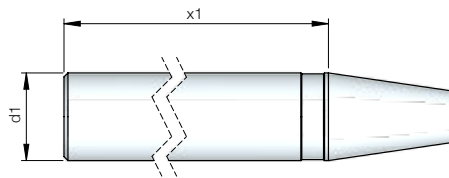

	d1	x1	Code
50 Form A	63	250	TB63.D50.250





Find additional information and
product catalogues

www.sab.hr

SAB d.o.o.
Podborska 1b / 43500 Daruvar
tel. + 385 43 675 850
fax. + 385 43 334 700
sab@sab.hr / www.sab.hr

Note: Product photos and illustrations are not binding. Product descriptions, technical specifications and dimensions are binding only when explicitly agreed upon. We reserve right to make technical modifications as well as price changes. We take no liability for print or type errors. Only our terms and conditions are valid. 07/2022