

## FILO-75E00 LOWPASS FITLER, WR-12, 58 - 75 GHz

### Features:

- 2 Weeks Lead Time
- Low Cost
- High Rejection
- High Power Handling

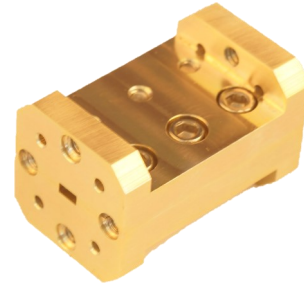

### Electrical Specifications:

- Passband Frequency: 58 - 75 GHz
- Passband Insertion Loss: 1.1 dB
- Passband Return Loss: 18 dB min.
- Rejection (40 dB): 79 - 137 GHz
- Waveguide Cutoff: 48.4 GHz

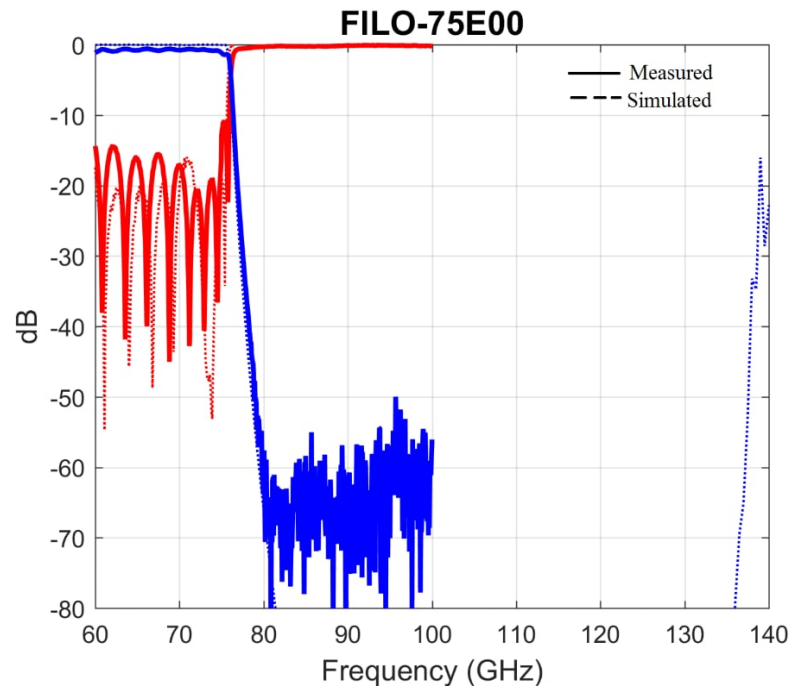

### Mechanical Specifications:

- Port: WR-12, UG-387/UM
- Size: 1.25" (L) X 0.75" (W) X 0.75" (W)
- Material: Aluminum
- Finish: Chromate

### Outline: FIBL001-OL00-002

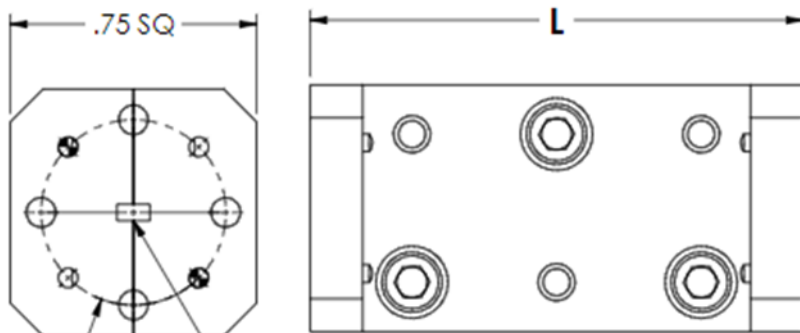

WR-8 W/ UG-387/U-M FLANGE  
WR-10 W/ UG-378/U-M FLANGE  
WR-12 W/ UG-387/U FLANGE  
WR-15 W/ UG-385/U FLANGE

DASH	L (inch)
-001	1.00
-002	1.25
-003	1.50
-004	1.75
-005	2.00

Note: Raytech Inc. reserves the right to change the information presented without notice.