

Mullca 510
Gaston Cavaillon 1964

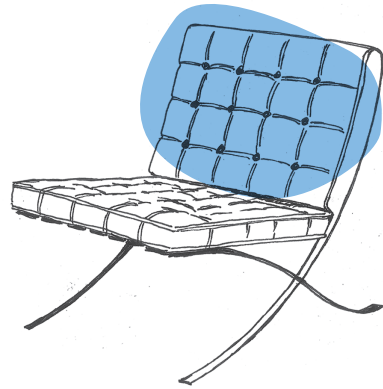

Barcelona
Ludwig Mies van der Rohe & Lilly Reich 1929



Best 18080500
Memphis XXe s.

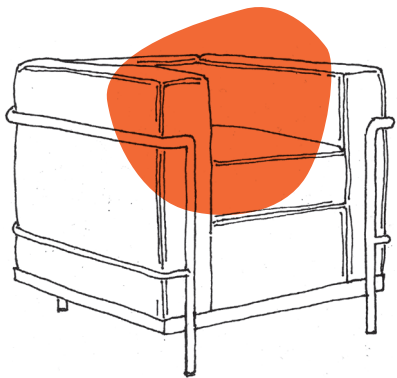

Sessel Grand Confort LC2
Le Corbusier, Pierre Jeanneret, Charlotte Perriand 1928

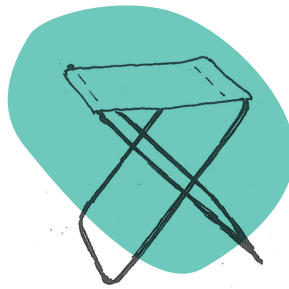

Tabouret Camping
XXe s.

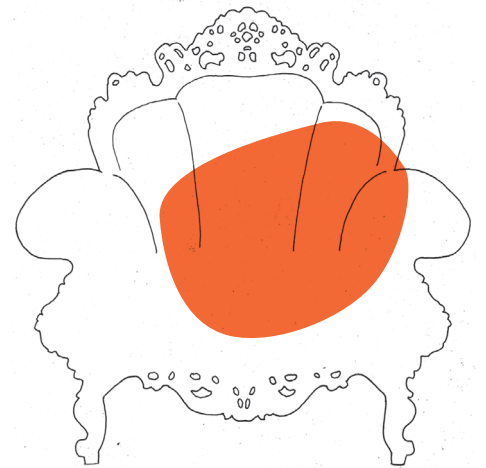

Proust
Alessandro Mendini 1978

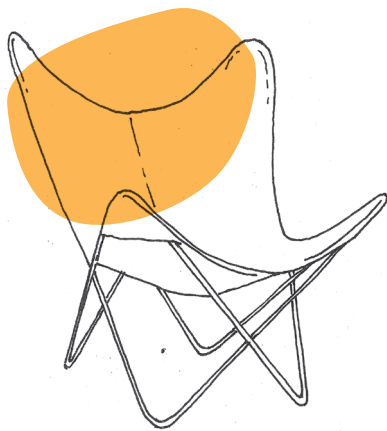

Chaise Papillon ou BKF
Grupo Austral 1938



Tom Vac
Ron Arad 1999

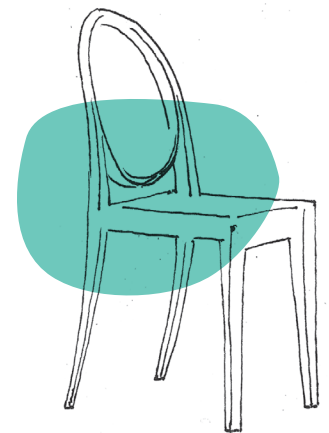

Louis Ghost
Philippe Starck 2002



Le Penseur
Auguste Rodin 1882



Tulip Chair
Eero Saarinen 1956

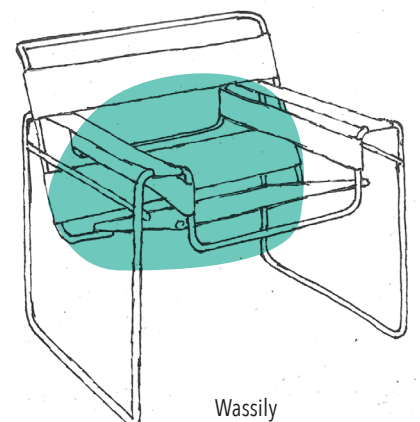

Wassily
Marcel Breuer 1925

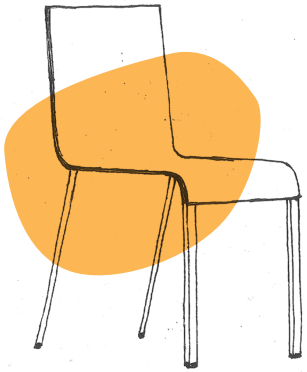

.03
Maarten Van Severen 1998



Chaise enfant
XXe s.

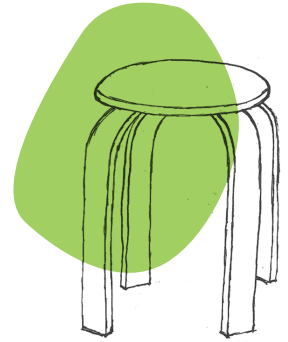

E60
Alvar Aalto 1933

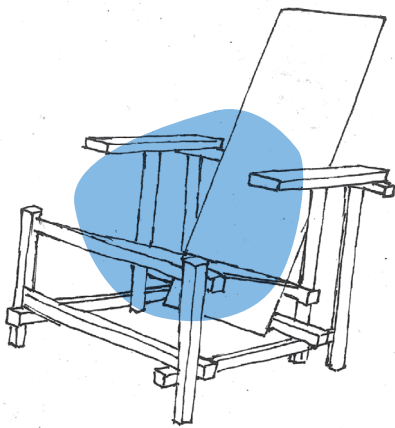

Red and Blue Chair
Gerrit Thomas Rietveld 1918

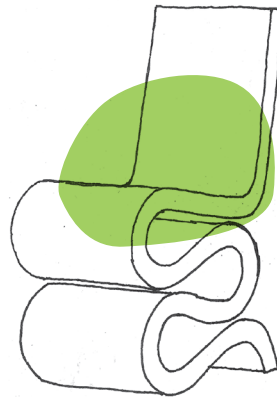

Wiggle Side Chair
Franck O. Gehry 1972



Duplex
Javier Mariscal 1983

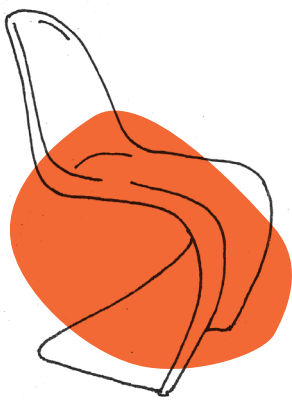

Panton Chair,
Verner Panton 1959



Hanging Egg
Nanna Ditzel 1959

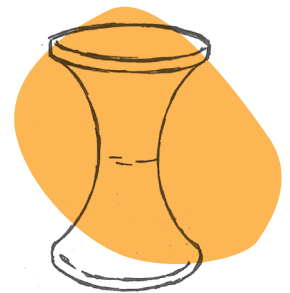

Tam tam
Henry Massonnet 1968

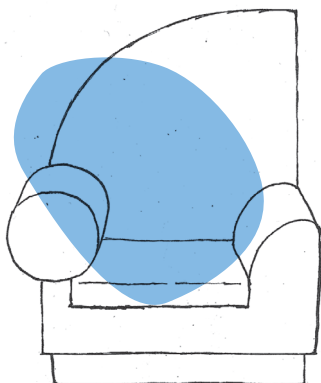

Bel Air
Peter Shire 1982



Nr. 14
Michael Thonet 1859

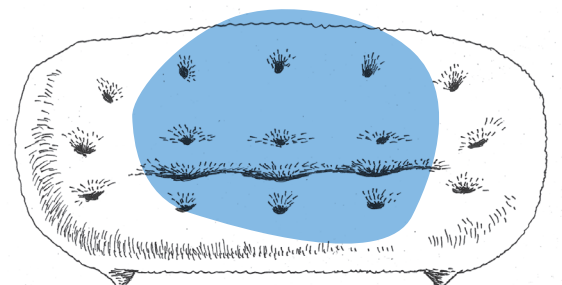

Ploum
R & E Bouroullec 2011

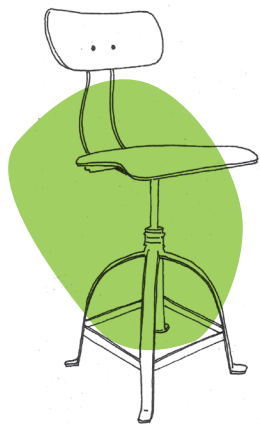

Chaise architecte
JB Pennel début XXe s.

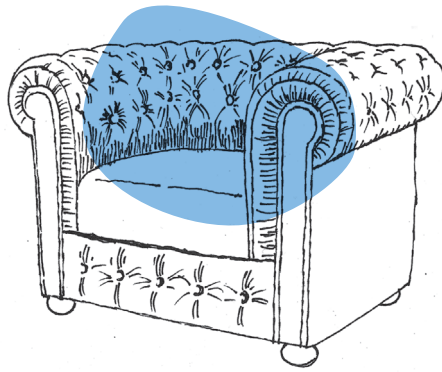

Chesterfield
style anglais fin XVIIIe s.

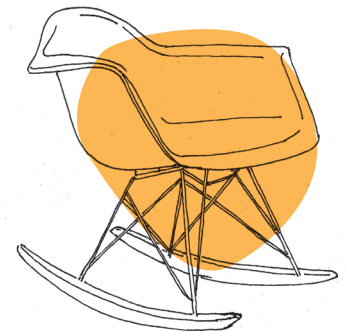

RAR
Charles & Ray Eames 1950

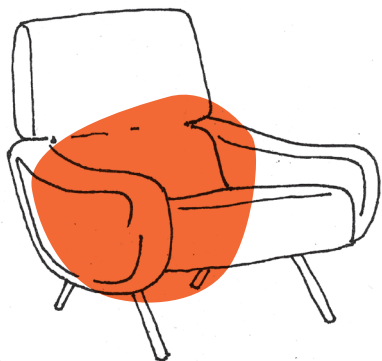

720 Lady
Marco Zanuso 1951

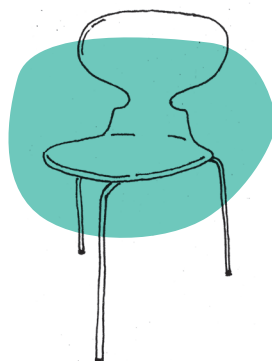

Ant
Arne Jacobsen 1952

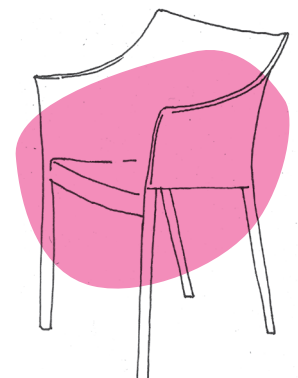

Dr No
Philippe Starck 1996



Fauteuil Memphis
XXe s.



Chaise DSW
Charles & Ray Eames 1950

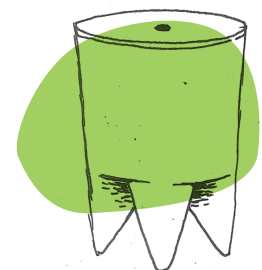

Bubu 1er
Philippe Starck 1991

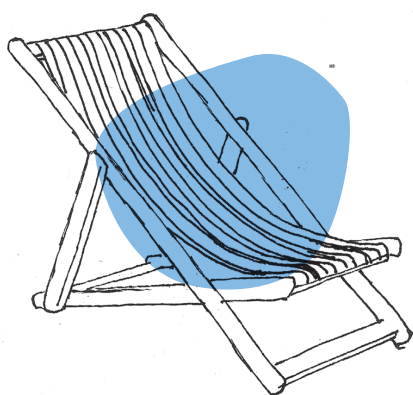

Transat
fin XIXe s.

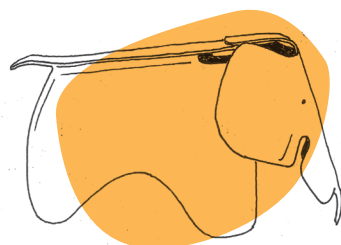

Eames Elephant
Charles & Ray Eames 1945

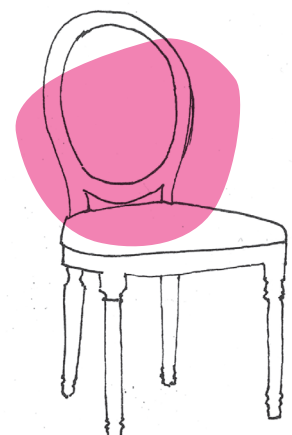

Louis XVI
XVIIIe s.