



INDEX	PAGE(S)
<u>The MultiTek Cart</u>	180 - 181
Preconfigured Models . . .	183 - 191
Accessories	192 - 193

MULTITEK CART

The MultiTek Cart is an ergonomic and multifunctional cart. In an innovative leap forward from standard cart solutions, not only does it transport tools, parts and other items, it also functions as a small portable workstation.

Many configurations are possible, ranging from minimalist to fully equipped. A wide range of accessories can be installed, so you can keep your tools organized and always on hand in your own personalized and mobile workstation.

Cart models with drawers include a lock-in mechanism and those with a cover have a standard lock. PVC liners are also available as optional accessories.

Heavy-duty and maneuverable, the MultiTek Cart is the ideal companion to help you perform your daily tasks.



THE ROUSSEAU DIFFERENCE

LOCKABLE COVER
Opens 90° for unrestricted access to the shelf

COMFORTABLE AND ERGONOMIC HANDLES

ROLL-OUT SHELF
Expand your work surface area by adding a roll-out shelf

FRONT OR SIDE DRAWERS (4"H)
Transport tools safely and securely. Each drawer includes a lock-in mechanism to keep it closed and has a 50lb. load capacity

FINISHING PANELS, UTILITY PANELS OR PLASTIC BIN PANELS
Add accessories to ensure everything you need is always within reach

UPRIGHT BUMPERS
Protect your work environment from accidental bumps

SUPERIOR-QUALITY CASTERS

GENERAL DIMENSIONS



CARTS WITH 3" H CASTERS

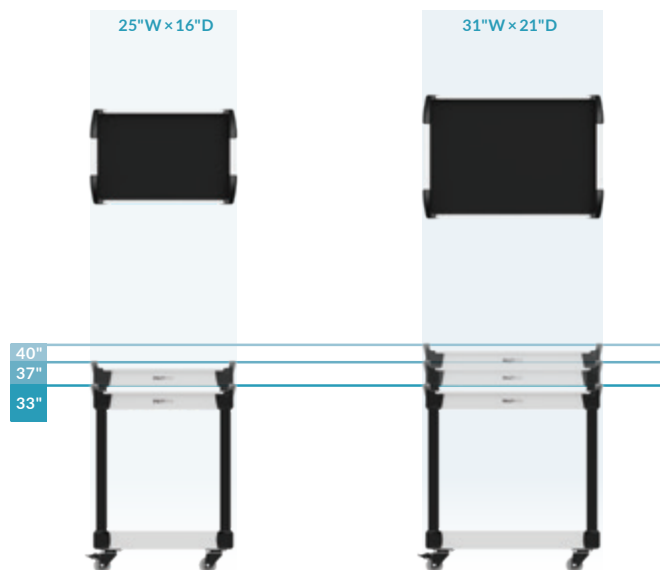

CARTS WITH 5" H CASTERS

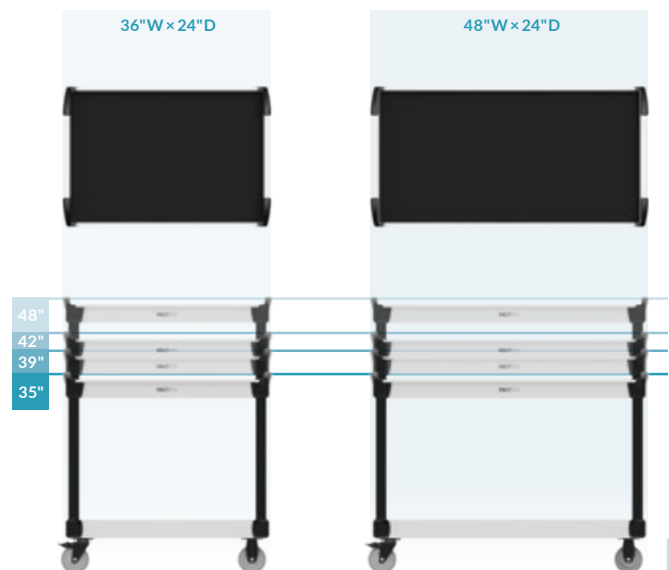

MULTITEK CART

DRAWER AND ROLL-OUT SHELF DIMENSIONS

DRAWER AND ROLL-OUT SHELF DIMENSIONS FOR 25"W x 16"D CART

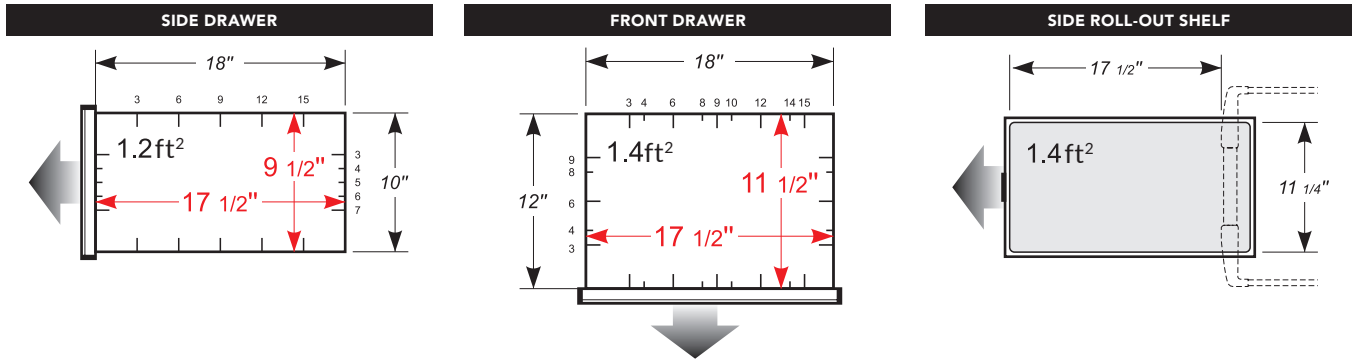

DRAWER AND ROLL-OUT SHELF DIMENSIONS FOR 31"W x 21"D CART

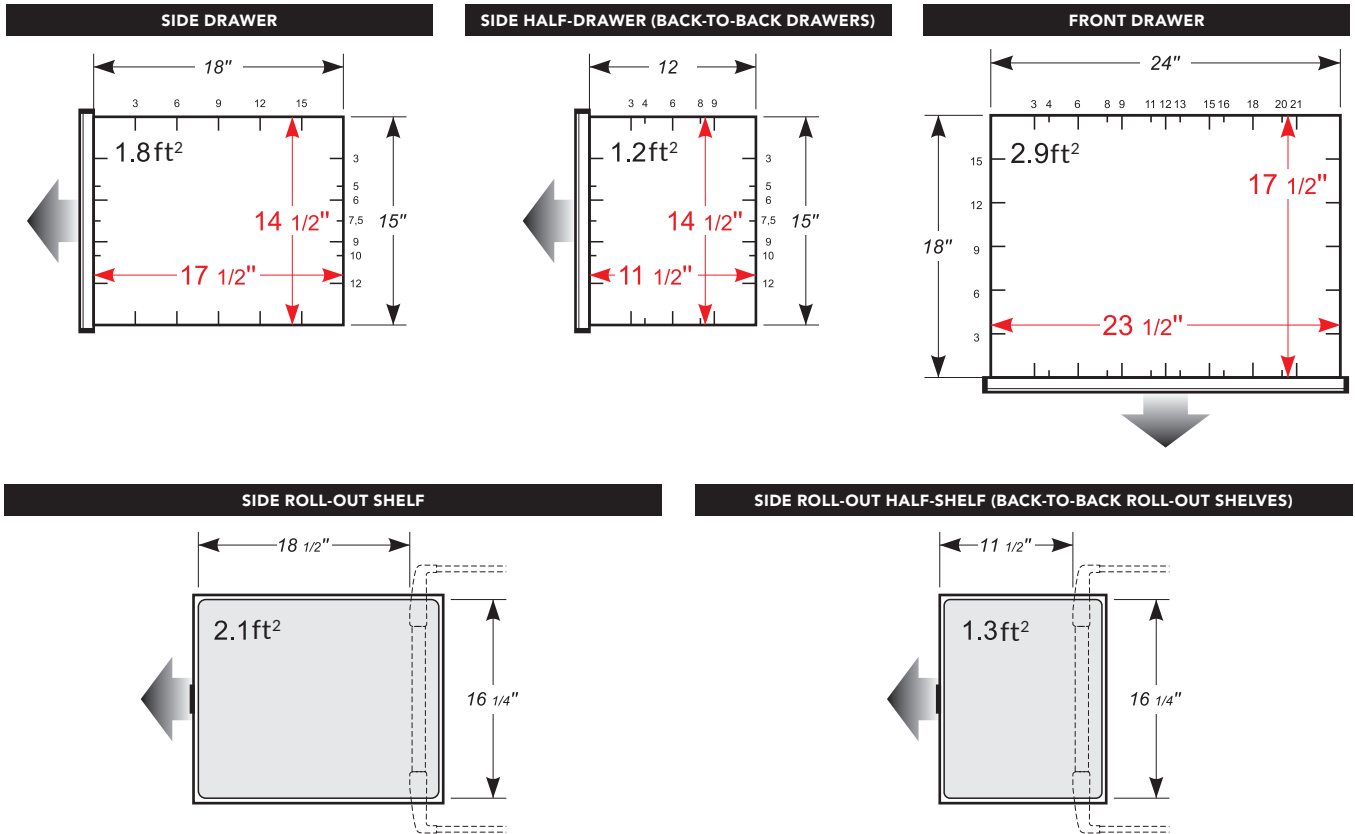

DRAWER COMPARTMENTS

SIDE DRAWERS FOR 25" W × 16" D CART



PARTITIONS AND DIVIDERS				GROOVE TRAYS *	
ROGBS-A010004 2 COMPARTMENTS	ROGBS-A010204 4 COMPARTMENTS	ROGBS-A010404 6 COMPARTMENTS	ROGBS-A011004 12 COMPARTMENTS	ROGBS-G01004 10 GROOVE TRAYS	ROGBS-G01504 15 GROOVE TRAYS
PLASTIC BINS			FOAM		
ROGBS-E01204 12 BINS	ROGBS-E01404 14 BINS	ROGBS-E01504 15 BINS	ROGBS-J0104 PROTECTIVE FOAM	ROGBS-J0204 TOOL FOAM	ROGBS-J0304 COLLET FOAM



FRONT DRAWERS FOR 25" W × 16" D CART

PARTITIONS AND DIVIDERS				GROOVE TRAYS *	
ROGBF-A020004 3 COMPARTMENTS	ROGBF-A010204 4 COMPARTMENTS	ROGBF-A020304 6 COMPARTMENTS	ROGBF-A051204 18 COMPARTMENTS	ROGBF-G01104 11 GROOVE TRAYS	ROGBF-G01204 12 GROOVE TRAYS
PLASTIC BINS			FOAM		
ROGBF-E00604 6 BINS	ROGBF-E01204 12 BINS	ROGBF-E01304 13 BINS	ROGBF-J0104 PROTECTIVE FOAM	ROGBF-J0204 TOOL FOAM	ROGBF-J0304 COLLET FOAM



NOTES: * Two dividers included with each groove tray.
 Preconfigured drawer layouts can be added to the MultiTek Cart preconfigured, [see pages 186-187](#).
 Preconfigured drawer layouts include subdividing accessories only (not the drawer).

PRECONFIGURED MODELS

SIDE HALF-DRAWERS FOR 31"W x 21"D CART



PARTITIONS AND DIVIDERS				GROOVE TRAYS*	
RONHB-A010004 2 COMPARTMENTS	RONHB-A010204 4 COMPARTMENTS	RONHB-A020304 6 COMPARTMENTS	RONHB-A020604 9 COMPARTMENTS	RONHB-G00504 5 GROOVE TRAYS	RONHB-G00904 9 GROOVE TRAYS
PLASTIC BINS			FOAM		
RONHB-E01204 12 BINS	RONHB-E01304 13 BINS	RONHB-E02004 20 BINS	RONHB-J0104 PROTECTIVE FOAM	RONHB-J0204 TOOL FOAM	RONHB-J0304 COLLET FOAM

SIDE DRAWERS FOR 31"W x 21"D CART

PARTITIONS AND DIVIDERS				GROOVE TRAYS*	
RONHS-A010004 2 COMPARTMENTS	RONHS-A010204 4 COMPARTMENTS	RONHS-A010404 6 COMPARTMENTS	RONHS-A042504 30 COMPARTMENTS	RONHS-G01004 10 GROOVE TRAYS	RONHS-G01204 12 GROOVE TRAYS
PLASTIC BINS			FOAM		
RONHS-E01204 12 BINS	RONHS-E01804 18 BINS	RONHS-E02104 21 BINS	RONHS-J0104 PROTECTIVE FOAM	RONHS-J0204 TOOL FOAM	RONHS-J0304 TOOL FOAM

NOTES: * Two dividers included with each groove tray.
 Preconfigured drawer layouts can be added to the MultiTek Cart preconfigured, [see pages 188-189](#).
 Preconfigured drawer layouts include subdividing accessories only (not the drawer).



FRONT DRAWERS FOR 31"W x 21"D CART

PARTITIONS AND DIVIDERS

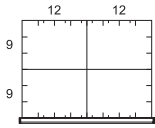

RONHF-A010204
4 COMPARTMENTS

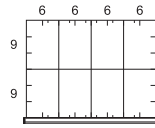

RONHF-A030404
8 COMPARTMENTS

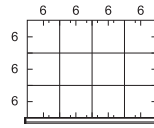

RONHF-A030804
12 COMPARTMENTS

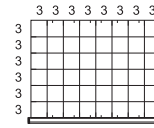

RONHF-A074004
48 COMPARTMENTS

GROOVE TRAYS*

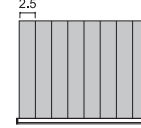

RONHF-G00804
8 GROOVE TRAYS

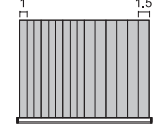

RONHF-G01504
15 GROOVE TRAYS

PLASTIC BINS

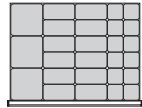

RONHF-E02704
27 BINS

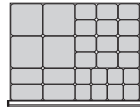

RONHF-E02804
28 BINS

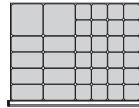

RONHF-E03404
34 BINS

FOAM



RONHF-J0104
PROTECTIVE FOAM

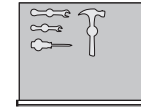

RONHF-J0204
TOOL FOAM

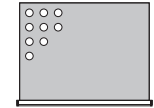

RONHF-J0304
COLLET FOAM



NOTES: * Two dividers included with each groove tray.
Preconfigured drawer layouts can be added to the MultiTek Cart preconfigured, [see pages 188-189](#).
Preconfigured drawer layouts include subdividing accessories only (not the drawer).



PRECONFIGURED MODELS

25"W x 16"D CARTS

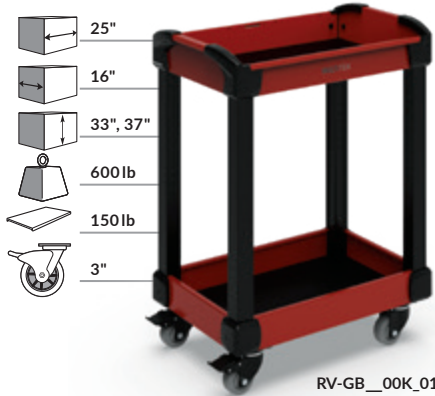

The 25"W x 16"D MultiTek Cart is compact and easy to maneuver. It offers plenty of storage space and multiple configurations

- Total load capacity: 600lb.
- Add intermediate shelves to transport more items
- The top, intermediate and bottom shelves each have a 150lb. load capacity
- The 4"H front and side drawers have a 50lb. load capacity and include a lock-in mechanism to prevent the drawers from opening by themselves
- The side roll-out shelf is lined with a rubber mat, has a 15lb. total load capacity and provides an extra work surface
- The cover features strategically placed gas springs to allow access to the top shelf when open. It is also equipped with a lock to secure the contents when closed
- For available accessories, [see pages 192-193](#)

SPECIFY THE HEIGHT, MAT AND LOCK REQUIRED

Height: 33" = 33 37" = 37

Rubber Mat on each shelf: With = 0 Whitout = 1

Drawer Lock = L3

RV-GB_A1F_02_B

IMPORTANT

All models with shelves only are sold non-assembled.

FRONT DRAWER



PRODUCT NO.
RV-GB_A1F_04_B

2 FRONT DRAWERS



PRODUCT NO.
RV-GB_A2F_04_B

FRONT DRAWER, SIDE ROLL-OUT SHELF



PRODUCT NO.
RV-GB_A1F_02_B

2 FRONT DRAWERS, SIDE ROLL-OUT SHELF



PRODUCT NO.
RV-GB_A2F_02_B

FRONT DRAWER, COVER, UTILITY PANEL



PRODUCT NO.
RV-GB_A1UC10_B¹

2 FRONT DRAWERS, COVER, UTILITY PANEL, UPRIGHT BUMPERS



PRODUCT NO.
RV-GB_A2UC12_B¹

NOTE: ¹For this model without a rubber mat replace the letter C with L.

SIDE DRAWER



PRODUCT NO.
RV-GB_S1F_04_B

2 SIDE DRAWERS



PRODUCT NO.
RV-GB_S2F_04_B

2 SIDE DRAWERS,
SIDE ROLL-OUT SHELF



PRODUCT NO.
RV-GB_S2F_06_B

2 SIDE DRAWERS,
SIDE ROLL-OUT SHELF, COVER,
UTILITY PANELS, UPRIGHT BUMPERS



PRODUCT NO.
RV-GB_S2X_02_B

SIDE DRAWER, SIDE ROLL-OUT SHELF



PRODUCT NO.
RV-GB_S1F_06_B

SIDE ROLL-OUT SHELF



PRODUCT NO.
RV-GB_00F_01

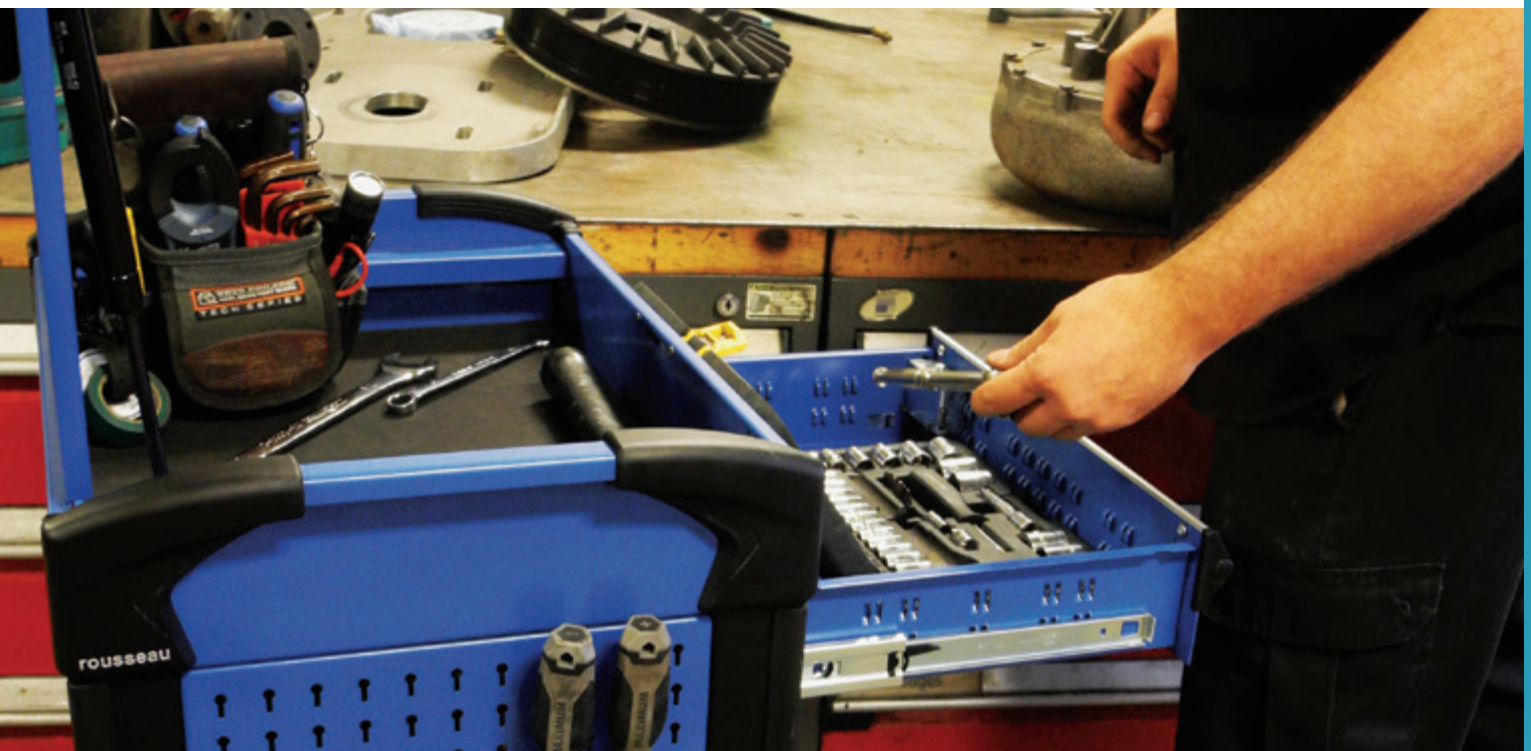

PRECONFIGURED MODELS

31"W x 21"D CARTS

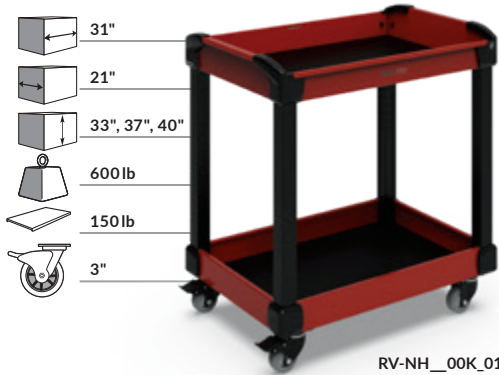

The 31"W x 21"D cart offers plenty of storage space and multiple configurations. With this size, you can have roll-out shelves or drawers on both sides of the cart

- Total load capacity: 600lb.
- Add intermediate shelves to transport more items
- The top, intermediate and bottom shelves each have a 150lb. load capacity
- The 4"H front and side drawers have a 50lb. load capacity and include a lock-in mechanism to prevent the drawers from opening by themselves
- The side roll-out shelf is lined with a rubber mat, has a 15lb. total load capacity and provides an extra work surface
- The cover features strategically placed gas springs to allow access to the top shelf when open. It is also equipped with a lock to secure the contents when closed
- For available accessories, [see pages 192-193](#)

SPECIFY THE HEIGHT, MAT AND LOCK REQUIRED

Height:
33" = 33 37" = 37
40" = 40

Rubber Mat on each shelf:
With = 0 Whitout = 1

Drawer Lock = L3

RV-NH__A1F_02__B

IMPORTANT
All models with shelves only are sold non-assembled.

SIDE DRAWER



PRODUCT NO.
RV-NH__S1F_04__B

2 SIDE DRAWERS



PRODUCT NO.
RV-NH__S2F_04__B

3 SIDE DRAWERS



PRODUCT NO.
RV-NH__S3F_04__B

3 FRONT DRAWERS, COVER, PLASTIC BIN PANEL, UPRIGHT BUMPERS



PRODUCT NO.
RV-NH__A3X_02__B

3 FRONT DRAWERS, COVER, UTILITY PANEL, UPRIGHT BUMPERS



PRODUCT NO.
RV-NH__A3UC16__B¹

SIDE ROLL-OUT SHELF



PRODUCT NO.
RV-NH__00F_01

NOTE: ¹For this model without a rubber mat replace the letter C with L.

FRONT DRAWER,
2 SIDE ROLL-OUT HALF-SHELVES



PRODUCT NO.
RV-NH_A1F_06_B

2 FRONT DRAWERS,
2 SIDE ROLL-OUT HALF-SHELVES



PRODUCT NO.
RV-NH_A2F_06_B

2 FRONT DRAWERS,
2 SIDE ROLL-OUT HALF-SHELVES,
COVER, UTILITY PANEL



PRODUCT NO.
RV-NH_A2UC06_B¹

2 SIDE HALF-DRAWERS



PRODUCT NO.
RV-NH_B2F_02_B

FRONT DRAWER,
2 SIDE HALF-DRAWERS



PRODUCT NO.
RV-NH_M3F_02_B

2 SIDE ROLL-OUT HALF-SHELVES



PRODUCT NO.
RV-NH_00F_02

3 SHELVES



PRODUCT NO.
RV-NH_00K_07

3 SHELVES, UTILITY PANELS



PRODUCT NO.
RV-NH_00U_07

3 SHELVES WITH TOOL FOAM²,
UTILITY PANEL, LONG TOOL HOLDER



PRODUCT NO.
RV-NH_00U210²

NOTE: ¹For this model without a rubber mat replace the letter C with L. ²Sold without cut-outs.

PRECONFIGURED MODELS

36"W x 24"D CARTS

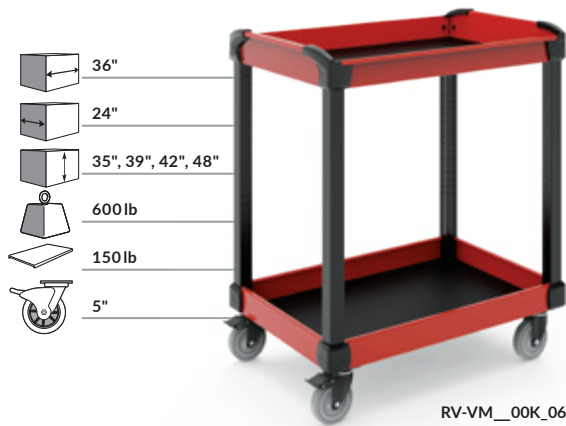

The 36"W x 24"D MultiTek Cart is ideal for transporting large parts. You will find it quickly becomes indispensable in your department.

- Total load capacity: 600lb.
- Add intermediate shelves to transport more items
- The top, intermediate and bottom shelves each have a 150lb. load capacity
- For available accessories, [see pages 192-193](#)

SPECIFY THE HEIGHT, MAT AND LOCK REQUIRED

Height: 35" = <u>35</u>	39" = <u>39</u>	Rubber Mat on each shelf: With = <u>0</u> Whitout = <u>1</u>
42" = <u>42</u>	48" = <u>48</u>	

RV-VM__00K_06

IMPORTANT

All models with shelves only are sold non-assembled.

2 SHELVES



PRODUCT NO.
RV-VM__00K_06

3 SHELVES



PRODUCT NO.
RV-VM__00K_08

4 SHELVES



PRODUCT NO.
RV-VM__00K_09

2 SHELVES, UTILITY PANELS



PRODUCT NO.
RV-VM__00U_06

3 SHELVES, UTILITY PANELS



PRODUCT NO.
RV-VM__00U_08

4 SHELVES, UTILITY PANELS



PRODUCT NO.
RV-VM__00U_09

48"W x 24"D CARTS

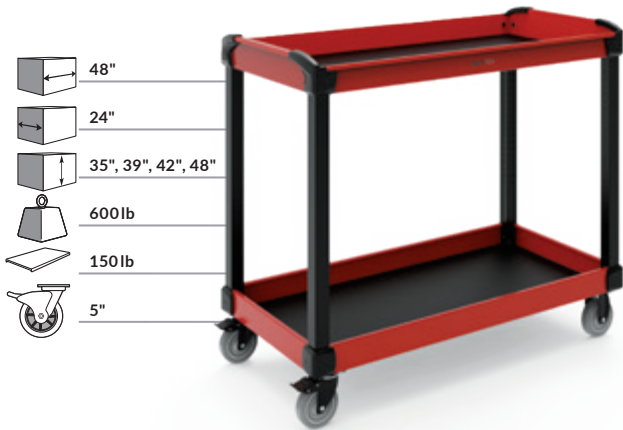

RV-ZM__00K_06

The 48"W x 24"D MultiTek Cart is ideal for transporting large parts. You will find it quickly becomes indispensable in your department.

- Total load capacity: 600lb.
- Add intermediate shelves to transport more items
- The top, intermediate and bottom shelves each have a 150lb. load capacity
- For available accessories, [see pages 192-193](#)

SPECIFY THE HEIGHT REQUIRED

Height: 35" = <u>35</u>	39" = <u>39</u>
42" = <u>42</u>	48" = <u>48</u>

Rubber Mat on each shelf:
With = 0 Whitout = 1

RV-ZM__00K_06

IMPORTANT
All models with shelves only are sold non-assembled.

2 SHELVES



PRODUCT NO.
RV-ZM__00K_06

3 SHELVES



PRODUCT NO.
RV-ZM__00K_08

4 SHELVES



PRODUCT NO.
RV-ZM__00K_09

2 SHELVES, UTILITY PANELS



PRODUCT NO.
RV-ZM__00U_06

3 SHELVES, UTILITY PANELS



PRODUCT NO.
RV-ZM__00U_08

4 SHELVES, UTILITY PANELS



PRODUCT NO.
RV-ZM__00U_09

ACCESSORIES

ACCESSORIES

INTERMEDIATE SHELF



RV25



- Load capacity: 150lb. per shelf, 600lb. max. per cart
- One or two shelves can be added to the cart
- Compatible with finishing panels, utility panels and plastic bin panels
- Thickness: 2"

PRODUCT NO.	W × D
RV25-2516	25" × 16"
RV25-3121	31" × 21"
RV25-3624	36" × 24"
RV25-4824	48" × 24"

NON-SLIP PVC LINER FOR SHELF



RV44 / RV74



- Protects items stored on a shelf
- One piece of 1/16"-thick
- To order a PVC Liner for a top or bottom shelf: [RV44](#)
- To order a PVC Liner for an intermediate shelf: [RV74](#)

PRODUCT NO.	W × D
RV_-2516-01	25" × 16"
RV_-3121-01	31" × 21"
RV_-3624-01	36" × 24"
RV_-4824-01	48" × 24"

TOOL FOAM FOR SHELF



RV47 / RV77

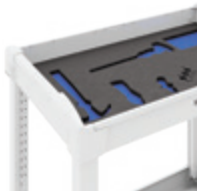

- Oil resistant and non-absorbent
- One piece of 1/4"-thick blue foam
- One piece of 1/2"-thick self-adhesive black foam
- To order tool foam for a top or bottom shelf: [RV47](#)
- To order tool foam for an intermediate shelf: [RV77](#)

PRODUCT NO.	W × D
RV_-2516-01	25" × 16"
RV_-3121-01	31" × 21"
RV_-3624-01	36" × 24"
RV_-4824-01	48" × 24"



Sold without cut-outs.

NOTE: Sold without cut-outs.

PROTECTIVE FOAM FOR SHELF



RV46 / RV76



- Protects items stored on a shelf
- One piece of 1/4"-thick blue foam
- To order protective foam for a top or bottom shelf: [RV46](#)
- To order protective foam for an intermediate shelf: [RV76](#)

PRODUCT NO.	W × D
RV_-2516-01	25" × 16"
RV_-3121-01	31" × 21"
RV_-3624-01	36" × 24"
RV_-4824-01	48" × 24"

UPRIGHT BUMPERS



RV63



- Kit of four protective bumpers
- Protects surrounding objects and the cart itself
- Made from soft PVC

PRODUCT NO.	MULTITEK CART (W × D)		
	25" × 16"	31" × 21"	36" × 24"
RV63-29	33"H	33"H	35"H
RV63-33	37"H	37"H	39"H
RV63-36		40"H	42"H
RV63-42			48"H

LONG TOOL HOLDER



WM9Q



- For storing long tools, e.g., pry bars
- Easy to install
- Holds up to three long tools;
- Space available for two smaller tools, e.g., screwdrivers

PRODUCT NO.	W × D × H
WM9Q-08	8" × 2" × 4"

NOTE: A range of holders, hooks and accessories are also available, see [pages 200-201](#).

PVC DRAWER LINER

RV40



- Protects items stored in drawers
- 1/16" thick
- Can be used under partitions and dividers

PRODUCT NO.	DRAWER	CART WIDTH
RV40-1623-01S	Side	25"
RV40-2131-01S	Side	31"
RV40-2131-01S2	Side Half	31"
RV40-2516-01F	Front	25"
RV40-3121-01F	Front	31"

PROTECTIVE FOAM FOR DRAWER

RV41

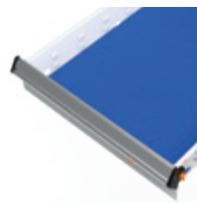

- Protects items stored in the drawer
- One piece of 1/4"-thick blue foam

PRODUCT NO.	DRAWER	CART WIDTH
RV41-1623-01S	Side	25"
RV41-2131-01S	Side	31"
RV41-2131-01S2	1/2 Side	31"
RV41-2516-01F	Front	25"
RV41-3121-01F	Front	31"

NOTE: Partitions and dividers cannot be installed in the same drawer as this foam.

TOOL FOAM FOR DRAWER

RV42

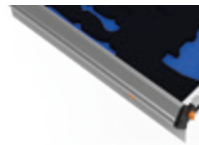

- Oil resistant and non-absorbent
- One piece of 1/4"-thick blue foam
- One piece of 1/2"-thick self-adhesive black foam

PRODUCT NO.	DRAWER	CART WIDTH
RV42-1623-01S	Side	25"
RV42-2131-01S	Side	31"
RV42-2131-01S2	1/2 Side	31"
RV42-2516-01F	Front	25"
RV42-3121-01F	Front	31"



Sold without cut-outs.

DRAWER LOCK



- Drawer can be locked with the same key used for other products (cover for the cart's shelf, tool box, storage cabinet, etc.)
- Does not reduce the drawer's storage space
- Easy to retrofit
- To order: Add L3 to the product number

PRODUCT NO.
L3

CASTERS



RV82 / RV83



- Available in two heights: 3" and 5"
- Sold in pairs
- Three types of casters available: fixed, swivel and swivel with brake
- Ultra-quiet casters
- Good chemical resistance

PRODUCT NO.	CASTER TYPE	HEIGHT	ACTUAL
RV82-01	Rigid	3"	4 1/4"
RV82-02	Swivel	3"	4 1/4"
RV82-03	Swivel with brake	3"	4 1/4"
RV83-01	Rigid	5"	6"
RV83-02	Swivel	5"	6"
RV83-03	Swivel with brake	5"	6"

NOTES: 25"W x 16"D and 31"W x 21"D MultiTek models include 3" wheels by default.
36"W x 24"D and 48"W x 24"D MultiTek models include 5" wheels by default.