

PARTS DEPARTMENT

A COMPLETE SOLUTION



We have been the experts in workspace storage and organization for over 70 years. In this time we have developed industry-leading expertise in parts department installations. You can therefore rest assured that all our products fulfill the strictest requirements for any dealership. All our products are designed, manufactured and rigorously tested in North America to meet the highest standards of engineering and quality.

The strength of our system is that it adapts to your environment and evolves with your needs. With the wide range of sizes and accessories available, you can create your own layouts and configurations to complement the installations you already have in place.

SERVICE COUNTERS



With our service counters, you can provide rapid, efficient and secure service to your customers. These workspaces can be fully personalized to ensure your most used items are always within easy reach. Placed exactly where you need it, your service counter will be an indispensable addition to your parts department.

Our products are customized to integrate into your unique environment and the space you have available. From corner workstations to counter cabinets, our scalable service counters offer the perfect blend of aesthetics and ergonomics.

PARTS DEPARTMENT



SPECIALIZED STORAGE

106-109

With our storage solutions, your parts are stored to make them easy to handle and completely secure. With racks available for any requirement, there's dedicated storage for every part: moldings, bumpers, exhaust pipes, tires, etc. Our specialists will also support you throughout the process, so you can take full advantage of everything our specialized storage has to offer.

By choosing our solutions, you ensure your parts department is optimally organized, and your inventory management is as efficient as possible.

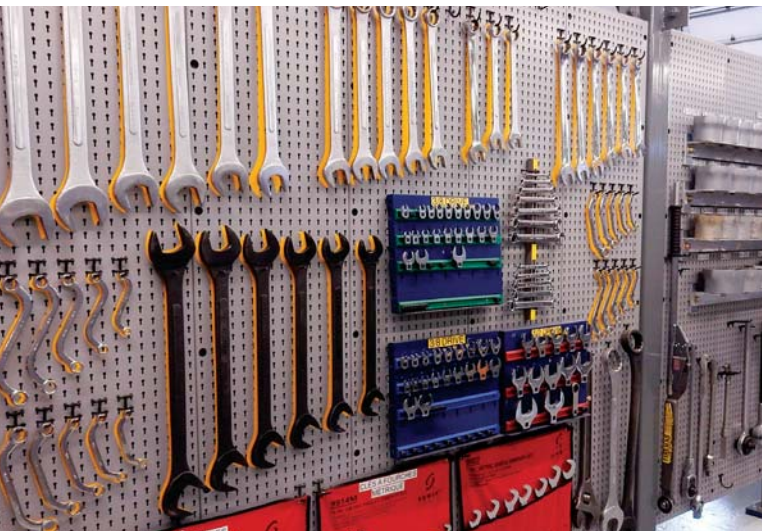

STORAGE

118-119

Rousseau's various storage solutions can be used to apply the Japanese 5S method. We have a range of products specially designed to optimize organization of your work area by assigning a specific place for each item. From hooks to tool holders to adhesive identification labels, everything has been designed to create a safe environment that facilitates inventory management and helps your staff to move around and work efficiently.



MULTITEK CART

114

When parts are located far away from the service counter, the MultiTek Cart is your best friend. It offers a safe and secure way to rapidly transport parts of different sizes from A to B.

Built for heavy-duty tasks, the premium-quality MultiTek Cart is available in various dimensions and can be equipped with a range of accessories, which makes it incredibly versatile and perfectly adapted to automotive dealership environments. And by adding shelves with a 150lb. load capacity, you can transport more items in one go, saving you precious time and energy.



DRAWERS FOR SHELVING

99-100

By adding drawers to your shelving, you can recover 50% to 70% of your floor space. This can help you reduce the size of your parts department, leaving more room available for money-making departments like the service department or showroom. And with our drawer subdividing and labeling accessories, it's also much easier and quicker to locate the parts you need, saving you time and effort. Great savings that will surpass your expectations!

MAIN BENEFITS:

- More parts stored in the same space
- Less time spent searching for parts
- Less time spent by your mechanics waiting at the service counter
- More time for vehicle maintenance
- More time for your customers

Rousseau drawers add value to your existing equipment. They can be installed in more than 35 brands of shelving on the market.

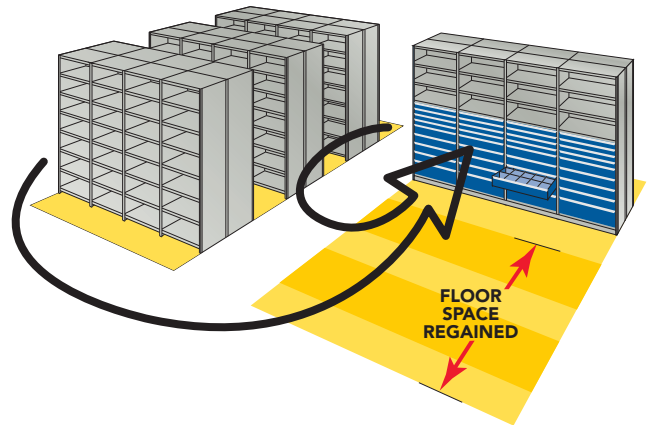
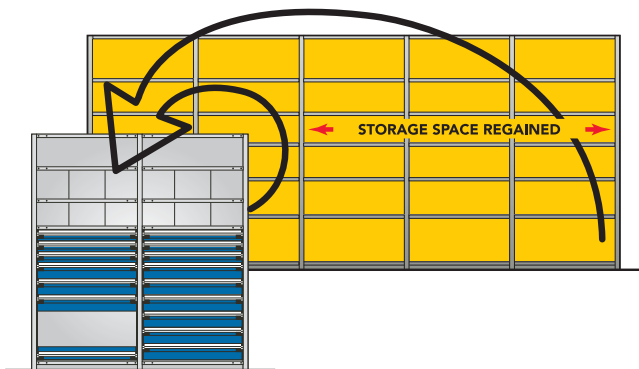

CURRENT SITUATION

- 1 Top and bottom shelves are not properly filled and hard to access
- 2 Backs of shelves are poorly lit
- 3 Shelves obstruct line of sight for stored items
- 4 Huge amount of unused space between shelves

RESULT

An inefficient system that makes finding items and managing inventory a laborious task

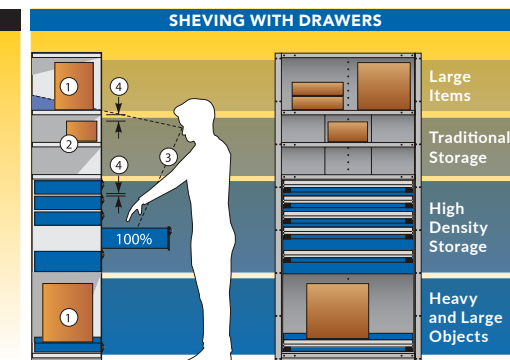
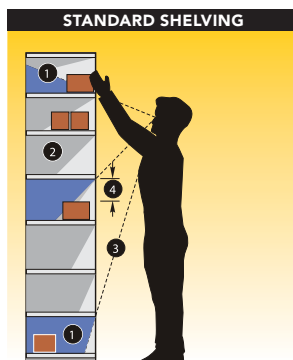

OUR RECOMMENDATIONS

- 1 Widely spaced shelves for storage of larger items
- 2 Close-set shelves positioned at eye level
- 3 Drawers that open to full extension for easily locating objects
- 4 Optimized use of space based on the size of stored items

RESULT

An organized and efficient storage system that enables easier inventory management

SMALL AND MEDIUM-SIZED PARTS STORAGE

MUCH MORE THAN A SIMPLE SHELVING UNIT



Our Spider® Shelving system is perfect for day-to-day parts, special orders and parts you need to keep in stock for warranties. It's the most versatile and complete solution of its type on the market! Thanks to its unique design, it is extremely easy to configure and add accessories.

- The only system that allows you to alternate shelves (medium-sized parts) and steel decking (large parts)
- Our common post reduces the number of posts needed by 25%, leaving more space for storage
- When planning tomorrow's needs today, make Spider® Shelving the heart of your multi-level shelving system



SRP0142



SRP0144

SHELVING FOR MEDIUM-SIZED PARTS

- Add drawers to combine storage of small and large items
- BOX shelves are adjustable in 1" increments c/c



W x D x H	NO. OF SHELVES	OPEN	CLOSED
36" x 18" x 75"	7	SRP0101	SRP0103
36" x 24" x 75"	7	SRP0102	SRP0104
36" x 18" x 87"	8	SRP0111	SRP0113
36" x 24" x 87"	8	SRP0112	SRP0114
36" x 18" x 99"	9	SRP0121	SRP0123
36" x 24" x 99"	9	SRP0122	SRP0124
48" x 18" x 75"	7	SRP0131	SRP0133
48" x 24" x 75"	7	SRP0132	SRP0134
48" x 18" x 87"	8	SRP0141	SRP0143
48" x 24" x 87"	8	SRP0142	SRP0144
48" x 18" x 99"	9	SRP0151	SRP0153
48" x 24" x 99"	9	SRP0152	SRP0154

SHELVING WITH SLOPED SHELVES

- The 15-degree angle provides excellent visibility of stored items and is ideal for gravity flow storage
- Includes a heavy-duty front edge to keep stored items in place
- Sloped shelves and non-sloped SH20 BOX shelves can be combined in the same unit



OPEN

SRE1T-EE750501



CLOSED

SRE2T-EE750501



FIFO

SRK1F-EE750501

W x D x H	NO. OF SHELVES	OPEN	CLOSED	FIFO
	5	SRE1T-EC750501	SRE2T-EC750501	SRK1F-EC750501
36" x 24" x 75"	5	SRE1T-EE750501	SRE2T-EE750501	SRK1F-EE750501
36" x 18" x 87"	6	SRE1T-EC870601	SRE2T-EC870601	SRK1F-EC870601
36" x 24" x 87"	6	SRE1T-EE870601	SRE2T-EE870601	SRK1F-EE870601
36" x 18" x 99"	6	SRE1T-EC990601	SRE2T-EC990601	SRK1F-EC990601
36" x 24" x 99"	6	SRE1T-EE990601	SRE2T-EE990601	SRK1F-EE990601
48" x 18" x 75"	5	SRE1T-HC750501	SRE2T-HC750501	SRK1F-HC750501
48" x 24" x 75"	5	SRE1T-HE750501	SRE2T-HE750501	SRK1F-HE750501
48" x 18" x 87"	6	SRE1T-HC870601	SRE2T-HC870601	SRK1F-HC870601
48" x 24" x 87"	6	SRE1T-HE870601	SRE2T-HE870601	SRK1F-HE870601
48" x 18" x 99"	6	SRE1T-HC990601	SRE2T-HC990601	SRK1F-HC990601
48" x 24" x 99"	6	SRE1T-HE990601	SRE2T-HE990601	SRK1F-HE990601

SMALL AND MEDIUM-SIZED PARTS STORAGE

SHELVING WITH DRAWERS



10 DRAWERS

W x D	HEIGHT/NO. OF USABLE SHELVES			NO. OF COMPARTMENTS	
	75" / 3	87" / 4	99" / 5	Total	Per drawer
36" x 18"	R5SEC-754851_	R5SEC-874851_	R5SEC-994851_	200	20
36" x 24"	R5SEE-754851_	R5SEE-874851_	R5SEE-994851_	250	25
48" x 18"	R5SHC-754851_	R5SHC-874851_	R5SHC-994851_	240	24
48" x 24"	R5SHE-754851_	R5SHE-874851_	R5SHE-994851_	300	30

NOTE: To order an add-on unit, add **A** to the product number.



8 DRAWERS, 1 ROLL-OUT SHELF

W x D	HEIGHT/NO. OF USABLE SHELVES			NO. OF COMPARTMENTS	
	75" / 3	87" / 4	99" / 5	Total	Per drawer
36" x 18"	R5SEC-754857_	R5SEC-874857_	R5SEC-994857_	160	20
36" x 24"	R5SEE-754857_	R5SEE-874857_	R5SEE-994857_	200	25
48" x 18"	R5SHC-754857_	R5SHC-874857_	R5SHC-994857_	192	24
48" x 24"	R5SHE-754857_	R5SHE-874857_	R5SHE-994857_	240	30

NOTE: To order an add-on unit, add **A** to the product number.



9 DRAWERS

W x D	HEIGHT/NO. OF USABLE SHELVES			NO. OF COMPARTMENTS	
	75" / 3	87" / 4	99" / 5	Total	Per drawer
36" x 18"	R5SEC-754853_	R5SEC-874853_	R5SEC-994853_	180	20
36" x 24"	R5SEE-754853_	R5SEE-874853_	R5SEE-994853_	225	25
48" x 18"	R5SHC-754853_	R5SHC-874853_	R5SHC-994853_	216	24
48" x 24"	R5SHE-754853_	R5SHE-874853_	R5SHE-994853_	270	30

NOTE: To order an add-on unit, add **A** to the product number.



7 DRAWERS, 1 ROLL-OUT SHELF

W x D	HEIGHT/NO. OF USABLE SHELVES			NO. OF COMPARTMENTS	
	75" / 3	87" / 4	99" / 5	Total	Per drawer
36" x 18"	R5SEC-754855_	R5SEC-874855_	R5SEC-994855_	140	20
36" x 24"	R5SEE-754855_	R5SEE-874855_	R5SEE-994855_	175	25
48" x 18"	R5SHC-754855_	R5SHC-874855_	R5SHC-994855_	168	24
48" x 24"	R5SHE-754855_	R5SHE-874855_	R5SHE-994855_	210	30

NOTE: To order an add-on unit, add **A** to the product number.

NOTES: 42"W shelving with drawers is also available. Contact us for more information.



Shelving with drawers must be anchored to the floor.



SMALL AND MEDIUM-SIZED PARTS STORAGE

BANKS OF DRAWERS FOR SHELVING

Rousseau drawers can be installed in over 35 shelving brands available on the market. You can therefore keep your existing installations and still make significant space saving gains.



4 DRAWERS - 18"H

PRODUCT NO.	W x D	NO. OF COMPARTMENTS
R5LEC-1801	36" x 18"	80
R5LEE-1801	36" x 24"	102
R5LGC-1801	42" x 18"	66
R5LGE-1801	42" x 24"	102
R5LHC-1801	48" x 18"	106
R5LHE-1801	48" x 24"	135



5 DRAWERS - 24"H

PRODUCT NO.	W x D	NO. OF COMPARTMENTS
R5LEC-2401	36" x 18"	88
R5LEE-2401	36" x 24"	114
R5LGC-2401	42" x 18"	78
R5LGE-2401	42" x 24"	114
R5LHC-2401	48" x 18"	116
R5LHE-2401	48" x 24"	150



7 DRAWERS - 36"H

PRODUCT NO.	W x D	NO. OF COMPARTMENTS
R5LEC-3601	36" x 18"	104
R5LEE-3601	36" x 24"	138
R5LGC-3601	42" x 18"	102
R5LGE-3601	42" x 24"	138
R5LHC-3601	48" x 18"	136
R5LHE-3601	48" x 24"	180



7 DRAWERS - 36"H

PRODUCT NO.	W x D	NO. OF COMPARTMENTS
R5LEC-3603	36" x 18"	120
R5LEE-3603	36" x 24"	156
R5LGC-3603	42" x 18"	108
R5LGE-3603	42" x 24"	156
R5LHC-3603	48" x 18"	158
R5LHE-3603	48" x 24"	205



8 DRAWERS - 48"H

PRODUCT NO.	W x D	NO. OF COMPARTMENTS
R5LEC-4801	36" x 18"	64
R5LEE-4801	36" x 24"	96
R5LGC-4801	42" x 18"	96
R5LGE-4801	42" x 24"	96
R5LHC-4801	48" x 18"	80
R5LHE-4801	48" x 24"	120



7 DRAWERS, 1 ROLL-OUT SHELF - 48"H

PRODUCT NO.	W x D	NO. OF COMPARTMENTS
R5LEC-4809	36" x 18"	136
R5LEE-4809	36" x 24"	174
R5LGC-4809	42" x 18"	114
R5LGE-4809	42" x 24"	174
R5LHC-4809	48" x 18"	180
R5LHE-4809	48" x 24"	230

NOTES: Shelving units must be ordered separately.

Shelving with drawers must be anchored to the floor.



SMALL AND MEDIUM-SIZED PARTS STORAGE

CABINETS WITH DRAWERS



DO YOU NEED MAXIMUM FLEXIBILITY?

Are you constantly rearranging your parts department or planning a remodel in the future? No problem! Choose a solution that makes the job easier: cabinets with drawers. With our selection of forklift bases, you can rest assured that moving them is fast, efficient and safe.

STACKING CABINETS

Stacking cabinets allow you to add storage for medium-sized parts above your small parts storage. For parts that require safekeeping, our doors with locks give you the security you need.



- Includes one adjustable shelf (adjustable in 1" increments c/c) and one bottom shelf
- Available with or without door (lock included on every door)

W × D × H	WITHOUT DOOR	WITH DOUBLE INTEGRATED DOORS
36" × 18" × 24"	R5HEC-2400	R5HEC-2403
36" × 18" × 30"	R5HEC-3000	R5HEC-3003
36" × 24" × 24"	R5HEE-2400	R5HEE-2403
36" × 24" × 30"	R5HEE-3000	R5HEE-3003
48" × 24" × 24"	R5HHE-2400	R5HHE-2403
48" × 24" × 30"	R5HHE-3000	R5HHE-3003
48" × 27" × 24"	R5HHG-2400	R5HHG-2403
48" × 27" × 30"	R5HHG-3000	R5HHG-3003

CABINETS WITH DRAWERS



8 DRAWERS

W × D × H	PRODUCT NO.	NO. OF COMPARTMENTS
36" × 18" × 60"	R5AEC-5835	64
36" × 24" × 60"	R5AEE-5835	96
48" × 24" × 60"	R5AHE-5815	120
48" × 27" × 60"	R5AHG-5815	120



10 DRAWERS

W × D	PRODUCT NO.	NO. OF COMPARTMENTS
36" × 18" × 60"	R5AEC-5837	160
36" × 24" × 60"	R5AEE-5837	210
48" × 24" × 60"	R5AHE-5817	275
48" × 27" × 60"	R5AHG-5817	235

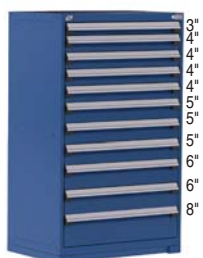

11 DRAWERS

W × D × H	PRODUCT NO.	NO. OF COMPARTMENTS
36" × 18" × 60"	R5AEC-5839	216
36" × 24" × 60"	R5AEE-5839	276
48" × 24" × 60"	R5AHE-5819	365
48" × 27" × 60"	R5AHG-5819	301

NOTES: Other dimensions available. Please contact us.
Lock included on each cabinet.



SMALL AND MEDIUM-SIZED PARTS STORAGE

SHELVING ACCESSORIES



With our shelving accessories, you can make use of all available space while resolving your storage challenges. The unique shape of the Spider® post is a Rousseau Metal Inc. trademark.

Cut back on wasted time and materials. Each item is stored in its proper place, clearly labeled and easy to locate. See **pages 118-119** for a range of Rousseau accessories that help you integrate the 5S methodology into the storage solution of your dealership's parts department.



FULL HEIGHT UTILITY PANEL



- With the side utility panel you can make the most of unused space at the end of aisles.
- Compatible with light-duty and heavy-duty hooks WM9F / WM9G / WM9H / WM9J / WM9A and WM9B hooks;
- Also compatible with WM9C / WM9D / WM9L / WM9N / WM9M / WM9Q supports and WM21 tiltable shelf;
- The holes are spaced 1" c/c, giving you many possibilities when configuring your hooks.

PRODUCT #	D × H
SH69-1875	18" × 75"
SH69-1887	18" × 87"
SH69-2475	24" × 75"
SH69-2487	24" × 87"

BACK UTILITY PANEL

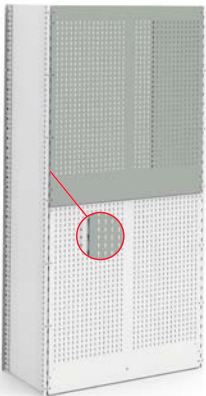

- Use the space on the back of shelving units with this panel.
- Two versions available: retrofit (SR79) or structural (SH79)
- Compatible with light-duty and heavy-duty hooks (WM9F / WM9G / WM9H / WM9J / WM9A and WM9B)
- Also compatible with plastic bin rails (WM9C), can holders (WM9D), tool holders (WM9L / WM9N / WM9M / WM9Q) and tiltable shelves (WM21)
- The holes are spaced 1" apart c/c, which provides many options for hook placement

PRODUCT NO.	W × H
S_79-3639	36" × 39"
S_79-3651	36" × 51"
S_79-4839	48" × 39"
S_79-4851	48" × 51"

FINISHING PANEL

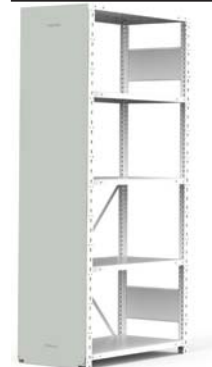

- Finishing panel for end-of-aisle shelving units
- Quick and easy hook-on assembly
- Creates a neater appearance
- Compatible with certain multi-level shelving applications. Contact Customer Service for more information

PRODUCT NO.	HEIGHT
SH37-__075	75"
SH37-__087	87"

NOTE: Add **R** to the product number for retrofit or **H** for structural.

NOTE: Complete the product number with the depth required: **18"** or **24"**.

SMALL AND MEDIUM-SIZED PARTS STORAGE

BACK OR SIDE PLASTIC BIN PANEL



Make the most of the space available on the sides or inside of your shelving to store small parts close by.

- Compatible with RG20 plastic bins and all brands of plastic bins with hanging lip on the market



PRODUCT NO.	TYPE	W × H
SH65-3614	Back	36" × 14"
SH65-3620	Back	36" × 20"
SH65-3632	Back	36" × 32"
SH65-4814	Back	48" × 14"
SH65-4820	Back	48" × 20"
SH65-4832	Back	48" × 32"

PRODUCT NO.	TYPE	D × H
SH66-1814	Side	18" × 14"
SH66-1820	Side	18" × 20"
SH66-1832	Side	18" × 32"
SH66-2414	Side	24" × 14"
SH66-2420	Side	24" × 20"
SH66-2432	Side	24" × 32"

BACK OR SIDE UTILITY PANEL



Make the most of the space available on the sides or inside of your shelving to store frequently used parts and tools close by.

- Compatible with light-duty and heavy-duty hooks (WM9F/WM9G/WM9H/WM9J/WM9A and WM9B)
- Also compatible with plastic bin rails (WM9C), can holders (WM9D), tool holders (WM9L/WM9N/WM9M/WM9Q) and tiltable shelves (WM21)
- The holes are spaced 1" apart c/c, which provides many options for hook placement



PRODUCT NO.	TYPE	W × H
SH67-3614	Back	36" × 14"
SH67-3620	Back	36" × 20"
SH67-3632	Back	36" × 32"
SH67-4814	Back	48" × 14"
SH67-4820	Back	48" × 20"
SH67-4832	Back	48" × 32"

PRODUCT NO.	TYPE	D × H
SH68-1814	Side	18" × 14"
SH68-1820	Side	18" × 20"
SH68-1832	Side	18" × 32"
SH68-2414	Side	24" × 14"
SH68-2420	Side	24" × 20"
SH68-2432	Side	24" × 32"

SHELF DIVIDER



- Shelf dividers are used to subdivide shelves and support stored items
- Tool-free installation and easily reconfigured

PRODUCT NO.	TYPE	D × H
SH50-1809	Full height	18" × 9"
SH50-1815	Full height	18" × 15"
SH50-2409	Full height	24" × 9"
SH50-2415	Full height	24" × 15"

SH52-1806	Partial divider	13 1/2"D for 18"D shelves
SH52-2406	Partial divider	19 1/2"D for 24"D shelves

LED LIGHT FOR SPIDER® SHELVING



- Brightens shaded areas under shelves
- Can be installed under shelves
- Brighter and more energy efficient than a fluorescent tube

PRODUCT NO.	FOR
SH95-01	30"W or 36"W shelves
SH95-02	42"W or 48"W shelves

SPOOL HOLDER



- Designed so the bar can be pivoted to help with changing spools.
- Each bar has a 50lb. load capacity and a diameter of 3/4" (compatible with most spools on the market)

PRODUCT NO.	NO. OF RAILS	W × D
SH72-3618-01	1	36" × 18"
SH72-3618-02	2	36" × 18"
SH72-3624-01	1	36" × 24"
SH72-3624-02	2	36" × 24"
SH72-4818-01	1	48" × 18"
SH72-4818-02	2	48" × 18"
SH72-4824-01	1	48" × 24"
SH72-4824-02	2	48" × 24"



SMALL AND MEDIUM-SIZED PARTS STORAGE

LEVELING GLIDE KIT



- Adjusts the height of Spider® Shelving units from 1¼" to 2⅝" on uneven surfaces
- Load capacity: maximum 750lb. per glide
- Restrictions:
 - Only compatible with 99"H shelving or shorter
 - Only compatible with SR uprights and posts
 - Not compatible with modular drawers (RF32, RF36), roll-out shelves (RF41, RF45), SH28 bases, or SH uprights and posts
- Sold in pairs

PRODUCT NO.
SR49-01

FLIPPER DOOR FOR SPIDER® SHELVING



- Ideal for safe storage of small amounts of equipment and confidential files.
- 14"H door for folder storage
- 16"H door for binder storage"

PRODUCT NO.	W × D
SH85-3618_	36" × 18"
SH85-3624_	36" × 24"
SH85-4818_	48" × 18"
SH85-4824_	48" × 24"

NOTES: Complete the product number with the height required: **14", 16", 17" or 18"**.
Complete **L3** for a standard lock or **L50** for an electronic door lock.

LABEL HOLDER FOR SHELF



- Self-adhesive and magnetic versions are available. The wide surface makes it adhere well to the shelf.

PRODUCT NO.	TYPE	W × H
SH82-600	Magnetic Label Holder	6" × 1"
SH81-36	Self-Adhesive Label Holder	36" × 1"
SH81-48	Self-Adhesive Label Holder	48" × 1"

NOTE: Labels (RG53) are available in packs of 200.

MOBILE SHELVING



- Preconfigured models include open shelving uprights, braces, BOX shelves, a mobile base for Spider® shelving and four 4" casters (2 swivel casters with total-lock brake system and 2 rigid casters)
- Load capacity: 1000lb. per base
- All preconfigured models are quick and easy to assemble and can be disassembled when not in use

W × D × H	OPEN
36" × 18" × 63"	SRE4001M
36" × 24" × 63"	SRE4002M
36" × 24" × 75"	SRE4003M
48" × 18" × 63"	SRE4007M
48" × 24" × 63"	SRE4008M
48" × 24" × 75"	SRE4009M

NOTE: Preconfigured models have six usable shelves.



SMALL AND MEDIUM-SIZED PARTS STORAGE

SOLID DOORS WITH FRAME



SRE3205

- Designed for shelving with or without drawers, Rousseau doors store equipment safely and protect it from dirt
- Ideal for expensive parts, such as car radios
- Doors open 180° with a locking mechanism integrated into the handle

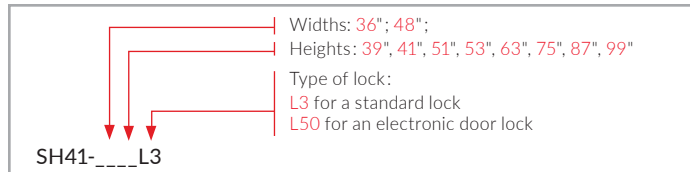

POLYCARBONATE DOORS WITH FRAME



SRE3204

- Designed for shelving with or without drawers, Rousseau doors store equipment safely and protect it from dirt
- Ideal for expensive parts, such as promotional items
- Polycarbonate panels ensure contents are visible
- Excellent impact resistance
- Doors open 180° with a locking mechanism integrated into the handle

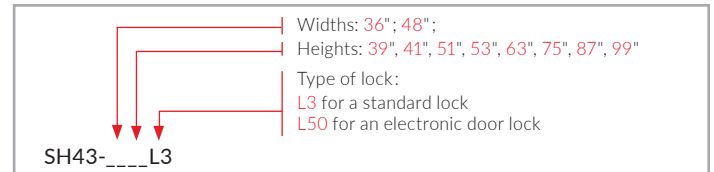

STACKED SOLID DOORS WITH FRAME



R5SEE-871813

- These doors install in the top part of Spider® Shelving over a bank of drawers without obstructing them
- Ideal for storage and keeping work areas tidy
- Ideal for storing expensive parts or slow-moving inventory
- Doors open fully on 180° hinges, allowing shelving contents to be visible and easily accessible
- The sturdy handle includes a lock
- See technical guide S64 for all available dimensions

STACKED POLYCARBONATE DOORS WITH FRAME



R5SEE-871815

- These doors install in the top part of Spider® Shelving over a bank of drawers without obstructing them
- Ideal for storage and keeping work areas tidy
- The polycarbonate panels ensure shelving contents are visible and have excellent impact resistance
- Ideal for storing expensive parts or slow-moving inventory
- Doors open fully on 180° hinges, allowing shelving contents to be visible and easily accessible
- The sturdy handle includes a lock
- See technical guide S64 for all available dimensions

Important: Refer to technical guide S64 Spider® Shelving Doors - Layouts and Dimensions for recommended configurations and all possible combinations.

DISTINCTIVE FEATURES



Door opens by turning handle to the left or right.



Door closes with a simple push.



Electronic lock: easier management of door access permissions.



R5SEE-871807



R5SEE-871811

SPECIALIZED STORAGE

A SOLUTION FOR EVERY NEED



What's the best way to store mufflers, bumpers, bodywork parts, batteries, tires and other items with unique shapes and sizes? The solution is simple: Rousseau specialized storage racks. These racks are the perfect way to make your parts department both efficient and tidy.



HANGING RACK FOR ASSORTED PARTS



- These racks are ideal for hanging exhaust pipes and any other item
- Available with one or two rails and includes hooks
- Three steel decking levels for storing large parts
- Extra hook (SR63-02)

SRP0404

DOUBLE HANGING RACK FOR ASSORTED PARTS



- Easily find what you are looking for!
- This two-level hanging rack can be used to store many items of different shapes and sizes
- Available with two or four rails and includes hooks
- Three steel decking levels for storing large parts
- Extra hook (SR63-02)

SRP2404

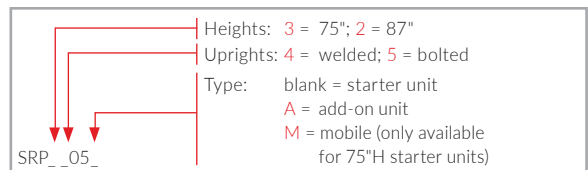
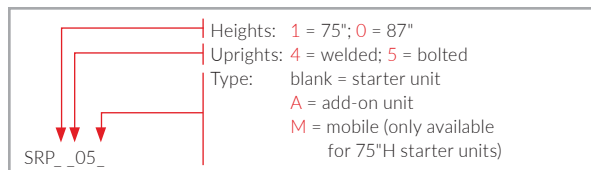

W × D	NO. OF RAILS (HOOKS)	PRODUCT NO.
60" × 36"	1 (15)	SRP_05_
60" × 36"	2 (30)	SRP_06_
72" × 36"	1 (15)	SRP_03_
72" × 36"	2 (30)	SRP_04_
96" × 36"	1 (25)	SRP_07_
96" × 36"	2 (45)	SRP_08_

W × D	NO. OF RAILS (HOOKS)	PRODUCT NO.
60" × 36"	2 (30)	SRP_05_
60" × 36"	4 (60)	SRP_06_
72" × 36"	2 (30)	SRP_03_
72" × 36"	4 (60)	SRP_04_
96" × 36"	2 (50)	SRP_07_
96" × 36"	4 (90)	SRP_08_

SINGLE MAT RACK



SRP0473

- Designed for hanging mats on one level
- Available with one or two rails
- Three steel decking levels for storing large parts

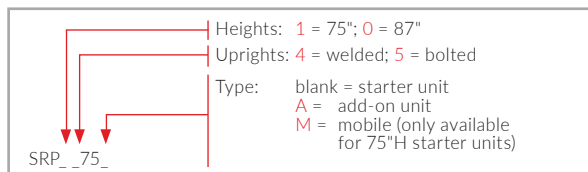

W x D	NO. OF RAILS	PRODUCT NO.
60" x 36"	1	SRP_ _75_
60" x 36"	2	SRP_ _76_
72" x 36"	1	SRP_ _73_
72" x 36"	2	SRP_ _74_
96" x 36"	1	SRP_ _77_
96" x 36"	2	SRP_ _78_

DOUBLE MAT RACK



SRP2473

- Designed for hanging mats on two levels
- Available with two or four rails
- Three steel decking levels for storing large parts

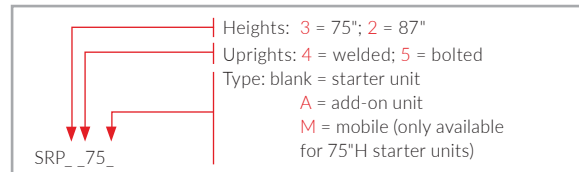

W x D	NO. OF RAILS	PRODUCT NO.
60" x 36"	2	SRP_ _75_
60" x 36"	4	SRP_ _76_
72" x 36"	2	SRP_ _73_
72" x 36"	4	SRP_ _74_
96" x 36"	2	SRP_ _77_
96" x 36"	4	SRP_ _78_

BUMPER AND PIPE RACK



SRP0420

- For storage of pipes and bumpers with space on top for other items
- Includes dividers to separate parts resting on the bottom of the unit
- The divider can be adjusted laterally without tools
- Extra single divider (SR61-2401)



W x D x H	NO. OF DIVIDERS	PRODUCT NO.
60" x 36" x 75"	4	SRP1421_
60" x 48" x 75"	4	SRP2421_
60" x 36" x 87"	4	SRP0421_
60" x 48" x 87"	4	SRP3421_
72" x 36" x 75"	4	SRP1420_
72" x 48" x 75"	4	SRP2420_
72" x 36" x 87"	4	SRP0420_
72" x 48" x 87"	4	SRP3420_
96" x 36" x 75"	6	SRP1422_
96" x 48" x 75"	6	SRP2422_
96" x 36" x 87"	6	SRP0422_
96" x 48" x 87"	6	SRP3422_

NOTES: Mobile version only available for 75"H starter units.

For an add-on unit, add **A** to the product number. For a mobile rack, add **M** to the product number.

SHEET METAL RACK



SRP0430

- Supports parts and boxes stored vertically in the unit
- The divider can be adjusted laterally without tools
- Extra double divider (SR60-2415)



W x D x H	NO. OF DIVIDERS	PRODUCT NO.
60" x 36" x 75"	2	SRP1431_
60" x 48" x 75"	2	SRP2431_
60" x 36" x 87"	2	SRP0431_
60" x 48" x 87"	2	SRP3431_
72" x 36" x 75"	2	SRP1430_
72" x 48" x 75"	2	SRP2430_
72" x 36" x 87"	2	SRP0430_
72" x 48" x 87"	2	SRP3430_
96" x 36" x 75"	3	SRP1432_
96" x 48" x 75"	3	SRP2432_
96" x 36" x 87"	3	SRP0432_
96" x 48" x 87"	3	SRP3432_

NOTES: Mobile version only available for 75"H starter units.

For an add-on unit, add **A** to the product number. For a mobile rack, add **M** to the product number.

SPECIALIZED STORAGE

WINDSHIELD RACK



SRP0481

- This rack provides secure storage for windshields and includes dividing rods.
- Includes a steel shelf at the top for extra storage space
- Includes stainless steel dividing rods

W × D × H	NO. OF USABLE SPACES	PRODUCT NO.
72" × 48" × 87"	7	SRP0481_
96" × 48" × 87"	7	SRP0480_

NOTE: To order an add-on unit, add **A** to the product number.

HOOD RACK



SRP0450

- This rack is designed to hold heavy boxes. There is no bottom shelf so heavy items can slide in without being lifted.
- Includes two steel shelves at the top for extra storage space

W × D × H	PRODUCT NO.
48" × 48" × 75"	SRP2450_
48" × 48" × 87"	SRP0450_
60" × 48" × 75"	SRP2451_
60" × 48" × 87"	SRP0451_



NOTES: To order an add-on unit, add **A** to the product number.

Hood racks must be anchored to the floor (anchoring kit included).

MOLDING RACK



SRP0410

- The dividing rods are designed to provide efficient storage for most molding sizes available.
- Includes stainless steel dividing rods

W × D × H	NO. OF SPACES	NO. OF SHELVES	PRODUCT NO.
36" × 48" × 75"	54	9	SRP0413_
36" × 48" × 87"	66	11	SRP0411_
48" × 48" × 75"	72	9	SRP0412_
48" × 48" × 87"	88	11	SRP0410_

NOTE: To order an add-on unit, add **A** to the product number.

HIGH-DENSITY MAT RACK



- This unit stores a large number of mats and includes dividing rods.
- Includes three steel shelves for storing mats vertically
- Includes one steel shelf at the top for extra storage space
- Includes stainless steel dividing rods

W × D × H	PRODUCT NO.
60" × 36" × 87"	SRP0482_

NOTE: To order an add-on unit, add **A** to the product number.

DOUBLE BUMPER RACK



WMA3510

- Double racks can hold up to 12 bumpers. Several models are available, including stationary and mobile versions.
- The support arms are easily reconfigured, removed and stored as needed without tools

W × D × H	VERSION	PRODUCT NO.
45" × 42" × 85 1/2"	Standard version	WMA3510
45" × 42" × 87"	With leveling glide kit	WMA3511
45" × 42" × 91"	With 4" casters: 2 rigid and 2 swivel with total-lock brake	WMA3512
45" × 42" × 91"	With 4" casters: 2 swivel and 2 swivel with total-lock brake	WMA3513

WALL-MOUNTED BUMPER RACK



- Wall-mounted racks can hold up to six bumpers.
- The support arms are easily reconfigured, removed and stored as needed without tools
- Load capacity: 300lb. (if wall and wall anchoring are of sufficient strength)

W × D × H	PRODUCT NO.
45" × 23" × 72"	WMP1000

SPECIALIZED STORAGE

TIRE RACK



SRP0442

- With Rousseau tire racks, you can efficiently store, quickly identify and easily access all your tires.
- The angled beams provide excellent support for your tires
- The rack can also be used to store rims and wheels
- The single row version includes a wall spacer, while the double row version includes a unit spacer

W x D x H	VERSION	PRODUCT NO.
60" x 15" x 87"	Single	SRP0443_
60" x 48" x 87"	Double	SRP0444_
72" x 15" x 87"	Single	SRP0441_
72" x 48" x 87"	Double	SRP0442_

NOTE: To order an add-on unit, add **A** to the product number.

BATTERY RACK



SRP0461

- The battery shelves are sloped 15° for easier battery rotation (first in, first out)
- Each level has a stop at the front and two guides on the sides to prevent batteries from falling accidentally
- 87"H models also include one steel decking level

W x D x H	NO. OF SHELVES	PRODUCT NO.
36" x 36" x 39"	2	SRP0464_
36" x 36" x 51"	3	SRP0465_
48" x 36" x 75"	4	SRP0460_
48" x 48" x 75"	4	SRP0461_
48" x 36" x 87"	4	SRP0462_
48" x 48" x 87"	4	SRP0463_

NOTES: Mobile version only available for 75"H starter units or shorter.

For an add-on unit, add **A** to the product number.

For a mobile rack, add **M** to the product number.

RECORD STORAGE SYSTEM



- Save between 10% and 15% of shelving space compared to similar products on the market.
- Designed to accommodate all popular sizes of record storage boxes
- Capacity: up to 80 boxes
- Shelving and Mini-Racking units are available in many dimensions. Contact our specialists for more information

KEY CUTTING STATION



- This unit makes cutting keys easy by ensuring everything is within easy reach.
- 1 roll-out shelf, 100% extension to accommodate the cutting machine
- 2 drawers (3"H) for storing keys and small parts
- 4 steel shelves for storing larger items

W x D x H	PRODUCT NO.
36" x 24" x 87"	R5SEE-871202



LARGE PARTS STORAGE

MINI-RACKING FOR LARGE PARTS



SRP0286

Mini-Racking is designed for storing large and heavy parts. With a wide choice of dimensions and decks, you can configure the units to fully meet your specific requirements.

There are three options available: steel decking, wire-mesh decking and wood decking.

MINI-RACKING WITH CHOICE OF DECKING

STEEL

To order a unit with steel decking, add **S** to the product number.



SRB5127S

SRE5127S

WIRE MESH

To order a unit with wire-mesh shelves, add **W** to the product number. Available for 48"W, 60"W, 72"W and 96"W units and 24"D, 36"D and 48"D.



SRB5127W

SRE5127W

WOOD

To order a unit without decking (e.g., for use with wood decking), leave the product number as is.



SRB5127

SRE5127

HOW TO ORDER

When ordering, model numbers must be completed as follows:

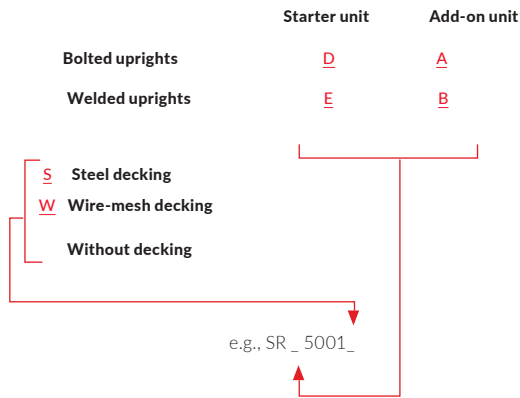

e.g., SRD5001S

For a starter unit (48"W x 18"D x 75"H) with bolted uprights and steel decking

MINI-RACKING WITH MEDIUM-DUTY AND HEAVY-DUTY BEAMS

MEDIUM-DUTY BEAMS

Dimensions			No. of Decking Levels	
W	D	H	3	4
48"	18"	75"	SR_5001_	SR_5021_
24"			SR_5002_	SR_5022_
36"			SR_5003_	SR_5023_
48"			SR_5004_	SR_5024_
18"	87"		SR_5005_	SR_5025_
24"			SR_5006_	SR_5026_
36"			SR_5007_	SR_5027_
48"			SR_5008_	SR_5028_
60"	18"	75"	SR_5051_	SR_5071_
24"			SR_5052_	SR_5072_
36"			SR_5053_	SR_5073_
48"			SR_5054_	SR_5074_
18"	87"		SR_5055_	SR_5075_
24"			SR_5056_	SR_5076_
36"			SR_5057_	SR_5077_
48"			SR_5058_	SR_5078_
24"	99"	-		SR_5080_
36"				SR_5081_
48"				SR_5082_
72"	18"	75"	SR_5101_	SR_5121_
24"			SR_5102_	SR_5122_
36"			SR_5103_	SR_5123_
48"			SR_5104_	SR_5124_
18"	87"		SR_5105_	SR_5125_
24"			SR_5106_	SR_5126_
36"			SR_5107_	SR_5127_
48"			SR_5108_	SR_5128_
24"	99"	-		SR_5130_
36"				SR_5131_
48"				SR_5132_

HEAVY-DUTY BEAMS

Dimensions			No. of Decking Levels	
W	D	H	3	4
72"	18"	75"	SR_5151_	SR_5171_
24"			SR_5152_	SR_5172_
36"			SR_5153_	SR_5173_
48"			SR_5154_	SR_5174_
18"	87"		SR_5155_	SR_5175_
24"			SR_5156_	SR_5176_
36"			SR_5157_	SR_5177_
48"			SR_5158_	SR_5178_
24"	99"	-		SR_5180_
36"				SR_5181_
48"				SR_5182_
96"	18"	75"	SR_5201_	SR_5221_
24"			SR_5202_	SR_5222_
36"			SR_5203_	SR_5223_
48"			SR_5204_	SR_5224_
18"	87"		SR_5205_	SR_5225_
24"			SR_5206_	SR_5226_
36"			SR_5207_	SR_5227_
48"			SR_5208_	SR_5228_
24"	99"	-		SR_5230_
36"				SR_5231_
48"				SR_5232_

* Mini-Racking units in these sizes can be joined to back-to-back shelving units of the same depth.

NOTES: Steel decking has a greater load capacity than wood.

Wire-mesh decking reduces fire risk.

Wood panels are not available from Rousseau.

LARGE PARTS STORAGE

MOBILE MINI-RACKING FOR LARGE PARTS



SRE4545SM

Mobile Mini-Racking is designed for moving parts, tools, and other large and heavy items. There are three options available: steel decking, wire-mesh decking and no decking.

- The preconfigured models in this section include a mobile base for Mini Racking and four 4" casters, including two swivel casters with total-lock brakes and two rigid casters
- Models with a 36"D or 48"D base include a mobile Mini-Racking handle
- Load capacity: 1000lb. per base
- All preconfigured models are quick and easy to assemble and can be disassembled when not in use

MOBILE MINI-RACKING WITH CHOICE OF DECKING

STEEL

To order a unit with steel decking, add **S** to the product number.



SRE4515SM

WIRE MESH

To order a unit with wire mesh decking, add **W** to the product number.

Not compatible with 18"D units.



SRE4515WM

WOOD

To order a unit without decking (e.g., for use with wood decking), leave the product number as is.



SRE4515M

HOW TO ORDER

When ordering, model numbers must be completed as follows:

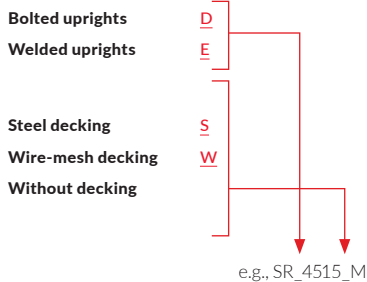

e.g., SRE4515SM
For a 36"D x 75"H unit with welded uprights, steel decking, and a 60"W x 36"D mobile base with 4" casters

NOTES: Steel decking has a greater load capacity than wood.
Wire-mesh decking reduces fire risk.
Wood panels are not available from Rousseau.

MOBILE MINI-RACKING WITH MEDIUM-DUTY AND HEAVY-DUTY BEAMS

Dimensions			Number of levels
Width	Depth	Height	4
MEDIUM-DUTY BEAMS			
48"	18"	63"	SR_4507_M
	24"	75"	SR_4509_M
60"	36"	75"	SR_4515_M
	48"	75"	SR_4517_M
72"	36"	75"	SR_4531_M
	48"	75"	SR_4533_M
HEAVY-DUTY BEAMS			
96"	36"	75"	SR_4539_M
	48"	75"	SR_4541_M

MULTI-LEVEL SHELVING SYSTEM

NOT ENOUGH SPACE?

BEFORE YOU EMBARK ON AN EXPANSION PROJECT, CONSIDER ROUSSEAU MULTI-LEVEL SHELVING

Our specialists will suggest solutions to work around all your building's obstacles: beams, columns, doors, air ducts, building structure, sprinklers, etc.

Our system maximizes your storage potential by combining shelving (with or without drawers), Mini Racking and specialized storage (tire racks, battery racks, etc.).

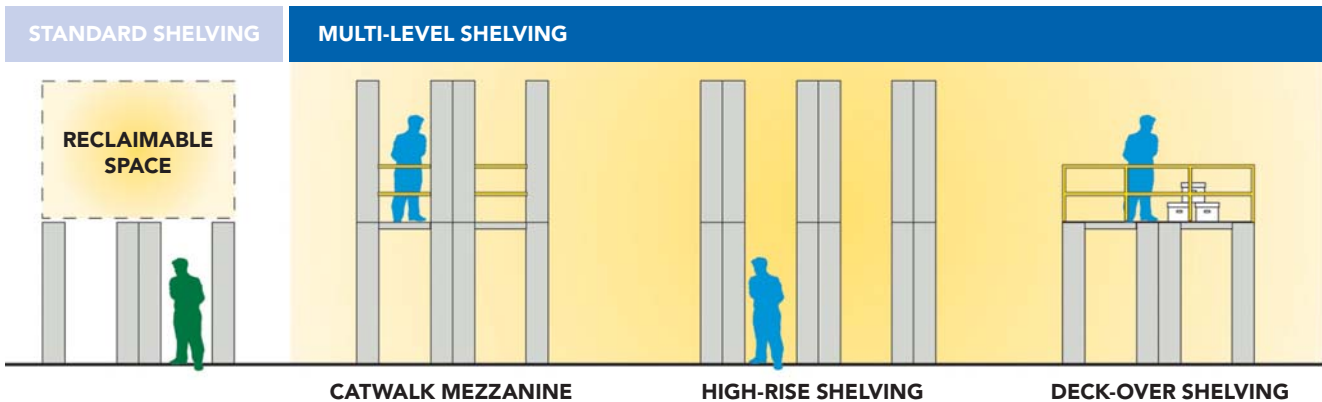

MULTI-LEVEL SHELVING SYSTEM

EXPERTISE THAT LEAVES NOTHING TO CHANCE

Multi-level shelving systems are subject to standards and recommendations in earthquake-prone regions.

The Rousseau team is available to help you work out what shelving and sway bracing you need to complete your multi-level shelving project.

Call us to speak with our experts. They will evaluate your requirements and suggest a system that meets your needs.

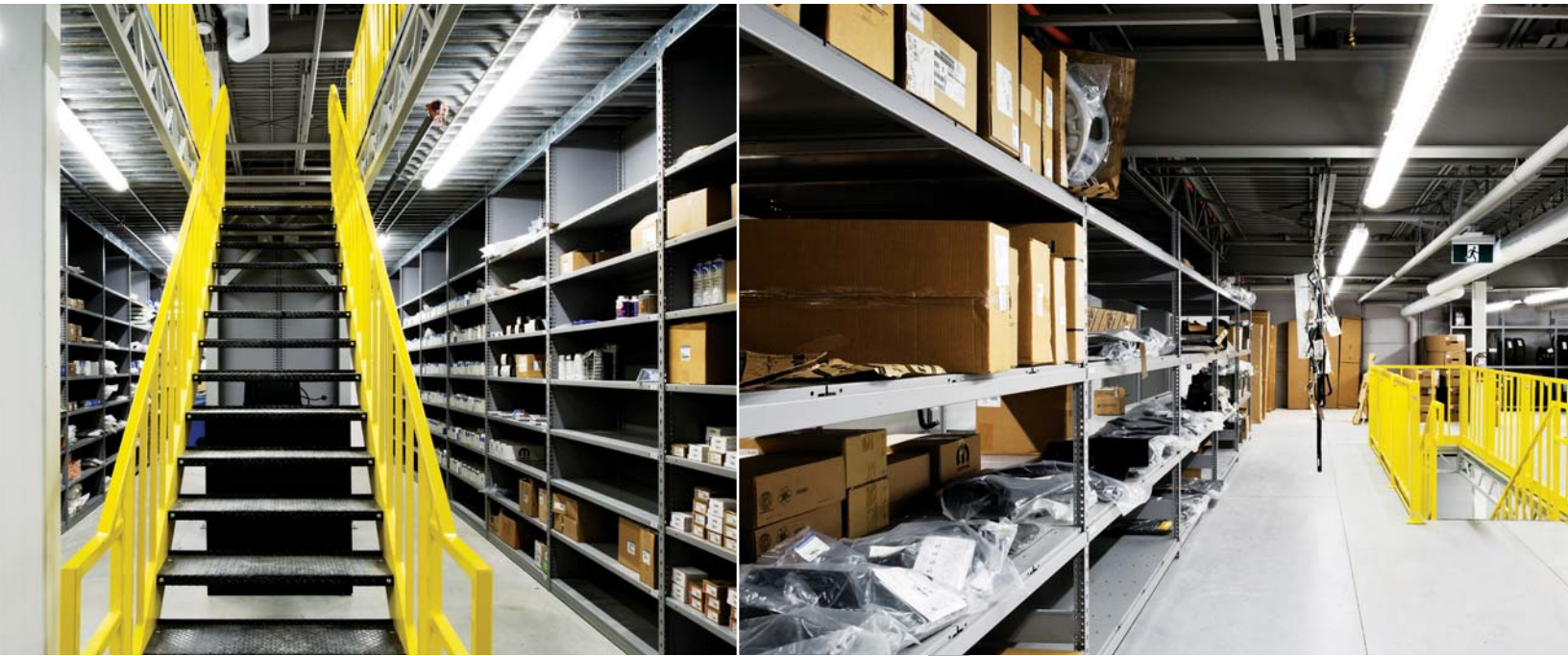

USE THE SECOND LEVEL TO STORE LARGER PARTS AND SPECIALIZED PARTS

106-111



OUR ACCESSORIES ARE PERFECT FOR STORING SMALL AND MEDIUM-SIZED PARTS

102-105

121-122

MULTITEK CART – MATERIAL HANDLING

ERGONOMIC AND VERSATILE



The MultiTek Cart is ideal for transporting large parts. You will find it quickly becomes indispensable in your parts department.

- Each shelf can be lined with a rubber mat
- Each shelf has a load capacity of 150lb. for a maximum of 600lb. per cart

You can find other preconfigured models (dimensions and accessories) on [pages 71 to 77](#).

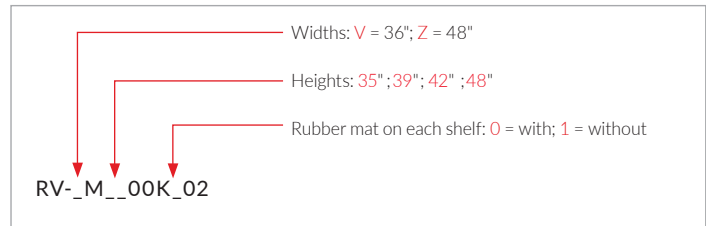

- NOTES 1: For compatible hooks, see [page 119](#).
 2: Only available for 42"H and 48"H carts.
 3: Sold unassembled.

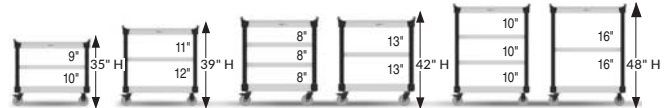
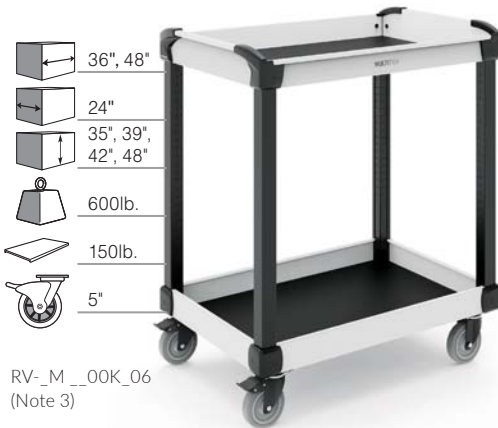

3 shelves

RV- M __00K_08 (Note 3)



4 shelves

RV- M __00K_09 (Note 2 and 3)



Utility panels

RV- M __00U_06 (Note 1)



Utility panels, 3 shelves

RV- M __00U_08 (Note 1)



Utility panels, 4 shelves

RV- M __00U_09 (Note 1 and 2)

WORKSTATIONS

OPTIMIZE YOUR WORKSPACE



To help you optimize your work area, Rousseau offers workstations tailored to your needs. Whether you are looking for a basic workbench or more extensive storage options over and under the work surface, we have many options available. And with a wide range of accessories to choose from, there is a near limitless number of layouts and configurations possible.

Heavy duty and meticulously designed, our workstations meet the strictest standards of quality and functionality. You will love their versatility and the value they add for specific tasks, including computer work, key copying, packaging, shipping, and much more.

BASIC WORKBENCH



- A high-quality bench available in multiple dimensions and with a choice of work tops



TYPE OF TOP

W x D x H	Painted steel	Lam. wood	Plastic lam.	Acrylic/PVC
60" x 30" x 34"	WS_1031	WS_2031	WS_3031	WS_9031
72" x 30" x 34"	WS_1035	WS_2035	WS_3035	WS_9035
72" x 36" x 34"	WS_1039	WS_2039	WS_3039	WS_9039

NOTES: For a stationary table, complete with an **A**.
For a mobile table, complete with a **W**.

WORKBENCH WITH STORAGE



- Ideal for storing tools, office supplies and other frequently used items
- Stationary workbench with 27"D cabinet on a 2"H recessed base

TYPE OF TOP

W x D x H	Stainless steel	Painted steel	Lam. wood	Plastic lam.	Acrylic/PVC
60" x 30" x 34"	R5WH5-2021	R5WH5-2022	R5WH5-2023	R5WH5-2024	R5WH5-2025
72" x 30" x 34"	R5WH5-2031	R5WH5-2032	R5WH5-2033	R5WH5-2034	R5WH5-2035
72" x 36" x 34"	R5WH5-2041	R5WH5-2042	R5WH5-2043	R5WH5-2044	R5WH5-2045

PACKING AND SHIPPING WORKSTATION



- For efficient preparation of orders to be shipped
- The spool support under the bench keeps your workspace clear

W x D x H	PRODUCT NO.
60" x 30" x 80"	WSM0006

RECEIVING WORKSTATION AND INVENTORY CONTROL



- For efficient inspection of merchandise upon arrival
- Includes a steel shelf under the work surface
- The riser shelf includes one standard support and one support with three 12A power outlets and two USB ports

W x D x H	PRODUCT NO.
60" x 30" x 50"	WSA2006

SERVICE COUNTERS

OPTIMIZE YOUR SERVICE



To provide rapid and efficient service to your internal and external customers, make sure you have high-turnover parts to hand, i.e., directly at the service counter!

Adding drawers under the work surface provides high-density storage. This means you can access more parts without having to move. We also recommend combining shelves and drawers to maximize storage efficiency of parts with a high turnover.

Rousseau service counters have been designed to be welcoming for your customers while also providing an efficient and ergonomic workspace. You will love the distinctive look of our new corner service counters. With an attractive finish and the option to personalize stainless steel front panels, you can proudly display your logo and highlight your brand image. See [page 94](#) for more details.

CORNER SERVICE COUNTER, CONFIGURATION 1830: 15 DRAWERS

This counter allows you to keep high-turnover parts within arm's reach. With a 24" W leg space, it's easy to work at the counter or store a chair underneath as needed.

- Left bank (24"W)
- Middle bank (24"W)
- Right bank (2 × 36"W)

	STAINLESS STEEL	PAINTED STEEL
30" × 36"	RS-C096S	RS-C096P



MIDDLE SECTION ONLY, INCLUDING THE CORNER TOP

STAINLESS STEEL	PAINTED STEEL
RS-J18303420S	RS-J18303420P

CORNER SERVICE COUNTER, CONFIGURATION 1830: 17 DRAWERS, 1 SHELF

With multiple drawers of different dimensions and a secure storage space with door, you can store high-demand parts whatever their size and shape.

- Left bank (24"W)
- Middle bank (24"W)
- Right bank (2 × 36"W)

	STAINLESS STEEL	PAINTED STEEL
30" × 36"	RS-C094S	RS-C094P



MIDDLE SECTION ONLY, INCLUDING THE CORNER TOP

STAINLESS STEEL	PAINTED STEEL
RS-J18303418S	RS-J18303418P

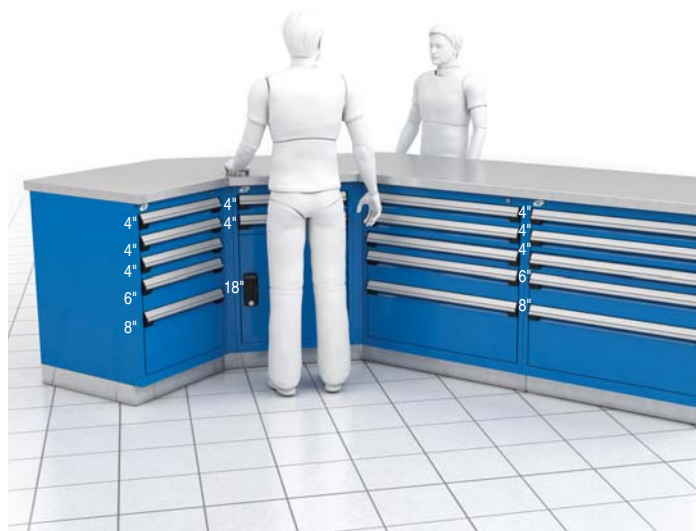

NOTES: The corner workstation must be anchored to two cabinets of the same height and depth, one on each side (RA30 or RA35).

Our corner service counters are available in configurations 0030, 0630, 1230 and 1830. Please contact Customer Service for more details.

SERVICE COUNTERS

R5XSE-100 _

1 = no top; 2 = stainless steel; 3 = painted steel
4 = lam. wood; 5 = plastic lam. 6 = acrylic/PVC

NOTES: Complete the product number with the type of top required.
Comes with painted bases, except models with stainless steel tops
will include stainless bases.



COUNTER CABINETS: 1 DRAWER, 3 SHELVES AND 2 ROLL-OUT SHELVES

With two roll-out shelves, this service counter is ideal for handling and storing heavy parts. The drawer with lock is also very useful for storing valuable items or even inserting a cash drawer.

- 1 left bank, 36"W (R5AEE-3404)
- 1 right bank, 36"W (R5AEE-3402), 2 roll-out shelves

W x D x H	PRODUCT NO.
72" x 24" x 40"	R5XLE-110_



COUNTER CABINETS: 4 DRAWERS, 6 SHELVES

This counter is perfect for storing small items and parts. It also includes several drawers and shelves to provide even more versatile storage options.

- 1 left and 1 right bank, 24"W (R5ADE-3004)
- 1 middle bank, 36"W (R5AEE-3020)

W x D x H	PRODUCT NO.
96" x 24" x 36"	R5XRE-120_



COUNTER CABINETS: 14 DRAWERS, 3 SHELVES

This counter is an ideal addition to your parts department for storing small to medium-sized parts while also serving as a customer service counter.

- 1 left bank, 36"W (R5AEE-3816)
- 1 middle bank, 36"W (R5AEE-3818)
- 1 right bank, 36"W (R5AEE-3820)

W x D x H	PRODUCT NO.
108" x 24" x 44"	R5XSE-100_



COUNTER CABINETS: 19 DRAWERS, 1 DOOR

This service counter has been designed to satisfy all your storage needs for high-volume parts, while providing a counter to serve your customers.

- 1 left bank, 60"W (R5KKE-3816)
- 1 right bank, 48"W (R5KHE-3820)

W x D x H	PRODUCT NO.
72" x 24" x 40"	R5XSE-120_

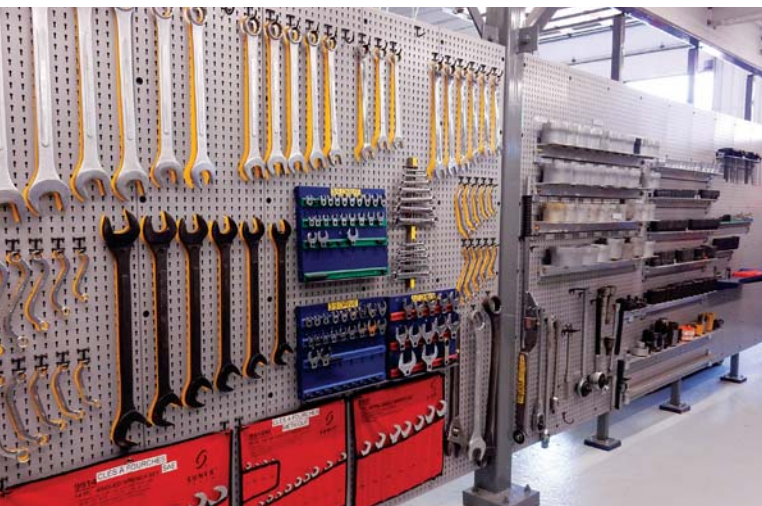

The Japanese 5S method focuses on sorting, straightening or setting in order, sweeping or shining, standardizing and sustaining the practice. This method ensures that the various tools and parts are stored according to their purpose and the frequency with which they are used, in a manner that is clear and well identified. Each item has its place, which reduces wasted time and lost items. With this method, the work environment is standardized so as to ensure the best organization possible while enhancing working conditions and team morale. Moreover, this means that less time and money are wasted. Here are several Rousseau accessories that will enable you to integrate the 5S method for lean manufacturing in the storage solution for the parts department of your automobile dealership.

WALL-MOUNTED UTILITY PANEL



- Can be used to organize a wide variety of items of different sizes and weights in the same system
- Compatible with light-duty and heavy-duty hooks, vinyl rub-on identification decals, plastic bin rails, can holders and tiltable shelves
- 16"W: vertical installation and conforms with architectural standards with uprights spaced 16" apart c/c
- An optional finishing panel (WM58/WM5D) is available to create an aesthetic finish on the right-hand side
- Available in painted steel or stainless steel

PRODUCT NO.	FINISH	WIDTH
WM57-16__	Painted steel	16"
WM57-24__	Painted steel	24"
WM5B-16__	Stainless steel	16"
WM5B-24__	Stainless steel	24"

NOTE: To order, specify the height required: 18", 24", 30", 36", 48", 60", 72".

WALL-MOUNTED PLASTIC BIN PANEL

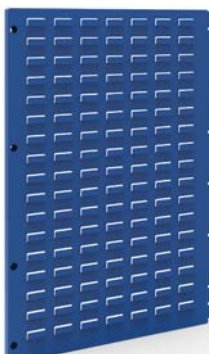

- For easier storing, moving and managing of small parts
- 16"W: vertical installation and conforms with architectural standards with uprights spaced 16" apart c/c
- Compatible with RG20 plastic bins and all brands of plastic bins with hanging lip on the market

PRODUCT NO.	WIDTH
WM5C-16__	16"
WM5C-24__	24"

NOTE: To order, specify the height required: 18", 24", 30", 36", 48", 60", 72".

VINYL RUB-ON IDENTIFICATION DECAL

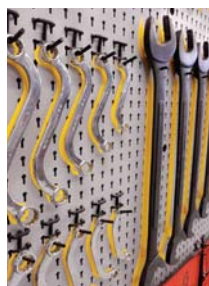

- Vinyl decals help to easily identify the proper place for tools on utility panels
- The contrasting color makes it easy to notice when a tool is missing and what kind of tool it is

PRODUCT NO.	W x L
WM91-01J	2' x 8'

FINISHING PANEL



- Provides a more aesthetic finish to the wall panel system
- Closes off the panel at the right-hand side
- Order the same height as the main utility panel
- Available in painted steel or stainless steel
- 1 1/8"W

PRODUCT NO.	FINISH
WM58-__	Painted steel
WM5D-__	Stainless steel

NOTE: To order, specify the height required: 18", 24", 30", 36", 48", 60", 72".

PLASTIC BINS



- 45° angled rim for easy identification of bin contents and removal of bins
- 6" plastic bins can be subdivided

PRODUCT NO.	W x D x H
RG20-030302	3" x 3" x 2"
RG20-040302	4" x 3" x 2"
RG20-060302	6" x 3" x 2"
RG20-060602	6" x 6" x 2"
RG20-030303	3" x 3" x 3"
RG20-040303	4" x 3" x 3"
RG20-060303	6" x 3" x 3"
RG20-060603	6" x 6" x 3"

HEAVY-DUTY HOOKS

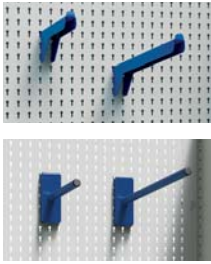

- Our hooks can be used to store many different parts and tools
- Load capacity: 50lb.
- Square and round versions available

PRODUCT NO.	TYPE OF HOOK	LENGTH
WM9A-06	Square	6"
WM9A-12	Square	12"
WM9B-06	Round	6"
WM9B-12	Round	12"

PLASTIC BIN RAIL



- Ideal for integrating and managing small parts in a 5S storage system
- Compatible with RG20 plastic bins

PRODUCT NO.	W x H
WM9C-06	6" x 3"
WM9C-15	15" x 3"

PLIERS HOLDER



- Holds up to six pliers

PRODUCT NO.	W x D x H
WM9M-01	9" x 2 1/2" x 2"

SCREWDRIVER HOLDER



- Two versions available for holding 6 or 12 screwdrivers

PRODUCT NO.	W x D x H	VERSION
WM9N-01	9" x 1 1/2" x 2"	Single
WM9N-02	9" x 3 3/4" x 2"	Double

LIGHT-DUTY HOOKS

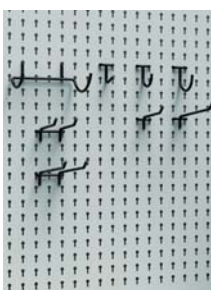

- Our hooks can be used to store many different parts, tools and accessories
- They are compatible with Rousseau utility panels as well as other panels currently available on the market (1/4" dia. holes)
- Also compatible with the wall-mounted panel system
- Color: black

CAN HOLDER



- Ideal for organization and storage of aerosol cans
- Also compatible with drinks cans
- The 6"W version stores 2 cans (standard size) and the 15"W version stores 5 cans

PRODUCT NO.	W x D x H
WM9D-06	6" x 3" x 4"
WM9D-15	15" x 3" x 4"

TILTABLE SHELF



- Includes slots spaced 2" apart c/c for installing SH52 dividers
- Includes two side brackets which can be placed at right angles or at a 15° angle
- The shelf is reversible and its edge can act as a back stop for plastic bins and ring binders
- Load capacity: 50lb. (evenly distributed)

PRODUCT NO.	W x D
WM21-1308	13" x 8"
WM21-1312	13" x 12"
WM21-1508	15" x 8"
WM21-1512	15" x 12"
WM21-3108	31" x 8"
WM21-3112	31" x 12"

LONG TOOL HOLDER



- For storing long tools, e.g., pry bars
- Holds up to three long tools
- Space available for two smaller tools, e.g., screwdrivers

PRODUCT NO.	W x D x H
WM9Q-08	8" x 3" x 4"

PRODUCT NO.	TYPE (QTY)	DIMENSIONS
WM9F-150	Straight Arm Hooks (20)	1 1/2"D
WM9G-150	Single Loop Hooks (20)	1 1/2" dia.
WM9G-200	Single Loop Hooks (20)	2" dia.
WM9H-03	Double Back Single Hooks (10)	3"D
WM9H-05	Double Back Single Hooks (10)	5"D
WM9J-03	Double Back Double Hooks (10)	3"D
WM9J-05	Double Back Double Hooks (10)	5"D
WM9L-01	Drill Holder (1)	5"W x 3 1/2"D
WM9N-01	Screwdriver Holder (1)	9"W x 1 1/2"D x 2"H
WM9N-02	Screwdriver Holder (1)	9"W x 3 3/16"D x 2"H
WM9M-01	Pliers Holder (1)	9"W x 2 1/2"D x 2"H

CABINETS FOR SPECIALIZED TOOLS

UNEQUALED FLEXIBILITY



We understand how valuable specialized tools are and that they must be carefully protected and completely secure. Our drawer accessories have been designed to protect your precious tools, regardless of their shape or size, and to make it easy to locate them.

We provide a turnkey service to help you create a cabinet that meets your exact and personal requirements.



YOUR OWN COMPLETELY ACCESSORIZED AND READY-TO-USE PRODUCT

Create fully personalized storage space with drawer accessories (PVC drawer liners, tool foam, plastic bins, subdivided compartment system)

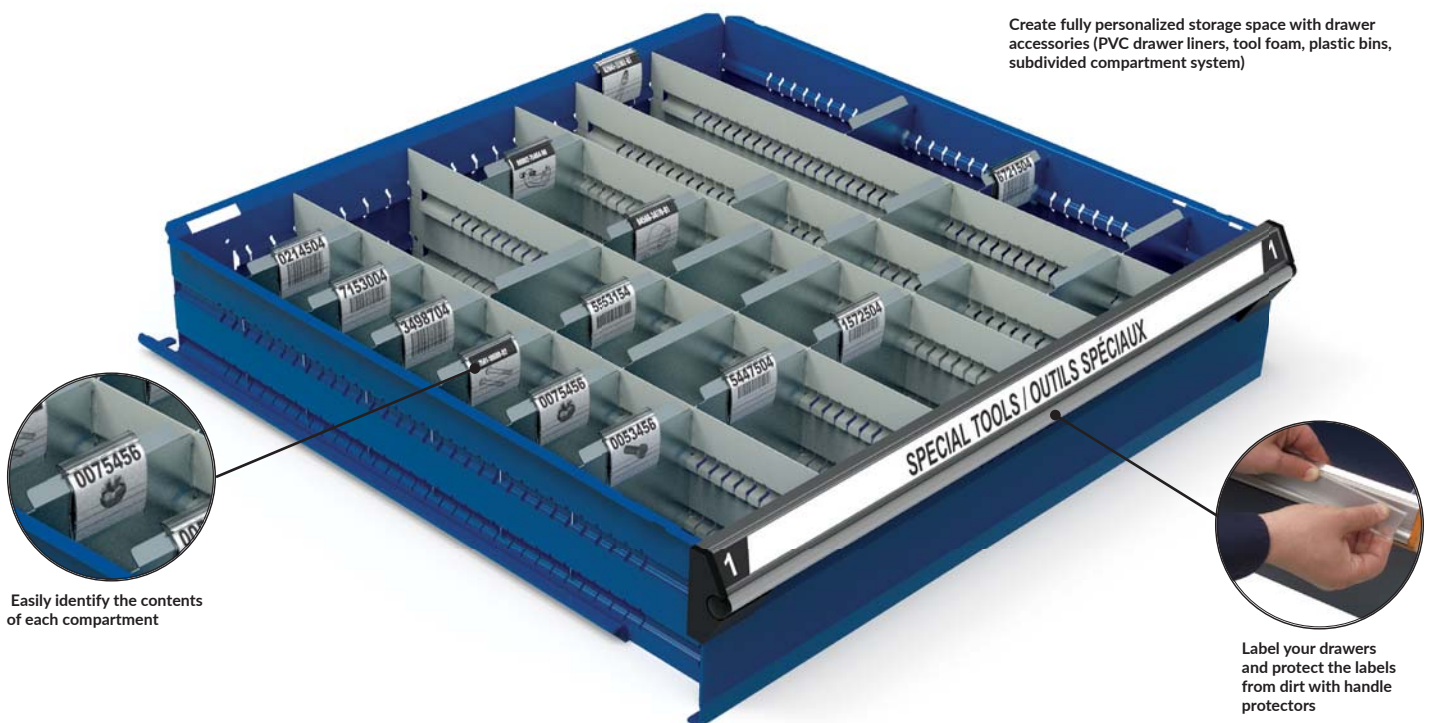

Easily identify the contents of each compartment

Label your drawers and protect the labels from dirt with handle protectors

DRAWER ACCESSORIES



Our wide range of drawer accessories are compatible with each other to help you keep your tools organized and easy to find. No matter what shape or size of item you need to store, we have the accessory you need.

The unique design of the R drawer is a trademark of Rousseau Metal Inc. The drawer is also protected by a registered industrial design. To view various preconfigured models, visit the Modular Drawers & Compartments section on our website.

NON-SLIP PVC DRAWER LINER **NEW DIMENSION**

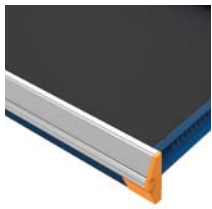

- Non-slip surface protects items stored in drawers
- Thickness: $\frac{3}{32}$ "
- Sold in sizes to fit drawer dimensions or in 27"W x 50"L rolls

NOTES: Not compatible with partitions and dividers.
To order a 27" x 50' roll: RG49-RR27-01.

PVC DRAWER LINER (RG40)

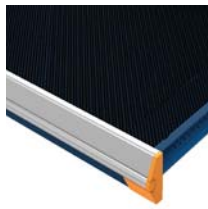

- Thickness: $\frac{3}{32}$ "
- Sold in sizes to fit drawer dimensions or in 7"W x 100"L
- Compatible with partitions and dividers

NOTE: To order a 7' x 100' roll: RG40-RR84-01.

TOOL FOAM



- Helps to easily identify stored items
- Oil resistant and non-absorbent
- The blue foam is $\frac{1}{4}$ " thick and the black self-adhesive foam is $\frac{1}{2}$ " thick

NOTE: Sold without cut-outs.

49 = Non-slip PVC drawer liner; 40 = PVC drawer liner; 42 = Tool Foam
Nominal drawer widths: 18", 24", 30", 36", 42", 48", 54", 60"
Nominal drawer depths: 18", 24", 27"
RG__-____-01

PARTITIONS AND DIVIDERS **PATENTED**



- Front to back and left to right partitions available
- Our tool-free "clip-in" subdividing system keeps the dividers firmly in place and reduces noise caused by vibrations

DRAWER DIVIDER

Nominal divider widths: 03", 04", 05", 06", 07", 08", 09", 10", 11", 12", 13", 14", 16"
Nominal drawer heights: 03", 04", 05", 06" (6" and 7"), 08" (8" and 9"), 10", 12" (12" and 14")
RG10-____

FRONT TO BACK PARTITIONS

Nominal drawer depths: 18", 24", 27"
Drawer heights: 03", 04", 05", 06" (6" and 7"), 08" (8" and 9"), 10", 12" (12" and 14")
RG00-____

LEFT TO RIGHT PARTITIONS

Nominal drawer widths: 18", 24", 30", 36", 42", 48", 54", 60"
Drawer heights: 03", 04", 05", 06" (6" and 7"), 08" (8" and 9"), 10", 12" (12" and 14")
RG01-____



NOTE: Drawer accessories are available in other dimensions. Please contact your customer service representative for more details.

DRAWER ACCESSORIES

PLASTIC BINS



- Ideal for easier storage, handling and management of small parts
- 45° angled rim for easy identification of bin contents and removal of bins
- Designed for 3"H and 4"H drawers

PRODUCT NO.	W × D × H
RG20-040302	4" × 3" × 2"
RG20-040303	4" × 3" × 3"
RG20-060302	6" × 3" × 2"
RG20-060303	6" × 3" × 3"
RG20-060602	6" × 6" × 2"
RG20-060603	6" × 6" × 3"

NOTE: Partitions and dividers are also available (RG22/RG24).

GROOVE TRAY

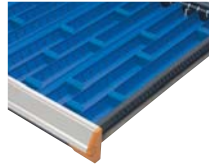

- For storing and protecting long objects
- Blue color for easy identification of stored items
- Specially designed for 3"H and 4"H drawers

PRODUCT NO.			DIVIDER NO.
DEPTH	WIDTH		
RG35-04__10	RG36-__0410		RG39-10
RG35-06__10	RG36-__0610		
RG35-04__15	RG36-__0415		RG39-15
RG35-06__15	RG36-__0615		
RG35-06__25	RG36-__0625		RG39-25

NOTE: Complete the product number with the depth required: 18", 24", 27", or the width required 18", 24", 30", 36", 42", 48", 54", 60".

LOCK-IN MECHANISM



- Stops drawer from opening on its own
- Designed so you can open and close the drawer with one hand only

PRODUCT NO.
A

LABEL HOLDER



- For dividers and plastic bins
- Once installed, the label holders remain in place when removing objects
- Contents of each compartment can be easily identified

PRODUCT NO.	TYPE	W × H
RG51-200	1"H Label Holder	2" × 1"
RG52-200	1"H Label Holder with Adhesive Strip for Plastic Bins	2" × 1"
RG54-200	1 3/4"H Label Holder	2" × 1 3/4"
RG54-400	1 3/4"H Label Holder	4" × 1 3/4"
RG55-200	1 3/4"H Label Holder with Adhesive Strip	2" × 1 3/4"
RG55-400	1 3/4"H Label Holder with Adhesive Strip	4" × 1 3/4"

NOTE: Labels (RG53) are available in packs of 200.

LABELS



- Labels that attach to toolbox handles under the handle protector (RF70)
- 22 labels per page (10 pages)
- Print your own labels

PRODUCT NO.	W × H
RF71-425100	4 1/4" × 1"

DRAWER LOCK

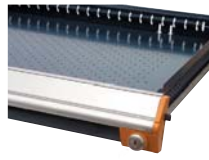

- Locks a single drawer
- Compatible with all drawer dimensions

PRODUCT NO.
L3

HANDLE PROTECTOR



- Protects identification labels from dust, grease and dirt
- Made of transparent, matte plastic that eliminates glare and makes labels easy to read
- Clips onto the handle of the drawer or roll-out shelf

PRODUCT #	WIDTH
RF70-18	18"
RF70-24	24"
RF70-30	30"
RF70-36	36"
RF70-42	42"
RF70-48	48"
RF70-54	54"
RF70-60	60"

"OUR PARTS DEPARTMENT HAD A PROBLEM WITH LACK OF SPACE"

Derek Copeland, BMW Mississauga

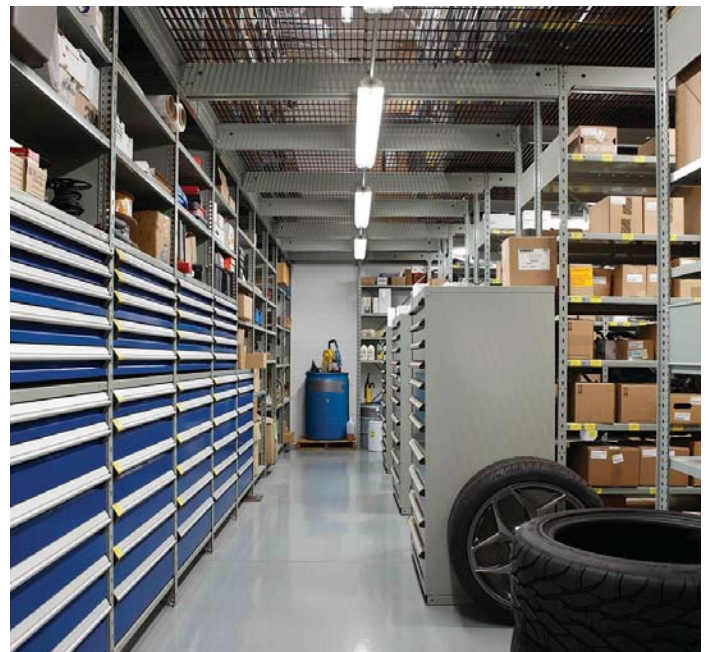

CHALLENGE

Find the ideal solution to maximize the space in the parts department at BMW Mississauga, and by doing so, assemble the entire inventory in one place.

OBJECTIVE

Create a storage solution that would allow the client to solve the problem of having little space in the parts department, using Spider® Shelving Systems and Rousseau drawers.

ROUSSEAU SOLUTION

BMW Mississauga is a prestigious car dealership which serves a huge client base in the Greater Toronto Area, in Canada. This very busy garage was looking for a solution for their lack of space in the existing parts department. When Derek Copeland, Parts Manager at BMW Mississauga, came to the conclusion that the parts department needed to be renovated, he had already made his decision on which option to go with. The owner of this high end dealership owns several other dealerships, among them a Ferrari dealership where he had selected Rousseau Storage Solutions in the past. He was so satisfied with the results that he knew right away he would use Rousseau systems for his BMW parts department to get the customized solution he needed.

"He was always available to talk to us. He asked questions about our needs and he presented us with his proposal. I liked their solution very much." This is what Mr. Copeland had to say about our automotive specialist Mike de Prinse. He loved his experience! After a week of working on the project, our distributor was successful in presenting the client with a customized solution, adapted to their specific needs. Quality, modularity, flexibility and efficiency were all combined to provide a personalized solution. The excellent team work between Mr. Copeland and Mr. de Prinse was the key to the success of this project!

"Our parts department had a problem with lack of space. It is impressive to see how the layout of the shelving, drawers and accessories in the parts department has made storing all of our materials in a limited space possible, while also maximizing the work environment and storage. The productivity in the parts department has significantly increased since installing these solutions!"

FINAL COMMENTS FROM DEREK COPELAND

Here is what Mr. Copeland noticed most about Rousseau Storage Systems: "Durability and quality are what best describe Rousseau. Their modular storage materials allow you to create infinite configurations".



CASE STUDIES

"WHAT GRABBED OUR ATTENTION WAS THE DESIGN AND FLEXIBILITY OF THE PRODUCTS AND HOW HEAVY-DUTY THEY WERE"

Lorenzo D'Alexandro, Queensway Honda

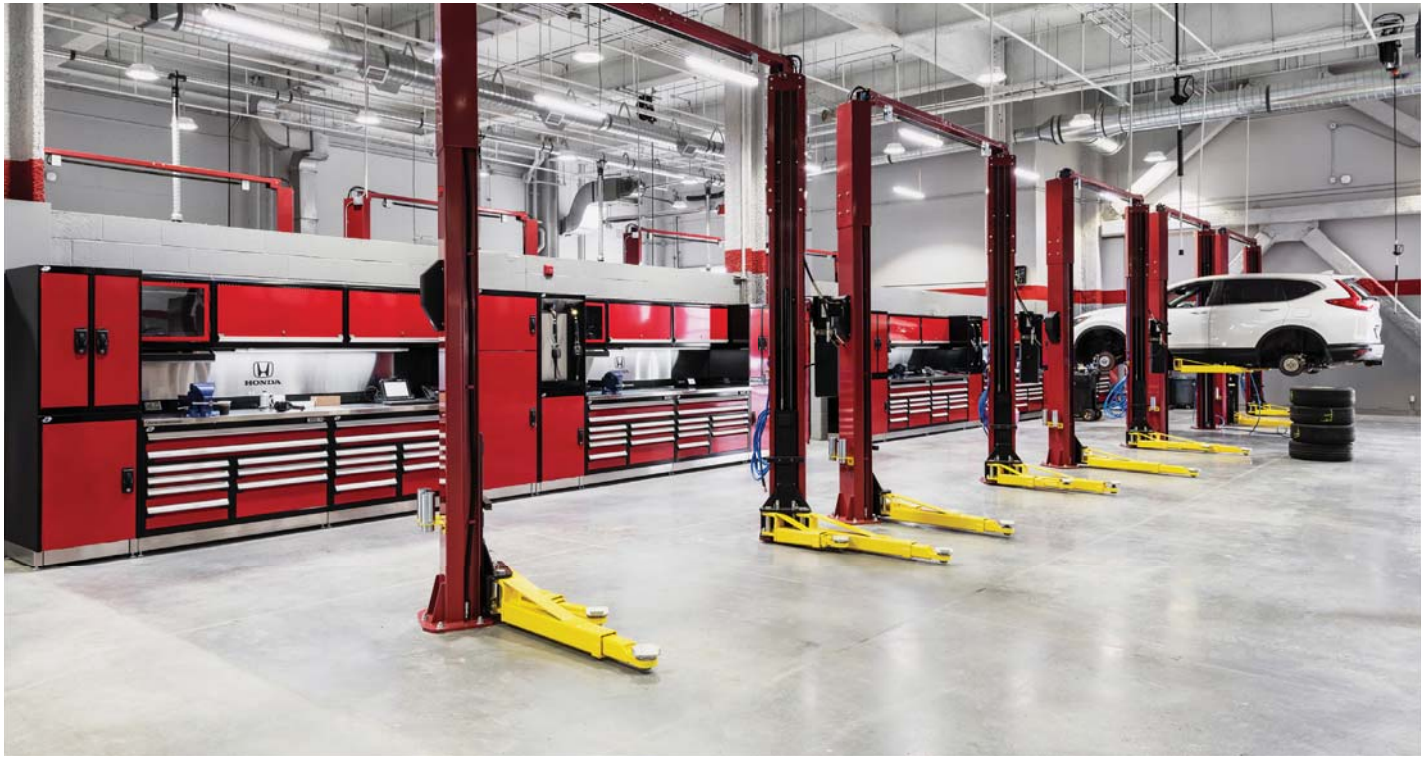

CHALLENGE

The new dealership had to look professional and include technicians workstations, toolboxes, reel cabinets and computer stations

OBJECTIVE

Create a comprehensive solution that combined high-quality products, professional aesthetics and efficient workflow

ROUSSEAU SOLUTION

For over 50 years, Marino's Auto Group's promise to its customers has always been to exceed expectations. This business in the greater Toronto area specializes in five vehicle brands: Honda, Subaru, Volvo, Jaguar and Land Rover. Each customer is given a family-style welcome by passionate employees. Their driving force is to provide the best customer service possible. Although the business was thriving for this respected company, it did not want to sit back and rely on its good reputation. Recognizing that the market was evolving, and customers had new expectations, the owners wanted to relocate three of its dealerships to a new location. As a result, the group moved Lakeshore Honda to a building built for the new Queensway Honda. Located in Etobicoke in Ontario, the new building needed to cater to current needs as well as growth in the medium and long term. This meant choosing a storage system that was flexible enough to scale over time. The group heard about Rousseau at the annual NADA trade show and at the Automotive Conference Expo (ACE). The managers were immediately

impressed by the quality of the products on show: "What grabbed our attention most of all was the design and flexibility of the products and, of course, how heavy-duty they were," said Partner Lorenzo D'Alexandro. "We also liked the fact that the products were made entirely in North America."

The group was in the early stages of their relocation project and meeting with the Rousseau team was a turning point. The Rousseau product specialist at Metric Storage Systems, was soon involved in the project. As Mr. D'Alexandro said, "It has been great to work with Rousseau products expert from Metric Automotive – he listened to our needs and presented us with recommendations based on our requirements as well as innovative storage solutions for our parts department. The initial need was for a high-quality

workbench solution with a professional appearance, but as we had a more in-depth look at our requirements, we had to find a solution for multiple technician shifts, as well as a way to integrate everything from toolboxes and air and oil reels to computer stations."

Everything was considered in this project. From technicians workstations to alignment stations and oil changes, every detail was included in the creation of workspaces that met the specific needs of the tasks to be performed. The Honda dealership now has stylish and distinctive aesthetics and is a pleasant environment for employees to work in. Mr. D'Alexandro maintains that the quality of the installations is also important for hiring and retaining high-performing employees.

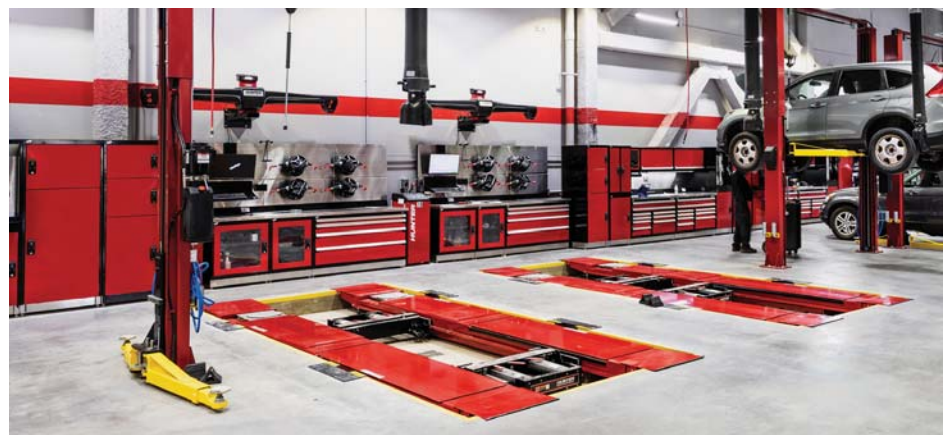

"Their design aesthetic makes an impactful statement by presenting a professional appearance not only to our customers but equally as important - to our employees." The work environment's design and functionality of the custom workstations will most likely help recruit top talent in the coming years.

The end result is down to teamwork from start to finish. This project proves that establishing a partnership between passionate people with a common goal - to offer customers the best experience - leads to an end result that exceeds expectations. Our Rousseau specialist agrees. He believes that a project of this scale is particularly rewarding: "It's great to work on a project of this size. We installed a total of 24 workstations and a complete parts department. We took the time to listen to our client and advise them. When you look at the result, and when the client is happy, you know you've done a good job."

Although they didn't know at the start of the project that the three dealerships would turn to Rousseau for their parts and service departments, they were left in no doubt after the Queensway Honda project was completed: Rousseau had the solution. Mr. D'Alessandro summed it up, "Rousseau products have greatly contributed to increased productivity and given the business a more professional look." A few months after completing the Honda Queensway installation, Marino's Auto Group once again called on Rousseau for Marino's Fine Cars Subaru and Jaguar Land Rover Metro West.

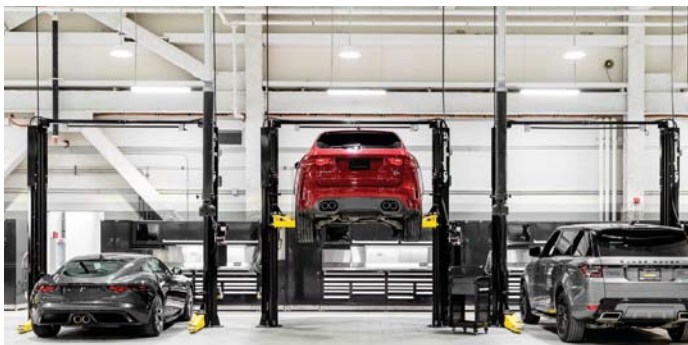

Jaguar Land Rover Metro West



Marino's Fine Cars Subaru

SHOWCASE – SERVICE DEPARTMENTS

TAILOR-MADE FOR EVERY CUSTOMER

FERRARI LAKE FOREST (IL)

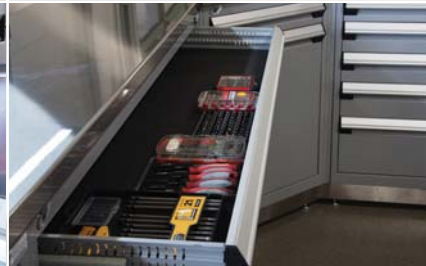

SHOWCASE – SERVICE DEPARTMENTS

NAPLES MOTORSPORTS (FL)



SHOWCASE – SERVICE DEPARTMENTS

BASNEY HONDA (IN)



SHOWCASE – SERVICE DEPARTMENTS

LANCASTER TOYOTA (PA)



SHOWCASE – SERVICE DEPARTMENTS

BUDDS JAGUAR LAND ROVER (ON)



SHOWCASE – SERVICE DEPARTMENTS

COMPLEXE VOLKSWAGEN 440 (QC)



SHOWCASE – OFFICES



SHOWCASE – PARTS DEPARTMENTS

SPECIALIZED STORAGE

For many years we have worked on solutions to help you achieve maximum efficiency in your parts stores. You can count on us no matter your store size or what obstacles you are faced with. We have the solution you need!



SHOWCASE – PARTS DEPARTMENTS

MULTI-LEVEL SHELVING



SHOWCASE – PARTS DEPARTMENTS

SMALL, MEDIUM AND LARGE PARTS STORAGE



SHOWCASE – PARTS DEPARTMENTS

SERVICE COUNTERS AND SERVICE ADVISOR DESKS



STANDARD COLORS

Having the ability to customize your Rousseau product with any of our 20 standard colors is also distinctively Rousseau!

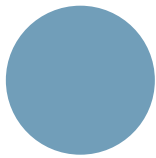

EVEREST BLUE
051

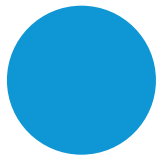

CLASSIC BLUE
052

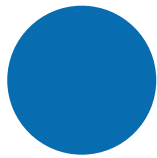

AVALANCHE BLUE
055

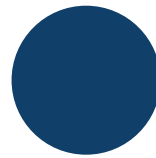

MIDNIGHT BLUE
057

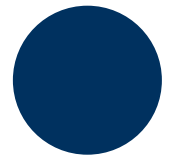

GLOSSY SAPPHIRE BLUE
560



BEIGE
041



FROST WHITE
061

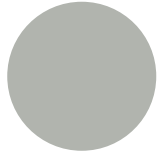

LIGHT GRAY
071

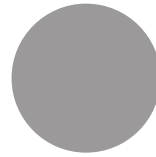

MODERN GRAY
745

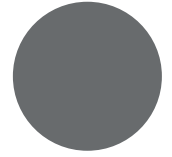

CHARCOAL GRAY
072

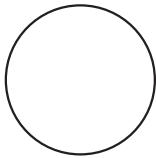

WHITE
616

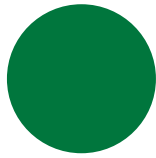

GLOSSY EVERGREEN
1025

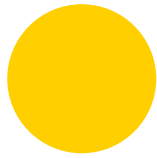

GLOSSY YELLOW
208

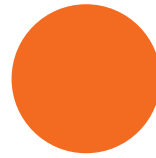

SIENNA ORANGE
085



FLAME RED
081



GLOSSY CARMINE RED
806

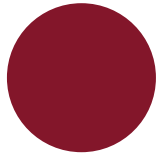

GLOSSY CRANBERRY RED
815

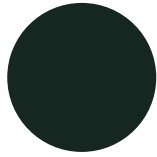

GLOSSY CARBON BLACK
741

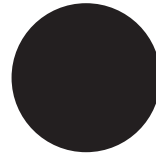

BLACK
091



GLOSSY BLACK
902

FOR PRODUCTS THAT REALLY POP, YOU CAN EVEN COMBINE COLORS. HERE ARE SOME EXAMPLES:

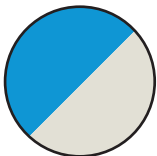

**CLASSIC BLUE /
FROST WHITE**
052/061



**GLOSSY YELLOW /
GLOSSY BLACK**
208/902

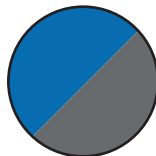

**AVALANCHE BLUE /
CHARCOAL GRAY**
055/072

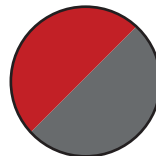

**GLOSSY CARMINE RED /
CHARCOAL GRAY**
806/072

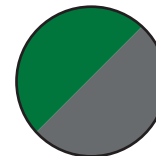

**GLOSSY EVERGREEN /
CHARCOAL GRAY**
1025/072

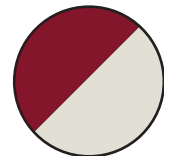

**GLOSSY CRANBERRY RED /
FROST WHITE**
815/061

HANDLE END CAPS:

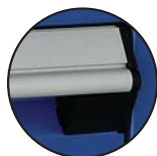

Black
031



Orange
021



Ocean Blue
011

CAN'T FIND THE COLOR YOU WANT?
Contact our Customer Service

**Colors may differ slightly from those shown.*



ROUSSEAU, DISTINCTIVE BY NATURE

For over 70 years, Rousseau has created superior-quality products with a focus on reliability, durability and stylish aesthetics. Our product range now includes a complete line for the automotive market. From technician workstations to service advisor desks to drawers in shelving, every product has been designed to meet the unique requirements of each task. Thanks to many years of industry experience and a reputation that has never stopped growing, Rousseau is now a global leader in storage solutions for parts and service departments.

With two plants covering a total of 254,000 square feet, the latest cutting-edge equipment and constant investment in R&D, we can build you a tailored solution while respecting your time and quality requirements.

At Rousseau we do not believe there is a one-size-fits-all solution for everyone. That's why we have a team of specialists, who are trained to analyze and understand the unique needs of every customer, to help us create a fully personalized and comprehensive answer to your challenges.





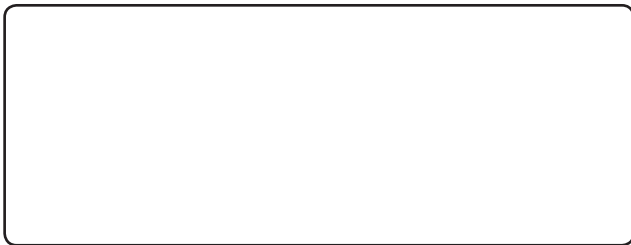















Rousseau products: Once you've tried them, you'll want them!

For more information, please contact your local specialist:



STANDARD COLORS

Colors may vary slightly from those shown.

						
Avalanche Blue 055	Everest Blue 051	Classic Blue 052	Midnight Blue 057	Glossy Sapphire Blue 560	Glossy EverGreen 1025	Black 091
						
Beige 041	Frost White 061	Light Gray 071	Modern Gray 745	Charcoal Gray 072	Glossy Carbon Black 741	White 616
						
Sienna Orange 085	Flame Red 081	Glossy Carmine Red 806	Glossy Cranberry Red 815	Glossy Yellow 208	Glossy Black 902	

Rousseau continuously improves its products and reserves the right to make any modifications judged necessary.

Product numbers presented on the cover: R5-C008X, SRP0442, GT-C2047S, R5GHE-3025, R5SEE-874818, RP-C252002S

ROUSSEAU METAL INC.

105, AVENUE DE GASPÉ OUEST
SAINT-JEAN-PORT-JOLI (QUÉBEC)
G0R 3G0 CANADA

WEBSITE
rousseau-automotive.com

END USERS
1.866.463.4270
EMAIL
info@rousseau.com

DISTRIBUTORS
1.800.463.4271
DISTRIBUTORS ACCESS
e-rousseau.com

