



RIBuild_D2.1_v1.0
Dissemination Level: PU

H2020-EE-03-2014



This project has received funding from the European Union's Horizon 2020 research and innovation programme under grant agreement No 637268

Robust Internal Thermal Insulation of Historic Buildings

Project no.: 637268

Project full title: Robust Internal Thermal Insulation of Historic Buildings

Project Acronym: RIBuild

Deliverable no.: D2.1

Title of the deliverable: Report on the material properties

Contractual Date of Delivery to the CEC:	31-12-2017
Actual Date of Delivery to the CEC:	29-01-2018
Organisation name of lead contractor for this deliverable:	AAU
Author(s):	Eva B. Møller
Participants(s):	Alan Esad, Andra Blumberga, Annika Ekstrand-Tobin, Ernst Jan de Place Hansen, Fredrik Ståhl, Gholam Reza Finken, Hans Janssen, John Grunewald, Peggy Freudenberg, Sébastien Lasvaux, Simon B. Jørgensen, Torben Tvedebrink
Internal reviewers:	Peggy Freudenberg, Ernst Jan de Place Hansen
Work package contributing to the deliverable:	WP2
Nature:	R
Version:	1.0
Total number of pages:	143
Start date of project:	01-01-2015
Duration of project:	31-12-2019

Abstract

In RIBuild hygrothermal simulations are used to determine whether internal insulation of a specific historic building is robust. The major aim of this report was to determine the most decisive hygrothermal material properties to help a user to focus on which material properties to test in a specific case. Different cluster analyses have been performed to identify those properties. Unfortunately, the analyses showed that the decisiveness of properties depend on where in the construction the analysis is performed and thereby which failure mode is considered. In addition, weather, precipitation catch ratio and long wave radiation change the clustering of materials showing that clustering depends not only on material properties and material functions. Consequently, it is not possible to single out properties that are always the most decisive.

The report also describes common hygrothermal simulation tools (DELPHIN, WUFI and MATCH) including their material characterisations. Simpler but in some countries commonly used calculation tools and methods (Glaser method, COND and Eco-sai) are also described.

Furthermore, the report includes a compilation of material properties of historic building materials in solid masonry walls and for internal insulation materials.

Finally, methods to determine material properties are presented: standard methods, deviations hereof and alternatives.

Keyword list: Material properties, material functions, hygrothermal simulations, cluster analysis, material property test methods.

Table of Contents

EXECUTIVE SUMMARY	4
1 INTRODUCTION	6
1.1 FROM MATERIAL PROPERTIES TO SIMULATIONS.....	6
1.2 HYGROTHERMALLY SIMILAR MATERIALS	8
1.3 READING GUIDE	9
2 HOW TO PREDICT HYGROTHERMAL BEHAVIOUR.....	10
2.1 REPLACING EXPERIMENTS WITH CALCULATIONS.....	11
2.2 SIMULATION TOOLS FOR COMBINED HEAT AND MASS TRANSFER	13
2.3 OTHER CALCULATION TOOLS AND METHODS.....	33
3 MATERIAL PROPERTIES OF BUILDING MATERIALS USED IN HISTORIC BUILDINGS	42
3.1 EXISTING INFORMATION ON MATERIAL PROPERTIES.....	42
3.2 MATERIAL PROPERTIES OF INTERNAL INSULATION MATERIALS	45
3.3 CLUSTERING	47
4 IMPACT OF MATERIAL PROPERTIES ON HYGROTHERMAL BEHAVIOUR.....	50
4.1 INTRODUCTION	50
4.2 SETUP.....	50
4.3 FINDINGS	53
4.4 DISCUSSION OF CLUSTERING	68
4.5 DISCUSSION OF IMPACT CHARACTERISATION.....	70
4.6 CONCLUSION.....	71
5 TESTING PROCEDURES FOR DETERMINATION OF MATERIAL PARAMETERS	73
5.1 STANDARD MEASUREMENT METHODS.....	73
5.2 DEVIATIONS FROM STANDARD MEASUREMENT METHODS	95
5.3 OTHER METHODS FOR DETERMINATION OF MATERIAL PARAMETERS	114
6 CONCLUSIONS AND PERSPECTIVES	129
REFERENCES	131
APPENDIX	138

Executive Summary

The aim of RIBuild is to ensure robust solutions with internal thermal insulation in historic buildings. The means are hygrothermal simulations with stochastic outcome that will help the user to understand the uncertainties in the outcome of these simulations.

Before simulations can be made a simulation tool must be chosen. This report describe several user friendly tools that are currently being used by more or less specialised practitioners. Three of them are simulation tools using transient climates; DELPHIN, WUFI and MATCH. They all need material properties for material characterisation, either as single values or as more complex material functions. Material properties and main characterisation methods of the tools are described.

If a user wants to perform a simulation it is difficult to determine which materials should be chosen from the database included in the simulation tool; what properties are the most decisive and therefore the ones that should match specific materials in the historic building or even the ones that should be tested. A major aim of this report has therefore been to determine the most decisive material properties in hygrothermal simulations. The main idea has been to make clusters of materials i.e. determine which materials are hygrothermally alike. This has been investigated in different ways:

- Traditional cluster analysis was used on twelve single material properties of 49 bricks. The properties were not weighed but treated equally. This was called input clustering.
- To check if bricks in a specific input cluster would have similar output values simulations were made for the same bricks in two model constructions; one solid brick wall and one solid, internally insulated brick wall. Moisture content in the material was used as output data.
- Through falsification it was shown that input clusters do not match output clusters. In addition the analysis on output clusters showed how other factors than material properties seem to be more decisive, at least as long as the properties are within a certain range e.g. if it is a brick. More decisive parameters are:
 - Where in the construction the investigation is made e.g. close to the exterior or close to the internal side of the masonry and thereby the failure mode of interest, as it is unlikely that e.g. frost and mould growth will be of interest in the same depth of the construction.
 - Weather, precipitation catch ratio and long wave radiation.

The result that material properties are not that decisive does not correspond to findings in other projects which might be explained by the fact that:

- The cluster analysis has been focused on extreme situations e.g. situations in which failure modes may occur.

- The evaluation has been made on simple material properties; the more complex material functions have not been evaluated

Further work should be done in clustering analyses, as it may reveal tendencies or even the possibility to determine the most decisive material properties if some of the functions can be described in better ways than single points on curves. Alternatively, the decisiveness may be coupled to failure modes i.e. if mould growth is the main issue; one set of parameters are important, if frost is the main issue; another set is important etc.

Despite of the finding that the decisiveness of material properties is not unique, methods to determine the material properties are compiled. Point of reference has been methods stated in standards. In addition, alternative methods have been described either because they are more precise or easier to perform, as they may be less time consuming or cheaper. A few methods determine properties that are not included in the standardised methods.

Hopefully, the description of tests will make it more clear what it takes to make these tests and thereby make it easier for practitioners and laboratories to discuss which properties and methods should be used. It would also help ensuring correct pricing of tests, as it becomes more transparent what the tests involve than just referring to a standard that may not even be particular precise.

Finally, the report also contains compilations of material properties as they can be found in databases, textbooks, older reports etc. The focus has been twofold:

- On materials used in solid walls of historic buildings e.g. bricks, natural stones, mortars and plasters
- On materials used for internal insulation based on EPS, XPS, PIR, PUR, mineral wool, mineral based materials (aerated concrete, calcium silicate), wood fibre and other organic materials. The sources for this information have mainly been producers

The compilations can be used further in the RIBuild project as material properties are still relevant for the simulations that are needed for Work Package 6 *Application and evaluation of assessment tools*. Especially since stochastic methods will be used here. Furthermore, missing values in the compilation of historic building materials may be calculated although with some uncertainties if it becomes possible to create clusters.

1 Introduction

1.1 From material properties to simulations

The aim of RIBuild is to ensure robust solutions with internal thermal insulation in historic buildings. One way to do this is to give general recommendations on what experience has shown normally works in historic buildings. To be on the safe side, this would probably be recommendations that would result in few solutions and only small energy savings. In engineering practice today simple calculation methods are often used; they require a minimum of material properties and boundary conditions, in some cases this might be sufficient. In RIBuild another approach is chosen; a specific outer wall is used as a reference point of hygrothermal simulations, the simulations include different kinds of internal insulation and in different thicknesses. The results of the simulations are compared to the threshold values for different failure modes to determine whether the solution is sufficient robust or not.

However, to get this far several steps must be taken:

1. The geometry of the wall must be determined including the thermal insulation
2. A simulation tool must be chosen.
3. All material properties needed for the simulation tool must be determined for all materials including internal insulation material.
4. Boundary condition needed for the simulation tool must be defined. Depending on the simulation tool, this will often include location and orientation.
5. Results of the simulation are compared with threshold values of different failure modes

Focus of this report is on step 2 and 3 the other steps will be handled in reports describing the outcome of RIBuild Work Package 6 (Application and evaluation of assessment tools) and Work Package 2: Task 2.3 Limit and threshold for failure.

Step 3 will also be part of RIBuild Work Package 4 (Probabilistic assessment of internal insulation solutions) where the uncertainties in the material properties will be handled. Specific property changes arising from hydrophobisation of the exterior are handled in Work Package 2: Task 2.4 Impact of water repellent agents on hygric material properties.

1.1.1 Simulation tools

There are several hygrothermal simulation tools available, based on different material characterization models. In section 2 *How to predict* hygrothermal behaviour different tools for making hygrothermal assessments are presented. The distinction between simulation tools and other calculation tools and methods is based on whether the tool uses transient climates (e.g. hourly values) or static conditions (e.g. monthly average values). Contrary to simulation tools, calculation tools only include heat and vapour transport and - if any - only simple liquid transport functions and moisture storage. The chosen tools are user friendly and chosen because they are used by more or less specialised practitioners and not only by researchers. The basic transport mechanisms and equations to determine these are described for each tool. The needed input data are also described; these are mainly material properties and boundary conditions.

1.1.2 Material properties

Each simulation tool need input data for material properties to be able to make accurate estimations of the hygrothermal behaviour of the construction. Most of the material properties can be measured directly and some are calculated from experiments. Section 5 *Testing procedures for determination of material parameters* is a compilation of test methods; both standardized test methods, including smaller deviations hereof, and test methods that are not described in any standard, but can be helpful in estimating the needed material properties. The required accuracy of material properties has not been estimated in this work package. Estimations hereof could be made based on measurements made on case studies in Work Package 3 *Case studies and laboratory measurement*, where it will be possible to evaluate the effect of minor changes in material properties on the accuracy of simulations compared with measurements.

The described simulation tools all have an extensive database of material properties, but materials vary and a user might miss the material that is relevant in a specific case. For example are two of the simulation tools of German origin and many of the materials in the database, especially historic materials, are materials from Germany. However, German bricks vary and they may vary even more from bricks from other countries. Therefore, material properties from materials from different countries have been gathered. Focus has been on historic building materials; brick, natural stone and mortar and plaster. These were chosen because they are the most common materials in outer walls of historic buildings (Blumberga et al. 2015). Furthermore, material properties of thermal insulation materials used for internal insulation has been gathered from manufacturers.

The compilation of material properties are available in Excel sheets, and examples are presented in section 3.1.3 *Hygrothermal properties of brick, natural stone, plaster and mortar* and section 3.2 *Material properties of internal insulation materials*.

Material properties have not been tested as a part of this work package, as it was not possible to determine which materials are representative in different geographic areas, not even within small areas. Identifying gaps in the compilation of material properties of historic materials with the aim to fill them through measurements was therefore not possible.

1.1.3 How to overcome missing material data

Unfortunately, the gathering of material properties has shown that complete sets of material data are rare; for most materials it was only the case if the material was in a database used by hygrothermal simulation tools. The user of the simulation tools described in this report can create new materials by using material properties they have determined themselves. E.g. by using the methods described in section 5 *Testing procedures for determination of material parameters*.

However, in most cases, the user will not determine a full set of material data, often only few properties are known. The user will might create a new material by choosing a similar material from the database of the simulation tool, change some material properties and leave others unchanged, as the user may not have a better guess for these than the ones from the original material. On the other hand, this means that the new material may not be realistic, as the new combination of material properties may never exist in any real material.

Another way to overcome missing data may be to cluster materials that are similar and instead of using deterministic material properties, accept a certain amount of uncertainty and use average values and standard deviations for each material property and make calculations with these; obtaining results with averages and standard deviations for a cluster of materials. Alternatively, simulations can be made for many materials in the same cluster with deterministic material properties. The results would be average values with standard deviations; a probabilistic approach.

Independently of which approach will be chosen, it is important to be able to cluster materials in an appropriate way.

1.2 Hygrothermally similar materials

1.2.1 Input or output clustering

The main idea behind clustering is to group elements that are alike. In this case, materials that hygrothermally will perform similarly. As the hygrothermal behaviour is determined by material properties, it is only logical to make clustering based on materials with similar material properties. In section 3.3 *Clustering* it is described how clustering can be based on material properties alone, and examples are given based on German bricks where complete sets of material properties are available.

However, some material properties may be more decisive than others and some may be correlated. Cluster analysis based on material properties without weighing decisive properties higher than less decisive properties, may lead to clusters that not necessarily will perform hygrothermally alike. E.g. temperature, relative humidity, moisture content etc. may not be alike. A way to test this is to compare the output of hygrothermal simulations of different clusters and compare if the same clusters can be recognised in the output; i.e. if input clusters are the same as output clusters. This is described in section 4 *Impact of material properties on hygrothermal behaviour*.

1.2.2 Decisive material properties

The most decisive hygrothermal material properties are determined by clustering materials based on output data from hygrothermal simulations where only the materials are changed. Within each cluster the material properties are compared and the variation within the cluster is compared with the variation of the whole sample. Material properties with small variation within the clusters are the most decisive. This is described in section 4 *Impact of material properties on hygrothermal behaviour*.

Based on the knowledge of the most decisive material properties, it is possible to weigh properties and thereby create new input clustering now based on weighed material properties. Because in the end, the user will only have material properties as a guidance of which cluster a specific material should be placed in.

When the most decisive material properties are known, it is also possible to identify the most important tests to perform to place a material in the right cluster. As a complete set of material properties are expensive and often time consuming to achieve, it is very important for the user to be

able to limit the number of tests. In section 5 *Testing procedures for determination of material parameters* the user can find description of how the tests can be performed.

Clusters based on the results of hygrothermal simulations may not be the final goal, as the outcome may have to be processed further to determine whether the solution is robust or not. This will depend on the failure mode. Whether two materials perform hygrothermally alike or not may not be interesting in cases where there is no risk of failure. E.g. clustering based on how materials perform hygrothermally when in the specific case the conditions are dry and warm is not interesting. Based on the outcome of RIBuild task 2.3 *Limit and threshold for failure*, which will be described in RIBuild deliverable D2.2, clustering and decisive material properties may have to be revised.

1.3 Reading guide

The report is divided in four main sections, the idea behind each section and how they are connected is explained in this introduction chapter. As the four chapters are independent, there is no overall discussion but only a brief conclusion to summarise how the outcome of the chapters can be used in RIBuild and further on.

Instead of having one list with all references, the references used in each section is placed at the end of the section or subsection, allowing the reader to focus on section of special interest without reading the whole report. Especially in section 5 *Testing procedures for determination of material parameters* where different test methods are described; in this way most test descriptions can stand alone.

2 How to predict hygrothermal behaviour

This section gathers information on existing models and simulation tools for combined heat and mass transfer including the way they characterize materials. It serves as an overview for RIBuild researchers and other readers.

A main concern for many users will be; how the predictions of calculations correspond with measured data or other programs. Therefore, a section describes how modelling of combined heat and moisture transfer in building components can be used in the design and planning phase of renovations involving internal insulation.

Specific tools and methods for modelling hygrothermal conditions in building components have been singled out and described in detail. The following tools and methods were identified as being used by a broader audience than the researcher or research institute that has developed the method, based on information gathered by RIBuild partners:

Simulation tools described in Section 2.2:

- DELPHIN, only used by highly specialised practitioners and researchers
- WUFI, used by specialised practitioners and researchers
- MATCH, used by specialised practitioners in Denmark

The description of DELPHIN is more elaborated than of the others as DELPHIN is used as simulation tool in the RIBuild project in general, e.g. in WP4 and WP6.

Calculation tools and methods described in Section 2.3:

- Glaser method, widely used
- COND, widely used but only in Germany
- Eco-Sai, used by specialised practitioners but only in Switzerland

The simplest of these six models and tools is the Glaser model; it is a 1-D model with stationary climate on both sides of the building component only considering thermal conductivity for heat transport and diffusion for moisture transport. Material properties are simplified to be independent of hygrothermal conditions and therefore constant. The method is not considered to be a simulation mainly because the climate is constant. More advanced methods like DELPHIN, WUFI and MATCH operate with transient conditions and hygrothermal dependent material properties and are therefore considered to be simulation tools.

2.1 Replacing experiments with calculations

2.1.1 Predicting hygrothermal behaviour by simulations

The main purpose of modelling combined heat and mass transfer in building components is to evaluate how the building component will perform in reality without doing physical experiments. The aim of each model is therefore to mimic what happens in reality. A perfect model would predict the hygrothermal condition in a building component if all boundary conditions and material parameters were known.

Unfortunately, there will always be unknown factors as reality is too complex to be described in a model; models are simplifications of reality, e.g. 3-D modelling has only recently become possible, and materials are not perfect. Therefore, in reality material properties will vary within the material. Uncertainties in measurements will make boundary conditions uncertain; time steps in measurements are often different from time steps in calculations, etc. Perfect agreement between calculated and measured values are unrealistic. Hens (2015) has described the shortcomings thoroughly.

However, it is possible to compare results from simulations with experimental obtained results and thereby quantify the accuracy of the computational model; the model is verified if the accuracy requirements are satisfied (Oberkampf & Roy, 2013). Mundt Petersen and Harderup (2014) have described a method for blind evaluation of hygrothermal calculation tools where independent practitioners perform hygrothermal simulations on given constructions with real indoor and outdoor climate data. They simply use the simulation tool as they would in a commercial task. The result are compared with measurements from existing houses with the same indoor and outdoor climate data. They call the method single blinded as the climate data are measured. According to Mundt Petersen (2015) neither DELPHIN nor WUFI (see section 2.2.1 DELPHIN and 2.2.2 WUFI) have been validated in this way before he validated WUFI. His single blinded validation was limited to two constructions: wood frame walls and cold roofs both with an internal vapour barrier and in locations with Northern European climate.

If a tool has been validated, the next step can be calibration i.e. physical modelling parameters are adjusted in the computational model to improve agreement with experimental data (Oberkampf & Roy, 2013). Many cases presented in literature are calibrated results presented as validation of different models. The difference is that calibration is performed after simulations have been performed and compared to measurements. Often the simulations have been made on case studies preferably with thorough knowledge of boundary conditions and material parameters. As the measured hygrothermal conditions are considered to be truthfully, the model can be changed and thereby calibrated towards the measured data. The changes are made on the parameters that are not known e.g. air change rates, precipitation catch ratio etc. In addition there is often lack of validation of models where the cases include more complex geometries, transport processes etc.

In practice calculations of hygrothermal conditions will never be an exact prediction of future behaviour. However, it will show tendencies that can help planners to choose between different building components e.g. between different types or thicknesses of internal insulation.

How well a model corresponds with reality depends on the complexity of the model, the transport mechanisms considered and how they are modelled. In addition, modelling of material properties is important, as most material properties vary with temperature and moisture content but are only measured at a few specific sets of hygrothermal conditions.

2.1.2 Development of tools and methods

The first modelling of combined heat and mass transfer in building components most probably dates back to the introduction of the Glaser method at the end of the 1950's (Glaser, 1958). Later with the use of computers in the 1970's a number of computational programs were made taking into account variation in moisture parameters as (Sandberg, 1970) and (Nielsen, 1974). The actual development of numerical simulation tools for heat and mass transfer really took off in the 1990's, with the PhD dissertations of Rode Pedersen (1990), Künzel (1994) and Grunewald (1997) presenting the initial versions of respectively MATCH, WUFI and DELPHIN. These tools initiated fruitful discussions and common research projects. One milestone of these activities was the HAMSTAD project. Since the 1990's, numerous other heat, air and moisture (HAM) simulation models have come (and gone). Surveys by Hens (1996) and Hill & McGowan (2003) respectively identified 37 and 45 HAM simulation models, and since then several additional models have been introduced, see (Delgado et al., 2013) and (Janssen, 2014) for examples. It should be kept in mind however that many of these models are not publicly available, since they primarily serve(d) research purposes in academic environments. Nevertheless, providing a full overview here would be near to impossible, and therefore only a concise synopsis is presented in this subsection.

A fine overview of the development of HAM simulation is given by Hens (2015), which also depicts the different stages in HAM simulation tools. Their origin primarily lies in vapour diffusion implementations, while in subsequent stages capillary suction by materials, air as moisture carrier, wind-driven rain loads and the whole-building perspective are added. Not all the these tools have experienced that entire evolution, implying that currently a myriad of tools with varying capabilities and applicability exists. The survey compiled by Delgado et al. (2013) shows that most of the currently publicly available HAM simulation tools have features that are within the spectrum made up by MATCH, WUFI, and DELPHIN, wherein the more recent arrivals typically are fairly complete tools similar to WUFI and DELPHIN (Janssen, 2014). For that reason no further documentation is included here and the reader is referred to the literature for more detailed information.

2.1.3 Simulation tools today

Simulation of coupled heat air and moisture transfer (HAM) is a widely accepted method to evaluate the performance of envelope construction and assembly variants. This includes a detailed analysis of moisture related risk factors, e.g. mould growth or interstitial condensation. The necessity for HAM approaches and software tools is primarily given for engineering practice where simplified methods proved to be too restrictive and incorrect for all cases with relevant liquid water transport and storage processes in the construction and for cases with a need for detailed performance analysis. For this reason standardization in this field has been pushed forward during the past years, e.g. WTA 6-1, EN 15026 (2007).

One of the findings of the HAMSTAD project was that HAM-results depend strongly on the detailing and quality of material characterization. This is on one hand bound to the material model in the particular approach and on the other hand strongly depending on the quality standards and methodologies realized in the laboratories. According to (Grunewald, Häupl, & Bomberg, 2003) HAM models can be subdivided into the group of simplified and the group of research approaches relating to the underlying material characterization.

Simplified approaches are based on a fixed set of material functions and include obvious, empirical transport potentials. These approaches result in so-called secondary (combined) material characterization models, which includes both, the material properties (including storage-relevant aspects) and partially transport characteristics. The disadvantages of the usage of such driving potentials are its limitations and a risk of non-physical effects. An example for such an empirical transport potential is the gradient of the moisture content for the resulting liquid water flux, which depends on the moisture diffusivity of a specific material. Moisture diffusivity depends on the porous material characteristics and its moisture content as well as on the previous course of the material moisture content. An experimental identification of the moisture diffusivity is, under certain circumstances (isothermal conditions, neglecting of hysteresis, isotropic material properties), possible and more appropriate, compared to the liquid water conductivity approach.

Research approaches are based on a variable set of material functions and include thermodynamic-based transport potentials. They rely on so-called primary material characterization models, which are supposed to include pure material properties. The disadvantages of these research models are an extended effort for the identification of primary material characteristics and a remaining vagueness in the experimental distinction of combined processes and material characteristics. An example for such a research model is the gradient of capillary pressure as thermodynamic force for the resulting liquid water flux, which depends on the liquid water conductivity of a specific material.

2.2 Simulation tools for combined heat and mass transfer

Three simulation tools (DELPHIN, WUFI, MATCH) were identified as being used more widely than just by those who developed the tool. They are described in this section.

2.2.1 DELPHIN

2.2.1.1 The origin of the program

The hygrothermal transport model DELPHIN was developed at Dresden Technical University by John Grunewald (Grunewald, 1997). It was extended by air flow (Grunewald & Nicolai, 2006), (Langmans et al., 2011), pollutant transport (Xu et al., 2009), and salt transport (Nicolai, 2007). Scheffler (2008) has used it as platform for material and transport model development (moisture transport) while Ochs (2010) used it for non-linear thermal storage and transport.

2.2.1.2 Transport forms included and numerical method

Simulation program for calculation of coupled heat, moisture, air, pollutant, and salt transport. The program is commercially available in 1- and 2-D. A new 3-D version is being tested.

Balance equations are used to carry out numerical analysis of the following transport processes:

- Heat transport in building components and construction details, incl. wall constructions, thermal bridges
- Moisture transport of both liquid and vapour transport, and moisture storage in constructions
- Air transport.

Thermodynamic principles are the theoretical foundation of DELPHIN. Mass and heat transfer is described by the following equations:

Liquid transport rate:
$$j_{k,conv}^{m_l} = -K_l(\theta_l) \left[\frac{\partial p_l}{\partial x_k} + \rho_l g_k \right]$$

Capillary pressure
$$j_{k,conv}^{m_l} = -K_l(\theta_l) \left[\frac{\partial p_l}{\partial x_k} + \rho_l g_k \right]$$

$$= -\rho_l D_l(\theta_l) \left[\frac{\partial \theta_l}{\partial x_k} \right]$$

Diffusion

Vapour diffusion rate
$$j_{k,diff}^{m_v} = -\frac{D_v(\theta_l, T)}{R_v T} \frac{\partial p_v}{\partial x_k}$$

$$j_{k,diff}^{m_v} = -\frac{D_v(\theta_l, T)}{R_v T} \frac{\partial p_v}{\partial x_k}$$

Air flow rate
$$j_{k,conv}^{m_g} = -K_g(\theta_l) \left[\frac{\partial p_g}{\partial x_k} + \rho_g g_k \right]$$

$$j_{k,conv}^{m_g} = -K_g(\theta_l) \left[\frac{\partial p_g}{\partial x_k} + \rho_g g_k \right]$$

Heat flow rate
$$j_{k,diff}^Q = -\lambda(\theta_l) \frac{\partial T}{\partial x_k}$$

$$j_{k,diff}^Q = -\lambda(\theta_l) \frac{\partial T}{\partial x_k}$$

Where suffixes *l*, *v* and *g* denote liquid, vapour and gas respectively, while *conv* and *diff* means convective and diffusive. *k* describes the direction. Further descriptions:

j = mass or heat flow [kg/m²s] or [W/m²]

K = Water or air permeability [s]

θ = Volumetric moisture content [m³/m³]

p = Pressure [Pa]

x = Coordinate [m]

ρ = Density [kg/m³]

g_k	= Gravity constant [m/s^2]
D	= Diffusivity [m^2/s]
λ	= Thermal conductivity [W/mK]
T	= Temperature [K]

In DELPHIN the transport equations are combined with material functions to characterise the hygrothermal behaviour of materials.

Control volume method (CVM) is used for solving the coupled heat and moisture transport. Therefore, the construction is discretised into small volumes. Volume integrals are converted into surface integrals. The surface integral is transformed into a sum of the flux over all surfaces; the flux entering a given volume is identical to that leaving the adjacent volume. The procedure of estimating the divergence in flux is applied iteratively until convergence is reached for the current time step.

2.2.1.3 Material parameters in DELPHIN

Material characterization procedure DELPHIN

DELPHIN is based on a set of primary material functions. The characterization of hygric material properties includes moisture conductivity (liquid water and vapour) and moisture storage. Both functions depend on the degree of saturation. Moisture storage is measured in form of equilibrium moisture content for defined steps of relative humidity (different salt solutions in exsicator vessels for sorption isotherm curve) in the hygroscopic range and for selected pressure steps (different pressure plate vessels with associated ceramic plates for retention curve) in the over-hygroscopic range. Further descriptions of the methods are given in chapter 5 *Testing procedures for determination of material parameters*.

The number of steps depends on the expected pore radii distribution maxima (modality) of the particular material in the same way as the measurement point-fitted resulting moisture storage curve does. Similarly, the moisture conductivity functions require measurements in different moisture content ranges, measurements for the vapour diffusion and liquid water transfer. The DELPHIN-material characterization procedure was revised in the frame of the RIBuild project in order to achieve both, a more appropriate and accurate characterization of the moisture storage and transport performance. It is based on the work of Grunewald, Scheffler and Plagge (Grunewald, Häupl, & Bomberg, 2003) (Scheffler & Plagge, 2010) (Scheffler, Grunewald, & Häupl, 2004).

Purpose of material characterization approaches is a proper functional description of hygric and thermal storage and transport characteristics. This implies a compromise between the feasible expenditure of time (money) for the laboratory experiments and the accuracy of represented material properties.

Directly measured basic parameters for the DELPHIN material model are the density, porosity, dry thermal conductivity, specific heat capacity, water vapour resistance factor (dry cup), and water uptake coefficient. Derived basic parameters are the effective and capillary saturation, the

“practical” water content at 80% R.H. and the saturated liquid water conductivity. The material functions are the original and reverse moisture storage function, the liquid water conductivity, the water vapour permeability and the thermal conductivity. For air permeable materials, an air permeability function is additionally required. All functions are primarily functions of the liquid water content and the temperature.

The laboratory raw data are determined by a series of experiments, *Table 1* and Section 5 *Testing procedures for determination of material parameters* gives an overview of these. For each experiment, 5-30 specimens have to be prepared (cut, pre-conditioning) in order to receive information on the variance of the properties and to minimize irregularity effects.

Table 1. Basic measurements (experiments) necessary for a complete material characterization (material property) in DELPHIN. Section 6 of the report describes these except a few parameters that are rarely used.

Name of the material property	Name of the corresponding experiment	Symbol	Unit	Described in Section
Bulk density	Via dimensions and weight of the sample	ρ_b	kg/m ³	5.2.1
Matrix (particle) density	Helium Pycnometer	ρ_m	kg/m ³	-
(Open) Porosity	Calculated from density	θ_{por}	m ³ /m ³	5.2.1
Thermal conductivity	Heat flux measurement (plate apparatus)	λ_{dry}	W/mK	5.3.1
Heat storage capacity	Calorimeter experiment	c	J/kgK	5.3.1
Sorption moisture content	Exsicator / Deciccator	$\theta_1(\varphi)$	m ³ /m ³	5.2.4
Retention moisture content	Pressure plate apparatus	$\theta_1(p_c)$	m ³ /m ³	5.2.4
Effective saturation moisture content	Exsicator / Desiccator	θ_{eff}	m ³ /m ³	5.2.4
Dry-cup vapour diffusion	μ dry-cup measurement	μ_{dry}	-	5.2.2
Wet-cup vapour diffusion	μ wet-cup measurement	μ_{wet}	-	5.2.2
Water absorption data	Water uptake experiment	$\theta_1(t)$	m ³ /m ³	5.2.3
Water uptake coefficient	Water uptake experiment	A_w	kg/(m ² s ^{1/2})	5.2.3
Capillary saturation moisture content	Final value of the water uptake experiment	θ_{cap}	m ³ /m ³	5.2.3
Drying data	Drying experiment	$\theta_1(t)$	m ³ /m ³	5.3.4

Conductivity at effective saturation	Indirect	$K_l(\theta_{\text{eff}})$	s	See below
Unsaturated conductivity data	Infiltrometer experiment	$K_l(\theta_l)$	s	-
Air permeability	Permeability of unsaturated porous materials by flowing air	K_p	m ²	5.1.7

In regard to the hygric material properties, three groups of experiments could be distinguished:

1. Moisture storage (section 5.2.4)
 - desorption/adsorption moisture content measurements (exsicator)
 - the retention moisture content (pressure plate apparatus)
2. Water vapour permeability (section 5.2.2)
 - dry cup tests
 - wet cup tests
3. Liquid water conductivity (section 5.2.3 and 5.3.4)
 - water uptake coefficient,
 - drying experiment.

First experiment serves for the identification of the near-saturation range conductivity, second experiment for the identification of the medium-range conductivity. A direct procedure for the determination of the conductivity function is not feasible because of the interrelations between the material functions (moisture storage, liquid water conductivity, vapour conductivity). Therefore, a procedure was developed by Grunewald, Scheffler and Plagge (Grunewald, Häupl, & Bomberg, 2003) (Scheffler & Plagge, 2010), which incorporates the dependencies and comprises certain calibration loops.

The experiments are described in chapter 5 *Testing procedures for determination of material parameters* as indicated in *Table 1*.

Calibration of material functions

DELPHIN material characterization follows a reviewed calibration procedure, which is currently (prototype) implemented in MathCad. The final version is supposed to run with MS Excel to allow an extended user group.

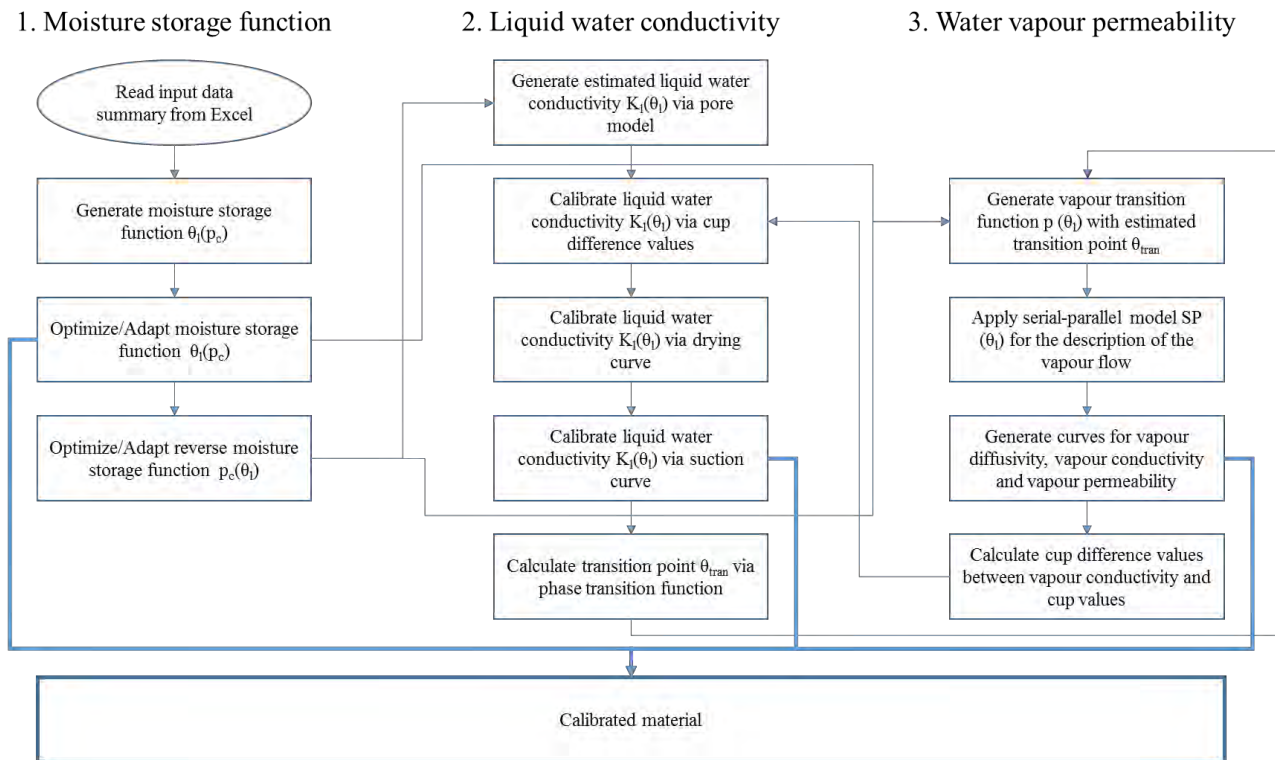

Figure 1. Graphic description of calibration procedure in DELPHIN

The procedure is illustrated in **Figure 1** and consists of the following steps:

- Adjust a generic moisture storage function (Gauss-error function) as a curve fitting on measured desorption isotherm results and water retention results. This implies an estimated modality (number of pore radius maxima depending on the material type) and a normal distribution of pore volume over logarithmic pore radius resp. pore-captured liquid water volume over logarithmic capillary pressure scale. **(1: moisture storage function)**
- Create the initial relative liquid water conductivity function based on the identified pore radius distribution of the moisture storage function. Scale the entire initial relative liquid water conductivity function to the measured value at effective saturation (K_{eff}). **(2: liquid water conductivity function)**
- Estimate the initial vapour permeability based on the measured vapour diffusion resistance factor in the dry range and a first guess for the correction parameter η_{sp} (characterizes the volumetric share of the parallel domains in the material) **(3: water vapour permeability)**
- Estimate the liquid water conductivity function in the hygroscopic range based on the estimated vapour permeability and the measured wet-cup vapour diffusion resistance factors. **(2: liquid water conductivity function)**
- Define a second scaling factor η_{cap} for capillary saturation level of the liquid water conductivity function. Limit the conductivity function via this factor to the measurement result of the water uptake experiment (A_w) for capillary saturation level. Assume a linear course between this point and the maximum value of the conductivity function at effective

saturation, which is gained from permeameter or infiltrometer experiment. **(2: liquid water conductivity function)**

- f) Adjust the scaling function $f_i(\theta_i)$ (includes parameter η_{sp}) and the correction parameter η_{cap} until a sufficient accordance between DELPHIN-simulated and measured drying experiment (variation of η_{sp}) and DELPHIN-simulated and measured water absorption experiment (variation of η_{cap}) results is achieved. This is an iterative adjustment- simulation loop which is not automated yet. **(2: liquid water conductivity function)**

The initial moisture storage function for DELPHIN is achieved from the measured points of the exsicator experiments (material equilibrium moisture content over relative humidity of surrounding air) and the pressure plate experiments (material equilibrium moisture content over pressure). The resulting curves (moisture retention curve and sorption isotherm curve respectively) characterize the drying behaviour of a material because they start with the saturated sample and end up with a nearly dry sample. The same is true for the liquid water conductivity function, which is calibrated with drying experiment results in the most-practice-relevant range of the hygroscopic and lower over-hygroscopic moisture content. Therefore, DELPHIN shows a higher accuracy in the simulation of drying processes than in the simulation of wetting processes. This is compromised concerning the higher moisture content level of the desorption curve in comparison with the adsorption curve and implies a worst-case evaluation which is either pursued for the practice.

The relative liquid water conductivity function equals the reverse of the moisture storage function. This initial guess equals a broad approximation based on the bundle of tubes model. It describes the transport through a porous material as laminar flow through a bundle of parallel and interconnected tubes based on Hagen-Poiseuille approach for each single tube. It's termed relative function due to the necessary scaling, which is a consequence of two simplifications. Firstly, the model assumes an ideal case of volume-proportional share of each pore radius bundle in the entire liquid water transport. Secondly, the model assumes ideal flow through the tubes. The scaling is therefore done in two ways, a limitation to a maximum possible value in form of the liquid water conductivity at effective saturation and a scaling of particular pore radius contributions in form of an adaptation to experiment results in the lower hygroscopic range (drying experiment) and the over-hygroscopic range (water uptake experiment).

Vapour transport is experimentally identified in form of the vapour diffusion resistance factors via dry (μ_{dry}) and wet-cup (μ_{wet}) tests. First value (μ_{dry}) is supposed to be solely a consequence of vapour transport while the second value (μ_{wet}) is assumed to include both, vapour and liquid water transport contingent. This allows an estimation of the vapour conductivity for a hygroscopic material based on the vapour transport coefficient (includes vapour diffusion resistance factor and a scaling term) and the Kelvin-law. The combined vapour and liquid water transport function is identified in the same way, as the difference between the entire moisture conductivity and the vapour conductivity for the measured vapour diffusion resistance factors in the wet range.

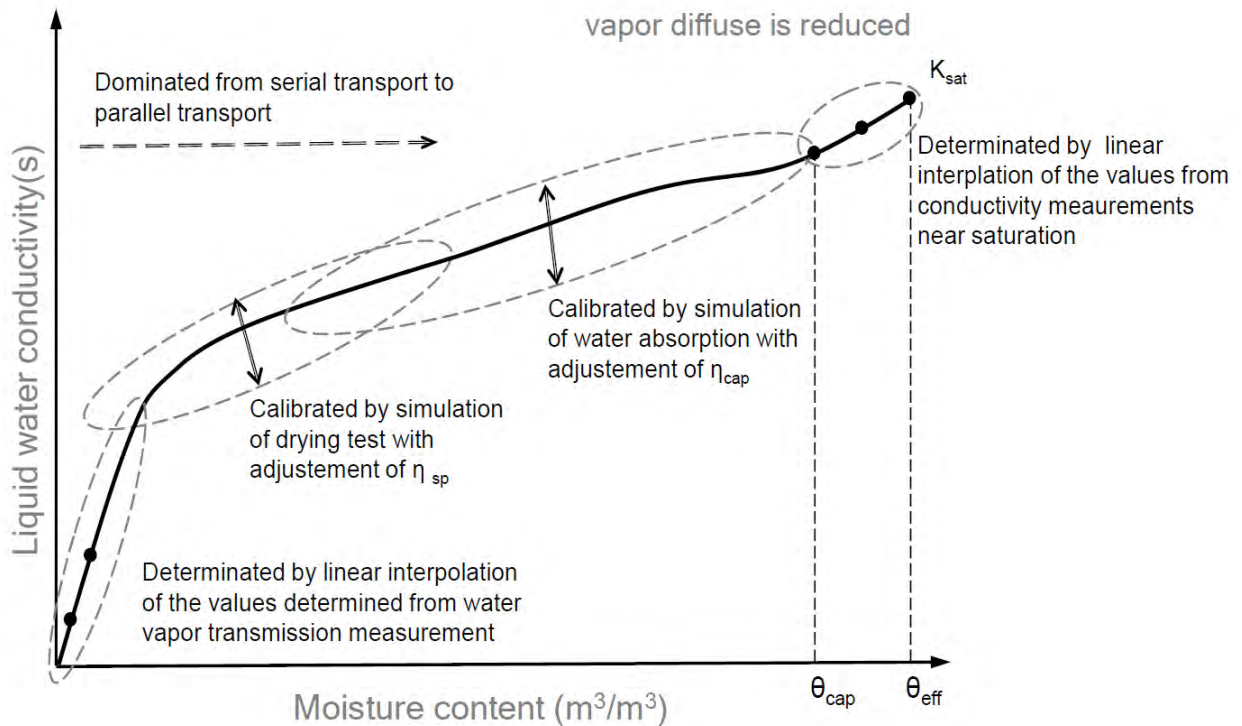

Figure 2. Illustration of how the liquid water conductivity function is determined; partly directly by experiments partly indirectly by calibrations based on water absorption and drying tests.

As a result, DELPHIN contains a large material database with exactly examined and verified material functions with detailed information on all used material properties.

However, all material properties can be varied by the user. Unless the user has calibrated the material functions as described here, there is no guaranty that the user defined set of material properties is realistic in a material. However, there is a general warning in case of manual material modification in DELPHIN.

2.2.1.4 Boundary conditions

Besides building a model of the construction element at interest, a simulation needs information on boundary conditions in form of indoor and outdoor climate. In DELPHIN these are typically transient. Outdoor climate can be hourly values from test reference years from different locations, but also measured data can be used. Input data are:

Outdoor:

- Temperature
- RH / Humidity ratio / Dew point / Vapour pressure / concentration
- Air pressure
- Solar radiation
- Wind speed
- Wind direction
- Horizontal rain

- Long-wave exchange
- Cloud index

Indoor:

- Temperature
- RH / Humidity ratio / Dew point / Vapour pressure / concentration

Furthermore, the program needs simple elements to describe the building component e.g. inclination and orientation. In addition, different surface coefficients can be chosen, depending of which method is used for determining flux.

2.2.1.5 Examples of use and tests against measurements

DELPHIN has wide range of applications:

- assessment of thermal bridges, incl. evaluation of hygrothermal problem areas such as surface condensation, and interstitial condensation
- assessment of external and internal insulation
- calculation of annual heating energy demand based on moisture dependent thermal conductivity
- evaluation of drying problems
- assessment of mould growth risks
- evaluation of ventilated roofs and ventilated facades.

The transport model, and the integrated material and climatic data models were tested in different research projects, e.g. test houses in Talstrasse (Dresden), Herrenschießhaus (Nürnberg), Gemeinschaftshaus (Nürnberg-Langwasser), Umgebäudehaus (Ebersbach), Fachwerkhaus (Niedersachsen/Edemissen), Bahnmeistergasse (Senftenberg), Handwerk 15 (Görlitz) (DELPHIN webpage: <http://bauklimatik-dresden.de/delphin/documentation.php>) as well as by Scheffler (2008).

The implementation and the numerical solution method in the simulation program was checked and is permanently checked if any update of the DELPHIN code is posted, with the following tests: HAMSTAD Benchmarks 1 through 5 (transient heat, air and moisture transport); EN 15026:2007 (Transient heat and moisture transport); EN 10211:2007 (Steady-state heat transport); IBK Wetting and drying (Transient heat and moisture transport, focus on capillary transport in middle and low moisture range) (DELPHIN webpage: <http://bauklimatik-dresden.de/delphin/documentation.php>).

Details on the validation, i.e. model configuration, solver parameters, result calculation etc. are provided in Sontag et al. (2013).

Several research groups have used simulation tool DELPHIN to study hygrothermal processes in the external wall with internal insulation. Häupl and Fechner (2003) have investigated by performing calculations calcium silicate used as insulation on the internal side of external walls and compared the obtained results with field measurements. Klošeiko et al. (2015) have used DELPHIN to assess hygrothermal processes in brick wall with four types of internal insulation materials before

tests are carried out (for more details see Chapter 1.1.1 of this report). Steskens et al. (2013) have used DELPHIN to verify calculations carried out for internal insulation of external wall based on Glaser method according to EN ISO 13788.xx

2.2.2 WUFI

2.2.2.1 The origin of the program

WUFI is designed to calculate simultaneous heat and moisture transport in one- or two-dimensional multi-layered building components in the building envelope based on laboratory and outdoor tests. WUFI is the acronym for "Wärme- und Feuchtetransport instationär" ("Transient Heat and Moisture Transport"). The original basis for the program is given in a thesis by H. M. Künzel (1995) and has been developed into the WUFI-family (WUFI-Plus, WUFI-2D, WUFI-Pro and WUFI-ORN/IBP) which are commercial programmes developed in Germany by the IBP-Fraunhofer Institute for Building Physics.

WUFI simulations can be done according to several regulations; EN 13788 (Glaser method), ASHRAE Standard 160 and EN 15026. WUFI-Bio is a post-processor to simulate the risk of mould growth. The results are given as the Mould Growth Index according to the Viitanen model (Viitanen & Rischkoff, 1991) and in mm mould growth per year according to Sedlbauer's biogrothermal model (Sedlbauer, 2001). Many possibilities exist to adjust material properties, outside and inside boundary conditions.

2.2.2.2 Transport forms included and numerical method

WUFI is designed to calculate simultaneous heat and moisture transport in multi-layered building components. Liquid-phase water transport is modelled by capillary and surface diffusion. Vapour-phase transport is modelled by vapour diffusion and solution diffusion. Heat transfer is a condition of enthalpy flow, long-wave radiation cooling (e.g. at night) and short-wave solar radiation. Convective heat and mass transfer is not modelled in WUFI.

Several transport phenomena have been neglected, that is why e.g. air flow in the component, and uptake of ground water under hydrostatic pressure cannot be calculated. The interface between two capillary-active materials (e.g. rendering/brick) is treated as ideally conducting, whereas in reality there is often a transfer resistance, which may reduce the moisture transport considerably. This resistance may be simulated by introducing an interface layer (ca. 1 mm thick) with adequately adjusted liquid transport coefficients.

Some materials do not conform to the simplified transport equations. Wood and concrete are changing their material data dependent on their present and past moisture content - the imbibed amount of water does not increase as the square root of time. The consequences of this fact may be negligible or serious - depending on the component assembly and the boundary conditions. Here only a comparison with samples exposed to natural weather can show whether the calculation results are reliable or not. The material data should be determined under boundary conditions similar to practical use.

If a material has a pronounced hysteresis in its moisture storage function, it may not be sufficient to use an averaged moisture storage function for the calculation.

The enthalpy flows resulting from the transport of liquid water across a temperature differential are ignored; i.e., cold rainwater does not cool the surface of a building component in the calculation. The cooling effect by the subsequent evaporation of the imbibed water - which is considerably greater in general - is correctly included, however.

For simplicity, the heat transfer coefficients are treated as constant or exhibiting a simple predefined dependence on wind speed.

WUFI uses a non-steady state numerical scheme.

The main equations for heat storage- and moisture storage capacity can be calculated with following formulas respectively:

$$\text{Heat storage-capacity: } \frac{\partial H}{\partial T} \frac{\partial T}{\partial t} = \nabla(\lambda \nabla \varphi) + h_v \nabla(\delta_p \nabla(\varphi p_{sat})) \quad (1)$$

$$\text{Moisture capacity: } \frac{\partial w}{\partial \varphi} \frac{\partial \varphi}{\partial t} = \nabla(D_\varphi \nabla \varphi + \delta_\varphi \nabla \varphi(\varphi p_{sat})) \quad (2)$$

In addition the water vapour diffusion resistance factor (μ), can be calculated with following formula:

$$\mu = \frac{\delta_a}{\delta_p} = \frac{2.0 \times 10^{-7} T^{0.81}}{\delta_p P_n} \quad (3)$$

$\partial H/\partial T$ [J/kg]	heat storage-capacity
$\partial w/\partial \varphi$ [kg/m ³ %]	moisture storage-capacity
w [kg/m ³]	moisture content
λ [W/mK]	thermal conductivity
D_φ [kg/ms]	liquid conduction coefficient
δ_a [kg/ms Pa]	vapour permeability in the air
δ_p [kg/ms Pa]	water vapour permeability
h_v [J/kg]	evaporation enthalpy of the water
P_n [Pa]	normal atmospheric pressure
p_{sat} [Pa]	water vapour saturation pressure
T [K]	Temperature
φ [%]	relative humidity
μ [-]	water vapour diffusion resistance factor

Like in DELPHIN Control volume method (CVM) is used for solving the coupled heat and moisture transport.

2.2.2.3 Material parameters

Table 2 shows which material parameters must be known and what can be calculated in the hygrothermal calculation with WUFI. The upper part lists necessary data, without which calculation is not possible. The lower part lists optional data. Their relevance is dependent of the material and purpose of calculation.

Table 2. Summary table of basic measurements (experiments) necessary for a complete material characterization (material property) in WUFI.

Name of the material property	Name of the corresponding experiment	Symbol	Unit	Described in Section
Bulk density	Via dimensions and weight of the sample	ρ_b	kg/m ³	5.1.1
(Open) Porosity	Calculated from density	θ_{por}	m ³ /m ³	5.1.2
Thermal conductivity (moisture dependent and temperature dependent for insulation materials)	Heat flux measurement (plate apparatus), 10 °C	λ_{dry}	W/mK	5.1.4
Specific heat capacity	Differential scanning calorimetric	c_p	J/kgK	0
Sorption moisture content (specifically θ_{80})	Exsicator / Deciccator	$\theta_1(\varphi)$	m ³ /m ³	5.1.8
Retention moisture content	Pressure plate apparatus	$\theta_1(p_c)$	m ³ /m ³	5.1.9
Water Vapour Diffusion Resistance Factor ($\mu = \frac{\delta_a}{\delta_p}$), moisture dependent	Cup measurement	μ	–	5.1.5
Liquid Transport Coefficient, absorption	Free water uptake	D_{ws}	m ² /s	5.1.6*
Liquid Transport Coefficient, Redistribution	Drying experiment and calculation	D_{ww}	m ² /s	5.3.4*
Enthalpy, temperature-dependent (only phase change materials)	Differential scanning calorimetry	H	J	Not described

* The test methods do not provide the needed material property directly but is used in simplified ways to determine the needed material property as described below.

In WUFI there is a clear distinction between the liquid transport coefficient when there is a supply of water (absorption) and when the supply is cut off (redistribution), based on the theory given by Krischer (1978) of a capillary bundle model with interconnected capillaries of varying diameter. The principle is shown in **Figure 3**.

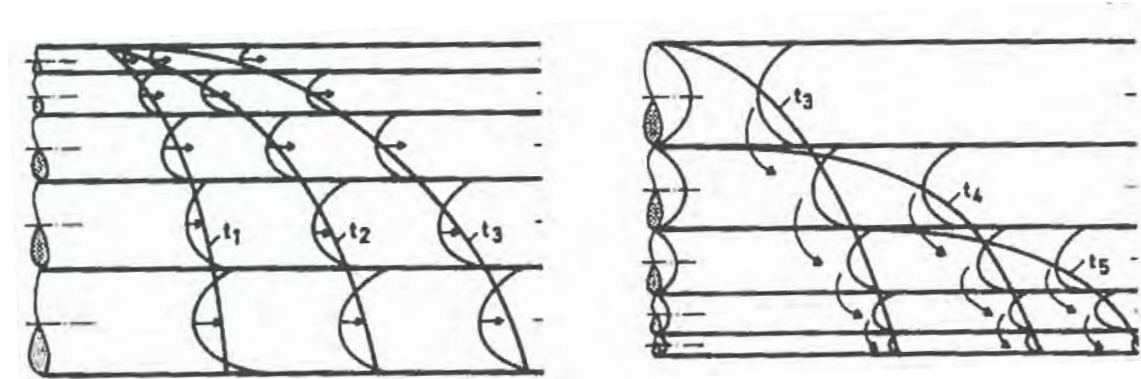

Figure 3. Principle of capillary transport, depending on whether there is water supply and therefore absorption (left hand side) or the supply is cut of and the water redistributes according to the pore size, (right hand side). From Krus & Holm (1999)

Determination of the liquid transport coefficients can be made by precise but time-consuming and cost-intensive methods e.g. nuclear-magnetic resonance or γ radiography, however, in WUFI simplified methods can be used (Krus & Holm, 1999).

A simplified method for determination of the liquid transport coefficient, absorption, D_{ws} , is determined by the equation:

$$D_{ws} = \frac{K\pi A_{cap} \ln\left(\frac{D_{ws}}{D_{w0}}\right)}{4u_f(u_f - u_{80})} + D_{w0}$$

Where:

K = Correction factor [-]

D_{w0} = Transport coefficient in the sorption moisture range ($2 \cdot 10^{-10}$ m²/s independent of material)

u_f = capillary saturation water content [kg/m³]

u_{80} = sorption water content at 80 % RH [kg/m³]

The simplified method for determination of the liquid transport coefficient, absorption, D_{ww} , is an iteration process based on WUFI calculations compared with drying experiments similar to those described in section 5.3.4.

The drying of the material is now simulated in WUFI several times to find the best D_{ww} value. This includes two steps:

1. D_{ww} is assumed to be equal D_{ws} and the heat transfer coefficient is set to be larger than the standard value of 8 W/m²K. The heat transfer coefficient is changed until there is a good correlation between the calculations and the first drying stage of the experiment i.e. until the curve flattens.
2. D_{ww} is now changed until there is only little deviation between the measurements in the experiment, and the calculations in the last part of the curve as well.

According to Krus & Holm (1999) with a little practice, a good correspondence can be found after only two to four calculations.

2.2.2.4 Boundary conditions

Besides building a model of the construction element at interest, a simulation needs information on boundary conditions in form of indoor and outdoor climates. In WUFI these are typically transient. Outdoor climate can be hourly values from test reference years from different locations, but also measured data can be used. Input data are:

Outdoor:

- Temperature
- RH / Humidity ratio / Dew point / Vapour pressure / concentration
- Solar radiation
- Wind speed
- Wind direction
- Horizontal rain
- Long-wave exchange
- Cloud index

Indoor:

- Temperature
- RH / Humidity ratio / Dew point / Vapour pressure / concentration

Furthermore, the program needs simple elements to describe the building component e.g. inclination, orientation and height of the building. In addition, different surface coefficients can be chosen.

2.2.2.5 Examples of test against measurements

With WUFI it is possible estimate the drying times of masonry and lightweight structures with trapped or concealed construction moisture, investigate the danger of interstitial condensation or study the influence of driving rain on external building components. The program can also help to select repair and retrofit strategies with respect to the hygrothermal response of particular roof or wall assemblies subjected to various climates. This allows the comparison and ranking of different designs with respect to total hygrothermal performance.

In addition, WUFI provides an instructive overview of the complex moisture transport phenomena occurring in construction assemblies, making the basic principles and interactions present during moisture transport more accessible and allowing both designers and architects insight into design decisions.

This design tool can also aid the development and optimization of innovative building materials and components. One example is that WUFI simulations led to the development of the smart vapour retarder; a successful application of a software tool to a practical moisture control problem.

Mundt Petersen (2015) has made a single-blind validation of WUFI and obtained in general good correlation between calculated and measured results, but pinpointed where the user has to be extra careful. In the traditional way of comparing measurements and simulation results, these points would have been caught by an experienced user or developer and rectified by a calibration of the simulation.

A number of reports on how WUFI Pro and WUFI 2D perform compared to measurements can be found in the end of the reference list.

Comparison of measurements and WUFI Pro

Alev, Ü., Uus, A., Teder, M., Miljan, M.-J. and Kalamees, T. (2014). Air leakage and hygrothermal performance of an internally insulated log house. Nordic Symposium on Building Physics 2014, Full paper No.7, Lund, Sweden.

Mundt Petersen, S., & Arfvidsson, J. (2010). Comparison of field measurements and calculations of relative humidity and temperature in wood framed walls. In O. Zmeskal (Ed.), Conference proceedings – Thermophysics 2010. (pp. 93-101). Brno University of Technology, Faculty of Chemistry.

Mundt-Petersen, S. O. and Harderup, L.-E. (2013). Validation of a One-Dimensional Transient Heat and Moisture Calculation Tool under Real Conditions. Thermal Performance of the Exterior Envelopes of Whole Buildings XII International Conference, Dec 1-5, 2013, Clearwater Beach, Florida

Ueno K., Straube J., Van Straaten R. (2013). Field Monitoring and Simulation of a Historic Mass Masonry Building Retrofitted with Interior Insulation, Conference Paper CP1301, Thermal Performance of the Exterior Envelopes of Whole Buildings XII International Conference, December 4, 2013, ASHRAE.

Stöckl, B.; Zirkelbach, D.; Künzeli, H. M. (2014). Hygrothermal Simulation of Green Roofs – New Models and Practical Application. Nordic Symposium on Building Physics 2014, Full Paper No. 120, Lund, Sweden.

Villmann, B., Slowik, V., Wittmann, F. H., Vontobel, P. and Hovind J. (2014). Time-dependent Moisture Distribution in Drying Cement Mortars – Results of Neutron Radiography and Inverse Analysis of Drying Tests. Restoration of Buildings and Monuments, 20(1), 49-62.

Comparison of measurements and WUFI 2D

<https://wufi.de/en/2015/04/09/two-dimensional-test-cases-of-iso-10211/>

CEN (2007). Thermal bridges in building construction – Heat flows and surface temperatures – Detailed calculations (EN ISO 10211:2007).

Krus, M. (1996). Moisture Transport and Storage Coefficients of Porous Mineral Building Materials – Theoretical Principles and New Test Methods. Fraunhofer IRB Verlag Stuttgart.

Künzel, H. M. (1995). Simultaneous Heat and Moisture Transport in Building Components. One- and two-dimensional calculation using simple parameters. Fraunhofer IRB Verlag Stuttgart.

Additional references on validation can be found at <https://wufi.de/en/literature/> and <https://wufi.de/en/software/validation/>, where links to the listed publications can be found.

2.2.3 MATCH

2.2.3.1 The origin of the program

MATCH (Moisture and Temperature Calculations for Constructions of Hygroscopic Materials) is a commercial computer simulation program for the calculation of combined transient moisture and heat transport through composite building materials. The one-dimensional model was developed within a research project at the Thermal Insulation Laboratory of the Technical University of Denmark around 1990. The theory behind the program is described in the Ph.D. thesis by Carsten Rode Pedersen (Pedersen, 1990). It was developed as an alternative to the steady state numerical Glaser scheme that is not feasible - i.e. accurate enough - for hygroscopic materials. It was originally developed for roofs, but useful to most kinds of building constructions. The MATCH model (limited to the vapour region) has been partly incorporated in another simulation program, BSim for whole building simulation, since the early 2000's (Rode & Grau, 2003).

2.2.3.2 Transport forms included and numerical method

MATCH calculates heat and moisture transport in composite building components. Moisture as well as temperature distribution are calculated in a transient way.

The following transport forms are included:

- Moisture transport is defined by vapour diffusion driven by water vapour pressure, and liquid moisture flow driven by capillary pressure.
- Sorption and suction curves are used to define the moisture storage function. In the hygroscopic area, the sorption isotherm is used. In the capillary area, moisture transport is modelled using the suction curve in combination with hydraulic conductivity. Hysteresis can be considered.
- Heat transfer in materials is driven by conduction and latent heat flow, while convection and radiation processes are considered at the exterior and interior boundaries. Latent heat flow is transferred by evaporation- diffusion and condensation.

Convection is only considered at the boundaries.

The calculation of the heat and moisture distribution uses the following main formulas:

$$\text{Heat distribution:} \quad \rho c \frac{\partial T}{\partial t} = \frac{\partial}{\partial x} \left(\lambda \frac{\partial T}{\partial x} \right) + \Delta h_v \frac{\partial}{\partial x} \left(\delta_p \frac{\partial p_v}{\partial x} \right) \quad (1)$$

$$\text{Moisture distribution:} \quad \rho \frac{\partial u}{\partial t} = \frac{\partial}{\partial x} \left(K \frac{\partial P_1}{\partial x} \right) + \frac{\partial}{\partial x} \left(\delta_p \frac{\partial p_v}{\partial x} \right) \quad (2)$$

Where:

ρ = density of material [kg/m^3]

c = specific heat of the material [$\text{J}/(\text{kg K})$]

T = temperature [K]

x = one dimensional space coordinate [m]

λ = thermal conductivity [$\text{W}/(\text{m K})$]

K = hydraulic conductivity [$\text{kg}/\text{m s Pa}$]

Δh_v = phase conversion enthalpy, water vapour [J/kg]

δ_p = water vapour permeability [$\text{kg}/\text{m s Pa}$]

p_v = water vapour pressure [Pa]

P_l = capillary water pressure [Pa]

u = moisture content, mass of moisture by dry mass of the material [kg/kg]

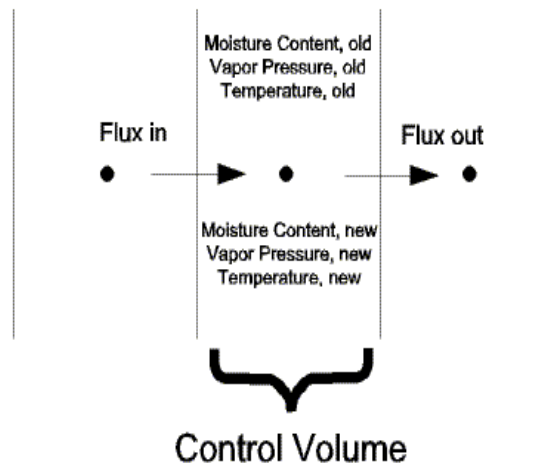

Figure 4. Principle in the Control Volume Method (CVM) method (<http://www.match-box.dk/uk/whatisdescription.htm>)

MATCH uses the Control Volume Method (CVM) to define the fluxes of moisture and temperature. The material is divided into small units i.e. control volumes for the transient calculation where the difference between the inflow and outflow is accumulating in the unit (see **Figure 4**). Small time steps (1 hour) - where the parameters are constant - secure that also short-lasting changes can be taken into account.

2.2.3.3 Material parameters

MATCH includes the following parameters for each material:

- Radiative surface characteristics
- Density
- Heat capacity
- Thermal conductivity

- Vapour permeability
- Sorption curves
- Suction curves
- Hydraulic conductivity (for the liquid transport)

The properties of some materials are variable, since they are moisture- and temperature-dependent. Both absorption and desorption/drying data are needed for the sorption and suction curves, since the program includes a model to consider hysteresis in the retention curves. A user friendly pre-processor, called PREMATCH, delivers the parameters' default values thereby helping to fill in the input data correctly.

To describe material parameters between measured points simplified curves are used. Below some of the most important parameters for calculating moisture transport are explained, mainly based on Petersen (1990).

Sorption curves

Sorption curves - adsorption as well as desorption - are determined experimentally and described mathematically by:

$$u = u_h \left(1 - \frac{\ln \varphi}{A}\right)^{-\frac{1}{n}}$$

Where u_h is the maximum hygroscopic moisture content, φ is the relative humidity, A and n are constants that can be determined by curve fitting of the results of experiments.

MATCH includes hysteresis in sorption curves as well as suction curves.

Vapour transport, water vapour permeability

The water vapour permeability, δ_p [kg/Pa m s], is defined by three fix points, depending on the relative humidity (RH) in the hygroscopic region and moisture content (u) above i.e. relative humidity > 98 %. As a result δ_p can be describes as shown in **Figure 5**.

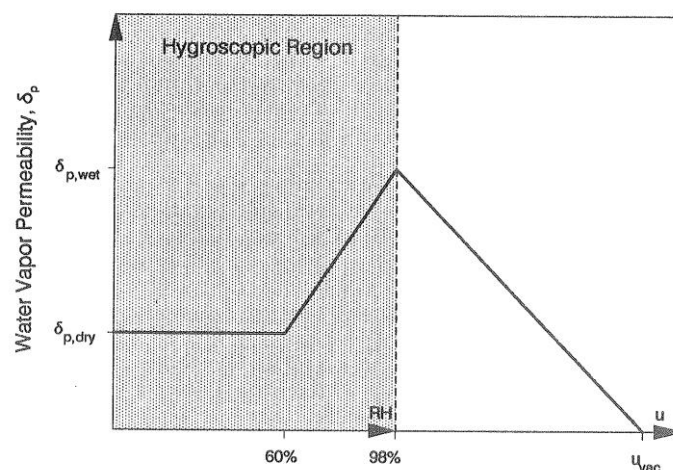

Figure 5. Water vapour permeability as a function of moisture content. The abscissa is linear with relative humidity up to the end of the hygroscopic region and with moisture content above. (Pedersen, 1990)

Liquid transport, moisture content

The over-hygroscopic region is the most interesting region when looking at material parameters used for liquid transport. Moisture content in the over-hygroscopic region is determined by wetting and drying experiments and described by suction curves.

The wetting curve in the over-hygroscopic range starts where the sorption curve ends i.e. at 98 % RH, this corresponds to a suction pressure (at 10 °C) of $P = 2.64 \cdot 10^6$ Pa or $\ln P = 14.79$. The end of the curve is u_{cap} at suction pressure $P = 1$ Pa or $\ln P = 0$, in between the moisture content u is described by:

$$u = u_{cap} - A_{wet} \cdot \ln P^{B_{wet}}$$

Where A_{wet} and B_{wet} are constants that must be determined by fitting the suction curve into the sorption curve differentiably and continuously at $\ln P = 14.79$ i.e. 98 % RH. See **Figure 6**.

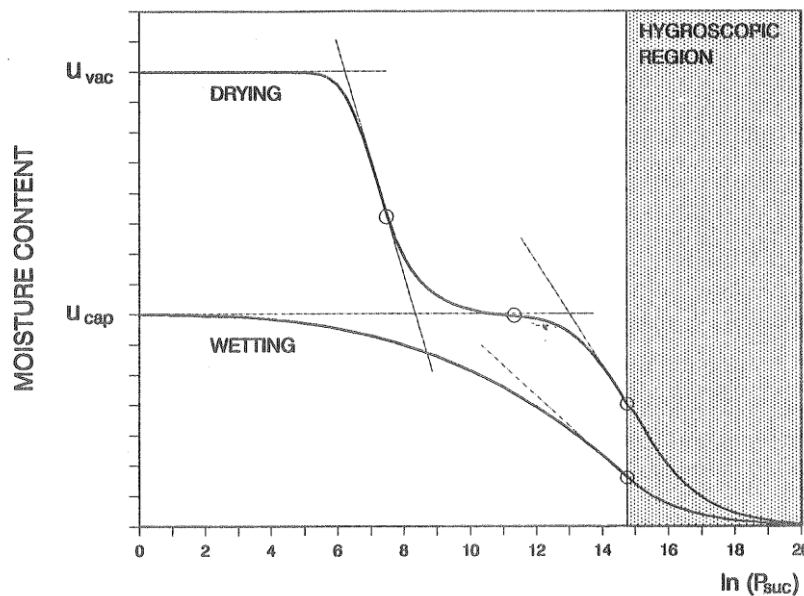

Figure 6. Graphical illustration of estimation of suction curves (Pedersen, 1990).

The drying curve is described by three hyperbolic functions smoothly joined as shown in **Figure 6**. The mathematical expressions of the hyperboles are (from right to left):

Hyperbole close to hygroscopic region:
$$u = A_{des} - \left[(B_{des} \cdot \ln P)^{exp} + (A_{des} - u_{cap})^{exp} \right]^{\frac{1}{exp}}$$

Hyperbole close at inflection:
$$u = u_0 + A_{dry} (\ln P - \ln P_0)^{B_{dry}}$$

Hyperbole at low pressure:
$$u = A_{ipt} - \left[(B_{ipt} \cdot \ln P)^{exp} + (A_{ipt} - u_{vac})^{exp} \right]^{\frac{1}{exp}}$$

The constants A and B are determined so that the curve will be smooth. In MATCH $exp = 30$. There is an inflection point (in **Figure 6** at $\ln P \approx 8$), this point is a point on the suction curve where there is the largest pore size collective.

Close to the hygroscopic region the lines that determines the hyperbole is the linear extrapolation of the desorption curve from $\ln P = 14.79$ (i.e. 98 % RH) and upwards and $u = u_{\text{cap}}$. The hyperbole at the low pressure is defined by the tangent at the inflection point and $u = u_{\text{vac}}$.

Therefore, the inputs needed to determine describe the suction curves are:

- Absorption and desorption isotherms (hygroscopic area)
- Moisture content at capillary and vacuum saturation (u_{cap} and u_{vac} respectively)
- Estimate of the tangent at the inflection point. This can be obtained from experiments determining the suction curve or based on pore size analysis.

2.2.3.4 Boundary conditions

MATCH takes into account the following climatic boundary conditions:

Outdoor:

- Temperature
- RH / Humidity ratio / Dew point / Vapour pressure/concentration
- Solar radiation
- Wind speed
- Long-wave exchange
- Cloud index

Indoor:

- Temperature
- RH / Humidity ratio / Dew point / Vapour pressure/concentration

The outdoor climate is described by using a Test Reference Year (TRY), a measure composed of real, hourly values chosen from a prior period of time, but own weather files of a certain location or constant values can also be used. TRY for MATCH are available for the following countries Denmark, Sweden, Norway, Finland, UK, France, Italy, Belgium and the Netherlands, but the TRY format is documented so files for other climates can be generated.

2.2.3.5 Examples of use and tests against measurements

Results of MATCH simulations have been compared with measurements both in laboratory and field studies. Empirical evaluations of the MATCH simulations limited to conditions in the hygroscopic region has been carried out and the predictions of moisture content and heat flux have been compared with experimental data from a calibrated hot box for 6 lightweight wall constructions typically used in North America (Rode & Burch, 1995). As a result, the program was able to predict the measured values quite well with a RMS difference of ~ 1 % moisture content by weight. Thus, MATCH is a valid tool for the prediction of hygrothermal behaviour of building materials. The deviations are for example seen due to inaccurately described material properties, extreme climatic conditions and errors regarding scaling and moisture uptake rate. Other aspects of the program (e.g. the liquid moisture flow) have been evaluated elsewhere by the program's author (Pedersen, 1990; Pedersen et al, 1992). Others have as well investigated how accurately MATCH

predicts the heat and moisture performance of building structures. For example, Kalamees & Vinha (2003) compared the results of 3 different hygrothermal models (MATCH, 1D-HAM, WUFI 2D) with laboratory tests in relation to 3 types of timber-framed wall structures and concluded that all 3 models were useful.

2.2.4 Similarities and differences in the simulation tools

The three simulation tools, DELPHIN, WUFI and MATCH are all used for simulations and compared with measurements. In general the simulation results have been close enough to reality as to be accepted by researchers and practice as reliable tools for assessment of hygrothermal behaviour of building constructions. However, each tool has limitations and weaknesses. The main difference between MATCH and DELPHIN/WUFI is, that MATCH in its current version does not include wind driven rain and is only available in 1-D.

Finer differences are found in the modelling of some of the transport mechanisms as described in the sections with each tool.

Reliable material properties are always important for simulations, therefore the amount of materials defined in the database in each tool is also important and how these material properties have been determined. In all the simulation tools it is possible to change material properties and thereby describe a specific material if the properties have been measured.

2.3 Other calculation tools and methods

In practice simpler methods than simulation tools are used for assessing the hygrothermal behaviour of constructions. In this section the most used are presented.

2.3.1 Glaser

2.3.1.1 The origin and main purpose of the method

This method was developed by German scientist Helmut Glaser (1958a, b, c, 1959). It is also called moisture profile method, or dew point method.

The Glaser method was developed to determine interstitial condensation risk and condensation speed in building component. The method can also be used as a fast but not very precise method to assess corrosion and mould growth risks. Glaser restricted condensation only to interfaces of layers since the interlayer condensation caused difficulties with the mass conservation law (Hens (2015)).

2.3.1.2 Transport forms included an numerical method

This method allows an isolated evaluation of steady-state, one-dimensional vapour diffusion processes, using constant material properties. Materials are assumed dry until condensation occurs at interfaces when RH=100%. The amount of condensed water at the interface can be determined. When presented graphically, vapour diffusion resistance is illustrated on X axis and vapour and saturation pressure on Y axis.

The method simplifies heat transport by only regarding conductivity and describing the thermal resistance R_j [$\text{W}/\text{m}^2\text{K}$] of material j as:

$$R_j = \frac{\lambda_j}{d_j}$$

where λ_j is the thermal conductivity [W/mK] and d is the thickness of material j [m].

The temperature change, $\Delta\theta_j$ [K] over material j is described by:

$$\Delta\theta_j = \frac{\Delta\theta_{tot}}{R_{tot}} \cdot R_j$$

where R_{tot} is the total thermal resistance (including surface resistances) of the construction and $\Delta\theta_{tot}$ is the total temperature change over the construction.

The simplified moisture transport is described by diffusion only. The vapour diffusion resistance Z_j [$\text{Pa m}^2 \text{ s}/\text{kg}$] is given by;

$$Z_j = \frac{\delta_j}{d_j}$$

where δ_j is the vapour permeability [$\text{kg}/\text{m s Pa}$] of material j .

The vapour pressure difference, Δp_j [Pa], over the material is given by:

$$\Delta p_j = \frac{\Delta p_{tot}}{Z_{tot}} \cdot Z_j$$

where the Δp_{tot} describes the total change of vapour pressure over the whole construction, and $Z_{tot} = \sum_{j=1}^n Z_j$ is the total vapour resistance of the whole construction.

In this way temperature and vapour pressure can be determined in all points where two material layers meet. Based on the temperature the saturated vapour pressure can be found and the relative humidity determined including if there will be interstitial condensation.

2.3.1.3 Material parameters

- thermal conductivity of material [W/mK]
- water vapour resistance factor [-] or vapour permeability of material [$\text{kg}/\text{m s Pa}$]
- material thickness [m]
- thermal resistance of internal and external surfaces [$\text{W}/\text{m}^2\text{K}$].

2.3.1.4 Boundary conditions

The following boundary conditions are used for Glaser method:

- average monthly outdoor and indoor air temperature

- average monthly outdoor and indoor air relative humidity

2.3.1.5 Examples of testing against measurements and other tools

The Glaser method has been widely used since it was developed. It serves as basis for ISO EN 13788 *Hygrothermal performance of building components and building elements. Internal surface temperature to avoid critical surface humidity and interstitial condensation*.

The Glaser method does not take into account that:

- materials can be wet at the beginning from either built in water or rain.
- materials can be hygroscopic.
- water moves by a combination of both vapour and liquid flow.
- material properties are affected by moisture content.
- Solar radiation and long waved radiation has an effect.
- 2D and 3D flows are of importance.
- driving forces are changing over time.

This method is applicable for many lightweight structures with little storage capacity while for modelling heavy structures with water storage capacity should be done with more complex models. The Glaser method can be used for the initial assessment and more sophisticated simulation tools should be applied for more precise simulation (Häupl et al., 2005).

Comparing Glaser and DELPHIN simulation results

Purviņš (2016) has made a comparison between Calculations with the Glaser method and simulation with DELPHIN:

- *The goal of simulation:* to assess amount of interstitial condensate on the internal surfaces of materials and mould growth risks by applying internal and external insulation and different materials.
- *Simulated construction:* the wall consists of three layers – plaster (25 mm), bricks (500 mm) and insulation (50 mm). Five types of insulation materials are modelled: mineral wool, EPS, aerogel, vacuum panel (VIP) and PIR (see Table 3).

Table 3. Parameters of wall construction used for simulations

Parameter	Material						
	Brick	Gypsum plaster	Mineral wool	EPS	Aerogel	VIP	PIR
Density, kg/m ³	1560	850	60	15	146	200	26,5
Specific heat, J/(kg·K)	850	850	850	1500	1000	800	1470
Open porosity, m ³ /m ³	0,38	0,65	0,95	0,95	0,92	0,001	0,99
Saturated moisture content (long term), m ³ /m ³	0,35	0,356	0,9	0,935	0,9	0,001	0,905
Saturated moisture	0,25	0,35	0,9	0,0007	0,9	-	-

content (short term) , m^3/m^3							
Vapour sorbtion content (RH=80%), m^3/m^3	0,0025	0,020342	$1,6 \cdot 10^{-4}$	$6 \cdot 10^{-4}$	$1,6 \cdot 10^{-4}$	0	$1,5 \cdot 10^{-6}$
Thermal conductivity, $\text{W}/(\text{m} \cdot \text{K})$	0,6	0,2	0,04	0,04	0,014	0,007	0,024
$A_w, \text{kg}/(\text{m}^2 \cdot \text{s}^{0,5})$	0,227	0,366961	0	$1 \cdot 10^{-5}$	0	$8 \cdot 10^{-6}$	$8 \cdot 10^{-6}$
μ	14,93	8,3	1,3	30	4,7	$1,5 \cdot 10^6$	51,5
Conductivity of liquid water in saturation, s	$2,344 \cdot 10^{-9}$	$5,531 \cdot 10^{-9}$	0	0	0	0	0
Air permeability, s	-	-	0,0001	-	0,0001	-	-

Indoor and outdoor climate: indoor temperature +19°C. In Glaser method Class 3 is calculated. For DELPHIN indoor relative humidity is 50%. Daily outdoor temperature, relative humidity and solar radiation is for Riga and wind driven data from Munich.

Results and conclusions

Both Glaser and DELPHIN predict that moisture content in the wall with internal insulation is highest with mineral wool and lowest with VIP, however major discrepancies is found:

- Accumulated condensation volume with internal insulation layer is much higher when calculated with Glaser method. This is due to calculation of condensation – in Glaser method condensation occurred every month while in DELPHIN condensate is generated only from September until April. Glaser method does neither take drying processes into account nor capillary transport.
- When external insulation is applied, Glaser method predicts internal condensation while DELPHIN does not. It might lead to misjudgement of the situation and wrong conclusions.
- Wind driven rain is shown to be of importance. The largest difference in results is observed when this is taken into account. Glaser method does not take into account wind driven rain while DELPHIN does. Calculations carried out with Glaser method show that internal insulation with VIP does not cause any moisture problems. Simulation results from DELPHIN show that when moisture penetrates to juncture layer of insulation and brick, mould growth, efflorescence and freeze-thaw problems can appear.
- Mould growth risk calculation with Glaser method compared to DELPHIN VTT method is limited. Glaser method results show the same results for all wall types. DELPHIN simulation is more nuanced. It also gives results how the mould affects the construction while the Glaser method determines whether there is mould growth risk.

2.3.2 COND

2.3.2.1 The origin and main purpose of the tool/method

The COND software was developed at The Institute for Building Climatology at Dresden University of Technology, Germany. The calculations are based on an algorithm developed by Prof. Dr.-Ing. habil P. Häupl in the 1980s. COND was developed to improve the Glaser method especially in relation to certain constructions. In the analysis, many simplifications and idealisations have been introduced that further narrow the scope of the method.

COND is a software for hygrothermal evaluation of one-dimensional building envelope systems, as it calculates the stationary heat and moisture transport. Based on the Glaser scheme standard method according to the German standard DIN 4108-3 (2014) and described in section 2.3.1 *Glaser* that only takes vapour fluxes due to differences in vapour pressure into account, COND additionally includes liquid fluxes, i.e. the redistribution of occurring internal condensate. Thus, the results are more realistic and it is therefore especially useful for multilayer constructions with capillary active internal insulation materials that are used for a thermal upgrade and refurbishment of older buildings.

COND is a simple and fast practice tool for the evaluation of possible moisture damage of the building envelope taking simplified climatic conditions into account. It needs limited input data and climatic conditions and material properties can be used-defined. The outcome is a short report stating whether or not the requirements of the chosen standard are fulfilled or not can be customized. The report includes a sketch of the construction, material and climate data, temperature, moisture and vapour pressure profiles and individual remarks. This report can be used for documentation purposes. Since COND provides the needed verification according to the German DIN 4108-3 (2014), it is mainly used in Germany, but may also be useful elsewhere if the German standard is regarded as acceptable.

2.3.2.2 Transport forms included

COND considers the following transport and storage processes:

- Humidity-dependent thermal conductivity (but latent heat not taken into account)
- Constant vapour diffusion
- Linear increase of liquid water transport
- Moisture storage due to difference of incoming and outgoing moisture fluxes (vapour diffusion and capillary transport), hygroscopic uptake according to linearized moisture storage function

Thermal storage, phase changes, wind driven rain, solar radiation, long waved radiation and air fluxes are not taken into account in COND.

2.3.2.3 Material parameters

COND has a comprehensive material database in which > 500 materials are shown tabulated. Own materials and constructions can also be defined and added.

Materials in the material database are defined by the following properties:

- Bulk density, ρ [kg/m^3]
- Thermal conductivity, λ [W/mK]
- Vapour diffusion resistance factor, μ [-]
- Moisture content at 80 % RH, W_{80} [m^3/m^3]
- Moisture content at saturation, W_{sat} [m^3/m^3]
- Water absorption coefficient, A_w [$\text{kg}/\text{m}^2\text{h}^{1/2}$]

2.3.2.4 Boundary conditions

COND uses temperature and relative humidity at each side of the construction as inside and outside boundary conditions. Driving rain is not taken into account. The climatic conditions are constant and can be chosen according to the German standard DIN 4108-3 (2014) or can be user-defined (but also constant). The climate according to DIN 4108-3 (2014) is defined in a simplified way as block climate, i.e. a condensation period of 90 days (Winter time: December to February) and an evaporation period of 90 days (Summer time: June to August).

Other boundary conditions that simulation tools include like orientation of the building, building height or the like cannot be specified in COND.

2.3.2.5 Examples of testing against measurements and other tools

The steady state COND calculations allow a more advanced verification of the construction than the Glaser method. It is not comparable with state-of-the art numerical hygrothermal simulation tools like WUFI and DELPHIN; analytical non-steady state calculation methods that include more precise and realistic climate data providing a simulation of real temperature and moisture fluxes in the construction.

Although the COND analysis provides more realistic condensation and evaporation quantities than the Glaser scheme, it is also based on several necessary simplifications and assumptions:

- linear dependence of thermal conductivity from moisture content
- simplified linearised sorption isotherms
- constant vapour diffusion
- linearised function for the capillary transport of liquid water.

Figure 7 shows how the simplified linearised sorption isotherms in COND differ from the real course and **Figure 8** the course of liquid water diffusivity.

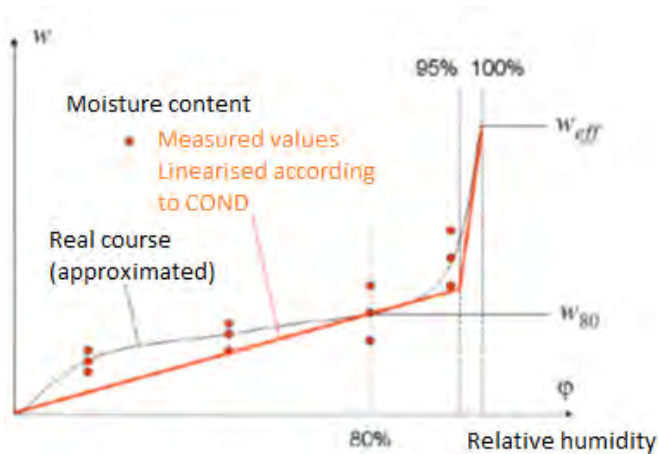

Figure 7. Simplified linearised sorption isotherms in COND. Ref.: Ruisinger & Grunewald (2009) p. 19

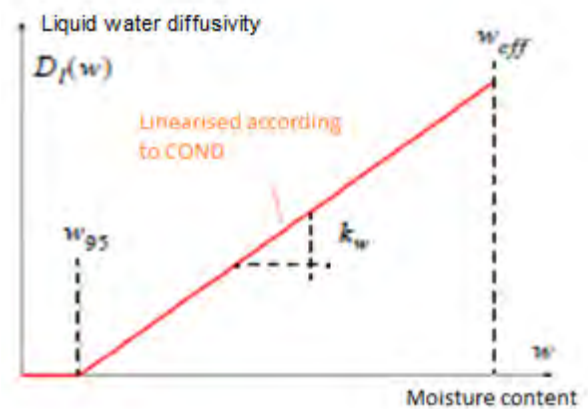

Figure 8. Approximate course of liquid water diffusivity. Ref: Ruisinger & Grunewald (2009), p. 21

COND calculates whether or not the moisture content and other related requirements are in agreement with the limits specified in the German standard, thus the result is the information whether or not the construction will be moisture safe. As such, the calculation method is not validated, since it is based on values taken from German standards that are reasonable.

2.3.2.6 References

DIN 4108-3. Thermal protection and energy economy in buildings - Part 3: Protection against moisture subject to climate conditions; Requirements and directions for design and construction. November 2014.

Ruisinger, U., Grunewald, J. (2009). Feuchteatlas zur Vermeidung planungsbedingter Feuchteschäden: neue Beurteilungskriterien zur Bewertung innen gedämmter Konstruktionen; Abschlussbericht. Technische Universität Dresden, Institut für Bauklimatik.

2.3.3 Eco-Sai tool based on Glaser method

2.3.3.1 The origin and main purpose of the tool/method

Eco-Sai is a stand-alone tool developed by the University of Applied Sciences of Western Switzerland that combines the calculations of U-value, thermal inertia and life cycle assessment of a construction (homogeneous and inhomogeneous) (www.eco-sai.ch). At present it is the single integrated tool for these three calculations. Eco-Sai can evaluate the characteristics of a construction during the preliminary stage or the project phase, for new buildings or renovation projects. Planners using the CAO Autodesk® Revit® software can also conduct these calculations within Revit®

2.3.3.2 Transport forms included and evaluation based on the method

Eco-Sai evaluates both surface and interstitial moisture and is based on the same calculations of heat and moisture transport as used in the Glaser method described in EN ISO 13788 (2012) and Section 2.3.1 *Glaser*; thermal conductivity and vapour diffusion.

Therefore, interstitial condensation is evaluated by performing a monthly calculation to check moisture levels within the construction element during the year. According to SIA 180 standard (1999), the evaluation using the Glaser method is successful when:

- After a full year, no remaining moisture is left within the construction element at the end of the summer;
- During periods when condensation occurs, moisture levels are lower than
 - 3% of the mass of wooden materials ;
 - 1% of the volume of the insulation materials ;
 - 800 g/m² for porous materials with capillary transport capabilities.

For the surface moisture, the risk of mould or condensation appearing on the internal surface of a construction element is evaluated according to the SIA 180 standard (1999). A internal surface resistance factor (f_{Rsi}), taking surface temperature into account as well as interior and exterior ambient temperatures, can be calculated using the following formula:

$$f_{Rsi} = (T_{si} - T_{ext}) / (T_{int} - T_{ext})$$

f_{Rsi} : Superficial internal resistance factor [-]

T_{si} : Internal surface temperature [K]

T_{int} : Internal temperature [K]

T_{ext} : External temperature [K]

If f_{Rsi} is higher than a pre-defined minimum value, the construction element is in conformity with SIA 180 requirements and therefore conceptually sound regarding surface condensation. The minimum value is in the 0.70 to 0.76 range and depends on the climate where the building is located.

Next to the hygrothermal assessment, Eco-Sai performs LCA calculations of construction elements and full buildings. The calculations use the life cycle approach, taking into account the main stages of the building life, from materials manufacturing to elimination at the end-of-life. The methodology complies with EN ISO 14040 standard.

2.3.3.3 Material parameters

The following material parameters are used for Glaser method and also for Eco-Sai

- thermal conductivity of material
- water vapour resistance factor or vapour permeability of material
- material thickness
- thermal resistance of internal and external surfaces.

2.3.3.4 Boundary conditions

The following boundary conditions are used for Glaser method and also for Eco-Sai:

- average monthly outdoor and indoor air temperature
- average monthly outdoor and indoor air relative humidity

2.3.3.5 Examples of testing against measurements and other tools

The Glaser method has some limitations. One of which is that materials which vapour permeability varies depending on interior humidity cannot be taken into account properly. Similarly, a previous study (Bouesse, 2013) examined the possibility of using the Glaser method with hourly climate data and variable vapor permeability but it was not successful. As a result, a dynamic simulation tool using the EN ISO 15026 standard (2007) is required in such cases. As interstitial moisture calculation is limited to 1D models in Eco-Sai, each section of inhomogeneous construction elements has to be evaluated separately.

3 Material properties of building materials used in historic buildings

Hygrothermal behaviour of building constructions depend on the material properties. As described in Blumberga et al. (2015b) each porous material has its own response to water vapour and liquid water, depending on e.g. pore shape, size and how the pores are interlinked. As a result, many material properties are necessary to describe the hygrothermal behaviour of a material. Some of them are single numbers others are described by curves. As described in section 2.1.3 *Simulation tools today* primary material characterization i.e. only including pure material properties is not sufficient to describe materials as combined processes are neglected. However, to make the description of the hygrothermal behaviour of a material operational, the material properties in this report are given by single numbers; in some cases, these represent different points on a curve.

This section has two subsections; the first considers historic building materials while the second considers new insulation materials that are used for internal insulation of historic buildings. In both subsections it is described how material properties for the materials have been gathered and the results in form of compilations on material properties.

3.1 Existing information on material properties

Material properties are used for characterization of materials and are therefore often given in textbooks. Unfortunately, textbooks often focus on few parameters, e.g. thermal conductivity and density, and not a complete set of data with both heat and moisture related properties. This has probably historical reasons, e.g. properties related to heat transport has been of interest for a long time, as these have been used to estimate the size of a heating system. Consequently, many researchers in the past may only have measured thermal properties. Combining tables of thermal properties with tables of hygric properties may often be the only way to find hygrothermal properties of a material. However, the combination may not always be true, as there is no guarantee that the measurements were performed on the same material. E.g. aerated concrete is a broad term; density of aerated concrete vary and thereby the thermal conductivity, porosity etc. If properties from different sources are combined it is important at least to make sure, that one parameter is measured by both sources to be the same. Otherwise, combination of data may be unrealistic.

The material properties that have been compiled in RIBuild are the hygrothermal properties that were available and preferably twelve properties that the simulation tool DELPHIN uses for its calculations, see section 2.2.1.3. Single points at certain values describe sorption curves and suction curves.

3.1.1 Delimitation of historic materials

Bricks, natural stones and mortars and plasters are the most common materials in outer walls of historic buildings (Blumberga et al., 2015a). Therefore, compilation of material properties has focused on these materials. Half-timbered walls are not treated specifically; these are a 2-D combination of timber and bricks. In some half-timbered walls the infill panels are wattle and daub,

giving material properties of wattle and daub is not meaningful as the material will be to inhomogeneous both geographically and especially in quality.

3.1.2 Sources of material properties

A few databases focus on hygrothermal material properties of materials used in historic buildings. MASEA (www.masea-ensan.de) is a German database of material properties of historic building materials; the database focuses on refurbishment and is based on a research program funded by the German Federal Ministry for Economic Affairs and Energy. Many of the materials are also included in the databases for DELPHIN and WUFI simulation tools.

Other projects like the EU funded project TABULA / EPISCOPE (www.episcope.eu) and SUSREF (<http://cic.vtt.fi/susref>) do focus on existing buildings, energy and refurbishment. Unfortunately, their focus have been less on hygrothermal material properties and more on energy use and sustainability data, respectively.

In RIBuild material properties have been collected from many sources; some directly from partners, who has determined the properties experimentally, either for clients as a part of the services their laboratories sell or as part of projects, including RIBuild, where material data has been needed. Some material properties have been found in textbooks from many countries and must be regarded as more or less generic. Unfortunately, there is a general lack of information on how many samples the material properties are based on. Likewise, information on how the properties were determined are also rare. Consequently, the uncertainty of the measurements and hence the material properties is unknown; some may be very precise while others may be based on crude measurements, that do not comply with standard methods.

Furthermore, some of the material properties may have a bias; e.g. thermal conductivity is an important parameter when calculation heat loss through a wall, increased thermal conductivity will lead to increased heat loss. Some materials may vary in their thermal conductivity, if the heat loss is underestimated, it may result in a too small heating system. The thermal conductivity may therefore have a tendency to be higher in textbooks than the average in reality, for estimation of heating systems this would be on the safe side.

3.1.3 Hygrothermal properties of brick, natural stone, plaster and mortar

The compilation of material properties for historic building materials is made and optimized as .exe file format, but due to the fact that only one single document can be uploaded to the participant portal and since the .exe file cannot easily be converted into a doc.file and attached to this deliverable, we will provide the files at any time upon request. However, an example of how the sheets are organized is shown in Table 4.

The shown table is not complete but shows only a representative selection of materials i.e. there are more materials in each category of insulation materials than shown here. The sources of the material properties are also omitted in Table 5, but given in the Excel file. For some of the materials some of the properties e.g. for sorption and suction curves are available as several points on curves. These are given in a separate table not shown here, but included in the Excel file.

Table 4 Compilation of material properties. Extract showing a selection of bricks and natural stones. The full table includes further of these as well as mortars and plasters

Country reported	Specific type	Bulk density [kg/m ³]	Porosity [%]	Specific Heat Capacity [J/g K]	Thermal Conductivity [W/m K]	Thermal Conductivity, temperature depen. [W/m K]	Thermal Conductivity, moisture dependent [W/m K]	Water Vapour Resistance Factor, dry cup [-]	Water Vapour Resistance Factor, wet cup [-]	Water absorption coefficient [kg/m ² ·s ^{0.5}]	Moisture Storage Function (sorption curve)	Moisture Storage Function (suction curve)	Reference moisture content, at RH = 80% [kg/m ³]	Moisture content, free water uptake [kg/m ³]	Moisture content at saturation [kg/m ³]
Brick															
BE	Ceramic brick	2054	22,08					18	12	0,05	see tab			102,8	220,5
		2082	20,97					24	13	0,05				104,9	209,4
		2071	21,41					24	18	0,06				115,8	213,8
		2107	19,66					17	13	0,05				107,5	196,3
		2094	20,46							0,04				107,0	204,3
		2082	20,92					21	14	0,05				107,62	208,88
BE	Vandersanden Robusta	1834	32,43					11	10	0,61	see tab	see tab		207,7	323,7
		1771	33,09					11	10	0,63				215,4	330,2
		1827	32,71					12	11	0,59				207,0	326,5
		1841	32,28					12	10	0,61				203,6	322,2
		1818	32,63					12	10	0,61				208,4	325,6
CH	Clay brick, module	1100		0,9	0,44			4	6						
CH	Calcium-silicate brick	2000		0,9	1,1			10	25						
DK	Marienlys tegl	1825	31,00					17		0,195					
DK	Brick Joens	1790	36,00					14		0,227					0,647
GR	Roman fired-Bricks, Filippi (historic)	1678								0,031					
GR	Byzantine fired-Brick, Hagios Panteleimonas (historic)	1518								0,138					
IT	General (density 1600)	1605	36,83		0,53			39	9	0,129					
LV	Aristida Briana iela, Riga yellow clay brick 1910s	1862,2	24,41												
	2	1834,7	23,37												
	3	1903,2	24,23												
	4	1902,8	24,86												
	5	1849,8	23,95												
	6	1855,4	23,20												
LV	Teodora Breiksa iela 41, Liepaja red clay brick, 19th century	1831,5	21,11												
	2	2060,6	12,26												
	3	1863,4	17,59												
	4	1869,2	17,21												
	5	1876,8	21,96												
	6	1663,4	25,43												
SE	Lime silica Brick	1894	28,00							0,08					
SE	Hard-burnt bricks ('hårdbränt tegel' in Swedish)	1900			0,89										
Natural stone															
CH	Shell limestone	2366	11					203	67				1,57		5,76
CH	Kalkstein - hard limestone	2600-2800	0,6-2,0	0,87907	3,5-5,8					0,5-1,5					
DK	Basalt, acc. DS 418	2700													

Although most original plasters and mortars in historic buildings are based on lime and gypsum (Blumberga, 2015a), several plasters and mortars with cement as binder is also included, as this more “modern” kind of mortar may have been used in previous refurbishment for historic buildings.

As expected, there are only few complete sets of hygrothermal properties, mainly data sets already used in the DELPHIN database.

3.2 Material properties of internal insulation materials

One of the outcomes of RIBuild is a tool to estimate robust internal insulation methods. The idea is to calculate many situations and describe whether they are robust or not. These calculations are based on a methodology developed in RIBuild WP4 and are executed as part of WP6. To perform the calculations hygrothermal properties not only for historic building materials but also for internal insulation materials are needed. Therefore, also a compilation of material properties for internal insulation materials has been made. These normally come as more or less defined systems; some are combinations of a specific thermal insulation material and e.g. a non-specific vapour barrier and gypsum or plywood board others are systems where all components are specified.

A distinction was made between systems that are condensate tolerating, condensate limiting or condensate preventing (Blumberga et al., 2015b). As this information is needed neither for the hygrothermal calculations nor by the user, it is therefore not used in this deliverable.

The main sources for the material properties of insulation materials are the manufacturers of the material; they have an interest in being able to provide practitioners with material properties and have therefore already tested the materials. Nevertheless, in most cases not all material properties are available, and the most comprehensive data sets are those used in the databases of simulation tools e.g. DELPHIN database.

The compilation of material properties for internal insulation materials is made and optimized as .exe file format under the conditions described in Section 3.1 An example of how the sheets are organized is shown in **Table 5**.

The shown table is not complete but shows only a representative selection of materials i.e. there are more materials in each category of insulation materials than shown here. The sources of the material properties are also omitted in **Table 5**, but given in the Excel file.

Table 5. Compilation of properties of internal insulation materials. Extract showing a selection of EPS, XPS, PIR, PUR based systems. The full table includes further of these as well as systems based on Mineral wool, mineral based materials (e.g. aerated concrete, Calcium Silicate), Wood fibre and other organic materials.

Country	System type	Manufacturer	Layer type (pick from list)	Standard thickness [mm]	Layer name (product specific)	Bulk density [kg/m ³]	Porosity [%]	Specific Heat Capacity [J/g K]	Thermal Conductivity [W/m K]	Water Vapour Resistance Factor, dry cup [-]	Water Vapour Resistance Factor, wet cup [-]	Water absorption coefficient [kg/m ² s ⁻¹]	75% RH (pick from list)	Moisture content, free water uptake [kg/m ³]	Moisture content at saturation [kg/m ³]	Remarks	
EPS based																	
CH	EPS		Internal cladding	25	Gypsum plasterboard (2x)	900		0,7992	0,21	5	10						
					Technical space and wood lathing												
			Vapour barrier		[no specific product mentioned]												
		Swisspor	Insulation	40-160	EPS30	30		1,404	0,033	60	60						
		Fixit		30-150	existing wall possible external insulating rendering	220			0,028	3	5						
IT	EPS + plasterboard	Knauf	Adhesive	5-7	SM700	1400			< 0.54	11		≤ 0,2					
		Knauf	Insulation	40/50/60/80/100/120/140/160/180/200	EPS 100			1,45	0,035	30-70							
		Knauf	metal C profile		C profile 27/50/27; i=600mm												
		Knauf	Plasterboard	9,5/12,5	GKB (A)	≥ 680			0,2	10	4						
LT	EPS plates with graphite	Tenapors	Insulation	20-1200	Tenapors EPS NEO	14-27			0,03-0,032	20-70						with step 10 mm	
SE	EPS (Expanded Polystyrene) foam		Insulation			30			0,055								
XPS based																	
CH	XPS	Swisspor	Adhesive		mortar												
			Insulation	20,30,40,50,60,80,100,120,140,160,180,200,220,240,260,280,300,320,340,360	Swisspor XPS 300 GE	30			0,036	80-250							
IT	XPS + plasterboard	Knauf	Adhesive	5-7	SM700	1400			< 0.54	11		≤ 0,2					
				20/30/40/50/60/80/100/120/140/160	POLYFOAM Ultragrip SE			1,7	0,035	80							
		Knauf	Insulation		C profile 27/50/27; i=600mm												
		Knauf	Plasterboard	9,5/12,5	GKB (A)	≥ 680			0,2	10	4						
PIR based																	
CH	PIR		Internal cladding	25	Gypsum plasterboard (2x)	900		0,7992	0,21	5	10						
					Technical space and wood lathing												
			Vapour barrier		[no specific product mentioned]												
		Swisspor	Insulation	20-240	SwissporPUR (PIR) Pr	30		1,404	0,02	100000	100000						
		Fixit	Surface rendering	30-150	existing wall possible external insulating rendering	220			0,028	3	5						
LT	Insulation plates from PIR	Finnfoam	Vapour barrier from Aluminium layers			33			0,023								
			Insulation from PIR	20/30/60	FF-PIR 30/40/70 GYL				0,023								
			Glue from polyurethan							0,023							
			Gypsum board	9,5						0,023							
PUR based																	
CH	PUR	Swisspor	Insulation	20,30,40,50,60,80,100,120,140,160,180,200,220,240	Swisspor PUR Premium	30			0,02	100000							

As for the historic building materials not all the information given by the manufacturers include description of test method, although some can provide test reports where tests have been performed according to international standards.

The compilations show, that many material properties are lacking, therefore, it is necessary to find ways to perform simulations without complete knowledge of material properties. The next section therefore focuses on how to decide which materials perform hygrothermally alike.

3.3 Clustering

3.3.1 Uncertainties in hygrothermal simulations

There are several obstacles in assessing the hygrothermal performance of outer walls of a historic building:

- Determining the specific materials of the wall. E.g. if the material is brick, the range for each material property is large and it is difficult to determine which simulation with deterministic material properties is the most correct.
- Deterministic material property values will give deterministic outcomes of a hygrothermal simulation. Uncertainties in e.g. material properties will not be included, and the outcome may therefore pretend to be more precise than the input allows. A more nuanced way would be a probabilistic approach as this includes numerous simulations with different but similar materials and find a probabilistic answer to whether a solution is robust or not. Alternatively, hygrothermal simulations should be made with material properties that are given by a mean value and a standard deviation. The outcome would be probabilistic.
- Using a probabilistic approach with not very well defined materials e.g. material data of low quality, the outcome will have very high standard deviation. Consequently, the chosen solution will have to be much on the safe side, while a more precise outcome may have allowed better insulation and therefore less heat loss.
- A complete test of historic materials would minimise the uncertainties but is expensive and time consuming. If it is possible to place the material in a cluster of materials where the variation in material properties is smaller, the simulations would be more precise, without the high costs of complete testing. The cluster would have to consist of materials having more in common with each other than the remaining materials. Hence, identification of clusters would mean finding groups of data similar to each other, which on the same time showed differences to other groups of materials.

Zhao et al. (2015b) have described how to make the uncertainties of material properties more visible by defining generic material properties by probabilistic distributions. Clustering was used to define the generic material.

3.3.2 Method for clustering

To determine which clusters are relevant the material properties found in section 3.1.3 *Hygrothermal properties of brick, natural stone, plaster and mortar* are used. An obstacle in the analysis is that for some materials data were incomplete. The missing values makes it impossible to compute the distance between different materials. Hence, either specific materials with missing values need to be excluded from the data, or the missing data are to be imputed. In order not to waste information, it was decided to use a principal component based method for imputing the missing values (Josse & Husson, 2016). Prior to the imputations all material data were standardised (mean of all materials subtracted and divided by the standard deviation) as this is recommended for variables having different units.

A model-based approach was used for clustering, which means that several finite mixture models are fitted to the data. These mixture models was multivariate Gaussian distributions, where the covariance structure was allowed to vary as well as the number of mixture components (Fraley et al, 2002, 2012). The number of clusters and the underlying covariance structure was selected based on the Bayesian Information Criterion (BIC).

Given the identified clusters and their structure, the mean and covariance matrix for each cluster were estimated. These parameter estimates should be interpreted as the “best guess” of the underlying central material in that group and the variability around it, respectively.

3.3.3 Classification tree

Some of the material properties were less important than others in defining the clusters. In order to gain insight in to the material property importance, as well as being able to classify new materials according to the identified clusters, we trained a classification tree to the data (Breiman et al, 1984). These classification trees are constructed by partitioning the data into disjoint sets based on several subsequent splitting criteria. Hence, the deeper one goes into the tree, the more specific are the materials in the various branches. A majority vote among the materials ending up in the leafs of the tree are used to classify future observations based on its material properties.

At any split in the tree the distribution of the materials used to construct the tree is known. Hence, one can compute an expected value and variance by using the well-known expressions for conditional mean and variance calculations. That is, the mean is computed as a weighed mean over the estimated means for each cluster with the material distribution as weights. Similar arguments applies to the variance. In principle, the calculations must be repeated each time a new material is added.

3.3.4 Example of clustering

The method described above was used on the complete data set of bricks included in the DELPHIN database. **Figure 9** illustrates this tree.

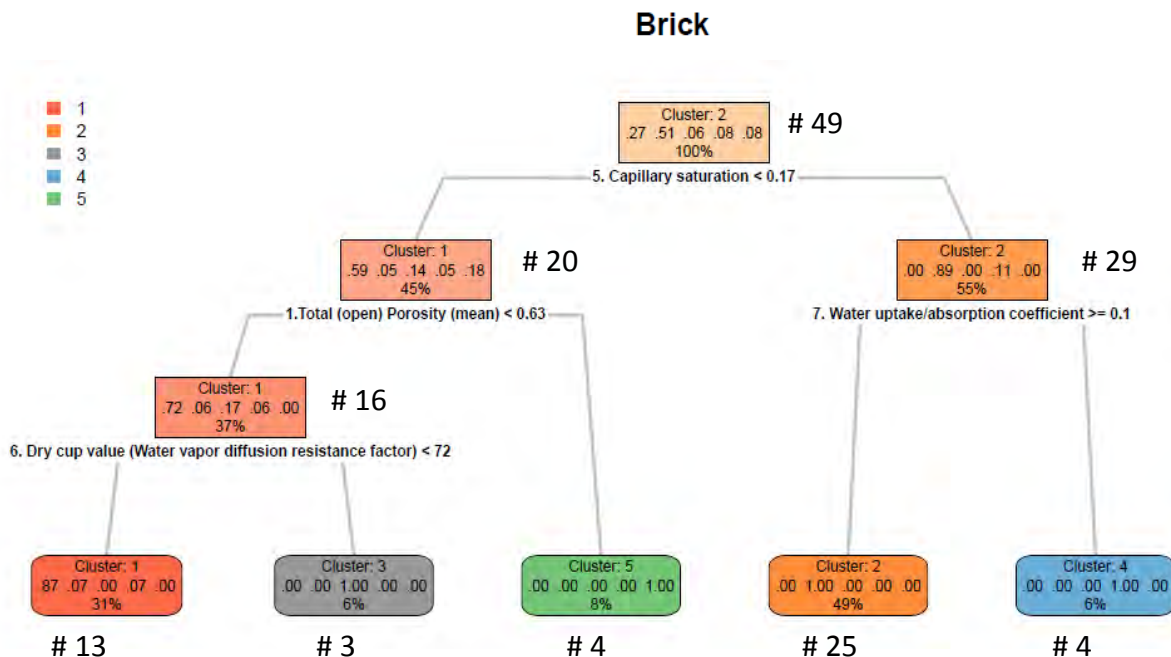

Figure 9. Training tree for clustering based on complete data set from the DELPHIN database. # marks the number of bricks in each cluster. The material properties shown are those who decides a split into more groups.

In addition to the bricks that defined the training tree 74 bricks from other sources, where the data set was not complete, were also placed in the cluster and missing values were imputed. From the 74 bricks, 17 were placed in cluster 1, 55 in cluster 2 and 2 in cluster 4. Apparently, there was a high risk of placing many bricks in the same cluster, consequently, either the bricks did not vary much from each other or the clusters were not narrow enough.

Zhao et al. (2015a) used a similar setup with 23 bricks and eight material properties and found different clusters depending on which clustering method he used. In this case the training tree was based on twelve material properties that all had the same weight. Nevertheless, some material properties may be more important than others when it comes to hygrothermal simulations. This clustering was based on input data only, but how the materials reaction to hygrothermal exposure is more important. Unfortunately, to determine which cluster a specific material with only a few known material properties – not yet being part of the database – belongs to, can only be based on input data, i.e. i.e. the few known properties. It is therefore necessary and more correct to base clustering on weighed material properties. To determine the most important properties, the impact of the different material properties on the output must be investigated. This is the subject of section 4 *Impact of material properties on hygrothermal behaviour*. Only then, the material properties can be used for clustering.

4 Impact of material properties on hygrothermal behaviour

4.1 Introduction

The aim of impact characterisation, as used in this report, is to map influence of material properties on the hygrothermal behaviour of solid external walls and hereby deducting the importance of each material property. The characterisation is made on material properties of bricks; similar characterisation can be made on other building materials. Bricks were chosen as they are the most common material in external walls of historic buildings (Blumberga et al, 2015).

Determination of hygrothermal behaviour of bricks involves many material properties, thereby involving many tests. Identifying the most decisive properties could reduce the number of tests and would make it easier to determine hygrothermally alike bricks. This is often done by a sensitivity analysis; one would simulate the same situations with stochastic variations of one variable at a time e.g. through Monte Carlo simulations. This is not appropriate here as bricks are described by several properties, some of which are correlated. Random combinations of properties could therefore mean simulation with unrealistic bricks.

Instead, a modified sensitivity analysis based on a portfolio of hygrothermal simulation models have been created, calculated and analysed. In these models the only variation is the brick e.g. the total set of material parameters for the brick is different in each model. In addition, four different variations of each model are created to evaluate the robustness of the findings. With the current variation and models, the portfolio includes 176 simulation models. The hygrothermal models have been created for and simulated with the software DELPHIN ver. 5.8.

As described in section 0 *Example of clustering* a statistical analysis of 49 different German bricks all characterised by twelve hygrothermal material properties led to a clustering of the bricks into five clusters. The five clusters emerged due to four statistically determined sorting mechanisms, shown in **Figure 9**, of the material properties, which distinguished each of the cluster from the others.

In Section 4, these five clusters will be referred to as Input clusters. The new setup – the modified sensitivity analysis introduced above – will not be based on the twelve parameters explicitly but take another approach. This approach will be evaluated with new clustering which will be referred to as Output clustering and Output clusters. Output clusters will finally allow another statically analysis including the twelve material parameters.

4.2 Setup

To deliver the wanted simulations two scripts in Python have been written: one, which match appropriate bricks, create project files for all bricks and prepare simulation, and another which import the results and do post-processing. The simulations themselves are executed as a sequence of commands in a batch file and the 176 simulations is outcome of two separate sequences run with Intel® Core™ i7 Processor computers in about 20 hours.

4.2.1 Brick data

The preparation of the simulation consists of implementation of specific bricks in models and descriptive naming; keeping them traceable throughout this and a preceding study. This was achieved by using the catalogue of bricks that was used for the Input clustering described in section 3.3.3 *Classification tree*.

The catalogue does not include material characterisation of same detail as in the DELPHIN material database, where material functions have been calibrated (see section 2.2.1.3 *Material parameters in DELPHIN*). Best possible modelling should rely on material files within the tool. However, the catalogue materials also exist in the database and therefore a material from the catalogue can be matched with a material file in the database. Only one material was not found among the 732 materials searched in the database; brick number 38 corresponding to study 037, a study which is therefore not created thus a void exist in the output. The simulations with the remaining bricks have been made with the calibrated material functions in the DELPHIN database.

4.2.2 The model

4.2.2.1 Background

The applied models are inspired by a preceding sensitivity analysis setup which provided a wide focus on model inputs such as geometry, materials, orientation and boundary conditions and thus a wide range of parameters which were varied stochastically or discrete to represent all parameters' effect on the results. Four variations of the models are chosen out of the 1008 simulations in the framework, number in brackets refer to the specific variation number, the numbers are mainly relevant as a distinction between the four variations and their outputs:

- the (expected) representative reference boundary conditions (092)
 - one and a half brick wall + no insulation (092-0xx)
 - one and a half brick wall + 50 mm calcium silicate insulation (092-4xx)
- the (expected) stressing boundary condition - higher precipitation catch ratio, lower absorption coefficient (short wave radiation) thereby reducing the drying potential of the wall (140)
 - one and a half brick wall + no insulation (140-0xx)
 - one and a half brick wall + 50 mm calcium silicate insulation (140-4xx)

The variations are selected as representative as possible, nevertheless, it is only a selection of two wall constructions and two boundary conditions.

The simulations with stressing conditions will act as comparable results to see if a conclusion appear durable and to show a possible variation. However, the variations with stressed conditions will not be presented parallel to the representative variations, as it will quickly become confusing to deal with four models.

4.2.2.2 Input

The geometry of the walls were as follows with layers listed from the outside of the wall and inwards:

Not insulated (-0xx):

- Homogenous historic brick 0.35 m
- Historic mortar 0.01 m

Insulated (-4xx):

- Homogenous historic brick 0.35 m
- Glue mortar (Calcium Silicate) 0.004 m
- Calcium Silicate insulation 0.05 m
- Historic mortar 0.01 m

Figure 10 shows a visualization of the construction.

The two stressed models (140-xxx) and the two reference models (092-xxx) differ in precipitation catch ratio and absorption as indicated above but due the underlying sensitivity analysis also in start year of the simulations, see **Table 6**. In addition, the location of the two main models differ slightly as they are situated in two different Danish locations where the weather differs.

Table 6. Two input parameter samples from a complete sample scheme. Here with same brick, thickness, orientation and humidity class. The orientation correspond to SW and start year is number of years into the available thirty-year weather data period. The unnecessary amount of digits origin from a technicality in the sampling scheme's implementation of stochastic variables and can be disregarded.

sample_number	material_brick	thickness_brick	climate	h_conv_slope	max_catch_ratio	absorption	orie	start_year	class
92	Brick1 - 45	0.346878	Kobenhavn	4.64583	0.28125	0.7417	248	4	2
140	Brick1 - 45	0.346878	Sminge	7.5625	0.84375	0.4583	248	24	2

4.2.2.3 Output

The results presented in 4.3 *Findings* follow from a specification of outputs within the simulation program. It will briefly be described where outputs have been assigned (DELPHIN terminology). **Figure 10** shows two different constructions; one without and one with insulation, corresponding to the -0xx/4xx distinction in section 4.2.2.1.

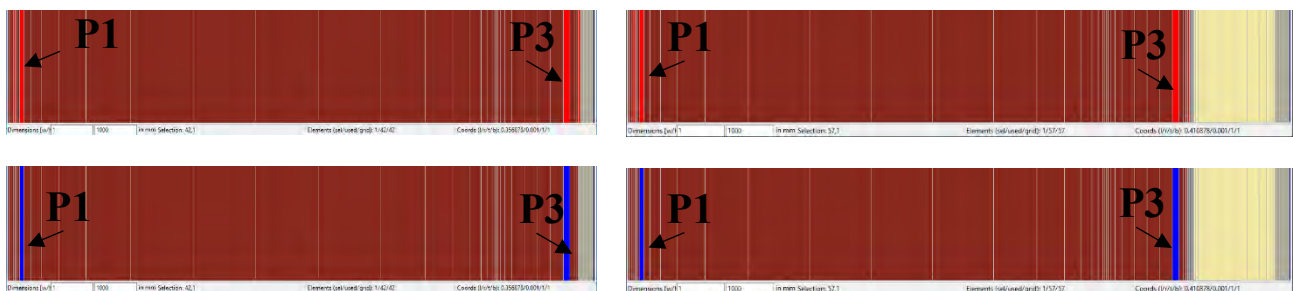

Figure 10. DELPHIN models' Construction/Discretisation detail. Not insulated wall (left) and insulated wall (right), in both cases outside to the left. Top row: Elements assigned temperature and relative humidity outputs (red), in addition, a fifth output exist for the internal surface element. Bottom row: Elements assigned moisture content output (blue). Elements assigned both with red and blue labels are referred to as P1 (near exterior surface; left) and P3 (near brick-plaster interface; right).

The separation (discretisation) of the brick into calculable elements shown in **Figure 10** is derived from preliminary calculations for comparison, this is not changed.

The blue element at the left in **Figure 10** is 2.6 mm thick and is located 7.6 - 10.2 mm inside the brick material. The output will be the mean value of this span. In the right the blue element is 4.1 mm thick and located 5.2 – 9.3 mm inside the wall (from interior side).

4.2.3 Weather data

Regional exhaustive weather forecasts (hourly data) with three different thirty year periods (1960 – 1990, 2020 – 2050 and 2070 – 2100) were created in the EU project ‘Climate for culture’ (www.climateforculture.eu) (Jacob & Kotova, 2013). Weather forecasts from the period 2020 – 2050 were used in the present models. The weather data were accessible in appropriate format for the DELPHIN. All simulations have run for six years after a proposed initiation period of four months. As a parameter the start year have been varied within the above period, the latest start being in September 2043.

Internal climate correspond to humidity class (B) in the standard EN 15026 (2007). Indoor temperature varies between 20 °C and 25 °C dependent on the outside temperature.

4.2.4 Data framework

Data treatment in the current study is based on 264 imported result files. This is based on 44 bricks in two reference variations, equivalent to 88 project files, each simulation produce three files per simulation (temperature, relative humidity and moisture content). This treatment is completed twice for two different location and parameter settings illustrated in **Table 6**. All visualisations and handling of the data is carried out in Jupyter Notebooks an interface with an underlying Python 3.6 compiler.

Moisture is assumed to be the most critical failure mode and temperature influences the relative humidity. Therefore, moisture content is considered to be the most absolute value among the three outputs and used as the decisive finding in the current methodology.

4.3 Findings

The basis for the findings is outputs on moisture content at the specific points shown in **Figure 10**, in most cases the moisture content has not been used directly as it is given as curves over time. Instead of comparing curves directly, the curves have been generalised to simple values based on the area under the curve, denoted as sum of moisture content, these values have been compared and used for ranking the bricks where the bricks with the highest sum of moisture content is ranked the highest. Another method for ranking has been to use the median of the moisture content within a given period.

The current study is a test of several possible analyses of the results and therefore a methodological development within the field of simplified material characterisation, simplified because of more generalisation in comparison with the level of detail found in material files. Before the findings are described in detail, the following bullet list gives an overview of different learnings made. These

have led the methodology to the current development and are findings supporting the methodology and the conclusion that follow.

- Input and output clusters are not alike
- Sum and median approaches find similar clustering
- The most robust results are obtained at relatively wet conditions in the bricks i.e. in the winter.
- Brick ranking is similar for insulated and not insulated walls
- Brick ranking is dependent on the position in the wall (outside or inside, cf. **Figure 10**)

Before elaborating on the details of the findings above and the foundation for these, the many simulation results are briefly presented.

4.3.1 Analysis of temperature and relative humidity output

The hygrothermal models in this section require a considerable amount of inputs, e.g. the group of boundary conditions with some variation on coefficients, and some automation e.g. changing the brick are implemented. It could be relevant to present and explain the current input, to reduce the amount of possible errors and to improve the insight into the wall behaviour seen in the results. On the other hand, because of the comprehensive inputs it would be very exhaustive to present these and is outside the current scope. Therefore, the simulations themselves are preserved as black boxes, understood as focusing on their outputs and inspection of these, not the preceding steps.

All the hygrothermal simulation results are available for the data analysis and visualization but due to the sampling size only summary statistics and visualizations are presented. Additional details can be found in 0 (appendix). Each output is referred in the following way: Relative humidity as RH, moisture content as MC and temperature as T.

As a general overview the simulation result of a not insulated wall with brick no. 10 is visualised in **Figure 11**. It is a representative brick setup, in means of average temperature and relative humidity for the entire output period (six year). The wall's mean temperature is 10.8 °C while the general mean temperature of all bricks is 10.7 °C with a standard deviation of 0.16 °C. Mean relative humidity is 82.6 % RH, while the general mean is 82.6 % RH as well with a standard deviation of 2.5 %.

In **Figure 11** six years of daily mean temperature (green curves) and daily mean relative humidity (red curves) is shown for a 'sensor' near the exterior surface. Early January 2024 has the lowest daily mean temperature of minus 10 °C while an extraordinary temperature of almost 30 °C is reached during the summer 2028. Within the six years shown in **Figure 11** the highest and lowest monthly mean temperature is ~ 21 °C and ~ 2 °C. Average monthly mean temperature over a ten year period (decadal means for 2001-2010) is highest in July (17.4 °C) and lowest in February (1.2 °C) (Danish Meteorological Institute, u.å.). Daily mean temperatures fluctuates similar to normal Danish climate, yet with more extreme values. Arguably because of:

- Climate change included in the 'climate for culture' weather data.

- Heating by short wave radiation in the summer
- Radiative cooling (long wave to a low sky temperature) in the winter

Relative humidity varies in a similar way (red curves in **Figure 10**).

In **Figure 11** a two-year period is marked in blue, the period is representative for the entire time span. The two-year period shows the following daily mean temperature extremes:

- a cold winter – minus 5 °C followed by
- a hot summer – 25 °C →
- a mild winter – 0 °C →
- a mild summer – 21 °C

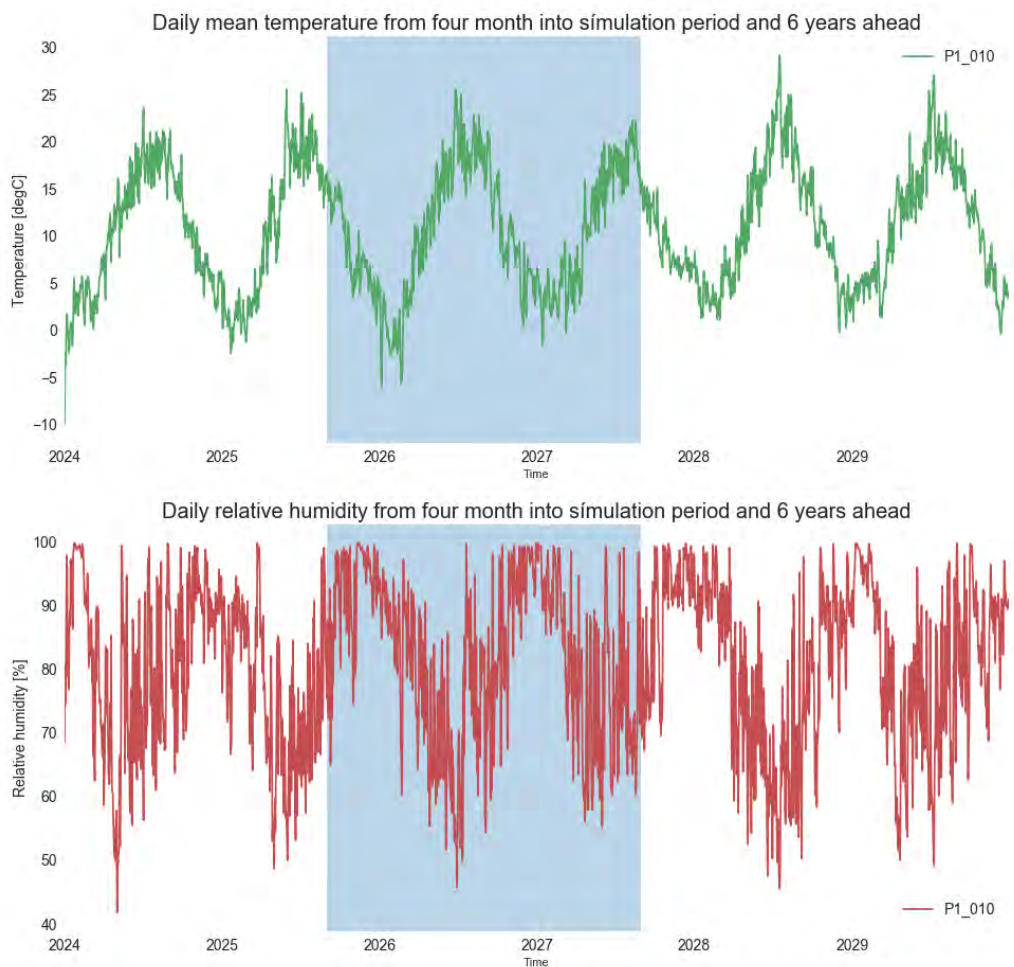

Figure 11 Daily mean temperature (top) and relative humidity (bottom) within a not insulated brick wall close to the exterior surface based on hourly results from simulations using a representative brick. The blue background indicates the time span used in Figure 12 where curves of moisture content in several bricks are shown.

4.3.2 Analysis of moisture content output

The mean moisture content for the two-year period (shown in blue in **Figure 11**) for a wall with brick 10 is of 5.9 kg/m^3 while the general mean is 12.4 kg/m^3 with a standard deviation of 7.8 kg/m^3 . This indicates that results for moisture content vary more than for temperature and relative humidity. To visualise the variation in results the moisture content in several bricks (brick 10, 12, 13, 41) are shown in **Figure 12**. The four bricks have been chosen from the 44 available bricks, as the output from these are visually representative for the whole group.

Figure 12 shows a large variation in both values and profiles of moisture content for the two-year period. The selection makes some general characterisation of the output possible. The following ‘characters’ can be identified in the profiles, notice that this is based on long term values (weekly mean moisture contents):

1. Reaction to available water ranging from low to high magnitude and acceleration
2. Effect of drying conditions ranging from low to high
3. Steady state condition level, characterised by its offset from zero moisture content

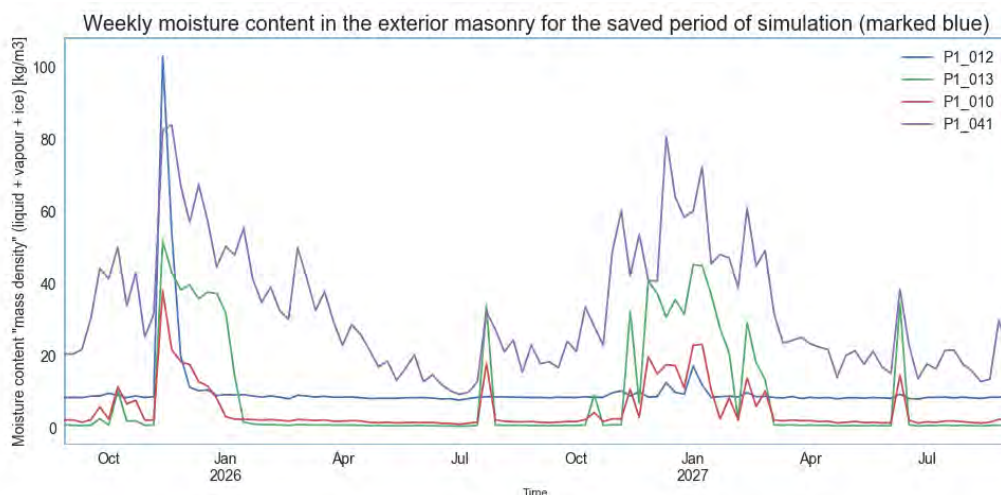

Figure 12 Weekly mean moisture content for not insulated walls made of brick 10, 12, 13 and 41.

Figure 11 indicates that it is difficult to find an automated and appropriate method to evaluate the different bricks used in the simulated wall. It might be clear that the upper graph (brick 41) is the highest ranking while it is more troublesome to ‘rank’ blue and green (brick 12 and 13). Currently no evaluation of the profile ‘characters’ listed above is implemented. As an alternative less demanding sum and median functions are used.

Figure 13 shows the three different output measure means (moisture content, relative humidity and temperature) for each brick sample of not insulated and insulated walls respectively. The time span is the same as marked blue in **Figure 11** and shown in **Figure 12**. The general observation is that in the brick near the exterior surface and near the internal surface, adding internal insulation increases the moisture content and the relative humidity, while the temperature decreases. This observation is consistent with common knowledge in the field.

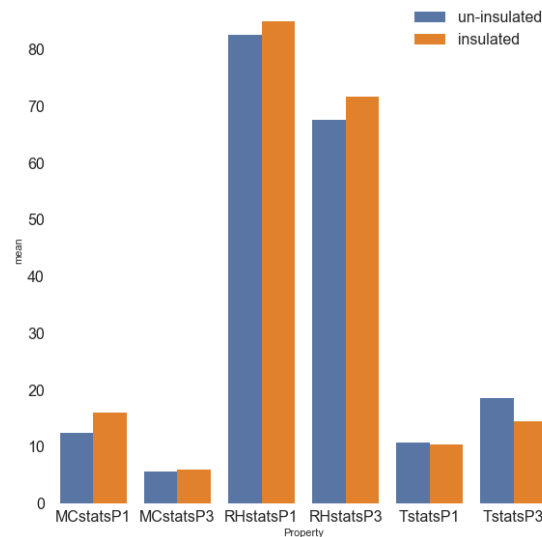

Figure 13 Insulated compared with not insulated wall on the three output measure means (moisture content, relative humidity and temperature). Near exterior (P1) and near brick-plaster interface (P3).

During simulation and after an initial period, temperature and relative humidity values are written to an output file on an hourly basis for a six-year period while moisture content values are kept on a daily basis for a two-year period. It is assumed that the inertia of the system is large and therefore changes slowly; this is especially appropriate for the centre of the wall. Therefore, daily values is chosen for moisture content instead of hourly values. In addition, the post processing has not required insights into daily fluctuations in the moisture content but rather the weekly or seasonal variations. In practice, the available output (of a continuous simulation) is written to a file every 1.25 day (simulated days). The one quarter of a day (1.25 days) is an additional six-hour offset to ensure that daily trends - e.g. lower moisture content in the evening than in the morning, does not bias the mean moisture content.

Results cover the following periods:

- Temperature and relative humidity: Simulation for Jan. 2024 to Dec. 2029, initiated in Sep. 2023.
- Moisture content: Sep. 2025 to Aug. 2027

The duration of the moisture content output is set to two years and cover from autumn to autumn in order to cover two different winters.

In each of the simulated models the moisture contents [kg/m^3] are saved from two different depths; one close to the exterior and one near the brick-plaster interface (seen in Figure 10).

Figure 14 shows moisture content for all bricks near exterior and close to the brick-plaster interface in both not insulated and insulated walls for a limited time span. The input clusters identified in section 0 *Example of clustering* are reused; bricks in the same input cluster are shown with the same colour. In general, profiles from input cluster 1 (orange) and 4 (black) are different, but many blue and orange lines cross each other often. The picture is the same whether the wall is insulated or not, although the fluctuations near the interior is smaller in the insulated wall. Consequently, it is difficult to distinguish these input clusters from each other when the output (moisture content) is considered. This phenomenon is discussed in Section 4.3.3.

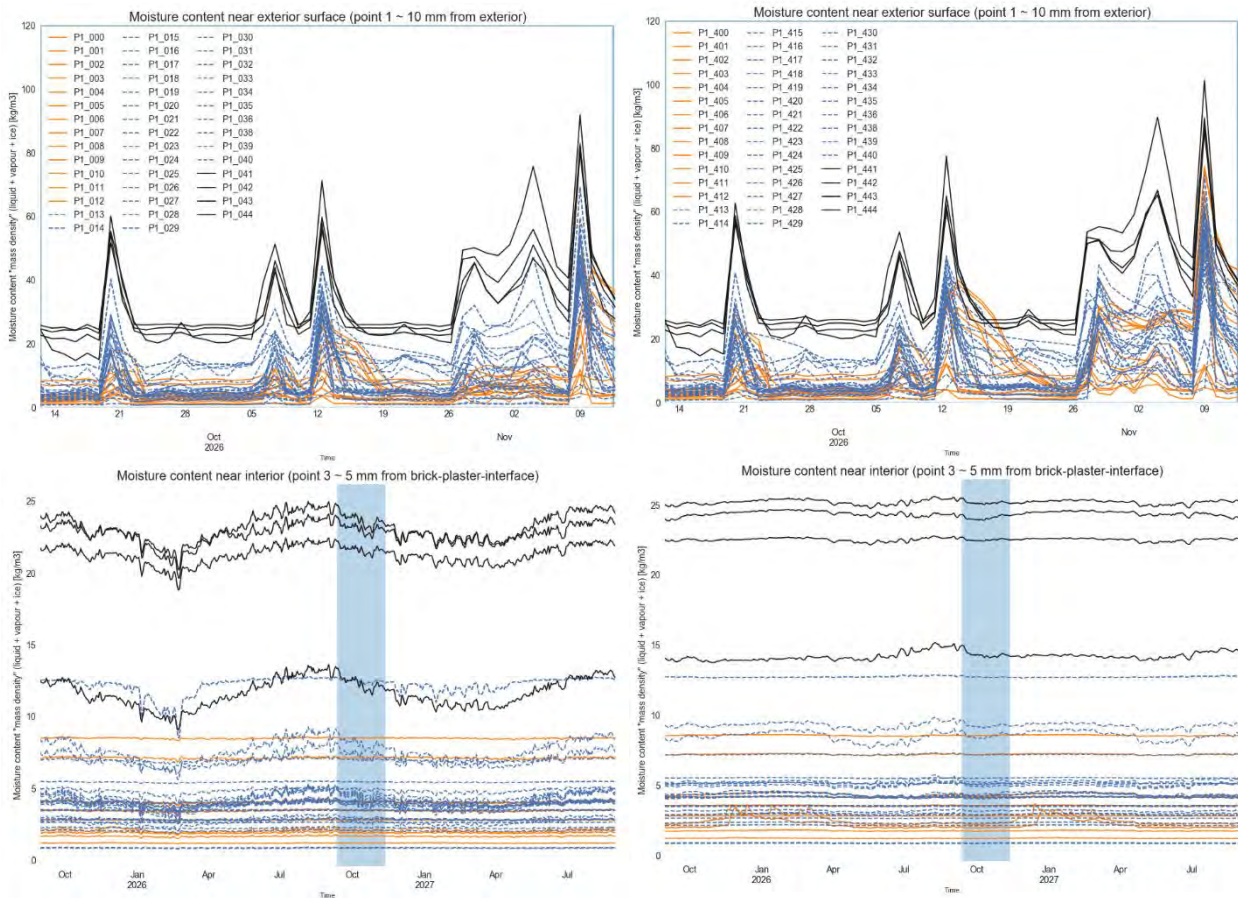

Figure 14 Moisture content details of the masonry wall near exterior surface (top row) and near brick-plaster interface (bottom row) in not-insulated walls (left) and insulated walls (right). Time span in top row correspond to marked area in bottom row. Lines can only be distinguished on cluster level: Input cluster 1 is orange, Input cluster 2 and 3 are dashed blue and Input cluster 4 is black. Numbering of input clusters refers to Figure 9.

4.3.3 Clustering

4.3.3.1 Identification of output clusters based on moisture content

In **Figure 14** it was possible to conclude that not all Input clusters could be clearly separated. Therefore, Input clusters must be different from Output clusters.

So far, the curves have been compared visually, however, for a more systematic comparison, different means must be used. Assuming that the different bricks can be evaluated based on the area under the moisture content vs time curve, described as their summed moisture content over a given time span e.g. a winter, a ranking method among the bricks will emerge. Preliminary investigations show like in **Figure 16**, that the winter period results close to the brick walls' exterior have the highest sum in comparison with measurements near the brick-plaster interface in general.

Figure 15 shows two different ranking methods; Ranking by sum of moisture content across the winter (Dec 1. to March 1.) and ranking by moisture content median in the same winter. The top seven bricks measured by sum are also marked in the ranking by median. The two different ranking

methods show good alignment although only the six highest rankings are the same in the two methods. The seventh (by sum method) - brick 003 is ranked two levels lower when ranked according to moisture content median while brick 015 and brick 038 rank higher. This is indicated by respectively orange and blue rectangles in **Figure 15** where also brick 015 and brick 038 are marked for the sum method (in the left).

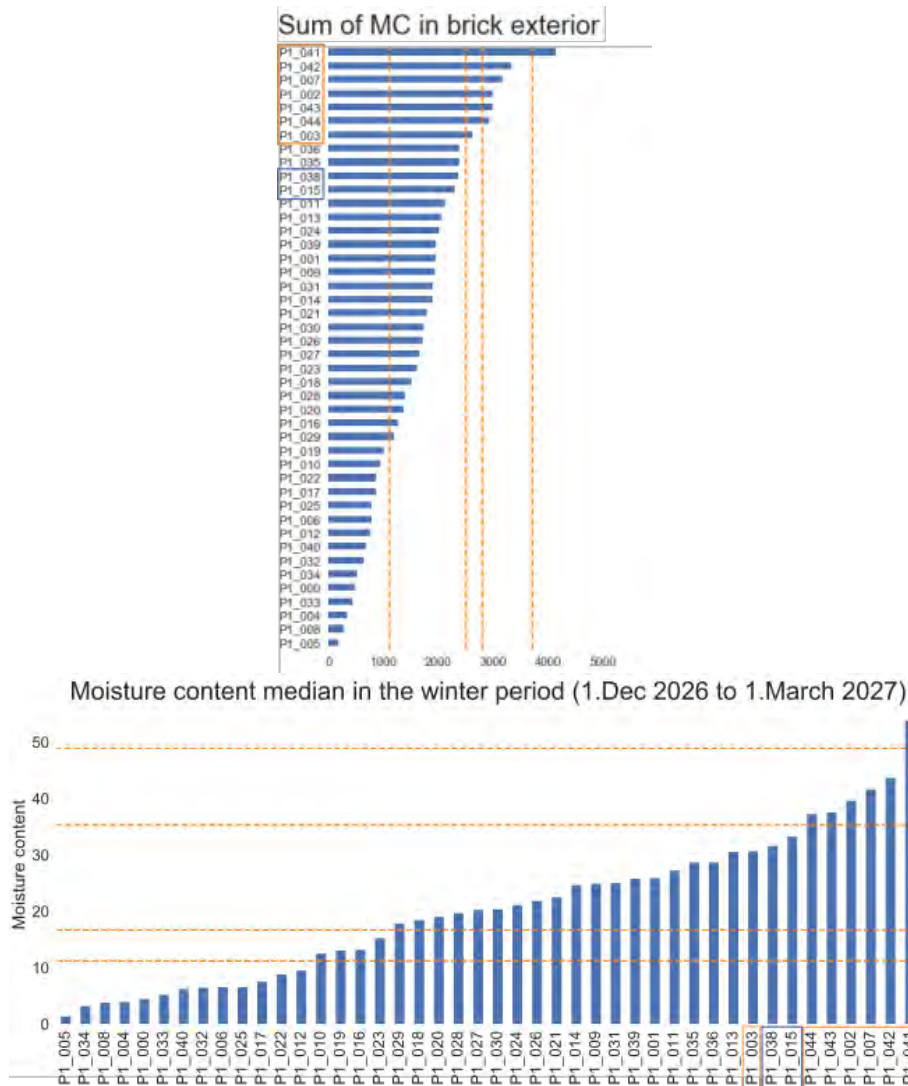

Figure 15 Ranking of moisture content during the winter 2026-2027 based on moisture content sum (top) and moisture content median (bottom). Orange rectangles around brick references show the seven highest sums while blue rectangles show the bricks that mix with the seven when ranked according to median. The dashed lines indicate approximately the middle of the four biggest differences within the ranked sum diagram or the ranked medians diagram.

Choosing between the sum method and the median method is based on which bias the methods introduce. A theoretical bias of the sums towards extreme values is beneficial as these extremes are assumably the most problematic. On the other hand, the median method is more representative of common conditions, which may also be valuable. Nevertheless, extreme conditions are probably most important when it comes to failure modes.

Consequently, the sum method is used and output clusters are identified based on where the biggest changes are in the moisture content sum. In **Figure 15** four dashed lines mark the biggest changes, the amount of lines are a combination of how many big differences there are and a reasonable number of bricks in the cluster with the highest sums, e.g. 5 to 8 bricks in a cluster.

The robustness of the ranking by sum is further analysed in Section 4.3.3.2.

4.3.3.2 Robustness of output clusters

In the left bar chart of **Figure 16** the moisture content sum ranking of bricks in the insulated wall is compared with the not insulated wall. The seven highest-ranking bricks at the exterior in the not insulated case (indicated by orange rectangles) are with one exception (brick 014) the same in the insulated case.

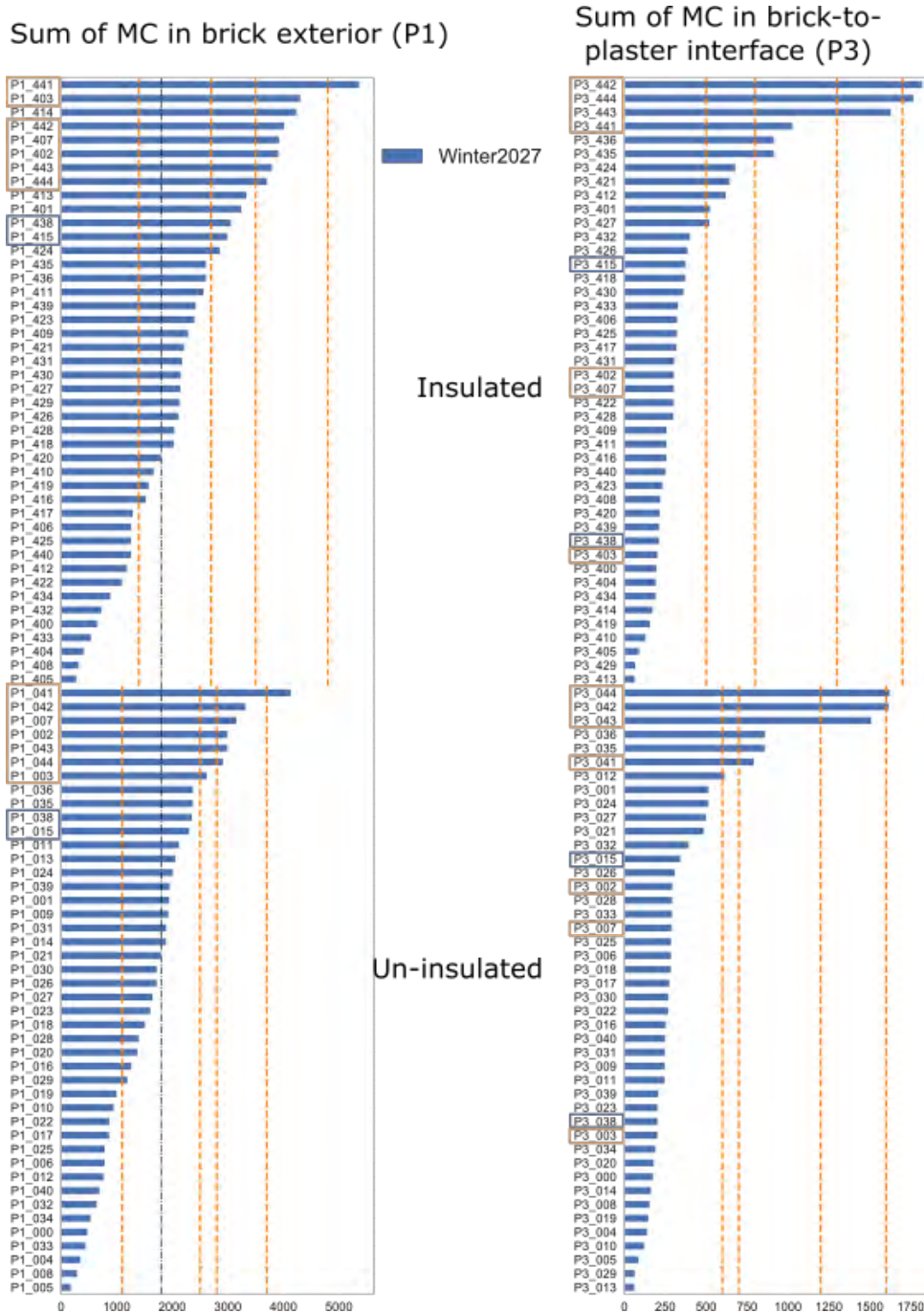

Figure 16 Moisture content sums near exterior (left) and near brick-plaster interface (right) for the insulated (top) and not insulated walls (bottom). Orange rectangles track the seven highest-ranking bricks based on ranking at the exterior in the not insulated wall (lower left bar chart), corresponding to the right bar chart in Figure 15. Blue rectangles track bricks that ranked as seventh and eighth brick in right bar chart in Figure 15 herby comparing robustness of the two ranking methods.

Also the sum of moisture content near the brick-plaster interface have been considered as shown in the bar charts at right in **Figure 16**. Orange and blue rectangles show how bricks with high ranking at the exterior (left bar charts) are ranked at the brick-plaster interface (right bar charts), with a significant different result. Only three to four high-ranking bricks at the exterior stay as candidates to a ‘top’ cluster while the rest leave their top position and move to the middle or lower. Note that maximum sum values at the brick-plaster interface is less than half of the sums reached near

exterior; see scales at the bottom of **Figure 16**, dark dashed vertical line in left bar charts (exterior) marks the maximum moisture content sum at right bar charts (internal brick-plaster interface).

Clusters based on an element close to the brick-plaster interface where the moisture content sum is low and the season variations small (see **Figure 14**), would differ from clusters based on an element close to the exterior surface. Therefore, it is not clear which brick will be the most at risk of failure; it depends on where the failure may occur and therefore the failure mode, as e.g. freeze-thaw is most likely as failure mode at the exterior while mould growth is most likely as failure mode at the interior.

For the current cluster definition ranking of moisture content outputs near the exterior are used and the result is in this way restricted by only considering sum of moisture content and specific depth of output.

4.3.4 Impact characterisation

In Section 1.2 it was assumed that some material parameters can be characterised as more influential than others and thereby should be weighed before clustering based on material properties (Inputs) can be made. Such weighting can be based on a very direct sensitivity analysis:

1. variation of a specific parameter while the effect on simulation outputs are evaluated in relation to that variation.

However, as no parameter is independent of other parameters, it can instead be reversed:

2. a relatively little output range (a cluster) where it is evaluated how bricks with high sum of moisture content differ from the rest of the bricks. E.g. if the bricks in the upper cluster have a considerably low variation in certain properties compared with the total sample of bricks, these properties are likely to have a big impact.

A prerequisite for method 2 is that high moisture content in bricks is important when evaluating the robustness of internal insulation systems. **Figure 17** shows an implementation of method 2.

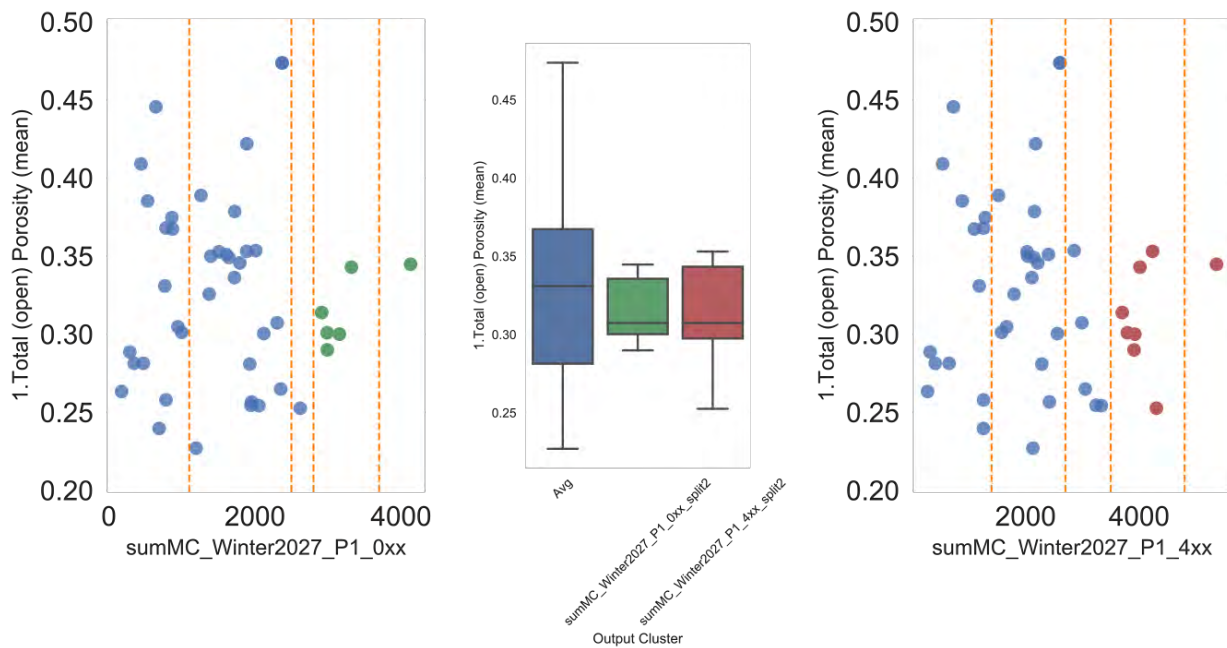

Figure 17. Total (open) porosity vs. sum of moisture content for the representative winter of 2027 (Scatter plots) near exterior surface in the not insulated wall (left) and the insulated wall (right) and Box plots (middle) showing the spread among all bricks (blue) and within two clusters (green and red). The Box plot is un-modified - as the whiskers cover entire spread. Orange dashed lines indicate the four biggest differences in the moisture content sum values (in absolute terms) used for various clustering, referring to left bar charts in Figure 16.

The basis for **Figure 17** is the clusters of bricks with the highest sum of moisture content identified in **Figure 16** for not insulated and insulated walls respectively (left bar charts). The example in **Figure 17** shows Scatter plots and Box plots of ‘total open porosity’. Box plots show the variation of a material property within the defined clusters, marked red and green, compared to the variation of the material property in the whole sample (boxes mark 25 and 75 % quantiles). In addition, Scatter plots show the porosity as a function of the sum of moisture content, conveying the reasonableness of the cluster definition given by the dashed lines from Figure 16. Scatter plots also give insights into details which bricks were left out by the Box plot.

The Box plot in the centre of Figure 17 shows the total (open) porosity for all bricks being between 22 % and 48 % thus 0.26 wide, while the range for the not insulated wall (green cluster) is 29 - 34 %, thus 0.05 wide and significant smaller. For the insulated wall (red cluster) porosity range from 25 % to 35 % thus 0.10 wide and still significant smaller than for all bricks.

For an easy overview, Figure 18 and Figure 20 show Box plots for eight of the twelve material parameters, as these are the most interesting. In parallel, Figure 19 and Figure 21 show the respective Scatter plots for the ‘green’ cluster alone.

In the orange rectangles seen in Figure 18 and Figure 20 mark the seemingly most important material parameter. Importance is understood as highest influence on output (moisture content sum). From the first Scatter plot of **Figure 19** it can be seen that including just one more brick e.g. second dashed line instead of third would enlarge the variation in the green Box plot (of first plot in **Figure 18**) for it to become very similar to the red Box plot for the same parameter.

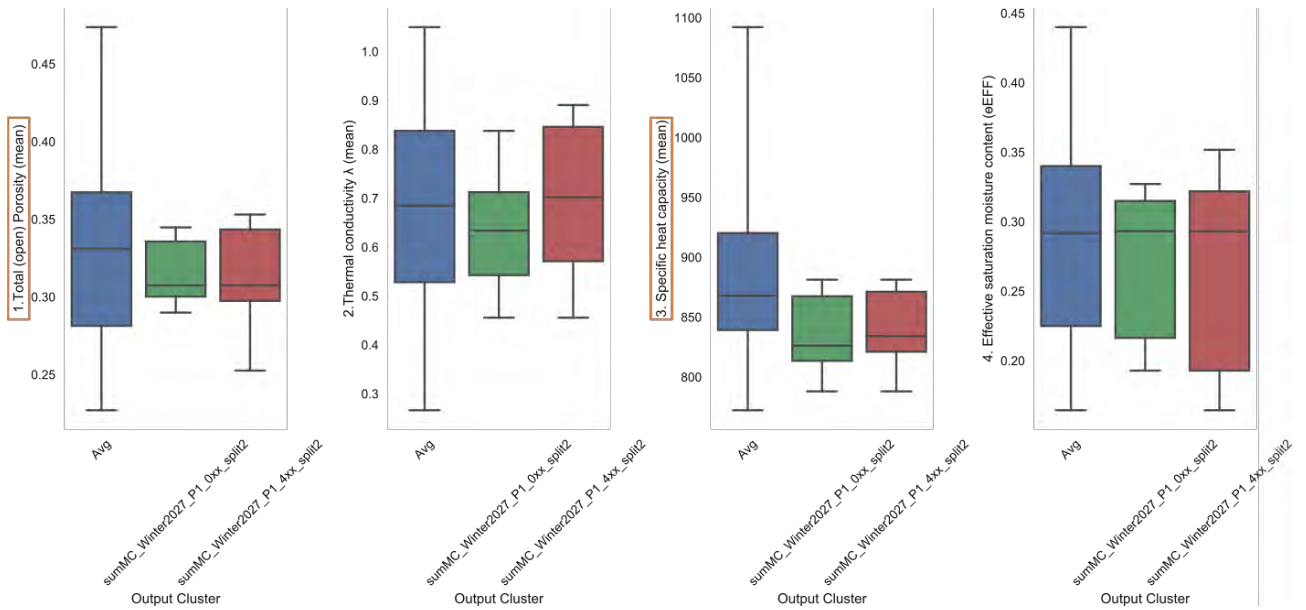

Figure 18 Variation of open porosity, thermal conductivity, specific heat capacity and effective saturation moisture content within two different cluster compositions compared to the variation seen in all the bricks. Box plots are un-modified - as the whiskers cover entire spread.

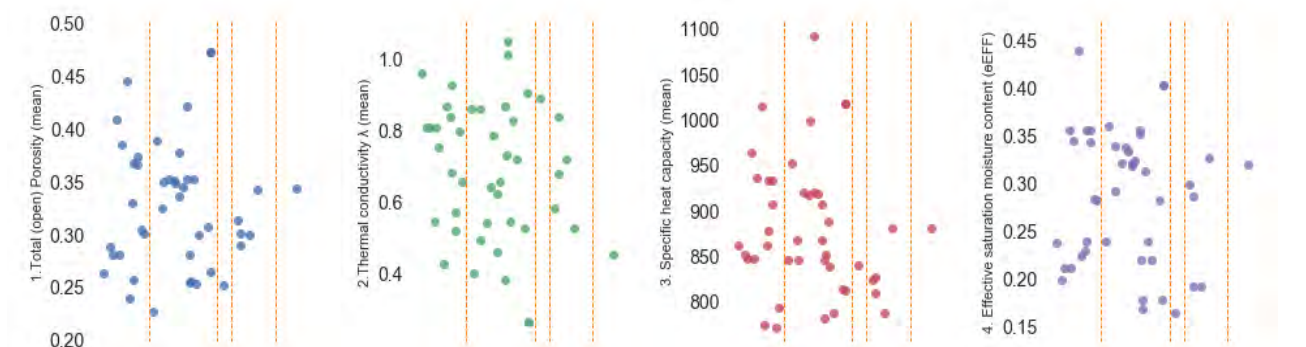

Figure 19 Scatter plots of the variation of the same material properties as in Figure 18, ranked by moisture content winter 2027, near exterior on a not insulated wall. Dots above second highest dashed line are included in the green Box plot (cluster) found in Figure 18. Colours does not relate.

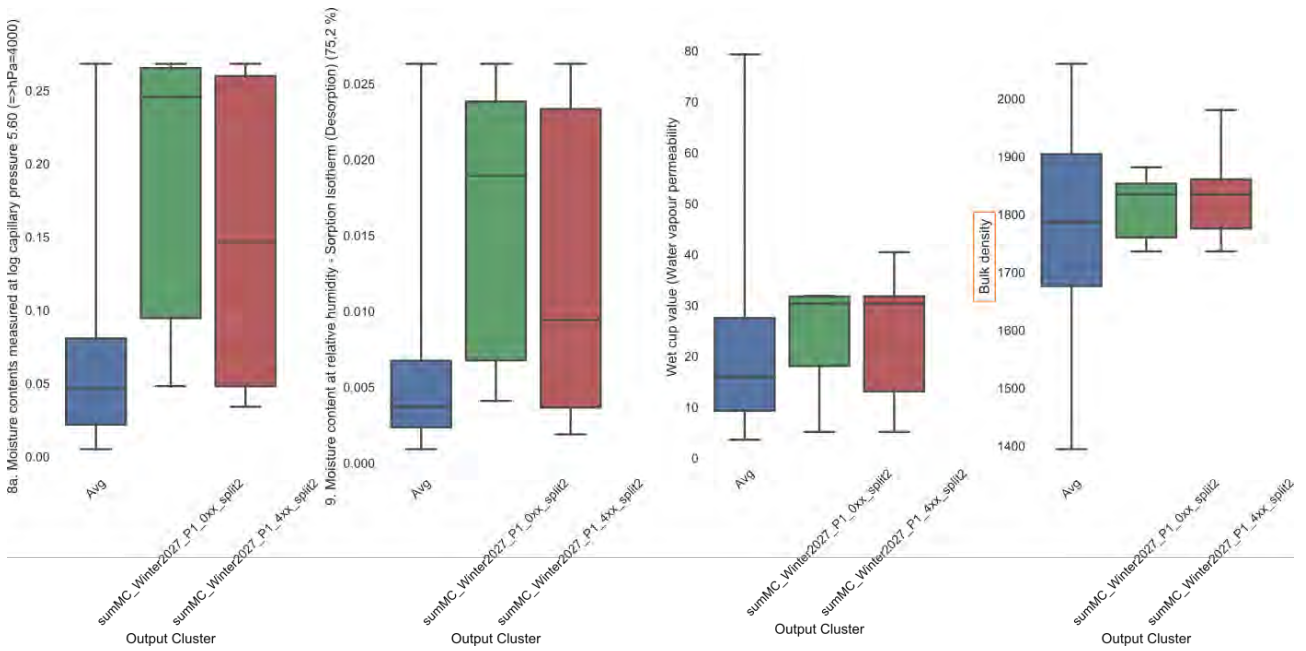

Figure 20. Variation of moisture content (log capillary pressure 5.60 and 75.2 % RH), wet cup value and bulk density within two different cluster compositions compared to the variation seen in all the bricks. Box plots are un-modified - as the whiskers cover entire spread.

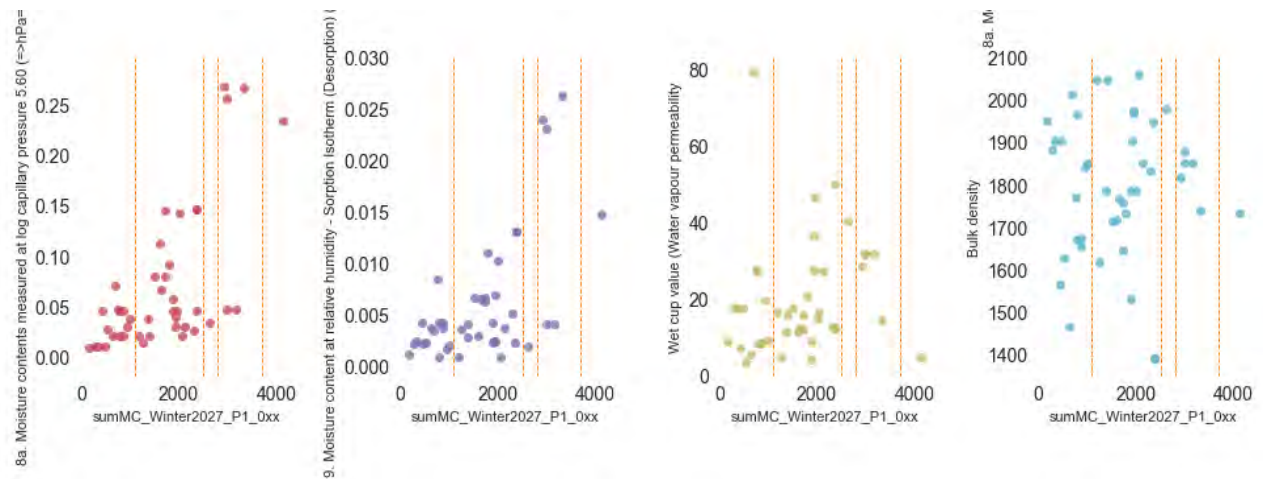

Figure 21. Scatter plots of the variation of the same material properties as in Figure 20, ranked by moisture content winter 2027, near exterior on a not insulated wall. Dots above second highest dashed line are included in the green Box plot (cluster) found in Figure 20. Colours does not relate.

Based on this analysis the most decisive properties are:

- Total open porosity
- Specific heat capacity
- Bulk density

4.3.5 Stress test

To test the robustness of the clustering a different set of simulations were performed. As described in section 4.2.2 the second model involves a more rough outdoor climate with a higher precipitation catch ratio and a lower absorption coefficient (short wave radiation) thereby lowering the drying potential. This should be understood as a hygrothermal model where the stochastic parameters represent more extreme conditions. In combination, the parameters can be described as ‘stressful’ why it is referred to as a stress test and a higher general moisture content of the wall can be expected.

Figure 22 shows the moisture content close to the exterior surface (upper graphs) and at the brick-plaster interface (lower graphs) considered for two winters (2045-2046 and 2046-2047). By comparing the upper graphs of **Figure 22** with **Figure 14** it is seen that the ranking between bricks become more diverse. The bricks represented by the black Input cluster are still close together, but now blue graphs and especially orange graphs mix with the black.

The behaviour of the element close to the brick-plaster interface is shown in the lower graphs in **Figure 22** and **Figure 14**. Here the picture in **Figure 22** deviates from the one in **Figure 14**; during the rough winter 2045-2046 a quite stable moisture content level in **Figure 22** suddenly increase with a factor of $2\frac{1}{2}$ for the not insulated wall and $3\frac{1}{2}$ for the insulated wall.

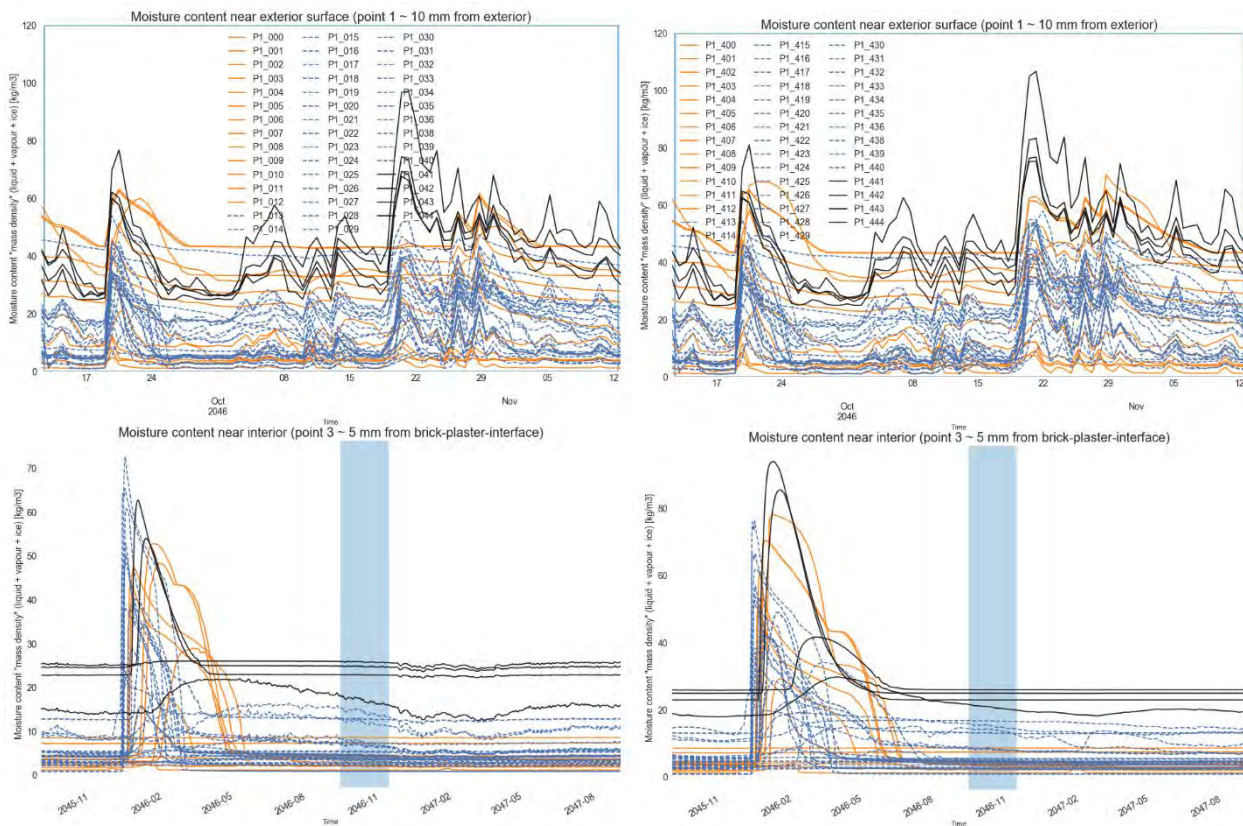

Figure 22 Moisture content details of the masonry wall near exterior (upper graphs) and near the brick-plaster interface (lower graphs) in not insulated walls (left) and insulated walls (right). Time duration in upper graphs correspond to area marked in lower graphs. Lines can only be distinguished on cluster level: Input cluster 1 is orange, Input cluster 2 and 3 are dashed blue and Input cluster 4 is black. Numbering of input clusters refers to Figure 9.

The period of time when the big increase in the moisture content occurs is in the winter 2045-2046. **Figure 23** shows two rankings of the bricks based on moisture content median calculated for the two winters 2045-2046 with big increase and 2046-2047 with uniform moisture content.

When comparing ranking and the following clustering based on these two winters with the same method and walls, we find two different results. In Figure 23 the six highest ranking bricks are 'clustered' for the winter 2045-2046, neglecting that two of the included bricks return much higher medians. The included bricks are marked with orange rectangles for both winters. Both brick 12 and 24 change ranking; placing both outside meaning full clustering for the winter 2046-2047. High-ranking bricks outside the cluster keep a more stable position e.g. 07, 02, 44, 43.

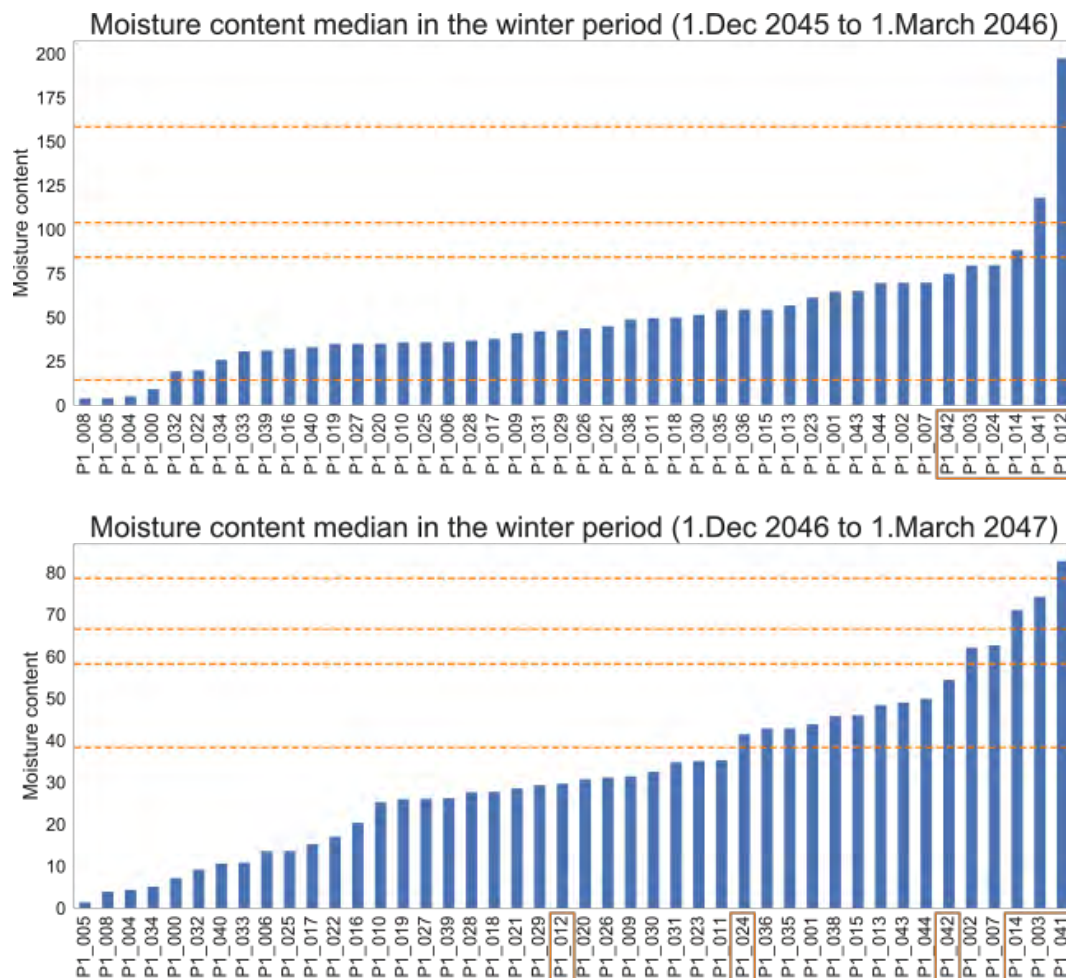

Figure 23 Median for moisture content near exterior during two winters of the stress simulation output. Orange rectangles track the highest-ranking bricks in the winter 2045-2046 into the winter 2046-2047.

In comparison with the output cluster consisting of the six bricks with the highest moisture content found in the not stressed model (winter 2026-2027), which contained brick 41, 42, 07, 02, 43, 44 (see **Figure 15**), the output cluster based on the stressed model is almost completely changed as only brick 41 and brick 42 remain. This show that changes in boundary conditions such as weather data with the current methodology have large influence on clustering and possibly conclusions drawn from this.

4.4 Discussion of clustering

The results presented above are the outcome of a specific data treatment of output from simulations of specific models with different bricks and two different outdoor climates. Some analyses were made in section 4.3 on specific findings, in this section a more general perspective is used in the discussion.

4.4.1 Falsification and findings

Falsification has been used as the scientific method; rejecting hypotheses by showing cases where they are not true. The main findings were:

1. Clustering of materials based on un-weighted material properties (input clusters) do not correspond to clusters based on moisture content (output clusters)
2. Clustering based on moisture content at a specific point in a masonry wall may not correspond to clustering based on moisture content in another point
3. Output clustering is not independent of weather conditions (geographical location or year)

Finding 1 could still mean that some material parameters are more decisive than others, and a weighing should be made. Unfortunately, finding 2 and 3 do not support that, as they point out that other parameters may be more decisive than material properties, assumedly when the properties are within a tolerable range. Finding 2 also show that clustering may depend on which failure mode is to be considered as e.g. the risk of mould growth and risk of frost damage is unlikely to be relevant in the same place in a wall.

The decisive material properties based on **Figure 18** to **Figure 22** are only true in the described situation and only when moisture content is considered. If e.g. temperature is considered thermal conductivity is probably of high importance as well. It is therefore likely that the importance of the material properties depend on what output is considered, this leads to the discussion of what failure mode should be considered.

Although falsification is a simple way to eliminate hypotheses, it can also be too early to rule out possible indications just because they are not always true. Especially when the findings are different from what has been found in other projects e.g. the HAMSTAD project as described in section 2.1.3 *Simulation tools today* where it was found that HAM-results depend strongly on the detailing and quality of material characterization.

More simulation should therefore be made before the idea of some material properties being more decisive than others is ruled out. At least some properties may be more decisive than others in some critical situations or failure modes. Likewise, simulations with more materials than bricks alone could help defining within what range material properties seem to be less important than e.g. the weather.

But for the time being, in practice it may be of less importance which brick is chosen compared to other parameters, as long as the material parameter of the brick is within a certain range.

The discrepancies between the findings in this report and the HAMSTAD project might be caused by different focus. While HAMSTAD is more focused on the accuracy of simulations, the aim in this report is more practical; to facilitate the use of HAM simulations by making it easier for users to choose the right materials for simulations and help deciding what is the most important material properties to test. RIBuild has also a scientific purpose and interest in refining material characterisation, as described in section 2.2.1.3.

The method used is only the first step of a methodology in continuous development. The procedure has been described but some aspects remain neglected and obvious questions remain unnoticed.

In the following, it is the aim to pose those obvious questions and remaining aspects in a discussion of the results and the methodology, which delivered them.

Contextual-wise it is beneficial to separate the questions under two headlines as some address how the setup prior to findings and the findings' themselves are conceived. Other questions consider the methodological step deriving conclusions from the results. The first separation carry the heading 4.4.2 *Discussion of setup and findings* the second 4.5 *Discussion of impact characterisation*

4.4.2 Discussion of setup and findings

The described setup and findings are divided into issues and arguments about how the issues affect results or have been mitigated.

Issue	Argument / Mitigation
Material file selection (matching catalogue and DELPHIN material database) based solely on identification number may face the challenge of choosing the wrong material due to type errors or changed identification numbers. As the project file will simply include the wrong material file and simulate with this without noticing any error. E.g. choosing an insulation material instead of a brick.	With the use of project file input a script comparing or just showing the material properties could be written. This could help noticing errors or just making visual inspection possible.
Two of the three output measures represent the content of water in the bricks: relative humidity and moisture content where the later are used with the unit [kg/m ³] or [kg/kg] (kg water per kg brick) thus of three possible evaluation measures only one was used.	Moisture content [kg/m ³] was chosen as the best measure to compare the bricks because it is independent of temperature. If the measure that provide the results is temperature dependent, thermal conductivity is represented in two ways first the walls actual accumulation/drying potential hereafter the value used to evaluate that moisture condition e.g. relative humidity.
The presented findings of somewhat consistent ranking across sum vs. median and	A season with more precipitation and a low drying potential (typical winter) leads to a

<p>not insulated vs. insulated illustrated in Figure 12, Figure 15 and Figure 16 rely solely on</p> <ol style="list-style-type: none"> 1. A high moisture content in the winter 2. Output (moisture content) near exterior <p>This leads to a ranking biased towards moist conditions and may thereby only be valid for the walls' behaviour under very humid conditions.</p>	<p>higher level of moisture content. Assuming that it is under high levels of moisture content that the relevant failure modes prevail. A biased result is therefore justifiable.</p>
<p>The study is limited, as it only consists of:</p> <ul style="list-style-type: none"> • Two models; insulated with one type of insulation material and not insulated • Investigations in two points in the construction • Two different sets of boundary conditions 	<p>Further simulations can be made by varying several parameters, using quasi Monte Carlo methods. In this way trends toward which material properties are the most decisive for some failure modes could appear. However, falsification has shown that the answer will not be simple.</p>

4.5 Discussion of impact characterisation

The current impact characterisation is divided into formulated issues and arguments about how the issues affect results or have been mitigated.

Issue	Argument / Mitigation
<p>For the Input clusters twelve material properties of the bricks were used. The impact characterisation was based on bricks ranked according to simulation outputs followed by Output clusters. However, in the simulation program brick properties are described by additional functions (calibrated material functions) not only the twelve material properties.</p>	<p>Currently Output clusters are not compared with all their input parameters. Providing additional input parameters is not an appropriate approach due to their complexity. E.g. one of the findings is, that neither sorption nor suction curves are important (see Figure 20), that may be because they are only represented by one single point each. Adding more points as single material properties would probably not change this. Maybe the curves should be represented in another way. One possibility could be to present them as simple functions like in Hansen (1986) and use the coefficients as parameters.</p> <p>It would be beneficial if additional research could provide a smaller selection of</p>

	parameters to use for clustering.
Clustering require a threshold value or any other clustering criteria. The current study has not aimed to define such criteria; a simple threshold value have been used (sum of moisture content). This may provide inappropriate clusters as important details may escape, e.g. those in Figure 14 .	The Output clustering method and underlying ranking is subject of an update as better criteria might benefit from a more consistent output. This require a framework e.g. a failure mode that priorities long duration of relative high moisture content rather than short duration of high moisture content.
The brick samples' material properties are differently distributed and within some ranges, very few materials exist. First Scatter plot in Figure 19 and Figure 21 show this issue.	The sample could be modified to a more equal distribution removing very similar bricks. On the other hand, this would shorten an already fairly short sample in comparison with the many varying parameters.

4.6 Conclusion

It has been investigated how the most important material parameters for hygrothermal simulation outputs can be identified. The aim was to identify those material parameters for common materials in solid masonry in historic buildings.

It was confirmed that applying internal insulation to a solid masonry wall on its internal surface with 50 mm calcium silicate means

- Higher mean moisture content in all 44 bricks with the most noticeable changes near exterior.
- Lower mean temperature across 44 bricks with the most noticeable changes near interior.
- Higher mean relative humidity across 44 bricks with the biggest change near exterior.

It was found that

- Unweighted input clusters differ from Output clusters
 - Seen in a visualization of the moisture content of each brick (short time)
 - To some degree by ranking by the summed moisture content
 - Supporting that a relevant weighting of each parameter may exist in some situations
- Other parameters in hygrothermal simulations may be more important than material properties, e.g. weather or longwave radiation and precipitation catch ratio.

Further work to be done

- Improve the robustness of the identified effects by additional simulations, which might also allow other effects to be seen as additional outputs can provide better statistics to conclude from.
- Further simulations may show if material properties are of less importance if they are within a certain range e.g. if all bricks could be considered as one cluster, because other parameters are more important,

- If further simulations contrary to the findings here show a tendency of some material properties to be more decisive than others. The information should be used to suggest a weighting for each material parameter and make weighed input clusters of not yet included bricks which are then simulated and compared to output clusters

5 Testing procedures for determination of material parameters

The testing of most material properties is described in standards, however, some of the standards are not sufficiently precise to give reproducible results or other methods have been developed because they are easier, faster or cheaper to perform. In section 5.1 the standard methods are described in general terms, for exact descriptions the reader is referred to the standards, if alternative methods are available the description also include a reference to section 5.2 where methods that are deviations of the standard method are described or section 5.3 where alternative methods are described.

5.1 Standard measurement methods

5.1.1 Density

Material parameter to be determined: Dry density, ρ [kg/m^3 ; g/ml]

Name of the measurement method: Determination of net and gross dry density

Reference to a valid international standard (including number) or other standard or reference:

EN 772-13:2000. Methods of test for masonry units. Determination of net and gross dry density of masonry units (except for natural stone)

Testing principle (what is measured and how)

Test specimens are oven-dried to determine the dry mass of the specimen. The volume of the specimen is determined according to shape. The mass is then divided by volume to find the dry density.

Test samples

- Specimens must be representative of the product
- Specimens are recommended to be of regular shape (preferably cut samples of prismatic or cylindrical shape) to ease determination of volume

Testing conditions

The specimens are dried in 105°C until two measurements with an interval of at least 24 hours differ less than 0.2%.

If volume is determined by level difference in a measuring tank when submerging specimen in water, the specimen should be saturated to reduce effect of water absorption during measurement. Sand can be used alternatively.

Calculation procedure (including symbols and units)

Generally dry density ρ is determined dividing dry mass m [kg] by volume V [m³]:

$$\rho = \frac{m}{V} \quad \left[\frac{\text{kg}}{\text{m}^3} \right] \quad (1)$$

If the specimen is of regular shape the volume can be determined by using basic geometric formulae for prismatic samples by multiplying 3 dimensions x , y and z [m]:

$$V = x \cdot y \cdot z \quad [\text{m}^3] \quad (2)$$

and for cylindrical samples by knowing height of the cylinder z [m] and base radius r [m]:

$$V = z \cdot \pi r^2 \quad [\text{m}^3] \quad (3)$$

If the level difference method is used, volume of the sample is the difference between volume of the liquid with sample submerged V_1 and volume of the liquid without the sample V_2 :

$$V = V_1 - V_2 \quad [\text{m}^3] \quad (4)$$

Alternative procedure: See section 5.2.1 *Density and porosity at TUD*

5.1.2 Porosity

Material parameter to be determined: Open porosity, P [%]

Name of the measurement method: Determination of net volume and percentage of voids

Reference to a valid international standard (including number) or other standard or reference:

- EN 772-3:1998. Methods of test for masonry units. Determination of net volume and percentage of voids of clay masonry units by hydrostatic weighing

Testing principle (what is measured and how)

The test specimens are saturated with water, weighed in air and weighed when submerged in water. The two weights are used to determine the volume of pores in the specimen which is then divided by the gross volume of the specimen (determined geometrically or by level difference) to get the percentage of pores.

Test samples

- Specimens must be representative of the product
- Specimens are recommended to be of regular shape (preferably cut samples of prismatic or cylindrical shape) to ease determination of volume

Testing conditions

The experiment requires a tank large enough for the sample to be submerged under water and a balance which can be used to weigh the tank together with the sample.

If volume is determined by level difference in a measuring tank when submerging specimen in water, the specimen should be saturated to reduce effect of water absorption during measurement. Sand can be used alternatively.

Calculation procedure (including symbols and units)

The net volume of the specimen (solid volume fraction) can be calculated using weight of the saturated specimen in air m_{au} [kg], weight of the specimen when submerged m_{wu} [kg] and density of water ρ_{wu} [kg/m³]:

$$V_{nu} = \frac{m_{au} - m_{wu}}{\rho_{wu}} \quad [\text{m}^3] \quad (1)$$

If the specimen is of regular shape the gross volume V_{gu} can be determined by using basic geometric formulae for prismatic samples by multiplying 3 dimensions x, y and z:

$$V_{gu} = x \cdot y \cdot z \quad [\text{m}^3] \quad (2)$$

and for cylindrical samples by knowing height of the cylinder z [m] and base radius r [m]:

$$V_{gu} = z \cdot \pi r^2 \quad [\text{m}^3] \quad (3)$$

If the level difference method is used, gross volume of the sample is the difference between volume of the liquid with sample submerged V_1 and volume of the liquid without the sample V_2 :

$$V_{gu} = V_1 - V_2 \quad [\text{m}^3] \quad (4)$$

The volume of voids is then calculated by:

$$V_{vu} = V_{gu} - V_{nu} \quad [\text{m}^3] \quad (5)$$

The open porosity P is then:

$$P = \frac{V_{vu}}{V_{gu}} \cdot 100\% \quad [\%] \quad (6)$$

Alternative procedure: See section 5.2.1 *Density and porosity at TUD*

5.1.3 Specific heat capacity

Material parameter to be determined: Specific heat capacity, c_p [J/g K]

Name of the measurement method:

Determination of the specific heat capacity by differential scanning calorimetry

Reference to a valid international standard (including number) or other standard or reference:

Specific heat capacity can be determined by the following standardized test methods:

- EN 11357-1:2009. Differential scanning calorimetry (DSC) - Part 1: General Principles
- EN 11357-4:2014. Differential scanning calorimetry (DSC) - Part 4: Determination of specific heat capacity
- ASTM E1269-11. Standard Test Method for Determining Specific Heat Capacity by Differential Scanning Calorimetry

Testing principle (what is measured and how)

Differential scanning calorimetric (DSC) measurements provide a rapid, simple method for determining specific heat capacities of materials. DSC is a technique in which the difference between the rate of flow of heat into a crucible containing the specimen and that into a reference crucible. It is derived as a function of temperature and/or time while the specimen and reference are subjected to the same controlled temperature programme in a specified atmosphere using a symmetrical measurement system.

In a heat-flux DSC the specimen and reference positions are subjected to the same temperature-control programme by a single heater. A difference in temperature ΔT [K] occurs between the specimen position and the reference position because of the difference in heat capacity between the specimen and the reference. From this temperature difference, the difference in the rates of heat flow into the specimen and reference positions is derived and is normally recorded against the temperature of the reference, T_{ref} [K], or against time.

Each measurement consists of three runs at the same scanning rate:

- 1) a blank run (empty pans in sample and reference holders);
- 2) a calibration run (calibration material in sample holder pan and empty pan in reference holder);
- 3) a specimen run (specimen in sample holder pan and empty pan in reference holder).

Test samples

Particular care shall be taken to avoid any contamination of the specimen. If the specimen is taken from larger pieces by cutting, care shall be taken to prevent heating, polymer orientation or any other effect that may alter the specimen properties. Operations such as grinding that could cause heating or reorientation and could therefore change the thermal history of the specimen shall be avoided.

The specimen shall be representative of the sample being examined and shall be prepared and

handled with care.

Solid specimens may be sampled by cutting or slicing with a clean knife or razor blade. Sample uniformity should be ascertained, since segregation within the solid is possible. Solid specimens should be so sampled as to maximize contact with the surface of the specimen holder.

Powdered or granular specimens should be mixed prior to sampling and should be sampled by removing portions from various parts of the container. These portions, in turn, should be combined and mixed to ensure a representative specimen for the determinations.

Typical specimen masses are between 2 mg and 40 mg. Since milligram quantities of specimen are used, it is essential that specimens are homogeneous and representative.

Testing conditions

Unless otherwise specified, specimens shall be dried to constant mass before performing measurements.

Care shall be taken to choose suitable drying conditions to prevent physical changes, such as ageing or changes in crystallinity, of the specimens.

The occurrence of chemical changes or mass loss on heating during the measurement may invalidate the test. Therefore, the temperature range and specimen holders should be chosen so as to avoid these processes.

The instrument shall be maintained and operated in an atmosphere suitable for the intended test.

Unless excluded by special requirements for particular test procedures, all calibration and test measurements shall be performed using closed, ventilated crucibles, preferably made of aluminium, to improve reproducibility. It is recommended that the instrument be protected from air draughts, exposure to direct sunlight and abrupt changes in temperature, pressure or mains voltage.

Calculation procedure (including symbols and units)

The test method consists of heating the test material at a controlled rate in a controlled atmosphere through the region of interest. The difference in heat flow into the test material and a reference material or blank due to energy changes in the material is continually monitored and recorded.

Specific heat capacity (at constant pressure) c_p [$\text{J g}^{-1} \text{K}^{-1}$] is the quantity of heat necessary to raise the temperature of unit mass of material by 1 K at constant pressure. It is given by the following equation:

$$c_p = \frac{C_p}{m} = \frac{1}{m} \left(\frac{dQ}{dT} \right)_p \quad (1)$$

where

m is the mass of material [g];

C_p is the heat capacity [J]; subscript p indicates an isobaric process;

dQ is the quantity of heat [J] necessary to raise the temperature of the material by dT [K];

Based on the DSC principle the following relations can be obtained:

$$m^{sp} \cdot c_p^{sp} = P_{specimen\ run} - P_{blank\ run} \quad (2)$$

$$m^{cal} \cdot c_p^{cal} = P_{calibration\ run} - P_{blank\ run} \quad (3)$$

where

P is the heat flow rate (dQ/dt) [J/K];

superscripts sp and cal represent specimen and calibration material.

When $P_{specimen\ run}$, $P_{calibration\ run}$ and $P_{blank\ run}$ are measured, c_p^{sp} can be calculated using the following equation, since the value of c_p^{cal} , m^{sp} and m^{cal} are known:

$$c_p^{sp} = c_p^{cal} \frac{m^{cal} \cdot (P_{specimen\ run} - P_{blank\ run})}{m^{sp} \cdot (P_{calibration\ run} - P_{blank\ run})} \quad (4)$$

Alternative procedure: See section 5.3.1 *Heat capacity and thermal conductivity at TUD*

5.1.4 Thermal conductivity

Material parameter to be determined: Thermal conductivity, λ [W/m K]

Name of the measurement method: Determination of thermal resistance by means of guarded hot plate and heat flow meter methods

Reference to a valid international standard (including number) or other standard or reference:

Steady state heat transfer properties may be measured by a number of standardized test methods:

- EN 12664:2001. Thermal performance of building materials and products - Determination of thermal resistance by means of guarded hot plate and heat flow meter methods - Dry and moist products of medium and low thermal resistance.
- EN 12667:2001. Thermal performance of building materials and products - Determination of thermal resistance by means of guarded hot plate and heat flow meter methods - Products of high and medium thermal resistance.
- EN 12939:2000. Thermal performance of building materials and products - Determination of thermal resistance by means of guarded hot plate and heat flow meter methods - Thick products of high and medium thermal resistance.

Detailed requirements for measurements in any testing condition of thermal resistance of any compatible plane specimen are given:

- for the guarded hot plate method, in ISO 8302:1991 and EN 1946-2:1999
- for the heat flow meter method, in ISO 8301:1991 and EN 1946-3:1999

Testing principle (what is measured and how)

Standards specify principles and testing procedures for determining, by means of the guarded hot plate or heat flow meter methods, the thermal resistance of test specimens. Both apparatus are intended to establish within homogeneous specimens with flat parallel faces, in the form of slabs, a unidirectional constant and uniform density of heat flow rate. The part of the apparatus where this takes place with acceptable accuracy is around its centre; the apparatus is therefore divided in a central metering section in which measurements are taken, and a surrounding guard section.

With the establishment of steady state conditions in the metering section, the density of heat flow rate, q [W/m^2], is determined from measurement of the heat flow rate, ϕ [W], and the metering area, A [m^2], that the heat flow rate crosses. The temperature difference across the specimens, ΔT [K], is measured by temperature sensors fixed at the surfaces of the apparatus in contact with the specimen and/or those of the specimens themselves, where appropriate.

The thermal resistance, R [$\text{m}^2\text{K}/\text{W}$], is calculated from the knowledge of q , A and ΔT if the appropriate conditions are realized. From the additional knowledge of the thickness d [m] of the specimen, thermal conductivity λ [$\text{W}/\text{m K}$] is computed.

Test samples

One or two specimens shall be selected (from each sample) according to the type of apparatus.

The surface of the test specimens shall be made plane by appropriate means (sandpapering, face-cutting in a lathe and grinding are often used), so that close contact between the specimens and the apparatus or interposed sheets can be effected. For rigid materials, the faces of the specimens shall be made as flat as the apparatus surfaces and shall be parallel over the total surface area within 2% of the specimen thickness. The planeness of the surfaces can be checked with, for example, a good quality engineer's straightedge (straight to 0,01 mm) held against the surface and viewing at grazing incidence with a light behind the straightedge. Departures as small as 25 μm are readily visible. Scratches, chips or similar defects over and above the naturally occurring surface irregularities in the finished surfaces of cellular or aggregate materials are accepted. Provided that the total of their surface areas is an acceptable fraction of the metering area and that their maximum depth is an acceptable fraction of the specimen thickness, so as to keep the added thermal resistance due to the corresponding air pockets low.

When testing loose-fill materials, the thickness of the specimen shall be at least 10 times the mean dimension of the beads, grains, flakes, etc. of the loose-fill material. For layered inhomogeneous composite specimens, the mean measurable thermal conductivity of each layer should be less than twice that of any other layer. Some specimens are anisotropic in that the value of the thermal conductivity measured in a direction parallel to the surfaces is different to that measured in a direction normal to the surfaces.

Testing conditions

Measurements should, as far as possible, be carried out on dry materials. The drying process should not alter the chemical and physical nature of the material. The specimen should be dried to constant mass in a ventilated oven at 105 °C to 110 °C that takes the air from an environment at (23 \pm 2) °C and (50 \pm 5) % relative humidity. Constant mass is considered to have been established

when the change in the mass of the test specimen over a 24 h period is random and less than the equivalent of 0,1 kg/m³ (or 0,01% by volume).

During the test to determine the heat transfer properties it is recommended that temperature differences are in the range of 10 K to 50 K, in order to minimize temperature-difference measurement errors. In the unlikely event that lower or higher temperature differences are required by a product, standard ISO 8302:1999 shall be consulted. The maximum operating temperature of the heating and cooling units may be limited by oxidation, thermal stress or other factors which degrade the flatness and uniformity of the surface plate and by changes of electrical resistivity of electrical insulations which may affect accuracy of all electrical measurements.

As the principle of the method assumes steady state conditions, to attain a correct value for properties, it is essential to allow sufficient time for the apparatus and specimen to attain thermal equilibrium.

Calculation procedure (including symbols and units)

Thermal conductivity λ [W/m K] is the quantity defined in each point of a purely conducting medium by the following relation between the vectors q and $grad(T): q = -\lambda grad(T)$

To make all the computations, average values of the observed steady state data should be used.

Concerning the guarded hot plate apparatus measurements the thermal resistance R [m²K/W] is computed using the following equation:

$$R = \frac{T_1 - T_2}{\phi} A \quad (1)$$

and the thermal conductivity λ [W/m K] using the following equation:

$$\lambda = \frac{\phi d}{A (T_1 - T_2)} \quad (2)$$

where

ϕ is the average power supplied to the metering section of the heating unit [W];

T_1 is the average specimen(s) hot side temperature [K];

T_2 is the average specimen(s) cold side temperature [K];

A is the metering area [m²];

d is the average specimen(s) thickness [m].

Concerning the heat flow meter apparatus, measurements on a single specimen configuration or a two-specimen configuration can be used.

In a single heat flow meter configuration the thermal resistance R [m²K/W] is computed using the following equation:

$$R = \frac{T_1 - T_2}{f e_h} \quad (3)$$

and the thermal conductivity λ [W/m K] using the following equation:

$$\lambda = \frac{f e_h d}{T_1 - T_2} \quad (4)$$

where

f is the calibration factor of the heat flow meter [$\text{W}/\text{mV m}^2$];

e_h is the heat flow meter output [mV];

T_1 is the average specimen(s) hot side temperature [K];

T_2 is the average specimen(s) cold side temperature [K].

In a two-specimen configuration the total thermal resistance R [$\text{m}^2\text{K}/\text{W}$] is computed using the following equation:

$$R_t = \frac{(T_1' - T_2') - (T_1'' - T_2'')}{f e_h} \quad (5)$$

and the thermal conductivity λ [$\text{W}/\text{m K}$] using the following equation:

$$\lambda = \frac{f e_h}{2} \left(\frac{d'}{(T_1' - T_2')} + \frac{d''}{(T_1'' - T_2'')} \right) \quad (6)$$

where f , e_h , T_1 , T_2 and d are as defined above and the symbols ' and '' refer to the two specimens (' for the first specimen and '' for the second specimen).

Alternative procedure: See section 5.3.1 *Heat capacity and thermal conductivity at TUD*

5.1.5 Vapour permeability

Material parameter to be determined: Water vapour resistance factor, μ [-]

Name of the measurement method: Determination of water vapour transmission properties

Reference to a valid international standard (including number) or other standard or reference:

- EN ISO 12572:2001 – Hygrothermal performance of building materials and products – Determination of water vapour transmission properties

The following parameters can be determined by the measurement method;

- Water vapour permeance, W [$\text{kg}/(\text{m}^2 \cdot \text{s} \cdot \text{Pa})$]
- Water vapour resistance, Z [$(\text{m}^2 \cdot \text{s} \cdot \text{Pa})/\text{kg}$]
- Water vapour permeability, δ [$\text{kg}/(\text{m} \cdot \text{s} \cdot \text{Pa})$]
- Water vapour resistance factor, μ [-]
- Water vapour diffusion-equivalent air layer thickness, s_d [m]

Testing principle (what is measured and how)

Test specimens are sealed in a test cup. The test cup contains either a desiccant or an aqueous solution, for dry cup and wet cup experiments respectively, in order to obtain steady climate conditions (RH) within the cup. The cup is placed in a climate chamber with controlled conditions (T and RH). A vapour flow will occur through the specimen due to variations in the vapour pressure on either side of the specimen. By means of periodic weighing of the test cup, the rate of water vapour transmission can be determined.

Test samples

- Specimens must be representative of the product
- Specimens should be tested with vapour flow in the intended direction, if different surfaces are represented
- The parallel faces of the specimens should be normal to the direction of flow (if not isotropic)
- Shape and fit
 - Depends on material and chosen test assembly
- Exposed area
 - Circular specimens: the diameter should be min. 2 x thickness
 - Square specimens: the side should be min. 2 x thickness
 - Exposed area: min. 0.005m²
 - Difference between upper and lower surface area max 3% (homogenous materials) or 10% (other materials)
- Thickness
 - Preferably that of the product in use (may be reduced if >100mm)
 - Non-homogenous materials: min. 3 x (preferably 5 x) the largest particle size.
- If specimen has macroscopic voids, solid material should be tested individually, and the total resistance calculated from the proportions of solid to air space.
- Number of specimens
 - If surface area <0.02 m², min. 5 specimens
 - If surface area < 0.02 m², min. 3 specimens
- Test specimens should be conditioned at 23 ± 5°C and 50 ± 5 % relative humidity until the weight is stable within 5 % for 3 successive daily weighings.

Testing conditions

Testing conditions depend on the desired test environment;

Set	Condition [°C - % RH]	Temperature [°C]	Relative humidity [%]			
			Dry state		Wet state	
			Set point	Tolerance	Set point	Tolerance
A	23 - 0/50	23 ± 0.5	0	+3	50	±3
B	23 - 0/85	23 ± 0.5	0	+3	85	±3
C	23 - 50/93	23 ± 0.5	50	±3	93	±3
D	38 - 0/93	38 ± 0.5	0	+3	93	±3

Dry cup tests indicates the material's performance at low humidities (moisture transfer dominated by vapour diffusion), whereas wet cup tests specifies the performance at high humidities (moisture transfer consists of both vapour and liquid transfer).

Desiccants could be: CaCl_2 and $\text{Mg}(\text{ClO}_4)_2$

Aqueous solutions could be: $\text{Mg}(\text{NO}_3)_2$ (53%), KCl (85%), $\text{NH}_4\text{H}_2\text{PO}_4$ (93%)

Calculation procedure (including symbols and units)

The mass is plotted as a function of time, and the slope of the regression line from this function represents water vapour flow rate, G [kg/s] through the specimen. The density of the water vapour flow, g [kg/m² s], can be calculated by means of equation (1), where A [m²] represents the area of exposed surface;

$$g = \frac{G}{A} \quad (1)$$

The water vapour permeance, W [kg/(m²·s·Pa)], is calculated by means of the water vapour pressure difference, Δp_v [Pa] between each side of the specimen. The water vapour pressure, p [Pa] on both sides is calculated according to mean temperature and relative humidity obtained in the chambers during the course of the experiment and equation (2), θ representing temperature [°C] and φ being relative humidity [%];

$$p = \varphi \cdot 610,5 \cdot e^{\frac{17,269 \cdot \theta}{237,5 + \theta}} \quad (2)$$

Thus the permeance, W [kg/(m²·s·Pa)], can be found by means of equation (3);

$$W = \frac{G}{A \Delta p_v} \quad (3)$$

The water vapour resistance, Z [m²·s·Pa/kg], is calculated as the reciprocal value of the permeance, equation (4):

$$Z = \frac{1}{W} \quad (4)$$

The water vapour permeability, δ [kg/(m·s·Pa)] can be calculated by means of equation (5), where d [m] represents the thickness of the given specimen:

$$\delta = W \cdot d \quad (5)$$

The water vapour resistance factor, μ [-], is calculated as the relationship between δ and δ_a . δ_a is the water vapour permeability of still air. δ_a is calculated by means of Schirmers formula, equation (6):

$$\delta_a = \frac{2.306 \cdot 10^{-5} \cdot P_0}{R_v \cdot T \cdot P_a} \cdot \left(\frac{T}{273.15} \right)^{1.81} \quad (6)$$

Where:

P_0 is the standard atmospheric pressure of 101325 Pa,

P_a [Pa] is the ambient air pressure,

T [°C] is the average climate chamber temperature

R_v is 461.5 J/kg·K - the gas constant for water.

The water vapour resistance factor can be found with δ_a and equation 7;

$$\mu = \frac{\delta_a}{\delta} \quad (7)$$

The thickness of an equivalently diffusive air layer, s_d [m], is calculated by one of the following equations in (8). Said for s_d is, that more than 1500 m the material is impermeable, and at values below 0.1 m the method is ruled useless due to large uncertainties.

$$s_d = \mu \cdot d \text{ or } s_d = \delta_a \cdot Z \quad (8)$$

For highly permeable materials ($s_d < 0.2$ m) the air layer between the desiccant/aqueous solutions and the test specimen has some resistance towards the vapour flow. Thus corrections to the original calculations must be made. The corrected water vapour permeance, W_c [$\text{kg}/(\text{m}^2 \cdot \text{s} \cdot \text{Pa})$], is calculated by equation (9) where d_a represents the thickness of the air layer. Hence corrected values of Z and δ can be found by means of formulas (4) and (5) with W_c .

$$W_c = \frac{1}{\frac{A \Delta p_v}{G} - \frac{d_a}{\delta_a}} \quad (9)$$

In order to disregard resistance of the air layer above the cup, the air velocity above the specimens is kept above 2 m/s.

Alternative procedure: See section 5.2.2 *Water vapour diffusion (water vapour permeability) at TUD*

5.1.6 Free water uptake

Material parameter to be determined:

Capillary absorption coefficient, A_{cap} , [$\text{kg}/\text{m}^2 \text{ s}^{0.5}$] and capillary moisture content, w_{cap} [kg/m^3]

Name of the measurement method: Free water uptake

Reference to a valid international standard (including number) or other standard or reference:

Most elements of this description have been adopted from

- ISO 15148:2002, 2002: Hygrothermal performance of building materials and products – Determination of water absorption coefficient by partial immersion. [1].
- HAMSTAD WP1 final report – Moisture transfer properties and materials characterisation [7]

It should be noted though that both guidelines are at points conflicting, and that there is hence no gold standard in relation the free water uptake test yet.

Comments:

The ISO 15148 primarily targets industrial applications, with less demanding procedures, while more stringent protocols are applied in scientific investigations. The free water uptake test, with strict protocols being followed, is in itself a very repeatable test method ISO 15148 (2002).

However, it is still blemished by a (very) poor reproducibility, as illustrated in the round-robin test performed during the HAMSTAD project (Roels, Carmeliet & Hens, 2003). The primary explanation put forward in (Roels, Carmeliet & Hens, 2003) is the impact of the way of top side sealing on the air escape and air pressure build-up. In section 5.2.3 *Free water uptake at TUD* a more stringent protocol is described as a deviation of the standard method.

Testing principle (what is measured and how)

Free water uptake tests can be applied for multiple purposes. At the simplest level, free water uptake tests are performed to acquire the capillary absorption coefficient A_{cap} ($\text{kg}/\text{m}^2\text{s}^{0.5}$) and the capillary moisture content w_{cap} (kg/m^3) (ISO 15148, 2002), both of which are principal indicators of the moisture storage and transport characteristics of porous building materials.

In what follows, the pure determination of the capillary absorption coefficient and capillary moisture content is assumed the target. The description moreover focuses on the manual weighing protocol, while automated weighing procedures are in place in selected laboratories (Plagge, Scheffler & Grunewald, 2005).

In a free water uptake test, the bottom surface of an initially oven-dry material sample is put in contact with a free water surface, which initiates the spontaneous capillary absorption of moisture into the material. During the test the cumulative moisture absorption is measured by frequent weighing. Generally, two distinct stages can be identified in the absorption process (**Figure 24**). In the first stage, the position of the moisture front moves up through the sample, until it reaches the top side at height h (m). At that point it is assumed that the capillary moisture content is reached. In the second stage, a further moisture increase occurs, due to dissolution of entrapped air through the pore water, until the saturated moisture content is reached (Janssen, Vereecken & Holúbek, 2015).

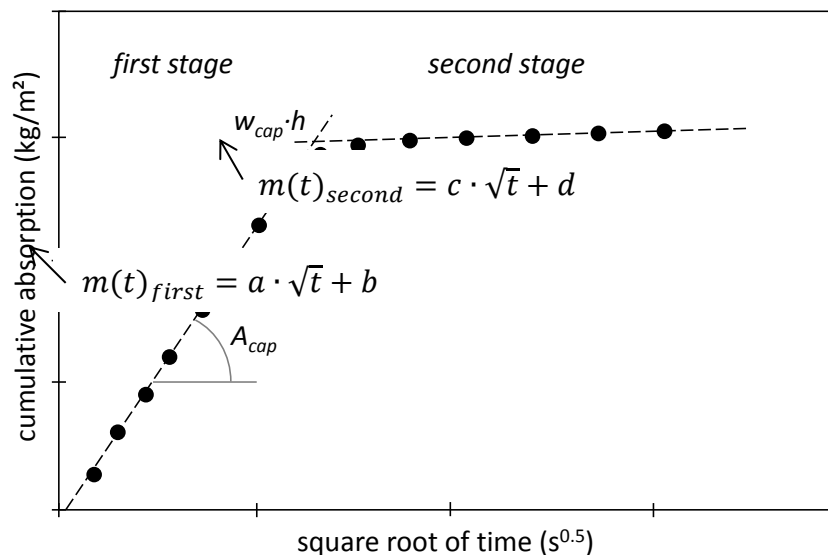

Figure 24. Free water uptake test: cumulative moisture absorption plotted versus square root of time.

Test samples

ISO 15148 (2002) recommends samples with a bottom surface of at least 100 cm², but imposes a lower limit of 50 cm². In the former case 3 samples are assumed to suffice, in the latter case at

least 6 samples with total bottom surface area of 300 cm² are required. The standard furthermore suggests maintaining the product's original height as sample height whenever possible.

To reduce the effect of evaporation during the uptake test, the lateral sides of all samples should be sealed. This may be done using a cling film or by applying wax or epoxy. In the latter case however, one should take care that the sealing product does not significantly penetrate these lateral sides. For the former, the film is not to touch the water surface, and hence preferably leaves the bottom centimetre of the lateral sides free. Whereas ISO 15148 suggests to keep the top surface free to allow evacuation of displaced air, it is better to cover it as well while allowing for escaping air, in order to diminish the impact of evaporation on the second absorption phase.

Testing conditions

Prior to the test, samples should be oven-dried at an appropriate temperature during an appropriate interval, typically until the sample mass is stabilised to within 0.1 % when measured over 24 h (ISO 15148, 2002). Preconditioning according to ISO 15148 (2002) is storage under lab conditions, at relative humidities between 40% and 60%.

To initiate the free water uptake test, the bottom surfaces of the samples are put in contact with a free water surface, with only a minimal water contact – maximum 1 mm – along the lateral sides. During the uptake test the water plane is kept at a constant height e.g. by use of a Mariotte-bottle. Below the water plane point supports need to be provided to hold the samples, to not impede the moisture absorption at the bottom surfaces. According to ISO 15148 (2002) the test can be performed under normal lab conditions.

NOTE: Necessary deviations for enhanced reproducibility:

- Prior to the test, samples should be oven-dried at an appropriate temperature during an appropriate interval, typically until the sample mass is stabilised to within 0.1 % when measured over 24 h (ISO 15148, 2002). Storing at lab conditions may lead to already significant initial moisture contents for highly hygroscopic materials, a disturbance that can be minimised by applying oven-drying. In almost all scientific investigations, such oven-drying is the norm.
- Ideally, the entire test takes place in a climate chamber at high relative humidity, to confine evaporation even further (Roels, Carmeliet & Hens, 2003). Alternatively, one can cover the water basin with a lid, wherein evaporation from the water plane then provides the high relative humidity (Feng et al., 2015).

Calculation procedure (including symbols and units)

The measured cumulative moisture absorption is typically processed by a two-secant-approach: the measured points of the first and the second absorption stage are separately fitted with a linear function of the form:

$$m(t)_{first} = a \cdot \sqrt{t} + b \quad (1)$$

$$m(t)_{second} = c \cdot \sqrt{t} + d \quad (2)$$

In these fits, one should exclude the points that form the transition from the first to the second

phase, as well as any deviating points at the start of the of the first phase (which may arise due to the initial three-dimensional inflow and/or an initial surface resistance).

The capillary absorption coefficient and capillary moisture content can then be derived from respectively the slope of the first curve and the intersection between the two curves:

$$A_{cap} = a \quad (3)$$

$$w_{cap} = (a \cdot d - b \cdot c) / (h \cdot a - h \cdot c) \quad (4)$$

Where h (m) is the height of the specimen.

Alternative procedure: See section 5.2.3 *Free water uptake at TUD*

5.1.7 Air permeability

Material parameter to be determined: Air permeability, K_p [m^2] and airflow resistance, r [Pa s/m^2]

Name of the measurement method

Measurement of the permeability of unsaturated porous materials by flowing air

Reference to a valid international standard (including number) or other standard or reference

ASTM D6539 – 13. Standard Test Method for Measurement of the Permeability of Unsaturated Porous Materials by Flowing Air

Testing principle (what is measured and how)

This test method covers laboratory determination of the coefficient of permeability for the flow of air through unsaturated porous materials and may be used with intact or compacted coarse grained soils, silts, or lean cohesive soils that have a low degree of saturation and that have permeability between $1.0 \times 10^{-15} \text{ m}^2$ and $1.0 \times 10^{-10} \text{ m}^2$.

A controlled air flow is passing through a test specimen in the form of a cylinder. The air flow through the test specimen shall be one-dimensional laminar. The permeameter shall be capable of rapidly establishing a constant flow of air through the test specimen and measuring the consequent pressure drop across it. The basic testing principle is shown in Figure 25.

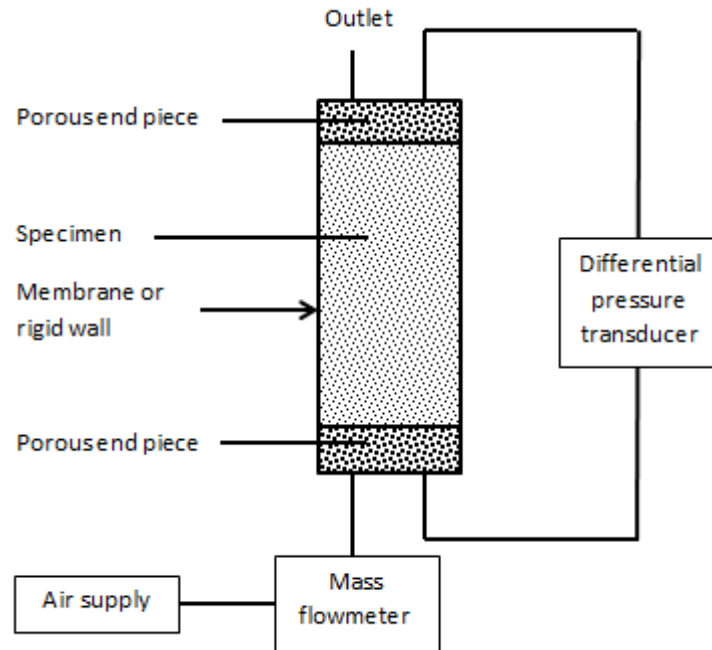

Figure 25. Basic testing principle

This test method covers the use of two different types of permeameter cells (flexible and rigid wall permeameters) and two types of air flow regulation (mass flow control and pressure control).

Test samples

The test specimen shall be a right circular cylinder with a diameter of at least 51 mm. The specimen length should be greater than 1.3 times the diameter and greater than five times the combined thickness of the porous end pieces.

Testing conditions

A controlled unidirectional airflow through the test specimen. The temperature of the testing environment shall not vary more than $\pm 2^\circ\text{C}$ over the course of test or a series of related tests. The degree of saturation of the specimen shall be less than that which would produce significant internal transport of pore water or alter the continuity of air voids under the applied gradients.

Calculation procedure (including symbols and units)

Calculation of the permeability using Darcy's law requires laminar flow conditions through the soil specimen. The conditions for laminar flow shall be evaluated by plotting the volumetric flow rate of air through the specimen against the pressure drop across the specimen. If the individual test points lie within 25 % of a straight line passing through the origin, then laminar flow conditions are present and Darcy's law may be used to calculate the permeability.

The airflow permeability K_p [m^2] is given by:

$$K_p = (Q_{VA} \cdot L \cdot \mu) / (\Delta P \cdot A) \quad (1)$$

and airflow resistance r [Pa s/m^2] is given by:

$$r = \mu/K_P \quad (2)$$

where:

Q_{AV} = average volumetric flow rate of air through the specimen [m^3/s]

ΔP = pressure drop across the specimen [Pa]

L = specimen length [m]

A = specimen cross-sectional area [m^2]

μ = viscosity of air at the test temperature [$\text{Pa}\cdot\text{s}$]

Alternative procedure: See section 5.2.6 Airflow resistance

5.1.8 Moisture storage function (sorption curve)

Material parameter to be determined: Moisture Storage Function (sorption curve)

Name of the measurement method: Determination of hygroscopic sorption properties

- a) Desiccator method (reference method)
- b) Climatic chamber method

Reference to a valid international standard (including number) or other standard or reference

EN ISO 12571:2013. Hygrothermal performance of building materials and products - Determination of hygroscopic sorption properties

Testing principle (what is measured and how)

Moisture sorption isotherm is a curve giving the functional relationship between humidity and equilibrium water content of a material at a constant temperature. Thus, the sorption (wetting)/desorption (drying) curves are sigmoidal curves established at a series of increasing/decreasing equilibrium relative humidities at a given temperature. Although they are almost identical, the desorption curve is usually slightly higher than the adsorption curve of a given material due to the phenomenon of hysteresis. Often only the adsorption isotherm is used.

In laboratory tests, the moisture content of samples in equilibrium with air at a specific temperature and humidity is determined. Several methods are available. EN ISO 12571:2013 allows two different methods to determine the hygroscopic sorption properties of porous building materials:

The desiccator method using desiccators and weighing cups (reference method)

The experimental setup is shown in Figure 26.

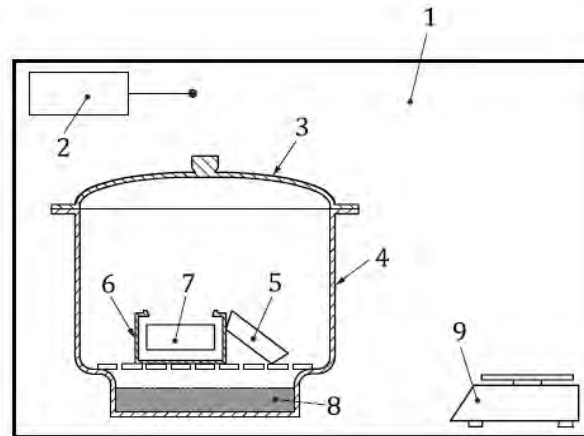

Key	
1	constant temperature chamber
2	thermometer
3	lid of desiccator
4	desiccator
5	lid of weighing cup
6	weighing cup
7	test specimen
8	saturated salt solution
9	electronic balance

Figure 26. Desiccator

To establish standard air relative humidities, at least 5 different saturated salt solutions with different corresponding relative humidities are used. In Table 7 Table 7. Standard air relative humidities above saturated solutions in equilibrium some examples of possible substances and the corresponding relative humidity values are shown. For measuring sorption curves at least 5 conditions including no. 2, 4 and 6 should be chosen.

The relative humidity within the weighing cup is determined by the saturated salt solution used in the desiccator. The saturated solution regulates the air's relative humidity in the desiccator.

Table 7. Standard air relative humidities above saturated solutions in equilibrium

No.	Substance	Relative humidity [%] at air temperature 23 °C	Relative humidity [%] at air temperature 27 °C
1	KOH	9	8
2	MgCl ₂ ·6H ₂ O	33	33
3	Mg(NO ₃) ₂ ·6H ₂ O	53	52
4	NaCl	75	75
5	KCl	85	84
6	KNO ₃	93	93

The climatic chamber method using a climatic chamber

Instead of using desiccator and saturated salt solutions, the samples are placed in a climatic chamber where relative humidity and temperature can be controlled.

The relative humidity and the temperature in the whole testing area of the climatic chamber shall be carefully monitored with shielded calibrated instruments.

For the adsorption curve, the completely dry test specimen is placed consecutively in a series of test environments where the relative humidity increases in stages (at least 4) within the humidity range under consideration, while the temperature is constant. Moisture content is measured when equilibrium is reached in the given environment. Equilibrium with the environment is established by weighing the specimen until constant mass is reached. The adsorption curve is drawn by joining the moisture content values.

The procedure for the desorption curve is similar, but starting at a point with at least 95 % relative humidity and placing the test specimens consecutively in a series of test environment with relative humidity decreasing in stages.

Test samples

Test specimens with a mass ≥ 10 g that are a typical example of the investigated product are used. For specimens with a dry density < 300 kg/m³ a minimum size of 100 mm x 100 mm is needed. Test specimens can be broken or cut into smaller pieces for time saving reasons, if it has been shown that this will not influence the results. The test must include at least three specimens.

Testing conditions

Reference sorption curves have usually to be made at a temperature of 23 (± 0.5) °C, but at 27 (± 0.5) °C in tropical regions. If necessary other temperatures can also be used if agreed upon.

Calculation procedure (including symbols and units)

Hygroscopic sorption

The moisture content u [kg/kg] can be calculated for each specimen with the following formula:

$$u = \frac{m - m_0}{m_0}$$

Where:

u [kg/kg] is the moisture content of test specimen

m [kg] is the mass of test specimen at equilibrium with the relative humidity

m_0 [kg] is the mass of the dried test specimen estimated from the following formula:

$$m_0 = m_2 - m_1$$

m_1 [kg] is the mass of the weighing cup and lid when empty and dry

m_2 [kg] is the mass of the test specimen dried to constant mass together with the weighing cup and

lid

m_3 [kg] is the constant mass of the test specimen at equilibrium with the relative humidity together with the weighing cup and lid, estimated from the following formula: $m_3 = m + n$
Constant mass is achieved when the mass remains constant ($\pm 0.1\%$ difference of the total mass of the specimen) during two consecutive periods ≥ 24 h with 3 weighings.

For the sorption- or desorption curve, the mean value of the calculated moisture content of the various test specimens (for a minimum of three specimens) at each relative humidity is taken. Thereafter, the sorption- or desorption curves can be drawn by joining the data points by using 5 or more air relative humidity conditions with straight lines (see Figure 27).

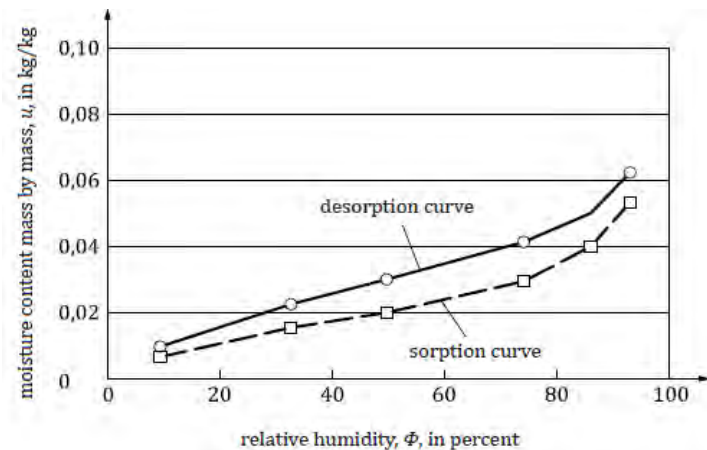

Figure 27. Equilibrium moisture content curves

Accuracy of measurement

The error in moisture content can be estimated by using the following formula: $\frac{\Delta u}{u} = \pm 0.0002 \frac{m_0}{m - m_0}$

The test apparatus shall include balance, capable of weighing to an accuracy of + 0.01 % of the mass of the test specimen.

Alternative procedure: See section 5.2.4 Moisture storage function (sorption and water retention) at TUD

5.1.9 Moisture storage function (suction curve)

Material parameter to be determined: Over-hygroscopic moisture content $\theta_i(p_c)$

Name of the measurement method:

Determination of the water-retention characteristic (moisture storage in over-hygroscopic range)

Reference to a valid international standard (including number) or other standard or reference:

EN ISO 11274 Soil quality - Determination of the water-retention characteristic - Laboratory

methods

Further references:

Möller, U., & Stelzmann, M. (2013). In-situ Messgerät für die zerstörungsfreie Messung der Wasseraufnahme. *2nd International Interior Insulation Congress 12th to 13th April 2013*, (pp. 186-197). Dresden.

Scheffler, G. A., & Plagge, R. (2010). A whole range hygric material mode: Modelling liquid and vapour transport properties in porous media. *International Journal of Heat and Mass Transfer*, pp. 286-296.

Testing principle (what is measured and how)

Moisture retention curve is measured via pressure plate apparatus. The pressure chamber vessel contains a saturated ceramic plate with a saturated kaolin-silt dust on top. The saturated material sample is placed on the dust and covered with a wet tissue. The kaolin-silt mixture improves the hygric contact between the sample and the ceramic plate. The bottom side of the ceramic plate includes an outlet. The apparatus is used to apply overpressure inside and the material samples are exposed to this overpressure from top through the surrounding air. The air is eliminating the water in the sample until capillary pressure in the sample is in equilibrium with induced air pressure. The sample water is able to release through the ceramic plate and through this outlet into a level drain when overpressure is added.

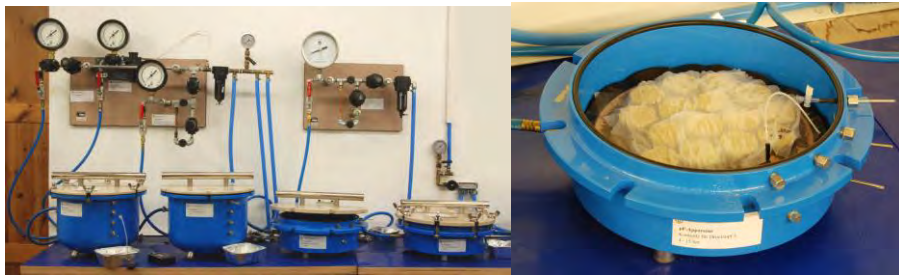

Figure 28. Left: Pressure plate chambers for pressures up to 0.5 MPa (high vessels on the left side) and up to 1.5 MPa (low vessels on the right side). Right: Open pressure chamber of up to 1.5 MPa with several covered specimen on a ceramic plate.

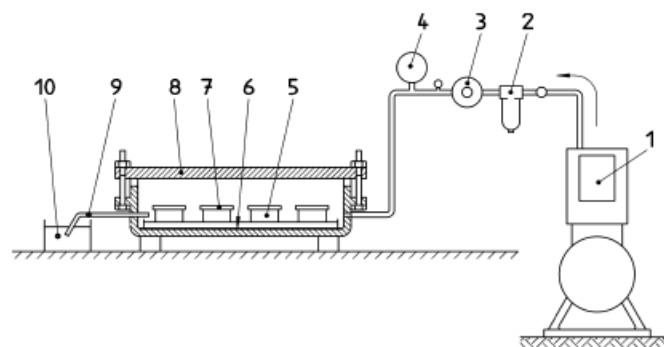

Figure 29. Pressure plate apparatus with pressure generator (1) and its equipment (2-4), material sample (5), ceramic plate (6), coverage (7), water outlet (9) and level drain vessel (10), Source: Möller & Stelzmann (2013).

Test samples

Cylinders (size depending on properties of material between 10 to 50 mm in height and 36-100 mm in diameter, moistened (period depending on material between 5-20 days), weighted and measured after preparation.

Testing conditions

Vessels and ceramic plates are selected in accordance to the final applied pressure due to the specific air entry value of the plates. A certain pressure is applied and remains constant until equilibrium is reached in the sample. This is measured via outgoing water mass. DIN EN ISO 11274 suggests a threshold value of 0.02% of the (initial) sample mass during two days (usually reached during two to four weeks).

Calculation procedure (including symbols and units)

Calculated liquid water content θ_l resulting from applied pressure:

$$\theta_l = \frac{m_e - m_d}{\rho_w \cdot V}$$

m_e = sample mass resulting from applied final pressure [kg]

m_d = sample mass at the initial state (dried) [kg]

ρ_w = density of liquid water [kg/m³]

V = volume of the sample [m³]

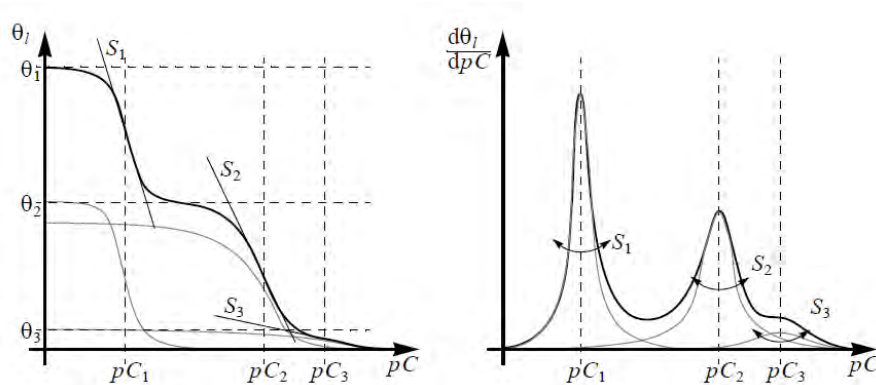

Figure 30. Moisture storage function (left diagram) and pore volume distribution (derivation of moisture storage function) as they can be directly derived from the measurements (Scheffler & Plagge, 2010).

Alternative procedure: See section 5.2.4 Moisture storage function (sorption and water retention) at TUD.

5.2 Deviations from standard measurement methods

This section includes descriptions of measurement methods used at RIBuild partners' laboratories, in those cases where the methods deviates from the standard methods described in Section 5.1.

5.2.1 Density and porosity at TUD

Material parameter to be determined: Density, ρ [kg/m^3 ; g/ml] and open porosity, P [%]

Name of the measurement method: Determination of bulk density and open porosity

Deviation from methods described in section 5.1.1 Density and 5.1.2 Porosity

Important deviations in this method compared with the standard method:

- More specific descriptions of number of samples
- Different temperatures for drying materials (not all at 105 °C)
- Higher demands for when dry weight is considered to be constant
- Saturation of samples is achieved under vacuum.

Reference to a valid international standard (including number) or other standard or reference

Laboratory methods – Description” by Rudolf Plagge, Dresden University of Technology, Germany, 2007.

Testing principle (what is measured and how)

Basic material properties, such as bulk density and open porosity are determined in the laboratory. The methods are to be used on porous building materials, e.g. concrete, ceramic bricks, and mortar. The density and porosity of materials are decisive for many factors, including strength, thermal properties, water transport and retention, etc. Therefore these basic parameters, density and porosity, are determined for the material characterization.

The bulk density is determined by the dry mass and geometric dimensions determined by means of a caliper. The open porosity is determined by vacuum saturation of the specimen, and the calculated volume.

Test samples

Bulk density: 18 samples of various sizes are used for determination of the bulk density.

Open porosity: 15 samples, preferably 10x10x5cm are used for the determination of open porosity.

Testing conditions

Initially, all specimens are subjected to hand craft procedures of metric measurements of the geometric sample dimensions, and thus the bulk volume can be calculated. Each dimension is measured twice, with a caliper of 1% precision. The bulk volume, V, is calculated based on the

average of these measurements.

The dry mass, m_d , of each specimen is determined by drying at a defined temperature; 105°C for ceramic bricks, 80°C for calcium silicate and 60°C for plaster. The mass is assumed constant when the difference between two successive weighings within 24 hours is less than 0.1 %.

Apparatus: Caliper; Drying oven; Balance with a precision of 0.0001 g; Desiccator; De-aired water; Vacuum pump

Calculation procedure (including symbols and units)

Bulk density: density of the whole material, and defined by the ratio of the mass of the dried solids to the bulk volume, including pore space.

Total porosity: the complete porosity of the specimen, defined by the ratio of pore volume to the total volume.

Symbol	Quantity	Unit
ρ_b	Bulk density	kg/m ³
m_d	Dry mass of sample	g
V	Bulk volume of sample	cm ³
φ_t	Total porosity	m ³ /m ³
m_w	Mass of water saturated specimen	kg
m_i	Mass of water saturated specimen immersed in water	kg
ρ_l	Density of water	kg/m ³
V_{op}	Calculated volume of specimen	m ³

Bulk density: The bulk density is solely calculated based on the bulk volume, and the dry mass.

Open porosity: The specimen is placed in a desiccator, which is slowly filled with de-aired water. A vacuum pump is used to evacuate the air, and the specimen is kept under water in the desiccator for >24 hours. The mass of the water saturated sample is registered, as well as the mass of the water saturated specimen immersed in water. When weighing the saturated specimen above water, excess water is wiped away with a damp cloth.

The bulk density, ρ_b :

$$\rho_b = \frac{m_d}{V} \cdot 1000 \quad (1)$$

Volume of the specimen based on experiment, V_{op} :

$$V_{op} = \left(\frac{m_w - m_i}{\rho_l} \right) \quad (2)$$

Open porosity, φ_o :

$$\varphi_o = \left(\frac{m_w - m_d}{\rho_l \cdot V_{op}} \right) \quad (3)$$

5.2.2 Water vapour diffusion (water vapour permeability) at TUD

Material parameter to be determined: Water vapour resistance factor, μ [-]

Name of the measurement method: Water vapour diffusion

Deviation from methods described in section 5.1.5 Vapour permeability

Important deviations in this method compared with the standard method:

- The method is described for a specific cup with PVC lid
- Higher demands for when dry weight is considered to be constant
- The used salts are different: Silica gel (5 % RH) dry cup experiments and KH_2PO_4 (monopotassium phosphate) (96% relative humidity) for wet cup experiments, therefore, the humidity levels are slightly different
- Slightly different formula to calculate saturated vapour pressure at a given temperature
- Different ways to calculate the water vapour resistance factor, including a correction factor not described in the standard method.

Reference to a valid international standard (including number) or other standard or reference

The water vapour permeability experiments, wet and dry cup, are based on EN ISO 12572, Hygrothermal performance of building materials and products – Determination of water vapour transmission properties (EN_ISO_12572, 2001). Furthermore, information from “Laboratory methods – Description” by Rudolf Plagge, Dresden University of Technology, Germany, 2007 (Rudolph Plagge, 2007) and the work of Scheffler, 2008, *Validation of hygrothermal material modelling under consideration of the hysteresis of moisture storage*. Dresden University of Technology, has been implemented.

Testing principle (what is measured and how)

Vapour permeability describes the property of water vapour penetration through a given material. Vapour diffusion through a material occurs due to vapour pressure differences on either side of the material. The method for determination of the parameter occurs at steady state flow conditions, which are obtained by creating a constant potential gradient on two sides of the material. These conditions are created by maintaining a constant temperature and defined relative humidities on either side of the test specimen.

Test specimens with defined surface areas and thicknesses are sealed to the open side of a

container. The container maintains a certain relative humidity on the inside, and the cups are placed in a climate chamber of constant relative humidity and temperature. The differential vapour pressure between the two environments instigate a vapour flow through permeable specimens, and by means of periodic weighings, the rate of water vapour transmission in the steady state can be determined.

The method can be conducted in two manners, wet and dry cup respectively. In the wet cup method, the relative humidity within the cup is kept higher than the climate chamber, and vice versa for dry cup measurements. For dry cup experiments, the cup contains a desiccant, and for wet cup experiments, the cup contains a saturated aqueous salt solution. The dry cup measurements represent a dry building material and the vapour transport inward in a building from a humid exterior, and the opposite direction for wet cup measurements.

Test samples

A minimum of three specimens per material, are tested. The specimens should be representative of the entire material. The specimens are cut in squares of 7x7cm and a thickness of at least 1cm. Prior to experiment, each dimension of every specimen is determined by calliper twice, and the average of each dimension is considered valid for the specimen.

The specimens are mounted in the fitting lid, and all edges are sealed with the vapour tight paraffin wax to ensure a one-dimensional vapour flow through the specimen. For the dry-cup experiment, the specimens are conditioned by drying in an oven until the difference in two successive weighings in 24 hours is less than 0.1%. The wet cup experiments are performed after the dry cup experiment, on the same specimens, and no conditioning is necessary.

Testing conditions

Initially the dry-cup experiment is performed. Each cup is filled with silica gel (5% relative humidity), the lid is placed and closed tightly with korasilon-paste. The distance between the silica gel and the bottom of the specimen (the lid) is measured. The cups are placed in a climate chamber with steady conditions of 35% relative humidity and 23 °C. The weight of each cup, as well as the relative humidity, temperature and baromatic pressure in the climate chamber, are registered on a regular basis, 3 times a week for a month.

The wet cup experiment follows the dry cup experiment. The lids and silica gel are removed from the cups, and the cups are cleaned. The cups are filled with a saturated aqueous salt solution of KH_2PO_4 (96% relative humidity), and the lids placed tightly on the cups, by means of korasilon-paste. The distance between the salt solution and the bottom of the specimen is noted. As in the dry cup experiment, the weight of each cup, as well as the relative humidity, temperature and baromatic pressure in the climate chamber, are registered on a regular basis, 3 times a week for a month.



Figure 31. Cups with specimens in climate chamber (left), and cup being weighed (right).

Apparatus

- Test cups, typically glass or metal (resistant to corrosion from salt solutions), with tight fitting PVC lids with sealed specimens, and korasilon paste (or similar) for sealing lid on cup
- Impermeable sealant that does not cause physical or chemical changes in the specimen, for sealing of the specimen in the lid. At TUD a paraffin wax with a high melting point is used.
- Caliper to measure specimen thickness, 0.1mm accuracy
- A balance with 0.001g resolution
- Climate chamber with capability of maintaining constant temperature ($\pm 0.5\text{K}$) and relative humidity ($\pm 3\%$) with monitoring of said values as well as barometric pressure. For constant values in the entire climate chamber, the air should be stirred at a low air velocity.
- Silica gel for dry cup experiments (5% relative humidity)
- KH_2PO_4 (monopotassium phosphate) for wet cup experiments (96% relative humidity)

Calculation procedure (including symbols and units)

Density of water vapour flow rate: mass of water vapour transferred through specimen per area and time.

Homogenous material: material which ability to transport water vapour does not vary on a macroscopic scale.

Water vapour diffusion resistance factor: The relation between water vapour diffusion coefficient of air and the tested material, of the same thickness and in the same temperature conditions.

Symbol	Quantity	Unit
μ_{mean}	Mean value of water vapour diffusion resistance factor	-
h	Average height of specimen	m
g	Water vapour diffusion flux	kg/(m ² ·d)
δ_l	Water vapour permeability of air with respect to partial vapour pressure	kg/(m·h·Pa)
$p_{\varphi,e}$	Partial vapour pressure in climate chamber	Pa
$p_{\varphi,i}$	Partial vapour pressure in cup	Pa
h_a	Height of air layer between specimen and salt solution	m
φ	Relative humidity	%
p_{sat}	Saturated vapour pressure	Pa
T	Temperature	°C
p_{ave}	Average barometric pressure measured in the climate chamber	hPa
Δm	Mass difference between two successive weighings	g
A	Surface area of specimen	m ²
Δt	Time difference between two successive weighings	d

There are several calculation steps that need be incorporated in the calculations of the μ -value, which is essentially obtained by the following equation (1);

$$\mu_{mean} = \frac{1}{h} \cdot \left(\left(\frac{\delta_l}{g_{mean}} \cdot (p_{\varphi,e} - p_{\varphi,i}) \right) - h_a \right) \quad (1)$$

The water vapour permeability of air in respect to the partial vapour pressure, δ_l , is calculated from the measured temperature in the climate chamber (eq.2);

$$\delta_l = 0.083 \cdot 1013.25 \cdot \left(\frac{T + 273}{273} \right)^{\frac{1.81}{462 \cdot (T+273) \cdot p_{ave}}} \quad (2)$$

The mean flux is calculated as the average of all fluxes obtained during the measurements. Each flux is calculated as follows (3);

$$g = \frac{\Delta m}{A \cdot \Delta t} \quad (3)$$

The partial vapour pressure, both on climate chamber and in the cup, is determined based on the temperature registered in the climate chamber (4);

$$p_{\varphi} = \varphi \cdot p_{sat} \quad (4)$$

And where the saturated vapour pressure is determined based on the measured temperature and following equation (5);

$$p_{sat} = 288.68 \cdot \left(1.098 + \frac{T}{100}\right)^{8.02} \quad (5)$$

5.2.3 Free water uptake at TUD

Material parameter to be determined

Water absorption coefficient (or capillary absorption coefficient) and capillary moisture content

Name of the measurement method: Determination of water uptake

Deviation from methods described in section 5.1.6 Free water uptake

Important deviations in this method compared with the standard method:

- The samples are oven-dried, temperature depending on material
- The specimens are preferably 4x4x5 cm
- The top surface is covered
- An automated weighing procedure
- Performed in a test chamber, ensuring high humidity around the sample contrary to normal lab conditions
- Introducing a correction factor not described in the standard method.

Reference to a valid international standard (including number) or other standard or reference

The determination of water uptake coefficient, A_w , is based on (“ISO 15148 Hygrothermal performance of building materials and products - Determination of water absorption coefficient by partial immersion,” 2002). The method is described in (Meissner, 2016). (Rudolph Plagge, 2007) has also been used.

Further references:

F. Meissner. 2016. *Water uptake coefficient of building materials*, Dresden University of Technology.

Feng C, Janssen H, Feng Y, Meng Q, 2015: Hygric properties of porous building materials: Analysis of measurement repeatability and reproducibility, *Building and Environment*, 85:160-172.

ISO 15148: 2002 *Hygrothermal performance of building materials and products - Determination of water absorption coefficient by partial immersion*.

R. Plagge. 2007. *Laboratory methods - Description*, Dresden University of Technology, 2007.

R. Plagge, G. Scheffler, J. Grunewald. 2005. Automatic Measurement of Water Uptake Coefficient of Building Materials, *Bauphysik*. 27, p. 315–323.

Roels S, Carmeliet J, Hens H, 2003: *HAMSTAD WPI final report – Moisture transfer properties*

and materials characterisation, KU Leuven, Leuven, Belgium.

Scheffler, G.A.. 2008. *Validation of hygrothermal material modelling under consideration of the hysteresis of moisture storage*, Dresden University of Technology, 2008.

Testing principle (what is measured and how)

Capillary absorption occurs in porous building materials subjected to liquid water, or above 95 % relative humidity. The absorption is driven by capillary forces in the pores, where the water moves under the hydraulic pressure. The water absorption coefficient indicates the rate of the capillary suction in the material. The method determines the short-term liquid water absorption coefficient, which indicates the liquid transport performance of the porous building material being tested.

The absorption coefficient is determined by a 1-dimensional free water uptake of a dry specimen placed upon a free water plane. The increased mass of the specimen is registered continuously at specific intervals. The bottom of the specimen is immersed in water, and the sides of the specimens are sealed to avoid absorption and evaporation from here. The slope of the first step of cumulative inflow curve as a function of the square root of time, defines the absorption coefficient, why the method requires graphical interpretation of the cumulative inflow curve. The method also yields results for the capillary moisture content of the specimens, which is the break point of the curve, and equal to the mean moisture content in the specimen.

Test procedure

After conditioning (see *Testing conditions*) the specimen is equipped with an evaporation protection foil on top, in order to prevent absorption of moist air from the climate chamber. However the cover must enable air pressure equilibration with the atmosphere, thus the seal should be perforated in some manner. An option is to seal the top halfway with scotch tape. The specimens are weighed again, for the initial mass, m_i .

The specimen is suspended in the purposely created system that hangs from a scale above. The system can be seen in **Figure 32**. The specimen is fixed in such a manner, that it is slightly tilted from the surface of the water, in order to avoid air under the specimen. A water tank is placed below the specimen, and filled until 2-3 mm below the specimen. The glass cover is put on the cabinet. The scale is connected to a data logger, which is initially set for logging every 3 seconds. As the logger is started, the water tank is lifted by turning the handle below the cabinet, such that the water level is ~2mm above the specimen surface. After 10 minutes the logging interval is increased to 1 minute, and after 30 minutes the interval is increased to 3 minutes. After 2 days the logging interval can be further increased to 5 minutes. The termination of the experiment is determined by the measurements; when little water uptake is identified and the measuring curve is nearly horizontal, the experiment can be ended. The termination time varies greatly due to the given material and specimen height, 2-14 days is regular.

At the end of the experiment, the saturated specimen is weighed for calibration purposes. The decrease in the water level of the tank also needs attention. The water uptake in the specimen is known, thus the decrease in the tank can be calculated. At the initiation of the experiment, the chamber is exposed to the room conditions with a lower relative humidity, and part of the water level decrease is caused by evaporation. This evaporation is measured prior to the experiment, and the balance records are adjusted accordingly.



Figure 32. System for automatic measurements of water uptake coefficient (Rudolf Plagge, Scheffler, & Grunewald, 2005).

Sources of error and the impact: The water level in the water bath decreases due to the water uptake in the specimen, as well as evaporation to the surrounding air. Past analysis has revealed that the difference in the height of the water level is 0.1-1mm, depending on the material and duration. An adjustment of height or permanent water supply in this range requires specific equipment, why the measurements are adjusted in calculations. The evaporation rate for the test setup at TUD has been measured to be 0.00055 g/s.

Test samples

A minimum of 3 test specimens should be tested. The specimens are preferably 4x4x5 cm. For some materials (mortar etc.) it might not be possible to obtain samples of this size, and smaller specimens can be used.

The dimensions of each test specimen, width, length and height is measured 1-4 times on each side. The average of these measurements constitutes the values used for calculation of the cross section area of the absorbing surface and the volume.

The Standard furthermore suggests maintaining the product's original height as sample height whenever possible. Although, a recent study (Feng et al, 2015) showed that very repeatable results can be obtained with (far) smaller bottom surfaces (32 cm² for the samples used in (Feng et al, 2015)), probably because of the use of more precise equipment for the weighing and measuring than imposed by ISO 15148. With respect to the samples' height, other studies Feng et al (2015 and Roels et al (2003) have opted for values that allowed reaching the second phase within a reasonable amount of time, while at the same time permitting to get a sufficient number of points in the first phase.

Testing conditions

Tests of the climatic conditions in the test chamber have revealed a relative humidity of nearly

100% and temperature around 22°C.

The specimens should be representative of the given material and with a constant cross section to ensure one-dimensional flow. The surfaces should also not contain irregularities.

The sides of the specimens are sealed with a water and vapour tight sealant that does not chemically react, or penetrate the specimen pores, e.g. epoxy resin and/or aluminium foil, thus only the top and bottom are free surfaces.

The specimens are dried in an oven, the temperature dependent on the material; 105° for bricks, 80°C for calcium silicate and 60°C for plasters, until the mass of each specimen has stabilized within 0.1% of its total mass within 24 hours. The dry mass of the specimens is registered. Hereafter, the specimens are kept in desiccators of 33% relative humidity for 14 days prior to the experiment, and the moisture content at this time is determined.

Apparatus

- Balance, capable of weighing test specimen to an accuracy of ± 0.01 g, with the possibility of hanging specimen and fixture below the balance and connection to data logger
- A special fixture for holding the sample and locating on the free water plane
- An insulated chamber with a vertically adjustable water bath and RH/T sensors
- Data logger and PC with logging software with variable measuring intervals from $t > 3$ s

Calculation procedure (including symbols and units)

Capillary water absorption coefficient

Mass of water absorbed by a test specimen per face area and per square root of time.

Capillary moisture content

Symbol	Quantity	Unit
θ_i	Initial moisture content	[g]
m_i	Initial mass	[g]
m_m	Mass of the evaporation protection	[g]
m_d	Dry mass of specimen	[g]
Δh	Height difference of water level	[m]
Δm	Current water uptake	[g]
A_{H_2O}	Surface area of the water bath	[m ²]
A_{PK}	Surface of the sample	[m ²]
F_{wa}	Total error of measurements	[g]
v_t	Evaporation rate	[g/s]
t	Duration of experiment	[s]
m_{corr}	Corrected measurement	[g]

m^*	Mass incl. initial water content	[g]
$\Delta m_{t,corr}$	Corrected value of water uptake pr. surface area of the specimen	[kg/m ²]
A_w	Water uptake coefficient	[kg/(m ² ·√s)]
θ_{cap}	Capillary moisture content	[m ³ /m ³]

The initial water content, θ_i , is calculated on the basis of the initial mass, m_i , the mass evaporation protection, m_m and the dry mass, m_d (1);

$$\theta_i = m_i - m_{st} - m_d \quad (1)$$

The errors in measurements are calculated by means of the following 3 equations:

The height difference of water level, Δh , is calculated by the following equation (2);

$$\Delta h = \frac{\Delta m}{A_{H_2O}} \cdot 10^{-6} \quad (2)$$

The error of the scale measurements, with the inclusion of the evaporation rate from the water bath, F_{wa} , is calculated by the following equation (3);

$$F_{wa} = ((v_t \cdot t) + \Delta m) \cdot \frac{A_{PK}}{A_{H_2O}} \quad (3)$$

The corrected measured value, therefore becomes (4);

$$m_{corr} = m^* - F_{wa} \quad \text{where } m^* = m + \theta_i \quad (4)$$

The water uptake pr. surface area at the various times, $\Delta m_{t,corr}$, can be defined (5), such that the results can be expressed graphically as the water uptake per area over the square root of time.

$$m_{t,corr} = \frac{m_{corr}}{A_{PK} \cdot 1000} \quad (5)$$

As $m_{t,corr}$ is plotted against the square root of time, a function similar to the curve represented below in Figure 33 will be generated for homogenous materials. The slope of the initial period of stabilization represents the water uptake coefficient, A_w , and the capillary moisture content, θ_{cap} , is taken as the moisture content where the slope breaks, or at the end of the experiment. By means of regression lines for the two phases, and the intersection point, the time for the break point can be determined.

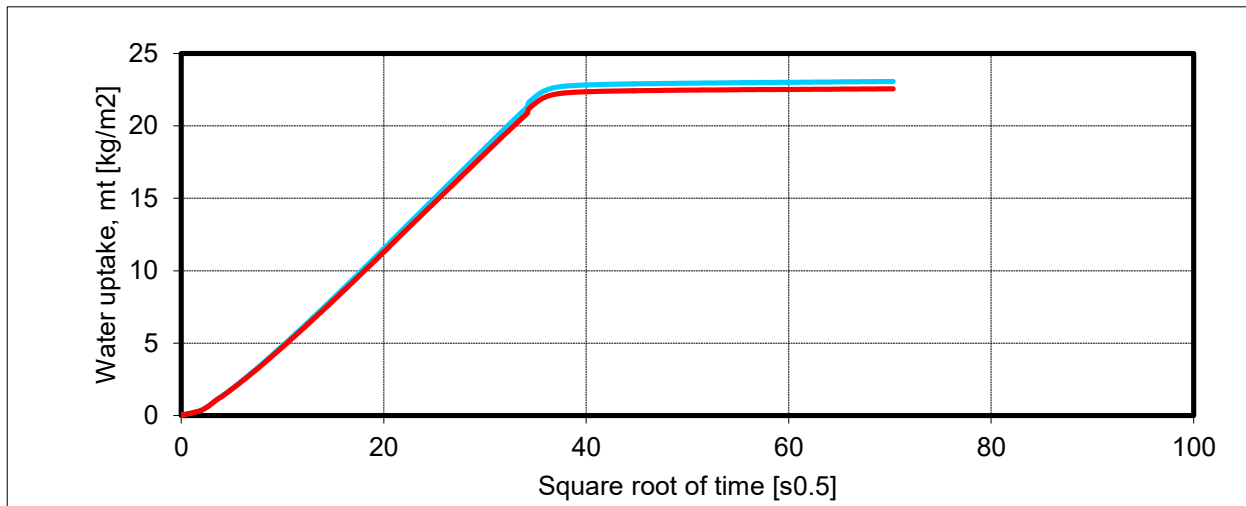

Figure 33: Example of water uptake curve for a homogenous material, both from direct measurements (blue) and corrected measurements (red)

The water uptake coefficient, is calculated from the time at which the curve breaks and the water uptake becomes constant or nearly constant, and the corresponding $m_{t,corr}$, as in (6);

$$A_w = \frac{m_{t,corr}}{\sqrt{t}} \quad (6)$$

The capillary moisture content is calculated at the same time as the water uptake coefficient, by the corrected measured mass and the volume, as expressed in (7);

$$\theta_{cap} = \frac{(m_{corr}/1000)}{\sqrt{t}} \quad (7)$$

5.2.4 Moisture storage function (sorption and water retention) at TUD

Material parameter to be determined:

Hygroscopic range; Over hygroscopic range; Sorption curve; desorption curve.

Name of the measurement method

The experiments for sorption (hygroscopic range) and water retention (over hygroscopic range)

Deviation from methods described in section 5.1.8 Moisture storage function (sorption curve) and 5.1.9 Moisture storage function (suction curve)

Important deviations in this method compared with the standard method:

- The same samples are used for both methods; therefore, they are treated as one method.
- Deviations are small, the descriptions could be seen as examples of how the standard method can be interpreted in practice

Reference to a valid international standard (including number) or other standard or reference

The experiments for sorption (hygroscopic range) are based upon EN ISO 12571:2013 Hygrothermal performance of building materials and products – Determination of hygroscopic sorption properties, (2013). The water retention (overhygroscopic range) characteristics are based on EN ISO 11274 Soil quality - Determination of the water-retention characteristic – Laboratory methods, (2014). Information from Scheffler (2008) has been included as well as information from (Rudolph Plagge, 2007) and Roels et al. (2010).

EN ISO 11274 Soil quality - Determination of the water-retention characteristic – Laboratory methods. (2014).

EN ISO 12571:2013 Hygrothermal performance of building materials and products – Determination of hygroscopic sorption properties. (2013).

Plagge, R. (2007). Laboratory methods - Description.

Roels, S., Talukdar, P., James, C. & Simonson C.J.. (2010) Reliability of material data measurements for hygroscopic buffering, *Int. J. Heat Mass Transf.* 53 (2010) pp.5355-5363.

Scheffler, G. A. (2008). Validation of hygrothermal material modelling under consideration of the hysteresis of moisture storage. Dresden University of Technology.

Testing principle (what is measured and how)

Moisture storage characteristics comprise of information in both the hygroscopic and over-hygroscopic area. Determination of the characteristics therefore consists of different procedures for each range. The desiccator method is used for determination of sorption properties in the hygroscopic range. The method for sorption isotherm (de- and adsorption) prescribes the determination of moisture content of a sample in equilibrium with air at a specific temperature and humidity. The pressure plate method is used for determination of water retention characteristics – implicit the moisture storage within the overhygroscopic range. The method includes desorption by means of draining samples with applied pressure.

Over-hygroscopic range: The overhygroscopic range is defined above 95 or 98% relative humidity. Liquid water transport dominates the moisture transport by vapour diffusion. Described by:

- **Pressure plate method:** Each specimen endures the pressure plate method at 3-8 different pressures.

Hygroscopic range: The hygroscopic range is defined between 0% and 95 or 98% relative humidity. In this range, vapour transport is the dominant moisture transport mechanism. Described by:

- **Sorption curve:** curve established at a series of increasing equilibrium relative humidities at a given temperature
- **Desorption curve:** curve established at a series of decreasing equilibrium relative humidities at a given temperature

Both curves are determined by the *Desiccator method*

Testing principle: Pressure plate method

The pressure plate method functions as a desorption measure for specimens by means of external overpressure draining the pores of a sample. Saturated specimens are placed on a ceramic plate (various plates at different pressures), and a contact material (e.g. silt/kaolin mixture or filter paper) provides optimal contact between specimen and ceramic plate. The plate and specimens are placed in a pressure chamber/pressure plate extractor, and pressure is supplied. The specimens are drained by the pressure, and mass of each specimen is determined when equilibrium is reached.

The pressures applied at TUD and corresponding ceramic plates are presented below in Table 8

Table 8: Possible pressure steps at TUD and corresponding ceramic plates used that are available at TUD

Pressure applied [hPa]	30	100	300	900	2000	4000	8000	15000
Ceramic plate [bar]	0.5	0.5	0.5	1	3	5	15	15
Experiment duration [weeks]	1	1	3	4	4	4	4	4

The ceramic plates are saturated for 5 days in a free water bath, and for 2 days with applied negative pressure, displayed in Figure 34, left. Kaolin-salt mixture is applied to the ceramic plate and sprayed with water (Figure 34 right), whereafter the conditioned specimens are placed on the ceramic plate. The ceramic plate (or plates – the pressure chamber holds up to three plates in layers) is placed in the pressure chamber. Each layer of specimens/plates is covered by a wetted towel (Figure 35 left). The pressure chamber is closed tightly (Figure 35 middle), and the given pressure applied (Figure 35 right).



Figure 34: Conditioning of pressure plates prior to experiment with negative pressure (left) and preparation of ceramic plate with kaolin salt-mixture and water (right)



Figure 35: Specimens in pressure plate apparatus, covered by wetted towels (left), the lid of the pressure plate apparatus being sealed tightly (middle), and pressure being applied to the system (right)

Testing principle: Desiccator method

After the pressure plate method, the specimens are weighed, and placed in desiccators for desorption. Specimens in a desiccator can be seen in Figure 36. A minimum of 4 specimens are placed in each of the following desiccator environments; high, medium and low RH. After 4 weeks, or when equilibrium is reached, the specimens are moved to desiccators with lower relative humidity. An example of this course is presented in Table 9 below;

Table 9: Rotation of specimens, in various humidity conditions. The defined relative humidities are based on a temperature of 23°C.

	Initial environment	2nd environment	3rd environment
High RH	97.4% K ₂ SO ₄ (Potassium sulfate)	96.0% KH ₂ PO ₄ (Monopotassium phosphate)	90.0% BaCl ₂ (Barium chloride)
Medium RH	84.7% KCl (Potassium chloride)	74.7% NaCl (Sodium chloride)	58.2% NaBr (Sodium bromide)
Low RH	43.2% K ₂ CO ₃ (Potassium carbonate)	32.9% MgCl ₂ (Magnesium chloride)	



Figure 36: Desiccator with specimens

Sorption: The specimens are after pressure plate experiment, concealed in desiccators with a series of various relative humidity (minimum 4 of these conditions; 6.5%, 11.3%, 22.8%, 32.9%, 43.2%, 58.2%, 75.4%, 84.7%, 90.0%, 94.0%, 96.0%, 97.4%) determined by the salt solution in the desiccator. The desiccator is placed in a room with steady temperature conditions. Initially desorption is made, and specimens are initially placed in an environment with high relative humidity. The moisture content in the specimen is determined by weighing as equilibrium with each environment is reached. Equilibrium with the environment is established by weighing the specimen until constant mass is reached, defined by a mass change of less than 0.1% within 24 hours – usually 2-4weeks. At this time, the specimens are moved to decreased relative humidities, and the procedure repeated. After desorption, adsorption is made by the same procedure, but increasing relative humidity.

Test samples

20-40 specimens are used for the determination of sorption and retention. A minimum of 6 specimens should be used for each step of the pressure plate to be performed. For the desiccator method, a minimum of 8 specimens should be used pr. class of relative humidity, which constitutes a total of 24 specimens. The specimens are flat and 1cm in height, and either round Ø5cm or square 4x4cm.

Prior to pressure plate experiment, the specimens are saturated for 1 month. The saturation of the specimens is obtained by partially immersing them in water, and placing them flat on a ½ bar ceramic pressure plate, as seen in Figure 37.



Figure 37: Saturation of specimens on ½ bar ceramic plate, partially immersed in water

The specimen dimensions are determined individually by caliper measurements; each dimension is determined twice, and the average of these measurements constitutes the values used for calculations of the volume.

Testing conditions

Apparatus

- Caliper of 0.01mm precision

Pressure plate method:

- A set of mid- and high-range pressure chambers (0.1-1500kPa)
- Ceramic pressure plates with various bubbling pressures; 5, 10, 20, 30, 50 and 150 hPa

- A gas pressure supply system with regulation, capable of pressure regulation between 0.01-150 hPa
- Kaolin-salt mixture for hydraulic contact
- Wet towels

Desiccator method:

- Weighing cups that do not absorb water, and with tight-fitting lids
- Balance, capable of maintaining the relative humidity within $\pm 0.01\%$ of the mass of the test specimen
- Drying oven
- Desiccator, capable of maintaining the relative humidity within $\pm 2\%$ relative humidity
- Constant-temperature chamber, capable of maintaining the specified test temperature to an accuracy of $\pm 0.5\text{K}$
- Salt solutions for keeping various relative humidities, as described in
- Table 10 below;

Table 10: Aqueous salt solutions and corresponding relative humidities

Salt solution	K ₂ S O ₄	KH ₂ P O ₄	KN O ₃	Ba Cl	KC L	Na Cl	Na Br	K ₂ C O ₃	MgC l ₂	CH ₃ CO OK	Li Cl	LiB r
RH [%]	97,4	96,0	94,0	90,0	84,7	75,4	58,2	43,2	32,9	22,8	11,3	6,5

Calculation procedure (including symbols and units)

Symbol	Quantity	Unit
θ	Water content	m^3/m^3
m_{pc}	Mass of test specimen at pressure pc	g
m_{φ}	Mass of test specimen at relative humidity φ	kg
m_d	Mass of dried test specimen	g
V	Volume of specimen	cm^3
ρ_w	Density of water	kg/m^3

Pressure plate method: For the pressure plate method, the water content [m^3/m^3] is determined for every given pressure applied, by means of the following formula (1), resulting in the arguments for the water retention (desorption);

$$\theta_{pc} = \frac{m_{pc} - m_d}{V} \quad (1)$$

The average values at each pressure steps, as well as standard deviation, maximum and minimum values are applied in the summary for the material characterization.

Desiccator method: In the desiccator method, the water content is determined by (2);

$$\theta_{\varphi} = \frac{m_{\varphi} - m_d}{V} \quad (2)$$

The average values at each step of relative humidity, as well as standard deviation, maximum and minimum values are applied in the summary for the material characterization.

The water content, θ [m^3/m^3] at the various pressures for pressure plate method, and relative humidities for desiccator method, are expressed by as a function of the obtained values at the various steps in pressure or relative humidity respectively.

5.2.5 Moisture storage function (sorption and adsorption)

Material parameter to be determined: Adsorption curve and desorption curve

Name of the measurement method:

The experiments for sorption (hygroscopic range)

Deviation from methods described in section 5.1.8 Moisture storage function (sorption curve)

Important deviations in this method compared with the standard method:

- The set-up of the desiccator method is basically the same, and the method is therefore not described further.
- Instead of measuring all humidity levels on the same samples, similar samples are placed in parallel in desiccators in which certain relative humidity is maintained by different saturated salt solutions for each until equilibrium is reached.
- For determination of scanning curves (hysteresis) the same samples can be used further: All the samples are moved to desiccators with higher or lower relative humidity consecutively.

Reference to a valid international standard (including number) or other standard or reference:

See section 5.1.8 *Moisture storage function (sorption curve)* and 5.2.4 *Moisture storage function (sorption and water retention) at TUD*

5.2.6 Airflow resistance

Name of the measurement method: Air permeability, K_p [m^2] and airflow resistance, r [$\text{Pa s}/\text{m}^2$]

Material parameter to be determined: Airflow resistance

Deviation from methods described in section 5.1.7 Air permeability

Important deviations in this method compared with the standard method:

- The size of instrument and therefore sample size differs (are larger) from the standard method

Reference to a valid international standard (including number) or other standard or reference

EN 29053: 1993 Acoustics – Materials for acoustical applications – Determination of airflow resistance

Testing principle (what is measured and how)

This standard describes two methods for the determination of the airflow resistance of porous materials for acoustical applications. The direct airflow method (Method A) is used. A controlled unidirectional airflow is passed through the test specimen mounted in a rectangular parallelepiped and the pressure drop between the two free faces of the test specimen is measured.

Test samples

The width and length of the measurement cell of the SP equipment is 400x400 mm. The thickness (or length) of the test specimen shall be chosen to obtain pressure drops measurable under optimum conditions and to suit the usable depth of the measurement cell. At least three samples, from each of which three specimens shall be cut. Up to five test specimens, chosen in the same way, can be superimposed if the thickness of available specimens is not sufficiently thick.

Testing conditions

A controlled unidirectional airflow through the test specimen. Apart from the size of the test specimen, the airflow rate and air pressure difference, test conditions such as temperature and relative humidity are not specified in the standard.

Two measurements are sufficient to ensure that the relation between the pressure drop and the air flow through the metering area is a straight line that goes through origin.

Calculation procedure (including symbols and units)

If the material is considered homogenous, the airflow permeability K_P [m^2] is given by:

$$K_P = (Q_{VA} \cdot L \cdot \mu) / (\Delta P \cdot A) \quad (1)$$

and airflow resistance r [Pa s/m^2] is given by:

$$r = \mu / K_P \quad (2)$$

where:

Q_{AV} = average volumetric flow rate of air through the specimen [m^3/s]

ΔP = pressure drop across the specimen [Pa]

L = specimen length (or thickness) [m]

A = specimen cross-sectional area [m²]

μ = viscosity of air at the test temperature [Pa·s]

5.3 Other methods for determination of material parameters

In addition to the standard measurement methods, other methods for determination of material parameters are described in this section. This includes derived or reduced methods and methods applied on-site. Focus is on methods relevant for historic building materials for external walls and insulation materials for internal insulation.

5.3.1 Heat capacity and thermal conductivity at TUD

Material parameter to be determined: Heat capacity and thermal conductivity

Name of the measurement method: Determination of heat capacity and thermal conductivity (ISOMET method)

Reference to a valid international standard (including number) or other standard or reference

No standard method is used for the determination of specific heat capacity and thermal conductivity, but the heat pulse technology is used at TUD, by means of ISOMET equipment.

Testing principle (what is measured and how)

The specific heat capacity of a material defines how much energy can be stored per kg material and degree Kelvin. This generally means the amount of energy needed to increase the temperature 1 degree for 1 kg of material. The thermal conductivity on the other hand, indicates the amount of heat that can be transported through a defined material thickness along a defined temperature gradient. Hence, the ability of the material to conduct heat. By means of the heat pulse technology and ISOMET equipment, both parameters can be determined simultaneously.

By means of dynamic cycles of heating and cooling impulses sent through a probe placed flatly on the specimen, and periodic temperature readings, the specific heat capacity and thermal conductivity can be determined.

Test samples

Specimens for the ISOMET measurements are 7x7cm, and 1-1.5cm high. Each specimen is measured with a caliper of 0.001mm precision twice on every side, and the average dimensions are used for determination of the volume.

The specimens are dried in an oven until a constant mass occurs (defined as the difference between two successive weighings in 24 hours is less than 0.1%). The temperature in the drying oven depends on the material (bricks: 105°C, calciumsilicate: 80°C, and plasters: 60°C). The specimens are weighed for determination of the dry mass. After drying, the specimens are placed in a

desiccator with silicagel for cooling.

Testing conditions

The ISOMET 2104 has various probes, for different ranges of thermal conductivity. The probe is placed flat on the specimen, inside the desiccator, as seen in Figure 38. The cable connecting the probe and the ISOMET goes through a fitted hole in the cork in the top of the desiccator to avoid mixing the desiccator climate to the laboratory climate conditions. The ISOMET makes the first measurement, and the results for specific heat capacity and thermal conductivity are noted. The probe is moved twice, and two other measurements are made. The measurements are made in the middle of the specimen, and on both right and left side.

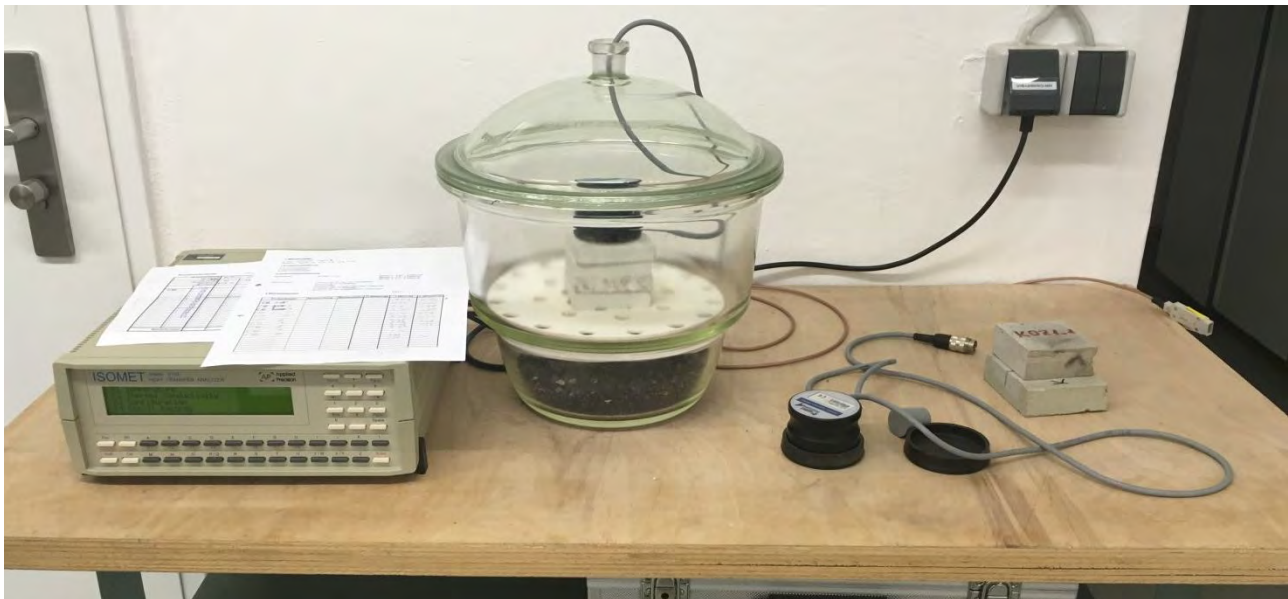

Figure 38: Experimental setup with ISOMET and specimen in desiccator

- **Apparatus:** ISOMET 2104, incl. a variety of probes, Desiccator, Silicagel

Calculation procedure (including symbols and units)

Symbol	Quantity	Unit
c_{iso}	Specific heat capacity, from ISOMET	J/(m ³ ·K)
V	Volume of specimen	cm ³
m_{dry}	Dry mass of specimen	g
ρ_{bulk}	Bulk density of specimen	kg/m ³
c	Specific heat capacity	J/(kg·K)
λ_{dry}	Thermal conductivity of the dry material	W/(m·K)

The ISOMET gives direct results for the thermal conductivity, but the specific heat capacity gained from the equipment, is volumetric. To convert the unit to mass, the bulk density is applied (1);

$$\rho_{bulk} = \frac{m_{dry}}{V} \cdot 1000 \quad (1)$$

Thereby the conversion of the specific heat capacity can be applied (2);

$$c = \frac{c_{iso}}{\rho_{bulk}} \quad (2)$$

5.3.2 Dynamic Vapour Sorption (DVS)

Material parameter to be determined: Adsorption and desorption curves and possible hysteresis (scanning curves)

Name of the measurement method: Dynamic Vapour Sorption (DVS)

Reference to a valid international standard (including number) or other standard or reference

The method is an alternative to standard method described in section 5.1.8 *Moisture storage function (sorption curve)* and the deviations described in sections 5.2.4 *Moisture storage function (sorption and water retention) at TUD* and 5.2.5 *Moisture storage function (sorption and adsorption)*

The principles are described in:

R. Peuhkuri, C. Rode, K.K. Hansen, Effect of method, step size and drying temperature on sorption isotherms, in: 7th Nordic Symposium on Building Physics. Reykjavik, Iceland, 2005, pp. 31-38.

Testing principle (what is measured and how)

A standard sorption equipment (IGAsorp) is used. The IGAsorp is a climatic chamber with a sensitive microbalance, which continuously registers the weight of a sample together with the temperature and relative humidity around the sample. Similar to the standard method described in section 5.1.8 *Moisture storage function (sorption curve)*, but automated; the IGAsorp is closed during the whole procedure.

First the sample is dried at 20 °C under flowing nitrogen, until the weight is constant at RH<1%.

Determination of the adsorption curve follows by raising RH in steps of 5 % RH, while temperature and RH is held constant until the sample equilibrium or until a given time is exceeded. Then next step can follow. When 95 % RH is reached, the determination of the desorption curve starts. The steps are similar now with decreasing RH.

Test samples

Only one test sample is necessary.

Testing conditions

The takes place in a climatic chamber with constant temperature and where changes in relative humidity are automated

Calculation procedure (including symbols and units)

The IGAsorp provides a sorption curve directly.

5.3.3 Boltzmann transformation of water content profiles

General principles

While the standard free water uptake test (see section 5.2.3) allows for an approximate or indirect estimation of the moisture diffusivity, a more accurate characterisation can be obtained based on water content profiles characterised during the uptake test. Characterisation of such moisture content profiles is possible with several techniques, such as: X-ray attenuation, γ -ray attenuation, magnetic resonance, time domain reflectometry, ..., which are presented and compared in Roels et al. (2004). The explanation below focuses on visualisation of transient moisture content profiles with the X-ray attenuation method and the subsequent processing to obtain the liquid diffusivity and liquid permeability.

The visualization requires the execution of a free water uptake test inside an X-ray apparatus, during which instantaneous moisture content profiles are determined at different times during the experiment. The profiles are subsequently translated to a so-called lambda profile, by Boltzmann-transforming the x-coordinate to the x/\sqrt{t} -coordinate (Carmeliet et al., 2004). After smoothing, the liquid diffusivity can be obtained via integration and differentiation of the lambda-profile, and that can finally be translated to the liquid permeability by multiplication with the moisture capacity. Therefore, for that last step, the moisture storage characteristic needs to be known.

Sample preparation

With respect to sample preparation, much of the guidelines related to the free water uptake test (see section 5.2.3 *Free water uptake at TUD*) remain valid. However, typically the equipment used for moisture content characterisation imposes restrictions or prescriptions for the sample size, and hence no strict values can be set. For the X-ray attenuation equipment illustratively applied here, an optimal thickness can be defined in order to obtain the largest moisture content resolution (Roels & Carmeliet, 2006). For example, for ceramic brick – dense – and calcium silicate insulation – less dense – optimal thicknesses of respectively 6 to 13 mm and 40 to 60 mm are suggested (Roels & Carmeliet, 2006). Regarding the sample height and width, the X-ray detector's limited size of dictates sample dimensions below 10 cm (**Figure 39**). It is thus evident that the recommended values for minimal bottom surface (see section 5.2.3) cannot be maintained. Furthermore, sample heights should be chosen such that measurements can be done within a reasonable time while still allowing to obtain sufficient radiographic images.

Measurement principle

An oven-dried sample is placed inside the X-ray chamber. The energy of the X-rays is adjusted, in order to obtain the optimal resolution (Roels & Carmeliet, 2006) . Initially, an image of the sample in its dry state is taken, after which the sample is brought in contact with water to start the free water uptake. The transient moisture content profiles are recorded by taking images at sequential time points. When the moisture front reaches the top of the sample, the measurement is stopped and the mass of the wet sample is determined. From that mass, the capillary moisture content in the sample can be (approximately) derived, which allows for a verification of the obtained moisture content profiles.

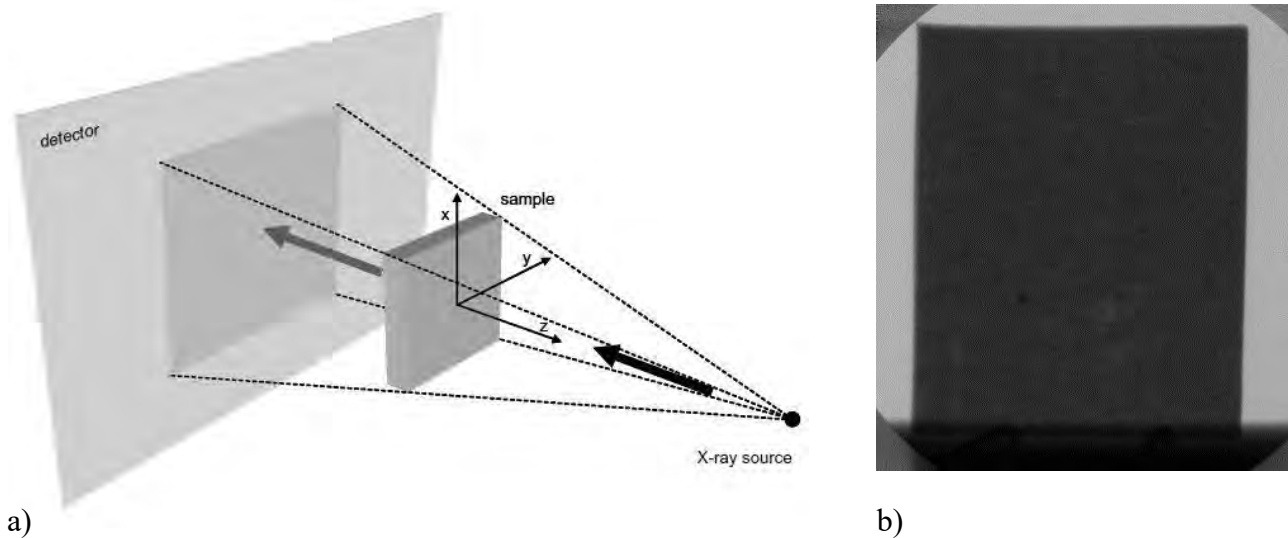

Figure 39. a) Schematic overview of the experimental set-up of the X-ray projection method (Roels & Carmeliet, 2006); b) example of a radiograph image showing that the full sample should be captured by the detector

Processing of results

Following (Roels & Carmeliet, 2006), the delivered X-ray intensity I_0 and the transmitted X-ray intensities I_{dry} and I_{wet} of the dry and the moist sample respectively follow Beer's Law, and can be expressed as:

$$I_{dry} = I_0 \exp(-\mu d) \quad (1)$$

$$I_{wet} = I_0 \exp(-\mu d - \mu_w d_w) \quad (2)$$

where μ [-] and μ_w [-] are the attenuation coefficients of the dry material and absorbed liquid, d [m] is the thickness of the sample and d_w [m] represents the thickness of fictitious liquid layer, equivalent to the liquid content in the material (**Figure 40**).

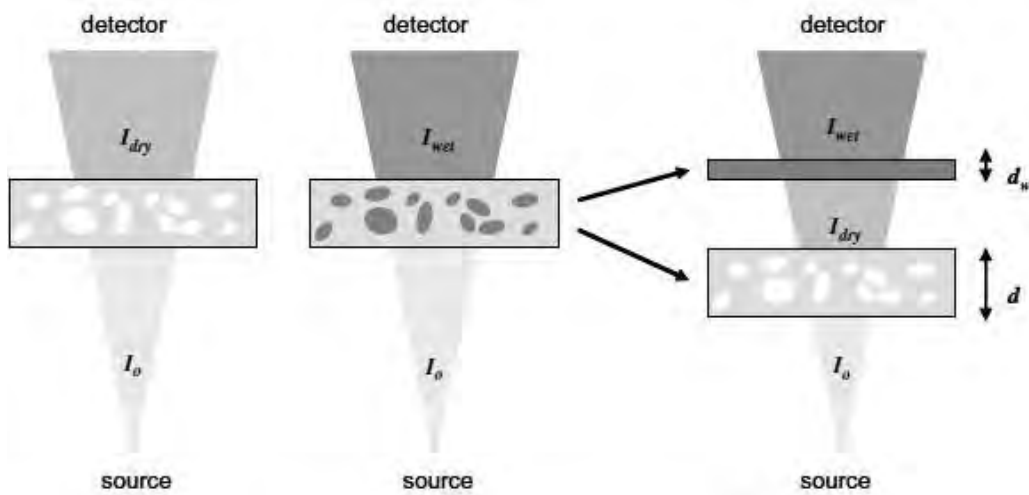

Figure 40. Illustration of Beer's law for the determination of moisture contents by X-ray attenuation (Roels & Carmeliet, 2006)

The moisture content at any position can be determined by subtracting the image of the dry state from the image of the moisture state:

$$w = -\frac{\rho_w}{\mu_w d} \ln\left(\frac{I_{wet}}{I_{dry}}\right) = -\frac{\rho_w}{\mu_w d} (\ln(I_{wet}) - \ln(I_{dry})) \quad (3)$$

with w [kg/m^3] and ρ_w [kg/m^3] the moisture content and the density of absorbed water respectively.

Once the transient moisture content profiles are determined (Figure 41a), the Boltzmann transformation can be applied to transform all measured data into one single curve, known as the lambda profile or 'w- λ curve' (Figure 41b), with $\lambda = x/\sqrt{t}$ [$\text{m}/\text{s}^{0.5}$]. The liquid diffusivity D [m^2/s] and liquid permeability K [s] in function of moisture content can be then finally be calculated as Carmeliet et al. (2004) and Carmeliet & Roels (2001) (Figure 42):

$$D(w) = -\frac{1}{2} \frac{\int_{w_0}^w \lambda du}{\frac{\partial w}{\partial \lambda}} \quad (4)$$

$$K(w) = D(w) \left| \frac{dw}{dp_c} \right| \quad (5)$$

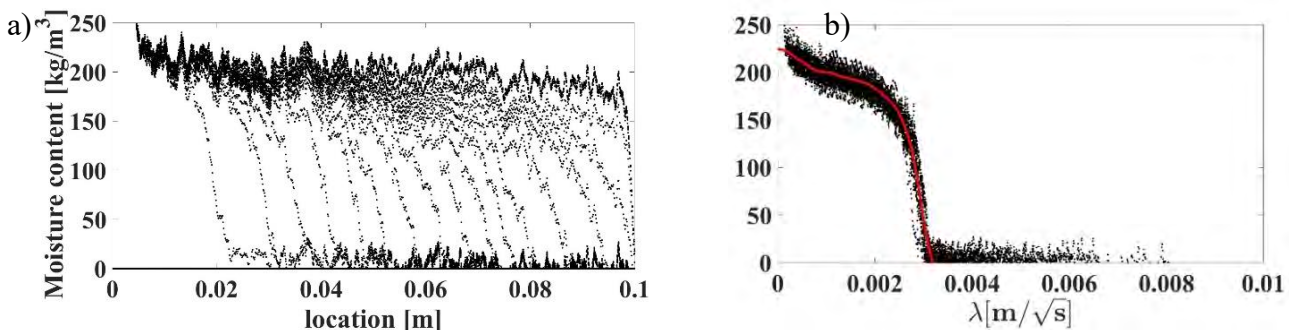

Figure 41. a) moisture content profiles at different time steps during free water uptake test in ceramic brick; b) lambda profile after applying the Boltzmann's transformation on data from a), smoothed profile in red

However, before applying equations (4-5), several considerations need to be taken into account. Firstly, to allow application of the Boltzmann transformation, constant initial and boundary conditions are necessary. The constant initial condition is typically obtained by making use of an initially oven-dry sample. A constant boundary condition moisture content is usually not clearly obtained and in general an assumption has to be made Carmeliet et al. (2004): vacuum saturation moisture content w_{sat} , capillary moisture content w_{cap} , or a fictitious moisture content in between these two. The choice is discussed in detail in the literature Carmeliet et al. (2004) and Carmeliet & Roels (2001) and is not further elaborated here. It is however important to note that regardless of the choice of a boundary moisture content, the diffusivity for moisture content values above the capillary moisture content should be omitted. Moreover, for heterogeneous materials, scatter may be present in the lambda profile, which can be alleviated by smoothing, averaging, curve fitting, ... More details on possible smoothing measures can equally be found in Carmeliet et al. (2004) and Carmeliet & Roels (2001). **Figure 41b** shows the original scattered lambda profile in black, and the final smoothed curve in red. It should finally be noted that the surface contained under the lambda profile should be equal to the capillary absorption coefficient of the material, which is a good way to check the validity of the outcomes.

One should finally be aware that the conversion of diffusivity to permeability commonly leads to a non-monotonous permeability curve, which drops off near to the capillary moisture content. This flaw is typically corrected by maintaining the maximum permeability beyond the drop-off moisture content (**Figure 42b**).

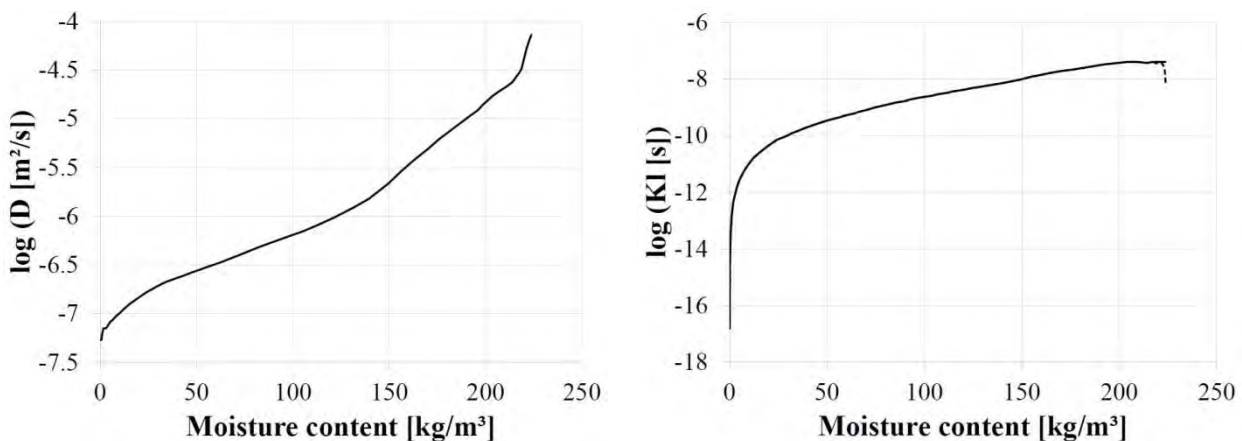

Figure 42. a) Liquid water diffusivity derived from the results in Figure 3; b) Liquid water permeability derived from the results in Figure 41; the dashed and full curve represent respectively the original and the corrected result.

5.3.4 Non-isothermal testing of combined vapour and liquid transfer

Some experiments could additionally be derived to characterize the moisture transport in certain moisture content ranges and to support the identification of transport parameters. The drying experiment is suitable to get information about the lower overhygroscopic range. The saturated and unsaturated flow experiments are suitable for the evaluation of the higher overhygroscopic range. Both experiments are not subject of any standard and are not overall described in publications.

The drying experiment starts with a saturated material sample which is sealed at the sides. The sample is stored in a certain environmental condition while its weight change over time is recorded. Moisture emission from the wet sample surface to the environment happens via evaporation from the sample surface. Normally two phases are passed off during this experiment. Starting with the saturated sample the liquid water within the sample is conducted to the surface where it evaporates (1st phase). During this phase, drying rate is supposed to be constant with a linear relationship between time and weight loss. The slope of this line is preferential influenced by the vapour transfer coefficient. This coefficient depends strongly on the material texture and flow conditions at the sample surface. If a certain moisture content in the sample is undercut (2nd phase), evaporation is already happening in the material and vapour flux is transported to the sample surface and then to the surrounding air. In this phase drying rate is much lower and mainly influenced by the liquid water conductivity of the material.

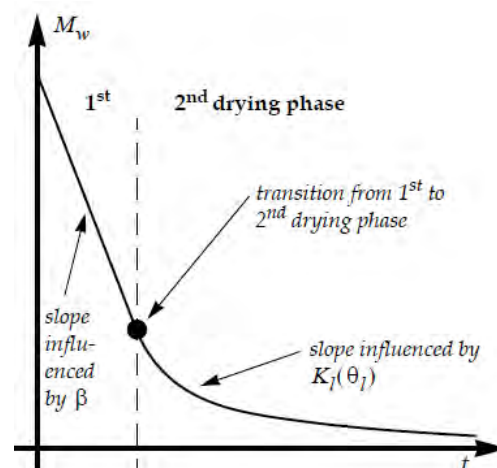

Figure 43. Liquid water mass (M_w) loss in the sample over time t during the drying experiment, distinction into 1st and 2nd phase. Source: Scheffler (2008).

Aspects like the transfer conditions (e.g. surface properties, boundary conditions) influence the measurement results and especially the impact of evaporation cooling at the surface strongly. For that reason, Scheffler (2008) initiated an improved drying apparatus design which allows the provision of completely defined and thus reproducible boundary conditions. It features an air flow channel with ventilators, surface temperature sensors, boundary conditions sensors and removable drawers for the material samples.

Name of the measurement method: TUD Method Drying

Material parameter to be determined: The water vapour transfer coefficient β

Reference to a valid international standard (including number) or other standard or reference

Drying experiments performed at TUD are not based on a standard. The following information is based on the work by Scheffler (2008), and experience from the TUD laboratory. A detailed explanation of this apparatus and the procedure to identify a drying coefficient are explained in Scheffler, 2008.

G.A. Scheffler, *Validation of hygrothermal material modelling under consideration of the*

hysteresis of moisture storage, Dresden University of Technology, 2008.

Testing principle (what is measured and how)

Drying experiments can give information about the moisture transport properties in the lower part of the overhygroscopic moisture content range. The results from the drying experiments are included in material functions for DELPHIN.

Saturated specimens that are sealed to the sides are exposed to certain boundary conditions, and the weight of each specimen is registered at various time intervals, as the drying occurs, and the moisture content reduces. By monitoring the boundary and surface conditions, the water vapour transfer coefficient, β , can be determined.

Test samples

The saturated specimens are taken directly from the water uptake experiment; min. 3 specimens of dimensions 4x4x5cm. The evaporation protection foil on the surface is removed, and the initial weight can be determined.

Testing conditions

The specimens are placed in the drawer fitted for the climate chamber, and the cover is made to fit the size of the specimens, so just the surface area is exposed to the boundary conditions. The drawer is adjusted in such a manner, that the specimen surface is aligned with the top of the drawer (this ensures the connection to the surface temperature sensor), see Figure 44, left. The drawer is placed in the climate chamber, and the surface temperature sensors are pushed down for contact.



Figure 44: Adjustment of the drawer for the specimens (left), and drawer with specimens placed in climate chamber, and surface temperature sensors in place.

When registering the weight of the specimens, the surface temperature sensors are pulled up, the drawer removed and the specimens weighed. The first 2 hours, the specimens are weighed every 30 minutes, where after the time intervals are increased to measurements every 1 or 2 hours. After 2 days, 2 or 3 measurements per day are sufficient. The duration of the experiment varies between materials, but from 2 weeks to 3 months is standard.

The boundary conditions, temperature and relative humidity, as well as the surface temperatures, are monitored through the experiment. These measurements are logged with a data logger every 15 minutes during the duration of the experiment. Large fluctuations in boundary temperature and relative humidity should be avoided.

Apparatus

Balance with a precision of 0.0001g

Drying chamber with drawers for specimens

Surface temperature sensors

Temperature and relative humidity sensors for the chamber conditions

Logging equipment for temperature and relative humidity measurements

Calculation procedure (including symbols and units)

Water vapour transfer coefficient: is a surface transfer coefficient, dependent on the boundary and surface conditions of the specimen, and

Symbol	Quantity	Unit
m_{water}	Mass of water in specimen	g
m_t	Mass of specimen at time t	g
m_{dry}	Dry mass of specimen	g
Ol	Moisture content	m^3/m^3
ρ	Bulk density of the specimen	kg/m^3
V	Volume of specimen	cm^3
$OUTFLOW$	Mass flux density	$kg/m^2 \cdot s$
Δm	The mass difference between successive weighings	g
Δt	The time difference between successive weighings	s
A	Surface area of the specimen	m^2
β	Water vapour transfer coefficient	s^2/m
$P_{v,surface}$	Vapour pressure at the surface of the specimen	Pa
$P_{v,boundary}$	Vapour pressure in the boundary climate	Pa
T_{ave}	Average temperature for first drying phase	$^{\circ}C$
φ_{ave}	Average relative humidity for the first drying phase	%

Initially, the water mass left in the specimen (1) and the moisture content in the specimen (2) at each time step is determined. The ρ implemented in the equation, is based on the geometric measurements and the dry weight;

$$m_{water} = m_t - m_{dry} \quad (1)$$

$$Ol = \frac{m_{water}}{m_{dry}} \cdot \frac{\rho}{1000}, \quad \text{where } \rho = \frac{m_{dry}}{V} \quad (2)$$

The mass flux density of the drying is also determined for every time step, by means of the equation below (3), where Δm and Δt are the difference in mass and time respectively between two successive weighings;

$$OUTFLOW = \frac{\Delta m}{1000 \cdot A \cdot \Delta t} \quad (3)$$

For the first drying phase (where liquid moisture within the material is transported to the surface for evaporation), the water vapour transfer coefficient can be determined (4);

$$\beta = \frac{-OUTFLOW}{p_{v,surface} - p_{v,boundary}} \quad (4)$$

And the vapour pressures are determined by the monitored temperatures and relative humidities at the surface and boundary respectively. The monitored values are averaged over the time-steps within the first drying phase. The relative humidity at the surface during the first drying phase, is assumed to be 100 %. The vapour pressures for surface and boundary, are calculated by means of the equation below (5);

$$p_v = 288.68 \cdot \left(1.098 + \frac{T}{100}\right)^{8.02} \cdot \frac{\varphi}{100} \quad (5)$$

5.3.5 Water absorption with Karsten tube

The Karsten tube method is a non-destructive and simple method for estimation of water absorption and penetration in porous materials. Previously results from Karsten tube measurements were used solely comparatively, but Hendrickx (2012) has theoretically described analytical and numerical methods for evaluating results gained by use of Karsten tube thus estimating water transport parameters such as sorptivity, S , and capillary saturated volume moisture content, θ_{cap} .

The measurement method is presented as RILEM Test Method II.4 (AMT Laboratories, 2006) for determination of the rate of water movement through porous materials by measuring the quantity of water absorbed by the surface in a given time period. The results can be used for determination of which degree of weathering a material has undergone by comparison between in-situ measurements and laboratory measurements of unweathered, untreated masonry. The method can also be used for

determination of the degree of protection provided by various water repelling or resistant surface treatments.

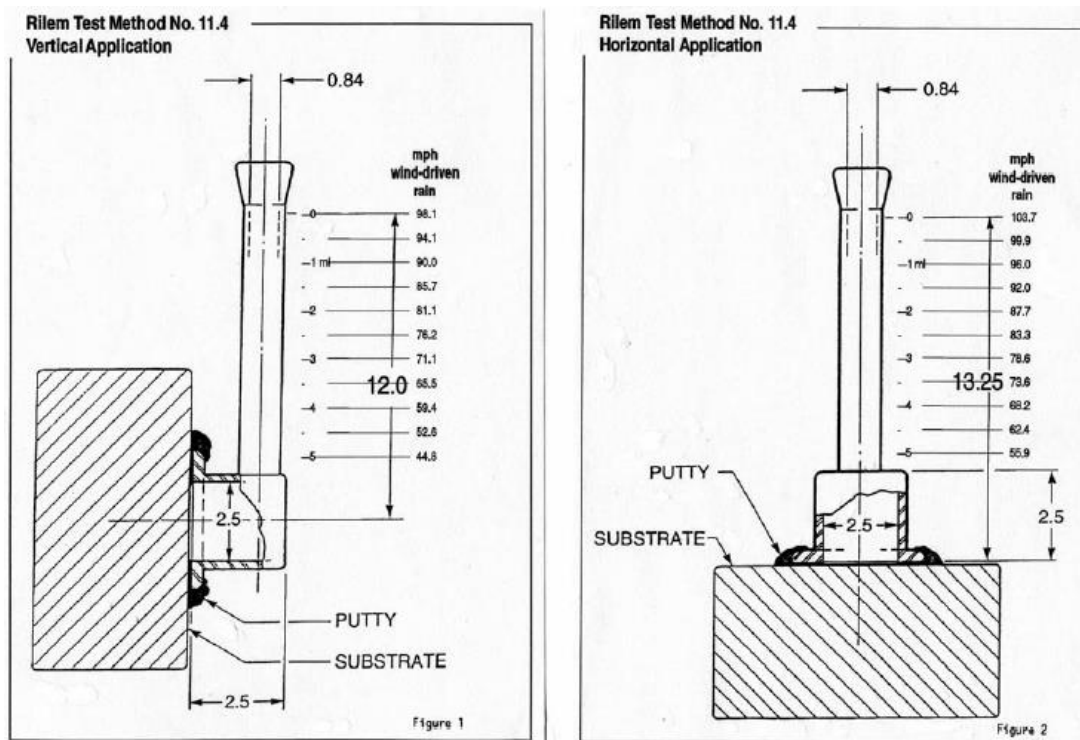

Figure 45: Karsten tubes applied vertically (left) and horizontally (right) (AMT Laboratories, 2006)

Figure 45 illustrates the principle of the Karsten tube; a 5 ml tube is fixed to the surface of the investigated material with putty. The putty is applied to the brim of the flat, round end of the tube, and manual pressure on the cylinder ensured the adhesion. The tube can be fixed either horizontally or vertically. Water is added to the top of the tube, until the 0ml mark, and thus the absorbed water can be read directly from the graduated tube. Appropriate measurement intervals depends on the given material, however generally 5, 10, 15, 20, 25 and 30 minute intervals provide useful data.

The following calculation are based on the Roel Hendrickx description (Hendrickx, 2012);

The effective radius for the contact area is denoted R_e [mm] and the diameter of the wet area is D_e [mm]. The penetration distance of the wet front is calculated for each time interval, t by equation (1):

$$x(t) = R_{wet}(t) - \frac{D_e}{2} \quad (1)$$

Thus the wet volume can be calculated by means of the following equation (2):

$$V_{wet}(t) = \frac{2}{3} \cdot \pi \cdot (x(t)^3 + R_e \cdot x(t)) + \pi \cdot R_e^2 x \cdot (t) \quad (2)$$

The capillary saturated volume moisture content, θ_{cap} , can be determined, assuming capillary saturation of the wetted zone and dry conditions before initiating the test, and V_{abs} represents the measured value of absorbed water. As θ_{cap} represents a material parameter this should be constant during the experiment, although slight variations allow the use of an average value of θ_{cap} , equation (3):

$$\theta_{cap}(t) = \frac{V_{abs}(t)}{V_{wet}(t)} \quad (3)$$

The following equation (4) is used to find the sorptivity, S , of the given material. The factor γ is gained empirically by Smettem (Hendrickx, 2012) to be 0.75. By means of the goal seek function in excel, S is found by aiming V_{abs} at the measured V_{abs} by changing S :

$$V_{abs} = \pi \cdot R_e^2 \cdot S \cdot \sqrt{t} + \frac{\pi \cdot R_e \cdot \gamma \cdot S^2}{\theta_{cap}} \cdot t \quad (4)$$

By multiplying the result with $\frac{10}{\sqrt{60}}$ the common unit of sorptivity, [$\frac{kg}{m^2 \cdot \sqrt{s}}$], is obtained.

5.3.6 Water absorption with an alternative instrument

Name of the measurement method

In-situ water absorption measurement instrument for masonry facades

Material parameter to be determined

Water absorption coefficient A_w (unit: $kg/m^2s^{1/2}$)

Reference to a valid international standard (including number) or other standard or reference

Procedure description is given in the literature (Stelzmann et al., 2013) EN ISO 15148

Limit/threshold values for plaster in EN 998-1, for specific constructions in DIN 4108-3, for the design of internal insulation in WTA guideline 6-4

Testing principle

Laboratory procedure for the A_w -Value

An air-dried sample is stored in a water bath, which provides nearly a pure contact between footprint area and the sheet of water (only some mm immersion). Depending on the material structure of the porous material, water is absorbed to a certain amount (e.g. capillary forces, gravity, air pressure etc.) and causes a weight gain. The sample is removed from the water bath in defined time steps and weighted. Normally, the resulting time depending function gives the area-related weight gain of the specimen in $kg/m^2s^{1/2}$. This procedure is only applicable in existing buildings if a destructive sample extraction is possible. Alternative methods are Karsten's resp. RELEM tube and Franke panel method. Both methods lack of exactness and results transferability due to different water pressure conditions, gravity – capillary suction directions, non-standardized

original condition of the wall material, relatively small absorption interface.

In-situ procedure

The new method is based on the ASTM C1601 procedure. In contrast to this method, complexity, time effort and destructive impact are reduced. The instrument, in form of a box, with about 0.2 m² wall measurement area, is directly fixed on the façade and sealed with a suitable compound material. The upper part includes a spraying unit, which distributes water drops and thus creates a closed water film on the wall surface. The water gets partially absorbed and the overrun is collected in a vessel, which is fixed below the measurement area at the bottom of the measurement device. From this vessel, the water is recirculated onto the wall. The weight in the vessel is continuously measured as the mass loss equals the absorbed water mass. Additionally, a lateral vent in the box creates a constant overpressure of 50 to 200 Pa. Some inaccuracies result from the evaporation of water within the measurement box, water edge effects, drops bonded at the inner box surfaces etc. The measurement phase itself is only about one hour. Mounting the device at the façade and removing it (residue-free) takes some more time. The results showed a reproduction precision of up to $8.3 \cdot 10^{-4} \text{ kg/m}^2\text{s}^{(1/2)}$.

A sketch of the measurement scheme is given in the left-hand of **Figure 46**. Right-hand photography shows the main components of the device (headwords in the **Figure 46** from top to bottom: wall fastening hook, air supplying pin, pump, wetted wall surface, inspection glass, wind shield box, cistern, balance)

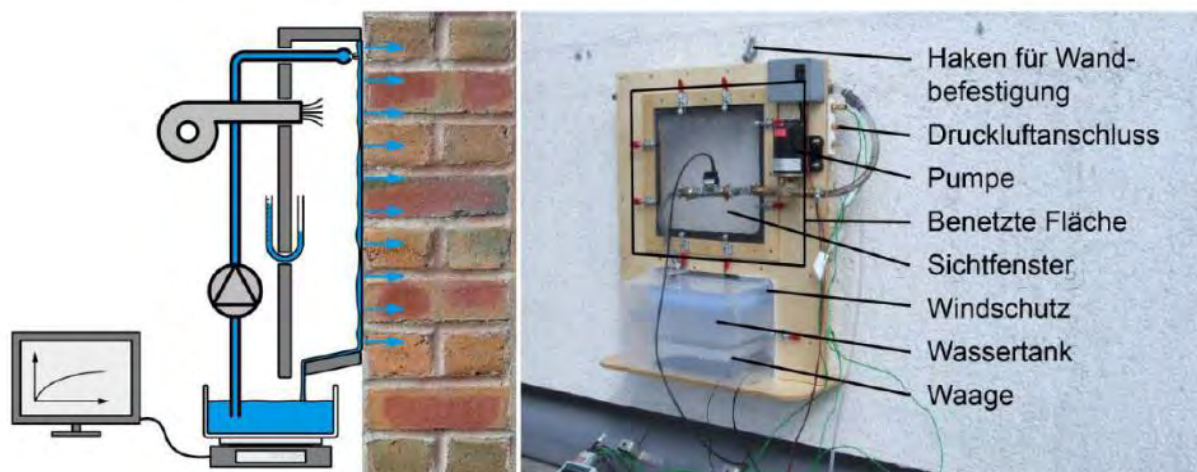

Figure 46. Principle of method to measure water absorption in situ.

Test samples

The measurement is conducted in-situ. A preparation of the wall is not necessary. The vertical measurement area shows a dimension of 41 cm in height and 50 cm in width. The device is slightly bigger (70 cm / 60 cm).

Testing conditions

Test conditions are not standardized yet. Studies about the impact of water temperature (calculational correction follows the equation below) and the impact of moisture content of the

existing wall (calculational correction is not possible) have been conducted by TU Dresden. According to these results, an environmental temperature close to lab test conditions (about 20°C, equilibrium moisture content of indoor air) and un-wetted masonry (e.g. measurement after non-rainy, ideal radiation conditions days) would be preferable.

Calculation procedure (including symbols and units):

The area-related mass change of the absorbed water is given in the following equation. It includes the density of water (ρ_w in kg/m³), the capillary volumetric water content (θ_{cap} in m³/m³), the water content (θ in m³/m³), the radius of the capillary tubes (r in m), the surface tension of water (σ N/m), the wetting contact angle (γ in °), the dynamic viscosity of water (η in kg/m sec) and the square root of the suction time (t in sec). The term in big brackets is summarized in form of the material property “water absorption coefficient” (second equation).

$$m = \left[\rho_w \cdot (\theta_{cap} - \theta) \cdot \sqrt{\frac{r \cdot \sigma \cdot \cos(\gamma)}{2 \cdot \eta}} \right] \cdot \sqrt{t} \quad [kg \cdot m^{-2}] \quad [1]$$

$$m = A_w \cdot \sqrt{t} \quad [kg \cdot m^{-2}]$$

Equation 1 includes different material properties which are not constant but depending on the water temperature, namely the density of water, the surface tension and the dynamic viscosity of water. The following approach allows a correction of measurement results based on the difference between reference values (values for 20°C water temperature) and recorded values during the in-situ measurement procedure.

$$m_g = A_w \cdot \sqrt{t} \cdot \left[\frac{\sigma \cdot \eta_{ref}}{\sigma_{ref} \cdot \eta} \right] \quad [kg \cdot m^{-2}] \quad [3]$$

The impact of temperature on the result is remarkable. An in-situ measurement water temperature range of about 5°C to 35°C results in mass correction factors of about 0.85 (for high temperatures) up to 1.25 (for low temperatures).

6 Conclusions and perspectives

The major findings of the report are:

- The most common tools and methods to perform hygrothermal calculations are identified and described. Simple tools and methods use static climates and consider only diffusion (Glaser and Eco-sai) or diffusion and redistribution of occurring internal condensate (COND). Simulation tools use transient climates e.g. hourly values; three of these are described: DELPHIN, WUFI and MATCH. The six tools and methods described were chosen as the ones used by more or less specialised practitioners and not only by researchers.
- For each of the three simulation tools satisfactory agreement between simulations and measurements have been found by different sources, although the tools have different ways to characterise materials. Some of the material properties are used directly in the material characterisation included in the simulation tools; others are used to describe material functions. A ranking of the simulation tools has not been made. The main idea has been to identify which material properties are needed.
- In practice the user of a simulation tool is most likely to choose a material from the database of the tool. Unfortunately, it can be difficult for the user to determine which material best resembles the actual material. An identification of the most decisive material properties would help the user in choosing a material or in deciding which material parameters to test before simulations are made. Consequently, such an analysis has been made on a solid masonry wall with and without internal insulation. Unfortunately, there is no simple answer, as it depends on several parameters such as:
 - Where in the construction the investigation is made, e.g. close to the exterior or close to the internal side of the masonry.
 - Consequently, the failure mode of interest, as it is unlikely that e.g. frost and mould growth will be of interest in the same depth of the construction.
 - The weather, precipitation catch ratio and long wave radiation.
- The analysis of the most decisive material properties was made as cluster analyses. Defining materials in clusters will also make it possible to express the uncertainty in performing simulations with materials whose material properties are partly unknown. It is one of the main ideas in RIBuild to use probabilistic methods instead of deterministic, as it would help the user to understand how certain the outcome is. Clustering the materials and either use average values and standard deviations in the material characterisation or make several simulations with the materials in the cluster and calculate the outcome of all these will result in outcomes as averages with standard deviations. If materials with missing material properties can be placed in clusters, it would be possible to determine missing values, although these would be less certain than if they were measured. The cluster analyses were made on inputs and outputs using 44 bricks with well-known material properties. For the input clusters traditional cluster analysis was used on twelve hygrothermal material properties. The output clustering was made on two specific simulation models, each

calculated with the 44 bricks of the input cluster. Through falsification it was shown that input clusters do not match output clusters. In addition the analysis on output clusters showed how other factors than material properties seem to be more decisive, at least as long as the properties are within a certain range e.g. if it is a brick. Analyses on other materials have not been made.

- The result that material properties are not that decisive does not correspond to findings of other projects. There might be several explanations:
 - The cluster analysis has been focused on extreme situations e.g. situations in which failure modes may occur.
 - The evaluation has been made on simple material properties; the more complex material functions have not been evaluated.
- Despite of the finding that the decisiveness of material properties is not unique, methods to describe the material properties are compiled. Point of reference has been methods stated in standards. In addition, alternative methods have been described either because these are more precise or easier to perform, as they may be less time consuming or cheaper. A few methods determine properties that are not included in the standardised methods.
- Finally, the report also contains compilations of material properties as they can be found in databases, textbooks, older reports etc. The focus has been twofold:
 - On materials used in solid walls of historic buildings e.g. bricks, natural stones, mortars and plasters.
 - On materials used for internal insulation based on EPS, XPS, PIR, PUR, mineral wool, mineral based materials (e.g. aerated concrete, calcium silicate), wood fibre and other organic materials.

The outcome of this study will be used further in the RIBuild project as material properties are still relevant for the simulations that are needed for Work Package 6 *Application and evaluation of assessment tools*. Especially since stochastic methods will be used here.

Further work should be done in clustering analyses, as it may reveal tendencies or even the possibility to determine the most decisive material properties if some of the functions can be described in better ways than single points on curves. Alternatively, the decisiveness may be coupled to failure modes i.e. if mould growth is the main issue; one set of parameters are important, if frost is the main issue; another set is important etc.

The compilation of material properties and how they can be found may also be of interest of other scientists and practitioners. Hopefully, the description of tests will make it more clear what it takes to make these tests and thereby make it easier for practitioners and laboratories to discuss which properties and methods should be used. It would also help ensuring correct pricing of tests, as it becomes more transparent what the tests involve than just referring to a standard that may not even be particular precise.

References

- AASTM C1601:2014. (2014). Standard Test Method for Field Determination of Water Penetration of Masonry Wall Facades.
- ASHRAE Standard 160 (2016). *Criteria for Moisture-Control Design Analysis in Buildings*.
- Blumberga, A., Blumberga, D., Kamendere, E., Kamenders, A., Kass, K., Purvins, R. & Zogla, G. (2015): *Report on historical building types and combinations of structural solutions*, RIBuild D1.1 _2.0, Horizon 2020. www.ribuild.eu
- Blumberga, A., Kašs, K., Kamendere, E., Žogla, G., Kamenders, A., Blumberga, D., Grāvelsiņš, A., Purviņš, R., Rošā, M., Timma, L., Janssen, H., Freudenberg, P., Stahl, F., Peuhkuri, R., Padey, P., Lasvaux, S., di Giuseppe, E., de Place Hansen, E.J. (2015b): *State of the art on historic building insulation materials and retrofit strategies*, RIBuild D1.2 _1.0, Horizon 2020.
- Bouesse, Y.T. (2013). *Analyse du comportement hygrothermique de la barrière de vapeur variable Vario KM duplex*. HEIG-VD
- Breiman L., Friedman J. H., Olshen R. A., and Stone, C. J. (1984) *Classification and Regression Trees*. Wadsworth.
- Carmeliet J, Adan O, Brocken H, Cerny R, Hall C, Hens H, Kumaran K, Pavlik Z, Pel L, Plagge R, Roels S, 2004: Determination of the liquid water diffusivity from transient moisture transfer experiments, *Journal of Thermal Envelope and Building Science*, 27: 277-305.
- Carmeliet J, Roels S, 2001: Determination of the isothermal moisture transport properties of porous building materials, *Journal of Thermal Envelope and Building Science* 24: 183-210.
- Carmeliet, J, Hens, H, Roels, S, Adan, O, Brocken, H, Cerny, R, Pavlik, Z, Hall, C, Kumaran, K, Pel, L, 2004: Determination of the liquid water diffusivity from transient moisture transfer experiments, *Journal of Thermal Envelope and Building Science*, 27:277-305.
- Danish Meteorological Institute. (n.d.). Decadal mean weather. Retrieved December 14, 2017, from <https://www.dmi.dk/en/vejtr/arkiver/decadal-mean-weather/decadal-mean-weather/>
- Delgado, J.M.P.Q., Barreira, E., Ramos, N.M.M., & de Freitas, V.P. (2013). *Hygrothermal numerical simulation tools applied to building physics*. Berlin: Springer-Verlag.
- DELPHIN webpage: <http://bauklimatik-dresden.de/delphin/documentation.php> – Accessed 25 Jan 2018
- EN 15026 (2007). *Hygrothermal performance of building components and building elements – Assessment of moisture transfer by numerical simulation*.

- EN ISO 10211-1. (2007). Thermal bridges in building construction — Heat flows and surface temperatures — Detailed calculations. *CEN*, 54.
- EN ISO 13788 (2012). *Hygrothermal performance of building components and building elements - Internal surface temperature to avoid critical surface humidity and interstitial condensation - Calculation methods*
- EN ISO 13788. (2012). *Hygrothermal performance of building components and building elements. Internal surface temperature to avoid critical surface humidity and interstitial condensation*
- EN ISO 14040 (2006) *Environmental management - Life cycle assessment - Principles and framework*
- EN_ISO_12572 (2001). *Hygrothermal performance of building materials and products – Determination of water vapour transmission properties (ISO 12572:2001)*
- Feng, C, Janssen, H, Feng, Y, Meng, Q, 2015: Hygric properties of porous building materials: Analysis of measurement repeatability and reproducibility, *Building and Environment*, 85:160-172.
- Fraley, C. and Raftery, A.E. (2002) Model-based Clustering, Discriminant Analysis and Density Estimation *Journal of the American Statistical Association* 97:611-631
- Fraley, C., Raftery, A.E., Murphy, T.B., & Scrucca, L. (2012) mclust Version 4 for R: *Normal Mixture Modeling for Model-Based Clustering, Classification, and Density Estimation*
- Glaser, H. (1958a). Wärmeleitung und Feuchtigkeitsdurchgang durch Kühlraum-isolierungen. *Kältetechnik*, no.3 (in German).
- Glaser, H. (1958b). Temperatur- und Dampfdruckverlauf in einer homogene Wand bei Feuchtigkeitsausscheidung. *Kältetechnik*, no.6 (in German).
- Glaser, H. (1958c). Vereinfachte Berechnung de Dampfdiffusion durch geschichtete Wände bei Ausscheiden von Wasser und Eis. *Kältetechnik*, no.11 & no.12 (in German).
- Glaser, H. (1959). Grafischer Verfahren zur Untersuchung von Diffusionsvorgange. *Kältetechnik*, no.10 (in German).
- Grunewald, J. (1997). *Diffusiver und konvektiver Stoff- und Energietransport in kapillarporösen Baustoffen*. PhD thesis, Technischen Universität Dresden, Germany (in German).
- Grunewald, J., Häupl, P., & Bomberg, M. (2003, April). Towards an Engineering Model of Material characteristics for Input to Ham Transport Simulations - Part 1: An Approach. *Journal of Thermal Envelope and Building Science Vol. 26*, pp. 343-366.
- Grunewald, J., Nicolai A. (2006). Effekte der Luftströmung auf das Hygrothermische Verhalten von Leichten Umfassungskonstruktionen. In: Proceedings of "Erste deutsch-österreichische IBPSA-Konferenz", Technische Universität München, IBPSA 2006, R. Koenigsdorff, C. van Treck.

- Hansen, K.K. (1986). *Sorption Isotherms A Catalogue*, Technical report 162/86, Technical University of Denmark, Department of civil engineering, Building Material Laboratory.
- Häupl P., Grunewald J. and Ruisinger U. (2005). Hygrothermal analysis of external walls of the Rijksmuseum Amsterdam. *WIT Transactions on The Built Environment*, 83, p. 10
- Häupl, P., Fechner, H. (2003). Hygric material properties of porous building materials. *Journal of Thermal Environment & Building Science*, 26(3): 259-284.
- Hendrickx, R. (2012). *Using the Karsten tube to estimate water transport parameters of porous building materials*. Materials and Structures, 1-12. <https://doi.org/10.1617/s11527-012-9975-2>
- Hens, H (1996). Final Report IEA-ECBCS Annex 24 *Heat, air and moisture transfer in insulated envelope parts, modelling, vol 1, Acco, Leuven (1996)*
- Hens, H. (2015). Combined heat, air, moisture modelling: A look back, how, of help? *Building and Environment* 91:138-151.
- Hill, D. & McGowan, A., 2003. Review of hygrothermal models for building envelope retrofit analysis. CMCH-SCHL, Technical Series, 03-128. Available at: <http://www.cmhc-schl.gc.ca/publications/en/rh-pr/tech/03-128-e.htm>
- <http://cic.vtt.fi/susref/> Sustainable Refurbishment of Building Facades and External Walls. EU funded project (FP7)
- ISO 15148:2002, 2002: Hygrothermal performance of building materials and products – Determination of water absorption coefficient by partial immersion.
- ISO EN 13788. (2012). *Hygrothermal performance of building components and building elements. Internal surface temperature to avoid critical surface humidity and interstitial condensation*
- Jacob, D. & Kotova, L.(2013). High resolution datasets for the different IPCC scenarios for selected Case Study areas as input data for hygrothermal building simulation and complete high resolution dataset over entire Europe. Hamburg.
- Janssen, H, Vereecken, E, Holúbek, M, 2015: A confrontation of two concepts for the description of the over-capillary moisture range: air entrapment versus low capillarity. Proceedings of the 6th International Building Physics Conference, Turin, Italy.
- Janssen, H. (2014). Simulation efficiency and accuracy of different moisture potentials. *Journal of Building Performance Simulation* 7:379-389.
- Josse, J. & Husson, F. (2016). missMDA: A Package for Handling Missing Values in Multivariate Data Analysis. *Journal of Statistical Software*, 70(1), 1-31. doi:10.18637/jss.v070.i01
- Kalamees T, Vinha J (2003). Hygrothermal calculations and laboratory tests on timber-framed wall structures. *Building and Environment* 38;5: 689-97.

- Klošeiko, P., Arumagi, E., Kalamees, T. (2015) Hygrothermal performance of internally insulated brick wall in cold climate: A case study in a historic school building. *Journal of Building Physics*, 38(5): 444–464.
- Krischer, O. & Kast, W. (1978). *Die wissenschaftlichen Grundlagen der Trocknungstechnik*, 3. Auflage, Springer-Verlag, Berlin.
- Krus, M, & Holm, A, (1999). *Simple methods to approximate the liquid transport coefficients describing the absorption and drying process*. Proceedings of 5th Symposium on Building Physics in the Nordic Countries, Göteborg, Sweden.
- Künzel, H. M. (1995). *Simultaneous Heat and Moisture Transport in Building Components. One- and two-dimensional calculation using simple parameters*. Fraunhofer IRB Verlag Stuttgart.
- Künzel, H.M. (1994). *Verfahren zur ein- und zweidimensionalen Berechnung des gekoppelten Wärme- und Feuchtetransports in Bauteilen mit einfachen Kennwerten (in German)*. PhD thesis, Universität Stuttgart, Germany.
- Langmans, J., Nicolai, A., Klein, R., Grunewald, J., Roels, S. (2011). Numerical Simulation of Building Components - Towards an Efficient Implementation of Air Convection in HAM-models. In: Proceedings of the 9th Nordic Symposium on Building Physics.
- Mundt Petersen, S.O, & Harderup, L.-E. (2014). A method for blind validation of hygrothermal calculation tools. In M. Quattrone, & Vanderley (Eds.), *Proceedings XIII DBMC – XIII International Conference on Durability of Building Materials and Components*, pp. 624-631.
- Mundt Petersen, S.O. (2015). *Moisture Safety in Wood Frame Buildings – Blind evaluation of the hygrothermal calculation tool WUFI using field measurements and determination of factors affecting the moisture safety*. Report TVBH-1021 Building Physics, LTH, Lund, Sweden
- Nicolai, A. (2007). Modeling and Numerical Simulation of Salt Transport and Phase Transitions in Unsaturated Porous Building Materials. Ph.D. thesis, Syracuse University.
- Nicolai, A., Scheffler, G.A., Grunewald, J., et al. (2008). An efficient numerical solution method and implementation for coupled heat, moisture and salt transport: The Delphin program, (Research Report on Priority Program DFG SPP 1122) (ed L. Franke, G. Dekkelmann and R. Espinosa-Marzal). Gottingen: Cuilliver Verlag, pp. 85–100.
- Nielsen, A. (1974). Moisture distribution in cellular concrete during heat- and moisture transfer (*in Danish: Fugtfordelinger i gasbeton under varme- og fugttransport*). LFV medd.29. PhD Thesis, Technical University of Denmark, Denmark,
- Oberkampf, W.L, & Roy, C. M. (2013). *Verification and Validation in Scientific Computing*. Virginia Polytechnic Institute and State University.
- Ochs, F. (2010). Modelling Large-Scale Thermal Energy Stores. Ph.D. thesis, University of Stuttgart. ISBN 978-3-8322-8834-1

- Pedersen, C. R., Grau, K (2003). Whole Building Hygrothermal Simulation Model. ASHRAE Transactions – 2003, Volume 109, pp. 572-582. American Society of Heating, Refrigerating and Air-Conditioning Engineers.
- Pedersen, C.R. (1990). Combined heat and moisture transfer in building constructions. Ph.D. thesis. Thermal Insulation Laboratory, Technical University of Denmark. Available at: <http://orbit.dtu.dk/files/5297902/CarstenRode.pdf>
- Pedersen, C.R., Burch, D.M. (1995). Empirical validation of a transient computer model for combined heat and moisture transfer. Proceedings of Thermal Performance of the Exterior Envelopes of Building VI, Clearwater Beach, FL, December 4-8, 1995, pp. 283–295. Available at: <http://fire.nist.gov/bfrlpubs/build95/PDF/b95023.pdf>
- Pedersen, C.R., Petrie, T.W., Courville, G.E., Desjarlais, A.O., Childs, P.W., Wilkes, K.E. (1992). Moisture effects in low-slope roofs: Drying rates after water addition with various vapor retarders. ORNL/CON-308. Oak Ridge. Tenn., Oak Ridge National Library.
- Plagge, R, Scheffler, & Grunewald, J. (2005). Automatic Measurement of Water Uptake Coefficient of Building Materials. *Bauphysik*, 27(6), 315-323.
- Plagge, R, Scheffler, G, Grunewald J, 2005: Automatic measurement of water uptake coefficient of building materials, Proceedings of 7th Symposium on Building Physics in the Nordic Countries, Reykjavik, Iceland.
- Plagge, R. (2007). Laboratory methods – Description.
- Purviņš, R. (2016). *Investigation of historic building material properties and effects on energy efficiency*, Bachelour Thesis, Riga Technical university (in Latvian)
- Rode Pedersen, C. (1990). *Combined heat and moisture transfer in building constructions*. PhD Thesis, Technical University of Denmark, Denmark.
- Roels S, Carmeliet J, 2006: Analysis of moisture flow in porous materials using microfocus X-ray radiography, *International Journal of Heat and Mass Transfer* 49: 4762-4772.
- Roels S, Carmeliet J, Hens H, Adan O, Brocken H, Cerny R, Pavlik Z, Ellis AT, Hall C, Kumaran K, 2004: A comparison of different techniques to quantify moisture content profiles in porous building materials, *Journal of Thermal Envelope and Building Science*, 27: 261-276.
- Roels, S, Carmeliet, J, Hens, H, 2003: HAMSTAD WP1 final report – Moisture transfer properties and materials characterisation, KU Leuven, Leuven, Belgium.
- Roels, S, Carmeliet, J, Hens, H, Adan, O, Brocken, H, Cerny, R, Pavlik, Z, Ellis, AT, Hall, C, Kumaran, K, 2004: A comparison of different techniques to quantify moisture content profiles in porous building materials, *Journal of Thermal Envelope and Building Science*, 27:261-276.
- Sandberg, PI. (1970). *Non-stationary moisture transport* (in Swedish: Icke stationär fukttransport), Report 16. Lund Institute of Technology, Lund University, Lund, Sweden.

- Scheffler, G. A. (2008). Validation of hygrothermal material modelling under consideration of the hysteresis of moisture storage. Ph.D. thesis, Dresden University of Technology, Faculty of Civil Engineering, Institute of Building Climatology.
- Scheffler, G. A., & Plagge, R. (2010, October 29). A whole range hygric material mode: Modelling liquid and vapour transport properties in porous media. *International Journal of Heat and Mass Transfer*, pp. 286-296.
- Scheffler, G. A., Grunewald, J., & Häupl, P. (2004). Calibration of an Engineering Model of Hygrothermal Material Characteristics. *IEA-EXCO Energy Conservation in Buildings and Community Systems*, (pp. 1-18). Glasgow.
- Scheffler, GA, Plagge, R, 2010: A whole range hygric material model: modelling liquid and vapour transport properties in porous media, *International Journal of Heat and Mass Transfer*, 53:286-296.
- Sedlbauer, K. (2001). *Vorhersagen von Schimmelpilzbildung auf und in Bauteilen*. Thesis, Universität Stuttgart, Lehrstuhl für Bauphysik, Stuttgart, Germany
- SIA 180. (1999). *Isolation thermique et protection contre l'humidité dans les bâtiments*. Zurich, Switzerland.
- Sontag, L., Nicolai A., Vogelsang S. (2013). Validierung der Solverimplementierung des hygrothermischen Simulationsprogramms DELPHIN, Qucosa, (available on [http://www.qucosa.de/recherche/frontdoor/?tx_slubopus4frontend\[id\]=12896](http://www.qucosa.de/recherche/frontdoor/?tx_slubopus4frontend[id]=12896))
- Stelzmann, M. (2013). In-situ Messgerät für die zerstörungsfreie Messung der kapillaren Wasseraufnahme von Fassaden. *24. Hanseatische Sanierungstage, 7th to 9th November 2013*, (pp. 175-184). Heringsdorf, Usedom.
- Stelzmann, M., Berg, R., Möller, U., & Grunewald, J. (2016). Aw-Wert Messung in-situ - Worauf ist bei der Bestimmung des Wasseraufnahmekoeffizienten zu achten? *4. Innendämmkongress - Beiträge aus Wissenschaft und Praxis, 19.-20. Mai 2017* (pp. 58-72). Dresden: Fraunhofer IRB-Verlag.
- Stelzmann, M., Möller, U., & Plagge, R. (2013). Messverfahren zur zerstörungsfreien Bewertung der kapillaren Wasseraufnahme von Fassaden. *Bauphysiktage Kaiserslautern 27th to 28th November 2013*, (pp. 89-91). Kaiserslautern.
- Steskens, P. Loncour, X. Roels, S. Vereecken, E. (2013). Interior insulation of masonry walls – Assessment and design. 2nd Central European Symposium on Building Physics (CESBP), At Vienna, p. 8.
- Viitanen, H. & Rischkoff A.C. (1991). *Mould growth in pine and spruce sapwood in relation to air humidity and temperature*. Swedish University of Agricultural Science, Department of Forest Products. Uppsala, Sweden.
- WTA. *Leitfaden für hygrothermische Simulationsberechnung 6-1 (in German)*, Merkblatt 6-1-01/D, WTA Publications, Germany.

www.eco-sai.ch

www.episcope.eu. Energy Performance Indicator Tracking Schemes for the Continuous Optimisation of Refurbishment Processes in European Housing Stocks. EU funded project

www.mases.ensan.de. Materialdatensammlung für die energetische Altbausanierung. Data base of material properties for renovation.

Xu, J., Zhang, J., Grunewald, J., Zhao, J., Plagge, R., Ouali, A., Allard, F. (2009). A Study on the Similarities between Water Vapor and VOC Diffusion in Porous Media by a Dual Chamber Method. *Clean*, 37(6), 444–453.

Zhao, J., Plagge, R., Ramos, N.M.M., Simões, M.L., & Grunewald, J. (2015a). Application of clustering technique for definition of generic objects in a material database. *Journal of Building Physics*, 1-23.

Zhao, J., Plagge, R., Ramos, N.M.M., Simões, M.L., & Grunewald, J. (2015b). Concept for development of stochastic databases for building performance simulation. A material database pilot project. *Building and Environment* 84: 189-203

Appendix

With the amount of data available the need for continuous visual inspection of the data have been crucial and more detailed graphs than the already presented exists and can be found assembled under the following subjects:

- A1: Detailed output summary for not insulated as well as insulated walls
- A2: Brick material parameters and moisture content in scatter plots. 'Winter sums' for not insulated as well as insulated walls in scatter plots
- A3: Brick material parameters in box plots; variation within in clusters compared to total variation.

A1: Detailed output summary

A1.1 Not insulated, reference and stress test

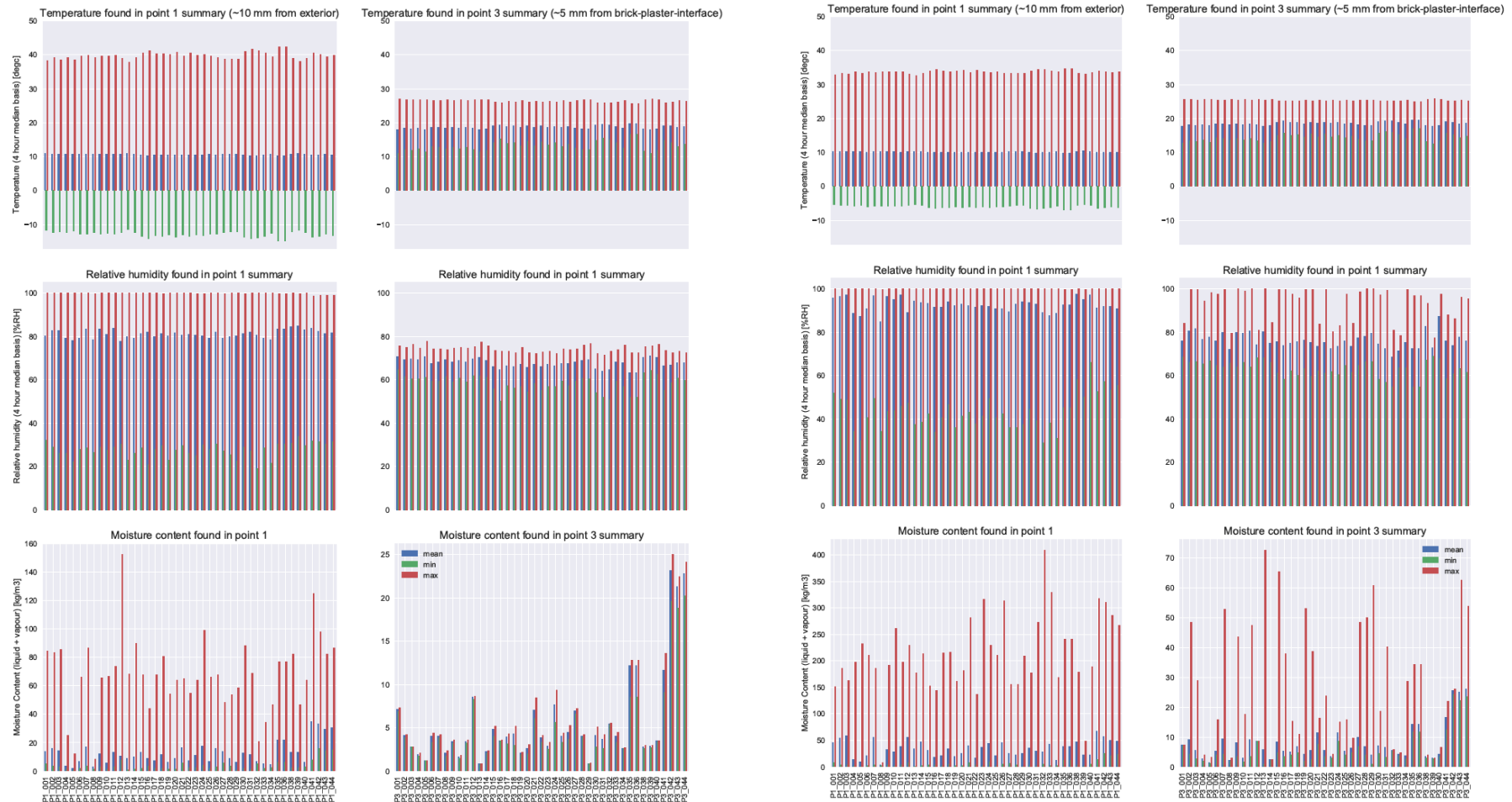

Figure 47. Outcome of simulations on temperature (top), relative humidity (middle) and moisture content in two different points (close to external and close to internal), no insulation. Two left columns are for the reference test two right columns for the stress test.

A1.2 Detailed output summary – insulated reference and stress test

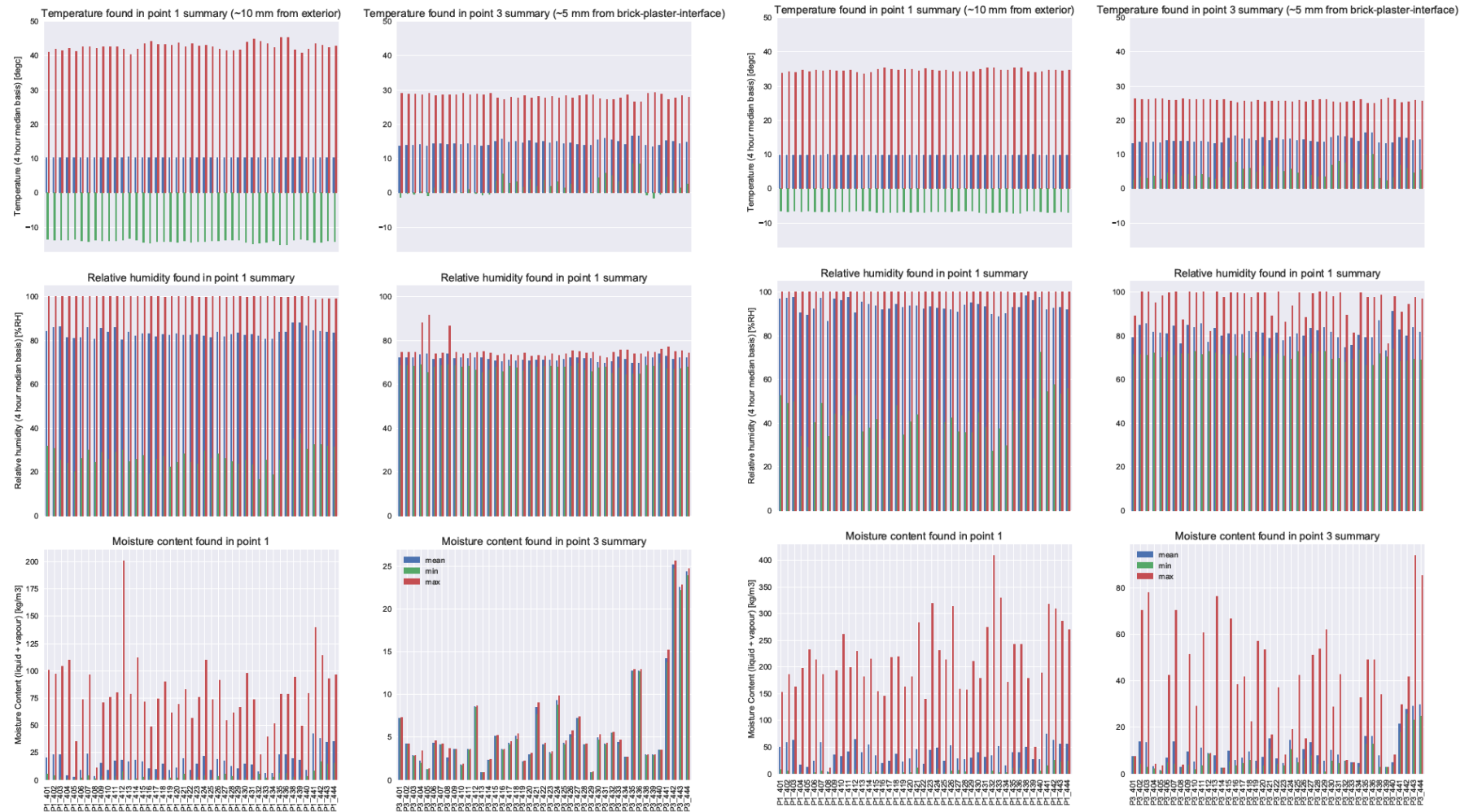

Figure 48. Outcome of simulations on temperature (top), relative humidity (middle) and moisture content in two different points (close to external and close to internal), with insulation. Two left columns are for the reference test two right columns for the stress test.

A2: Brick material parameters in scatter plot

Each bricks property shown against the sum of the respective brick's moisture content in a winter period.

Each bricks property shown against the sum of the respective brick's moisture content in a winter period.

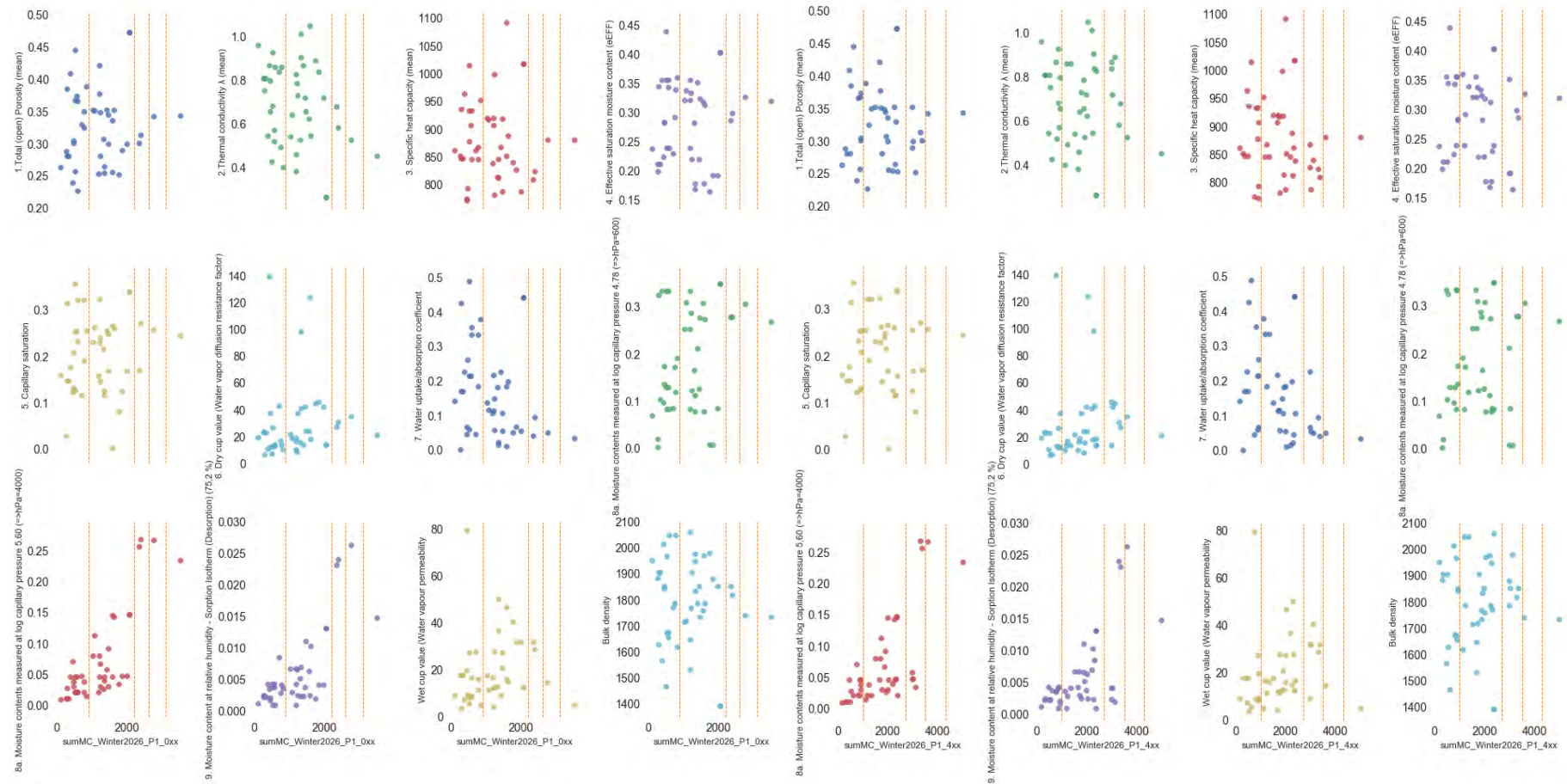

Figure 49. Brick material parameters (twelve different y-axis) all shown in a Scatter plot on a moisture content sum (x-axis). Orange dashed lines indicate the four biggest differences in the moisture content sum values (in absolute terms) used for various cluster. Four left columns in the not insulated case, four right column in the insulated case.

A3: Brick material parameters in box plots

In the following it is seen how a specific material parameter varies within a given cluster. Shown as a box plot for each parameter (a total of twelve) of all the materials included in the clusters. The variation of one parameter within a cluster can then be compared to other clusters and the whole catalogue of bricks. Below a box plot of all the bricks is compared with the six highest-ranking moisture content sums during winter for a ‘sensor’ near exterior in an insulated and not insulated wall respectively.

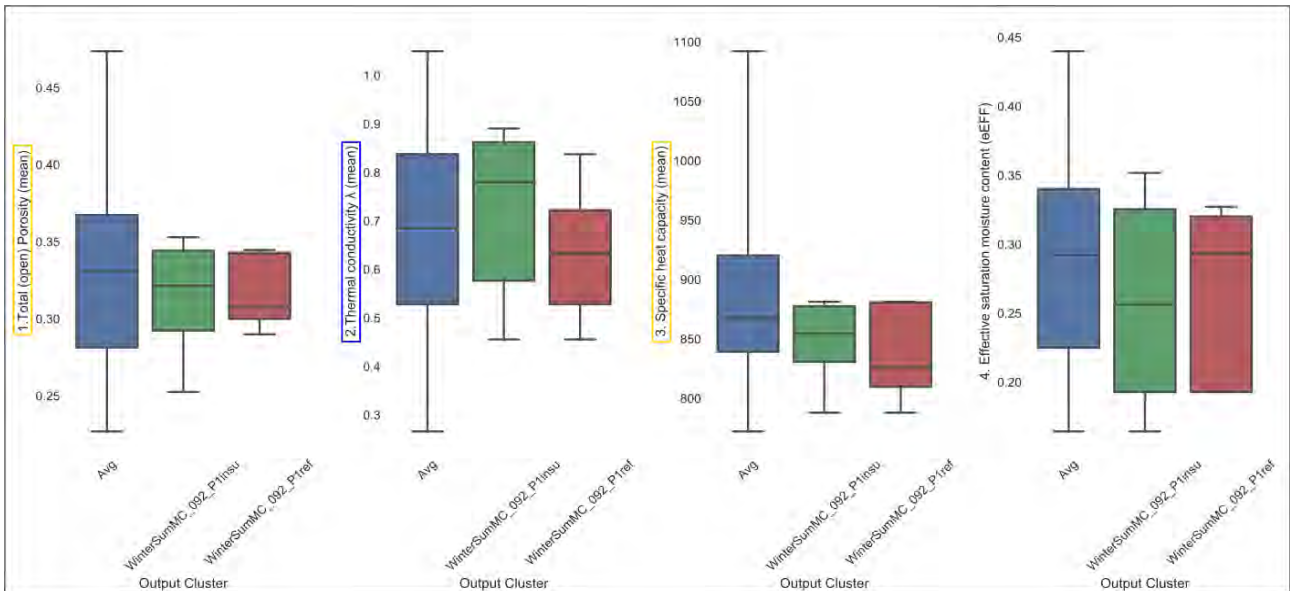

Figure 50. Variation of open porosity, thermal conductivity, specific heat capacity and effective saturation moisture content within two different cluster compositions compared to the variation seen in all the bricks (blue). Box plots are un-modified - as the whiskers cover entire spread. Clusters are based on a ‘sensor’ near exterior in an insulated (green) and not insulated wall (red) respectively.

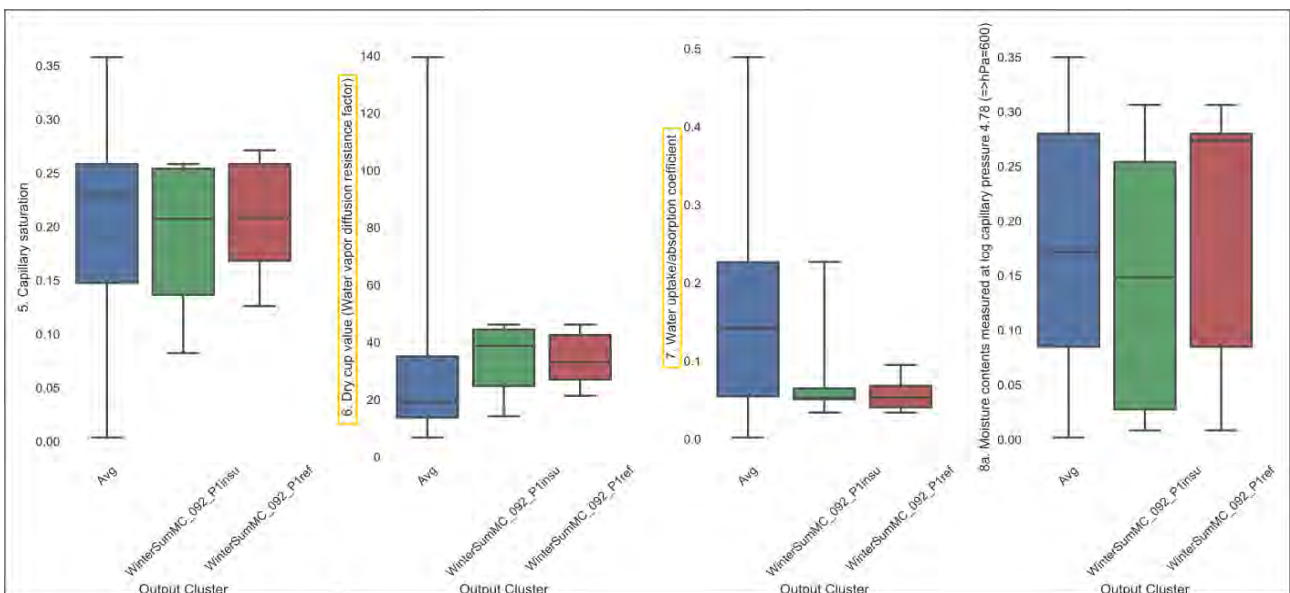

Figure 51. Variation of capillary saturation, water vapour diffusion resistance factor (dry cup), water uptake and moisture content measured at log capillary pressure 4.78 within two different cluster compositions compared to the variation seen in all

the bricks (blue). Box plots are un-modified - as the whiskers cover entire spread. Clusters are based on a 'sensor' near exterior in an insulated (green) and not insulated wall (red) respectively.

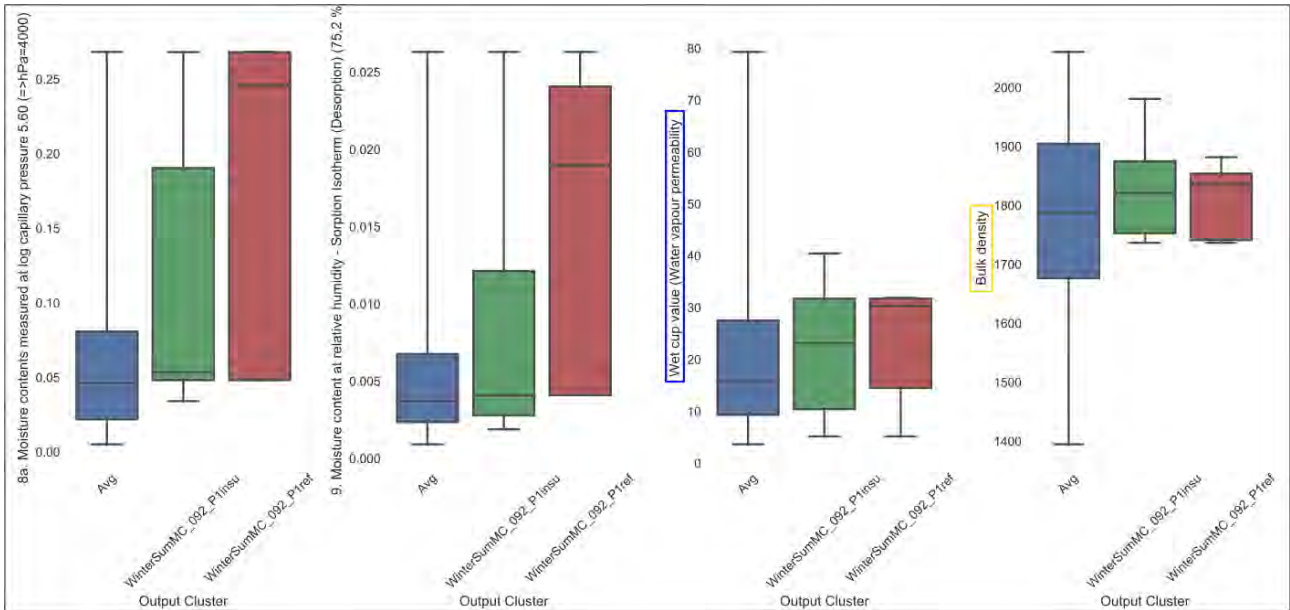

Figure 52. Variation of moisture content measured at log capillary pressure 5.60 moisture content at 75.2 % RH, water vapour diffusion resistance factor (wet cup) and bulk density within two different cluster compositions compared to the variation seen in all the bricks (blue). Box plots are un-modified - as the whiskers cover entire spread. Clusters are based on a 'sensor' near exterior in an insulated (green) and not insulated wall (red) respectively.