

BOWTIE

34 pieces

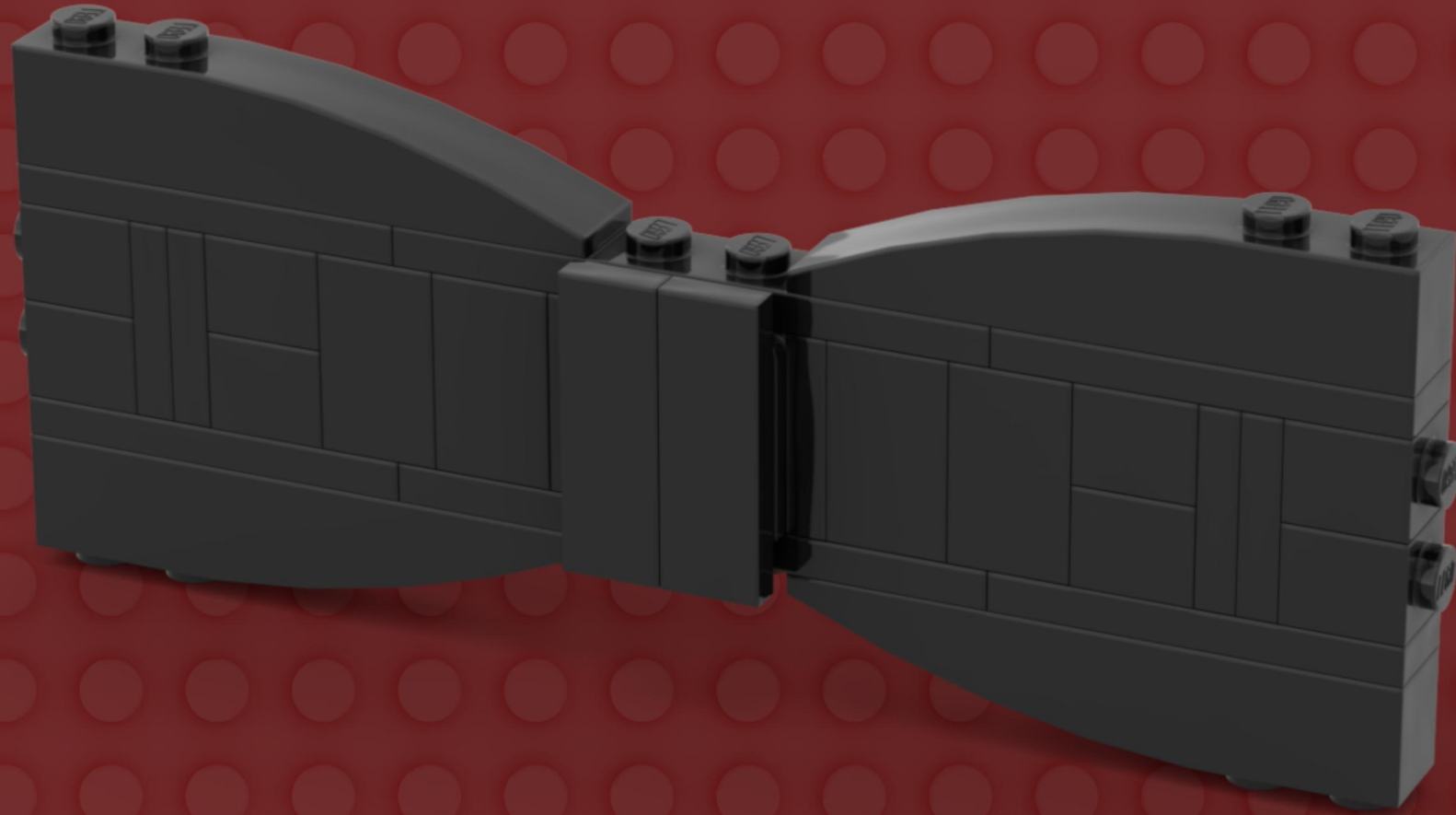

Build & Design by:

     @BrickinNick

Instructions By:

   @AsgardianStudio

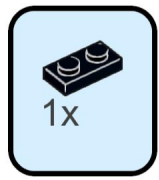

1

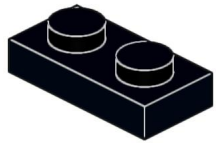

2

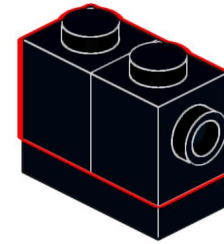

DESIGNED BY BRICKINNICK INSTRUCTIONS BY ASGARDIAN STUDIO

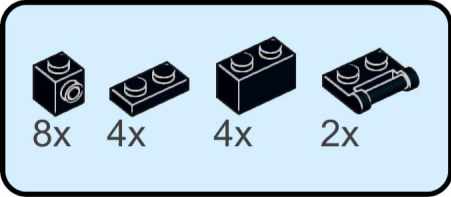

3

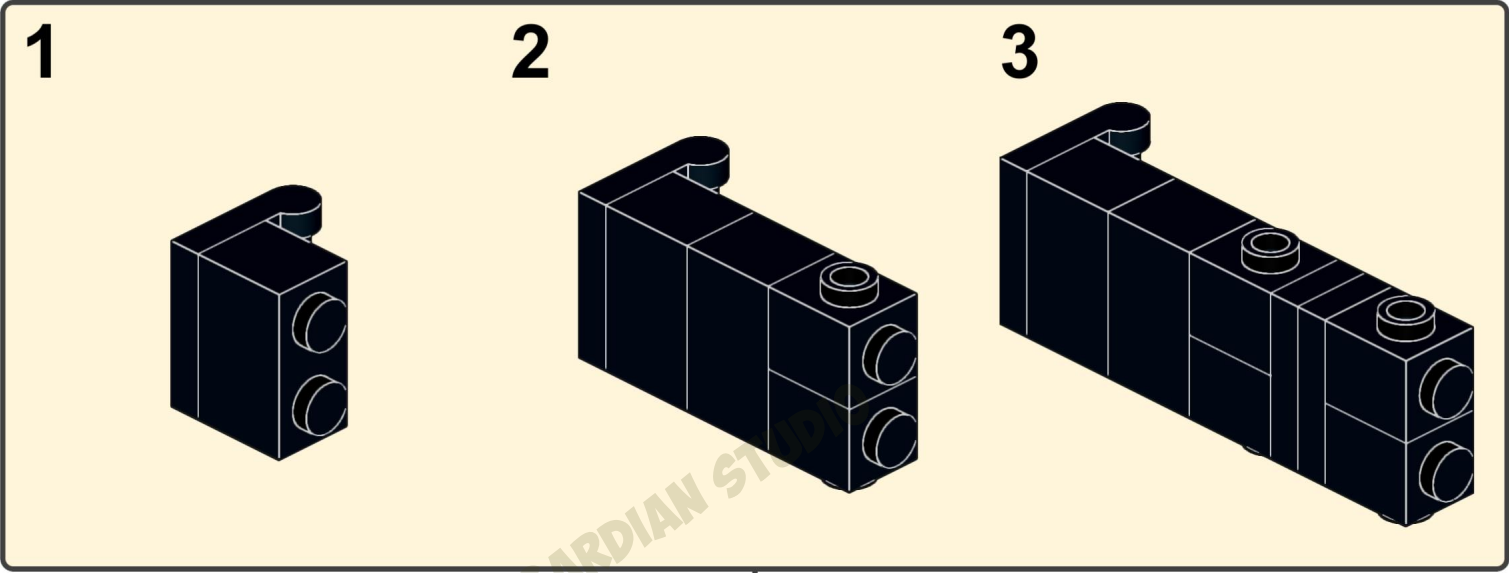

2x

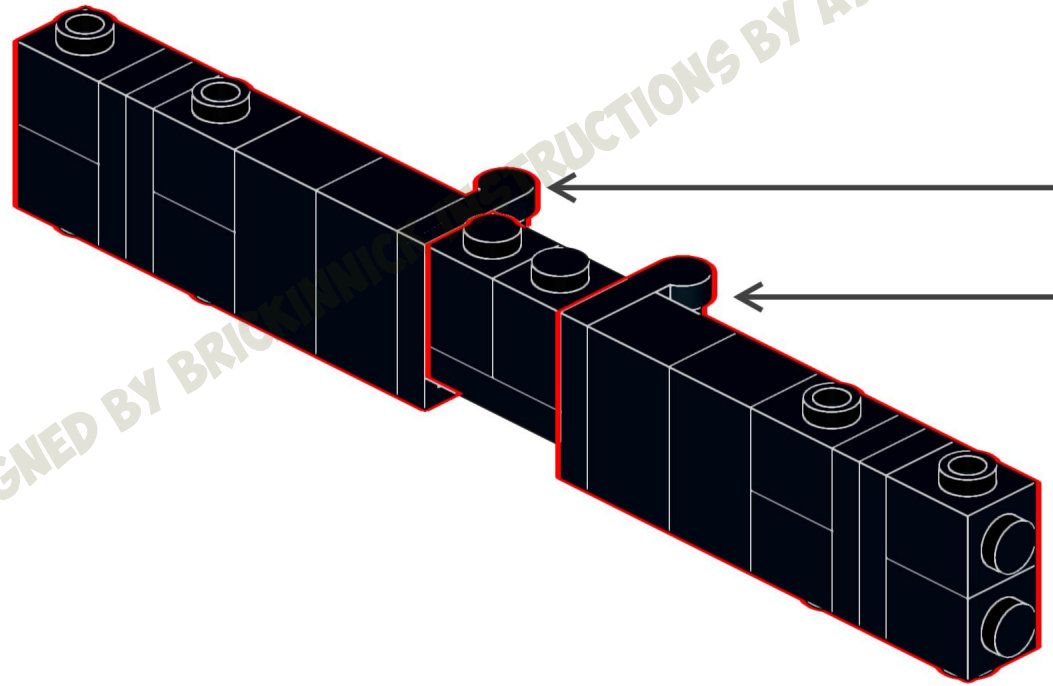

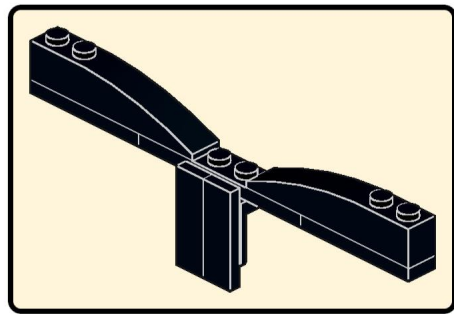
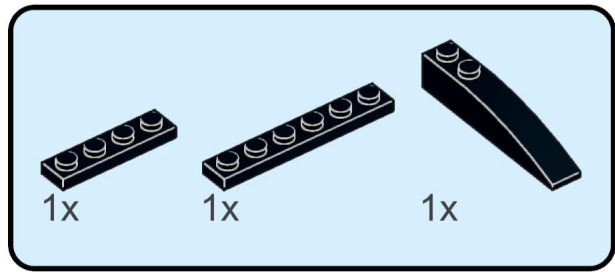

4

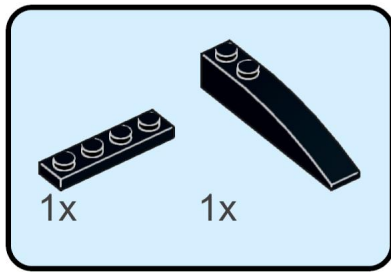
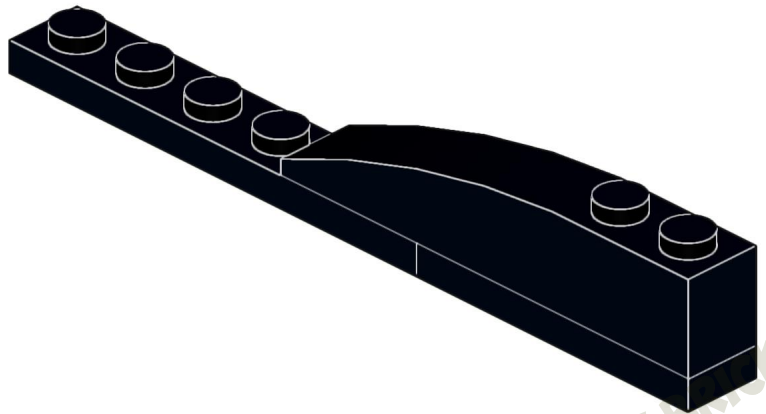

5

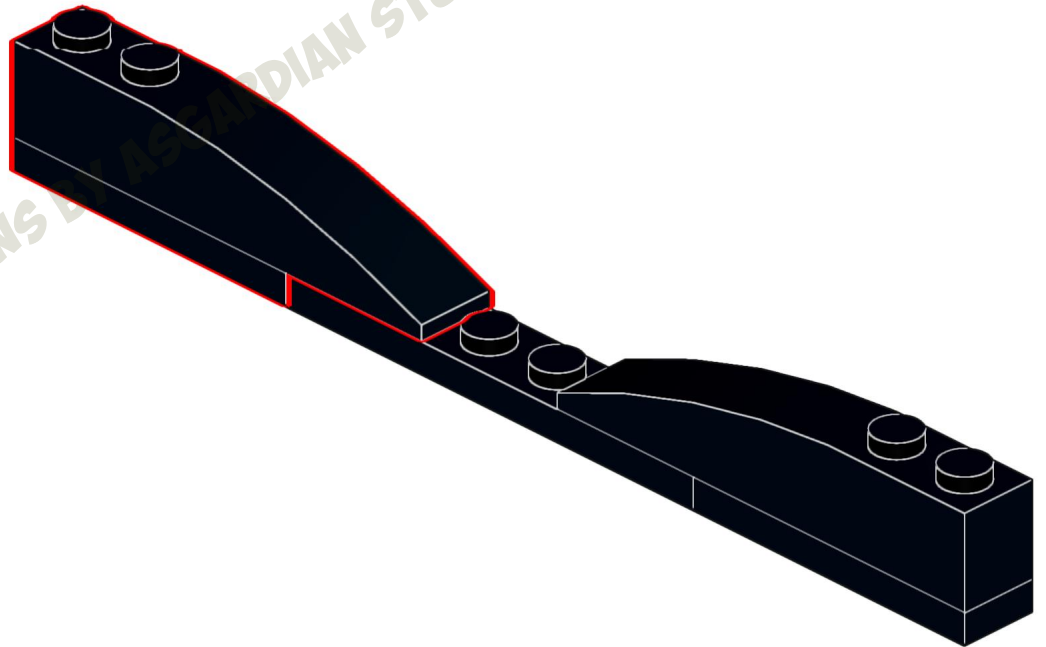

DESIGNED BY BRICKINICK INSTRUCTIONS BY BRICKINICK CANADIAN STUDIO

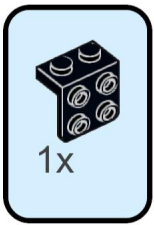

6

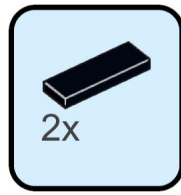
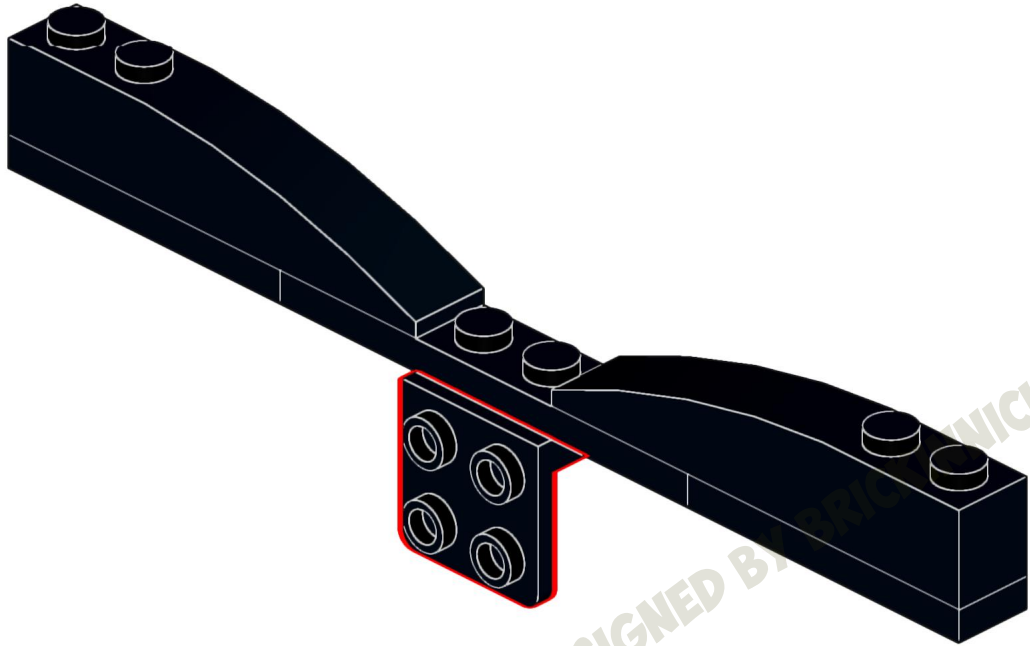

7

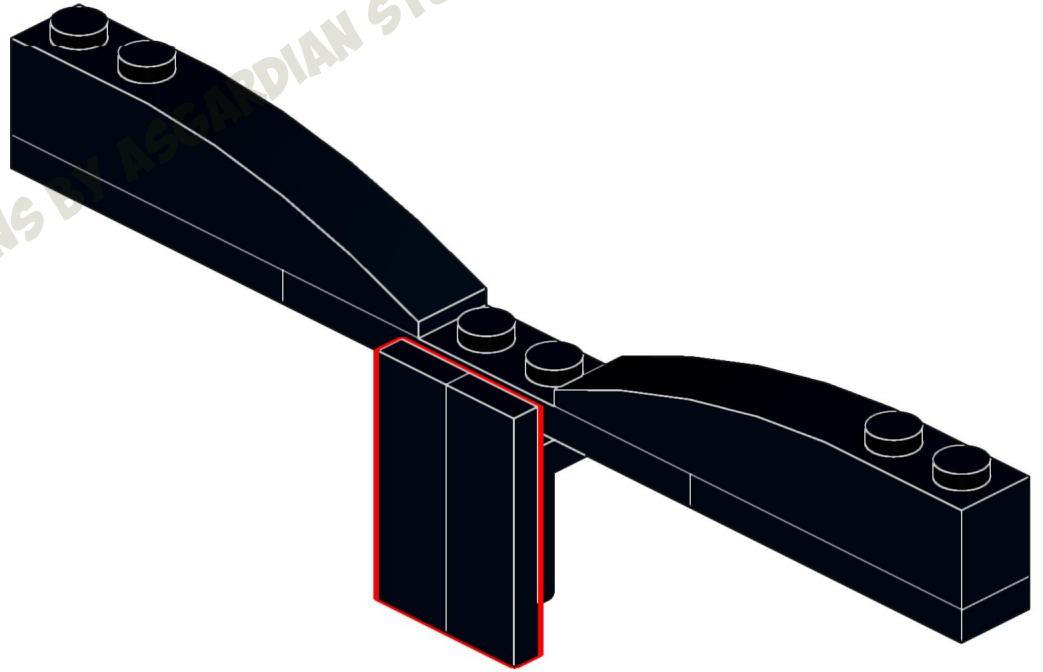

DESIGNED BY *LEWIS WICK* INSTRUCTIONS BY *LEWIS WICK* GARDIAN STUDIO

8

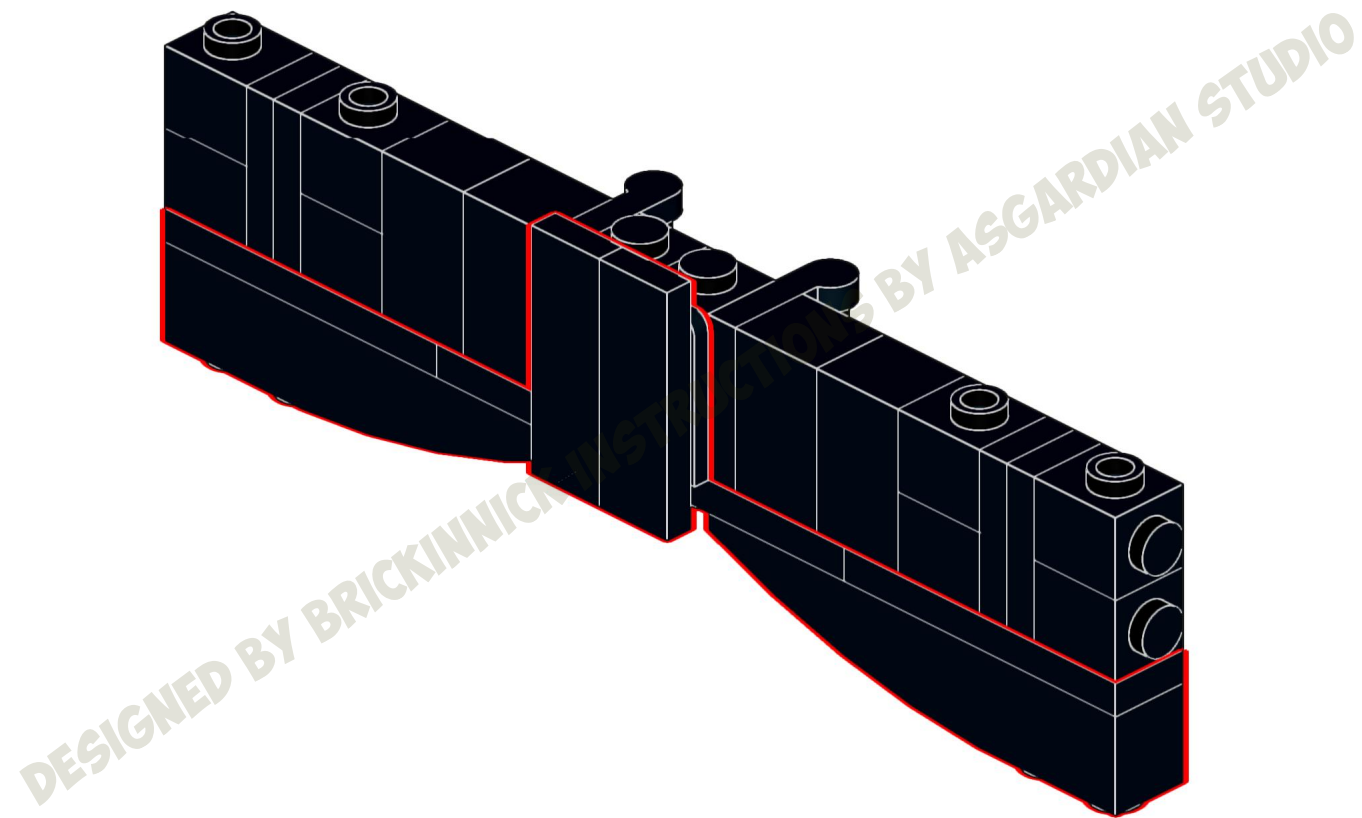

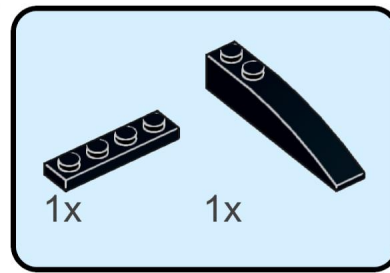
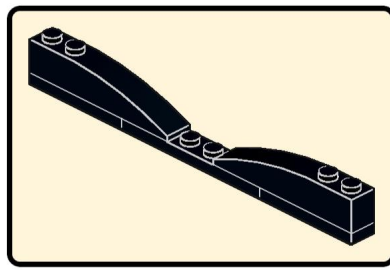
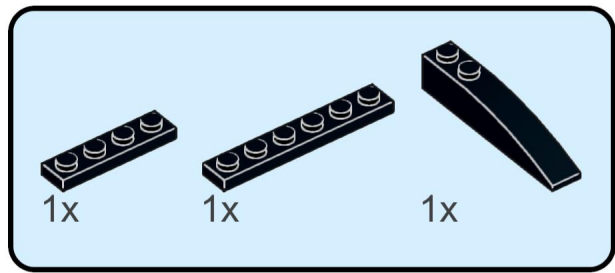

9

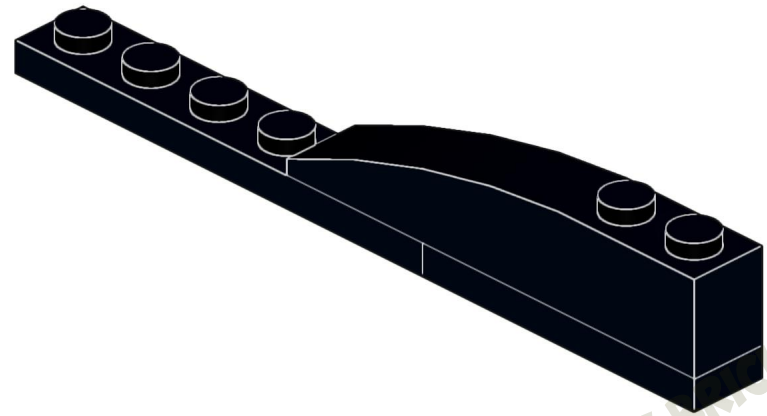

10

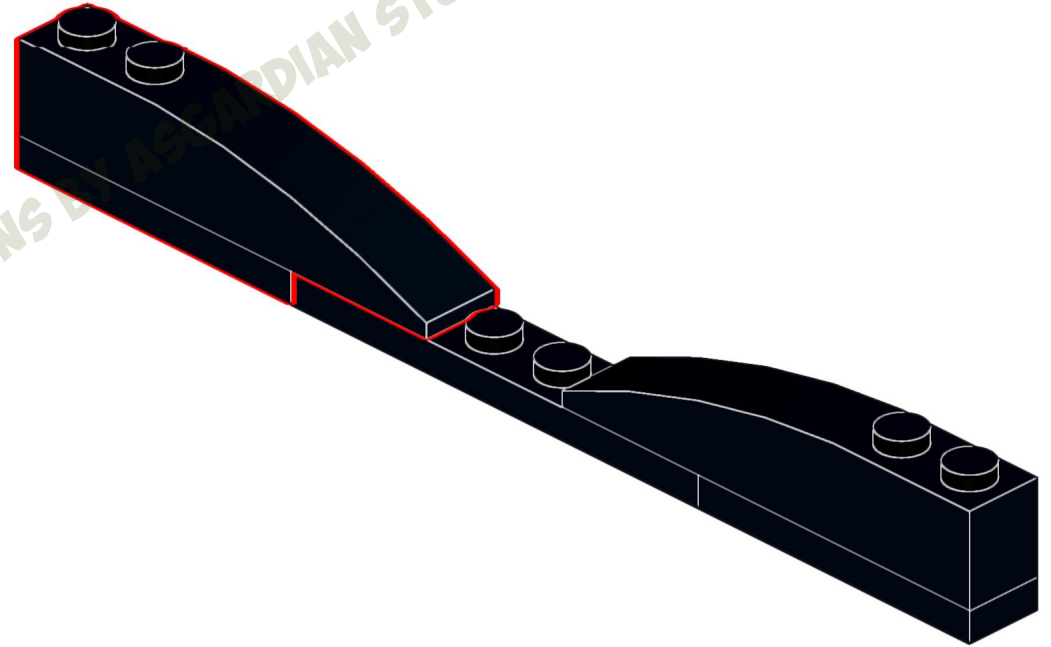

DESIGNED BY BRICKINICK INSTRUCTIONS BY BRICKINICK STUDIO

11

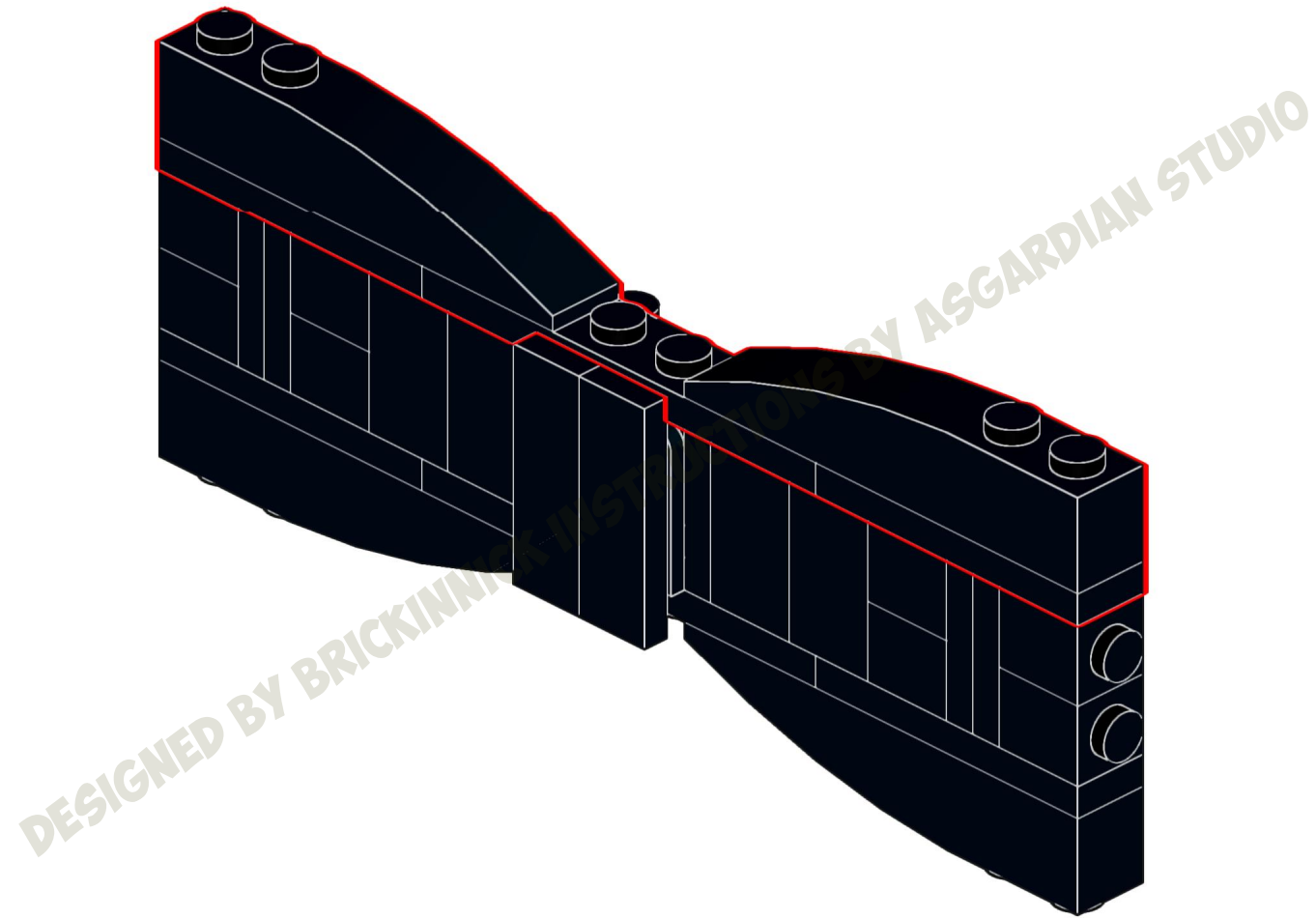



10x
87087
Black

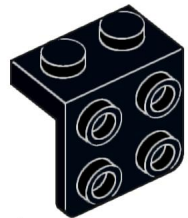

1x
44728
Black



5x
3023
Black

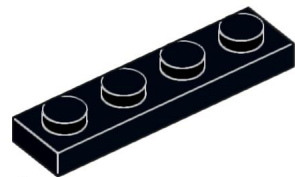

4x
3710
Black

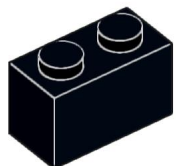

4x
3004
Black



2x
3666
Black



2x
48336
Black



2x
63864
Black

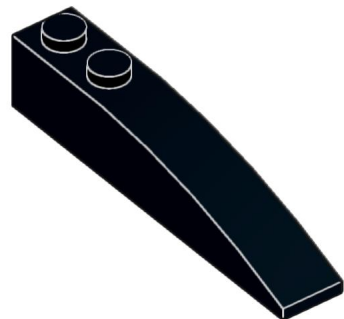

4x
42022
Black

DESIGNED BY BRICKINNICK INSTRUCTIONS BY ASGARDIAN STUDIO