

SEE PERFORMANCE CHART ON PAGE 2

STANDARD FINISHES

Black, White, & Silver

SPECIAL FINISH COLORS - Longer Lead Time

Orange, Forest Green, Bronze, Moss Green, Slate Gray, Blue, Red, Yellow

LUX | **ENABLED**



LIGHT LOSS FACTOR		
CCT	CRI	%
4000K	84+	100%
3500K	84+	97.1%
3000K	84+	95.7%
2700K	84+	94.1%
4000K	92+	88.9%
3500K	92+	85.5%
3000K	92+	83.8%
2700K	92+	82.4%

ORDER GUIDE

A	B	C	D	E	F	G	H	I	J	K	L	M
EXAMPLE: FLKs.4-P-DI DLAM/IXBT 542 6 27K 9 UNV S1 W W HC 24 WC EB												

OPTIONS

N (Multiple Selections)

A. MODEL	B. DISTRIBUTION	C. DIRECT/INDIRECT OUTPUT			D. LUMINAIRE LENGTHS
FLKs.4 - P - DI	DLAM/IXBT	37% Direct-Lambertian	500	567 lm/ft	(D-213/I-354)
		63% Indirect Extreme Bat Wing	800	845 lm/ft	(D-316/I-529)
			1100	1119 lm/ft	(D-419/I-700)
	DLAM/IBAT	52% Direct Lambertian	400	415 lm/ft	(D-215/I-200)
		48% Indirect Bat Wing	600	608 lm/ft	(D-315/I-294)
			800	810 lm/ft	(D-419/I-392)
DBAT/IBAT	47% Direct Bat Wing	400	453 lm/ft	(D-215/I-238)	
	53% Indirect Bat Wing	600	671 lm/ft	(D-319/I-353)	
		800	883 lm/ft	(D-419/I-464)	
		1100	1107 lm/ft	(D-525/I-583)	
		1300	1330 lm/ft	(D-630/I-700)	
		1500	1555 lm/ft	(D-737/I-819)	

NOTES: Indirect Output Varies. Refer to distribution/performance charts on page 2 for detailed outputs. Please see Pattern Guide on p.2 for further details. More length options. Individuals only available in 2, 3, 4, 5 and 6 footers.

E. COLOR TEMPERATURE	F. CRI	G. VOLTAGE	H. DRIVER	I. HOUSING FINISH	J. END CAP/HUB FINISH
27K 30K 35K 40K	2700K 3000K 3500K 4000K	80 + CRI 90 + CRI	UNV 120 - 277v 347 347v	S1 1% Dimming (0 - 10v) LDE1 Lutron Hi-Lume 1% ELO 0.1% EldoLED DXL 1% Dexal	Standard W White B Black S Silver
				Special (Longer Lead Time) LC LUX MG Moss OR Orange BL Blue BZ Bronze RD Red SG Slate Gray CC Custom Color YW Yellow FG Forest Green	Standard W White B Black S Silver
					Special (Longer Lead Time) LC LUX MG Moss OR Orange BL Blue BZ Bronze RD Red SG Slate Gray CC Custom Color YW Yellow FG Forest Green

90 CRI option has an R9 value greater than 60. 347 may not be available in all configurations. See page 3 for more information on finishes. Consult factory for custom colors. (Power feeds and canopies excluded).

K. MOUNTING TYPE	L. SUSPENSION LENGTH	M. CANOPIES	N. CONTROLS & FACTORY OPTIONS
HC Ceiling Mount Into J Box	24 42 102 150	WC White Canopy BC Black Canopy SC Silver Canopy	<ul style="list-style-type: none"> AWNR-W Lutron Athena Wireless Node (RF-only) in White AWNR-B Lutron Athena Wireless Node (RF-only) in Black EB Emergency Battery (10 - Watt)
Each power over cable must terminate into a junction box.	Each individual suspension length is adjustable.	Select feed and canopy choice. May choose more than one option in this category.	Emergency battery is remote only. Emergency test switch is remote mounted by contractor.

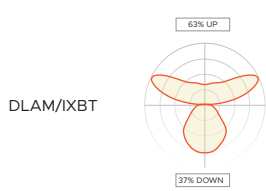

DLAM/IBBT

UP TO 119 lm/W PERFORMANCE						
DELIVERED LUMENS (PER 4ft)	6681	5548	4474	3381	2267	
ORDER CODE	1600	1300	1100	800	500	
LUMENS PER FT.	63% UP	1046	868	700	529	354
	37% DOWN	625	519	419	316	213
WATTS PER FOOT	14.53	11.83	9.35	7.05	4.73	
EFFICACY (lm/W)	115.0	117.3	119.6	119.9	119.9	
CALCULATED L80 (h)	80,000					

Performance based on 4-foot luminaire at 4,000K @ 25-degrees C

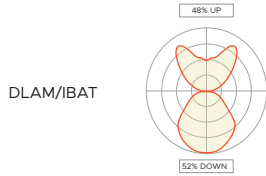

DLAM/IBAT

UP TO 119 lm/W PERFORMANCE							
DELIVERED LUMENS (SYSTEM)	5673	4897	4056	3241	2433	1660	
ORDER CODE	1400	1200	1000	800	600	400	
LUMENS PER FT.	49% UP	684	590	489	392	294	200
	51% DOWN	735	634	525	419	315	215
WATTS PER FOOT	12.20	10.40	8.55	6.80	5.08	3.65	
EFFICACY (lm/W)	116.3	117.7	118.6	119.2	119.9	113.7	
CALCULATED L80 (h)	80,000						

Performance based on 4-foot luminaire at 4,000K @ 25-degrees C

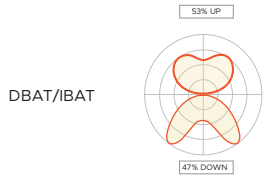

DBAT/IBAT

UP TO 117 lm/W PERFORMANCE							
DELIVERED LUMENS (SYSTEM)	6221	5318	4428	3530	2685	1812	
ORDER CODE	1500	1300	1100	800	600	400	
LUMENS PER FT.	53% UP	819	700	583	464	353	238
	47% DOWN	737	630	525	419	319	215
WATTS PER FOOT	13.83	11.55	9.48	7.53	5.70	3.95	
EFFICACY (lm/W)	112.5	115.1	116.8	117.3	117.8	114.7	
CALCULATED L80 (h)	80,000						

Performance based on 4-foot luminaire at 4,000K @ 25-degrees C

LIGHT SOURCE

Long life name brand LED chips and boards to ensure the highest of quality while providing even and smooth illumination throughout our luminaires.

Our luminaires are available in 2700K, 3000K, 3500K and 4000K color temperature .

Optional 80CRI or 90CRI available in all CCT options.

LUMEN MAINTENANCE

The projected lumen maintenance of the name brand mid-powered LED's are projected to maintain 80% (L80) of their initial output for +80,000 hours.

CONSTRUCTION

The housings are constructed of (6063T5) extruded aluminum. Our internal joiner system is designed to the highest of standards to ensure our precision cut housings align and fit tightly without light leak. Our precision fitting end caps are constructed out of die cast aluminum.

FINISH

Polyester powder, low gloss textured paint finish applied after a multi-stage pretreatment. Standard luminaire finishes include white, silver, and black. Custom color options are available. (Consult Factory).

INDIVIDUAL STRAIGHT

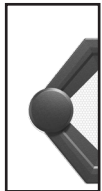
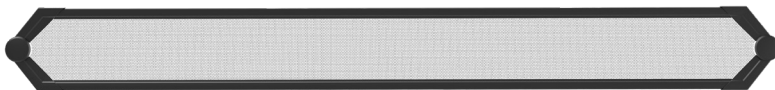

ENDS

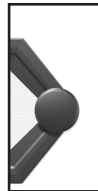

OPTICS

Anodic Light Guide Technology; Direct & Indirect Batwing Distribution.

DRIVERS (REMOTE)

All of our luminaires come standard with 1% dimming and THD <20% utilizing 0-10v constant current protocol. 120v/277v is standard with the option of 347v. For maximum remote distance see chart below.

EMERGENCY

An integral factory installed 10 watt emergency battery pack is contained in the remote driver enclosure. Emergency circuit and Night Light circuit capable by connecting to appropriate circuit in the field.

LUMINAIRE LENGTH

Our FLKs.4 Pendant Direct Indirect luminaire series are available in 2',3',4',5 & 6' individual panel lengths or continuous row configurations. Continuous row configurations are joined together on-site utilizing the joiner kits provided.

LUMINAIRE WEIGHT

The approximate weight of a four foot luminaire is 4lbs Including end caps assembled.

LUMINAIRE SUSPENSION

The FLKs.4 features Power Over Cable suspension featuring a kevlar jacketed cable and is field adjustable.

INDIVIDUAL UNITS WEIGHTS	
Luminaire	Weight
2 Foot Unit	2lbs
3 Foot Unit	3lbs
4 Foot Unit	4lbs
5 Foot Unit	5lbs
6 Foot Unit	6lbs

Remote Driver Distance	
Wire Size	Distance
22 AWG	18 feet
20 AWG	29 feet
18 AWG	46 feet
16 AWG	74 feet
14 AWG	95 feet

Distance is a maximum based on an assumption of a TV drop across the full distance.



PATTERN GUIDE

W. FLKs.4 PATTERN

FRUN	System Run Lengths. Total Footage
FSL	FLKs.4 Straight-L (90-180° - Hub Setting 90°- 0°) - See Pattern Guide on p.3 for further details.
FTY	FLKs.4 T-Y (90-135°- Hub Setting 90°- 45°) - See Pattern Guide on p.4 for further details.
FX	FLKs.4 X (90°) - See Pattern Guide on p.5 for further details.
FSR	FLKs.4 Square-Rectangle (90°) - See Pattern Guide on p.6 for further details.
FSR(X)	Multiple FLKs.4 Square-Rectangle (90° & 180°) - See Pattern Guide on p.6 for further details.
FH	FLKs.4 Hex (120° - Hub Setting 60°) - See Pattern Guide on p.7 for further details.
FG	FLKs.4 Octagon (135° - Hub Setting 45°) - See Pattern Guide on p.7 for further details.
FCC	Custom Pattern - Sketch or Drawing Always Required

X. PATTERN DIMENSIONS

AxBxCxD...
AxB
AxBxC
AxBxCxD
AxBxCxDxE
AxBxCxDExFxG...
AxBxCxDExF
AxBxCxDExFxGxH

CONTINUOUS RUN ORDER GUIDES

Please use the following run guides for fixture ordering. If your product will require a submittal, our in-house Application Engineering Team will work closely with you on your project. These are our suggested standard run configurations. Alternate options available, consult factory.

GUIDE

W. FLKs.4

FRUN	System Run Length
------	-------------------

X. PATTERN DIMENSIONS

Total footage

ALUMINUM PRODUCT ORDER GUIDE

RUN LENGTH (ft)	RUN CONFIGURATION - SECTION LENGTHS	RUN LENGTH (ft)	RUN CONFIGURATION - SECTION LENGTHS
7	4' + 3'	29	6' + 6' + 6' + 6' + 5'
8	4' + 4'	30	6' + 6' + 6' + 6' + 6'
9	5' + 4'	31	6' + 5' + 5' + 5' + 5' + 5'
10	5' + 5'	32	6' + 5' + 5' + 5' + 5' + 6'
11	6' + 5'	33	6' + 6' + 6' + 5' + 5' + 5'
12	6' + 6'	34	5' + 6' + 6' + 6' + 6' + 5'
13	5' + 3' + 5'	35	6' + 6' + 6' + 6' + 6' + 5'
14	5' + 4' + 5'	36	6' + 6' + 6' + 6' + 6' + 6'
15	5' + 5' + 5'	37	6' + 5' + 5' + 5' + 5' + 5' + 6'
16	4' + 4' + 4' + 4'	38	4' + 6' + 6' + 6' + 6' + 6' + 4'
17	6' + 5' + 6'	39	5' + 6' + 6' + 6' + 6' + 6' + 4'
18	6' + 6' + 6'	40	6' + 6' + 6' + 4' + 6' + 6' + 6'
19	5' + 5' + 5' + 4'	41	6' + 6' + 6' + 5' + 6' + 6' + 6'
20	5' + 5' + 5' + 5'	42	6' + 6' + 6' + 6' + 6' + 6' + 6'
21	6' + 5' + 5' + 5'	43	4' + 6' + 6' + 6' + 6' + 6' + 6' + 3'
22	6' + 5' + 5' + 6'	44	4' + 6' + 6' + 6' + 6' + 6' + 6' + 4'
23	6' + 6' + 6' + 5'	45	5' + 6' + 6' + 6' + 6' + 6' + 6' + 4'
24	6' + 6' + 6' + 6'	46	5' + 6' + 6' + 6' + 6' + 6' + 5'
25	5' + 5' + 5' + 5' + 5'	47	6' + 6' + 6' + 6' + 6' + 6' + 5'
26	6' + 5' + 5' + 5' + 5'	48	6' + 6' + 6' + 6' + 6' + 6' + 6'
27	6' + 5' + 5' + 5' + 6'	49	4' + 6' + 6' + 6' + 6' + 6' + 6' + 3'
28	5' + 6' + 6' + 6' + 5'	50	4' + 6' + 6' + 6' + 6' + 6' + 6' + 4'

*Standard Run Configurations Shown, Consult Factory for Custom Configurations.



STANDARD PATTERNS
Individual Flex Horizontal Line 2, 3, 4, 5, 6 ft lengths.

PATTERN GUIDE

W. FLKs.4 PATTERN

FSL

FLKs.4 Straight-L
(90-180° - Hub Setting 90°- 0°)

X. PATTERN DIMENSIONS

AxB

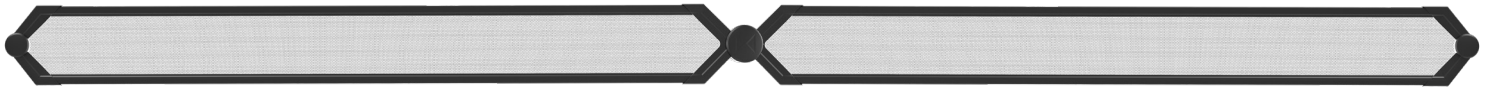

TWO ARM ROTATIONAL HUB

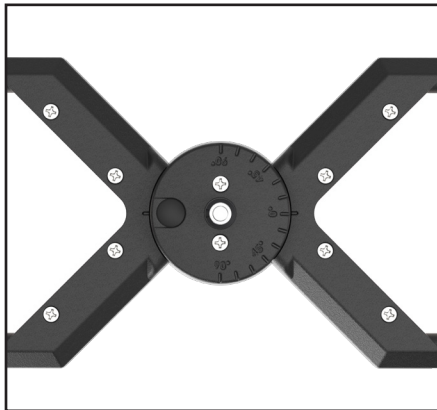

CLOSE UP OF ROTATIONAL HUB

FSL (Straight to L Pattern) is field adjustable in 15° increments from 180° to 90°. FSL Pattern shown is straight 180°, Hub setting 0°.

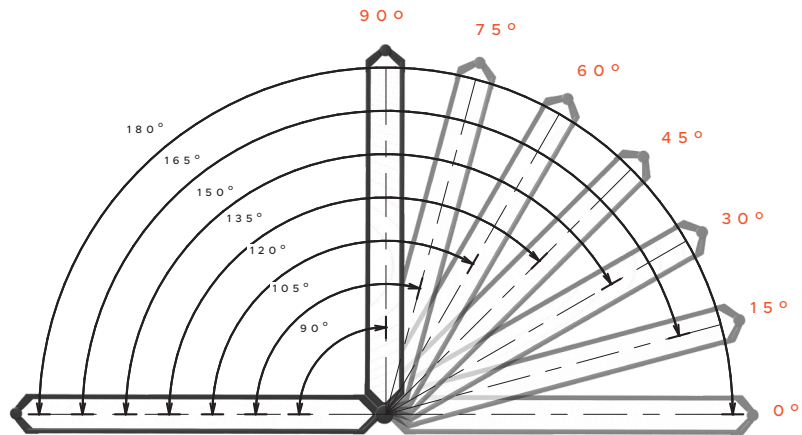

STANDARD TWO ARM FLKs.4 ROTATIONAL HUB PATTERN EXAMPLES



FSL (Straight to L Pattern) is field adjustable in 15° increments from 180° to 90°. FSL Pattern shown is two arm 180°, Hub setting 0°.

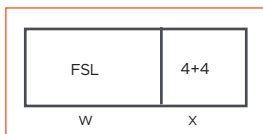

D

Above code gets entered in "D" LENGTH field of ordering guide.



FSL (Straight to L Pattern) is field adjustable in 15° increments from 180° to 90°. Pattern shown is two arm 150°, Hub setting 30°.

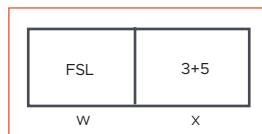

D

Above code gets entered in "D" LENGTH field of ordering guide.



Field adjustable in 15° increments from 180 degree to 90°. Pattern shown is two arm 150°, Hub setting 30°.

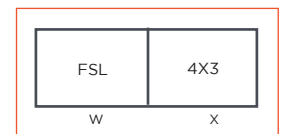

D

Above code gets entered in "D" LENGTH field of ordering guide.



MULTIPLE ARM PATTERNS

Arm lengths 2, 3, 4, 5, 6 ft lengths. Rotational in 15 degree increments adjustments are made in-field with the exception of 90 degree 4 arm pattern.

PATTERN GUIDE

W. FLKs.4 PATTERN

FTY

FLKs.4 T-Y
(90-135°- Hub Setting 90°- 45°)

X. PATTERN DIMENSIONS

AxBxC

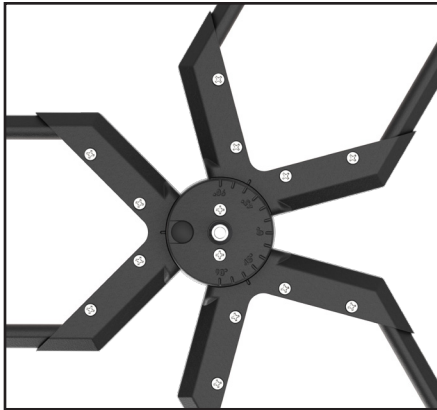

CLOSE UP OF ROTATIONAL HUB

FTY (T or Y Pattern) is field adjustable in 15° increments from 90° to 135°. FTY Pattern corners shown is Y 120°, Hub setting 60°.

90° to 135° ROTATIONAL PATTERN

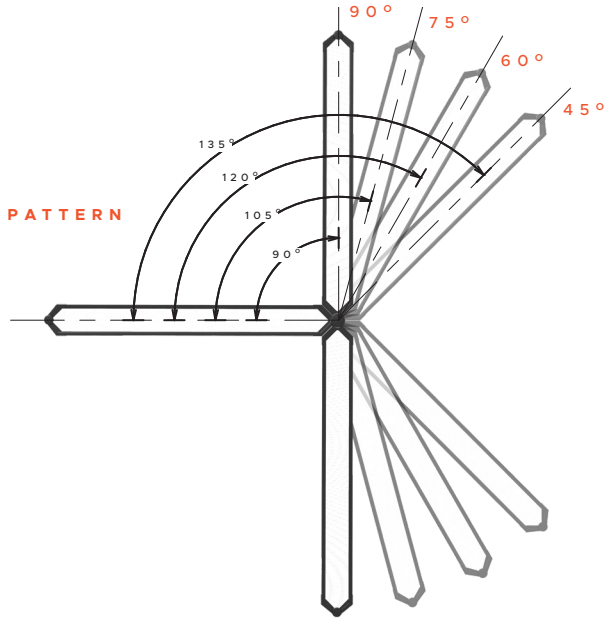

STANDARD LENGTH FLKs.4 HUB PATTERN EXAMPLES

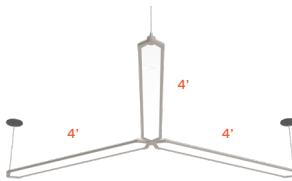

FTY (T or Y) pattern is field adjustable in 15° increments from 0° to 90°. FTY pattern shown is three arm at 120°, Hub setting: Starter position with 60° position, and 60° position to create your 120°; to create your Y pattern.

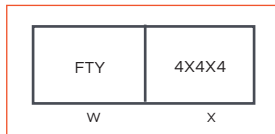

D

Above code gets entered in "D" LENGTH field of ordering guide.

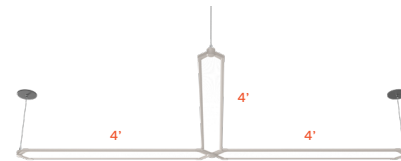

FTY (T or Y) pattern is field adjustable in 15° increments from 0° to 90°. FTY pattern shown is three arm at 90°, and 180°, Hub setting: Starter position with 90° position, and 0° position to create your T pattern.

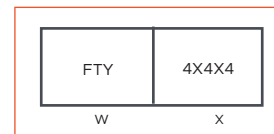

D

Above code gets entered in "D" LENGTH field of ordering guide.

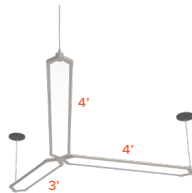

Field adjustable in 15° increments from 0° to 90°. Three arm pattern shown is three arm at 105°, 120°, 135° Hub setting: 75°, 60°, 45; to create your Y pattern.°.

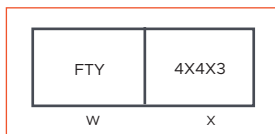

D

Above code gets entered in "D" LENGTH field of ordering guide.

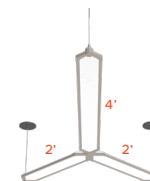

Field adjustable in 15° increments from 0° to 90°. Three arm pattern shown is three arm at 135°, and 135° Hub setting: Starter position with 90° position, and 0° position; to create your Y pattern.

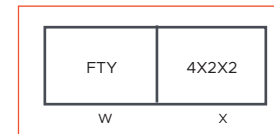

D

Above code gets entered in "D" LENGTH field of ordering guide.



MULTIPLE ARM STANDARD PATTERNS

Arm lengths 2, 3, 4, 5, 6 ft lengths. Rotational in 15 degree increments adjustments are made in-field with the exception of 90 degree 4 arm pattern.

PATTERN GUIDE

W. FLKs.4 PATTERN

FX
FSR
FSR(X)

FLKs.4 X
FLKs.4 Square-Rectangle
Multiple FLKs.4 Square-Rectangle

(90°- Hub Setting 90°)

X. PATTERN DIMENSIONS

AxBxCxD
AxBxCxD
AxBxCxDxExFxG...

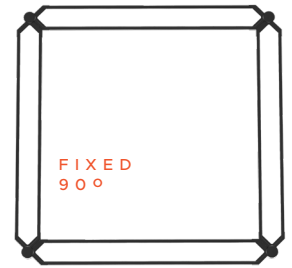
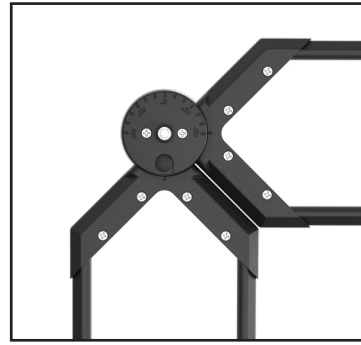
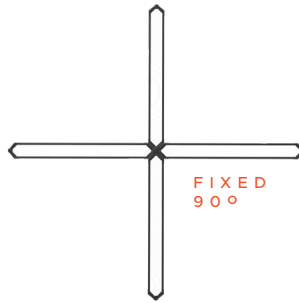
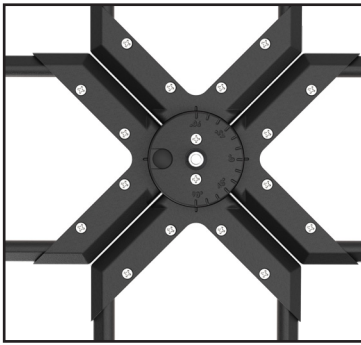

FX (X) pattern is fixed at 90°. FX pattern corners shown with four fixed 90° arms.

FSR (Square or Rectangle) pattern is fixed at 90°. FSR Square pattern corner shown with four fixed 90° arms.

STANDARD LENGTH FLKs.4 HUB PATTERN EXAMPLES

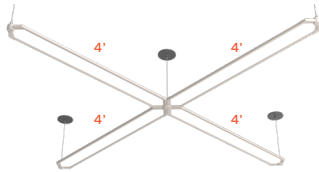

FX (X) pattern is fixed at 90°. FX pattern shown with four fixed 90° arms.



FSR (Square or Rectangle) pattern is fixed at 90°. FSR pattern shown with four fixed 90° arms.

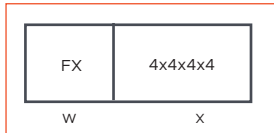

D

Above code gets entered in "D" LENGTH field of ordering guide.

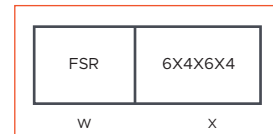

D

Above code gets entered in "D" LENGTH field of ordering guide.

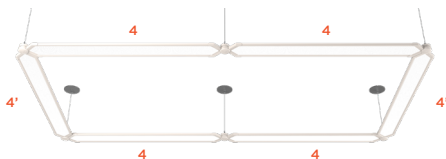

FSR (Square or Rectangle) pattern is fixed at 90° and 180°. FSR pattern shown with four fixed 90° arms, and two 0° arms.

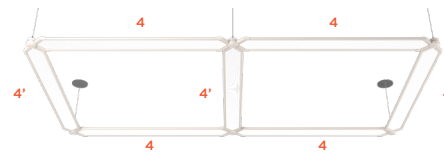

FSR(2) (Two Square or Rectangle) patterns are fixed at 90° and 180°. FSR(2) pattern shown with four fixed 90° arms, and two 0° arms.

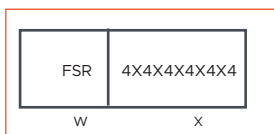

D

Above code gets entered in "D" LENGTH field of ordering guide.

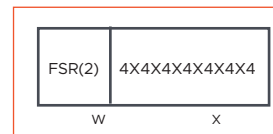

D

Above code gets entered in "D" LENGTH field of ordering guide.



MULTIPLE ARM PATTERNS

Arm lengths 2, 3, 4, 5, 6 ft lengths. Rotational hub is adjustable in 15° increments. adjustments are made in-field with the exception of 90 degree 4 arm pattern.

PATTERN GUIDE

W. FLKs.4 PATTERN

FH FLKs.4 Hex
(120° - Hub Setting 60°)
FG FLKs.4 Octagon
(135° - Hub Setting 45°)

X. PATTERN DIMENSIONS

AxBxCxDxExF
Total Footage
AxBxCxDxExFxGxH
Total Footage

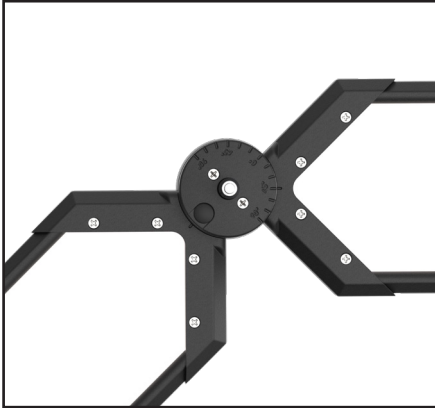

FH (Hex) Pattern shown with six 4' arms 120°, Hub setting 60°.

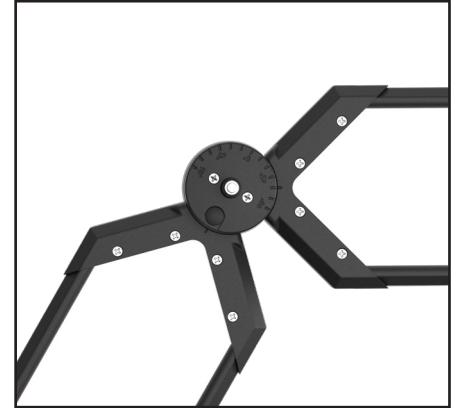

FG (Octagon) Pattern shown with six 4' arms 135°, Hub setting 45°.

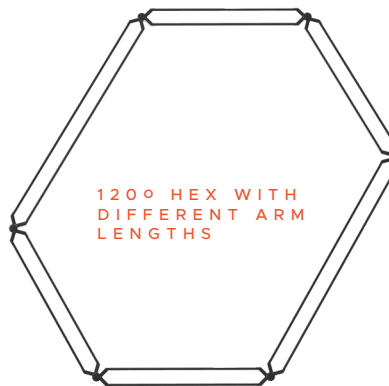
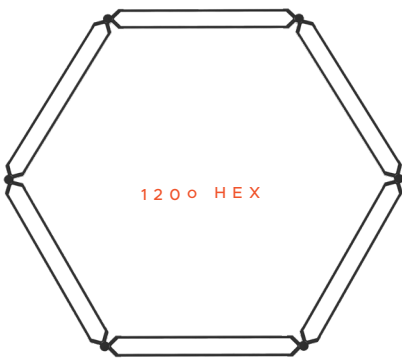

STANDARD LENGTH FLKs.4 HUB PATTERN EXAMPLES

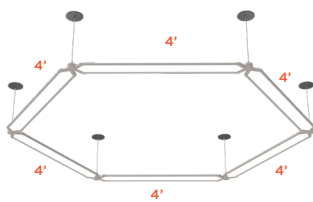

FH (Hex) Pattern shown with six 4' arms 120°, Hub setting 60°.

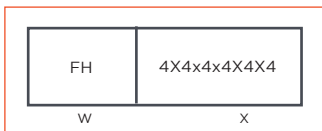

D

Above code gets entered in "D" LENGTH field of ordering guide.

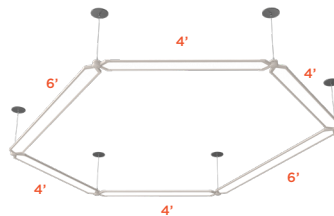

FH (Hex) Pattern shown is four 4' and two 6' arms 120°, Hub setting 60°.

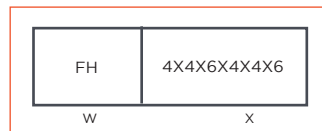

D

Above code gets entered in "D" LENGTH field of ordering guide.

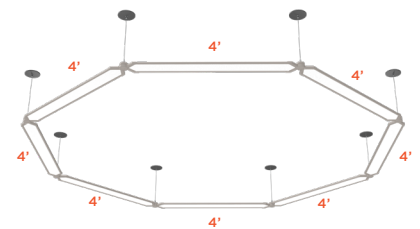

FG (Octagon) Pattern shown with six 4' arms 135°, Hub setting 45°.

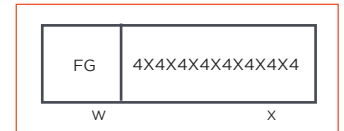

D

Above code gets entered in "D" LENGTH field of ordering guide.



CUSTOM PATTERNS

Include a simple sketch to illustrate your projects scope. Use the key provided to identify length of arms and runs on page 9. (Does not need to be to same scale).



STARTER



JOINER



ENDER

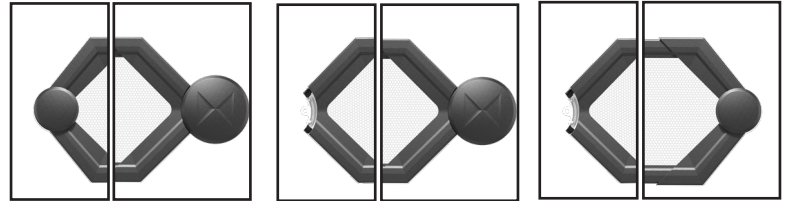

STARTER | HUB

JOINER | HUB

HUB | ENDER

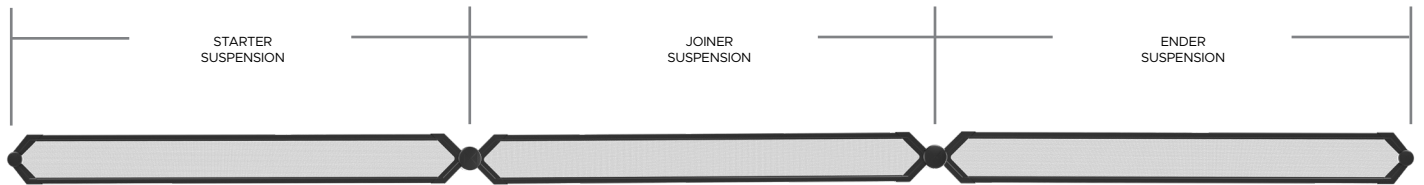

EXAMPLE

NOMINAL JOINER RUN FOR SAME LENGTH UNITS

	Starter Suspension	Joiner Suspension	Ender Suspension	Overall Length
2 Foot Unit	24.00"	25.00"	24.00"	49 Foot Unit
3 Foot Unit	36.00"	37.00"	36.00"	73 Foot Unit
4 Foot Unit	48.00"	49.00"	48.00"	97 Foot Unit
5 Foot Unit	60.00"	61.00"	60.00"	121 Foot Unit
6 Foot Unit	72.00"	73.00"	72.00"	145 Foot Unit

NOTES

Customer to provide a drawing for all patterns with more than (1) hub connector.

CUSTOM LENGTH PATTERN EXAMPLES



PATTERN GUIDE

W. FLKs.4 PATTERN

FCC

Custom Pattern
- Sketch or Drawing Always Required
Multiple Links

X. PATTERN DIMENSIONS

Run Lengths (Quote #, A, B, C...)
Number created by LUX



D



SKETCH CUSTOM PATTERN & DIMENSIONS

Include a simple sketch to illustrate your projects scope.
Use the key provided to identify length of arms, runs and connectors.
(Does not need to be to same scale).

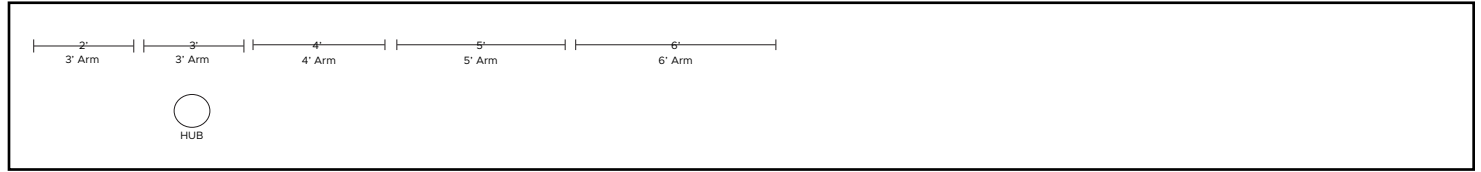

YOUR SKETCH



DRIVER HOUSING MOUNTING OPTIONS

REMOTE HOUSING

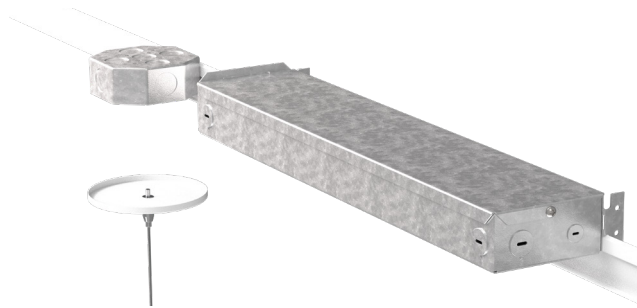

Grid-mountable driver housing with integrated T-Wing mounts.

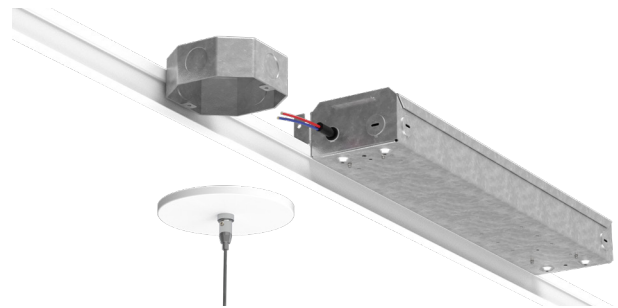

Remote-mounted driver housing with integrated mounting features, including power feed, canopy, and suspension system. Suitable for exposed conduit, or recessed junction boxes.

