

Shelford Channel

Transformer Gain Mic Preamp, Inductor EQ, Diode Bridge Compressor & SILK



Operations Manual

Important Safety Instructions

1. Read these instructions.
2. Keep these instructions.
3. Heed all warnings.
4. Follow all instructions.
5. Do not use this apparatus near water.
6. Clean only with a dry cloth.
7. Do not block any ventilation openings. Install in accordance with the manufacturer's instructions.
8. Do not install near any heat sources such as radiators, heat registers, stoves, or other apparatus (including amplifiers) that produce heat.
9. Do not defeat the safety purpose of the polarized or grounding-type plug. A polarized plug has two blades with one wider than the other. A grounding-type plug has two blades and a third grounding prong. The wide blade or the third prong are provided for your safety. If the provided plug does not fit into your outlet, consult an electrician for replacement of the obsolete outlet.
10. Protect the power cord from being walked on or pinched particularly at plugs, convenience receptacles, and the point where they exit from the apparatus.
11. Only use attachments/accessories specified by the manufacturer.
12. Use only with a cart, stand, tripod, bracket, or table specified by the manufacturer, or sold with the apparatus. When a cart is used, use caution when moving the cart/apparatus combination to avoid injury from tip-over.
13. Unplug this apparatus during lightning storms or when unused for long periods of time.
14. Refer all servicing to qualified service personnel. Servicing is required when the apparatus has been damaged in any way, such as power-supply cord or plug is damaged, liquid has been spilled or objects have fallen into the apparatus, the apparatus has been exposed to rain or moisture, does not operate normally, or has been dropped.
15. This apparatus shall not be exposed to dripping or splashing, and no object filled with liquids, such as vases or beer glasses, shall be placed on the apparatus.
16. Do not overload wall outlets and extension cords as this can result in a risk of fire or electric shock.
17. This apparatus has been designed with Class-I construction and must be connected to a mains socket outlet with a protective earthing connection (the third grounding prong).
18. This apparatus has been equipped with a rocker-style AC mains power switch. This switch is located on the rear panel and should remain readily accessible to the user.
19. The MAINS plug or an appliance coupler is used as the disconnect device, so the disconnect device shall remain readily operable.



20. NOTE: This equipment has been tested and found to comply with the limits for a Class B digital device, pursuant to part 15 of the FCC Rules. These limits are designed to provide reasonable protection against harmful interference in a residential installation. This equipment generates, uses, and can radiate radio frequency energy and, if not installed and used in accordance with the instructions, may cause harmful interference to radio communications. However, there is no guarantee that interference will not occur in a particular installation. If this equipment does cause harmful interference to radio or television reception, which can be determined by turning the equipment off and on, the user is encouraged to try to correct the interference by one or more of the following measures:

- Reorient or relocate the receiving antenna.
- Increase the separation between the equipment and the receiver.
- Connect the equipment into an outlet on a circuit different from that to which the receiver is connected.
- Consult the dealer or an experienced radio/TV technician for help.

CAUTION: Changes or modifications to this device not expressly approved by Rupert Neve Designs LLC, could void the user's authority to operate the equipment under FCC rules.

21. This apparatus does not exceed the Class A/Class B (whichever is applicable) limits for radio noise emissions from digital apparatus as set out in the radio interference regulations of the Canadian Department of Communications.

ATTENTION — *Le présent appareil numérique n'émet pas de bruits radioélectriques dépassant les limites applicables aux appareils numériques de class A/de class B (selon le cas) prescrites dans le règlement sur le brouillage radioélectrique édicté par les ministere des communications du Canada.*

22. Exposure to extremely high noise levels may cause permanent hearing loss. Individuals vary considerably in susceptibility to noise-induced hearing loss, but nearly everyone will lose some hearing if exposed to sufficiently intense noise for a period of time. The U.S. Government's Occupational Safety and Health Administration (OSHA) has specified the permissible noise level exposures shown in the following chart. According to OSHA, any exposure in excess of these permissible limits could result in some hearing loss. To ensure against potentially dangerous exposure to high sound pressure levels, it is recommended that all persons exposed to equipment capable of producing high sound pressure levels use hearing protectors while the equipment is in operation. Ear plugs or protectors in the ear canals or over the ears must be worn when operating the equipment in order to prevent permanent hearing loss if exposure is in excess of the limits set forth here:

CAUTION AVIS

RISK OF ELECTRIC SHOCK. DO NOT OPEN RISQUE DE CHOC ELECTRIQUE. NE PAS OUVRIR

CAUTION: TO REDUCE THE RISK OF ELECTRIC SHOCK DO NOT REMOVE COVER (OR BACK) NO USER SERVICEABLE PARTS INSIDE. REFER SERVICING TO QUALIFIED PERSONNEL

ATTENTION: POUR EVITER LES RISQUES DE CHOC ELECTRIQUE, NE PAS ENLEVER LE COUVERCLE. AUCUN ENTRETIEN DE PIECES INTERIEURES PAR L'USAGER. CONFIER L'ENTRETIEN AU PERSONNEL QUALIFIE.

AVIS: POUR EVITER LES RISQUES D'INCENDIE OU D'ELECTROCUTION, NE EXPOSEZ PAS CET ARTICLE A LA PLUIE OU A L'HUMIDITE

The lightning flash with arrowhead symbol within an equilateral triangle is intended to alert the user to the presence of uninsulated "dangerous voltage" within the product's enclosure, that may be of sufficient magnitude to constitute a risk of electric shock to persons.

Le symbole éclair avec point de flèche à l'intérieur d'un triangle équilatéral est utilisé pour alerter l'utilisateur de la présence à l'intérieur du coffret de "voltage dangereux" non isolé d'ampleur suffisante pour constituer un risque d'électrocution.

The exclamation point within an equilateral triangle is intended to alert the user of the presence of important operating and maintenance (servicing) instructions in the literature accompanying the appliance.

Le point d'exclamation à l'intérieur d'un triangle équilatéral est employé pour alerter les utilisateurs de la présence d'instructions importantes pour le fonctionnement et l'entretien (service) dans le livret d'instruction accompagnant l'appareil.

This symbol indicates that this product must not be disposed of with other waste. Instead, it is your responsibility to dispose of your waste equipment by handing it over to a designated collection point for the recycling of waste electrical and electronic equipment. The separate collection and recycling of your waste equipment at the time of disposal will help conserve natural resources and ensure that it is recycled in a manner that protects human health and the environment. For more information about where you can drop off your waste equipment for recycling, please contact your local city recycling office or the dealer from whom you purchased the product.

Duration, per day in hours	Sound Level dBA, Slow Response	Typical Example
8	90	Duo in small club
6	92	
4	95	Subway Train
3	97	
2	100	Typical music via head phones
1.5	102	
1	105	Siren at 10 m distance
0.5	110	
0.25 or less	115	Loudest parts at a rock concert

WARNING — To reduce the risk of fire or electric shock, do not expose this apparatus to rain or moisture.

Table of Contents

Introduction	1
Block Diagram	1
Shelford Front Panel	2
Shelford Rear Panel	4
Shelford Features	5
Specifications	9
Limited Warranty	21

Shelford Channel Block Diagram

Rupert Neve Designs Shelford Channel

Thank you for purchasing the Rupert Neve Designs Shelford Channel. We hope you enjoy using this product as much as we have enjoyed designing and building it. The Shelford Channel features Rupert Neve's first new transformer-gain, Class-A Mic Pre in over 40 years, a thoughtfully refined classic 3-band inductor EQ, an updated Diode Bridge Compressor and custom Rupert Neve Designs transformer coupled outputs with variable SILK. The Shelford Channel maintains the soul of Rupert's classics with new levels of versatility, delivering the distilled essence of over fifty years of Rupert Neve's most treasured designs.

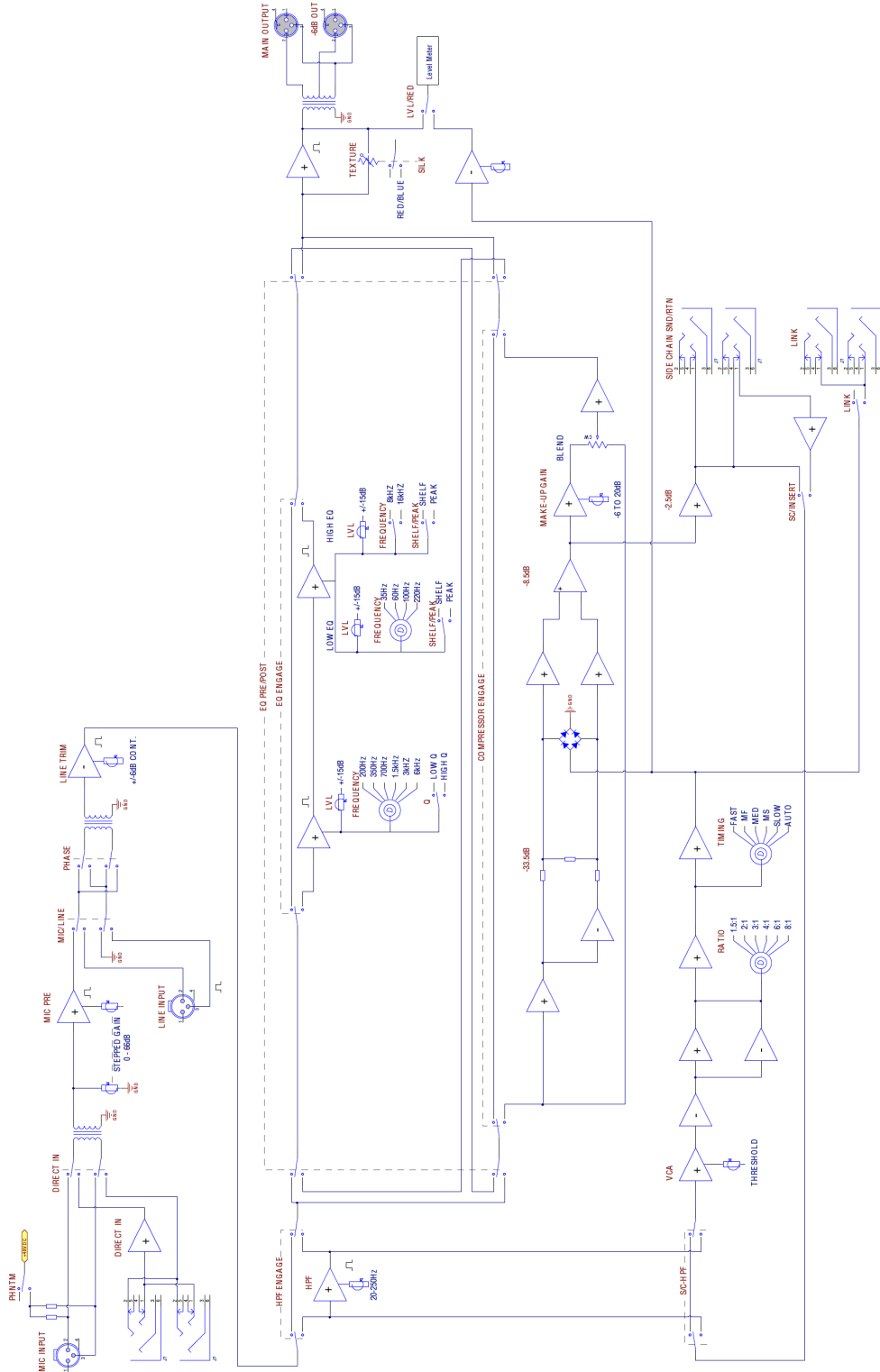

Shelford Channel Front Panel

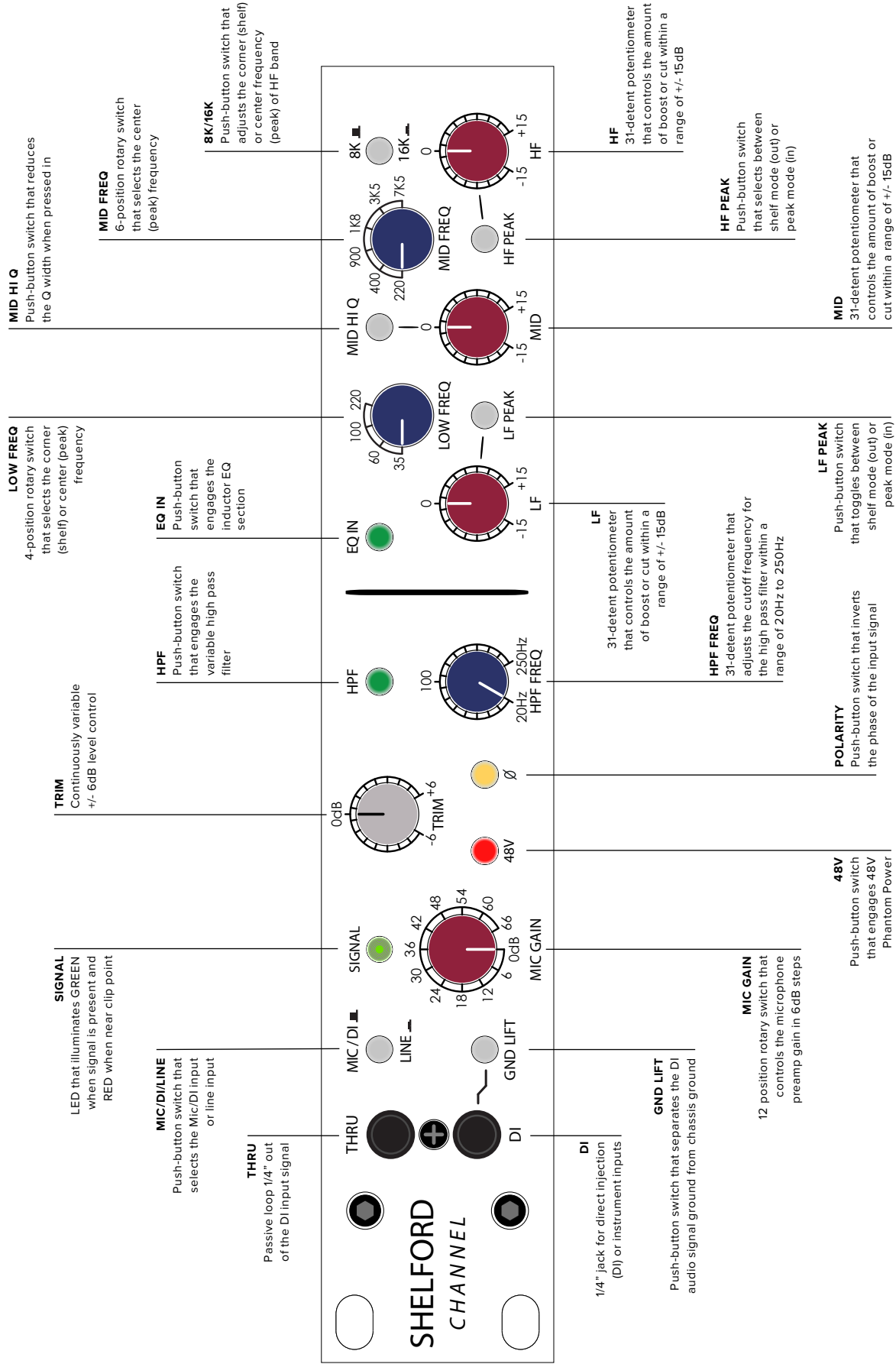

Shelford Channel Front Panel (continued)

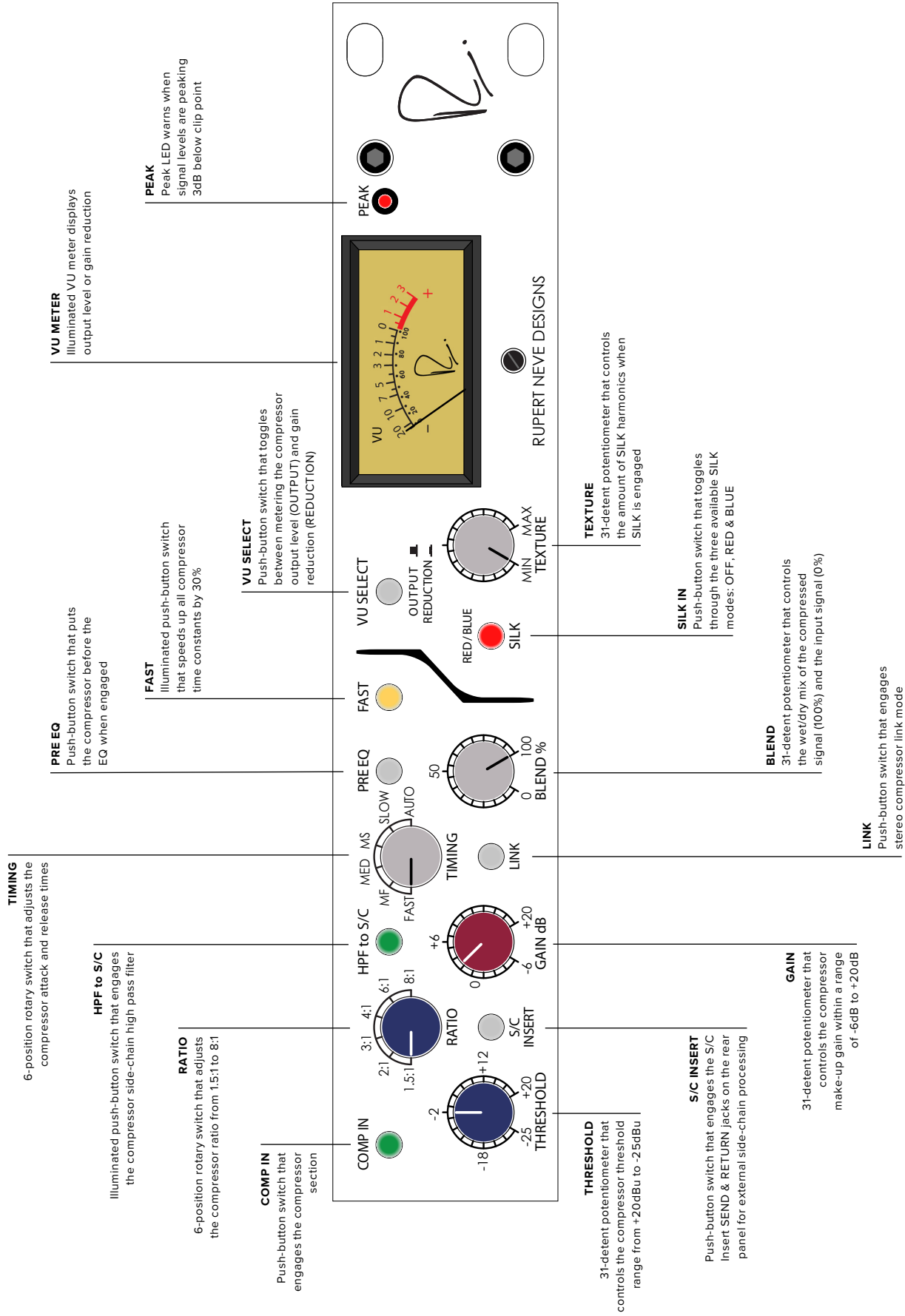

Shelford Channel Rear Panel

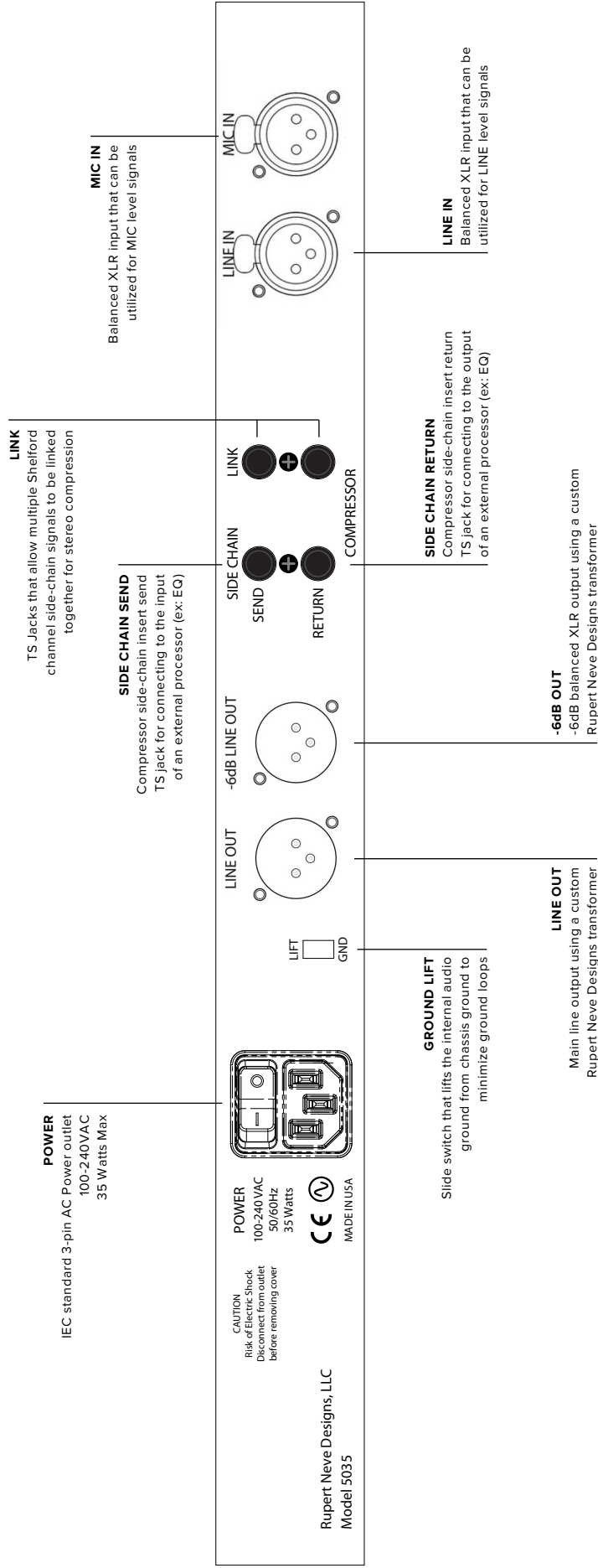

Shelford Channel Front Panel Features

THRU

Passive loop 1/4" output of the DI input signal.

DI

1/4" jack for direct injection (DI) or instrument inputs.

MIC/DI/LINE

Push-button switch that selects the Mic/DI input or line input.

GND LIFT

Push-button switch that separates the DI audio signal ground from chassis ground.

SIGNAL

LED that illuminates GREEN when signal is present and RED when near clip point.

MIC GAIN

12-position rotary switch that controls the microphone preamp gain in 6dB steps.

TRIM

31-detent potentiometer that allows the user to adjust the preamp gain within a range of +/- 6dB.

48V

Push-button switch that illuminates RED when +48V Phantom Power is engaged.

Ø (Polarity)

Push-button switch that illuminates AMBER when engaged and inverts the phase of the input signal.

HPF

Push-button switch that illuminates GREEN when the variable high pass filter is engaged.

FREQ

31-detent potentiometer that allows the user to adjust the cutoff frequency of the variable high pass filter within a range of 20 Hz to 250 Hz.

EQ IN

Push-button switch that illuminates GREEN when the inductor EQ section is engaged.

LF

31-detent potentiometer that controls the amount of boost or cut for the low frequency band within a range of +/- 15dB.

Shelford Channel Front Panel Features (continued)

LOW FREQ

4-position rotary switch that selects the corner (shelf) or center (peak) frequency of the low frequency band.

LF PEAK

Push-button switch that toggles between shelf mode (OUT) or peak mode (IN) of the low frequency band.

MID HI Q

Push-button switch that reduces the Q width of the mid frequency band when pressed in.

MID

31-detent potentiometer that controls the amount of boost or cut for the mid frequency band within a range of +/- 15dB.

MID FREQ

6-position rotary switch that selects the center (peak) frequency of the mid frequency band.

8K/16K

Push-button switch that selects between the two available high frequency shelf/peak frequencies: 8kHz (OUT) and 16kHz (IN).

HF

31-detent potentiometer that controls the amount of boost or cut for the high frequency band within a range of +/- 15dB.

COMP IN

Push-button switch that illuminates GREEN when the diode bridge compressor section is engaged.

THRESHOLD

31-detent potentiometer that controls the compressor threshold range from +20dBu to -25dBu.

RATIO

6-position rotary switch that adjusts the compressor ratio from 1.5:1 to 8:1.

S/C INSERT

Push-button switch that engages the side-chain insert SEND & RETURN jacks on the rear panel for external side-chain processing (ex: EQ).

HPF TO S/C

Push-button switch that illuminates GREEN when the compressor side-chain high pass filter is engaged.

NOTE: The GREEN 'HPF' switch will turn off when the HPF to S/C switch is engaged

Shelford Channel Front Panel Features (continued)

GAIN

31-detent potentiometer that controls the compressor make-up gain within a range of -6dB to +20dB.

TIMING

6-position rotary switch that adjusts the compressor attack and release times.

NOTE: Please refer to the 'Diode Bridge Compressor' section on page 10 for specific attack and release time settings.

LINK

Push-button switch that engages stereo compressor link mode.

PRE EQ

Push-button switch that routes the compressor section ahead of the EQ section when engaged.

BLEND %

31-detent potentiometer that controls the wet/dry mix of the compressed signal (wet) to the input signal (dry).

FAST

Illuminated push-button switch that speeds up all time constants by 30%.

VU SELECT

Push-button switch that toggles between metering the output level (OUTPUT) and compressor gain reduction (REDUCTION).

SILK IN

Illuminated push-button switch that toggles through the three available SILK modes: OFF, RED, and BLUE. RED enhances harmonic content in high mid and high frequencies. BLUE enhances harmonic content in low and low mid frequencies.

TEXTURE

31-detent potentiometer that controls the amount of SILK harmonics added within the transformer output stage when SILK is engaged.

PEAK

PEAK LED warns when signal levels are peaking 3dB below clip point.

Shelford Channel Rear Panel Features

POWER

IEC AC power inlet with integrated power switch. 100-240VAC at 50/60Hz. 35 Watts maximum AC power consumption.

GROUND LIFT

Slide switch that lifts the internal audio ground from chassis ground on the MAIN OUT and the -6dB OUT to help isolate from ground interference.

LINE OUT

Balanced XLR output utilizing a custom Rupert Neve Designs transformer.

-6dB OUT

Balanced XLR output utilizing the center tap of a custom Rupert Neve Designs transformer.

SIDE CHAIN SEND

Compressor side-chain insert SEND 1/4" TS jack for connecting to the input of an external processor (ex: EQ).

SIDE CHAIN RETURN

Compressor side-chain insert RETURN 1/4" TS jack for connecting to the output of an external processor (ex: EQ).

LINK

1/4" TS jacks that allow for two Shelford Channel compressors to be linked together for stereo compressor operation. ONLY INTENDED FOR USE WITH OTHER SHELFORD CHANNEL LINK JACKS.

LINE IN

Balanced XLR input that can be utilized for LINE level signals.

MIC IN

Balanced XLR input that can be utilized for MIC level signals.

Specifications

Note: All measurements typical, all measurements recorded using 25ft. XLR output cables

MIC PREAMP

Input Impedance 2200 ohms

Maximum Input Level +21.5 dBu from 150Hz to 22kHz
+8dBu from 20Hz to 22kHz

Noise (Un-weighted, 22Hz-22kHz, source impedance 150 Ohm balanced)

Line Out (Unity Gain) -100.9 dBu

-6dB Line Out (Unity Gain) -106.6 dBu

Line Out (+30dB Gain) -91.37 dBu

Line Out (+66dB Gain) -64.1 dBu

Equivalent Input Noise -121.37 dBu

Frequency Response

17Hz to 45 kHz +/- 0.25 dB

DIRECT INPUT

Maximum Input Level +8 dBu from 20Hz to 120kHz

Noise (LINE OUT) -100 dBu (22Hz to 22kHz)

LINE INPUT

Maximum Input Level +30.5 dBu from 20Hz to 30kHz

Total Harmonic Distortion & Noise @ 1kHz, +20 dBu output level, no load: Better than 0.002%
@ 20Hz, +20 dBu output level, no load: 0.05% typical (2nd and 3rd harmonic)

Noise (Un-weighted, 22Hz-22kHz, source impedance 40 Ohm balanced, no load)

Line Out (Unity Gain) -101.1 dBu

Frequency Response

<10Hz to 110 kHz +/- 0.25 dB

120Hz +/- 0.32 dB

Maximum Output Level @ 16Hz to 20kHz +26 dBu

Total Harmonic Distortion + Noise with SILK Engaged

SILK RED MIN TEXTURE: @ 100Hz, +20 dBu output level, no load: 0.0131% typical, mostly 3rd harmonic
MAX TEXTURE: @ 100Hz, +20 dBu output level, no load: 1.66% typical, mostly 2nd harmonic

SILK BLUE MIN TEXTURE: @ 100Hz, +20 dBu output level, no load: 0.0079% typical, mostly 3rd harmonic
MAX TEXTURE: @ 100Hz, +20 dBu output level, no load: 0.941% typical, mostly 2nd harmonic

Specifications (continued)

High Pass Filter (*Continuously variable frequency selection from 20Hz to 250Hz*)

Slope 12 dB/Octave

EQ Noise

Un-weighted, 22Hz to 22kHz -92 dBu

Signal Present

Illuminates GREEN when input stage signal level reaches -20 dBu

Overload Indicator

Illuminates RED when input stage signal level reaches -23 dBu

Diode Bridge Compressor Section

Compressor Noise

BW, 22Hz to 22kHz
0dB Make-up gain: -84.5 dBu
+20dB Make-up gain: -64.2 dBu

Note: Time Constant (TC) measurements taken represent full range achievable between 1.5:1 and 8:1 ratio setting, 0 dBu I/P 1kHz burst tone used for all recorded measurements

Fast (TC1):
Attack: 180µS - 1.8mS
Release: 100mS - 150mS

Medium Fast (TC2):
Attack: 750µS - 5.25mS
Release: 160mS - 250mS

Medium (TC3):
Attack: 2.7mS - 18mS
Release: 350mS - 525mS

Medium Slow (TC4):
Attack: 4.6mS - 38mS
Release: 600mS - 1 S

Slow (TC5):
Attack: 11mS - 72.5mS
Release: 800mS - 1.25 S

Auto (TC6):
Attack: 5.75mS - 35.5mS
Dual Release: T1 500mS, T2 1 S

'FAST' Mode: Speeds up all compressor time constants by 30%

Product Dimensions (W x D x H) 19" (48.3 cm) x 10.5" (26.7 cm) x 1.75" (4.5 cm)

Shipping Dimensions (W x D x H) 24" (61 cm) x 13" (33 cm) x 4" (10.2 cm)

Shipping Weight 12.25 lbs. (5.5 kg)

Low Frequency Peak Response

Audio Precision

07/14/16 16:45:40

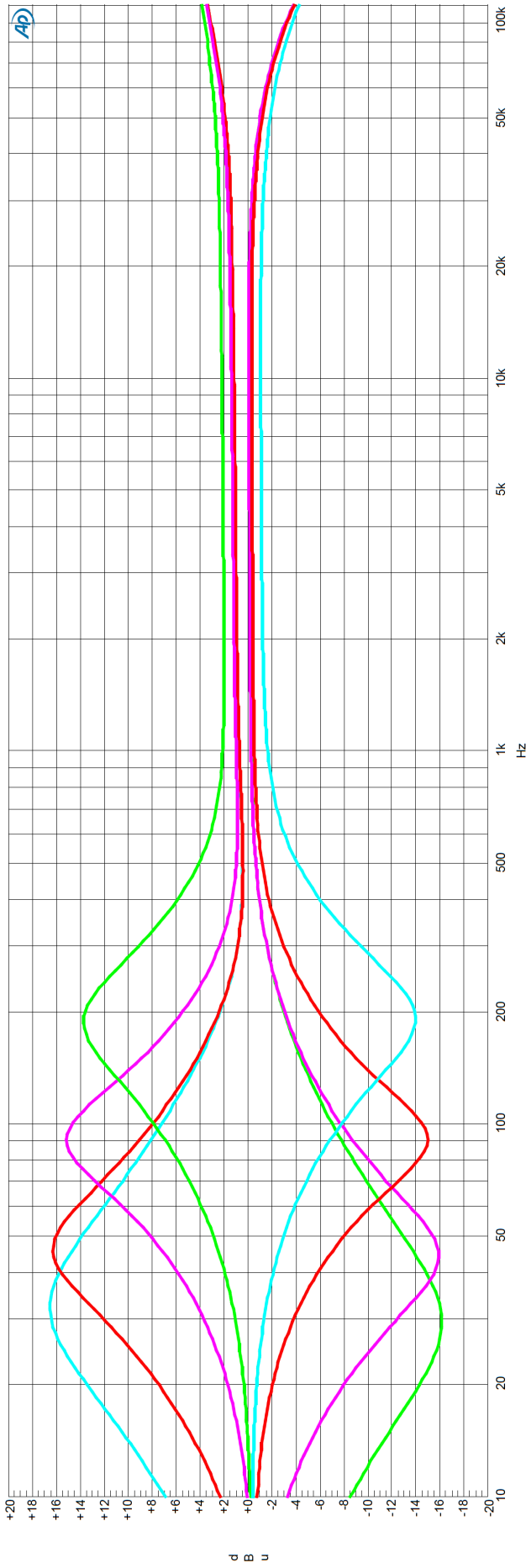

Sweep	Trace	Color	Line Style	Thick	Data	Axis	Comment
1	1	Cyan	Solid	3	Antr.Level/A	Left	35Hzboost
2	1	Green	Solid	3	Antr.Level/A	Left	35Hzcut
3	1	Red	Solid	3	Antr.Level/A	Left	60Hzboost
4	1	Magenta	Solid	3	Antr.Level/A	Left	60Hzcut
5	1	Magenta	Solid	3	Antr.Level/A	Left	100Hzboost
6	1	Red	Solid	3	Antr.Level/A	Left	100Hzcut
7	1	Green	Solid	3	Antr.Level/A	Left	220Hzboost
8	1	Cyan	Solid	3	Antr.Level/A	Left	220Hzcut

810-00042(SheifordCH)
 Low Frequency Peak Response
 Z-Out = 40 Ohms
 Line Input to Main Output

FreqResp_LoFreqPeak.ai27

Low Frequency Shelf Response

Audio Precision

07/14/16 16:34:46

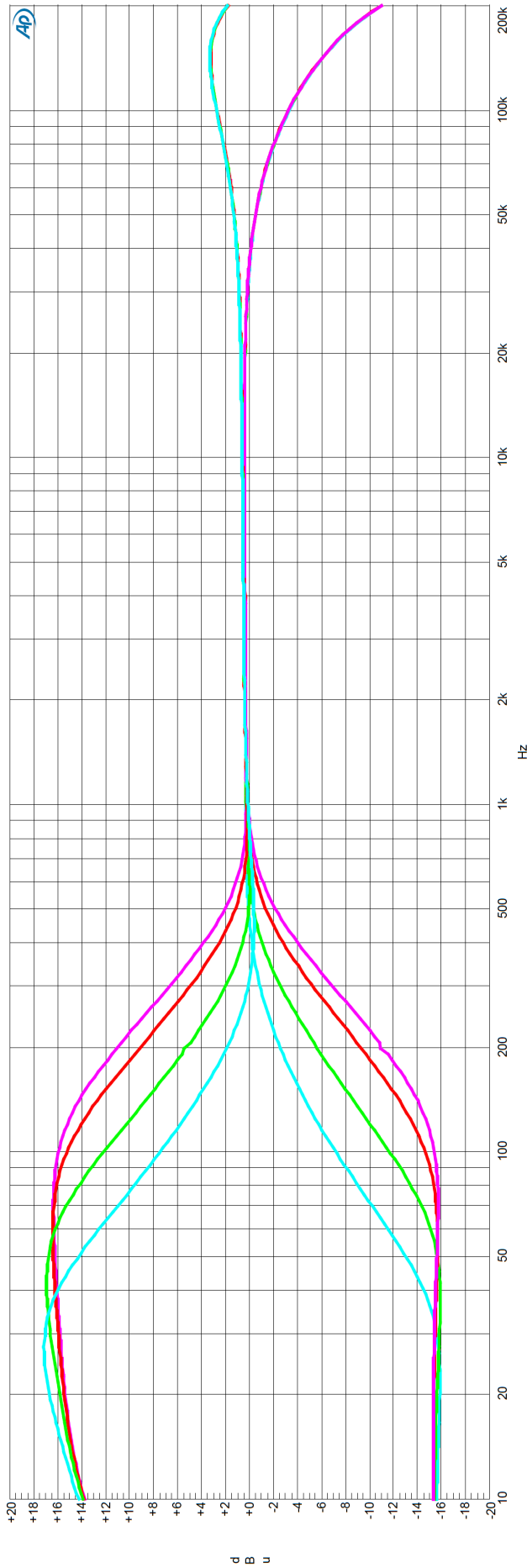

Sweep	Trace	Color	Line Style	Thick	Data	Axis	Comment
1	1	Cyan	Solid	3	Anir.Level/A	Left	35Hz Cut
2	1	Green	Solid	3	Anir.Level/A	Left	60Hz Cut
3	1	Red	Solid	3	Anir.Level/A	Left	100Hz Cut
4	1	Magenta	Solid	3	Anir.Level/A	Left	220Hz Cut
5	1	Magenta	Solid	3	Anir.Level/A	Left	220Hz Boost
6	1	Red	Solid	3	Anir.Level/A	Left	100Hz Boost
7	1	Green	Solid	3	Anir.Level/A	Left	60Hz Boost
8	1	Cyan	Solid	3	Anir.Level/A	Left	35Hz Boost
810-00042(ShelfordCH)							
Low Frequency Shelf Response							
Z-Out = 40 Ohms							
Line Input to Main Output							

FreqResp_LoFreqShelf.a27

Mid-Band Low Q Frequency Response (boost)

Audio Precision

07/01/16 13:31:05

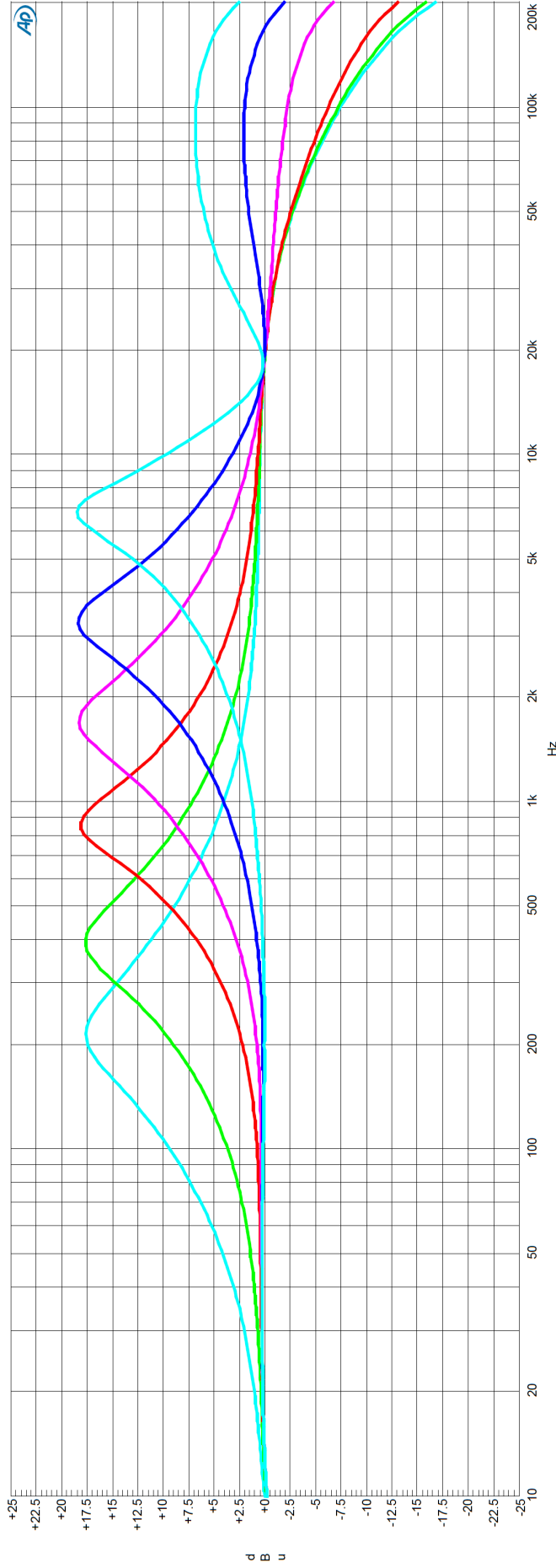

Sweep	Trace	Color	Line Style	Thick	Data	Axis	Comment
1	1	Cyan	Solid	3	A1r1.Level A	Left	220Hz
2	1	Green	Solid	3	A2r1.Level A	Left	400Hz
3	1	Red	Solid	3	A3r1.Level A	Left	900Hz
4	1	Magenta	Solid	3	A4r1.Level A	Left	1.8kHz
5	1	Blue	Solid	3	A5r1.Level A	Left	3.5kHz
6	1	Cyan	Solid	3	A6r1.Level A	Left	7.5k

810-00042(ShelfordCH)							
Mid-band Lo-Q Frequency Response							
Z-Out = 40 Ohms							
Line Input to Main Output							

FreqResp_LoQMidBandEQBoostat27

Mid-Band Low Q Frequency Response (cut)

07/01/16 13:29:57

Audio Precision

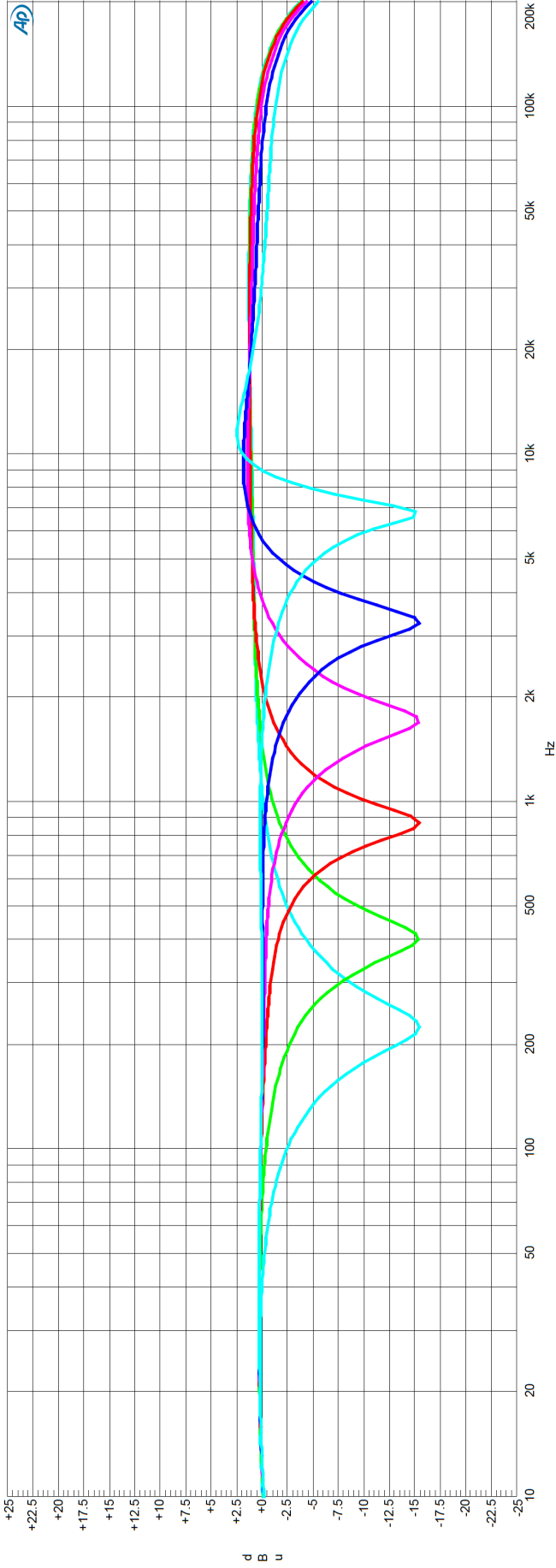

Sweep	Trace	Color	Line Style	Thick	Data	Axis	Comment
1	1	Cyan	Solid	3	Antr.Level/A	Left	220Hz
2	1	Green	Solid	3	Antr.Level/A	Left	400Hz
3	1	Red	Solid	3	Antr.Level/A	Left	900Hz
4	1	Magenta	Solid	3	Antr.Level/A	Left	1.8kHz
5	1	Blue	Solid	3	Antr.Level/A	Left	3.5kHz
6	1	Cyan	Solid	3	Antr.Level/A	Left	7.5kHz

810-00042(SheffordCH)
 Mid-band Lo-Q Frequency Response
 Z-Out = 40 Ohms
 Line Input to Main Output

FreqResp_LOQMidBandECCut.a27

Mid-Band High Q Frequency Response (boost)

Audio Precision

07/01/16 13:40:06

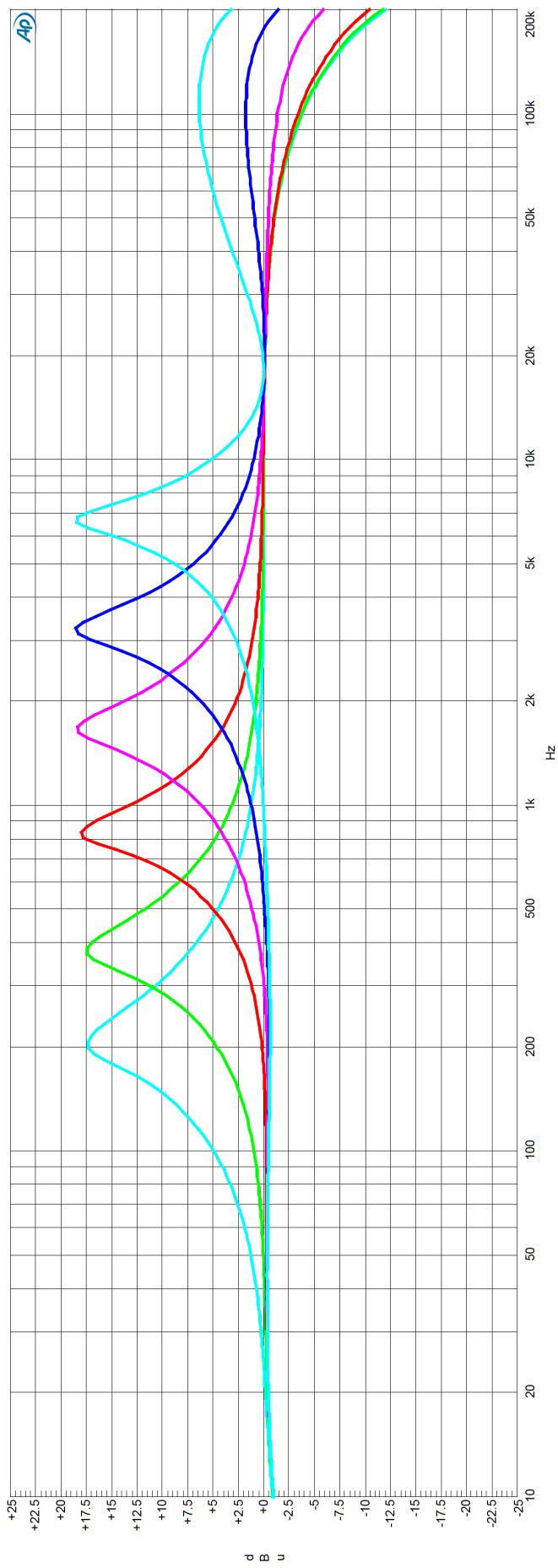

Sweep	Trace	Color	Line Style	Thick	Data	Axis	Comment
1	1	Cyan	Solid	3	Anlr.Level A	Left	220Hz
2	1	Green	Solid	3	Anlr.Level A	Left	400Hz
3	1	Red	Solid	3	Anlr.Level A	Left	900Hz
4	1	Magenta	Solid	3	Anlr.Level A	Left	1.8kHz
5	1	Blue	Solid	3	Anlr.Level A	Left	3.5kHz
6	1	Cyan	Solid	3	Anlr.Level A	Left	7.5kHz
810-00042(ShelfordCH)							
Mid-band Hi-Q Frequency Response							
Z-Out = 40 Ohms							
Line Input to Main Output							

FreqResp_HiQMidBandEQBoost.lat27

Mid-Band High Q Frequency Response (cut)

Audio Precision

07/01/16 13:46:06

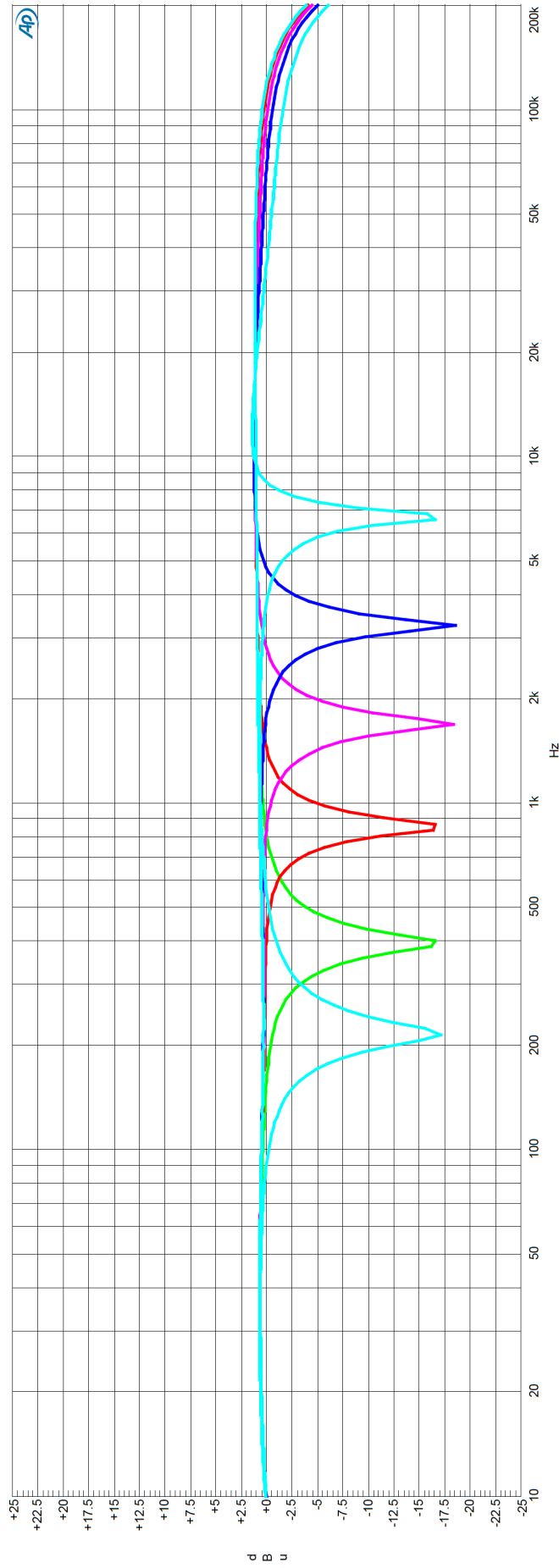

Sweep	Trace	Color	Line Style	Thick	Data	Axis	Comment
1	1	Cyan	Solid	3	Anir.Level A	Left	220Hz
2	1	Green	Solid	3	Anir.Level A	Left	400Hz
3	1	Red	Solid	3	Anir.Level A	Left	900Hz
4	1	Magenta	Solid	3	Anir.Level A	Left	1.8kHz
5	1	Blue	Solid	3	Anir.Level A	Left	3.6kHz
6	1	Cyan	Solid	3	Anir.Level A	Left	7.5kHz

810-00042(ShellfordCH)							
Mid-band Hi-Q Frequency Response							
Z-Out = 40 Ohms							
Line Input to Main Output							

FreqResp_HiQMdBandEQcut.a27

High Frequency Peak

Audio Precision

07/14/16 17:05:45

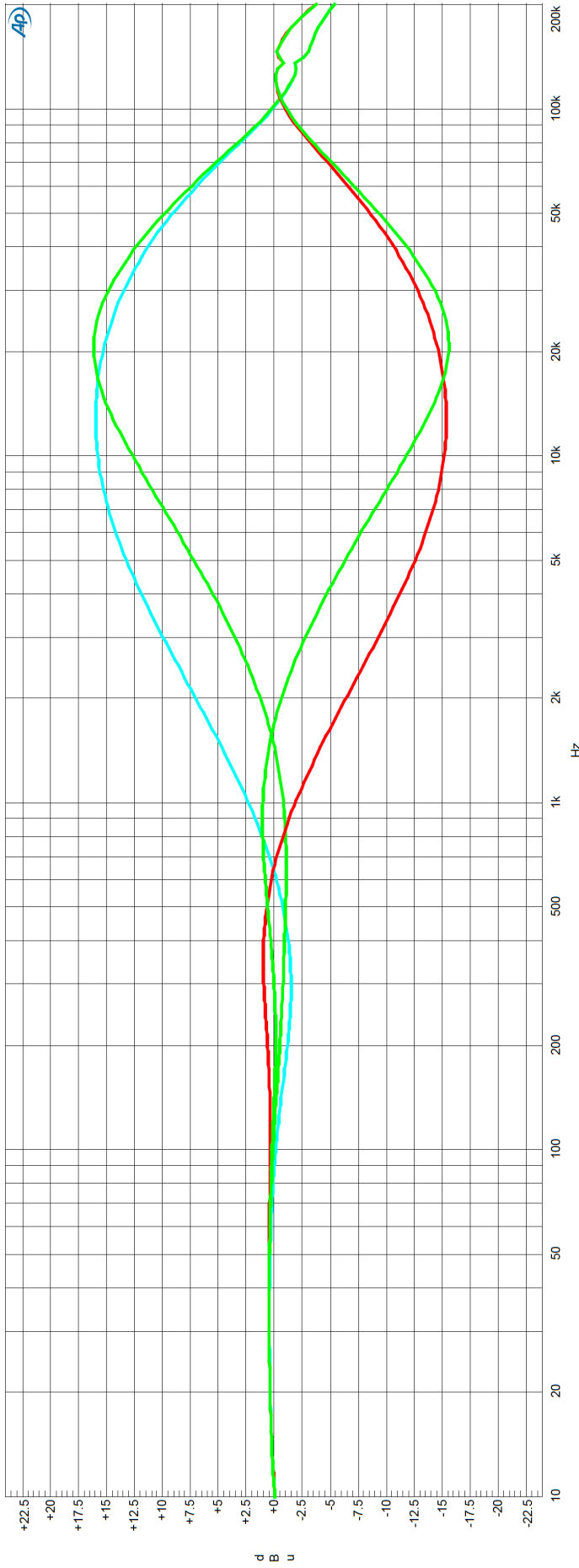

Sweep	Trace	Color	Line Style	Thick	Data	Axis	Comment
1	1	Cyan	Solid	3	Anlr.Level/A	Left	8kHz boost
2	1	Green	Solid	3	Anlr.Level/A	Left	16kHz boost
3	1	Red	Solid	3	Anlr.Level/A	Left	8kHz cut
4	1	Green	Solid	3	Anlr.Level/A	Left	

810-00042(ShelfordCH)							
High Frequency Peak							
Z-Out = 40 Ohms							
Line Input to Main Output							

FreqResp_HIFreqPeak.at27

High Frequency Shelf

Audio Precision

07/14/16 17:01:58

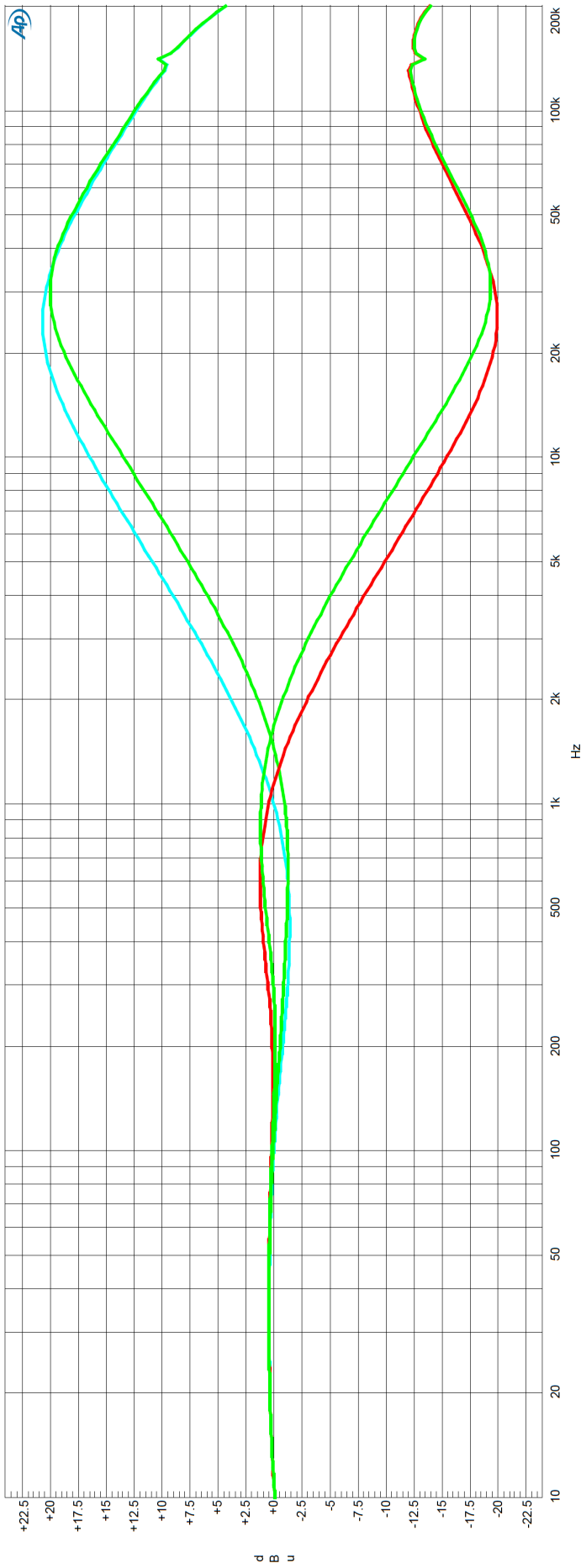

Sweep	Trace	Color	Line Style	Thick	Data	Axis	Comment
1	1	Cyan	Solid	3	Anlr.Level A	Left	8kHz boost
2	1	Green	Solid	3	Anlr.Level A	Left	16kHz boost
3	1	Red	Solid	3	Anlr.Level A	Left	8kHz cut
4	1	Green	Solid	3	Anlr.Level A	Left	16kHz cut

810-00042(ShellfordCH)							
High Frequency Shelf							
Z-Out = 40 Ohms							
Line Input to Main Output							

FreqResp_HIFreqShelf.a27

High Pass Filter Frequency Response

Audio Precision

07/01/16 09:22:01

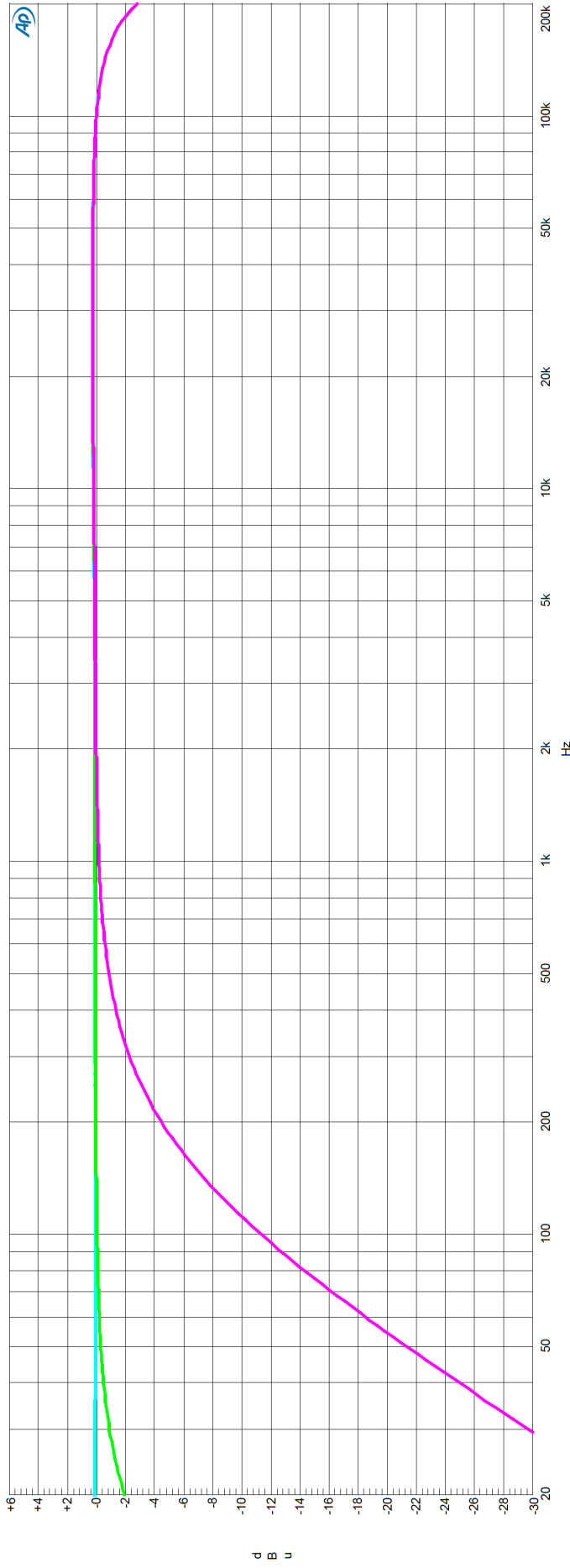

Sweep	Trace	Color	Line Style	Thick	Data	Axis	Comment
1	1	Cyan	Solid	3	Anlr.Level/A	Left	Baseline
2	1	Green	Solid	3	Anlr.Level/A	Left	HPF @ 20Hz
3	1	Magenta	Solid	3	Anlr.Level/A	Left	HPF @ 250Hz

810-00042(ShelfordCh)
 HPF Frequency Response
 Line Input to Main Output
 Z-Out = 40 Ohms

FreqResp_HPF.at27

SILK Texture Frequency Response

Audio Precision

07/14/16 16:50:54

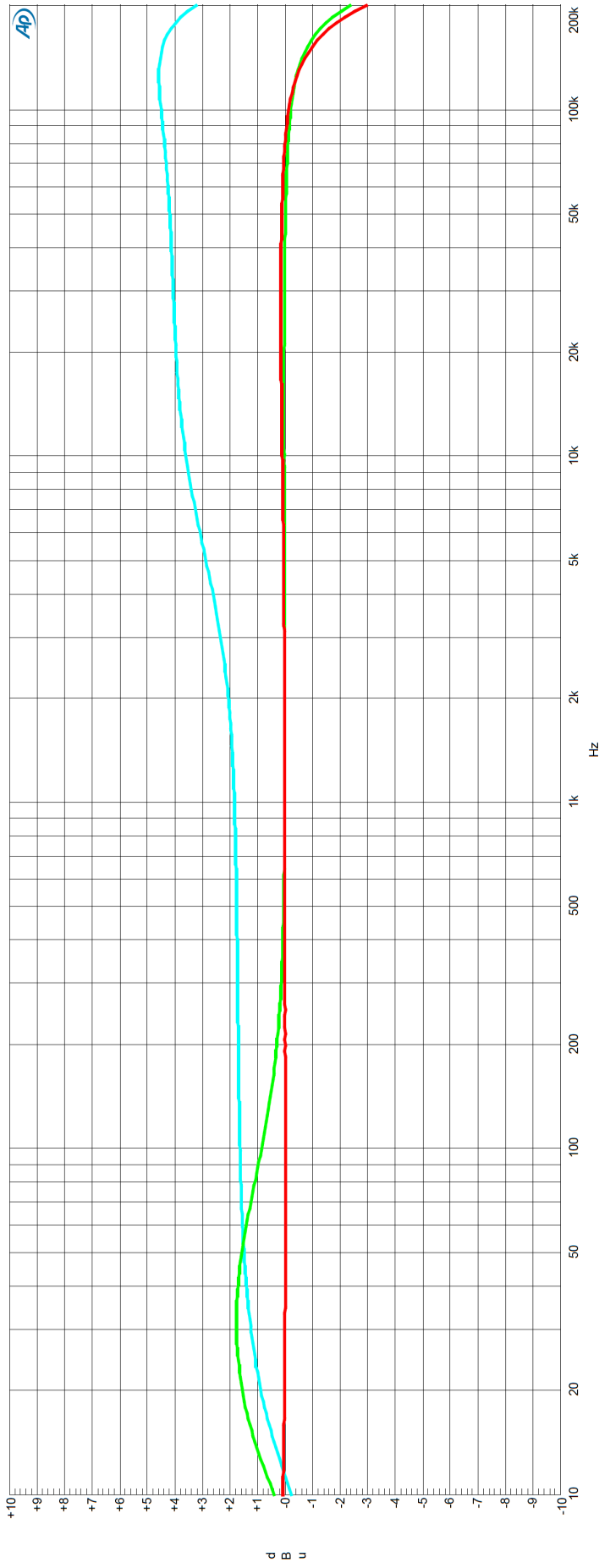

Sweep	Trace	Color	Line Style	Thick	Data	Axis	Comment
1	1	Cyan	Solid	3	Anlr,Level/A	Left	RED @ max
2	1	Green	Solid	3	Anlr,Level/A	Left	BLUE @ max
3	1	Red	Solid	3	Anlr,Level/A	Left	

810-00042(ShelfordCH)
 Texture Frequency Response
 Z-Out = 40 Ohms
 Line Input to Main Output

FreqResp_Silk.a27

PRODUCT WARRANTY

Rupert Neve Designs warrants this product to be free from defects in materials and workmanship for a period of three (3) years from date of purchase, and agrees to remedy any defect identified within such three year period by, at our option, repairing or replacing the product.

LIMITATIONS AND EXCLUSIONS

This warranty, and any other express or implied warranty, does not apply to any product which has been improperly installed, subjected to usage for which the product was not designed, misused or abused, damaged during shipping, damaged by any dry cell battery, or which has been altered or modified in any way. This warranty is extended to the original end user purchaser only. A purchase receipt or other satisfactory proof of date of original purchase is required before any warranty service will be performed. THIS EXPRESS, LIMITED WARRANTY IS IN LIEU OF ALL OTHER WARRANTIES, EXPRESS OR IMPLIED, TO THE EXTENT ALLOWED UNDER APPLICABLE STATE LAW. IN NO EVENT SHALL RUPERT NEVE DESIGNS BE LIABLE FOR ANY SPECIAL, INCIDENTAL, OR CONSEQUENTIAL DAMAGES RESULTING FROM THE USE OF THIS PRODUCT. Some states do not allow the exclusion or limitation of consequential damages or limitations on how long an implied warranty lasts, so this exclusion may not apply to you.

WARRANTY SERVICE

If you suspect a defect in this product, please contact our support staff for troubleshooting by phone (512-847-3013) or email (service@rupertneve.com). If it is determined that the device is malfunctioning, we will issue a Return Material Authorization and provide instructions for shipping the device to our service department.



Rupert Neve Designs

PO Box 1969

Wimberley TX 78676

www.rupertneve.com

tel: +1 512-847-3013

fax: +1 512-847-8869

775-00027 Rev C3